

DISTRIBUTION BASICS II

CONTINUING EDUCATION PROFESSIONAL DEVELOPMENT COURSE

Second Edition



Printing and Saving Instructions

TLC recommends that you download and save this pdf document and assignment to your computer desktop and open it with Adobe Acrobat DC reader.

Adobe Acrobat DC reader is a free computer software program and you can find it at Adobe Acrobat's website.

You can complete the course by viewing the course on your computer or you can print it out. This course booklet does not have the assignment (the test). Please visit our website and download the assignment (the test).

Printing Instructions: Once you have purchased the program, we will give you permission to print this document. If you are going to print this document, it was designed to be printed double-sided or duplexed but can be printed single-sided.

Hyperlink to Assignment...

<http://www.abctlc.com/downloads/PDF/WD2ASS.pdf>

State Approval Listing Link, check to see if your State accepts or has pre-approved this course. Not all States are listed. Not all courses are listed. Do not solely trust our list for it may be outdated. It is your sole responsibility to ensure this course is accepted for credit. No refunds.

Professional Engineers; Most states will accept our courses for credit but we do not officially list the States or Agencies acceptance or approvals.

State Approval Listing URL...

<http://www.abctlc.com/downloads/PDF/CEU%20State%20Approvals.pdf>

Hyperlink to the Glossary and Appendix

<http://www.abctlc.com/downloads/PDF/WTGlossary.pdf>

You can obtain a printed version from TLC for an additional \$189.95 plus shipping charges.

All downloads are electronically tracked and monitored for security purposes.



Top photo, a steel water storage tank. This type of type generally uses a pump to provide pressure to customers. Bottom photo, this is an elevated storage tank and is often found in flat areas. The height creates gravity water pressure and only one pump is necessary to pump the water into storage. This is tank is in Galveston, Texas.



Library of Congress Card Number TX-6-825-267

DISTRIBUTION BASICS II



Some States and many employers require the final exam to be proctored.

Do not solely depend on TLC's Approval list for it may be outdated.

Most of our students prefer to do the assignment in Word and e-mail or fax the assignment back to us. We also teach this course in a conventional hands-on class. Call us and schedule a class today.

Precept-Based Training Course

This training course is based upon a form of induction training, made of topical and technical precepts. The training topics are made up of "micro-content" or "precepts"— or small chunks of information that can be easily digested. These bite-size pieces of technical information are considered to be one of the most effective ways of teaching people new information because it helps the mind retain knowledge easier.

Micro-learning or precept-based training doesn't rely on the student processing a large amount of information before breaking it down. Our method includes short modules with clearly defined learning goals for each section. This method allows a student to hone in on a particular skill, then given the opportunity to exhibit their knowledge in the final assessment.

Copyright Notice

1999-2022 Technical Learning College (TLC) No part of this work may be reproduced or distributed in any form or by any means without TLC's prior written approval. Permission has been sought for all images and text where we believe copyright exists and where the copyright holder is traceable and contactable. Other materials including text and artwork are in the public domain or fair use (the state of belonging or being available to the public as a whole, and therefore not subject to copyright.) All material that is not credited or acknowledged or referenced in the rear of this course is the copyright of Technical Learning College. Most unaccredited photographs have been taken by TLC instructors or TLC students. All written, graphic, photographic or other material is provided for educational information only. We will be pleased to hear from any copyright holder and will make good on your work if any unintentional copyright infringements were made as soon as these issues are brought to the editor's attention.

This educational training course and assignment is intended for educational purposes only. Every possible effort was made to ensure that all information provided in this course is accurate. Therefore, Technical Learning College accepts no responsibility or liability whatsoever for the application or misuse of any information included herein.

Requests for acknowledgements or permission to make copies shall be made to the following address: TLC, P.O. Box 3060, Chino Valley, AZ 86323

Information in this document is subject to change without notice. TLC is not liable for errors or omissions appearing in this document.

Contributing Editors

James L. Six Received a Bachelor of Science Degree in Civil Engineering from the University of Akron in June of 1976, Registered Professional Engineer in the State of Ohio, Number 45031 (Retired), Class IV Water Supply Operator issued by Ohio EPA, Number WS4-1012914-08, Class II Wastewater Collection System Operator issued by Ohio EPA, Number WC2-1012914-94

Joseph Camerata

has a BS in Management with honors (magna cum laude). He retired as a Chemist in 2006 having worked in the field of chemical, environmental, and industrial hygiene sampling and analysis for 40 years. He has been a professional presenter at an EPA analytical conference at the Biosphere in Arizona and a presenter at an AWWA conference in Mesa, Arizona. He also taught safety classes at the Honeywell and City of Phoenix, and is a motivational/inspirational speaker nationally and internationally.

James Bevan, Water Quality Inspector S.M.E. Twenty years of experience in the environmental field dealing with all aspects of water regulations on the federal, state, and local levels. Teacher and Proctor in Charge for Backflow Certification Testing at the ASETT Center in Tucson for the past 15 years and possess an Arizona Community College, Special Teaching Certificate in Environmental Studies.

Dr. Pete Greer S.M.E., Retired biology instructor, chemistry and biological review.

Jack White, Environmental, Health, Safety expert, City of Phoenix. Art Credits.

Important Information about this Manual

Disclaimer

This CEU training manual has been prepared to assist employees in the general awareness of the water distribution system and groundwater production system, complex pumping ideas, dangerous excavation techniques, water regulatory sampling and dealing with often-complex procedures and requirements for safely handling hazardous and toxic materials.

The scope of the material is quite large, requiring a major effort to bring it under control. Employee health and safety, as well as that of the public, depend upon careful application of federal and state regulations and safe working procedures.

This manual will cover general laws, regulations, required procedures and work rules relating to water distribution and sampling. It should be noted, however, that the federal and state regulations are an ongoing process and subject to change over time. For this reason, a list of resources and hyperlinks is provided to assist in obtaining the most up-to-date information on various subjects. You can find these on our website or in this manual. This manual is a guidance document for employees who are involved with water distribution, water quality and pollution control.

It is not designed to meet the full requirements of the United States Environmental Protection Agency (EPA) or the Department of Labor-Occupational Safety and Health Administration (OSHA) rules and regulations. Working in the distribution field is a very dangerous profession and you are solely responsible for safety and regulatory compliance at all times.

This course manual will provide general guidance and should not be used as a preliminary basis for developing general water sampling plans, regulatory or compliance, groundwater or water distribution safety plans or procedures.

This document is not a detailed water/wastewater textbook or a comprehensive source book on water/wastewater/safety rules and regulations. Technical Learning College makes no warranty, guarantee or representation as to the absolute correctness or appropriateness of the information in this manual and assumes no responsibility in connection with the implementation of this information.

It cannot be assumed that this manual contains all measures and concepts required for specific conditions or circumstances.

This document should be used for guidance and is not considered a legal document. Individuals who are responsible for water distribution, groundwater production and/or sampling and the health and safety of workers at hazardous waste sites should obtain and comply with the most recent federal, state, and local regulations relevant to these sites and are urged to consult with OSHA, the EPA and other appropriate federal, state, and local agencies.



Hand digging, getting soaked with water and mud, being run over from traffic are just a few tasks and major portions of repairing the distribution system. We hope to be able to teach you about the system. You will understand the distribution system and water quality as well.

Before any excavation, always determine the location of the other buried utilities, before tapping a main for a new service connection, the operator should call Bluestake or One-Call centers.

Technical Learning College's Scope and Function

Welcome to the Program,

Technical Learning College (TLC) offers affordable continuing education for today's working professionals who need to maintain licenses or certifications. TLC holds several different governmental agency approvals for granting of continuing education credit.

TLC's delivery method of continuing education can include traditional types of classroom lectures and distance-based courses or independent study. TLC's distance based or independent study courses are offered in a print - based distance educational format. We will beat any other training competitor's price for the same CEU material or classroom training.

Our courses are designed to be flexible and for you to finish the material at your convenience. Students can also receive course materials through the mail. The CEU course or e-manual will contain all your lessons, activities and instruction to obtain the assignments. All of TLC's CEU courses allow students to submit assignments using e-mail or fax, or by postal mail. (See the course description for more information.)

Students have direct contact with their instructor—primarily by e-mail or telephone. TLC's CEU courses may use such technologies as the World Wide Web, e-mail, CD-ROMs, videotapes and hard copies. (See the course description.) Make sure you have access to the necessary equipment before enrolling; i.e., printer, Microsoft Word and/or Adobe Acrobat Reader. Some courses may require proctored closed-book exams, depending upon your state or employer requirements.

Flexible Learning

At TLC, there are no scheduled online sessions or passwords you need contend with, nor are you required to participate in learning teams or groups designed for the "typical" younger campus based student. You will work at your own pace, completing assignments in time frames that work best for you. TLC's method of flexible individualized instruction is designed to provide each student the guidance and support needed for successful course completion.

Course Structure

TLC's online courses combine the best of online delivery and traditional university textbooks. You can easily find the course syllabus, course content, assignments, and the post-exam (Assignment). This student-friendly course design allows you the most flexibility in choosing when and where you will study.

Classroom of One

TLC offers you the best of both worlds. You learn on your own terms, on your own time, but you are never on your own. Once enrolled, you will be assigned a personal Student Service Representative who works with you on an individualized basis throughout your program of study. Course specific faculty members (S.M.E.) are assigned at the beginning of each course providing the academic support you need to successfully complete each course. Please call or email us for assistance.

Satisfaction Guaranteed

We have many years of experience, dealing with thousands of students. We assure you, our customer satisfaction is second to none. This is one reason we have taught more than 20,000 students.

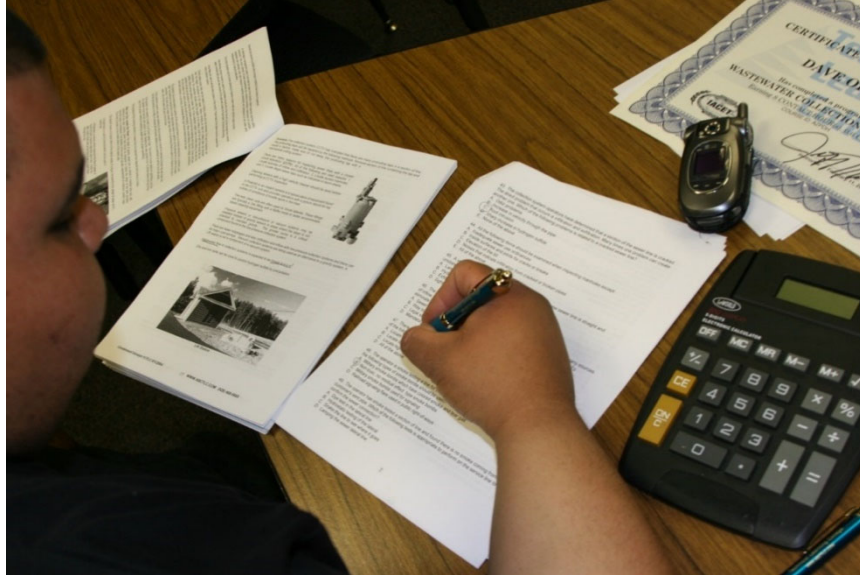

We welcome you to do the electronic version of the assignment and submit the answer key and registration to us either by fax or e-mail.

If you need this assignment graded and a certificate of completion within a 48-hour turn around, prepare to pay an additional rush charge of \$50.

We welcome you to complete the assignment in Word.

Once we grade it, we will mail a certificate of completion to you. Call us if you need any help.

Contact Numbers
Telephone (866) 557-1746
Fax (928) 468-0675
Email Info@tlch2o.com

Responsibility

This course contains EPA's federal rule requirements. Please be aware that each state implements drinking water, groundwater production, and safety regulations that may be more stringent than EPA's or OSHA's regulations. Check with your state environmental agency for more information. You are solely responsible in ensuring that you abide with your jurisdiction or agency's rules and regulations.

CEU Course Description

DISTRIBUTION BASICS CEU TRAINING COURSE *Second Edition*

Review of water distribution systems and related treatment fundamentals. This course will cover the basic requirements of the Safe Drinking Water Act and general water distribution principles. You will not need any other materials for this course.

Water Distribution, Well Drillers, Pump Installers, Water Treatment Operators.

The target audience for this course is the person interested in working in a water treatment or distribution facility and/or wishing to maintain CEUs for certification license or to learn how to do the job safely and effectively, and/or to meet education needs for promotion.

Final Examination for Credit

Opportunity to pass the final comprehensive examination is limited to three attempts per course enrollment.

Course Procedures for Registration and Support

All of Technical Learning College's correspondence courses have complete registration and support services offered. Delivery of services will include, e-mail, web site, telephone, fax and mail support. TLC will attempt immediate and prompt service.

When a student registers for a distance or correspondence course, he/she is assigned a start date and an end date. It is the student's responsibility to note dates for assignments and keep up with the course work.

If a student falls behind, he/she must contact TLC and request an end date extension in order to complete the course.

It is the prerogative of TLC to decide whether to grant the request. All students will be tracked by a unique number assigned to the student.

Instructions for Written Assignments

The Distribution Basics Second Edition CEU Training course uses a multiple choice answer key. If you should need any assistance, please email all concerns and the final test to: info@tlch2o.com.

You may write your answers or type out your own answer key. TLC would prefer that you utilize the answer key found on the TLC website under Assignments and e-mail the answer key to TLC, but it is not required. You may also fax the answer key. Please call us a couple hours later to ensure we received your information.

Feedback Mechanism (examination procedures)

Each student will receive a feedback form as part of their study packet. You will be able to find this form in the front of the course assignment or lesson.

Security and Integrity

All students are required to do their own work. All lesson sheets and final exams are not returned to the student to discourage sharing of answers. Any fraud or deceit and the student will forfeit all fees and the appropriate agency will be notified.

Grading Criteria

TLC will offer the student either pass/fail or a standard letter grading assignment. If TLC is not notified, you will only receive a pass/fail notice.

Required Texts

The Distribution Basics Second Edition CEU Training course will not require any other materials. This course comes complete. No other materials are needed.

Recordkeeping and Reporting Practices

TLC will keep all student records for a minimum of seven years. It is the student's responsibility to give the completion certificate to the appropriate agencies.

ADA Compliance

TLC will make reasonable accommodations for persons with documented disabilities. Students should notify TLC and their instructors of any special needs. Course content may vary from this outline to meet the needs of this particular group.

You will have 90 days from receipt of this manual to complete it in order to receive your Continuing Education Units (CEUs) or Professional Development Hours (PDHs). A score of 70% or better is necessary to pass this course.



Educational Mission

The educational mission of TLC is:

To provide TLC students with comprehensive and ongoing training in the theory and skills needed for the environmental education field,

To provide TLC students with opportunities to apply and understand the theory and skills needed for operator certification,

To provide opportunities for TLC students to learn and practice environmental educational skills with members of the community for the purpose of sharing diverse perspectives and experience,

To provide a forum in which students can exchange experiences and ideas related to environmental education,

To provide a forum for the collection and dissemination of current information related to environmental education, and to maintain an environment that nurtures academic and personal growth.

TABLE OF CONTENTS (Learning Objective Legend on Page 20)

Preface.....	21
Topic 1- Groundwater Production Section.....	23
Groundwater Introduction -O&M.....	25
Aquifer Introduction -O&M and TECH.....	27
Cone of Depression O&M and TECH	29
Groundwater Explained O&M and TECH	31
Appendix 1 –WQ.....	38
Well Reports - O&M and TECH	39
Permeability of Aquifer - O&M and TECH	43
Well Tests- O&M and TECH	47
Well Drilling- O&M and TECH	51
Direct Rotary- O&M and TECH	53
Reverse Mud Rotary- O&M and TECH	57
Drill Through Casing Driver- O&M and TECH	59
Common Well Construction- O&M and TECH	63
Choice of Casing- O&M and TECH	65
Concrete Collar- O&M and TECH	69
Well Development Section- O&M and TECH	71
Well Backwashing- O&M and TECH	72
Selecting a Pumping Rate- O&M and TECH	74
Post Quiz.....	75
Topic 2- Pump, Motors and Hydraulic Section.....	77
Hydraulic Terms –O&M -TECH	79
Hydraulic Principles –O&M -TECH	81
Atmospheric Pressure –O&M -TECH	83
Pressure –O&M -TECH	85
General Pumping Fundamentals –O&M -TECH	87
Pump Definitions –O&M -TECH	89
Positive Displacement Pump –O&M -TECH	91
Understanding the Pump–O&M -TECH.....	97
Types of Pumps –O&M -TECH	99
Submersible Pump –O&M -TECH	103
Centrifugal Pump Section –O&M -TECH.....	105
Vertical Turbine Section –O&M -TECH.....	107
Pump Performance –O&M -TECH	113
Motor and Pump Calculation Section –O&M -TECH	115
NPSH–O&M -TECH	119
Pump Casing –O&M -TECH	123
Mechanical Seals –O&M -TECH	127
Coupling Section –O&M -TECH	129
Motor Section –O&M -TECH	131
Motor Controls –O&M -TECH	132

Maintenance–O&M -TECH	139
Troubleshooting Pumps–O&M -TECH	145
SCADA–O&M -TECH	149
Post Quiz.....	153
Topic 3- Water Distribution Section.....	155
Distribution Design –O&M -TECH	161
System Layouts–O&M -TECH	163
Friction Loss–O&M -TECH	164
Distribution Valve Section–O&M -TECH	167
Common Rotary Valves –O&M -TECH	173
Butterfly –O&M -TECH	173
Water Meter Section–O&M -TECH	177
Service Connections –O&M -TECH	183
Types of Pipes –O&M -TECH	185
Joints and Fittings –O&M -TECH	189
Water Main Installation –O&M -TECH	192
Troubleshooting Distribution–O&M -TECH	195
Water Use–O&M -TECH	196
Water Storage –O&M -TECH	197
Hydropneumatic Tanks–O&M -TECH	205
Post Quiz.....	209
Topic 4- Backflow Section	211
Backflow Introduction – CRAO.....	213
Cross-Connection Terms–O&M -TECH	219
Backsiphonage – CRAO.....	221
Backpressure – CRAO	222
Backflow Responsibility – CRAO	223
Methods and Assemblies–O&M -TECH	225
Pressure Vacuum Breaker – CRAO.....	227
Post Quiz.....	231
Topic 5- Water Quality Section.....	233
Raw Water Introduction - WQ	237
Surface Water Properties– WQ & CRAO.....	239
Physical Characteristics– WQ & CRAO.....	241
Turbidity – CRAO.....	243
pH Sub-Section– WQ & CRAO.....	247
Hardness– WQ & CRAO.....	259
TDS– WQ & CRAO.....	261
Langelier Saturation Index– WQ & CRAO.....	263
Biological Characteristics– WQ & CRAO.....	267
Tastes and Odors– WQ & CRAO.....	269
Safe Drinking Water Act – CRAO.....	271
Source Water Protection – WQ & CRAO	274

MCL Introduction – CRAO	277
Inorganic Contaminants – CRAO	278
Common Distribution Problems – CRAO	279
Sampling Plan Introduction – CRAO	281
Disinfection Rules Stages 1 and 2– CRAO	285
Primary Drinking Water Regulations – CRAO	295
Secondary Drinking Water Regulations – CRAO	301
Chemical Monitoring – CRAO	303
QA/QC Measures – WQ & CRAO	307
Drinking Water Analysis Chart – WQ & CRAO.....	309
Inorganic Chemicals – CRAO.....	315
Volatile Organic Chemicals – CRAO.....	323
Summary.....	329
Post Quiz.....	331
Topic 6- Bacteriological Monitoring Section.....	333
Microbiological Contaminants– CRAO & WQ.....	337
Coliform Bacteria – M/O.....	339
TCR Provisions – CRAO & WQ	340
Related Microbes – CRAO & M/O	341
Bacteriological Monitoring – CRAO & M/O	345
Types of Samples – CRAO	347
Coliform Present – CRAO	349
Heterotrophic Plate Count – CRAO	351
Total Coliforms– CRAO	355
RTCR – CRAO & M/O.....	357
Pathogens – CRAO & M/O	363
Viral Diseases – CRAO.....	371
Cryptosporidiosis – CRAO& M/O.....	374
Sampling Procedures - CRAO& M/O.....	377
Chain of Custody– CRAO	378
Summary– CRAO & WQ	381
Post Quiz.....	383
Topic 7- Advanced Water Treatment Section.....	385
Hard Water -CRAO and WQ.....	387
Hard Water Expression –TECH & WQ	389
Types of Water Hardness –TECH & WQ	390
Ion Exchange –TECH & WQ	393
Membrane Filtration Section - WQ and O&M	395
Membrane Configurations - WQ and O&M	398
Electrodialysis –TECH & WQ.....	399
Desalination–TECH & WQ	401
Osmotic Processes–TECH & WQ	403
Reverse Osmosis Section- WQ and O&M	405
Nanofiltration vs Reverse Osmosis - WQ and O&M	415

Summary.....	417
Post Quiz.....	419
Topic 8- Disinfection Section.....	421
Gas Introduction - O&M -DISN.....	425
Chemistry of Chlorination- O&M -DISN	431
Chlorine Residuals – WQ & DISN.....	433
Breakpoint Chlorination - O&M -DISN	441
Amperometric Titration –WQ-DISN	443
Using DPD - O&M -DISN	444
Chlorination Equipment - O&M –DISN- SAFETY	447
Chlorine Leak Detection - O&M –DISN- SAFETY	451
Storage of Containers- O&M –DISN- SAFETY.....	453
Risks and Benefits of Chlorine - O&M –DISN-CRAO- SAFETY.....	459
Chlorine Byproducts – CRAO & O&M & DISN-.....	460
Sodium Hypochlorite – SAFETY –DISN.....	463
Calcium Hypochlorite – SAFETY –DISN.....	471
Chlorine Review- O&M –DISN- SAFETY	475
Chlorine Health - O&M & SAFETY.....	477
Respiratory Protection - O&M & SAFETY.....	479
Alternative Disinfectants –TECH & DISN.....	485
Chlorine Dioxide - O&M –DISN- SAFETY	489
Ozone –TECH & DISN & O&M	493
Ultraviolet Radiation –TECH & DISN & O&M	495
Summary.....	501
Post Quiz.....	503
Topic 9- Safety Program Section.....	505
Confined Space Program Requirements - SAFETY.....	507
Confined Space Program Purpose - SAFETY.....	511
Confined Space Hazards - SAFETY.....	513
Tanks and Sumps- SAFETY.....	515
Unusual Conditions- SAFETY.....	517
Permit Required Confined Space- SAFETY.....	519
Corrosive Atmospheres- SAFETY.....	523
Trench Safety Section- SAFETY.....	525
Excavation Facts- SAFETY.....	527
Competent Person- SAFETY.....	529
Excavation Protection Systems- SAFETY.....	533
Trench Safety Guidelines- SAFETY.....	535
Hazards- SAFETY.....	537
Excavation Safety Plans- SAFETY.....	539
Soil Classifications- SAFETY.....	543
Sloping- SAFETY.....	545
Inspections- SAFETY.....	547
Checklist- SAFETY.....	549

One Call Center- SAFETY.....	551
Natural Gas Dangers- SAFETY.....	553
Safety Glossary.....	555
References.....	559
Post Quiz.....	561
Post Quiz Answers.....	563
Math Conversions	565
References.....	569

Topic Legend

This CEU course covers several different educational topics/functions/purposes/objectives of conventional water distribution, cross-connection control, safety, pumps, groundwater production, disinfection, bacteriological monitoring and regulatory compliance. The topics listed below are to assist in determining which educational objective or goal is covered for a specific topic area:

CRAO - Compliance and Regulatory Affairs: The regulatory and compliance component of your need to know. May be a requirement of the SDWA act or State Regulations, i.e. Compliance, non-compliance, process control related sampling or other drinking water related requirement. This EPA information is to satisfy the regulatory portion of your operator training. Part of O&M or laboratory training requirement for many operators.

DISN - Disinfection: This area covers plant disinfection procedures. Part of O&M training for many operators. May include alternative disinfection procedures, i.e. Ozone and Ultraviolet

GP - GROUNDWATER MINING OR PRODUCTION: This may be considered O&M training for many operators or credit for pump engineers or well drillers.

M/O - Microorganisms: The biological component. The microorganisms that are specifically found in drinking water. This section may be part of required sampling, i.e. Total Coliform Rule or other biological related sampling. Part of O&M or laboratory training requirement for many operators.

MOTOR: Having to do with the electrical-mechanical portion of moving water. This may be considered O&M training for many operators. Maybe good for credit for those who hold an electrician or instrumentation certification.

O&M - Operations and Maintenance: This area is for normal Operation and/or Maintenance of the distribution system. Part of O&M training requirement for many operators.

PE - PUMP ENGINEERING: The technical science of pumping and pump performance principles. May be a law or theory or calculation related to pumping. Information that a pump engineer or well operator may need.

SAFETY: This area describes process safety procedures. It may be part of O&M training requirement for many operators.

TECH - TECHNICAL: The daily operation of mechanical or physical treatment process/component. Part of O&M training for many operators.

WQ – Water Quality: Having to do with Water Quality or pollutants, i.e., hard water to primary water standards. May be a requirement of the SDWA and/or water chemistry concerns. This along with the EPA information is to satisfy the regulatory portion of your operator training.

Preface

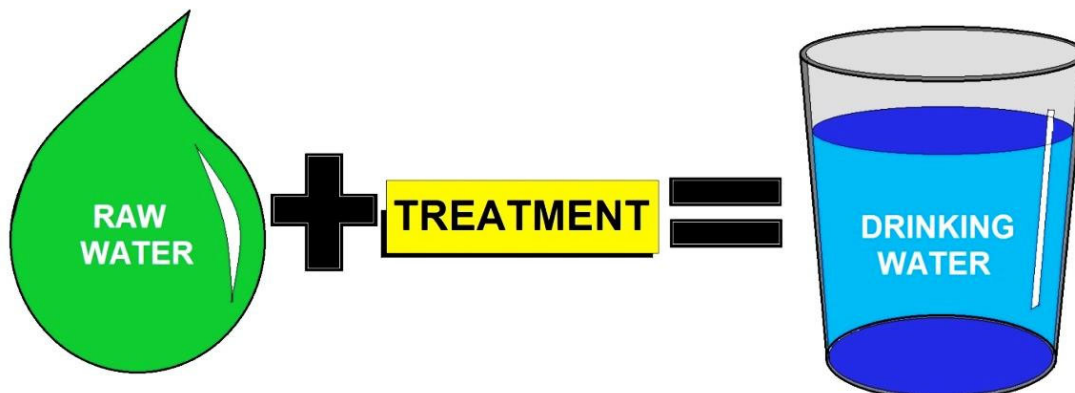

Safe Drinking Water Act of 1974 Introduction

(PL 93-523) as amended by:

- The Safe Drinking Water Act Amendments of 1986
- National Primary Drinking Water Regulations, 40 CFR 141
- National Interim Primary Drinking Water Regulations Implementation, 40 CFR142
- National Secondary Drinking Water Regulations, 40 CFR 143

This is the primary Federal legislation protecting drinking water supplied by public water systems (those serving more than 25 people). The Environmental Protection Agency (EPA) is the lead agency and is mandated to set standards for drinking water. The EPA establishes national standards of which the states are responsible for enforcing.

The act provides for the establishment of primary regulations for the protection of the public health and secondary regulations relating to the taste, odor, and appearance of drinking water. Primary drinking water regulations, by definition, include either a maximum contaminant level (MCL) or, when a MCL is not economically or technologically feasible, a prescribed treatment technique which would prevent adverse health effects to humans.

An MCL is the permissible level of a contaminant in water that is delivered to any user of a public water system. Primary and secondary drinking water regulations are stated in 40 CFR 141 and 143, respectively. As amended in 1986, the EPA is required to set maximum contaminant levels for 83 contaminants deemed harmful to humans (with specific deadlines). It also has authority over groundwater. Water agencies are required to monitor water to ensure it meets standards.

National Drinking Water Regulations

The Act instructs the EPA on how to select contaminants for regulation and specifies how the EPA must establish national primary drinking water regulations once a contaminant has been selected (Section 1412). As of late 1996, the EPA had promulgated 84 drinking water regulations.

Contaminant Selection

P.L. 104-182 establishes a new process for the EPA to select contaminants for regulatory consideration based on occurrence, health effects, and meaningful opportunity for health risk reduction. By February 1998 and every 5 years thereafter, the EPA must publish a list of contaminants that may warrant regulation. Every 5 years thereafter, the EPA must determine whether or not to regulate at least 5 of the listed contaminants.

The Act directs the EPA to evaluate contaminants that present the greatest health concern and to regulate contaminants that occur at concentration levels and frequencies of public health concern. The law also includes a schedule for the EPA to complete regulations for disinfectants and disinfection byproducts (D/DBPs) and *Cryptosporidium* (a waterborne pathogen).

Standard Setting

Developing national drinking water regulations is a two-part process. For each contaminant that the EPA has determined merits regulation, the EPA must set a non-enforceable maximum contaminant level goal (MCLG) at a level at which no known or anticipated adverse health effects occur, and which allows an adequate margin of safety.

The EPA must then set an enforceable standard, a maximum contaminant level (MCL), as close to the MCLG as is "*feasible*" using the best technology, treatment techniques, or other means available (taking costs into consideration).

Standards are generally based on technologies that are affordable for large communities; however, under P.L. 104-182, each regulation establishing an MCL must list any technologies, treatment techniques, or other means that comply with the MCL and that are affordable for three categories of small public water systems.

The 1996 Amendments authorize the EPA to set a standard at other than the feasible level if the feasible level would lead to an increase in health risks by increasing the concentration of other contaminants or by interfering with the treatment processes used to comply with other SDWA regulations. In such cases, the standard or treatment techniques must minimize the overall health risk.

Also, when proposing a regulation, the EPA must now publish a determination as to whether or not the benefits of the standard justify the costs. If the EPA determines that the benefits do not justify the costs, the EPA may, with certain exceptions, promulgate a standard that maximizes health risk reduction benefits at a cost that is justified by the benefits.

More on these concerns in the Water Quality Section of the course.

Topic 1- Groundwater Production System Section

Section Focus: You will learn the basics of the groundwater production system. At the end of this section, you will be able to describe how groundwater is pumped and delivered to the customer. There is a post quiz at the end of this section to review your comprehension and a final examination in the Assignment for your contact hours.

Scope/Background: EPA issued the Groundwater Rule (GWR) to improve drinking water quality and provide protection from disease-causing microorganisms. Water systems that have groundwater sources may be susceptible to fecal contamination. In many cases, fecal contamination can contain disease causing pathogens. The purpose of the Groundwater Rule (GWR) is to reduce disease incidence associated with harmful microorganisms in drinking water.

Other EPA drinking water regulations pertain to groundwater systems include:

- Stage 1 and 2 Disinfectants and Disinfection Byproducts Rules (DBPR) (monitoring for DBPs in the distribution system)
- Groundwater Rule (sanitary surveys)
- Revised Total Coliform Rule (monitoring for bacterial contamination in distribution systems)

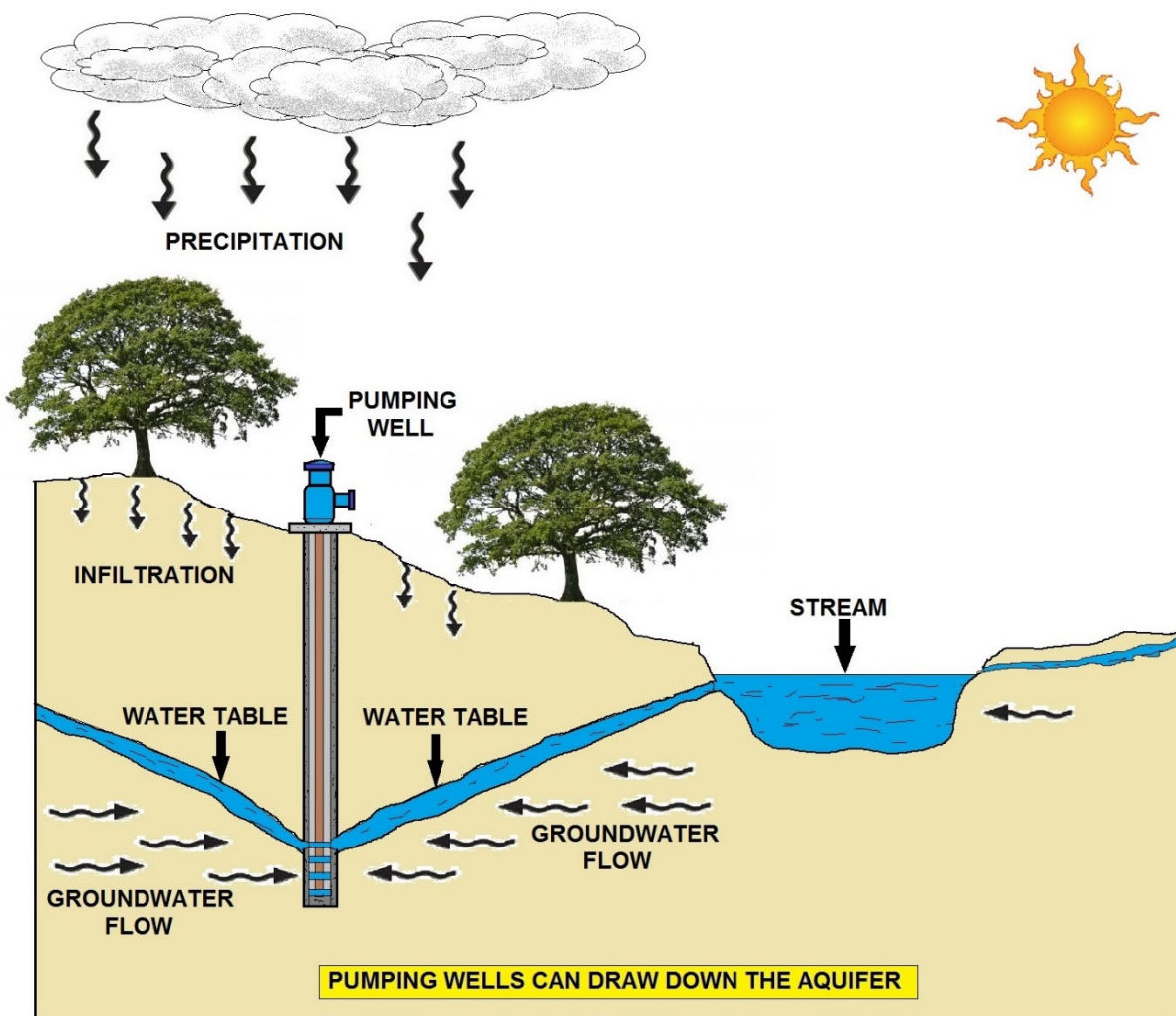

Contaminated Wells Introduction

Contaminated wells used for drinking water are especially dangerous. Wells can be tested to see what chemicals may be in the well and if they are present in dangerous quantities.

Groundwater is withdrawn from wells to provide water for everything from drinking water for the home and business to water to irrigate crops to industrial processing water.

When water is pumped from the ground, the dynamics of groundwater flow change in response to this withdrawal. Groundwater flows slowly through water-bearing formations (aquifers) at different rates. In some places, where groundwater has dissolved limestone to form caverns and large openings, its rate of flow can be relatively fast but this is exceptional.



Well with a mineral oil sealed vertical turbine pump

Groundwater and Wells

A well can be easily contaminated if it is not properly constructed or if toxic materials are released into the well. Toxic material spilled or dumped near a well can leach into the aquifer and contaminate the groundwater drawn from that well.

Groundwater Introduction

Half of all Americans and more than 95 percent of rural Americans get their household water supplies from underground sources of water, or groundwater. Groundwater also is used for about half of the nation's agricultural irrigation and nearly one-third of the industrial water needs. This makes groundwater a vitally important national resource.

Over the last 10 years, however, public attention has been drawn to incidents of groundwater contamination. This has led to the development of groundwater protection programs at federal, state, and local levels. Because groundwater supplies and conditions vary from one area to another, the responsibility for protecting a community's groundwater supplies rests substantially with the local community.

If your community relies on groundwater to supply any portion of its fresh water needs, you, the citizen, will be directly affected by the success or failure of a groundwater protection program.

Equally important, you, the citizen, can directly affect the success or failure of your community's groundwater protection efforts.

This course is intended to help you take an active and positive role in protecting your community's groundwater supplies. It will introduce you to the natural cycle that supplies the earth with groundwater, briefly explain how groundwater can become contaminated, examine ways to protect our vulnerable groundwater supplies, and, most important of all, describe the roles you and your community can play in protecting valuable groundwater supplies.

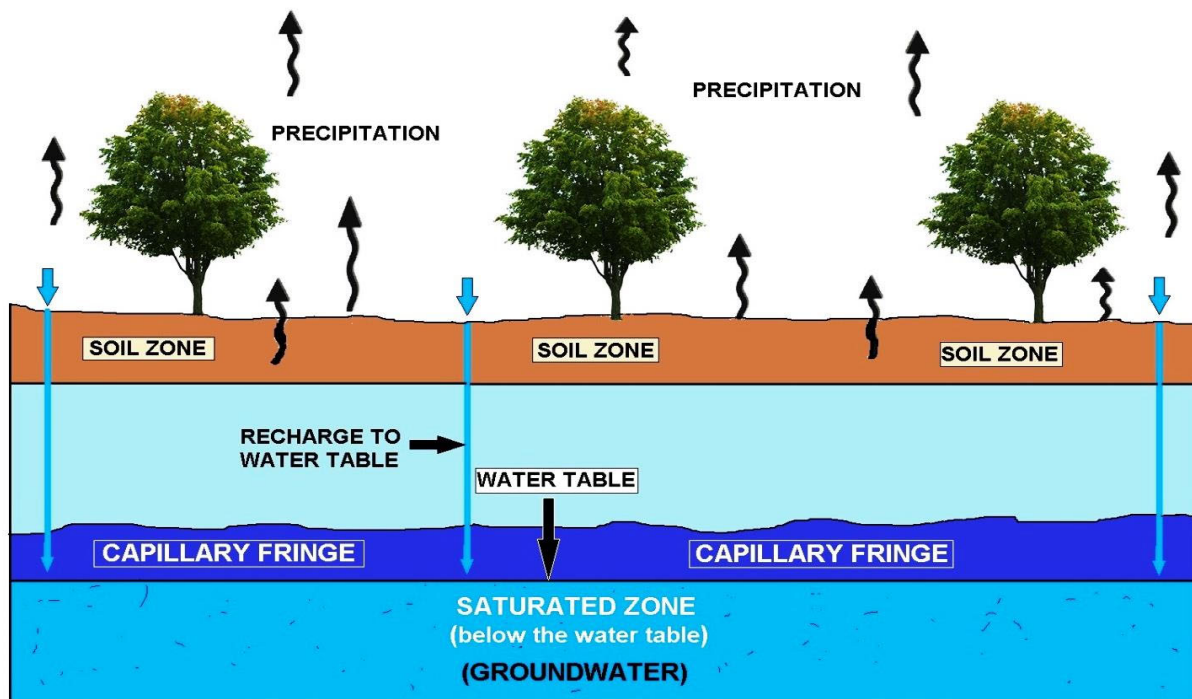

CAPILLARY FRINGE

(Material above water table that may contain water by capillary pressure in small voids)



VERTICAL TURBINE WELL EXAMPLE

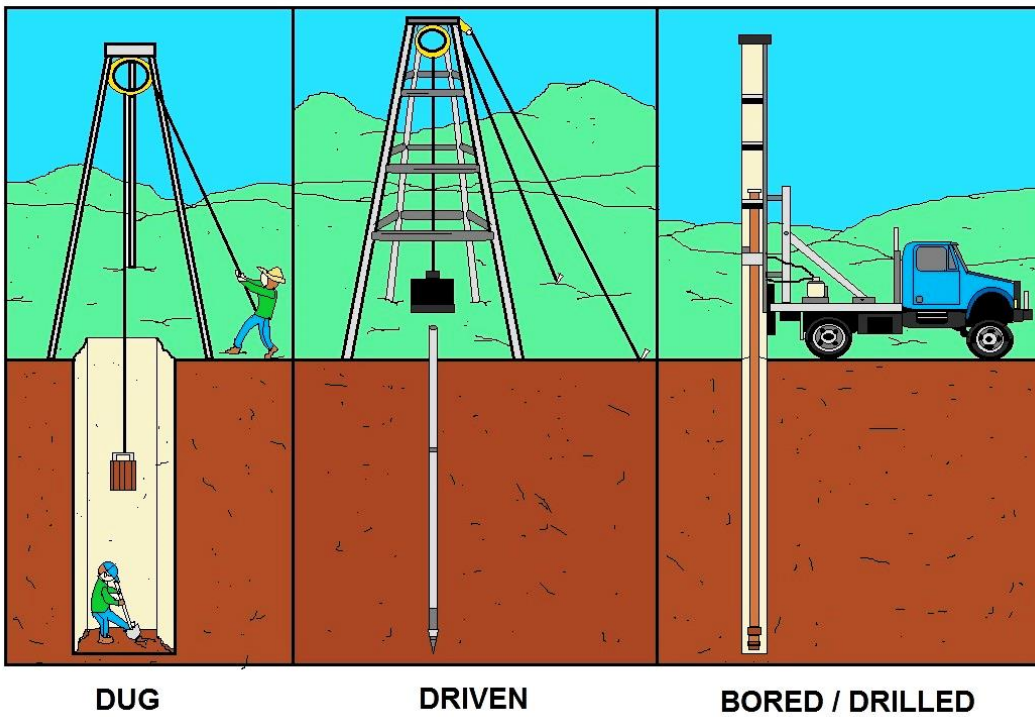

COMMON TYPES OF WATER WELLS

Aquifer Introduction

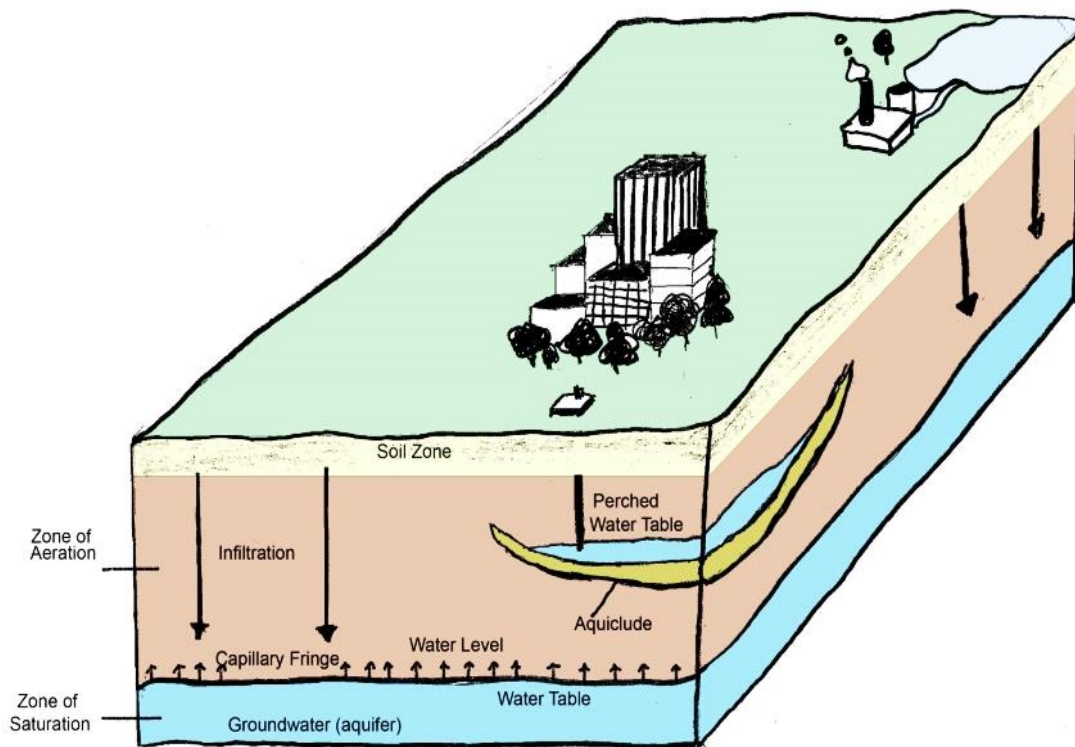

Many terms are used to describe the nature and extent of the groundwater resource. The level below which all the spaces are filled with water is called the *water table*. Above the water table lies the *unsaturated zone*. Here the spaces in the rock and soil contain both air and water. Water in this zone is called *soil moisture*. The entire region below the water table is called the *saturated zone* and water in this saturated zone is called *groundwater*.

Fractured aquifers are cracks, joints, or fractures in solid rock, through which groundwater moves. Examples of fractured aquifers include granite and basalt. Limestones are often fractured aquifers, but here the cracks and fractures may be enlarged by solution, forming large channels or even caverns. Limestone terrain where solution has been very active is termed *karst*.

Porous media such as sandstone may become so highly cemented or recrystallized that all of the original space is filled. In this case, the rock is no longer a porous medium. However, if it contains cracks it can still act as a fractured aquifer.

Most of the aquifers of importance to us are unconsolidated porous media such as sand and gravel. Some very porous materials are not permeable. Clay, for instance, has many spaces between its grains, but the spaces are not large enough to permit free movement of water.

Groundwater usually flows downhill with the slope of the water table. Like surface water, groundwater flows toward, and eventually drains into, streams, rivers, lakes and the oceans.

Groundwater flow in the aquifers underlying springs or surface drainage basins, however, does not always mirror the flow of water on the surface.

Therefore, groundwater may move in different directions below the ground than the water flowing on the surface.

Unconfined aquifers are those that are bounded by the water table. Some aquifers, however, lie beneath layers of impermeable materials.

These are called *confined aquifers*, or some-times *artesian aquifers*. A well in such an aquifer is called an *artesian well*. The water in these wells rises higher than the top of the aquifer because of confining pressure. If the water level rises above the ground surface a *flowing artesian well* occurs.

The *piezometric surface* is the level to which the water in an artesian aquifer will rise.

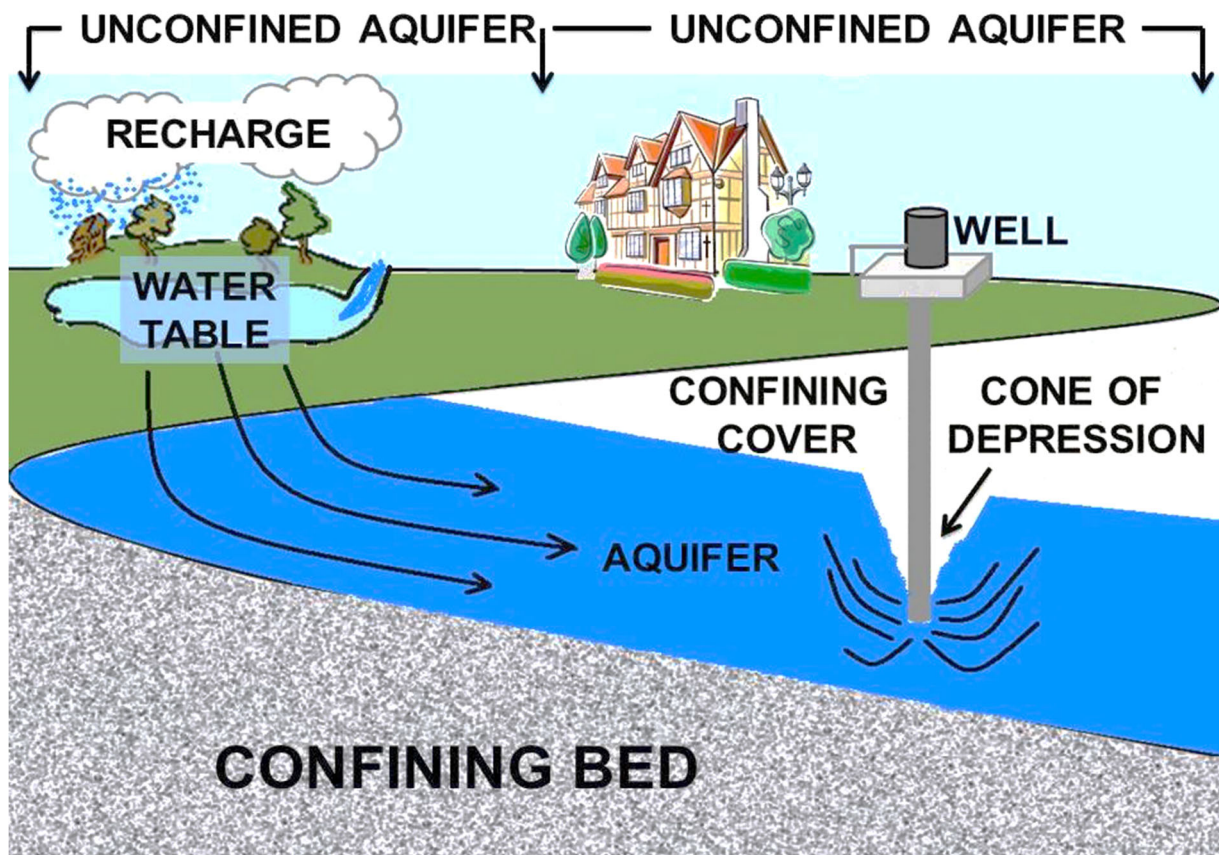

Cone of Depression

When pumping begins, water begins to flow towards the well in contrast to the natural direction of groundwater movement. The water level in the well falls below the water table in the surrounding aquifer.

As a result, water begins to move from the aquifer into the well. As pumping continues, the water level in the well continues to increase until the rate of flow into the well equals the rate of withdrawal from pumping. The movement of water from an aquifer into a well results in the formation of a cone of depression.

The cone of depression describes a three-dimensional inverted cone surrounding the well that represents the volume of water removed as a result of pumping. Drawdown is the vertical drop in the height between the water level in the well prior to pumping and the water level in the well during pumping.

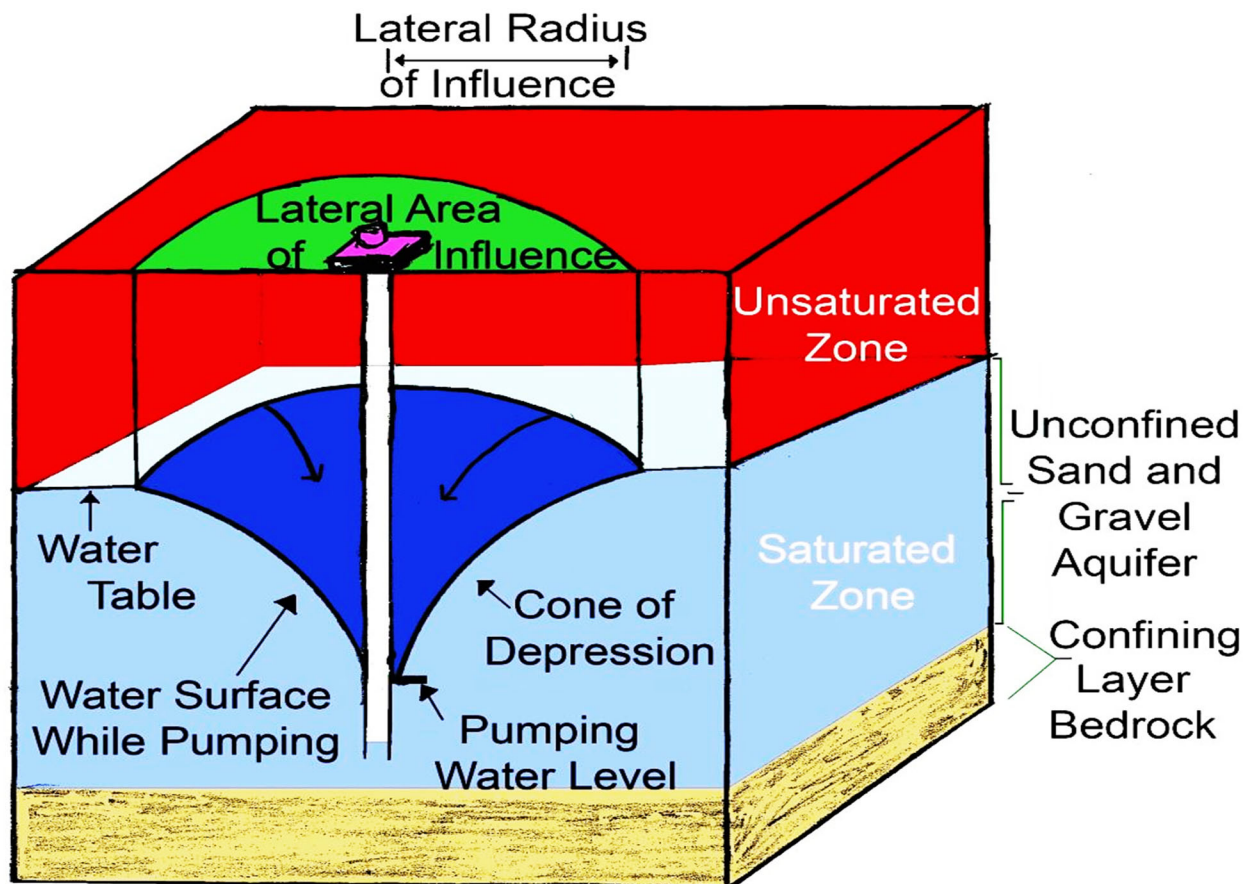

When a well is installed in an unconfined aquifer, water moves from the aquifer into the well through small holes or slits in the well casing or, in some types of wells, through the open bottom of the well. The level of the water in the well is the same as the water level in the aquifer.

Groundwater continues to flow through and around the well in one direction in response to gravity.



Chemical separation and recycling of batteries, oils and paint is important to a groundwater protection program. This includes proper pesticide disposal and triple-rinsing pesticide containers. Be carefully on chemical application and always clean-up spills.



Groundwater Explained

Many people have never heard of groundwater. That's not really so surprising since it isn't readily visible -- groundwater can be considered one of our "*hidden*" resources.

What Is Groundwater and Where Does It Come From?

Actually groundwater occurs as part of what can be called the oldest recycling program - the hydrologic cycle. The hydrologic cycle involves the continual movement of water between the earth and the atmosphere through evaporation and precipitation. As rain and snow fall to the earth, some of the water runs off the surface into lakes, rivers, streams, and the oceans; some evaporates; and some is absorbed by plant roots. The rest of the water soaks through the ground's surface and moves downward through the unsaturated zone, where the open spaces in rocks and soil are filled with a mixture of air and water, until it reaches the water table. The water table is the top of the saturated zone, or the area in which all interconnected spaces in rocks and soil are filled with water. The water in the saturated zone is called groundwater. In areas where the water table occurs at the ground's surface, the groundwater discharges into marshes, lakes, springs, or streams and evaporates into the atmosphere to form clouds, eventually falling back to earth again as rain or snow - thus beginning the cycle all over again.

Where Is Groundwater Stored?

Groundwater is stored under many types of geologic conditions. Areas where groundwater exists in sufficient quantities to supply wells or springs are called aquifers, a term that literally means "water bearer." Aquifers store water in the spaces between particles of sand, gravel, soil, and rock as well as cracks, pores, and channels in relatively solid rocks. An aquifer's storage capacity is controlled largely by its porosity, or the relative amount of open space present to hold water. Its ability to transmit water, or permeability, is based in part on the size of these spaces and the extent to which they are connected.

Basically, there are two kinds of aquifers: confined and unconfined. If the aquifer is sandwiched between layers of relatively impermeable materials (e.g., clay), it is called a confined aquifer.

Confined aquifers are frequently found at greater depths than unconfined aquifers. In contrast, unconfined aquifers are not sandwiched between these layers of relatively impermeable materials, and their upper boundaries are generally closer to the surface of the land.

Does Groundwater Move?

Groundwater can move sideways as well as up or down. This movement is in response to gravity, differences in elevation, and differences in pressure. The movement is usually quite slow, frequently as little as a few feet per year, although it can move as much as several feet per day in more permeable zones. Groundwater can move even more rapidly in karst aquifers, which are areas in water soluble limestone and similar rocks where fractures or cracks have been widened by the action of the groundwater to form sinkholes, tunnels, or even caves.

How Is Groundwater Used?

According to the U.S. Geological Survey, groundwater use increased from about 35 billion gallons a day in 1950 to about 87 billion gallons a day in 1980. Approximately one-half of all fresh water used in the nation comes from groundwater. Whether it arrives via a public water supply system or directly from a private well, groundwater ultimately provides approximately 35 percent of the drinking water supply for urban areas and 95 percent of the supply for rural areas, quenching the thirst and meeting other household needs of more than 117 million people in this nation.

Overall, more than one-third of the water used for agricultural purposes is drawn from groundwater; Arkansas, Nebraska, Colorado, and Kansas use more than 90 percent of their groundwater withdrawals for agricultural activities. In addition, approximately 30 percent of all groundwater is used for industrial purposes. Groundwater use varies among the states, with some states, such as Hawaii, Mississippi, Florida, Idaho, and New Mexico, relying on groundwater to supply considerably more than three-fourths of their household water needs and other states, such as Colorado and Rhode Island, supplying less than one-quarter of their water needs with groundwater.

Groundwater Quality

Until the 1970s, groundwater was believed to be naturally protected from contamination. The layers of soil and particles of sand, gravel, crushed rocks, and larger rocks were thought to act as filters, trapping contaminants before they could reach the groundwater. Since then, however, every state in the nation has reported cases of contaminated groundwater, with some instances receiving widespread publicity. We now know that some contaminants can pass through all of these filtering layers into the saturated zone to contaminate groundwater.

Between 1971 and 1985, 245 groundwater related disease outbreaks, with 52,181 associated illnesses, were reported. Most of these diseases were short-term digestive disorders. About 10 percent of all groundwater public water supply systems are in violation of drinking water standards for biological contamination.

In addition, approximately 74 pesticides, a number of which are known carcinogens, have been detected in the groundwater of 38 states. Although various estimates have been made about the extent of groundwater contamination, these estimates are difficult to verify given the nature of the resource and the difficulty of monitoring its quality.

How Does Groundwater Become Contaminated?

Groundwater contamination can originate on the surface of the ground, in the ground above the water table, or in the ground below the water table.

Table I shows the types of activities that can cause groundwater contamination at each level. Where a contaminant originates is a factor that can affect its actual impact on groundwater quality. For example, if a contaminant is spilled on the surface of the ground or injected into the ground above the water table, it may have to move through numerous layers of soil and other underlying materials before it reaches the groundwater.

As the contaminant moves through these layers, a number of processes are in operation (e.g., filtration, dilution, oxidation, biological decay) that can lessen the eventual impact of the substance once it finally reaches the groundwater.

The effectiveness of these processes also is affected by both the distance between the groundwater and where the contaminant is introduced and the amount of time it takes the substance to reach the groundwater. If the contaminant is introduced directly into the area below the water table, the primary process that can affect the impact of the contaminant is dilution by the surrounding groundwater.

GROUND SURFACE	Infiltration of polluted surface water Land disposal of wastes Stockpiles Dumps Sewage sludge disposal	De-icing salt use & storage Animal feedlots Fertilizers & pesticides Accidental spills Airborne source particulates
ABOVE WATER TABLE	Septic tanks, cesspools, & privies Holding ponds & lagoons Sanitary landfills Waste disposal in excavations Underground storage tank leaks	Underground pipeline leaks Artificial recharge Sumps and dry wells Graveyards
BELOW WATER TABLE	Waste disposal in wells Drainage wells and canals Underground storage Mines	Exploratory wells Abandoned wells Water-supply wells Groundwater withdrawal

TABLE 1. Activities That Can Cause Groundwater Contamination

In comparison with rivers or streams, groundwater tends to move very slowly and with very little turbulence. Therefore, once the contaminant reaches the groundwater, little dilution or dispersion normally occurs. Instead, the contaminant forms a concentrated plume that can flow along the same path as the groundwater. Among the factors that determine the size, form, and rate of movement of the contaminant plume are the amount and type of contaminant and the speed of groundwater movement.

Because groundwater is hidden from view, contamination can go undetected for years until the supply is tapped for use.

What Kinds of Substances Can Contaminate Groundwater, Where Do They Come From?

Substances that can contaminate groundwater can be divided into two basic categories: substances that occur naturally and substances produced or introduced by man's activities. Substances that occur naturally include minerals such as iron, calcium, and selenium. Substances resulting from man's activities include synthetic organic chemicals and hydrocarbons (e.g., solvents, pesticides, petroleum products); landfill leachates (liquids that have dripped through the landfill and carry dissolved substances from the waste materials), containing such substances as heavy metals and organic decomposition products; salt; bacteria; and viruses. A significant number of today's groundwater contamination problems stem from man's activities and can be introduced into groundwater from a variety of sources.

Septic Tanks, Cesspools, and Privies

A major cause of groundwater contamination in many areas of the United States is effluent, or outflow, from septic tanks, cesspools, and privies. Approximately one fourth of all homes in the United States rely on septic systems to dispose of their human wastes. If these systems are improperly sited, designed, constructed, or maintained, they can allow contamination of the groundwater by bacteria, nitrates, viruses, synthetic detergents, household chemicals, and chlorides.

Although each system can make an insignificant contribution to groundwater contamination, the sheer number of such systems and their widespread use in every area that does not have a public sewage treatment system makes them serious contamination sources.

Surface Impoundments

Another potentially significant source of groundwater contamination is the more than 180,000 surface impoundments (e.g., ponds, lagoons) used by municipalities, industries, and businesses to store, treat, and dispose of a variety of liquid wastes and wastewater. Although these impoundments are supposed to be sealed with compacted clay soils or plastic liners, leaks can and do develop.

Agricultural Activities

Agricultural activities also can make significant contributions to groundwater contamination with the millions of tons of fertilizers and pesticides spread on the ground and from the storage and disposal of livestock wastes. Homeowners, too, can contribute to this type of groundwater pollution with the chemicals they apply to their lawns, rosebushes, tomato plants, and other garden plants.

Landfills

There are approximately 500 hazardous waste land disposal facilities and more than 16,000 municipal and other landfills nationwide. To protect groundwater, these facilities are now required to be constructed with clay or synthetic liners and leachate collection systems. Unfortunately, these requirements are comparatively recent, and thousands of landfills were built, operated, and abandoned in the past without such safeguards. A number of these sites have caused serious groundwater contamination problems and are now being cleaned up by their owners, operators, or users; state governments; or the federal government under the Superfund program.

In addition, a lack of information about the location of many of these sites makes it difficult, if not impossible, to determine how many others may now be contaminating groundwater.

Underground Storage Tanks

Between five and six million underground storage tanks are used to store a variety of materials, including gasoline, fuel oil, and numerous chemicals. The average life span of these tanks is 18 years, and over time, exposure to the elements causes them to corrode. Now, hundreds of thousands of these tanks are estimated to be leaking, and many are contaminating groundwater. Replacement costs for these tanks are estimated at \$1 per gallon of storage capacity; a cleanup operation can cost considerably more.

Abandoned Wells

Wells can be another source of groundwater contamination. In the years before there were community water supply systems, most people relied on wells to provide their drinking water. In rural areas this can still be the case. If a well is abandoned without being properly sealed, however, it can act as a direct channel for contaminants to reach groundwater.

Accidents and Illegal Dumping

Accidents also can result in groundwater contamination. A large volume of toxic materials is transported throughout the country by truck, train, and airplane.

Every day accidental chemical or petroleum product spills occur that, if not handled properly, can result in groundwater contamination. Frequently, the automatic reaction of the first people at the scene of an accident involving a spill will be to flush the area with water to dilute the chemical. This just washes the chemical into the soil around the accident site, allowing it to work its way down to the groundwater. In addition, there are numerous instances of groundwater contamination caused by the illegal dumping of hazardous or other potentially harmful wastes.

Highway De-icing

A similar flushing mechanism also applies to the salt that is used to de-ice roads and highways throughout the country every winter. More than 11 million tons of salt are applied to roads in the United States annually. As ice and snow melt or rain subsequently falls, the salt is washed into the surrounding soil where it can work its way down to the groundwater. Salt also can find its way into groundwater from improperly protected storage stockpiles.

What Can Be Done After Contamination Has Occurred?

Unlike rivers, lakes, and streams that are readily visible and whose contamination frequently can be seen with the naked eye, groundwater itself is hidden from view. Its contamination occurs gradually and generally is not detected until the problem has already become extensive. This makes cleaning up contamination a complicated, costly, and sometimes impossible process.

In general, a community whose groundwater supply has been contaminated has five options:

1. Contain the contaminants to prevent their migration from their source.
2. Withdraw the pollutants from the aquifer.
3. Treat the groundwater where it is withdrawn or at its point of use.
4. Rehabilitate the aquifer by either immobilizing or detoxifying the contaminants while they are still in the aquifer.
5. Abandon the use of the aquifer and find alternative sources of water

Which option is chosen by the community is determined by a number of factors, including the nature and extensiveness of the contamination, whether specific actions are required by statute, the geologic conditions, and the funds available for the purpose. All of these options are costly. For example, a community in Massachusetts chose a treatment option when the wells supplying its public water system were contaminated by more than 2,000 gallons of gasoline that had leaked into the ground from an underground storage tank less than 600 feet from one of the wells.

The town temporarily provided alternative water supplies for its residents and then began a cleanup process that included pumping out and treating the contaminated water and then recharging the aquifer with the treated water. The cleanup effort alone cost more than \$3 million. Because of the high costs and technical difficulties involved in the various containment and treatment methods, many communities will choose to abandon the use of the aquifer when facing contamination of their groundwater supplies.

This requires the community to either find other water supplies, drill new wells farther away from the contaminated area of the aquifer, deepen existing wells, or drill new wells in another aquifer if one is located nearby. As Atlantic City, New Jersey, found, these options also can be very costly for a community. The wells supplying that city's public water system were contaminated by leachate from a landfill. The city estimated that development of a new wellfield would cost approximately \$2 million.

Government Groundwater Protection Activities

Given the importance of groundwater as a source of drinking water for so many communities and individuals and the cost and difficulty of cleaning it up, common sense tells us that the best way to guarantee continued supplies of clean groundwater is to prevent contamination.

Are There Federal Laws or Programs to Protect Groundwater?

The U.S. Environmental Protection Agency (EPA) is responsible for federal activities relating to the quality of groundwater. EPA's groundwater protection activities are authorized by a number of laws, including:

The Safe Drinking Water Act, which authorizes EPA to set standards for maximum levels of contaminants in drinking water, regulate the underground disposal of wastes in deep wells, designate areas that rely on a single aquifer for their water supply, and establish a nationwide program to encourage the states to develop programs to protect public water supply wells (i.e., wellhead protection programs).

The Resource Conservation and Recovery Act, which regulates the storage, transportation, treatment, and disposal of solid and hazardous wastes to prevent contaminants from leaching into groundwater from municipal landfills, underground storage tanks, surface impoundments, and hazardous waste disposal facilities.

The Comprehensive Environmental Response, Compensation, and Liability Act (Superfund), which authorizes the government to clean up contamination caused by chemical spills or hazardous waste sites that could (or already do) pose threats to the environment, and whose 1986 amendments include provisions authorizing citizens to sue violators of the law and establishing "community right-to-know" programs (Title III).

The Federal Insecticide, Fungicide, and Rodenticide Act, which authorizes EPA to control the availability of pesticides that have the ability to leach into groundwater.

The Toxic Substances Control Act which authorizes EPA to control the manufacture, use, storage, distribution, or disposal of toxic chemicals that have the potential to leach into groundwater.

The Clean Water Act, which authorizes EPA to make grants to the states for the development of groundwater protection strategies and authorizes a number of programs to prevent water pollution from a variety of potential sources.

The federal laws tend to focus on controlling potential sources of groundwater contamination on a national basis. Where federal laws have provided for general groundwater protection activities such as wellhead protection programs or development of state groundwater protection strategies, the actual implementation of these programs must be by the states in cooperation with local governments.

A major reason for this emphasis on local action is that protection of groundwater generally involves making very specific decisions about how land is used. Local governments frequently exercise a variety of land-use controls under state laws.

Do the States Have Laws or Programs to Protect Groundwater?

According to a study conducted for EPA in 1988, most of the states have passed some type of groundwater protection legislation and developed some kind of groundwater policies. State groundwater legislation can be divided into the following subject categories:

Statewide strategies - Requiring the development of a comprehensive plan to protect the state's groundwater resources from contamination.

Groundwater classification - Identifying and categorizing groundwater sources by how they are used to determine how much protection is needed to continue that type of use.

Standard setting - Identifying levels at which an aquifer is considered to be contaminated.

Land-use management - Developing planning and regulatory mechanisms to control activities on the land that could contaminate an aquifer.

Groundwater funds - Establishing specific financial accounts for use in the protection of groundwater quality and the provision of compensation for damages to underground drinking water supplies (e.g., reimbursement for groundwater cleanup, provision of alternative drinking water supplies).

Agricultural chemicals - Regulating the use, sale, labeling, and disposal of pesticides, herbicides, and fertilizers.

Underground storage tanks - Establishing criteria for the registration, construction, installation, monitoring, repair, closure, and financial responsibility associated with tanks used to store hazardous wastes or materials.

Water-use management - Including groundwater quality protection in the criteria used to justify more stringent water allocation measures where excessive groundwater withdrawal could cause groundwater contamination.

APPENDIX 1. POTENTIALLY HARMFUL COMPONENTS OF COMMON HOUSEHOLD PRODUCTS

Product	Toxic or Hazardous Components
Antifreeze (gasoline or coolant systems)	methanol, ethylene glycol
Automatic transmission fluid	petroleum distillates, xylene
Battery acid (Electrolyte)	sulfuric acid
Degreasers for driveways and garages	petroleum solvents, alcohols, glycol ether
Degreasers for engines and metal	chlorinated hydrocarbons, toluene, phenols, dichloroperchloroethylene
Engine and radiator flushes	petroleum solvents, ketones, butanol, glycol ether
Hydraulic fluid (brake fluid)	hydrocarbons, fluorocarbons
Motor oils; and waste oils	hydrocarbons
Gasoline and jet fuel	hydrocarbons
Diesel fuel, kerosene, #2 heating oil	hydrocarbons
Grease, lubes	hydrocarbons
Rustproofers	hydrocarbons
Car wash detergents	phenols, heavy metals
Car waxes and polishes	alkyl benzene sulfonates
Asphalt and roofing tar	petroleum distillates, hydrocarbons
Paints, varnishes, stains, dyes	hydrocarbons
Paint and lacquer thinner	heavy metals, toluene
Paint and varnish removers, deglossers	acetone, benzene, toluene, butyl, acetate, methyl ketones
Paint brush cleaners	methylene chloride, toluene, acetone, xylene, ethanol, benzene, methanol
Floor and furniture strippers	hydrocarbons, toluene, acetone, methanol, glycol ethers, methyl ethyl ketones
Metal polishes	xylene
Laundry soil and stain removers	petroleum distillates, isopropanol, petroleum
Spot removers arid dry cleaning fluid	naphtha
Other solvents	petroleum distillates, tetrachloroethylene
Rock salt (Halite)	hydrocarbons, benzene, trichloroethylene, 1, 1, 1 trichloroethane
Refrigerants	acetone, benzene
Bug and tar removers	sodium concentration
Household cleansers, oven cleaners	1, 1, 2 trichloro - 1, 2, 2 trifluoroethane
Drain cleaners	xylene, petroleum distillates
Toilet cleaners	xlenols, glycol ethers, isopropanol
Cesspool cleaners	1, 1, 1 trichloroethane
Disinfectants	xylene, sulfonates, chlorinated phenols
Pesticides (all types)	tetrachloroethylene, dichlorobenzene, methylene chloride
Photochemicals	cresol, xlenols
Printing ink	naphthalene, phosphorus, xylene, chloroform, heavy metals, chlorinated hydrocarbons
Wood preservatives (creosote)	phenols, sodium sulfite, cyanine, silver halide, potassium bromide
Swimming pool chlorine	heavy metals, phenol-formaldehyde
Lye or caustic soda	pentachlorophenols
Jewelry cleaners	sodium hypochlorite
	sodium hydroxide
	sodium cyanide

Water Well Reports and Hydrogeology Introduction

Filling in the blanks doesn't just satisfy some agency's requirements. Good well reports also provide hydrogeologists from the public and private sector with valuable information regarding local groundwater systems. By Dennis Nelson

HYDROGEOLOGISTS ARE OFTEN CALLED UPON TO evaluate an aspect of a groundwater system—for example, the direction of groundwater flow, the potential impact of a given land use on groundwater, the potential impact of a well on another well or nearby stream, or the “capture zone” for a given well.

In order to conduct such an evaluation, the hydrogeologist must have actual or reasonable estimates of the physical and hydraulic properties of the geologic material through which the groundwater is moving.

In some cases, data may be available in the form of geologic maps, aquifer tests, monitoring wells, or written reports. In many cases, however, the only information available is in the form of well reports (well logs), filed by well constructors at the time of drilling.



The importance of water well reports in hydrogeological investigations cannot be overstated. The information collected by well constructors during and after the drilling of a well is often the only information available to the hydrogeologist. In many cases, it is our only “window” into the aquifer.

The purpose of this document is to describe the type of groundwater information needed to conduct typical hydrogeological assessments, and how the data collected by well constructors is used to obtain this information.

Hydrogeologic Data

For hydrogeologists to make reliable assessments about the current and future status of groundwater, they need to know where groundwater occurs in the subsurface, what the properties are of the various geologic units below the surface, and how fast and in what direction groundwater is moving. Obtaining the data necessary for these studies can be time consuming and expensive.

Well reports, however, can provide information that can be used to determine if further data is needed, and if so, what data and from where. In this document, important hydrogeologic parameters that are used will be discussed first, followed by several general examples of how they are used. Finally, how a typical well report can be used to acquire this data will be described.

Depth to the Aquifer

It is necessary to identify which geologic unit is the aquifer; i.e., the porous and permeable rock or sediment that contains groundwater and the depth at which it occurs. It is often also important to know the type of geologic materials that occur from the surface down to the top of the aquifer.

Nature of the Aquifer

The nature of the aquifer can be described as either unconfined or confined. An unconfined aquifer has the water table as its upper surface; there are no significant low-permeability layers between the water table and the surface; and the aquifer is recharged locally, (in the immediate vicinity of the well). The top of the aquifer, the water table, can rise or fall depending on water use and amount of recharge to the aquifer.

A confined aquifer has a low-permeability geologic formation (a confining layer) as its upper boundary; the groundwater in the aquifer is under pressure; the aquifer is separated from the surface by the confining layer and generally is recharged at some distance from the well, e.g., in nearby or distant areas of higher topography.

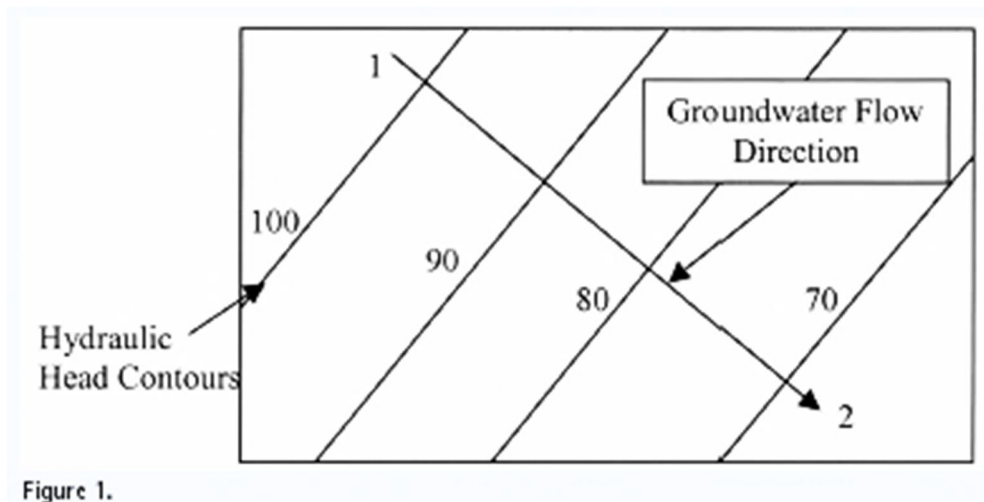

Hydraulic Head (h)

The hydraulic head is a measure of the energy that the water at a certain depth possesses because of its elevation and the pressure exerted through the weight of the water above it. Hydraulic head has units of feet, and generally corresponds to the elevation of water in the well.

Hydraulic head is the driving force for groundwater movement either in a horizontal or vertical direction. Groundwater moves from where the head is higher to where the head is lower. If we have enough hydraulic head data for an aquifer over a given area, we can contour the head elevation just like the ground elevation is contoured on a topographic map. Groundwater will move from high head areas to low head areas and will generally flow in a direction that crosses the contours at a 90° angle (see Figure 1).

The change in hydraulic head ($h_1 - h_2$) over the distance from point 1 to point 2 ($D_{1,2}$) is the gradient (I), calculated as

$$I = (h_1 - h_2) / D_{1,2}$$

In Figure 1, assuming points 1 and 2 represent individual wells, the gradient would be the difference in head between well 1 (~102 feet) and well 2 (~68 feet) divided by the horizontal (map) distance between the two wells.

Thickness of the Aquifer (b) and Water-Bearing Zones

To evaluate the amount of groundwater moving through the aquifer or its ability to supply groundwater to wells, it is necessary to know the thickness of the aquifer. It is also important to be able to identify whether the aquifer is uniform throughout its thickness or consists of one or more discrete water-bearing zones.

Aquifer Porosity (n)

The volume of open space relative to the total volume of the aquifer (porosity) and the degree to which these pore spaces are interconnected (effective porosity) controls the volume of water in the aquifer and the amount of water that can be reasonably withdrawn from the aquifer. For a given gradient, the effective porosity strongly influences the velocity in which the groundwater is moving.

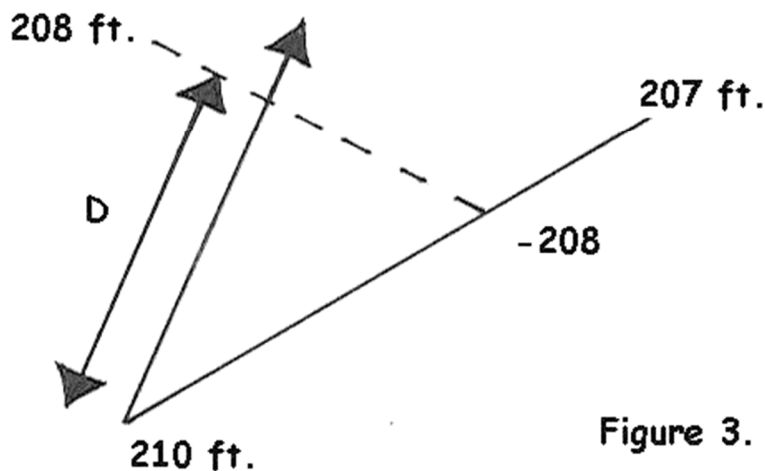
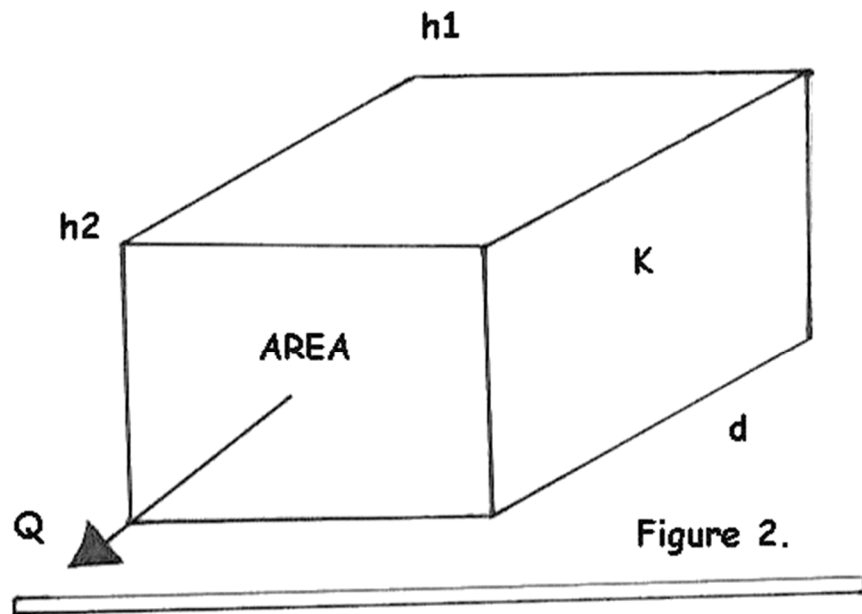

$$\text{Hydraulic Gradient} = \frac{h_A - h_B}{l} = \frac{\Delta h}{l}$$

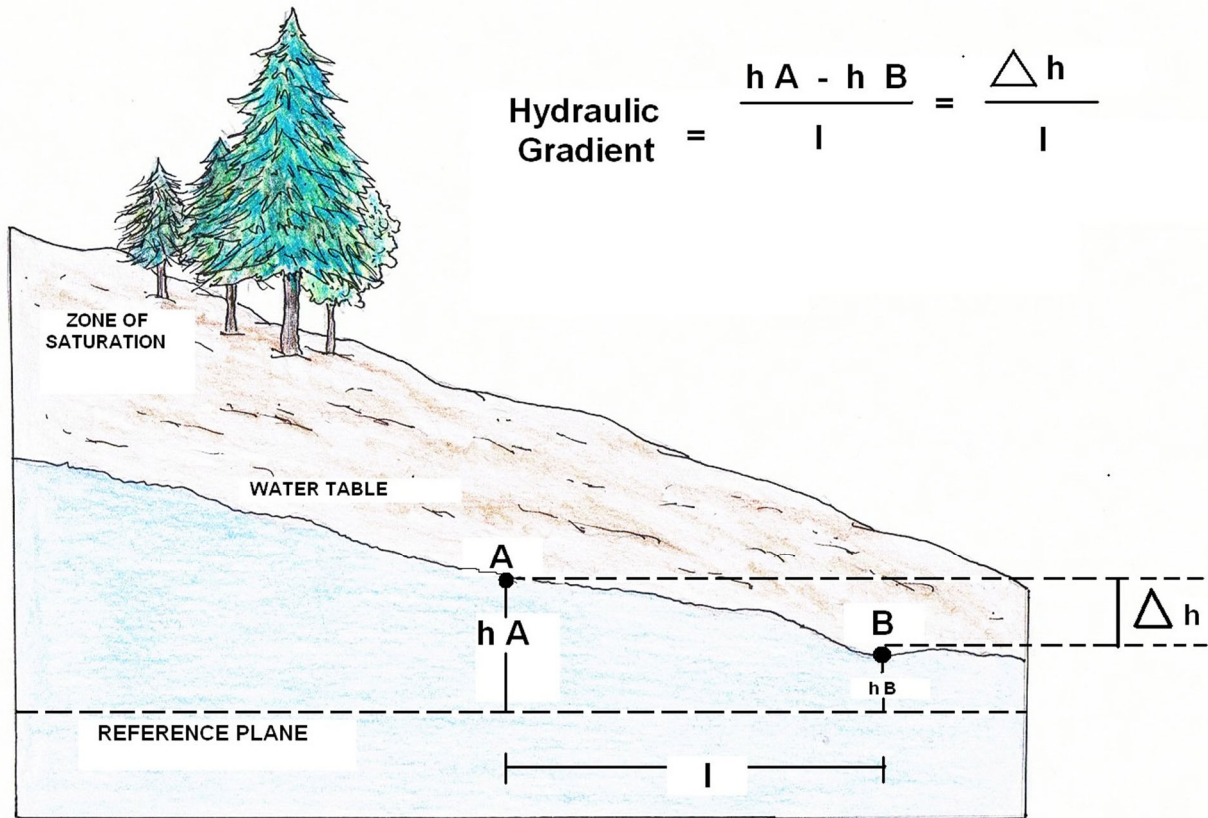

Permeability of the Aquifer (K)

The permeability, or hydraulic conductivity, of the aquifer is a measure of how fast groundwater can move through the aquifer. Hydraulic conductivity has units of distance/time, e.g., feet/day, although it does not represent an actual speed.

Examples of the Use of Hydrogeological Parameters--Is the Aquifer Unconfined or Confined?

As indicated previously, whether an aquifer is confined or unconfined has important implications for its vulnerability to pollution. The most direct method of determining this characteristic is to compare the hydraulic head to the elevation of the top of the aquifer. Unconfined aquifers have the water table as their upper boundary. The water table is at atmospheric pressure and therefore, when the aquifer is drilled into, the water level in the well remains at the same elevation as the water table. Confined aquifers contain water that is under pressure.

When the aquifer is drilled into, the water level in the well will rise to a higher elevation than that of the top of the aquifer (remember that water seeks its own level).

Volume Rate of Groundwater Moving Through an Aquifer

If we wanted to know how much groundwater was traveling through an aquifer, we can apply Darcy's law, which states that the rate (Q) is equal to the hydraulic conductivity (K), times the cross-sectional area of the aquifer (A), times the hydraulic gradient (I):

$$Q \text{ (ft}^3\text{/day)} = K \text{ (ft/day)} \times A \text{ (ft}^2\text{)} \\ \times I \text{ (ft/ft),}$$

where $I = (h_1 - h_2)/d$ in Figure 2.

Consider a gravel quarry that intersects an aquifer through a thickness of 50 feet and a width of 500 feet. If the aquifer had a hydraulic conductivity of 50 feet/day with a gradient of a 1-foot drop for every 1000 feet of horizontal distance ($I = 0.001$), what volume of groundwater would have to be pumped out of the quarry each day in order to keep it dry?

$$Q \text{ (ft}^3\text{/day)} = 50 \text{ ft/day} \times (50 \text{ feet} \times 500 \text{ feet}) \times 0.001 \text{ (ft/ft)}$$

$$Q \text{ (ft}^3\text{/day)} = 1250 \text{ ft}^3\text{/day or approximately 9300 gallons per day}$$

It is common to combine the hydraulic conductivity and aquifer thickness to yield a number referred to as the transmissivity ($T = Kb$), a parameter that is more directly related to the volume of groundwater flow. Using the transmissivity term, Darcy's law becomes;

$$Q \text{ (ft}^3\text{/day)} = T \text{ (ft}^2\text{/day)} \times w \text{ (ft)} \times I \text{ (ft/ft)}$$

In What Direction Is Groundwater Flowing?

The direction of groundwater flow is from higher to lower hydraulic head. Consequently, if we have wells that produce from the same aquifer, we can estimate the direction of groundwater flow. The hydraulic head can be measured by lowering a probe through the observation port of a number of wells, all within the same relative time period, i.e., within a few days of each other.

A minimum of three wells is required to estimate the direction of flow. We can also determine the gradient from these wells. Three wells from the same aquifer have hydraulic heads (elevation of the water table) of 207, 208, and 210 feet.

What is the direction groundwater is flowing and what is the gradient?

We begin by drawing a line from the lowest (207 feet) to highest (210 feet) value of head. We note that somewhere along that line, the elevation of 208 feet, the intermediate value, must fall. If we assume that the water table has a constant slope, an elevation of 208 feet will occur one-third of the way from 207 to 210 ($(208-207)/(210-207)$).

Once we have determined where the 208 feet elevation occurs along the line, we can draw a line from that point to the well with the 208 feet hydraulic head. This line represents the 208 feet contour on the water table. As mentioned before, groundwater tends to flow directly across, i.e., perpendicular to, the contours from higher head to lower head.

The arrow, then, represents the direction of flow. The gradient can be calculated by measuring D, the distance along the perpendicular from the well, with the 210-foot head to the 208-foot contour using the equation:

$$I = (h_2 - h_1)/D = (210 - 208)/D$$

Note that the three-point solution works best on wells that are relatively close to one another.

How Fast Is Groundwater Moving?

The speed of groundwater movement in the down gradient direction can be calculated using a modified version of Darcy's law:

$$V \text{ (ft/day)} = KI$$

This equation assumes that groundwater is moving across the entire area of the aquifer, but in the real world, groundwater does not flow that way. Groundwater is moving only through the pore spaces (actual openings in that area). As a result, we have to include the porosity (n) in this equation: $V = KI/n$

Using the gravel quarry example given before ($K = 50 \text{ ft/day}$; $I = 0.001$; $n = 0.25$), the velocity of groundwater through the aquifer can be determined as follows:

$$V = (50 \text{ ft/day} \times 0.001)/0.25 = 0.2 \text{ foot/day}$$

What Is the Drawdown Associated with Pumping of a Well?

Often we would like to know how the pumping of one well might affect the water level in another. There is a relation between the pumping rate of the well, the transmissivity of the aquifer, the distance between wells, the storage coefficient of the aquifer, and the duration of the pumping event.

The storage coefficient of an aquifer is related to how much water is released from the aquifer as the hydraulic head of the groundwater drops. The storage coefficient is slightly less than porosity for an unconfined aquifer (from 0.10 to 0.25) and is significantly less than porosity in a confined aquifer (from 0.01 to 0.000001 or less).

For unconfined aquifers, using the porosity is a reasonable approximation in most cases. No simple expression is available to determine drawdown as a function of distance for a given set of conditions; however, there are a number of computer programs that can perform this calculation with input of the previously mentioned parameters.

Using the Well Report

Although most of the proposed questions can best be addressed through more detailed hydrogeologic investigations, we can often make reasonable estimates from available well reports if they have been carefully filled out (see The Well Guy, “*Lithology*,” May 2002, Water Well Journal).

Well report forms vary from state to state, but most contain data that is relevant to a hydrogeologic investigation. Using typical entries from a well report form, let’s examine where we can obtain the data we need.

Well Location

For most hydrogeologic studies, the precise location of the well is very important. In many cases, wells are located only to the nearest section or perhaps in a quarter-section. In the latter case, we still only know the location to the nearest 40 acres. Over the last few years, well constructors have been using tax lot information to locate wells. This is an improvement, but depending on lot size, there still may be significant uncertainty.

We hope that more and more well constructors will take advantage of low-cost global positioning system (GPS) technology and begin reporting well location as latitude and longitude. There are 24 satellites positioned above the earth’s surface and at any given time off-the shelf GPS units are capable of linking to three or more of these and determining locations within 100 feet or less.

Such high precision locations greatly enhance our ability to use the well report data to determine direction of groundwater flow, groundwater gradients, variation of aquifer properties throughout an area, and so on.



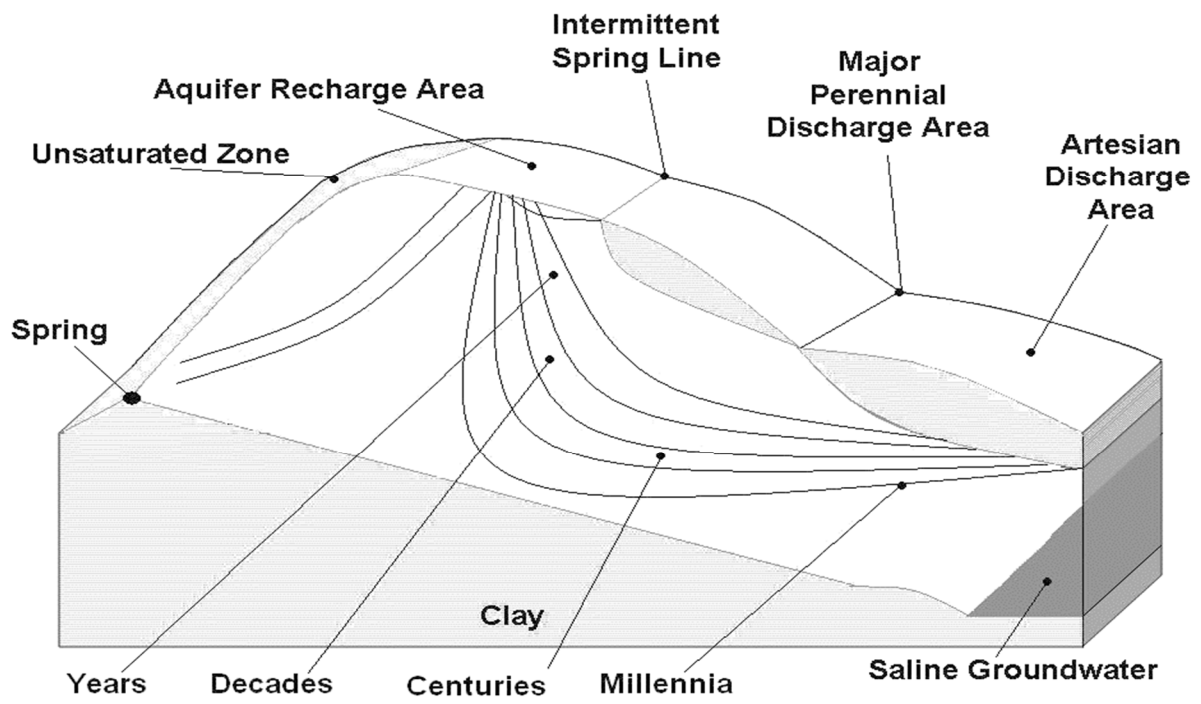

Well Tests

Most well reports require the well constructor to perform some level of pump test to evaluate the capacity of the well. If the well constructor has carefully monitored the rate of water production (Q) and drawdown (s) associated with that production over the period of the test (t), the hydrogeologist can often derive useful information regarding the permeability or hydraulic conductivity (K) of the aquifer. The specific capacity (SC) of the aquifer at the well site is defined as the ratio of the discharge of the well to the total drawdown:

$$SC = Q \text{ (gpm)}/s \text{ (ft.)}$$

The transmissivity of the aquifer can be estimated from the specific capacity through the following relationship:

$$T \text{ (ft}^2\text{/day)} = AC \times SC \text{ (gpm/ft.)}$$

Where AC is a number varying in value depending on the aquifer characteristics.

If the hydrogeologist can determine the aquifer thickness from elsewhere in the well report, the hydraulic conductivity can be derived from this transmissivity value. It must be stressed that the specific capacity data can in no way replace the time-drawdown information acquired from a well-designed constant rate aquifer test. However, it does provide an approximation, and if enough specific capacity data can be found for an area, reasonable estimates can be made.

For information on conducting aquifer tests, see www.ohd.hr.state.or.us/ and click on "**How to prepare for an aquifer test.**" So what is a hydrogeologist looking for in specific capacity data? Ideally, the SC test will have been accomplished using a pump over a period of at least four hours. Why four hours? Let's consider a 50 gpm test of 25-foot-thick sand and gravel aquifer. If this test lasts for only an hour, all the water will be derived from within 4.5 feet of the well.

This small volume will not be very representative of the aquifer in general. If the test is run over a longer time period, a larger volume of aquifer can be "**sampled**" and the resulting hydraulic conductivity estimate will be more representative of the aquifer.

Depth to First Water-Bearing Zone

There seems to be two ways that well constructors interpret this parameter. Some report the depth at which water is first encountered in the drill hole; while others report the depth where enough water to supply the well is encountered. From the hydrogeologist perspective, the first interpretation is preferred because it tells us where the top of the aquifer is.

It is common to find that an aquifer, i.e., a water-saturated geologic unit, varies in permeability in the vertical sense. For example, consider a 50-foot-thick sand aquifer that occurs at a depth of 30 feet and contains silt in the top 5 feet.

The entire 50 feet of aquifer is saturated; however, useful quantities of water can be produced from only the lower 45 feet. First, recognizable water would be encountered at 30 feet, while producible water would not be encountered until 35 feet.

From the hydrogeologist's view, the top of the aquifer is at 30 feet. Why is this so important? In order to determine whether the aquifer is confined or is unconfined, we must compare the elevation of the static water level to elevation of the top of the aquifer. In the case just given, the static water level in a well in this aquifer would be at 30 feet. If we had mistakenly thought that the top of the aquifer was at 35 feet, we may have considered it to be confined when actually it is unconfined.

Static Water Level

The driving force for groundwater movement is the hydraulic head, and the static water level (SWL) is a measure of that force (head = ground elevation- SWL). If we want to determine the groundwater flow direction and the gradient, we may be able to gather that information from well reports. Care must be taken in using SWLs from wells drilled at different times of the year or over a period of years. Careful SWL measurements greatly enhance our understanding of the nature of groundwater movement.

Well report forms generally provide space for SWL reporting as a function of depth in a given well. Multiple aquifers exist in most areas and these aquifers may be encountered as one drills deeper into the ground. Identifying where one aquifer ends and another begins is key to identifying the source of groundwater to individual wells.

Although this often can be determined by careful review of the lithologic log provided by the well constructor, the transition from one aquifer to the next can be indicated by a marked change in the SWL.

A change in SWL is a better indicator that a different aquifer has been encountered than the lithologic description.

A progressive change in the static water level with depth can indicate to the hydrogeologist that the area represents a recharge zone (decreasing head with depth) or a discharge zone (increasing head with depth). Identification of recharge and discharge zones may have important implications in groundwater protection and identifying the relation between area groundwater and local streams.

Water-Bearing Zones

A well report that does not indicate where within the 200 feet of open hole the water is actually coming from does not provide enough information to describe how water moves to the well. In some cases, the screened or perforated portions of cased wells provide a clue, but all too often, the screened interval is either significantly greater or less than the actual thickness of the water-bearing zone(s).

Arriving at accurate estimates of aquifer parameters or calculating groundwater velocity requires us to know the thickness of the water-bearing zone(s). On well reports, if well constructors can identify the depth(s) where groundwater is found and estimate the yield from each zone, the hydrogeologist can increase his or her understanding of the groundwater system significantly.

Lithologic Log

The well log portion of the well report describes what the driller encountered in the subsurface. Clear descriptions of the material drilled through, e.g., the relative proportions of silt/clay in the sand units, the locations of weak (fractured) zones in bedrock, whether a clay unit contains lenses or layers of sand, etc., allow the hydrogeologist to better estimate the potential permeability of these zones. This information also allows the hydrogeologist to better estimate the recharge amount, vulnerability from contaminants from the surface, degree of hydraulic connection to surface water, and so on.

Of course, it is not necessary that well constructors be trained geologists. But it is important that their observations, coupled with their experience on a rig, be recorded. Once a hydrogeologist has examined a number of well reports from a given driller, he or she can begin to attach geologic terms to the descriptions provided. Consistency in reporting lithologic character and distribution with depth is very important.

Contributions of Well Constructors to Hydrogeology

This document stresses the importance of data that is recorded on well reports and how that data influences hydrogeologic investigations. Filling in those blanks doesn't just satisfy some agency's requirements; it also provides hydrogeologists from the public and private sector valuable information regarding local groundwater systems.

Well constructors can provide important contributions to the science by making careful observations and measurements when recording that data on the well report.

Dennis O. Nelson is a registered geologist and the groundwater coordinator at the Drinking Water Program, Oregon Department of Human Services (442 A Street, Springfield, OR 97477; 541-726-2587; fax 541-726-2596; donelson@oregonvos.net).

His current work focuses on the hydrogeologic identification of the source of groundwater-based public water systems (drinking water protection areas), determining the sensitivity of aquifers to contamination, and assisting public water systems and communities in developing drinking water protection plans.

Reprinted with permission of the *Water Well Journal*. Copyright 2003 by the National Groundwater Association (www.ngwa.org). All rights reserved.

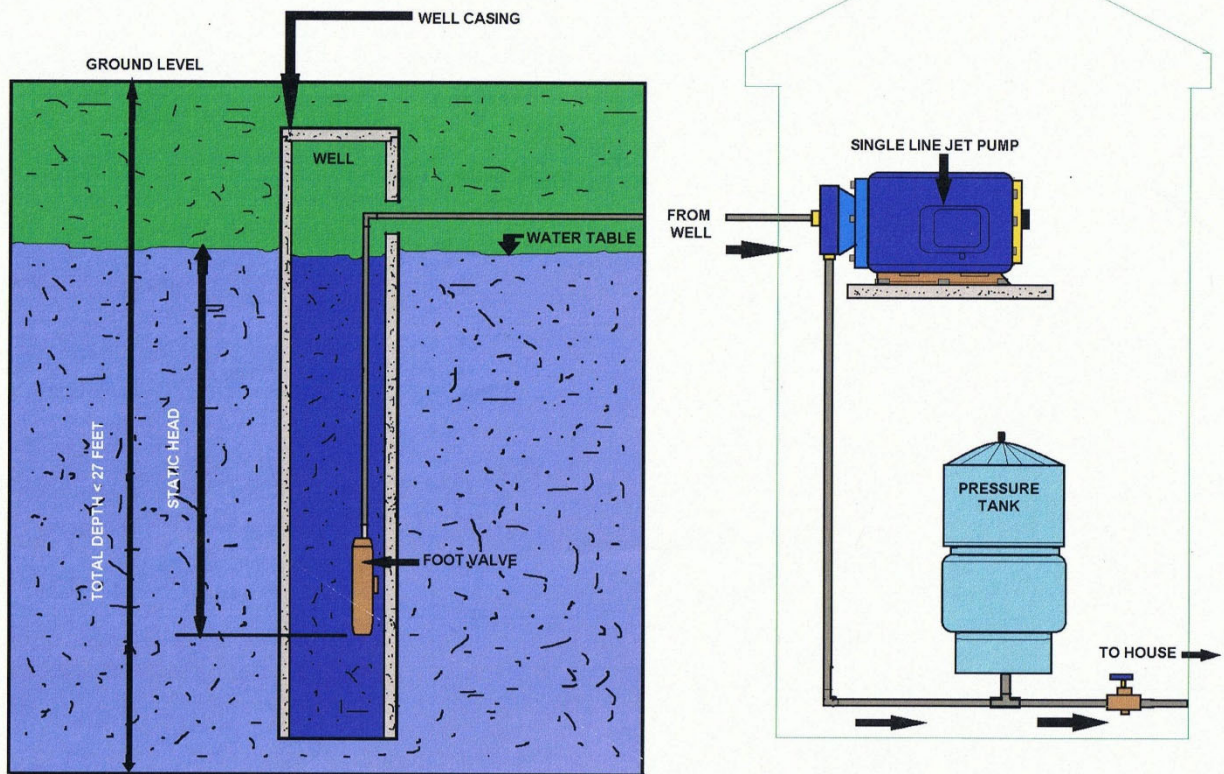

SHALLOW WELL WITH SINGLE-LINE JET PUMP
 (SUITABLE FOR SHALLOW WELLS LESS THAN 27 FEET DEEP)

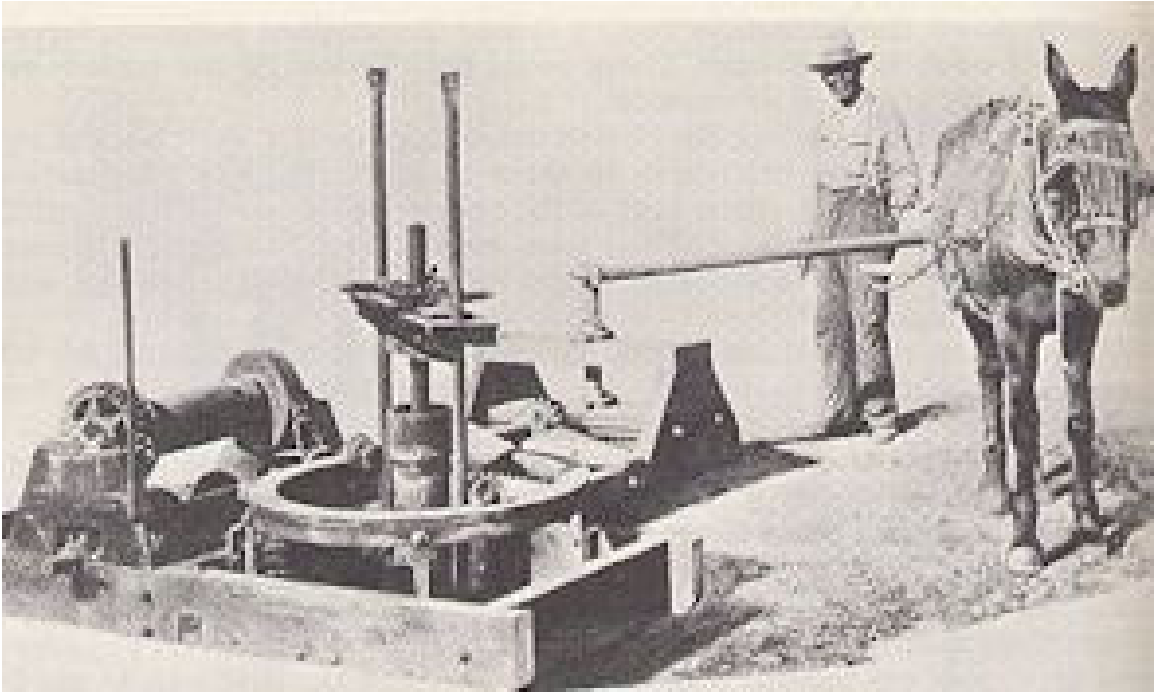

Up until 1940, mules were used as the horsepower to drill wells.

How Wells Are Drilled

Man has been digging holes into the ground to obtain water for thousands of years. Early on, these wells were dug by hand and sometimes using animals. This work could be dangerous and slow requiring many years to complete. In these modern times, wells can be drilled much faster and safer using numerous technologically advanced methods.

Some examples of today's more common well drilling methods include **rotary, auger, and cable tool** with many variations of each.

Drilling fluids are often used during drilling in order to keep the borehole open while drilling is done.

Drilling fluids **stabilize** the hole and aid in the removal of **cuttings**. Typical drilling fluids may be **water, mud, air, chemical or natural additives, or combinations of each**.

Although each drilling technique may be utilized in different types of geology, each one is better suited for particular types of material. For example, **air rotary with downhole hammer** is particularly suited for **hard rock** drilling, while **mud rotary** is better suited for drilling in **sediment**.

No matter what type of rig or method is being used, a highly trained and skilled **driller** is required to operate it successfully.



Drill String



Top Drive



Drill Pipe

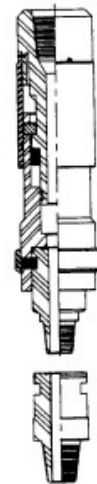

Floating Sub Assembly

Basic Rotary Drilling Methods

Rotary drilling utilizes a **drilling rig** with a rotating bit and circulating drilling fluid to penetrate into the aquifer. It is the most common type of drilling method used today. Common variations of this method include: **direct and reverse mud rotary, direct air rotary, and drill through casing driver methods**.

The Rotary Drill String

Rotary drilling methods use a **drill string**, which typically consists of a bit, collar, drill pipe and a kelly (if table driven). A **kelly** is a section of heavy walled pipe that can be hexagonal, square, or rounded with grooves. The kelly is several feet longer than the drill pipe being used and fits into the table drive much like the splines on an automobile's drive shaft fit into a transmission.

The **table drive** turns the kelly and the rest of the drill string connected below as it slips down through the table. Some rotary rigs use a **top drive** to turn the drill string and are like a drill press, but larger. A top drive is free to move up and down the **mast** of the rig while rotating the drill string.

Drill pipe makes up a majority of the overall length of a drill string and is used in various diameters and wall thicknesses for added strength. Drill pipe can be used in various lengths but are typically 20-foot sections and may be connected to the **drive unit** with a **sub**.

A sub is a length of pipe used to connect pipes and/or act as shock absorber (**floating sub**) between the drill pipes and drive unit. At the end of the drill pipe is the drill collar.

The **drill collar or stabilizer** is typically very heavy and is often **gauged** close to the diameter of the bit being used. There are many types of drill collars that are often custom made by the driller by adding metal ribs to heavy drill pipe. The drill collar aids in maintaining a consistent borehole diameter and primarily helps to prevent **borehole deviation**.

At the end of the collar is the rotary **bit**. Several types of bits may be used; such as drag bits or roller bits.

Drag bits are typically used in unconsolidated to semi-consolidated sand, silt, and clay-rich formations.

Drag bits come in many shapes and sizes and cut with a shearing action aided by the jetting of drilling fluids from nozzles or jets in the bit. Roller bits, such as the common **tri-cone bit**, typically utilize interlocking teeth or buttons on individual rotating cones to cut, crush, or chip through the formation.

Roller bits are also aided by the jetting of drilling fluids from nozzles or jets in the bit. These bits can be used in consolidated formations and even hard rock applications if equipped with **carbide buttons**. These types of bits are often referred to as **roller button bits**.

Often an initial borehole needs to be **reamed** or made larger. **Reamers** are bits that can be used to enlarge, straighten, or clean an existing borehole. Occasionally, **under reamers** are used to enlarge deeper sections of an existing borehole without requiring the enlargement of the entire upper well bore.

Under reaming involves the projection of cutting blades beneath permanently installed casing in loosely consolidated sediments. This can allow for the cost effective installation of well screen and gravel pack within deeper loosely consolidated aquifers.



RIBBED STRAIGHT STABILIZER



RIBBED SPIRALED STABILIZER



OVER THE HAMMER STABILIZER

Table Drive (Notice notches for Kelly)



Tricone Roller Bits

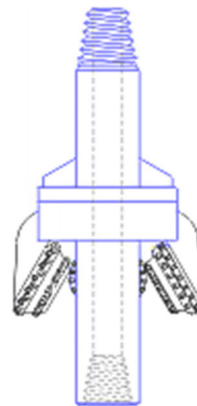

Roller Reamer



Drag Bit

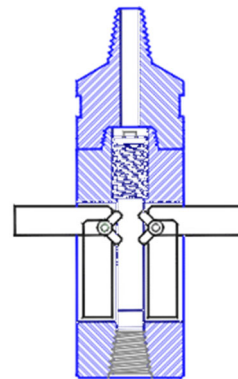

Drag Type Under-reamer

Direct Rotary Method

Direct rotary drilling methods utilize a rotating bit at the end of a **drilling string** with **drilling fluid** that is **circulated** from the rig through the drill pipe and jets in the bit. Down-force exerted by the drilling rig and/or the weight of the drill string itself is used along with rotating action to force the bit downwards, cutting through the sediment or rock. The drilling fluid that is pumped by the rig's **mud pump** and/or **air compressor** is jetted out of ports in the bit.

These ports are called **jets**. The drilling fluid carries **cuttings** up the **annular space** between the drill pipe and **formation** and into **mud pits** or **containment recirculating systems** on the surface.

The drilling fluid pressurizes the **borehole** and helps to keep the hole open while removing cuttings. If this pressure is lost due to **washouts**, **voids**, **caverns**, or any number of other causes, circulation will not be maintained and drilling will likely have to be stopped.

Large drill rigs may utilize the cutting's containment systems that separate the cuttings from the drilling fluid before a pickup pump recirculates the drilling fluid back down the borehole, where the process is then repeated.

Also, one or more temporary mud pits may be dug into the ground adjacent to the rig in order to contain and settle out cuttings from the drilling fluid before recirculating.

Direct Mud Rotary Method

Direct Mud rotary drilling rigs use various types of mud or drilling fluid to drill into the ground. Mud is circulated down the drill string and through the bit at the bottom of the borehole. The mud then carries the cuttings generated by the bit up to the surface and into the mud **recirculating system**.

Soil or formation samples may be collected from the recirculating system as drilling proceeds. A vibrating screen or set of screens called a **shaker** may be used in part of the recirculating system on larger rigs. It separates out cuttings from drilling fluid and provides an ideal **sampling location**.

The mud not only removes cuttings but also adheres to and pushes against the borehole walls, minimizes fluid loss, and cools the bit.

The process of building up a film of mud on the borehole walls is important to mud rotary drilling and is called **mud caking**. Sometimes specially trained personnel are needed to manage the physical properties of the mud to ensure that a proper **mud cake** thickness is maintained and that a proper density or weight of mud is used to efficiently drill the well.

The **mud engineer** will often use bentonite clay and water to make the mud drilling fluid. Sometimes chemical additives such as drilling polymers or gels may be used.

Mud engineers play an important role in ensuring that a mud rotary drilled well can be drilled to the proper depths successfully and ultimately developed for use. Sometimes the loss of mud drilling fluids to cavities in the earth cannot be stopped with a mud cake alone, however. In these instances, **casing** or **grout** may be installed to permit drilling beyond such zones.



Mud Pump



Well Drilling Components and Products



Typical Rotary Rig



Small Self-Contained Mud System



Constructed Mud Pits

Reverse Mud Rotary Method

Reverse mud rotary drilling rigs utilize the same process as direct mud rotary with the exception that the mud drilling fluid injection process is reversed. Reverse rotary methods pump the drilling fluid down the borehole to the bit where the cuttings are forced up the drill string and into the containment or recirculating system.

The reverse method is utilized in situations where borehole stability problems are particularly difficult and would otherwise prevent conventional drilling of the well to the total **target depth**.

This method is particularly applicable to hard rock aquifers in zones where highly fractured or **weathered** rock may prevent the efficient flow of drilling fluids up the borehole walls to the surface. Also, fluid losses may be minimized with this method.

Samples are collected in the same way as mud rotary.

Air Rotary Method

Air rotary methods utilize compressed air and derived drill cuttings and groundwater as the drilling fluid. Air is forced through the drill string and out the bit where it then mixes with and lifts cuttings and any derived groundwater to the surface.

Once at the surface, the cuttings and groundwater are typically contained in subsurface pits, much like the mud rotary method.

Soil or formation samples may be collected in a bucket or shovel placed beneath the **table** of the rig as drilling proceeds, resulting in representative samples. The borehole is kept in a pressured condition while drilling, in order to maintain the circulation of drilling fluid to the surface.

Biodegradable foam or **surfactant** (soap) is often added while drilling with air in order to maintain sufficient hole pressurization so that cuttings may be lifted to the surface efficiently while maintaining hole stability.

As in drilling with mud, if this pressure is lost due to washouts, voids, caverns, or any number of causes, circulation cannot be maintained and drilling may not continue.

The air rotary method is particularly suitable to hard rock drilling with a **down hole air hammer**. The air hammer utilizes compressed air to drive a piston up and down which makes the **hammer bit** move up and down while the drill string rotates.

The combined rotating and hammering action generates great rock breaking force and is very valuable for drilling through solid rock or consolidated formations. Conventional air rotary drilling methods utilize roller bits in the same way as those used for mud rotary drilling.

In hard rock or consolidated formations, a roller **button bit** may be used when **drilling pressures** are too high or borehole sizes are too large for the efficient operation of an air hammer.



Air Rotary Containment Pit
(Notice Foam and Water Truck)



Hammer & Bit



First Pit (heavy with cuttings)



Last Pit (small amount of fines)

Several containment pits installed in series can help cuttings to settle out.

Drill through Casing Driver Method

The drill through casing driver method drives casing into the borehole as the drill string advances. A **casing driver** is a pneumatic device designed to push or pull casing that is typically attached to a top head drive air rotary rig. Heavy gauge steel casing is used with a **cutting shoe** installed on the down hole side.

The cutting shoe is a specially designed hardened steel ring that is installed on the casing end. It helps the casing cut its way through the formation as it is forced downward by the casing driver. The drill string is inserted into the casing and the casing is attached to the casing driver. As the drill string penetrates into the **overburden** or formation, the casing driver hammers the casing down, following the drill string.

The drill string may employ a hammer or roller bit. The driller pays close attention to the distance between the cutting shoe and the bit and adjusts as is necessary. Cuttings rise to the surface with the injected air through the casing and exit through the casing driver.

The cuttings are then collected near the rig. As the borehole is drilled, the casing advances and isolates the material being drilled from the remaining borehole. As a result, very accurate soil or cuttings samples may be collected as drilling proceeds with this method.

The addition of casing and drill string can continue until **competent** formation is encountered. Once the well has been drilled to competent formation, conventional drilling methods may be utilized to continue. The casing driver method is often used to install temporary casing in order to permit the installation of a well in unstable aquifers.

In this instance, the casing driver may be used as a puller to remove the temporary casing following well construction. This method is most useful when accurate formation or soil samples are needed and when drilling in troublesome unconsolidated overburden or formations with numerous cobbles or boulders.

Cutting Shoe



The Cutting Shoe is welded to the bottom of casing before installation.



A Casing Driver attached to a top drive air rig.



Auger Boring Methods

Auger boring methods make use of a rotating blade or **spiral flange**, which may be attached to a **pilot bit** and **cutter head**. Down-force applied by the rig along with the rotating action of the blade and cutting action of the pilot and/or cutter bits facilitates the boring process.

Soil samples may be collected as cuttings rise or are brought to the surface, or they may be collected with **split spoon** type samplers.

Augers are capable of boring large diameter holes in excess of four feet in diameter. They are typically used in shallow applications (less than 200 feet) and where stable silt and clay soils or soft materials are dominant.

These boring methods are commonly used to construct large diameter boreholes for the construction of **surface seals** around wells through thin and stable overburden sediments which overlie the aquifer below.

One of the methods is commonly used in environmental applications for the collection of soil samples. There are three primary types of auger boring methods: **solid stem, bucket, and hollow stem**.

Solid Stem Auger Method

The solid stem auger boring method uses a spiral flanged drill pipe driven by either a kelly or rotary drive head, like those used on rotary rigs. The drill pipe may be continuously flanged or just the initial section is flanged. Flanged sections of drill pipe are referred to as **flighting**. The lower portion of flighting, having the cutter bit attached, makes the initial cuts into the formation, providing the path for the remaining flighting to follow.

Larger diameter augers typically employ a single flight and can be used in stable formations to depths of approximately 60 feet. Deeper borings are typically installed with continuous flighting and only in stable formations.

Occasionally, the lower flight is removed from the borehole so that cuttings, which accumulate at the bottom of the borehole, may be removed and/or sampled. When boring with continuous flighting, cuttings are brought to the surface by the spiral action of the flighting. Samples may be collected from these cuttings or the flighting may be brought to the surface and samples collected from the **cutting head**. This method is not suited for applications below the water table and may provide limited soil sample data. However, it may be used to aid in quickly constructing the larger diameter upper sections for larger wells.

**Auger Flighting:
Cutting Head**

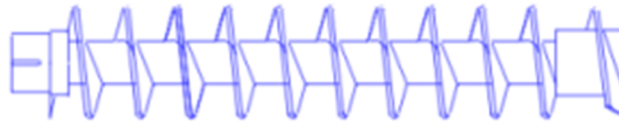

Bucket Auger Method

The bucket auger method essentially combines the rotary and auger techniques. The bucket auger method employs a single, typically large in diameter, bucket auger to drill or bore into the ground. The **bucket auger** is a cylinder constructed with auger like blades at its bottom edge. These blades may be armored with various forms of cutting teeth or blades to provide strength and “**bite**”. The bucket auger is rotated via a kelly and table drive much like those of rotary rigs. However, bucket auger rigs utilize a **telescoping kelly**.

A telescoping kelly consists of two or more sections of square piping that telescope into each other. This type of kelly allows the rig to drill to depths of 40 feet or more without requiring the addition and removal of drill pipe.

When the bucket is filled with cuttings it is closed and brought to the surface where it is swung out to the side of the rig by a specially designed **swing arm or dumping arm**. At this point the bucket is opened and cuttings are dumped. Soil samples may then be collected and can be considered representative of the section bored.

Bucket auger methods typically cannot be used in material containing cobbles and boulders, but is used most often in more stable **semi consolidated** silty or clay rich deposits. Large diameter wells up to 4 feet in diameter may be constructed with the bucket auger method, with smaller diameters approaching 200 feet in depth.

Occasionally, drilling fluids such as **bentonite mud** may be used in order to maintain borehole stability when drilling in questionable materials.

Common Well Construction Specifications

Water wells should always be located and constructed in such a manner that they **yield** safe water at all times and under all conditions. Contamination of a water supply typically occurs when leachate from sewage systems or surface waters enter a well. Surface water may enter the well through an opening in the top or by seeping through the shallow borehole walls.

Tests have shown that bacterial contamination is usually eliminated after filtering through 10 feet of normal soil. Therefore, construction of the well must ensure that the top and uppermost 20 feet of the well bore are sealed and watertight. This is the primary reason why surface casing and surface seals are so important.

All wells must be constructed with a **surface seal** to prevent the infiltration of surface water and/or surface contaminants into the well bore and aquifer. This seal is installed in the upper portions of the well bore between the **annulus** and **surface casing** and will normally extend to the ground surface around the well.

The seal is constructed by pouring or pumping neat **cement grout** and/or **bentonite** between the surface casing and the well bore. The installation of the cement or grout between the annulus and surface casing effectively seals off the upper borehole from the surface.

The surface casing used is a solid piece of permanently installed casing, usually steel, that should be of sufficient size to allow the **completion** of the well within it. In addition to the surface seal, a **well seal** or **cap** is always installed with the pumping equipment to ensure no surface water or debris enters the well.

When the well is drilled into the aquifer, the depths of water (**productive intervals**) and **estimated well yield** are normally **logged** by the **driller** or **geologist**. Sometimes the aquifer's productive intervals may not be known, due to drilling method limitations or a lack of regional **hydrogeological** data.

In these instances, specialized **borehole geophysical logging equipment** may be used to isolate the areas of optimum production capability and aid in determining the ultimate well design.

In addition, preliminary **pumping tests** are normally conducted to ensure the well is as productive as originally estimated and to obtain preliminary **aquifer parameters**.

Following the installation of the well's surface seal, the well is then reamed (if necessary) to accept additional **blank casing, well screen, and filter or gravel pack**. Once the well has been reamed large enough in diameter for the anticipated flow rate, the appropriate casing can be installed.

The well casing ensures that the borehole remains open and that debris from the formation(s) does not enter the well, thereby protecting the pump equipment and the well itself. Blank casing is normally installed to the depth of the main **producing zone**.

At this point, **well screen** is used and may extend to the total depth of the well or may be used intermittently to total depth with blank casing used through unstable or non-productive areas.

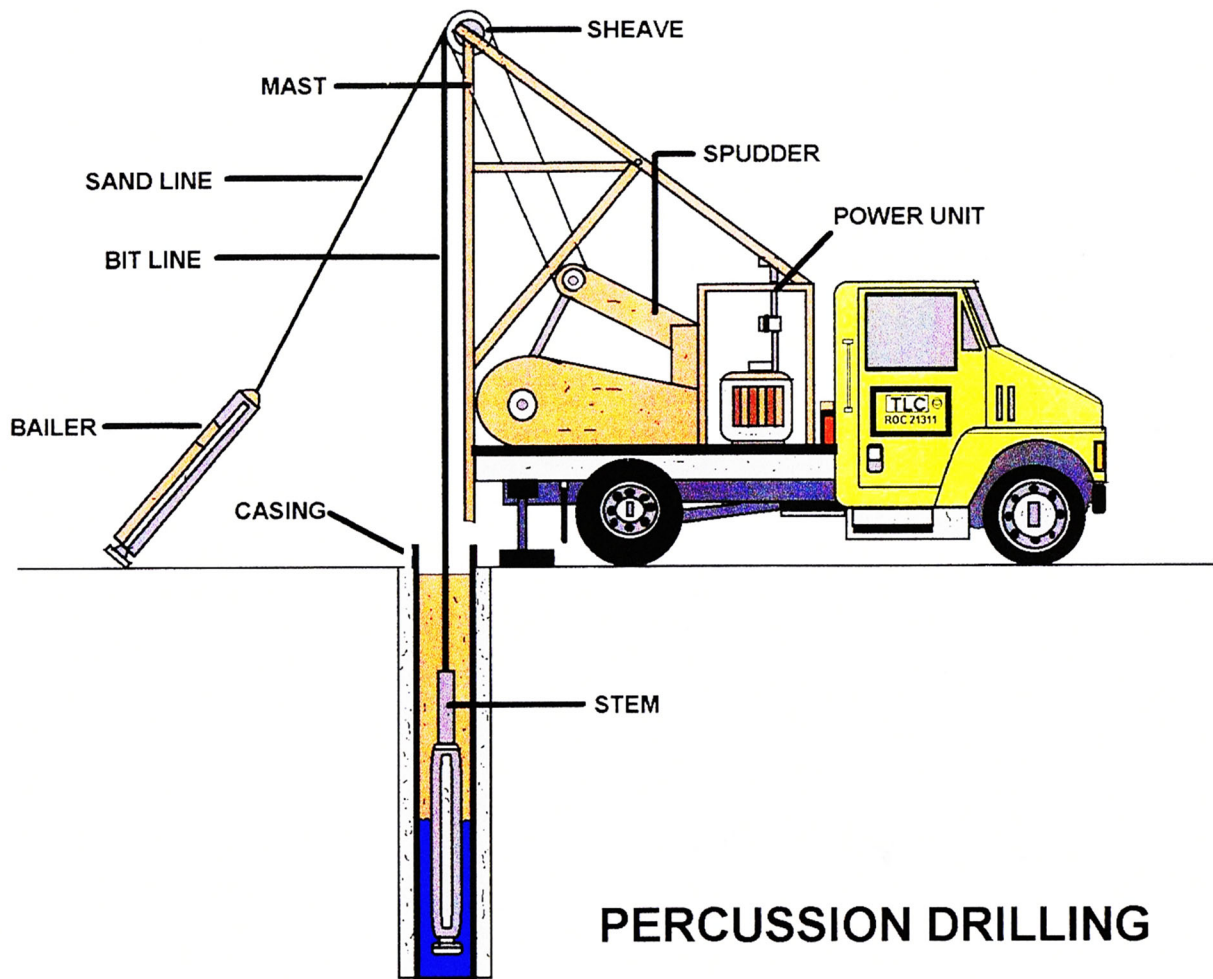

PERCUSSION DRILLING

Percussion drilling is a commonly found groundwater production drilling technique in which a drill bit attached to rope or cable is repeatedly raised and lowered, impacting soil and rock and making the hole deeper. Frequently used to drill wells or during mineral prospecting activities, percussion drilling has been used for thousands of years and is adaptable to whatever technology is available.

Percussion drills may be simple apparatuses consisting of a heavy drill bit and a rope, and operated by hand. Modern percussion drilling may also be called cable drilling and uses an engine and cable to drill holes that may be hundreds of feet deep.

One use of percussion drilling is in third-world countries as a cheap and reliable way to drill water wells. Equipment is easy to build, transport, and simple to use. Percussion drills introduce less contamination than conventional hand drilling methods. This technique can drill a narrower and deeper hole than hand drilling through many different types of soil and rock.

If the substance being drilled through is sturdy enough, drilling can continue until water is reached. If drilling occurs in loose soil or sand, a pipe may need to be inserted to keep walls from collapsing. After the well is deep enough, permanent casing is installed, too.

Choice of Casing

The choice of casing is as important as its placement. There are numerous types of casing designed for specific applications. The type of well casing needed is related to the type of aquifer, well depth, water quality, well use, and regulatory requirements. *Stainless steel* casing and screen may be required for one situation, while *PVC* or *low carbon steel* may be acceptable in another. As such, *please check with your regulating agency and well driller to ensure the installation of the appropriate type of casing for your application.*

As with casing, the choice of well screen is as important as its placement. The size of the openings in the casing (*screen slot or perforated opening size*) are dependent on the *grain size* of the filter or gravel pack used. The same applies to applications where a well is *naturally developed* or *naturally packed* (no filter pack is used). As a rule, coarse grained sediment or fractured hard rock aquifers may be naturally developed, while fine-grained sediment aquifers typically require a filter pack. The selection of screen slot size is normally made based on samples collected from the aquifer during drilling and consideration of the filter or gravel pack grain-size. A *sieve analyses* is often conducted in order to select the optimum size of slot for the application. During a sieve analyses for well screen, determination samples are screened through various sizes of sieves. The *sieve size that retains 40% of total aquifer sample is normally used to select the well screen and associated filter pack material.*

The sieve analyses results will indicate in decimal inches what size slot may be used.

For Example: A sieve analyses indicates that a 40% share of a sample from an aquifer is retained in a .050 sieve. This suggests that the well screen slot size should be .050 inches wide and that a filter pack of .050 or larger may be used within that portion of the aquifer.

However, unless the entire aquifer is uniform in composition, it is always possible that the ideal slot size for one interval may not be ideal in another. This is why the collection of samples during drilling is so important. It is not unusual to have a single well-constructed with several different slot sizes over variable intervals.

It is still possible though to identify a single slot size that may be effective throughout the screened interval by varying the filter pack size and adjusting the slot size to the smallest observed 40% retention sieve analyses result. Not only are there numerous types of casing and slot sizes, but there are also many different types of well screen. A few of the more common types of well screen are: *wire wrapped, continuous screen, slotted, louvered, and perforated screens.*



All except wire wrapped are available in various types of metal or PVC composition. Again, the appropriate selection depends on local regulations, use, type of aquifer, depth, water quality, location and possibly much more. Therefore, *please refer to your driller and regulatory agency for the proper selection or recommended well screen.* As a rule, wire wrapped screen or continuous screen is normally used in municipal applications where a *high yield* is obtained from *unconsolidated to semi-consolidated* formations.

Slotted and perforated screens are stronger and less expensive than wire wrapped screens and are best suited to deep applications, where borehole stability is a concern, and in domestic applications. Louvered screen is used in high yield production wells but particularly in filter packed wells and may help where *cascading water* is a problem.

Louvers

The louvers deflect groundwater above *pumping levels* back into the annulus or filter pack so that *air entrainment* and corrosion within the well are minimized. Air entrainment occurs when cascading water drops into the pumping water level creating turbulence and making bubbles. These bubbles may get drawn into a *vortex* created by the pump and then included in the water pumped from the well.

Once the casing and screen specifications are determined, they may be installed into the well. Due to weight, casing is often installed with a drill rig. If a well is *telescoped*, the driller will install the largest diameter portions first.

Gravel or filter packs can then be installed. A bentonite or *cement plug* is often installed in the bottom of the borehole before the filter pack is installed, effectively sealing the bottom of the casing and borehole. If certain intervals of the well need to be isolated from others, *inflatable packers* and bentonite or cement grout may be used. The inflatable packer is used to seal off a portion of the annulus to prevent the mixing of the seal material and the filter pack.

These types of seals are commonly used for wells constructed within confined aquifers so that they may be isolated to prevent cross connection with other aquifers or formations. Well *centralizers* are normally installed on the screen and casing before installation. The centralizers are a type of banding or metal offset that, when installed, ensures the casing and screen do not rest up against the borehole walls.

The centralizers will minimize the potential of *bridging* during the installation of filter media and grout. When complete, the well casing is *capped* and normally must terminate at least 12 inches above ground level. Once the well construction is completed it may be developed.



Wire wrapped screen being installed in a well.

Specialized Well Construction Information

(Please check with your regulating agency and well driller to ensure your well is properly constructed)

Fractured Formations

Wells obtaining water from fractured formations such as limestone or granite are susceptible to contamination. Contaminated water can move rapidly through these types of formations. Therefore, proper well location and construction are very important when drilling wells in these types of formations. When the **overburden** overlying the upper bedrock formation is less than 30 feet thick, the well casing should extend to a depth of at least 40 feet below ground level.

The annular space between the well bore and the casing should also be pressure grouted. Where the well is drilled to obtain water from a formation located below a fractured formation, the casing should extend at least through the fractured formation and be seated in firm rock or clay. Where the overburden overlying the upper bedrock formation is greater than 30 feet thick, the casing should be fitted with a drive shoe and driven to a firm seat in the bedrock. The annular space around the casing can then be sealed with Bentonite grout or neat cement grout.

Auger Drilled Wells

As opposed to smaller diameter drilled wells, auger wells are generally constructed at locations where aquifers (water bearing geologic formations) are both shallow and low yielding. An aquifer that yields only 1 gallon per minute will provide 1,440 gallons per day. Auger wells range in depth from 30 to 100 feet.

To compensate for low-yielding aquifers, large diameter auger wells serve as storage reservoirs to provide water during periods of high demand. An auger well with a diameter of 3 feet, a total depth of 50 feet and a water depth of 30 feet, contains approximately 1,600 gallons of water.

There are two recommended methods for the construction of auger wells.

1) Auger (bored) Well with Buried Slab Construction

Auger wells are usually constructed utilizing the buried slab method. With this method, the upper well casing shall extend to a depth of 10 feet or more below ground surface and be firmly imbedded in a uniformly tapered hole that is formed when the reinforced concrete buried slab is manufactured, or shall be connected to a pipe cast in the concrete slab.

The upper well casing should be at least 4 inches in diameter and extend from the concrete slab to at least 8 inches above the finished ground surface.

A bentonite seal that is a minimum of 12 inches in thickness shall be installed over the buried slab the entire diameter of the borehole. The earth fill on top of the buried slab and around the upper well casing should be well compacted and mounded to drain away from the well.

Sand or gravel cannot be used as fill on top of the buried slab. The lower concrete casing is normally constructed using pre-cast concrete sections ranging in diameter from 2 to 3 feet.

The diameter of the well bore hole below the buried slab must be at least 4 inches greater than the outer diameter of the well casing, and the annular space (opening between concrete casing and well bore) must be filled with pea gravel to the well bottom.

The discharge pipe exits the well below grade through an approved *pitless* well adapter. A pitless well adapter is a mechanical device attached to the well casing pipe, usually below frost level, that permits water to pass through the wall of the casing and provides protection to the well and water from contamination. An approved vented well cap or seal should be properly installed on top of the well casing. As an alternative, the discharge pipe can exit at the top of the well casing through an approved well seal. If the pump is located away from the well, the buried pipe leading to the pump from the well must be encased in a pressure discharge line at system pressure.

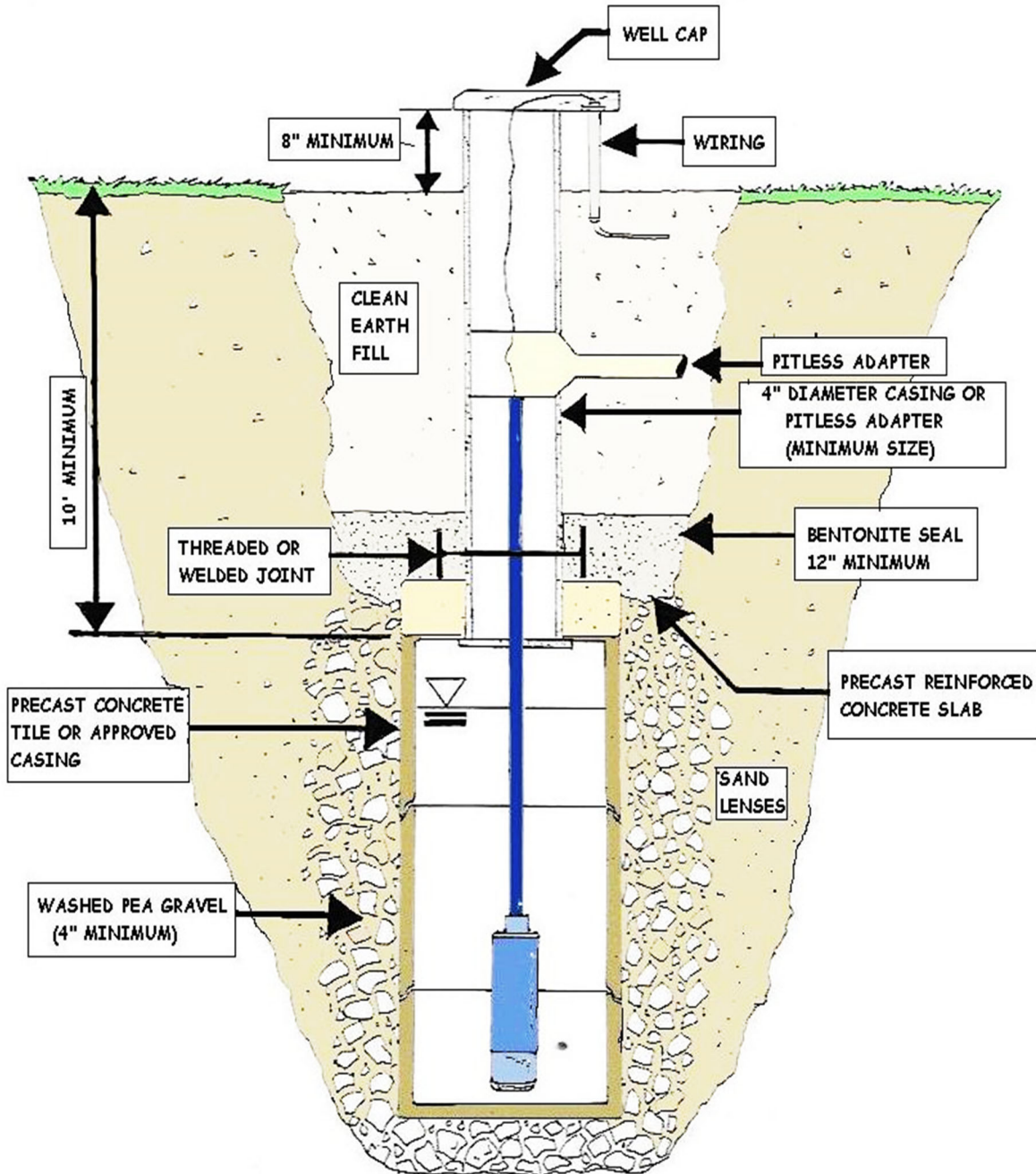

(EXAMPLE ONLY – CHECK STATE OR LOCAL REQUIRMENTS)

Auger (bored) Well with Concrete Collar

For auger wells not finished with a buried slab, the concrete casing also ranges in diameter from 2 to 3 feet. The annular space between the excavation and the installed casing should be grouted with concrete that is at least 6 inches thick and poured without construction joints from a minimum of 10-20 feet below ground level to the ground surface. The diameter of the well bore hole below the grouting must be at least 4 inches greater than the outside diameter of the well casing and the annular space should be filled with pea gravel to the well bottom.

The casing should extend at least 8-12 inches above the finished ground surface. The cover slab must be at least 4 inches thick, without joints, adequately reinforced and with a diameter sufficient to extend to the outer edge of the casing.

Adequate sized pipe sleeve(s) should be cast in place in the slab to accommodate the type of pump or pump piping proposed for the well.

A watertight joint must be made where the slab rests on the well casing. If a manhole is installed, it should consist of a curb cast in the slab and extend 4 inches above the slab. A watertight cover must be provided over the manhole and should overhang the curb at least 2 inches. The discharge pipe must exit the well in a watertight manner at the top of the well casing through an approved well seal.

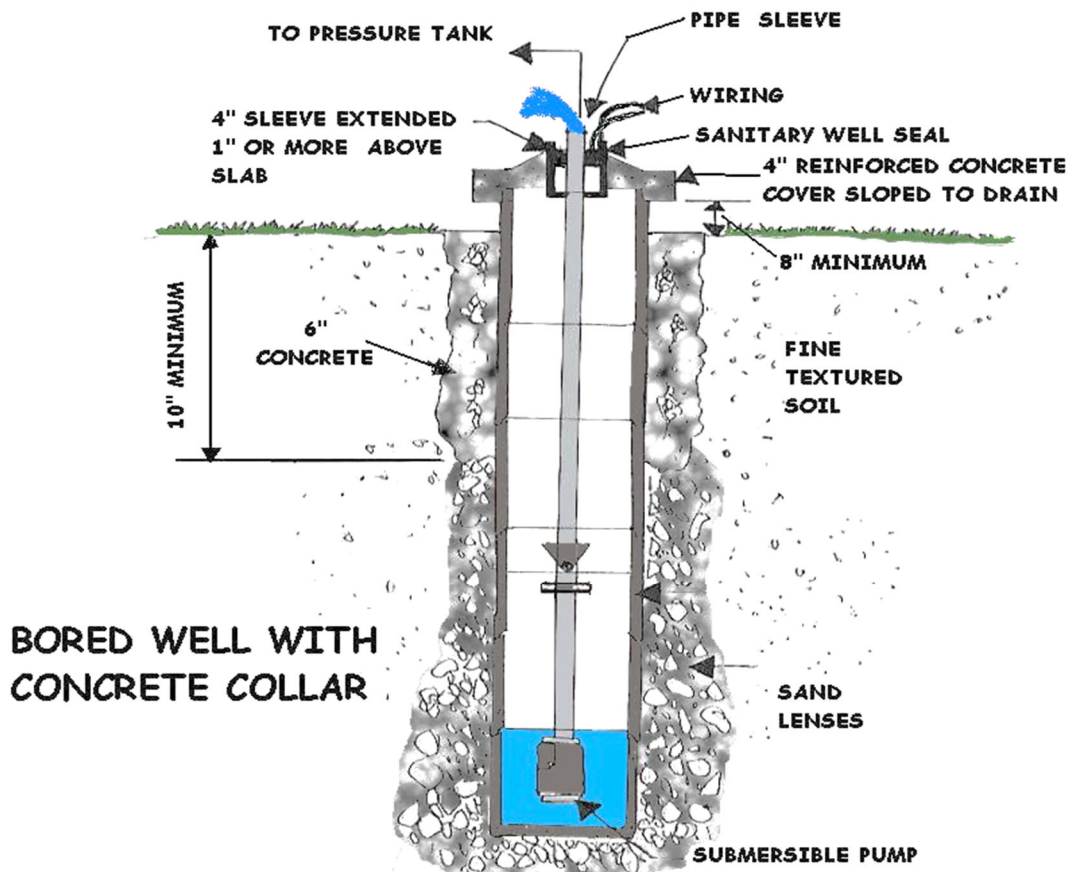

Why is EPA taking a risk-based approach to protect drinking water provided by groundwater systems?

An evaluation of data on outbreaks and the occurrence of waterborne viral and bacterial pathogens and indicators of fecal contamination in groundwater supplying public water system (PWS) wells indicate that there is a subset of groundwater systems (GWS) that are susceptible to fecal contamination. Therefore, in 1996, Congress amended the Safe Drinking Water Act (SDWA) to require that EPA take a targeted risk-based approach to require GWSs that are identified as being at the greatest risk of contamination to take action to protect public health. Previously, the 1986 Amendments to the SDWA had included a provision that would have required all PWSs using groundwater to disinfect. This would have posed a great implementation challenge for approximately 147,000 GWSs and states.

What types of pathogens can be found in water provided by groundwater systems?

Groundwater that is susceptible to fecal contamination may contain harmful viruses or bacteria. Viral pathogens found in GWSs may include enteric viruses such as Echovirus, Hepatitis A and E, Rotavirus and Noroviruses (i.e., Norwalk-like viruses) and enteric bacterial pathogens such as Escherichia coli (including E. coli O157:H7), Salmonella species, Shigella species, and Vibrio cholerae. Ingestion of these pathogens can cause gastroenteritis or, in certain rare cases, serious illnesses such as meningitis, hepatitis, or myocarditis. Health implications in sensitive subpopulations may be severe (e.g., hemolytic uremic syndrome) and may cause death.

What causes contamination of groundwater?

Viral and bacterial pathogens are present in human and animal feces, which can, in turn, contaminate drinking water. Fecal contamination can reach groundwater sources, including drinking water wells, from failed septic systems, leaking sewer lines, and by passing through the soil and large cracks in the ground. Fecal contamination from the surface may also get into a drinking water well along its casing or through cracks if the well is not properly constructed, protected, or maintained.

Does this rule address private wells? If not, how does EPA help protect them?

This rule does not address private wells because they are not under the jurisdiction of the Safe Drinking Water Act and are therefore not subject to EPA regulation. EPA has provided outreach material to states and homeowners to help them understand how to manage individual wells. EPA recommends that well owners periodically test their water for microbial and chemical contaminants and properly maintain their well. Information is available on EPA's Private Wells Web site.

What are the basic requirements of the rule?

The risk-targeting strategy incorporated into the rule provides for: regular sanitary surveys of public water systems to look for significant deficiencies in key operational areas; triggered source water monitoring when a system that does not sufficiently disinfect drinking water identifies a positive sample during its Total Coliform Rule monitoring and assessment monitoring (at the option of the state) targeted at high-risk systems; implementation of corrective actions by groundwater systems with a significant deficiency or evidence of source water fecal contamination to reduce the risk of contamination; and compliance monitoring for systems that are sufficiently disinfecting drinking water to ensure that the treatment is effective at removing pathogens.



Well Development Section

Once well construction is complete, the well is *developed*. The purpose of well development is to *purge* the well and bore of all drilling mud and or fluid, fine grained sediment, and loose aquifer matter.

The well development process also helps to settle the gravel or filter pack and/or rearrange particles within the well and nearby aquifer to allow for the most efficient operation of the well. Not surprisingly, the drilling procedure often damages the aquifer around the well.

Well development can significantly improve a well's performance by essentially repairing as much of this damage as possible by improving the transition from the aquifer to the well. The screened and productive portions of the well can be subjected to various development techniques.

All methods of well development essentially involve the flushing of water back and forth between the well and aquifer.

If you think of the aquifer as one great big *natural media filter*, the development process to a well is much the same as the backwashing process for a water treatment system. So what about hard rock wells?

Wells constructed in hard rock aquifers are not composed of unconsolidated sediments. Still, they can and should be developed because fine cuttings, drilling mud, and clay within the *fractures* and *pore spaces* near the well can obstruct flow from otherwise productive zones.

Well development procedures can remove such sediments from hard rock wells also. Several common methods of well development include, surge-block, jetting, airlift, and pump surging.

Well Surging or Backwashing

Pump surging (sometimes called **Rawhiding**) involves the repeated pumping and resting of the well for well development purposes. A column of water that is withdrawn through a pump is allowed to surge back into the well by turning the pump on and off repeatedly. However, sufficient time for the pump motor to stop reverse rotation must be allowed, such that pump damage can be avoided. Occasionally, water is pumped to waste until it is clear of sediment before again shutting the pump off. This is done to permanently remove the sediments that are being developed by the backwashing action. The process continues until sufficient quantities of water produced are consistently clean.

Surge-blocks, swabs, or plungers are disc shaped devices made to fit tightly within the well. Their edges are usually fitted with rubber or leather rings to make a tight seal against the well casing. Pipe sections are then attached to the surge-block to lower it into the well, above the well screen, and about 15 feet below the water level. The assembly is then repeatedly lifted up and down. The up and down action of the surge-block creates suction, and compression strokes that force water in and out of the well through the screened interval, gravel pack, and aquifer. It works like a plunger in the way that it removes small obstructions and sediments from the well. The surge-block is slowly lowered each time resistance begins to decrease.

Once the top of the screen is reached, the assembly may be removed and accumulated sediment either bailed or airlifted out of the well. Surging within known problem areas of the screened interval may be conducted also. The cycle of swabbing and removing sediment should be continued until resistance to the action of the swab or block is significantly lower than at the start of development. The development is complete when the amount of sediment removed is both significantly and consistently less than when surging began.

Airlifting (or **Air surging**) involves the introduction of large short blasts of air within the well that lifts the column of water to the surface and then drop it back down again. Continuous airlifting or **air pumping** from the bottom of the well is then used occasionally to lift sediments out of the well. Airlift development is most often used following initial pump surging, and is employed to confirm that the well is productive, since the injection of air into a plugged well may result in casing or screen failure.

Air lifting development is most often done with a rotary drilling rig through the drill string. Sometimes special air diffusers or jets are used to direct the bursts of air into preferred directions (see jetting). Piping is inserted into the well and intermittent blasts of air are introduced as the piping is slowly lowered into the well. Sometimes surfactant or drill foam is added to aid in the efficiency of sediment removal and cleaning of the well. Air surging development is much the same as drilling the well with air rotary; only the well has already been constructed. Specialized air development units are available independent of a drilling rig, which may be used as well. The great thing about air rotary drilled wells is that they are essentially developed while drilling, particularly in hard rock formations, when greater than 100 gallons per minute is being lifted to the surface. The development of a filter pack (if used) in such wells is still recommended.

Jetting is a type of well development technique in which water and/or air is *jetted* or sprayed horizontally into the well screen. This method is especially suited for application in *stratified* and *unconsolidated* formations. The water or air is forced through *nozzles* in a specially designed *jetting tool* (or simply drilled pipe and fittings) at high velocities.

Normally, air lifting or pumping is used in conjunction with jetting methods in order to minimize potential damage to the well bore. Jetting with water alone can be so powerful that the sediment, which is supposed to be removed, can be forced into the formation causing clogging problems.

This is why pumping or airlifting while jetting with water is so important. Jetting is normally conducted from the bottom of the well screen upwards.

Rotary Rig

A rotary rig is often used to provide the fluid or air with sustained pressure while the tool is slowly raised up through the screen. As jetting proceeds, sediment is occasionally removed from the bottom of the well bore thru the use of a bailer or airlifting. Several passes should be made over the length of screen until sediment generation drops off.

Air is normally used for jetting in shallow aquifers (less than 300 feet of submergence) due to limited supply pressures. Jetting in PVC constructed wells is not recommended since the high velocities of fluid and sediment can erode and possibly cut through the plastic well screen.

In addition, wells constructed with louvered or slotted screen limit the effectiveness of jetting. In these types of wells, surging may be more effective.

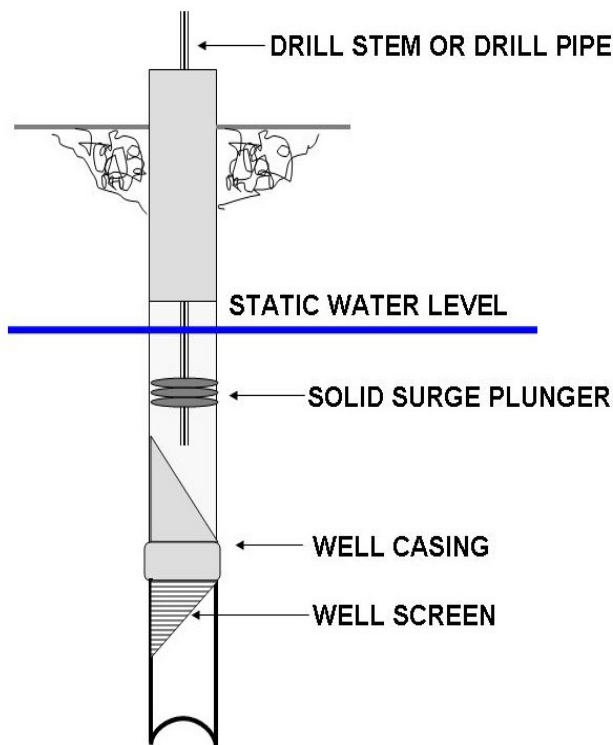

Jetting Nozzle that can be → attached to drill pipe.

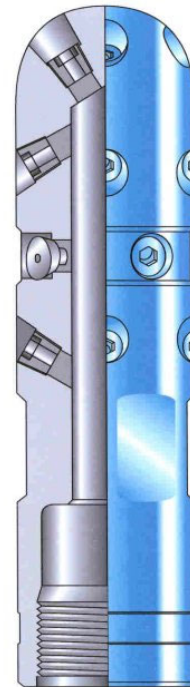

In the best of situations, a combination of methods can be used to ensure the efficient development and operation of a well.

Selecting an Optimum Pumping Rate

Before a well can be completed with the necessary pumping equipment, it should be tested for capacity and proper operation. When the well was drilled, the driller and geologist kept close watch of the amount of water production that had been obtained. The development techniques used can also be useful in estimating a well's production rate. However, the driller will normally know what to expect based on his experience, and the geologist or *hydrologist* will also obtain information on other nearby wells to bracket the expected production rate. If the well was drilled with air rotary, the *airlift* at the time of drilling also can serve as a baseline to estimate the well's production rate. Either way, the well is normally pump tested following well development.

A *pumping test* is normally conducted for at least eight hours in order to estimate a well's maximum production rate. Ideally, a twenty-four-hour step test is conducted. A step test is a *variable rate* pumping test, typically conducted for 24 hours at up to six different pumping rates. Typically, the well will be pumped at the lower estimated maximum pumping rate for the first four hours.

The pumping rate is then adjusted upwards in equal amounts every four hours until 24 hours of pumping have been completed. The personnel conducting the test keep track of the water levels in the well to ensure that the steps are not too large and not too small.

In the end, the optimum pumping rate is selected following a careful review and comparison of the water level data for each rate. The well's *specific capacity* (Sc) is then determined. Specific capacity is the gallons per minute the well can produce per foot of drawdown. Specific capacities for each of the pumping steps are compared. The highest Sc observed is normally associated with the optimum pumping rate. That rate should also have resulted in *stabilized* pumping levels or *drawdown*.



Well pumping test being conducted in photograph above. (Notice the portable electric generator for powering the pump. The Hydrogeologist is using a depth probe to measure the drop in the static water level.)

Groundwater Production System Post Quiz

Hyperlink to Assignment...

<http://www.abctlc.com/downloads/PDF/WD2ASS.pdf>

Answers to post quiz are located in the rear near the references.

1. Toxic material spilled or dumped near a well can leach into _____ and contaminate the groundwater drawn from that well.
2. Many terms are used to describe the nature and extent of the groundwater resource, the level below which all the spaces are filled with water is called the?
3. Above the water table lies the?
4. _____ may move in different directions below the ground than the water flowing on the surface.
5. Unconfined aquifers are those that are bounded by the water table. Some aquifers lie beneath layers of impermeable materials.
A. True B. False
6. Clay has many spaces between its grains, but the spaces are not large enough to permit free movement of water.
A. True B. False
7. _____ usually flows downhill with the slope of the water table.

Cone of Depression

8. When pumping begins, water begins to flow towards the well in contrast to the natural direction of groundwater movement.
A. True B. False
9. _____ describes a three-dimensional inverted cone surrounding the well that represents the volume of water removed as a result of pumping.

10. _____ is the vertical drop in the height between the water level in the well prior to pumping and the water level in the well during pumping.

11. When a well is installed in _____, water moves from the aquifer into the well through small holes or slits in the well casing or, in some types of wells, through the open bottom of the well.

Where Is Groundwater Stored?

12. Areas where groundwater exists in sufficient quantities to supply wells or springs are called aquifers, a term that literally means?

13. If the aquifer is sandwiched between layers of relatively impermeable materials, it is called?

14. Confined aquifers are not sandwiched between layers of relatively impermeable materials, and their upper boundaries are generally closer to the surface of the land.

A. True B. False

Groundwater Quality

15. The layers of soil and particles of sand, gravel, crushed rocks, and larger rocks were thought to act as filters, trapping contaminants before they could reach the groundwater.

A. True B. False

Water Use or Demand

16. Water system demand comes from a number of sources including residential, commercial, industrial and public consumers as well as waste and some?

17. The combination of storage reservoirs and distribution lines must be capable of meeting consumers' needs for pressure at all times.

A. True B. False

18. The quantity of water used in any community varies from 100 to 200 gallons per person per day.

A. True B. False

Topic 2 - Pumps and Motors Section

Section Focus: You will learn the basics of hydraulics, with a study into various pumps and motors. At the end of this section, you will be able to describe water pumps and motors and the associated hydraulic principles that are found in water treatment production. There is a post quiz at the end of this section to review your comprehension and a final examination in the Assignment for your contact hours.

Scope/Background: The main purpose of this section is to provide understanding of various water lifting procedures, basic pump fundamentals, hydraulic principles, theory, maintenance, related electrical and motor principles.

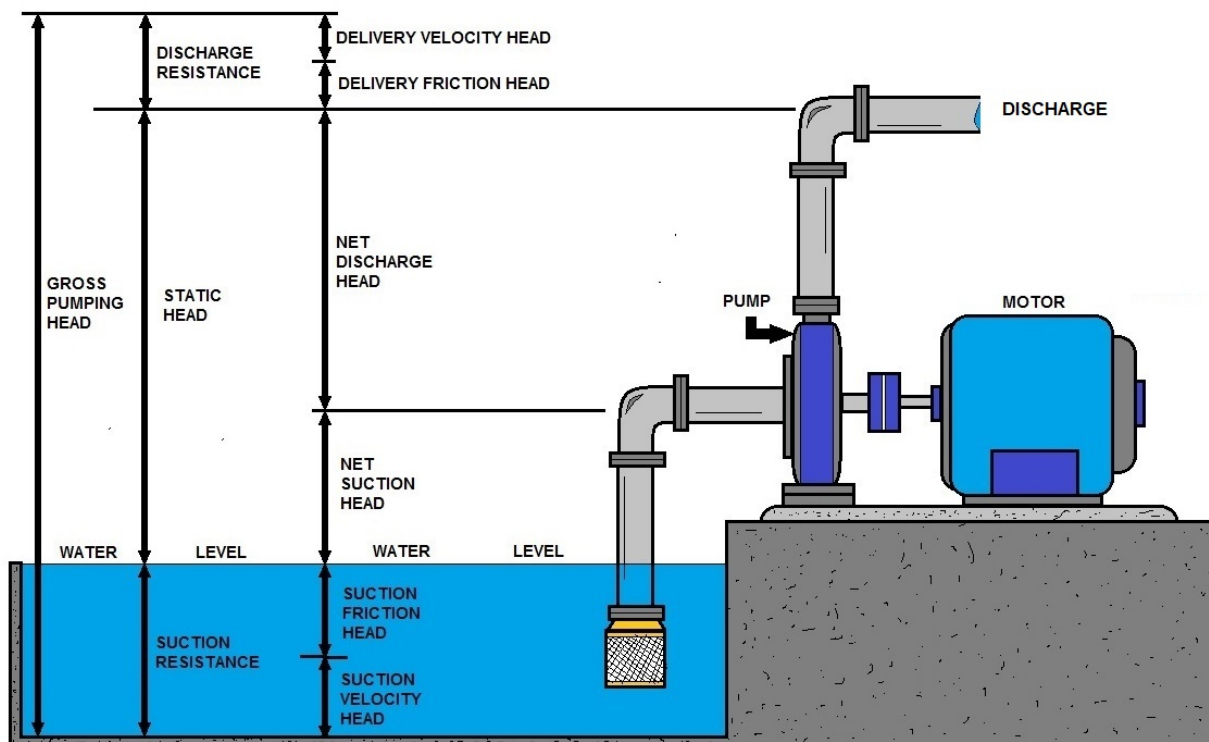

Technical Learning College

FACTORS IN DETERMINING A TYPICAL PUMP INSTALLATION

Pump Introduction

Moving fluids plays a major role in the process of a plant. Liquid can only move on its own power from top to bottom or from a high pressure to a lower pressure system. This means that energy to the liquid must be added to move the liquid from a low to a higher level.

To add the required energy to liquids, pumps are used. There are many different definitions of a pump but it can be described as: A machine used for the purpose of transferring quantities of liquids, gases and even solids from one location to another.

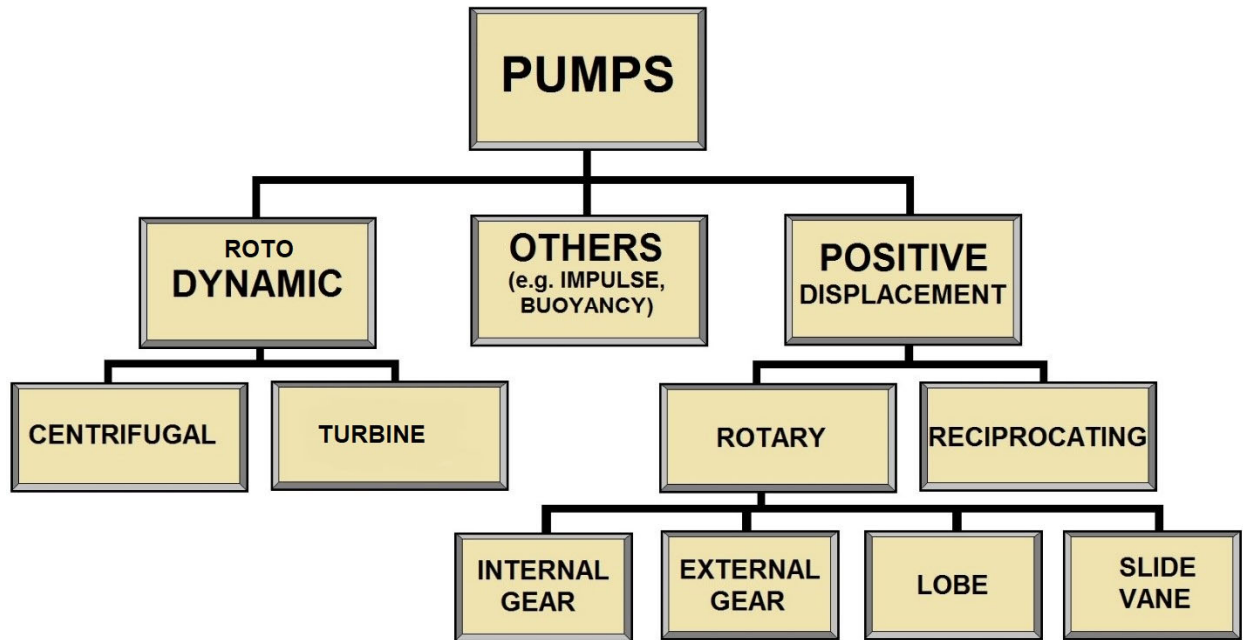

Types of Pumps

Pump types generally fall into two main categories - Rotodynamic and Positive Displacement, of which there are many forms.

The Rotodynamic pump transfers rotating mechanical energy into kinetic energy in the form of fluid velocity and pressure. The Centrifugal and Liquid Ring pumps are types of rotodynamic pump, which utilize centrifugal force to transfer the fluid being pumped.

The Rotary Lobe pump is a type of positive displacement pump, which directly displaces the pumped fluid from pump inlet to outlet in discrete volumes.

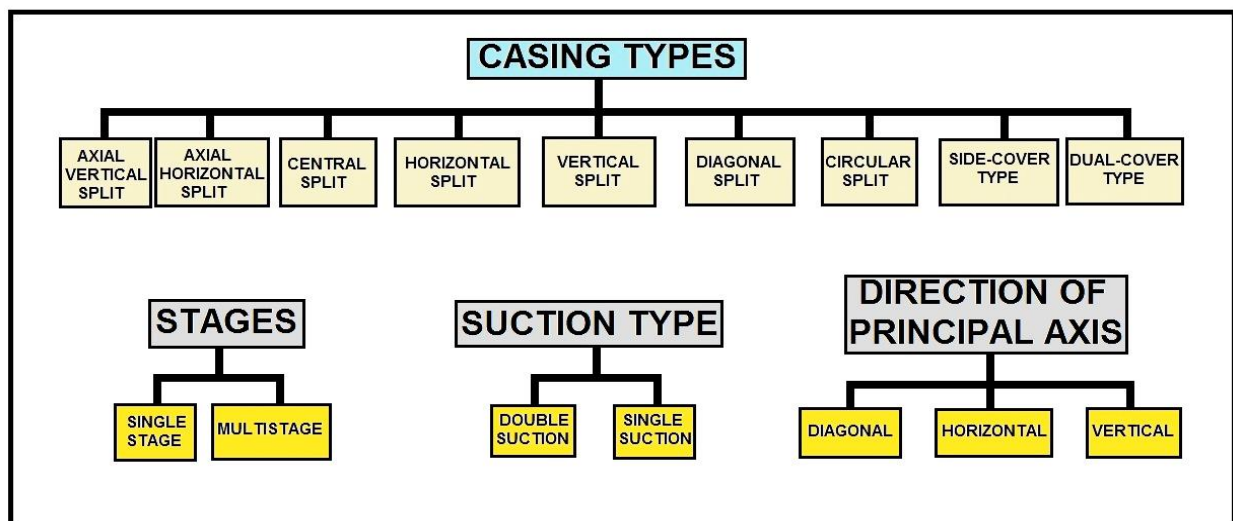

PUMP CONFIGURATIONS

Common Hydraulic Terms

Head

The height of a column or body of fluid above a given point expressed in linear units. Head is often used to indicate gauge pressure. Pressure is equal to the height times the density of the liquid.

Head, Friction

The head required to overcome the friction at the interior surface of a conductor and between fluid particles in motion. It varies with flow, size, type, and conditions of conductors and fittings, and the fluid characteristics.

Head, Static

The height of a column or body of fluid above a given point.

Hydraulics

Engineering science pertaining to liquid pressure and flow.

Hydrokinetics

Engineering science pertaining to the energy of liquid flow and pressure.

Pascal's Law

A pressure applied to a confined fluid at rest is transmitted with equal intensity throughout the fluid.

Pressure

The application of continuous force by one body upon another that it is touching; compression. Force per unit area, usually expressed in pounds per square inch (Pascal or bar).

Pressure, Absolute

The pressure above zone absolute, i.e. the sum of atmospheric and gauge pressure. In vacuum related work it is usually expressed in millimeters of mercury. (mmHg).

Pressure, Atmospheric

Pressure exerted by the atmosphere at any specific location. (Sea level pressure is approximately 14.7 pounds per square inch absolute, 1 bar = 14.5psi.)

Pressure, Gauge

Pressure differential above or below ambient atmospheric pressure.

Pressure, Static

The pressure in a fluid at rest.

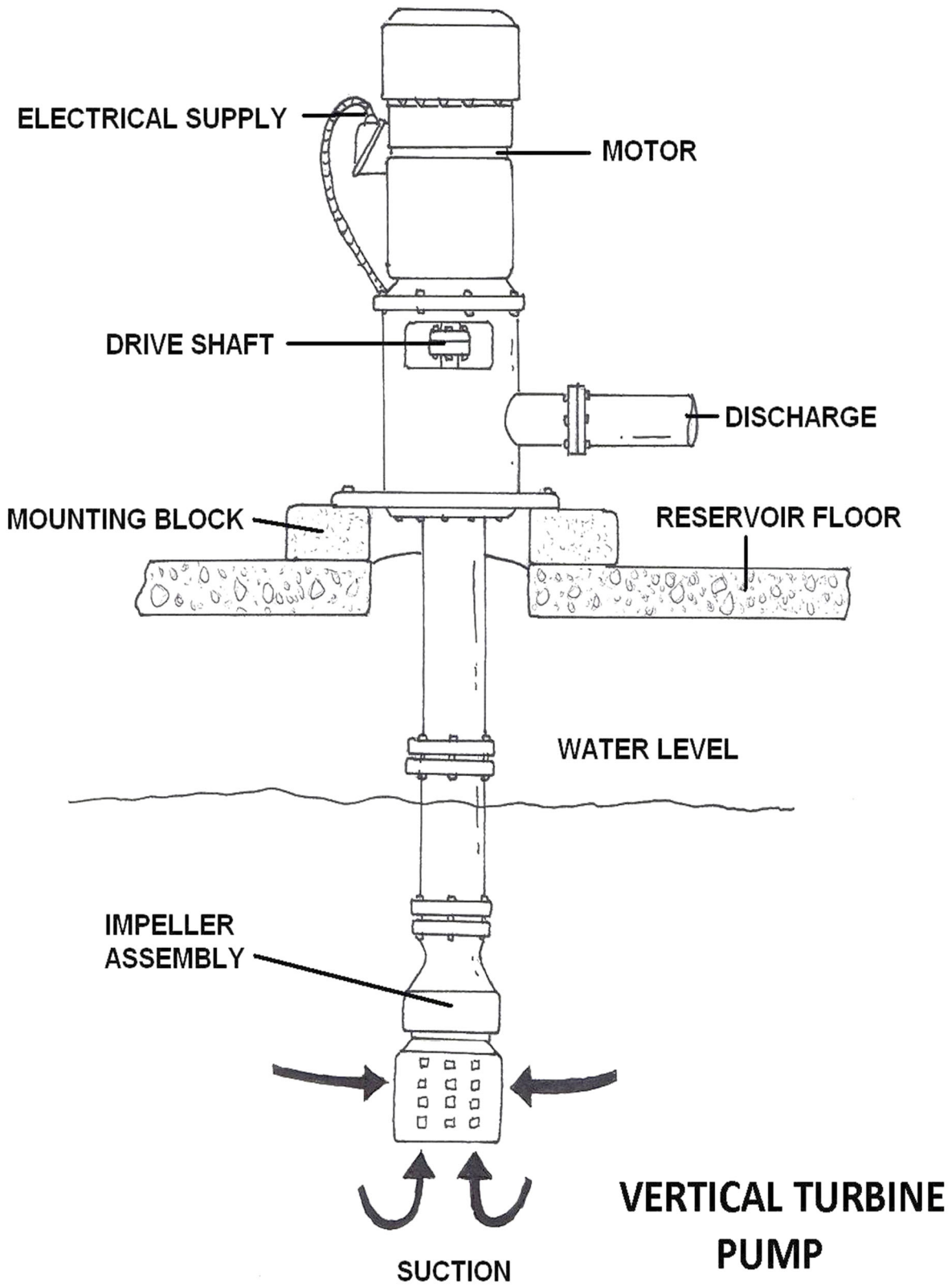

Hydraulic Principles Sub-Section

Definition **Hydraulics** is a branch of engineering concerned mainly with moving liquids. The term is applied commonly to the study of the mechanical properties of water, other liquids, and even gases when the effects of compressibility are small. Hydraulics can be divided into two areas, hydrostatics and hydrokinetics.

Hydraulics *The Engineering science pertaining to liquid pressure and flow.*

The word **hydraulics** is based on the Greek word for water, and originally covered the study of the physical behavior of water at rest and in motion. Use has broadened its meaning to include the behavior of all liquids, although it is primarily concerned with the motion of liquids.

Hydraulics includes the manner in which liquids act in tanks and pipes, deals with their properties, and explores ways to take advantage of these properties.

Hydrostatics, the consideration of liquids at rest, involves problems of buoyancy and flotation, pressure on dams and submerged devices, and hydraulic presses. The relative incompressibility of liquids is one of its basic principles. Hydrodynamics, the study of liquids in motion, is concerned with such matters as friction and turbulence generated in pipes by flowing liquids, the flow of water over weirs and through nozzles, and the use of hydraulic pressure in machinery.

Hydrostatics

Hydrostatics is about the pressures exerted by a fluid at rest. Any fluid is meant, not just water. Research and careful study on water yields many useful results of its own, however, such as forces on dams, buoyancy and hydraulic actuation, and is well worth studying for such practical reasons.



The definition of a fluid deserves careful consideration. It is usually stated that a fluid is a substance that cannot resist a shearing stress, so that pressures are normal to confining surfaces.

Geology has now shown us clear that there are substances which can resist shearing forces over short time intervals, and appear to be typical solids, but which flow like liquids over long time intervals. Such materials include wax and pitch, ice, and even rock.

A ball of pitch, which can be shattered by a hammer, will spread out and flow in months. Ice, a typical solid, will flow in a period of years, as shown in glaciers, and rock will flow over hundreds of years, as in convection in the mantle of the earth.

Shear earthquake waves, with periods of seconds, propagate deep in the earth, though the rock there can flow like a liquid when considered over centuries. The rate of shearing may not be strictly proportional to the stress, but exists even with low stress.

Viscosity may be the physical property that varies over the largest numerical range, competing with electrical resistivity.

There are several familiar topics in hydrostatics which often appears in expositions of introductory science, and which are also of historical interest and can enliven their presentation. Let us start our study with the principles of our atmosphere.

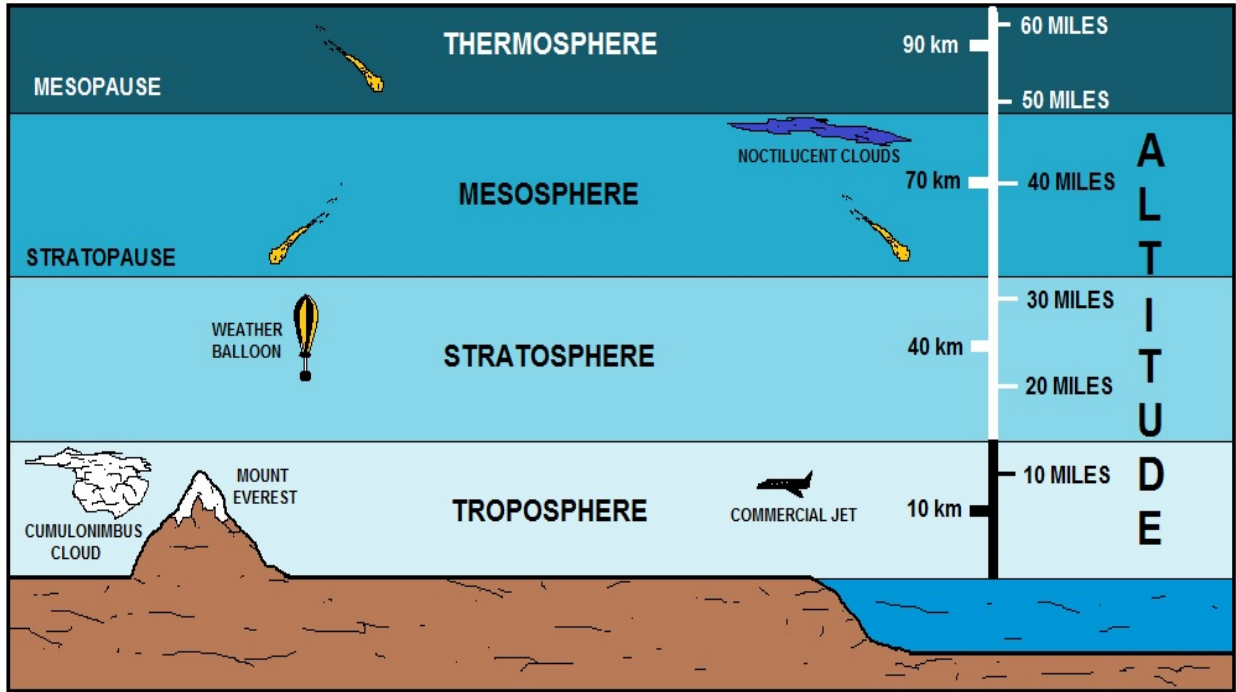

ATMOSPHERE DIAGRAM

Atmospheric Pressure

The atmosphere is the entire mass of air that surrounds the earth. While it extends upward for about 300 miles, the section of primary interest is the portion that rests on the earth's surface and extends upward for about 7 1/2 miles. This layer is called the troposphere.

If a column of air 1-inch square extending all the way to the "top" of the atmosphere could be weighed, this column of air would weigh approximately 14.7 pounds at sea level. Thus, atmospheric pressure at sea level is approximately 14.7 psi.

As one ascends, the atmospheric pressure decreases by approximately 1.0 psi for every 2,343 feet. However, below sea level, in excavations and depressions, atmospheric pressure increases. Pressures under water differ from those under air because the weight of the water must be added to the pressure of the air.

Atmospheric pressure can be measured by any of several methods. The common laboratory method uses the mercury column barometer. The height of the mercury column serves as an indicator of atmospheric pressure. At sea level and at a temperature of 0° Celsius (C), the height of the mercury column is approximately 30 inches, or 76 centimeters. This represents a pressure of approximately 14.7 psi. The 30-inch column is used as a reference standard.

Another device used to measure atmospheric pressure is the aneroid barometer. The aneroid barometer uses the change in shape of an evacuated metal cell to measure variations in atmospheric pressure. The thin metal of the aneroid cell moves in or out with the variation of pressure on its external surface. This movement is transmitted through a system of levers to a pointer, which indicates the pressure.

The atmospheric pressure does not vary uniformly with altitude. It changes very rapidly. Atmospheric pressure is defined as the force per unit area exerted against a surface by the weight of the air above that surface. In the diagram below, the pressure at point "X" increases as the weight of the air above it increases. The same can be said about decreasing pressure, where the pressure at point "X" decreases if the weight of the air above it also decreases.

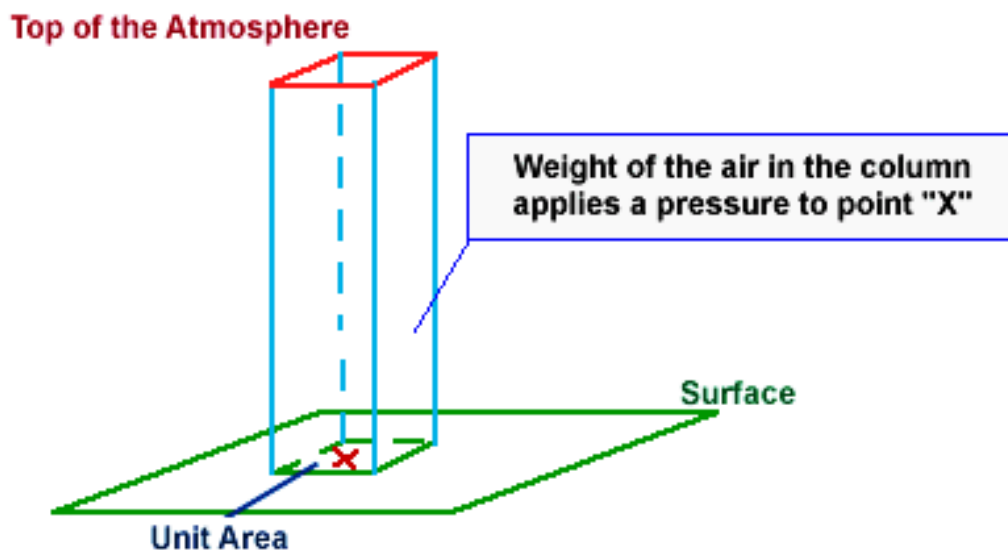

Barometric Loop

The barometric loop consists of a continuous section of supply piping that abruptly rises to a height of approximately 35 feet and then returns back down to the originating level. It is a loop in the piping system that effectively protects against backsiphonage. It may not be used to protect against back-pressure.

Its operation, in the protection against backsiphonage, is based upon the principle that a water column, at sea level pressure, will not rise above 33.9 feet. In general, barometric loops are locally fabricated, and are 35 feet high.

Pressure may be referred to using an absolute scale, pounds per square inch absolute (**psia**), or gauge scale, (**psiag**). Absolute pressure and gauge pressure are related. Absolute pressure is equal to gauge pressure plus the atmospheric pressure. At sea level, the atmospheric pressure is 14.7 psia.

Absolute pressure is the total pressure.

Gauge pressure is simply the pressure read on the gauge. If there is no pressure on the gauge other than atmospheric, the gauge will read zero. Then the absolute pressure would be equal to 14.7 psi, which is the atmospheric pressure.

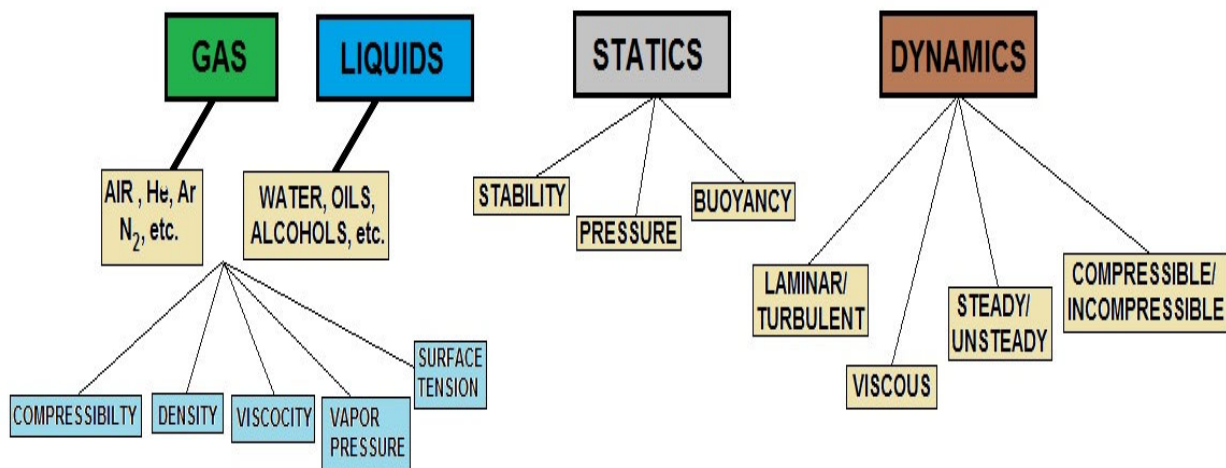
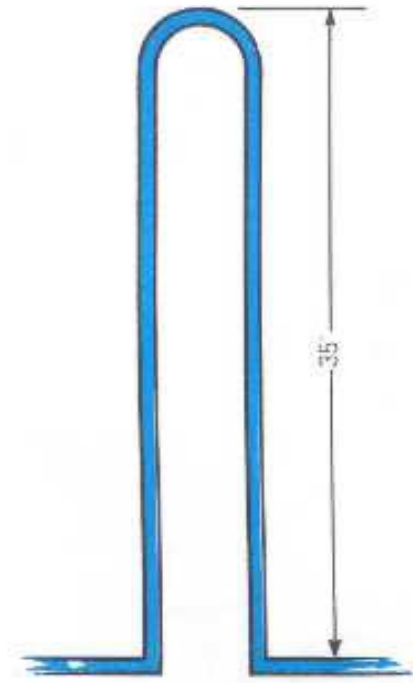

FLUID MECHANICS OVERVIEW

Pressure

By a fluid, we have a material in mind like water or air, two very common and important fluids. Water is incompressible, while air is very compressible, but both are fluids. Water has a definite volume; air does not. Water and air have low viscosity; that is, layers of them slide very easily on one another, and they quickly their shapes when disturbed by flows. Other fluids, such as molasses, may have high viscosity and take a long time to come to equilibrium, but they are no less fluids. The coefficient of viscosity is the ratio of the shearing force to the velocity gradient. Hydrostatics deals with permanent, time-independent states of fluids, so viscosity does not appear, except as discussed in the Introduction.

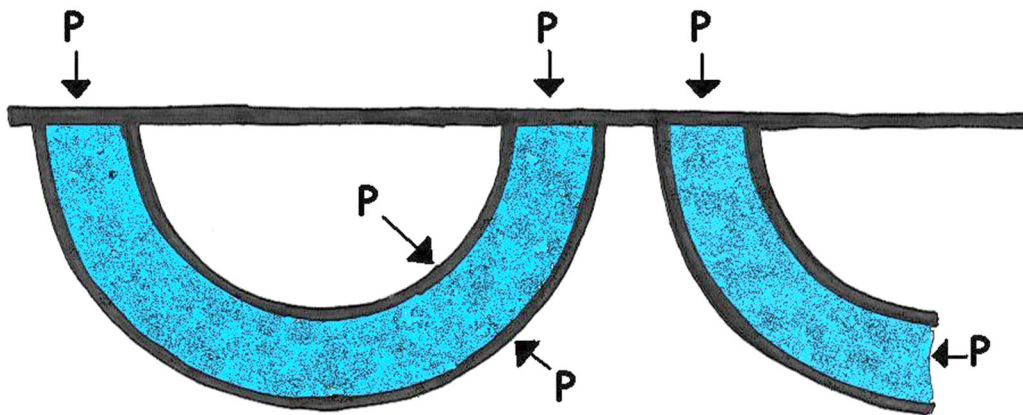

EQUALITY OF PRESSURE –CURTIAN RINGS DIAGRAM

Pressure Definition

A fluid, therefore, is a substance that cannot exert any permanent forces tangential to a boundary. Any force that it exerts on a boundary must be normal perpendicular to the boundary. Such a force is proportional to the area on which it is exerted, and is called a pressure.

We can imagine any surface in a fluid as dividing the fluid into parts pressing on each other, as if it were a thin material membrane, and so think of the pressure at any point in the fluid, not just at the boundaries. In order for any small element of the fluid to be in equilibrium, the pressure must be the same in all directions (or the element would move in the direction of least pressure), and if no other forces are acting on the body of the fluid, the pressure must be the same at all neighboring points.

Pascal's Principle

Therefore, in this case the pressure will be the same throughout the fluid, and the same in any direction at a point (Pascal's Principle). Pressure is expressed in units of force per unit area such as dyne/cm², N/cm² (pascal), pounds/in² (psi) or pounds/ft² (psf). The axiom that if a certain volume of fluid were somehow made solid, the equilibrium of forces would not be disturbed, is useful in reasoning about forces in fluids.

Equality of Pressure

On earth, fluids are also subject to the force of gravity, which acts vertically downward, and has a magnitude $\gamma = \rho g$ per unit volume, where g is the acceleration of gravity, approximately 981 cm/s² or 32.15 ft/s², ρ is the density, the mass per unit volume, expressed in g/cm³, kg/m³, or slug/ft³, and γ is the specific weight, measured in lb/in³, or lb/ft³ (pcf).

Gravitation

Gravitation is an example of a body force that disturbs the equality of pressure in a fluid. The presence of the gravitational body force causes the pressure to increase with depth, according to the equation $dp = \rho g dh$, in order to support the water above. We call this relation the barometric equation, for when this equation is integrated, we find the variation of pressure with height or depth. If the fluid is incompressible, the equation can be integrated at once, and the pressure as a function of depth h is $p = \rho gh + p_0$.

The density of water is about 1 g/cm^3 , or its specific weight is 62.4 pcf .

We may ask what depth of water gives the normal sea-level atmospheric pressure of 14.7 psi , or 2117 psf .

This is simply $2117 / 62.4 = 33.9 \text{ ft}$ of water. This is the maximum height to which water can be raised by a suction pump, or, more correctly, can be supported by atmospheric pressure.

Equality of Pressure

Professor James Thomson (brother of William Thomson, Lord Kelvin) illustrated the equality of pressure by a "curtain-ring" analogy shown in the diagram. A section of the toroid was identified, imagined to be solidified, and its equilibrium was analyzed.

The forces exerted on the curved surfaces have no component along the normal to a plane section, so the pressures at any two points of a plane must be equal, since the fluid represented by the curtain ring was in equilibrium.

The diagrams illustrates the equality of pressures in orthogonal directions. This can be extended to any direction whatever, so Pascal's Principle is established. This demonstration is similar to the usual one using a triangular prism and considering the forces on the end and lateral faces separately.

Free Surface

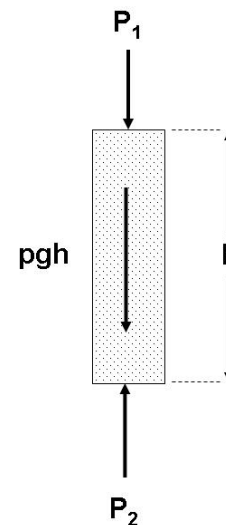

Increase of Pressure with Depth

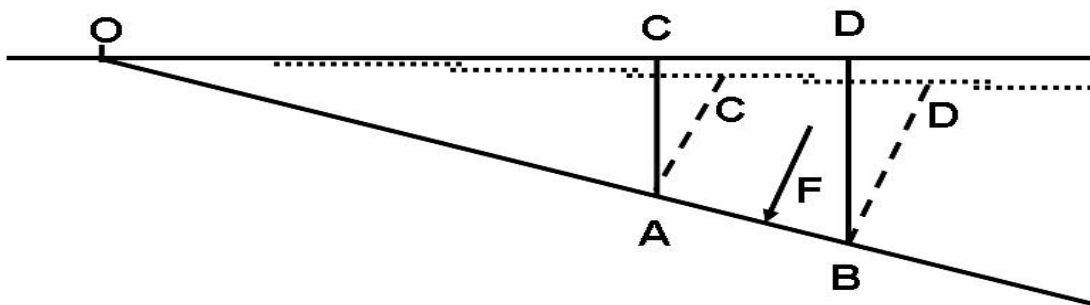

THRUST ON A PLANE DIAGRAM

General Pumping Fundamentals- Introduction

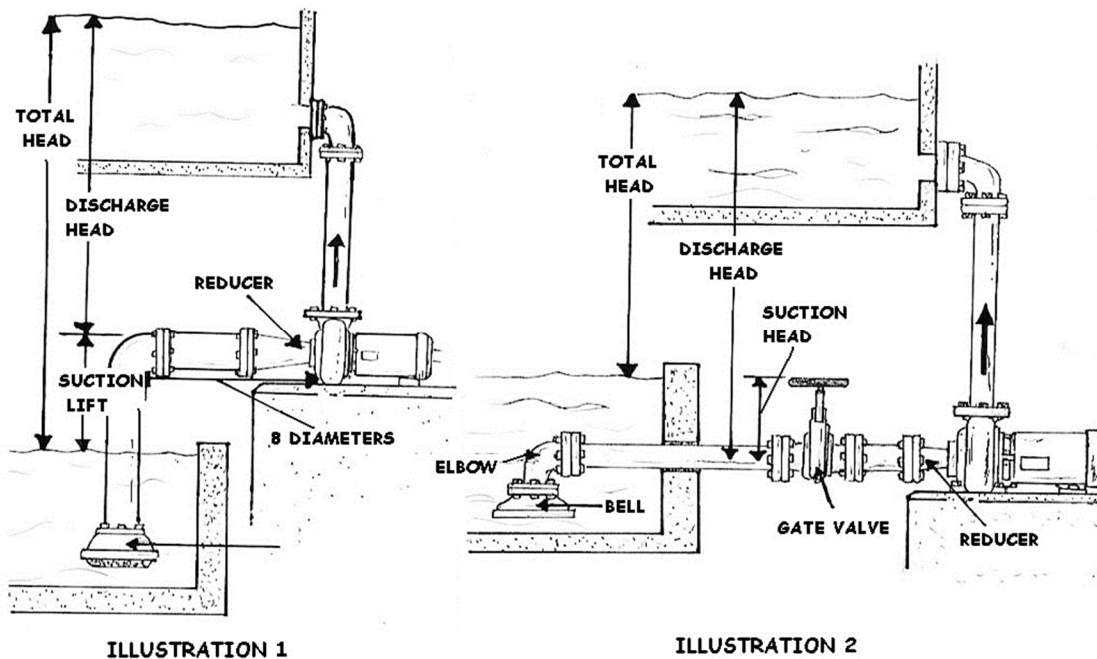

Here are the important points to consider about suction piping when the liquid being pumped is below the level of the pump:

- First, suction lift is when the level of water to be pumped is below the centerline of the pump. Sometimes suction lift is also referred to as 'negative suction head'.
- The ability of the pump to lift water is the result of a partial vacuum created at the center of the pump.
- This works similar to sucking soda from a straw. As you gently suck on a straw, you are creating a vacuum or a pressure differential. Less pressure is exerted on the liquid inside the straw, so that the greater pressure is exerted by the atmosphere on the liquid around the outside of the straw, causing the liquid in the straw to move up. By sucking on the straw, this allows atmospheric pressure to move the liquid.
- Look at the diagram illustrated as "1". The foot valve is located at the end of the suction pipe of a pump. It opens to allow water to enter the suction side, but closes to prevent water from passing back out of the bottom end.
- The suction side of pipe should be one diameter larger than the pump inlet. The required eccentric reducer should be turned so that the top is flat and the bottom tapered.

Notice in illustration "2" that the liquid is above the level of the pump. Sometimes this is referred to as 'flooded suction' or 'suction head' situations.

Points to Note are:

If an elbow and bell are used, they should be at least one pipe diameter from the tank bottom and side. This type of suction piping must have a gate valve which can be used to prevent the reverse flow when the pump has to be removed. In the illustration, you can see in both cases the discharge head is from the centerline of the pump to the level of the discharge water. The total head is the difference between the two liquid levels.

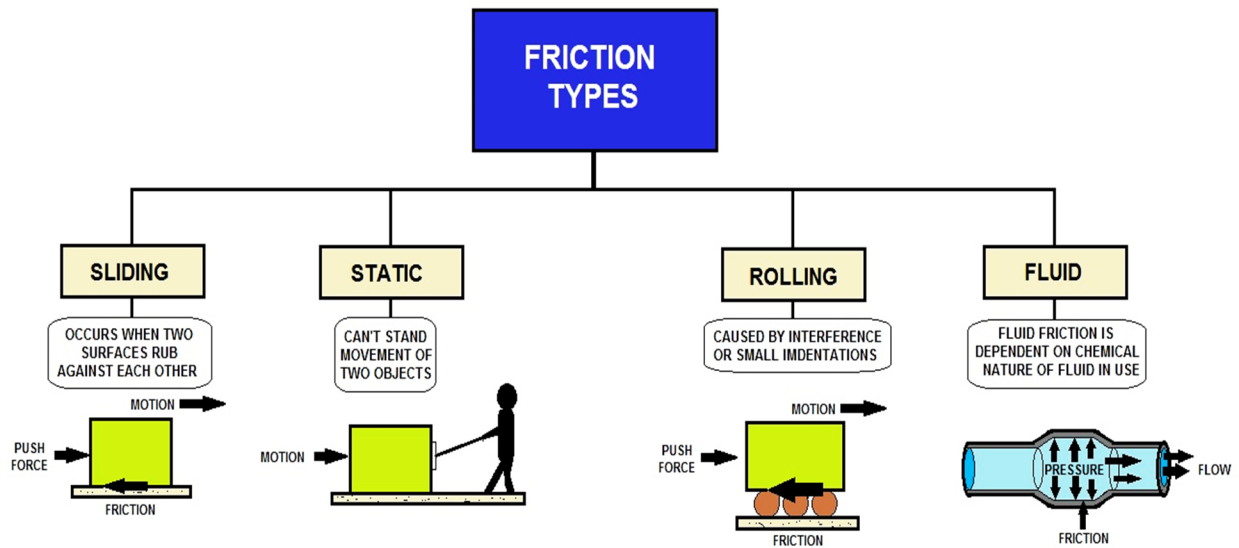

FRICTION TYPE EXAMPLES

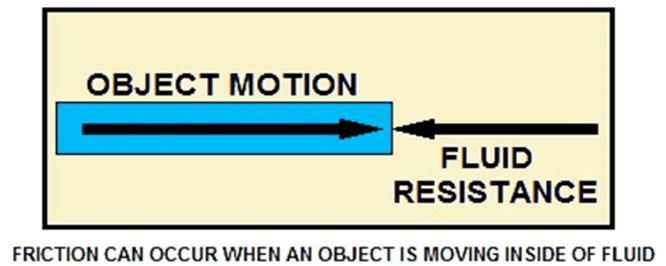
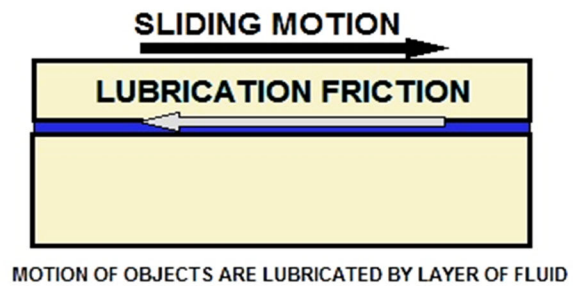
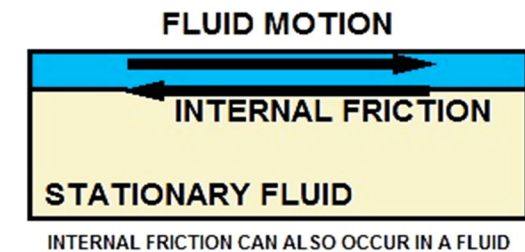
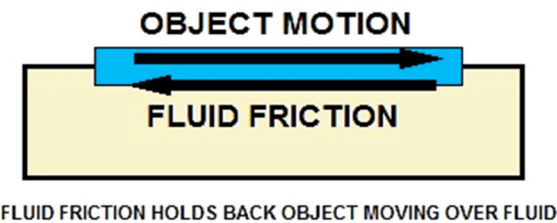
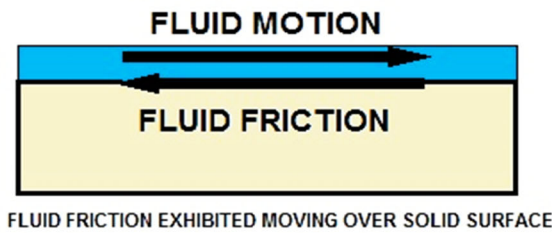

EXAMPLES OF FLUID FRICTION

Dynamic Pump Definitions

Hyperlink to the Glossary and Appendix

<http://www.abctlc.com/downloads/PDF/WTGlossary.pdf>

Fluid: Any substance that can be pumped such as oil, water, refrigerant, or even air.

Gasket: Flat material that is compressed between two faces to form a seal.

Gland follower: A bushing used to compress the packing in the stuffing box and to control leakoff.

Gland sealing line: A line that directs sealing fluid to the stuffing box.

Horizontal pumps: Pumps in which the center line of the shaft is horizontal.

Impeller: The part of the pump that increases the speed of the fluid being handled.

Inboard: The end of the pump closest to the motor.

Inter-stage diaphragm: A barrier that separates stages of a multi-stage pump.

Key: A rectangular piece of metal that prevents the impeller from rotating on the shaft.

Keyway: The area on the shaft that accepts the key.

Kinetic energy: Energy associated with motion.

Lantern ring: A metal ring located between rings of packing that distributes gland sealing fluid.

Leak-off: Fluid that leaks from the stuffing box.

Mechanical seal: A mechanical device that seals the pump stuffing box.

Mixed flow pump: A pump that uses both axial-flow and radial-flow components in one impeller.

Multi-stage pumps: Pumps with more than one impeller.

Outboard: The end of the pump farthest from the motor.

Packing: Soft, pliable material that seals the stuffing box.

Positive displacement pumps: Pumps that move fluids by physically displacing the fluid inside the pump.

Radial bearings: Bearings that prevent shaft movement in any direction outward from the center line of the pump.

Radial flow: Flow at 90° to the center line of the shaft.

Retaining nut: A nut that keeps the parts in place.

Rotor: The rotating parts, usually including the impeller, shaft, bearing housings, and all other parts included between the bearing housing and the impeller.

Score: To cause lines, grooves or scratches.

Shaft: A cylindrical bar that transmits power from the driver to the pump impeller.

Shaft sleeve: A replaceable tubular covering on the shaft.

Shroud: The metal covering over the vanes of an impeller.

Slop drain: The drain from the area that collects leak-off from the stuffing box.

Slurry: A thick, viscous fluid, usually containing small particles.

Stages: Impellers in a multi-stage pump.

Stethoscope: A metal device that can amplify and pinpoint pump sounds.

Strainer: A device that retains solid pieces while letting liquids through.

Stuffing box: The area of the pump where the shaft penetrates the casing.

Suction: The place where fluid enters the pump.

Suction eye: The place where fluid enters the pump impeller.

Throat bushing: A bushing at the bottom of the stuffing box that prevents packing from being pushed out of the stuffing box into the suction eye of the impeller.

Thrust: Force, usually along the center line of the pump.

Thrust bearings: Bearings that prevent shaft movement back and forth in the same direction as the center line of the shaft.

Troubleshooting: Locating a problem.

Vanes: The parts of the impeller that push and increase the speed of the fluid in the pump.

Vertical pumps: Pumps in which the center line of the shaft runs vertically.

Volute: The part of the pump that changes the speed of the fluid into pressure.

Wearing rings: Replaceable rings on the impeller or the casing that wear as the pump operates.

Pump Introduction

Pumps are used to move or raise fluids. They are not only very useful, but are excellent examples of hydrostatics. Pumps are of two general types, hydrostatic or positive displacement pumps, and pumps depending on dynamic forces, such as centrifugal pumps. Here we will only consider positive displacement pumps, which can be understood purely by hydrostatic considerations. They have a piston (or equivalent) moving in a closely-fitting cylinder, and forces are exerted on the fluid by motion of the piston.

Let's cover the essentials first. The key to the whole operation is, of course, the *pump*. And regardless of what type it is (reciprocating piston, centrifugal, turbine or jet-ejector, for either shallow or deep well applications), its purpose is to move water and generate the delivery force we call pressure.

Sometimes — with centrifugal pumps in particular — pressure is not referred to in pounds per square inch but rather as the equivalent in elevation, called head. No matter; head in feet divided by 2.31 equals pressure, so it's simple enough to establish a common figure.

Pumps may be classified on the basis of the application they serve. All pumps may be divided into two major categories: (1) dynamic, in which energy is continuously added to increase the fluid velocities within the machine, and (2) displacement, in which the energy is periodically added by application of force.

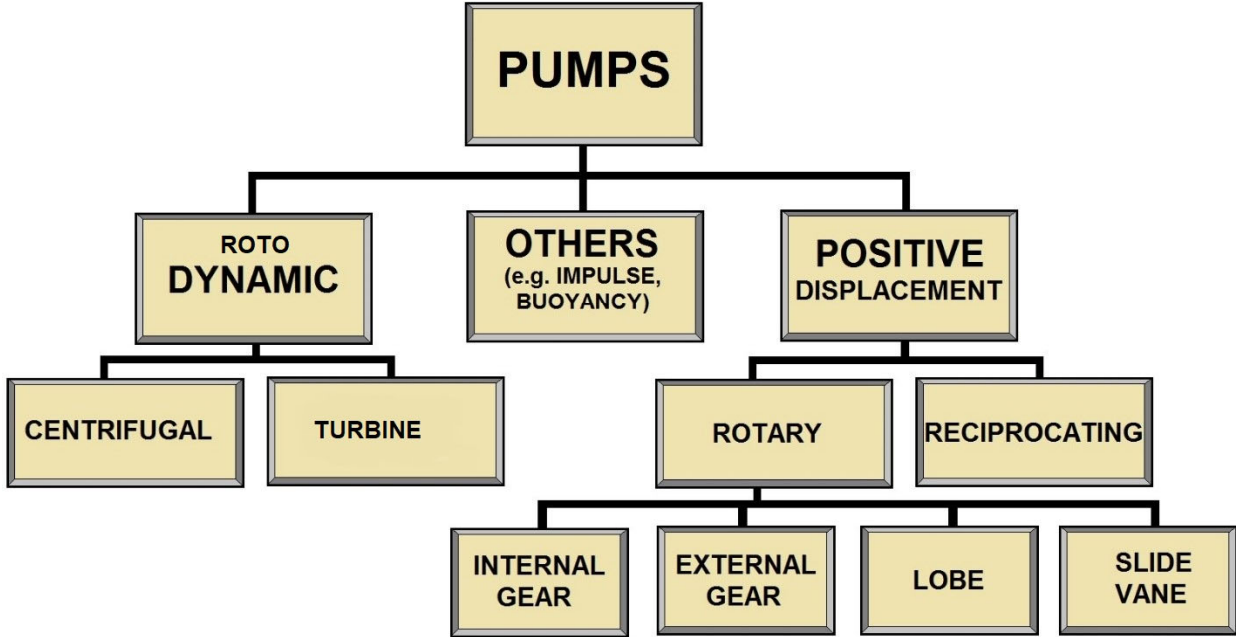

Types of Pumps

The family of pumps comprises a large number of types based on application and capabilities. The two major groups of pumps are dynamic and positive displacement.

Dynamic Pumps (Centrifugal Pump)

Centrifugal pumps are classified into three general categories:

Radial flow—a centrifugal pump in which the pressure is developed wholly by centrifugal force.

Mixed flow—a centrifugal pump in which the pressure is developed partly by centrifugal force and partly by the lift of the vanes of the impeller on the liquid.

Axial flow—a centrifugal pump in which the pressure is developed by the propelling or lifting action of the vanes of the impeller on the liquid.

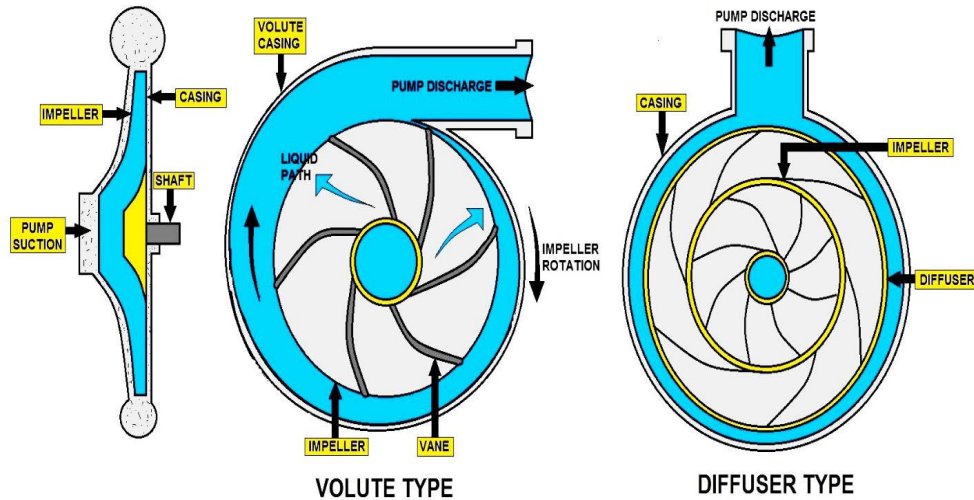

TYPES OF CENTRIFUGAL PUMPS

We have already seen an important example of this in the hydraulic lever or hydraulic press, which we have called quasi-static. The simplest pump is the syringe, filled by withdrawing the piston and emptied by pressing it back in, as its port is immersed in the fluid or removed from it.

More complicated pumps have valves allowing them to work repetitively. These are usually check valves that open to allow passage in one direction, and close automatically to prevent reverse flow. There are many kinds of valves, and they are usually the most trouble-prone and complicated part of a pump.

The force pump has two check valves in the cylinder, one for supply and the other for delivery. The supply valve opens when the cylinder volume increases, the delivery valve when the cylinder volume decreases.

The lift pump has a supply valve and a valve in the piston that allows the liquid to pass around it when the volume of the cylinder is reduced. The delivery in this case is from the upper part of the cylinder, which the piston does not enter.

Diaphragm pumps are force pumps in which the oscillating diaphragm takes the place of the piston. The diaphragm may be moved mechanically, or by the pressure of the fluid on one side of the diaphragm.

Some positive displacement pumps are shown below. The force and lift pumps are typically used for water. The force pump has two valves in the cylinder, while the lift pump has one valve in the cylinder and one in the piston. The maximum lift, or "suction," is determined by the atmospheric pressure, and either cylinder must be within this height of the free surface.

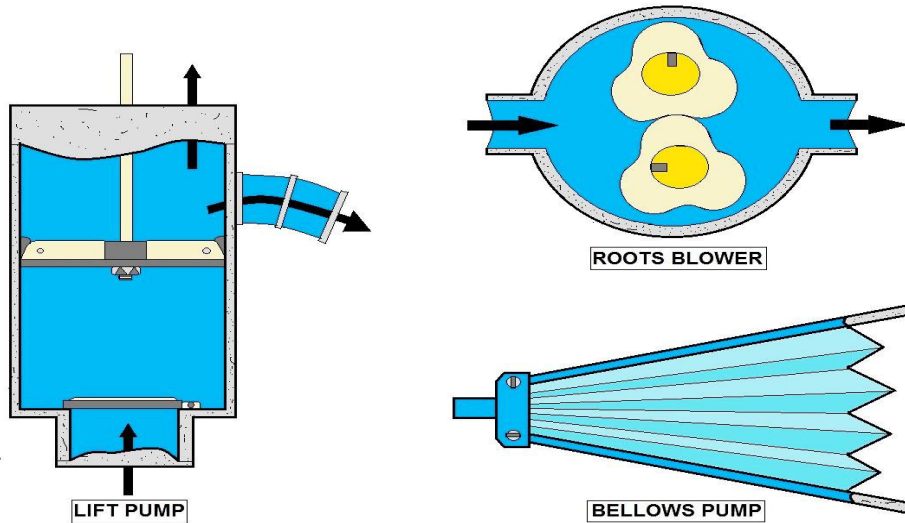

TYPES OF POSITIVE DISPLACEMENT PUMPS

The force pump, however, can give an arbitrarily large pressure to the discharged fluid, as in the case of a diesel engine injector. A nozzle can be used to convert the pressure to velocity, to produce a jet, as for firefighting. Fire fighting force pumps usually have two cylinders feeding one receiver alternately. The air space in the receiver helps to make the water pressure uniform.

The three pumps below are typically used for air, but would be equally applicable to liquids. The Roots blower has no valves, their place taken by the sliding contact between the rotors and the housing.

The **Roots (rotating lobe) blower** can either exhaust a receiver or provide air under moderate pressure, in large volumes.

The **Bellows** is a very old device, requiring no accurate machining. The single valve is in one or both sides of the expandable chamber. Another valve can be placed at the nozzle if required. The valve can be a piece of soft leather held close to holes in the chamber.

The **bicycle pump** uses the valve on the valve stem of the tire or inner tube to hold pressure in the tire. The piston, which is attached to the discharge tube, has a flexible seal that seals when the cylinder is moved to compress the air, but allows air to pass when the movement is reversed. Diaphragm and vane pumps are not shown, but they act the same way by varying the volume of a chamber, and directing the flow with check valves.

Positive Displacement Pump Examples

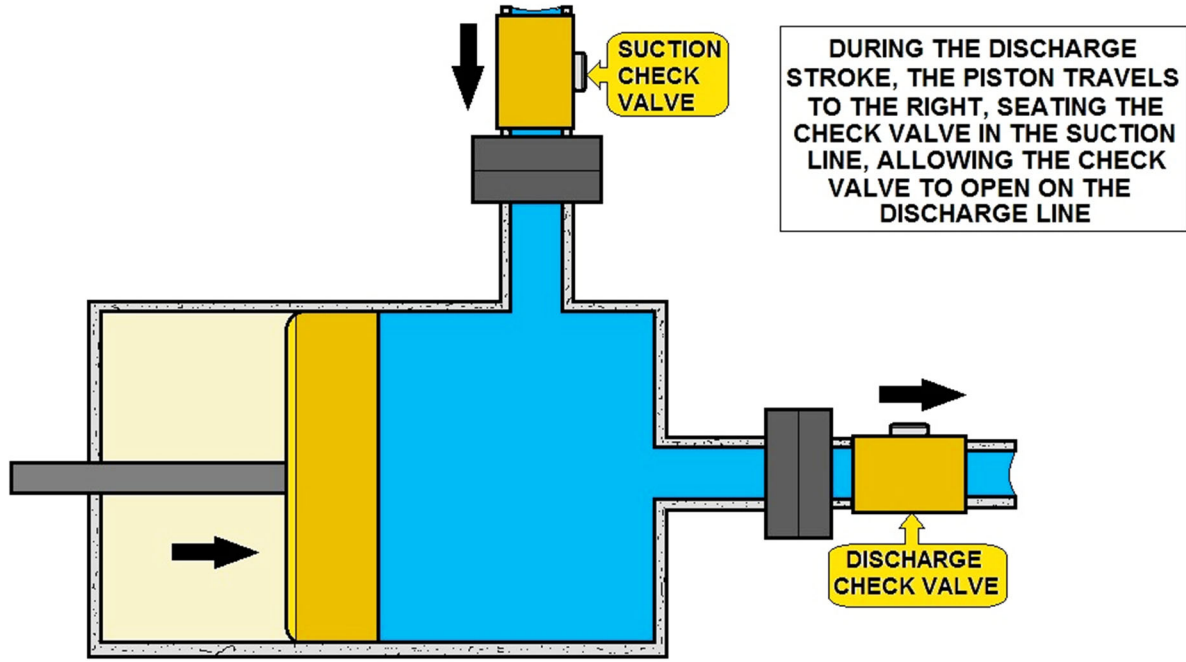

PISTON TYPE –POSITIVE DISPLACEMENT PUMP

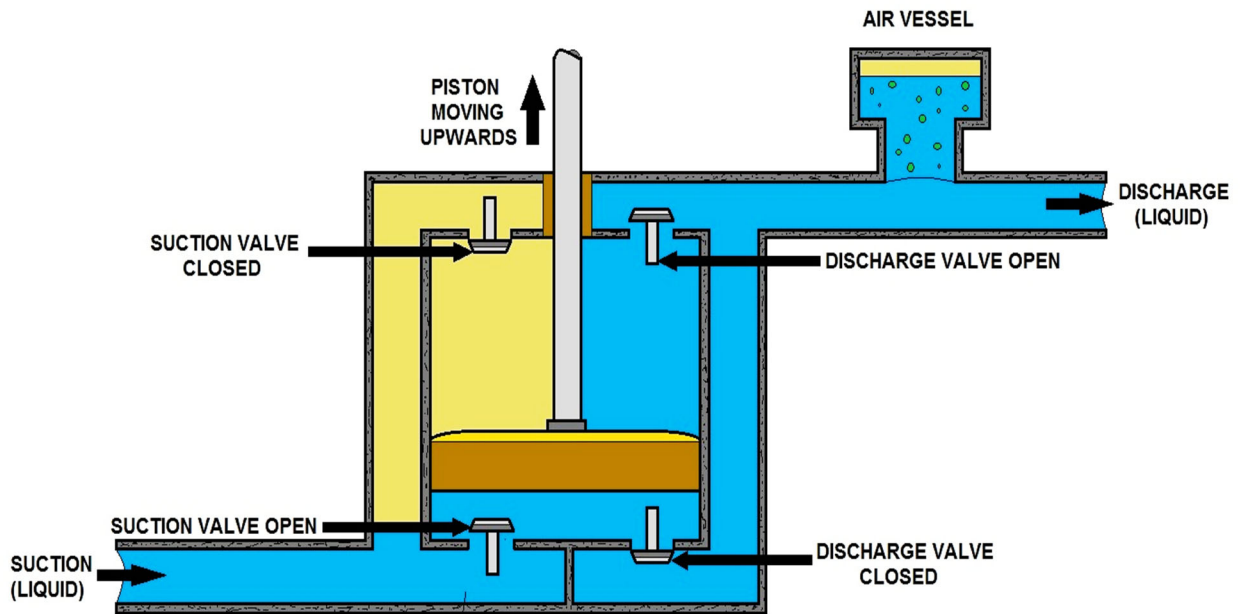

**POSITIVE DISPLACEMENT PUMP
RECIPROCATING PISTON TYPE**

Positive Displacement Pump Sub-Section

A positive displacement pump has an expanding cavity on the suction side of the pump and a decreasing cavity on the discharge side. Liquid is allowed to flow into the pump as the cavity on the suction side expands and the liquid is forced out of the discharge as the cavity collapses. This principle applies to all types of positive displacement pumps whether the pump is a rotary lobe, gear within a gear, piston, diaphragm, screw, progressing cavity, etc.

A positive displacement pump, unlike a centrifugal pump, will produce the same flow at a given RPM no matter what the discharge pressure is. A positive displacement pump cannot be operated against a closed valve on the discharge side of the pump, i.e. it does not have a shut-off head like a centrifugal pump does. If a positive displacement pump is allowed to operate against a closed discharge valve, it will continue to produce flow that will increase the pressure in the discharge line until either the line bursts or the pump is severely damaged or both.

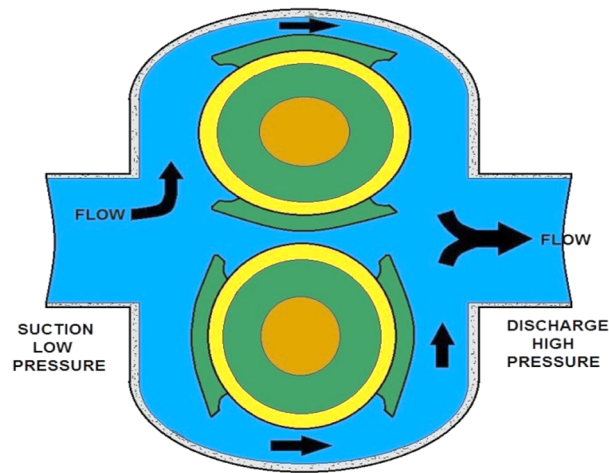

POSITIVE DISPLACEMENT PUMP WITH ROTATING LOBES

Types of Positive Displacement Pumps

Single Rotor	Multiple Rotor
Vane	Gear
Piston	Lobe
Flexible Member	Circumferential Piston
Single Screw	Multiple Screw

There are many other types of positive displacement pumps. We will look at:

- Plunger pumps
- Diaphragm pumps
- Progressing cavity pumps, and
- Screw pumps

Single Rotator Positive Displacement Pump

Component	Description
Vane	The vane(s) may be blades, buckets, rollers, or slippers that cooperate with a dam to draw fluid into and out of the pump chamber.
Piston	Fluid is drawn in and out of the pump chamber by a piston(s) reciprocating within a cylinder(s) and operating port valves.
Flexible Member	Pumping and sealing depends on the elasticity of a flexible member(s) that may be a tube, vane, or a liner.
Single Screw	Fluid is carried between rotor screw threads as they mesh with internal threads on the stator.

Multiple Rotator

Component	Description
Gear	Fluid is carried between gear teeth and is expelled by the meshing of the gears that cooperate to provide continuous sealing between the pump inlet and outlet.
Lobe	Fluid is carried between rotor lobes that cooperate to provide continuous sealing between the pump inlet and outlet.
Circumferential piston	Fluid is carried in spaces between piston surfaces not requiring contacts between rotor surfaces.
Multiple Screw	Fluid is carried between rotor screw threads as they mesh.

Plunger Pump

The plunger pump is a positive displacement pump that uses a plunger or piston to force liquid from the suction side to the discharge side of the pump. It is used for heavy sludge. The movement of the plunger or piston inside the pump creates pressure inside the pump, so you have to be careful that this kind of pump is never operated against any closed discharge valve. All discharge valves must be open before the pump is started, to prevent any fast build-up of pressure that could damage the pump.

Diaphragm Pumps

In this type of pump, a diaphragm provides the mechanical action used to force liquid from the suction to the discharge side of the pump. The advantage the diaphragm has over the plunger is that the diaphragm pump does not come in contact with moving metal. This can be important when pumping abrasive or corrosive materials.

There are three main types of diaphragm pumps available:

1. Diaphragm sludge pump
2. Chemical metering or proportional pump
3. Air-powered double-diaphragm pump

Understanding the Basic Centrifugal Pump

The water pump commonly found in our systems is centrifugal pumps. These pumps work by spinning water around in a circle inside a cylindrical pump housing. The pump makes the water spin by pushing it with an impeller. The blades of this impeller project outward from an axle like the arms of a turnstile and, as the impeller spins, the water spins with it. As the water spins, the pressure near the outer edge of the pump housing becomes much higher than near the center of the impeller.

There are many ways to understand this rise in pressure, and here are two:

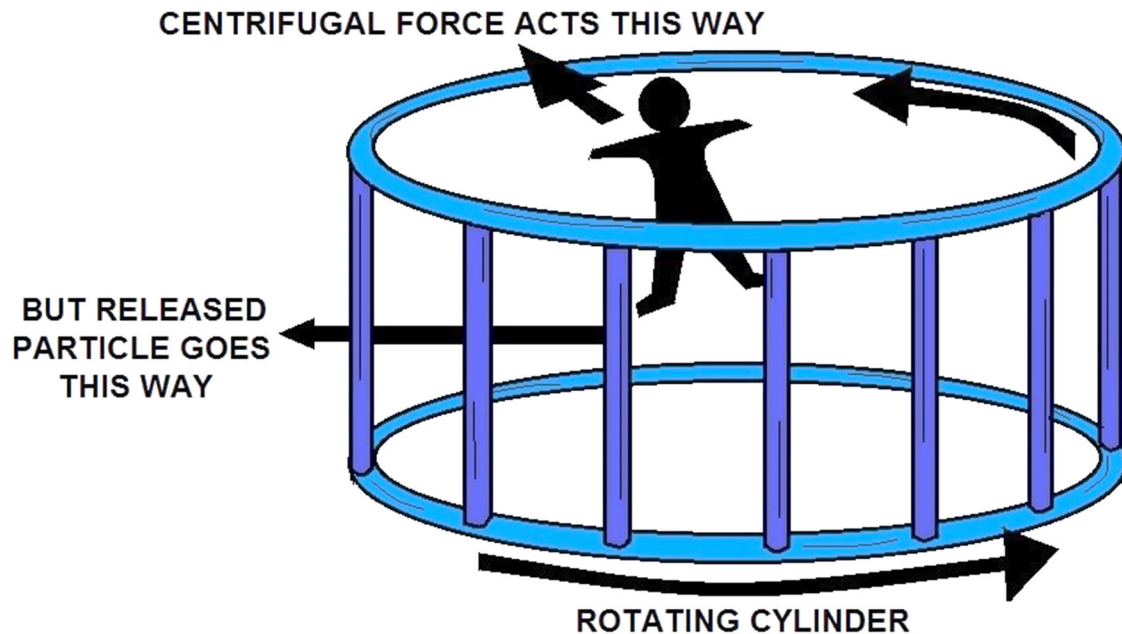

CENTRIFUGAL WATER EFFECT IN ACTION DIAGRAM

First, you can view the water between the impeller blades as an object traveling in a circle. Objects do not naturally travel in a circle--they need an inward force to cause them to accelerate inward as they spin. Without such an inward force, an object will travel in a straight line and will not complete the circle. In a centrifugal pump, that inward force is provided by high-pressure water near the outer edge of the pump housing.

The water at the edge of the pump pushes inward on the water between the impeller blades and makes it possible for that water to travel in a circle. The water pressure at the edge of the turning impeller rises until it is able to keep water circling with the impeller blades.

You can also view the water as an incompressible fluid, one that obeys Bernoulli's equation in the appropriate contexts. As water drifts outward between the impeller blades of the pump, it must move faster and faster because its circular path is getting larger and larger. The impeller blades cause the water to move faster and faster. By the time the water has reached the outer edge of the impeller, it is moving quite fast. However, when the water leaves the impeller and arrives at the outer edge of the cylindrical pump housing, it slows down because of the loss of energy.



Bernoulli's Equation

Glenn
Research
Center

Restrictions :

- Inviscid
- Steady
- Incompressible (low velocity)
- No heat addition.
- Negligible change in height.

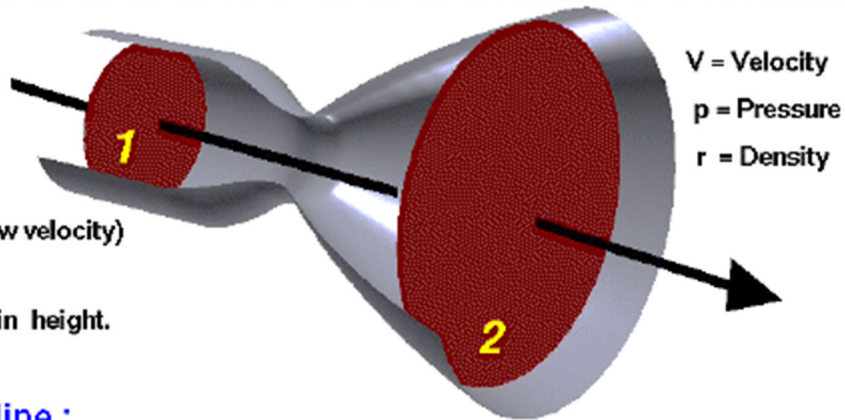

Along a streamline :

static pressure + dynamic pressure = total pressure

$$p_s + \frac{rV^2}{2} = p_t$$

$$\left(p_s + \frac{rV^2}{2} \right)_1 = \left(p_s + \frac{rV^2}{2} \right)_2$$

Here is where Bernoulli's equation figures in. As the water slows down and its kinetic energy decreases, that water's pressure potential energy increases (*to conserve energy*). Thus, the slowing is accompanied by a pressure rise. That is why the water pressure at the outer edge of the pump housing is higher than the water pressure near the center of the impeller. When water is actively flowing through the pump, arriving through a hole near the center of the impeller and leaving through a hole near the outer edge of the pump housing, the pressure rise between center and edge of the pump is not as large.

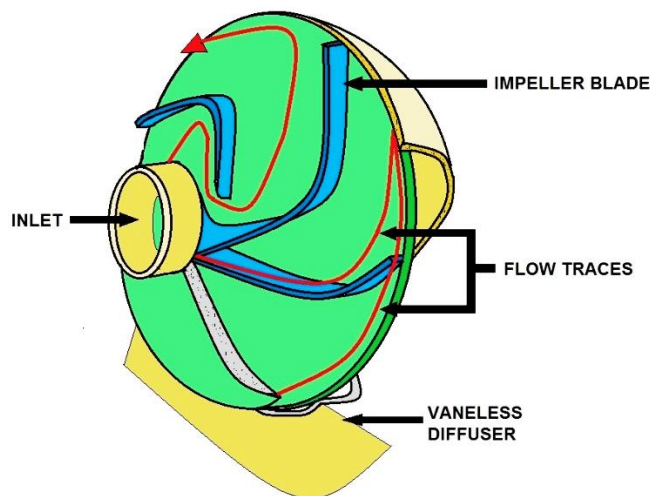

COMMON PUMP IMPELLER

Three Types of Water Pumps

The most common type of water pumps used for municipal and domestic water supplies are *dynamic pumps* or also referred to as *variable displacement pumps*. A variable displacement pump will produce at different rates relative to the amount of pressure or lift the pump is working against. *Centrifugal* pumps are variable displacement pumps that are by far used the most. The water production well industry almost exclusively uses *Turbine* pumps, which are a type of centrifugal pump.

Turbine Pump

The turbine pump utilizes *impellers* enclosed in single or multiple *bowls or stages* to lift water by *centrifugal force*. The impellers may be of either a *semi-open or closed type*. Impellers are rotated by the *pump motor*, which provides the horsepower needed to overcome the pumping head. A more thorough discussion of how these and other pumps work is presented later in this section. The size and number of stages, horsepower of the motor and pumping head are the key components relating to the pump's lifting capacity.

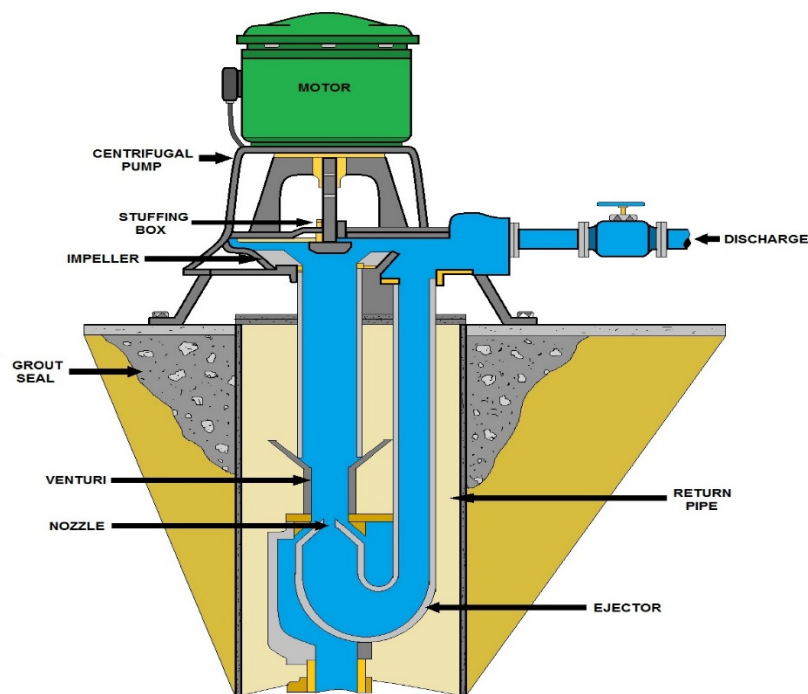

VERTICAL TURBINE INSTALLATION DIAGRAM

Vertical Turbine Pump

Vertical turbine pumps are commonly used in groundwater wells but also in many other applications. These pumps are driven by a shaft rotated by a motor that is usually on the surface. The shaft turns the impellers within the pump housing while the water moves up the column.

This type of pumping system is also called a *line-shaft turbine*. The rotating shaft in a line shaft turbine is actually housed within the column pipe that delivers the water to the surface. The size of the column, impeller, and bowls are selected based on the desired pumping rate and lift requirements.

Column pipe sections can be threaded or coupled together while the drive shaft is coupled and suspended within the column by *spider bearings*. The spider bearings provide both a seal at the column pipe joints and keep the shaft aligned within the column. The water passing through the column pipe serves as the lubricant for the bearings. Some vertical turbines are lubricated by oil rather than water. These pumps are essentially the same as water lubricated units; only the drive shaft is enclosed within an *oil tube*.

Food grade oil is supplied to the tube through a gravity feed system during operation. The oil tube is suspended within the column by *spider flanges*, while the line shaft is supported within the oil tube by *brass or redwood bearings*. A continuous supply of oil lubricates the drive shaft as it proceeds downward through the oil tube.

A small hole located at the top of the pump bow unit allows excess oil to enter the well. This results in the formation of an oil film on the water surface within oil-lubricated wells. Careful operation of oil lubricated turbines is needed to ensure that the pumping levels do not drop enough to allow oil to enter the pump. Both water and oil lubricated turbine pump units can be driven by electric or fuel powered motors.

Most installations use an electric motor that is connected to the drive shaft by a keyway and nut. However, where electricity is not readily available, fuel powered engines may be connected to the drive shaft by a right angle drive gear. Also, both oil and water lubricated systems will have a strainer attached to the intake to prevent sediment from entering the pump.

When the line shaft turbine is turned off, water will flow back down the column, turning the impellers in a reverse direction. A pump and shaft can easily be broken if the motor were to turn on during this process. This is why a *time delay* or *ratchet* assembly is often installed on these motors to either prevent the motor from turning on before reverse rotation stops or simply not allow it to reverse at all.

Three Main Types of Diaphragm Pumps

In the first type, the diaphragm is sealed with one side in the fluid to be pumped, and the other in air or hydraulic fluid. The diaphragm is flexed, causing the volume of the pump chamber to increase and decrease. A pair of non-return check valves prevents reverse flow of the fluid.

Volumetric Positive Displacement

The second type of diaphragm pump also works with volumetric positive displacement, but differs in that the prime mover of the diaphragm is neither oil nor air; but is electro-mechanical, working through a crank or geared motor drive. This method flexes the diaphragm through simple mechanical action, and one side of the diaphragm is open to air. The third type of diaphragm pump has one or more unsealed diaphragms with the fluid to be pumped on both sides.

The diaphragm(s) again are flexed, causing the volume to change. When the volume of a chamber of either type of pump is increased (the diaphragm moving up), the pressure decreases, and fluid is drawn into the chamber.

When the chamber pressure later increases from decreased volume (the diaphragm moving down), the fluid previously drawn in is forced out. Finally, the diaphragm moving up once again draws fluid into the chamber, completing the cycle. This action is similar to that of the cylinder in an internal combustion engine.

Cavitation

Cavitation is defined as the phenomenon of formation of vapor bubbles of a flowing liquid in a region where the pressure of the liquid falls below its vapor pressure. Cavitation is usually divided into two classes of behavior: inertial (or transient) cavitation and non-inertial cavitation. Inertial cavitation is the process where a void or bubble in a liquid rapidly collapses, producing a shock wave.

Such cavitation often occurs in pumps, propellers, impellers, and in the vascular tissues of plants. Non-inertial cavitation is the process in which a bubble in a fluid is forced to oscillate in size or shape due to some form of energy input, such as an acoustic field. Such cavitation is often employed in ultrasonic cleaning baths and can also be observed in pumps, propellers etc.

Cavitation is, in many cases, an undesirable occurrence. In devices such as propellers and pumps, cavitation causes a great deal of noise, damage to components, vibrations, and a loss of efficiency. When the cavitation bubbles collapse, they force liquid energy into very small volumes, thereby creating spots of high temperature and emitting shock waves, the latter of which are the source of a rattling noise.

The noise created by cavitation is a particular problem for military submarines, as it increases the chances of being detected by passive sonar. Although the collapse of a cavity is a relatively low-energy event, highly localized collapses can erode metals, such as steel, over time. The pitting caused by the collapse of cavities produces great wear on components and can dramatically shorten a propeller's or pump's lifetime. After a surface is initially affected by cavitation, it tends to erode at an accelerating pace.

The cavitation pits increase the turbulence of the fluid flow and create crevasses that act as nucleation sites for additional cavitation bubbles. The pits also increase the component's surface area and leave behind residual stresses. This makes the surface more prone to stress corrosion.

Impeller

An impeller is a rotating component of a centrifugal pump, usually made of iron, steel, aluminum or plastic, which transfers energy from the motor that drives the pump to the fluid being pumped by accelerating the fluid outwards from the center of rotation.

The velocity achieved by the impeller transfers into pressure when the outward movement of the fluid is confined by the pump casing. Impellers are usually short cylinders with an open inlet (called an eye) to accept incoming fluid, vanes to push the fluid radially, and a splined center to accept a driveshaft.

Factor	Dynamic (Centrifugal) Pump	Positive Displacement Pump
Mechanics	Impellers pass on velocity from the motor to the liquid which helps move the fluid to the discharge port (produces flow by creating pressure).	Traps confined amounts of liquid and forces it from the suction to the discharge port (produces pressure by creating flow).
Performance	Flow rate varies with a change in pressure.	Flow rate remains constant with a change in pressure.
Viscosity	Flow rate rapidly decreases with increasing viscosity, even any moderate thickness, due to frictional losses inside the pump.	Due to the internal clearances high viscosities are handled easily and flow rate increases with increasing viscosity.
Efficiency	Efficiency peaks at a specific pressure; any variations decrease efficiency dramatically. Does not operate well when run off the middle of the curve; can cause damage and cavitation.	Efficiency is less affected by pressure, but if anything tends to increase as pressure increases. Can be run at any point on their curve without damage or efficiency loss.
Suction Lift	Standard models cannot create suction lift, although self-priming designs are available and manometric suction lift is possible through a non-return valve on the suction line.	Create a vacuum on the inlet side, making them capable of creating suction lift.
Shearing	High-speed motor leads to shearing of liquids. Not good for shear sensitive mediums.	Low internal velocity means little shear is applied to the pumped medium. Ideal for shear sensitive fluids.

Submersible Pump

Introduction

Submersible pumps are in essence very similar to turbine pumps. They both use impellers rotated by a shaft within the bowls to pump water. However, the pump portion is directly connected to the motor.

The pump shaft has a keyway in which the splined motor end shaft inserts. The water-tight motor is bolted to the pump housing. The pump's intake is located between the motor and the pump and is normally screened to prevent sediment from entering the pump and damaging the impellers.

The efficient cooling of submersible motors is very important, so these types of pumps are often installed such that flow through the well screen can occur upwards past the motor and into the intake. If the motor end is inserted below the screened interval or below all productive portions of the aquifer, it will not be cooled, resulting in premature motor failure.

Some pumps may have *pump shrouds* installed on them to force all the water to move past the motor to prevent overheating.

The shroud is a piece of pipe that attaches to the pump housing with an open end below the motor. As with turbine pumps, the size of the bowls and impellers, number of stages, and horsepower of the motor are adjusted to achieve the desired production rate within the limitations of the pumping head.



Insertion of motor spline into the pump keyway.

Left- Cut away of a small turbine pump without the motor.

Key Pump Words

NPSH: Net positive suction head - related to how much suction lift a pump can achieve by creating a partial vacuum. Atmospheric pressure then pushes liquid into the pump. A method of calculating if the pump will work or not in a given application.

S.G.: Specific gravity. The weight of liquid in comparison to water at approx. 20 degrees C, when it has a SG = 1.

Specific Speed: A number which is the function of pump flow, head, efficiency etc. Not used in day to day pump selection, but very useful, as pumps with similar specific speed will have similar shaped curves, similar efficiency / NPSH / solids handling characteristics.

Vapor Pressure: If the vapor pressure of a liquid is greater than the surrounding air pressure, the liquid will boil.

Viscosity: A measure of a liquid's resistance to flow. i.e.: how thick it is. The viscosity determines the type of pump used, the speed it can run at, and with gear pumps, the internal clearances required.

Friction Loss: The amount of pressure / head required to 'force' liquid through pipe and fittings.

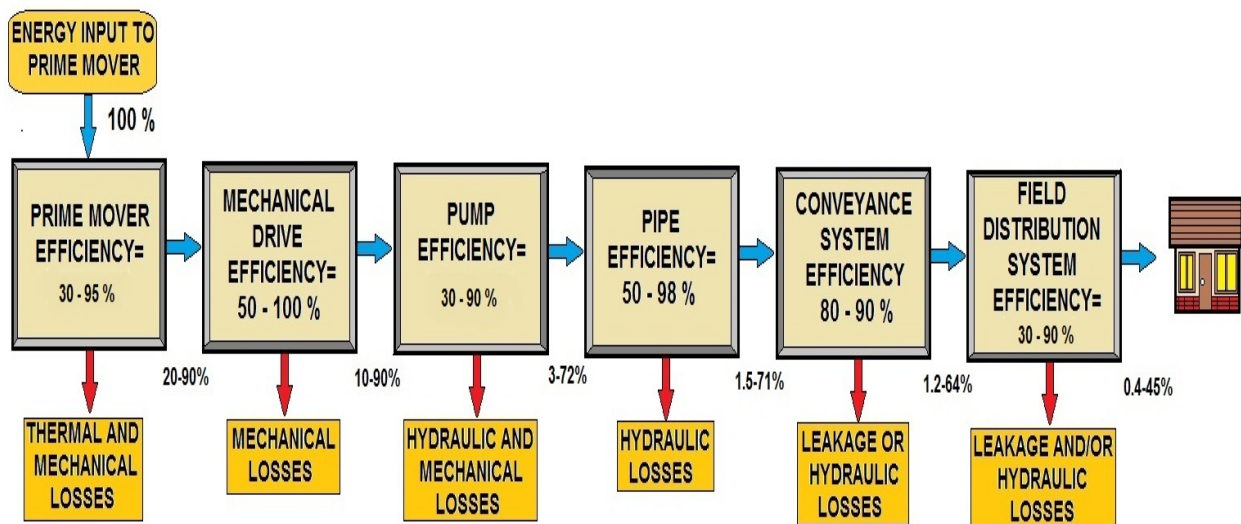

SYSTEM ENERGY EFFICIENCY LOSSES DIAGRAM

Centrifugal Pump Sub-Section

By definition, a centrifugal pump is a machine, a machine that imparts energy to a fluid. This energy infusion can cause a liquid to flow, rise to a higher level, or both.

The centrifugal pump is an extremely simple machine. It is a member of a family known as rotary machines and consists of two basic parts: 1) the rotary element or impeller and 2) the stationary element or casing (volute). The figure at the bottom of the page is a cross section of a centrifugal pump and shows the two basic parts.

In operation, a centrifugal pump “slings” liquid out of the impeller via centrifugal force. One fact that must always be remembered: A pump does not create pressure, it only provides flow. Pressure is just an indication of the amount of resistance to flow.

Centrifugal pumps may be classified in several ways. For example, they may be either SINGLE STAGE or MULTI-STAGE. A single-stage pump has only one impeller. A multi-stage pump has two or more impellers housed together in one casing.

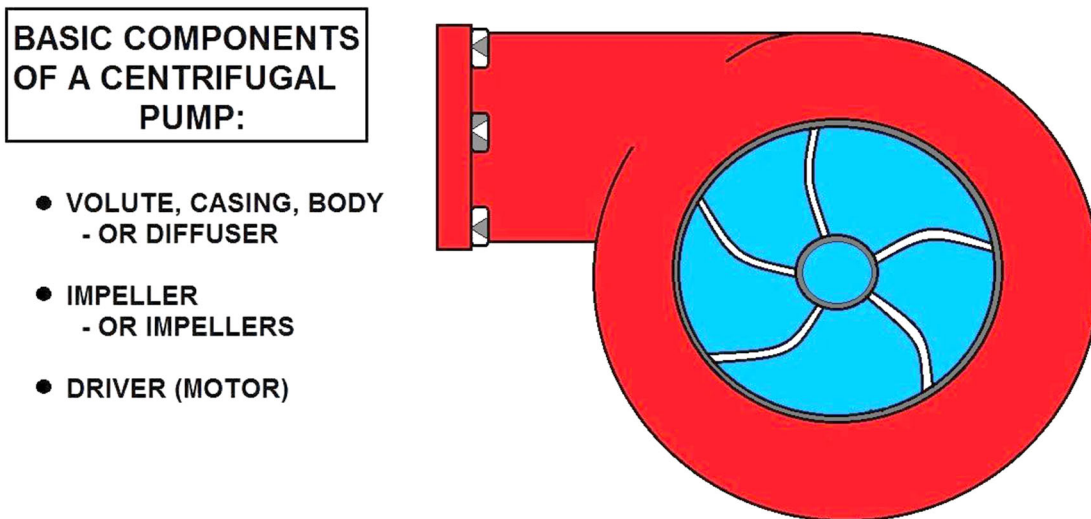

BASICS OF A CENTRIFUGAL PUMP

As a rule, each impeller acts separately, discharging to the suction of the next stage impeller. This arrangement is called series staging. Centrifugal pumps are also classified as horizontal or vertical, depending upon the position of the pump shaft.

Impellers

The impellers used on centrifugal pumps may be classified as *single suction* or *double suction*. The single-suction impeller allows liquid to enter the eye from one side only. The double-suction impeller allows liquid to enter the eye from two directions.

Impellers are also classified as *closed* or *open*. Closed impellers have side walls that extend from the eye to the outer edge of the vane tips. Open impellers do not have these side walls. Some small pumps with single-suction impellers have only a casing wearing ring and no impeller ring. In this type of pump, the casing wearing ring is fitted into the end plate.

Recirculation lines are installed on some centrifugal pumps to prevent the pumps from overheating and becoming vapor bound, in case the discharge is entirely shut off or the flow of fluid is stopped for extended periods.

Seal piping is installed to cool the shaft and the packing, to lubricate the packing, and to seal the rotating joint between the shaft and the packing against air leakage. A lantern ring spacer is inserted between the rings of the packing in the stuffing box.

Seal piping leads the liquid from the discharge side of the pump to the annular space formed by the lantern ring. The web of the ring is perforated so that the water can flow in either direction along the shaft (between the shaft and the packing).

Water flinger rings are fitted on the shaft between the packing gland and the pump bearing housing. These flingers prevent water in the stuffing box from flowing along the shaft and entering the bearing housing.

Look at the components of the centrifugal pump.

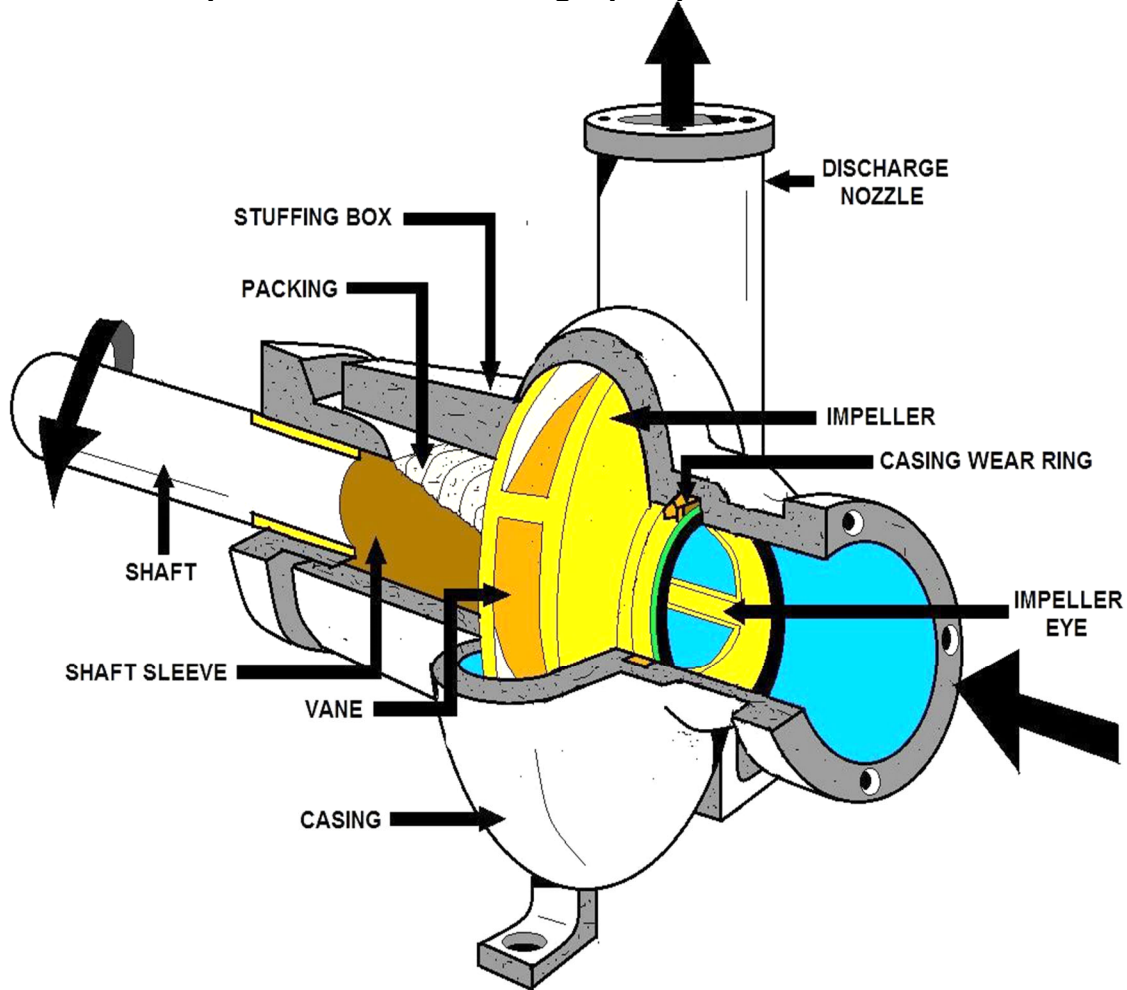

CENTRIFUGAL PUMP BREAKDOWN DIAGRAM #1

As the impeller rotates, it sucks the liquid into the center of the pump and throws it out under pressure through the outlet. The casing that houses the impeller is referred to as the volute, the impeller fits on the shaft inside. The volute has an inlet and outlet that carries the water as shown below.

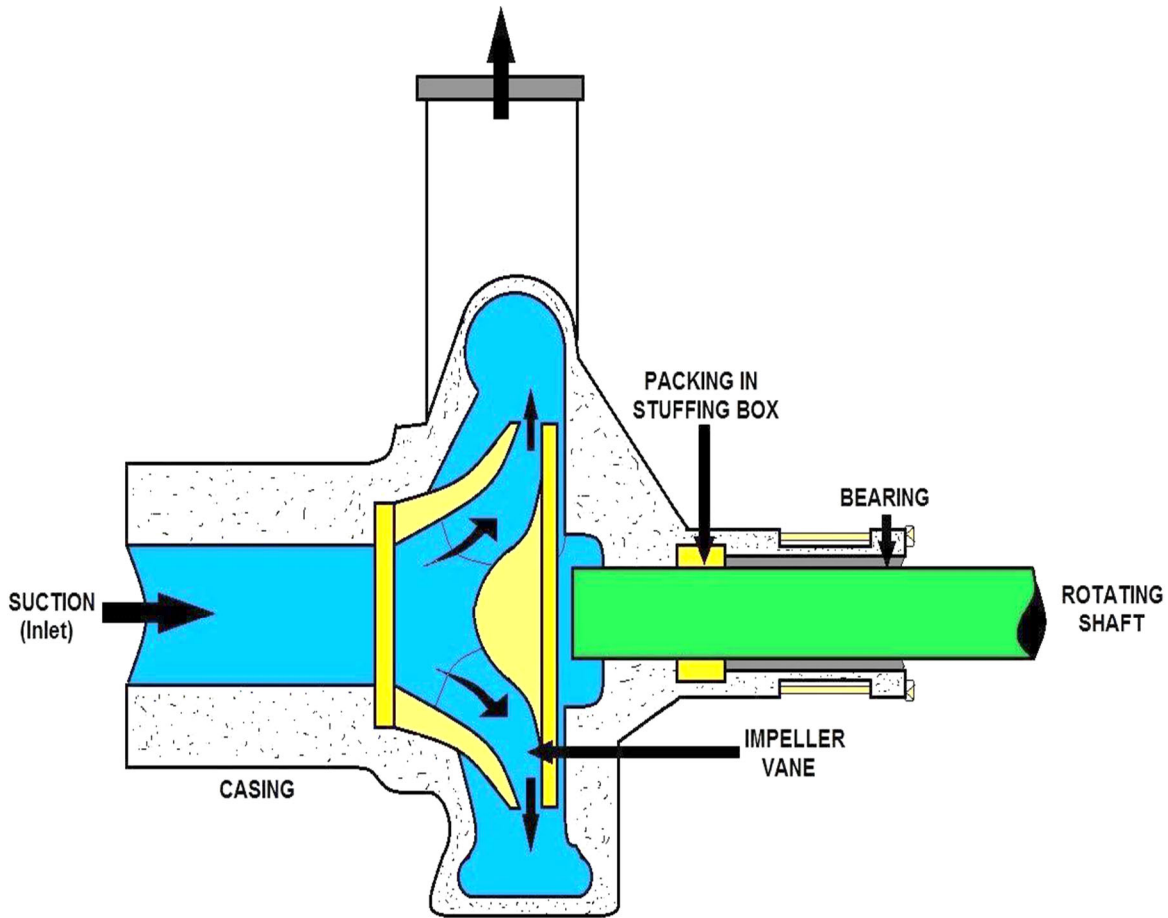

CENTRIFUGAL PUMP BREAKDOWN DIAGRAM #2

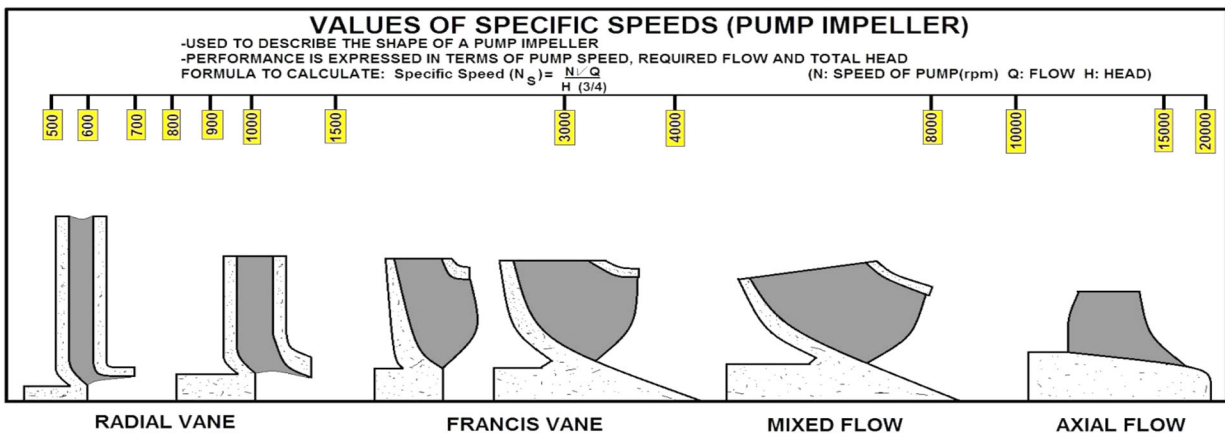

IMPELLER SPECIFIC SPEEDS - IMPELLER VANE CROSS SECTION

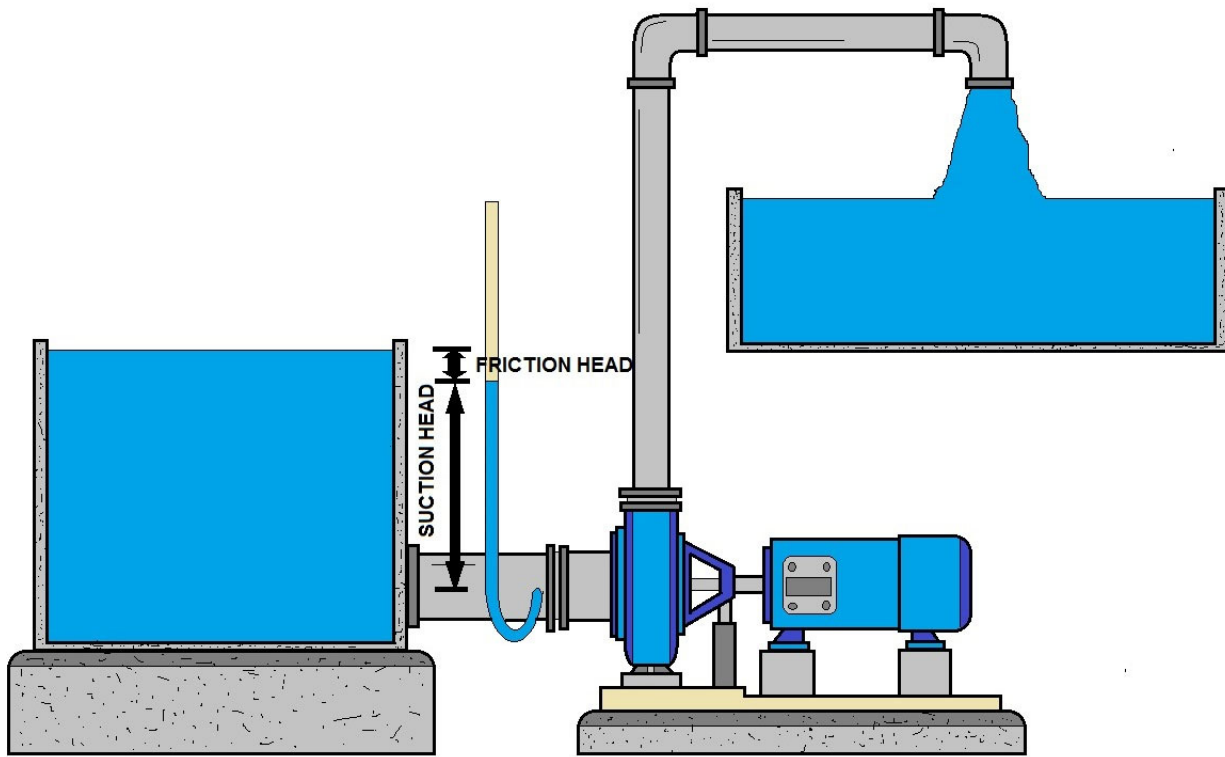

SUCTION HEAD (Suction Lift)

Vertical Turbine Pump Sub-Section

Vertical turbine pumps are available in deep well, shallow well, or canned configurations. VHS or VSS motors will be provided to fulfill environmental requirements. Submersible motors are also available. These pumps are also suitable industrial, municipal, commercial and agricultural applications.

Deep well turbine pumps are adapted for use in cased wells or where the water surface is below the practical limits of a centrifugal pump. Turbine pumps are also used with surface water systems. Since the intake for the turbine pump is continuously under water, priming is not a concern. Turbine pump efficiencies are comparable to, or greater than most centrifugal pumps. They are usually more expensive than centrifugal pumps and more difficult to inspect and repair. The turbine pump has three main parts: (1) the head assembly, (2) the shaft and column assembly and (3) the pump bowl assembly. The head is normally cast iron and designed to be installed on a foundation. It supports the column, shaft, and bowl assemblies, and provides a discharge for the water. It also will support an electric motor, a right angle gear drive or a belt drive.

Bowl Assembly

The bowl assembly is the heart of the vertical turbine pump. The impeller and diffuser type casing is designed to deliver the head and capacity that the system requires in the most efficient way. Vertical turbine pumps can be multi-staged, allowing maximum flexibility both in the initial pump selection and in the event that future system modifications require a change in the pump rating. The submerged impellers allow the pump to be started without priming. The discharge head changes the direction of flow from vertical to horizontal, and couples the pump to the system piping, in addition to supporting and aligning the driver.

Drivers

A variety of drivers may be used; however, electric motors are most common. For the purposes of this manual, all types of drivers can be grouped into two categories:

1. Hollow shaft drivers where the pump shaft extends through a tube in the center of the rotor and is connected to the driver by a clutch assembly at the top of the driver.
2. Solid shaft drivers where the rotor shaft is solid and projects below the driver mounting base. This type of driver requires an adjustable flanged coupling for connecting to the pump.

Discharge Head Assembly

The discharge head supports the driver and bowl assembly as well as supplying a discharge connection (the “NUF” type discharge connection which will be located on one of the column pipe sections below the discharge head). A shaft sealing arrangement is located in the discharge head to seal the shaft where it leaves the liquid chamber. The shaft seal will usually be either a mechanical seal assembly or stuffing box.

Column Assembly

The shaft and column assembly provides a connection between the head and pump bowls. The line shaft transfers the power from the motor to the impellers and the column carries the water to the surface. The line shaft on a turbine pump may be either water lubricated or oil lubricated.

The oil-lubricated pump has an enclosed shaft into which oil drips, lubricating the bearings. The water-lubricated pump has an open shaft. The bearings are lubricated by the pumped water. If there is a possibility of fine sand being pumped, select the oil lubricated pump because it will keep the sand out of the bearings. If the water is for domestic or livestock use, it must be free of oil and a water-lubricated pump must be used.

Line shaft bearings are commonly placed on 10-foot centers for water-lubricated pumps operating at speeds under 2,200 RPM and at 5-foot centers for pumps operating at higher speeds. Oil-lubricated bearings are commonly placed on 5-foot centers.

A pump bowl encloses the impeller. Due to its limited diameter, each impeller develops a relatively low head. In most deep well turbine installations, several bowls are stacked in series one above the other. This is called staging. A four-stage bowl assembly contains four impellers, all attached to a common shaft and will operate at four times the discharge head of a single-stage pump.

Impellers used in turbine pumps may be either semi-open or enclosed. The vanes on semi-open impellers are open on the bottom and they rotate with a close tolerance to the bottom of the pump bowl. The tolerance is critical and must be adjusted when the pump is new.

During the initial break-in period the line shaft couplings will tighten, therefore, after about 100 hours of operation, the impeller adjustments should be checked. After break-in, the tolerance must be checked and adjusted every three to five years or more often if pumping sand.

Column assembly is of two basic types, either of which may be used:

1. Open line shaft construction utilizes the fluid being pumped to lubricate the line shaft bearings.
2. Enclosed line shaft construction has an enclosing tube around the line shaft and utilizes oil, grease or injected liquid (usually clean water) to lubricate the line shaft bearings.

Column assembly will consist of:

- 1) column pipe, which connects the bowl assembly to the discharge head,
- 2) shaft, connecting the bowl shaft to the driver and,
- 3) may contain bearings, if required, for the particular unit. Column pipe may be either threaded or flanged.

Note: Some units will not require column assembly, having the bowl assembly connected directly to the discharge head instead.

Bowl Assemblies

The bowl consists of:

- 1) impellers rigidly mounted on the bowl shaft, which rotate and impart energy to the fluid,
- 2) bowls to contain the increased pressure and direct the fluid,
- 3) suction bell or case which directs the fluid into the first impeller, and
- 4) bearings located in the suction bell (or case) and in each bowl.

Both types of impellers may cause inefficient pump operation if they are not properly adjusted. Mechanical damage will result if the semi-open impellers are set too low and the vanes rub against the bottom of the bowls. The adjustment of enclosed impellers is not as critical; however, they must still be checked and adjusted.

Impeller adjustments are made by tightening or loosening a nut on the top of the head assembly. Impeller adjustments are normally made by lowering the impellers to the bottom of the bowls and adjusting them upward.

The amount of upward adjustment is determined by how much the line shaft will stretch during pumping. The adjustment must be made based on the lowest possible pumping level in the well. The proper adjustment procedure is often provided by the pump manufacturer.

Vertical Turbine Pump



Large Diameter Submersible Pump, Motor, and Column Pipe

Larger check valve installed on submersible pump to prevent water hammer (notice motor shaft splines.)

Common Elements of Vertical Turbines

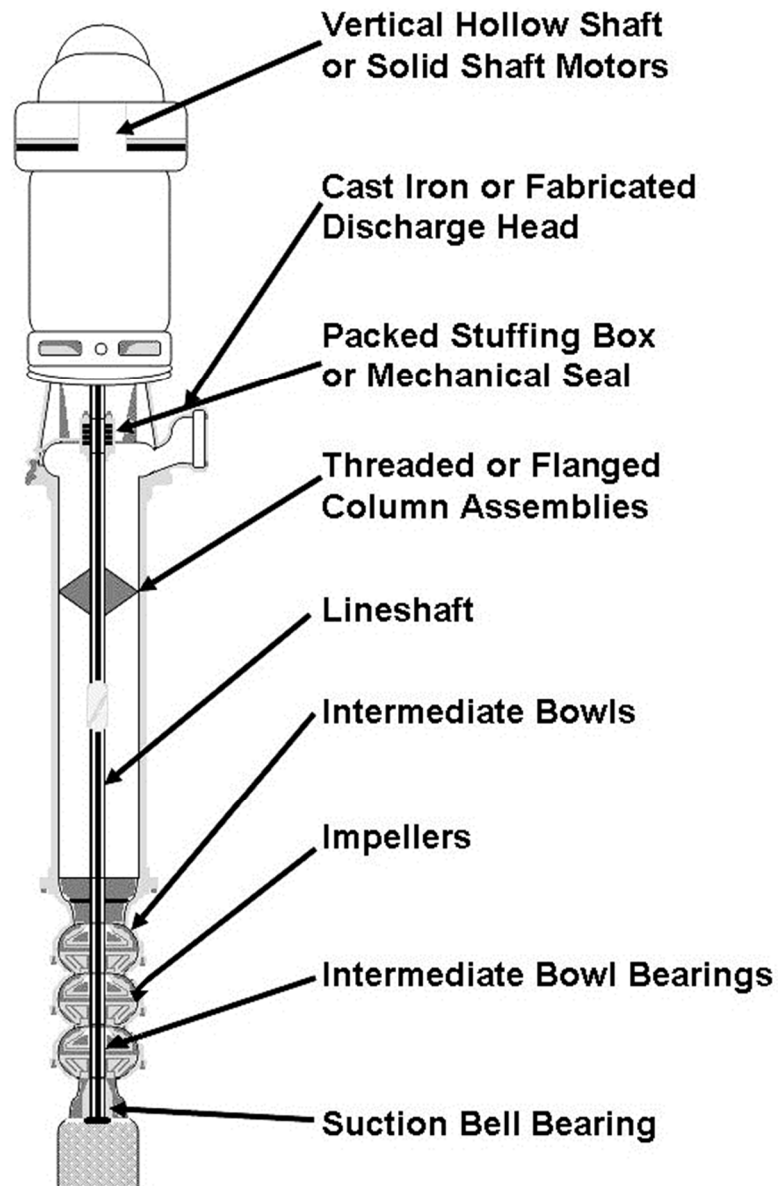

Below - A Small Closed Pump Impeller



Pump Performance and Curves

Let's look at the big picture. Before you make that purchase of the pump and motor you need to know the basics such as:

- Total dynamic head, the travel distance
- Capacity, how much water you need to provide
- Efficiency, help determine the impeller size
- HP, how many squirrels you need
- RPM, how fast the squirrels run

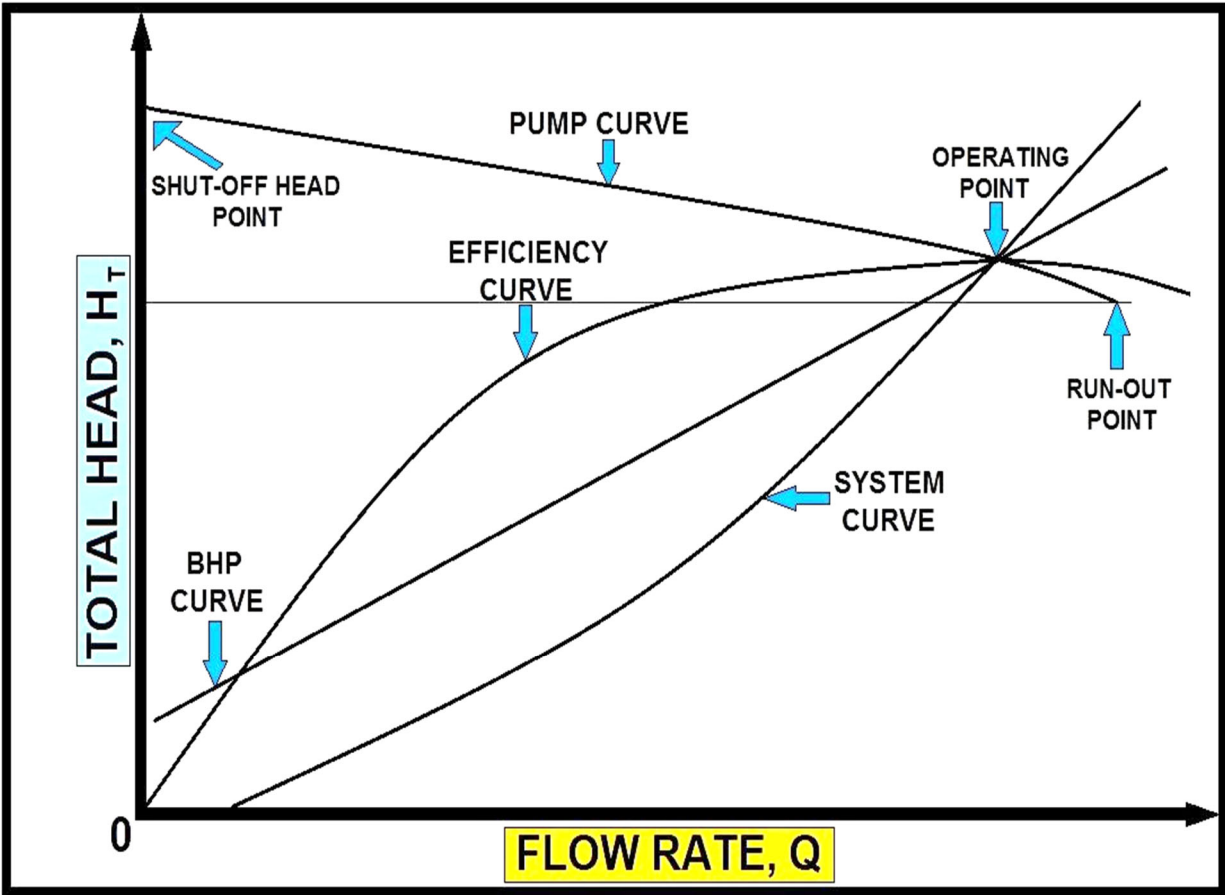

PUMP PERFORMANCE CURVE (CENTRIFUGAL PUMP)

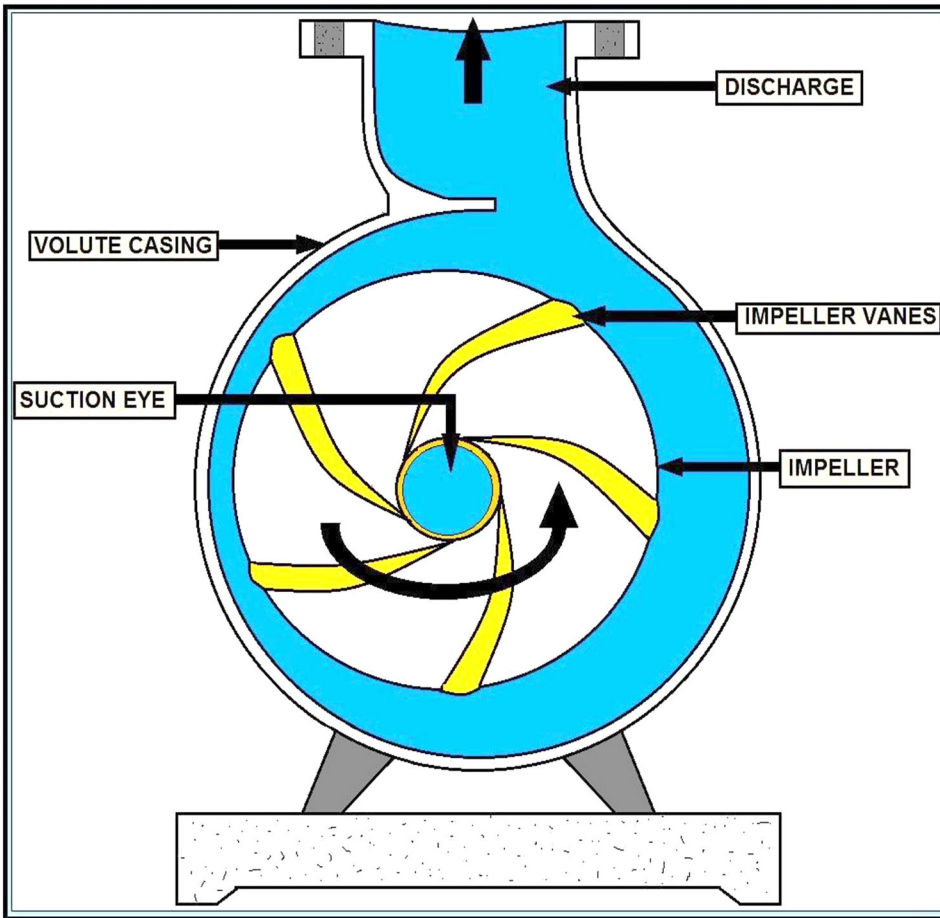

- LIQUID FORCED INTO IMPELLER
- VANES PASS KINETIC ENERGY TO LIQUID BEING PUMPED: LIQUID IS ROTATED AND LEAVES THE IMPELLER
- VOLUTE CASING CONVERTS THE KINETIC ENERGY INTO PRESSURE ENERGY

HOW A CENTRIFUGAL PUMP WORKS

Motor and Pump Calculations

The centrifugal pump pumps the difference between the suction and the discharge heads. There are three kinds of discharge head:

- **Static head.** The height we are pumping to or the height to the discharge piping outlet that is filling the tank from the top. Note: that if you are filling the tank from the bottom, the static head will be constantly changing.
- **Pressure head.** If we are pumping to a pressurized vessel (like a boiler) we must convert the pressure units (psi. or Kg.) to head units (feet or meters).
- **System or dynamic head.** Caused by friction in the pipes, fittings, and system components. We get this number by making the calculations from published charts.

Suction head is measured the same way.

- If the liquid level is above the pump center line, that level is a positive suction head. If the pump is lifting a liquid level from below its center line, it is a negative suction head.
- If the pump is pumping liquid from a pressurized vessel, you must convert this pressure to a positive suction head. A vacuum in the tank would be converted to a negative suction head.
- Friction in the pipes, fittings, and associated hardware is a negative suction head.
- Negative suction heads are added to the pump discharge head, positive suction heads are subtracted from the pump discharge head.

Total Dynamic Head (TDH) is the total height that a fluid is to be pumped, taking into account friction losses in the pipe.

$$\text{TDH} = \text{Static Lift} + \text{Static Height} + \text{Friction Loss}$$

where:

Static Lift is the height the water will rise before arriving at the pump (also known as the 'suction head').

Static Height is the maximum height reached by the pipe after the pump (also known as the 'discharge head').

Friction Loss is the head equivalent to the energy losses due to viscose drag of fluid flowing in the pipe (both on the suction and discharge sides of the pump). It is calculated via a formula or a chart, taking into account the pipe diameter and roughness and the fluid flow rate, density, and viscosity.

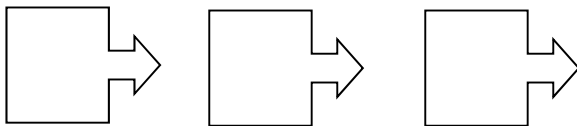

Motor hp

Brake hp

Water hp

Horsepower

Work involves the operation of force over a specific distance. The rate of doing work is called power.

The rate in which a horse could work was determined to be about 550 ft-lbs./sec or 33,000 ft-lbs./min.

$$1 \text{ hp} = 33,000 \text{ ft-lbs./min}$$

Motor Horsepower (mhp)

$$1 \text{ hp} = 746 \text{ watts or } .746 \text{ Kilowatts}$$

MHP refers to the horsepower supplied in the form of electrical current. The efficiency of most motors range from 80-95%. (Manufacturers will list efficiency %)

Brake Horsepower (bhp)

$$\text{Brake hp} = \frac{\text{Water hp}}{\text{Pump Efficiency}}$$

BHP refers to the horsepower supplied to the pump from the motor. As the power moves through the pump, additional horsepower is lost, resulting from slippage and friction of the shaft and other factors.

Water Horsepower

$$\text{Water hp} = \frac{(\text{flow gpm})(\text{total hd})}{3960}$$

Water horsepower refers to the actual horse power available to pump the water.

Horsepower and Specific Gravity

The specific gravity of a liquid is an indication of its density or weight compared to water. The difference in specific gravity, include it when calculating ft-lbs./min pumping requirements.

$$\frac{(\text{ft})(\text{lbs./min})(\text{sp.gr.})}{33,000 \text{ ft-lbs./min/hp}} = \text{whp}$$

MHP and Kilowatt requirements

$$1 \text{ hp} = 0.746 \text{ kW or } \frac{(\text{hp}) (746 \text{ watts/hp})}{1000 \text{ watts/kW}}$$

Well Calculations

1. Well drawdown

Drawdown ft = Pumping water level, ft - Static water level, ft

2. Well yield

Well yield, gpm = $\frac{\text{Flow, gallons}}{\text{Duration of test, min}}$

3. Specific yield

Specific yield, gpm/ft = $\frac{\text{Well yield, gpm}}{\text{Drawdown, ft}}$

4. Deep well turbine pump calculations.

Discharge head, ft = (pressure measured) (2.31 ft/psi)

Field head, ft = pumping water + discharge head, ft

Bowl head, ft = field head + column friction

1 psi = 2.31 feet of head

1 foot of head = .433 psi

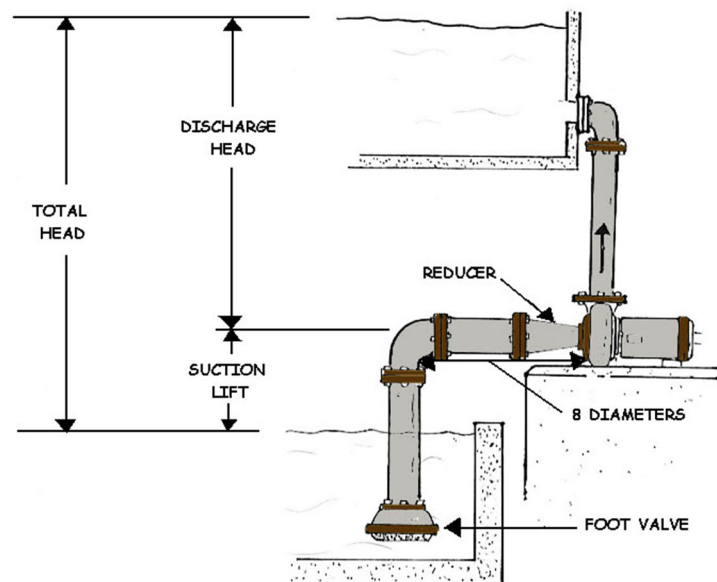

Example 1

A centrifugal pump is located at an elevation of 722 ft. This pump is used to move water from reservoir **A** to reservoir **B**. The water level in reservoir **A** is 742 ft and the water level in reservoir **B** is 927 ft. Based on these conditions answer the following questions:

- 1. If the pump is not running and pressure gauges are installed on the suction and discharge lines, what pressures would the gauges read?**

Suction side:

Discharge side:

- 2. How can you tell if this is a suction head condition?**
- 3. Calculate the following head measurements:**

SSH:

SDH:

TSH:

- 4. Convert the pressure gauge readings to feet:**

6 psi:

48 psi:

110 psi:

- 5. Calculate the following head in feet to psi:**

20 ft:

205 ft:

185 ft:

NPSH - Net Positive Suction Head

A pump creates a partial vacuum and atmospheric pressure forces water into the suction of the pump, and NPSH describes the concept. NPSH(r) is the Net Positive Suction Head Required by the pump, which is read from the pump performance curve. (Think of NPSH(r) as friction loss caused by the entry to the pump suction.)

NPSH (a) is the Net Positive Suction Head Available, which is calculated as follows:

$$\text{NPSH (a)} = p + s - v - f$$

Where:

'p'= atmospheric pressure,

's'= static suction (If liquid is below pump, it is shown as a negative value)

'v'= liquid vapor pressure

'f'= friction loss

NPSH (a) must exceed NPSH(r) to allow pump operation without cavitation. (It is advisable to allow approximately 1 meter difference for most installations.) The other important fact to remember is that water will boil at much less than 100 deg C^o if the pressure acting on it is less than its vapor pressure, i.e. water at 95 deg C is just hot water at sea level, but at 1500m above sea level it is boiling water and vapor.

The vapor pressure of water at 95 degrees C is 84.53 kPa, there was enough atmospheric pressure at sea level to contain the vapor, but once the atmospheric pressure is dropped at a higher elevation, the vapor is able to escape. This is why vapor pressure is always considered in NPSH calculations when temperatures exceed 30 to 40 degrees C.

Suction Lift

Suction conditions are some of the most important factors affecting centrifugal pump operation. If they are ignored during the design or installation stages of an application, they will probably come back to haunt you.

A pump cannot pull or "suck" a liquid up its suction pipe because liquids do not exhibit tensile strength. Therefore, they cannot transmit tension or be pulled. When a pump creates a suction, it is simply reducing local pressure by creating a partial vacuum. Atmospheric or some other external pressure acting on the surface of the liquid pushes the liquid up the suction pipe into the pump.

Atmospheric pressure at sea level is called absolute pressure (PSIA) because it is a measurement using absolute zero (a perfect vacuum) as a base. If pressure is measured using atmospheric pressure as a base it is called gauge pressure (PSIG or simply PSI).

Atmospheric pressure, as measured at sea level, is 14.7 PSIA. In feet of head it is:

$$\text{Head} = \text{PSI} \times 2.31 / \text{Specific Gravity}$$

For Water it is:

$$\text{Head} = 14.7 \times 2.31 / 1.0 = 34 \text{ Ft}$$

Thus, 34 feet is the theoretical maximum suction lift for a pump pumping cold water at sea level. No pump can attain a suction lift of 34 ft; however, well designed ones can reach 25 ft quite easily.

You will note, from the equation above, that specific gravity can have a major effect on suction lift. For example, the theoretical maximum lift for brine (Specific Gravity = 1.2) at sea level is 28 ft. The realistic maximum is around 20ft. Remember to always factor in specific gravity if the liquid being pumped is anything but clear, cold (68 degrees F) water.

In addition to pump design and suction piping, there are two physical properties of the liquid being pumped that affect suction lift:

1) Maximum suction lift is dependent upon the pressure applied to the surface of the liquid at the suction source. Maximum suction lift decreases as pressure decreases.

2) Maximum suction lift is dependent upon the vapor pressure of the liquid being pumped. The vapor pressure of a liquid is the pressure necessary to keep the liquid from vaporizing (boiling) at a given temperature. Vapor pressure increases as liquid temperature increases. Maximum suction lift decreases as vapor pressure rises.

It follows then, that the maximum suction lift of a centrifugal pump varies inversely with altitude. Conversely, maximum suction lift will increase as the external pressure on its source increases (for example: a closed pressure vessel).

Cavitation - Two Main Causes:

A. NPSH (r) EXCEEDS NPSH (a)

Due to low pressure the water vaporizes (boils), and higher pressure implodes into the vapor bubbles as they pass through the pump, causing reduced performance and potentially major damage.

B. Suction or discharge recirculation. The pump is designed for a certain flow range, if there is not enough or too much flow going through the pump, the resulting turbulence and vortexes can reduce performance and damage the pump.

Affinity Laws

The Centrifugal Pump is a very capable and flexible machine. Because of this it is unnecessary to design a separate pump for each job. The performance of a centrifugal pump can be varied by changing the impeller diameter or its rotational speed. Either change produces approximately the same results. Reducing impeller diameter is probably the most common change and is usually the most economical. The speed can be altered by changing pulley diameters or by changing the speed of the driver. In some cases both speed and impeller diameter are changed to obtain the desired results.

When the driven speed or impeller diameter of a centrifugal pump changes, operation of the pump changes in accordance with three fundamental laws. These laws are known as the "Laws of Affinity". They state that:

- 1) Capacity varies directly as the change in speed
- 2) Head varies as the square of the change in speed
- 3) Brake horsepower varies as the cube of the change in speed

If, for example, the pump speed were doubled:

- 1) Capacity will double
- 2) Head will increase by a factor of 4 (2 to the second power)
- 3) Brake horsepower will increase by a factor of 8 (2 to the third power)

These principles apply regardless of the direction (up or down) of the speed or change in diameter.

Consider the following example. A pump operating at 1750 RPM, delivers 210 GPM at 75' TDH, and requires 5.2 brake horsepower. What will happen if the speed is increased to 2000 RPM? First we find the speed ratio.

$$\text{Speed Ratio} = 2000/1750 = 1.14$$

From the Laws of Affinity:

1) Capacity varies directly or:
 $1.14 \times 210 \text{ GPM} = 240 \text{ GPM}$

2) Head varies as the square or:
 $1.14 \times 1.14 \times 75 = 97.5' \text{ TDH}$

3) BHP varies as the cube or:
 $1.14 \times 1.14 \times 1.14 \times 5.2 = 7.72 \text{ BHP}$

Theoretically the efficiency is the same for both conditions. By calculating several points a new curve can be drawn.

Whether it be a speed change or change in impeller diameter, the Laws of Affinity give results that are approximate. The discrepancy between the calculated values and the actual values obtained in test are due to hydraulic efficiency changes that result from the modification. The Laws of Affinity give reasonably close results when the changes are not more than 50% of the original speed or 15% of the original diameter.

Affinity Laws - Centrifugal Pumps

If the speed or impeller diameter of a pump changes, we can calculate the resulting performance change using:

Affinity laws

- a. The flow changes proportionally to speed
i.e.: double the speed / double the flow
- b. The pressure changes by the square of the difference
i.e.: double the speed / multiply the pressure by 4
- c. The power changes by the cube of the difference
i.e.: double the speed / multiply the power by 8

Notes:

1. These laws apply to operating points at the same efficiency.
2. Variations in impeller diameter greater than 10% are hard to predict due to the change in relationship between the impeller and the casing. For rough calculations you can adjust a duty point or performance curve to suit a different speed. NPSH (r) is affected by speed / impeller diameter change = **DANGER!**

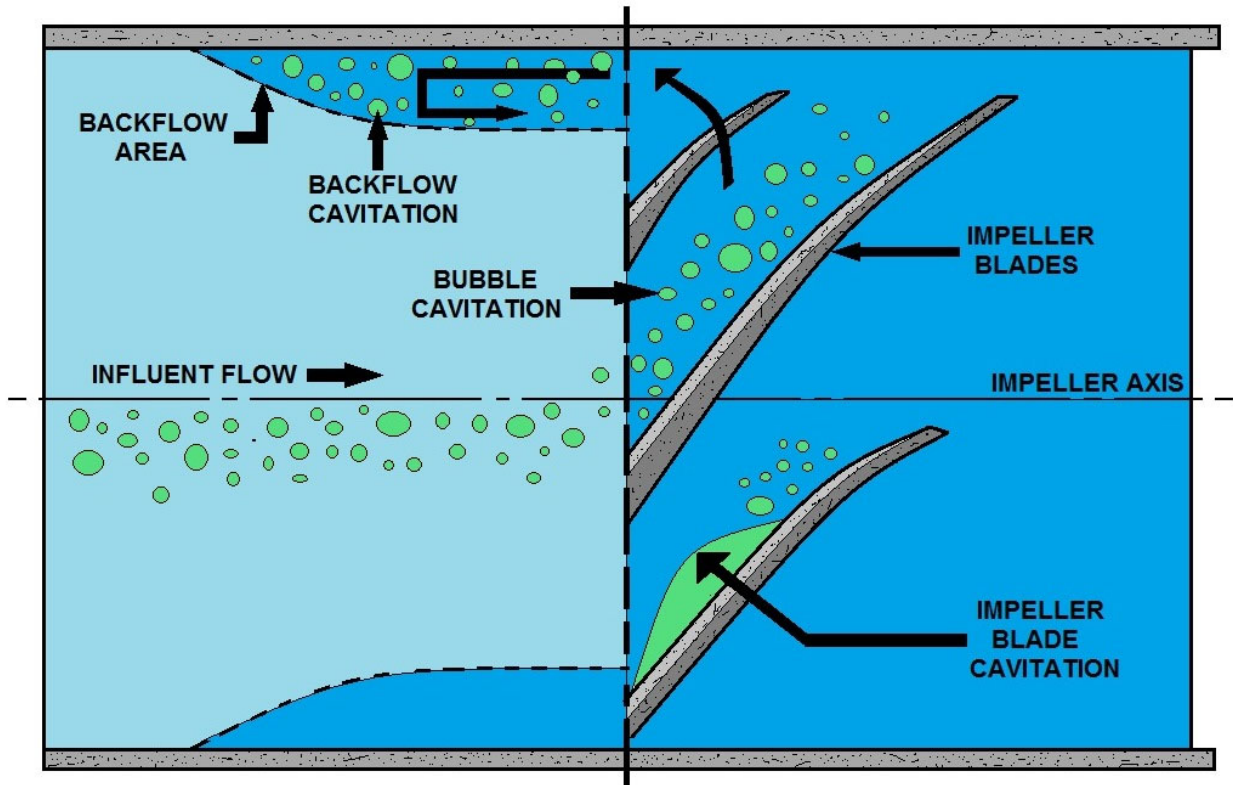

PUMP CAVITATION

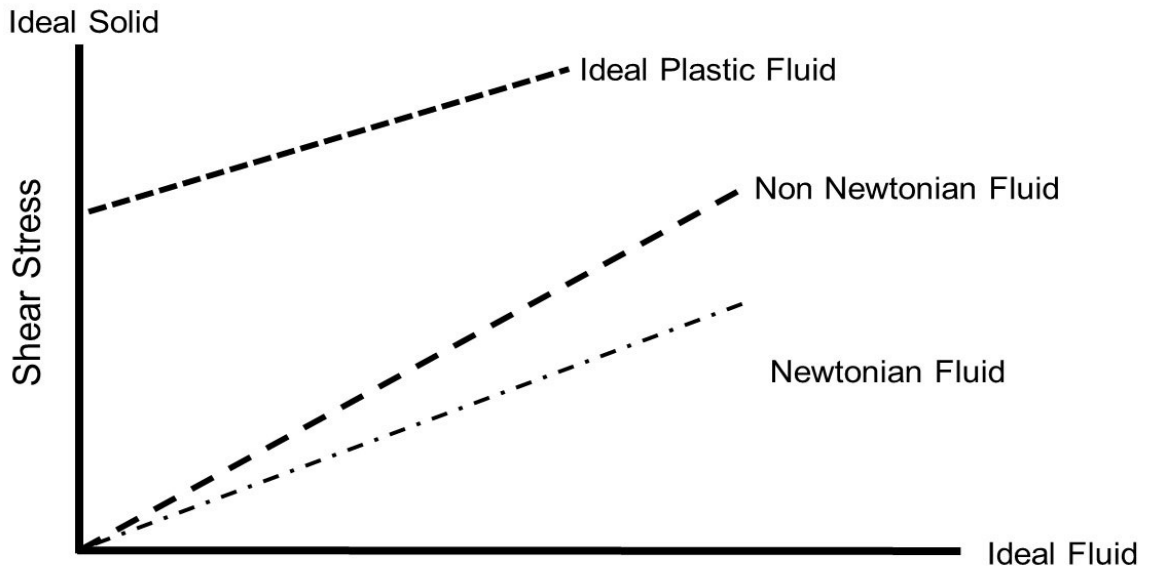

VELOCITY GRADIENT

Pump Casing Sub-Section

There are many variations of centrifugal pumps. The most common type is an end suction pump. Another type of pump used is the split case. There are many variations of split case, such as; two-stage, single suction, and double suction. Most of these pumps are horizontal.

There are variations of vertical centrifugal pumps. The line shaft turbine is really a multistage centrifugal pump.

Impeller

In most centrifugal pumps, the impeller looks like a number of cupped vanes on blades mounted on a disc or shaft. Notice in the picture below how the vanes of the impeller force the water into the outlet of the pipe.

The shape of the vanes of the impeller is important. As the water is being thrown out of the pump, this means you can run centrifugal pumps with the discharged valve closed for a **SHORT** period of time. Remember the motor sends energy along the shaft, and if the water is in the volute too long it will heat up and create steam. Not good!

Impellers are designed in various ways. We will look at:

- Closed impellers
- Semi-open impellers
- Opened impellers, and
- Recessed impellers

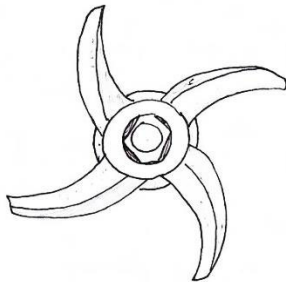

OPEN

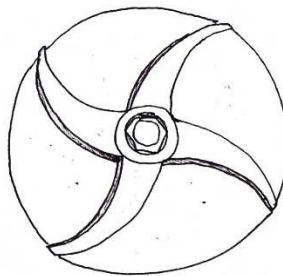

SEMI-OPEN

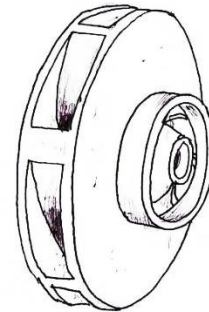

CLOSED

IMPELLER TYPES

The impellers all cause a flow from the eye of the impeller to the outside of the impeller. These impellers cause what is called radial flow, and they can be referred to as radial flow impellers.

The critical distance of the impeller and how it is installed in the casing will determine if it is high volume / low pressure or the type of liquid that could be pumped.

Axial flow impellers look like a propeller and create a flow that is parallel to the shaft.

Packing Seals



PUMP PACKING BOX WITH ADJUSTMENT LOCK NUTS

How can we prevent the water from leaking along the shaft?

A special seal is used to prevent liquid leaking out along the shaft. There are two types of seals commonly used:

- **Packing seal**
- **Mechanical seal**

Leakage

During pump operation, a certain amount of leakage around the shafts and casings normally takes place.

This leakage must be controlled for two reasons:

- (1) to prevent excessive fluid loss from the pump, and
- (2) to prevent air from entering the area where the pump suction pressure is below atmospheric pressure.

The amount of leakage that can occur without limiting pump efficiency determines the type of shaft sealing selected. Shaft sealing systems are found in every pump. They can vary from simple packing to complicated sealing systems.

Packing is the most common and oldest method of sealing. Leakage is checked by the compression of packing rings that causes the rings to deform and seal around the pump shaft and casing.

The packing is lubricated by liquid moving through a lantern ring in the center of the packing. The sealing slows down the rate of leakage. It does not stop it completely, since a certain amount of leakage is necessary during operation. Mechanical seals are rapidly replacing conventional packing on centrifugal pumps.

Some of the reasons for the use of mechanical seals are as follows:

1. Leaking causes bearing failure by contaminating the oil with water. This is a major problem in engine-mounted water pumps.
2. Properly installed mechanical seals eliminate leakoff on idle (vertical) pumps. This design prevents the leak (water) from bypassing the water flinger and entering the lower bearings.

Leakoff causes two types of seal leakage:

- a. Water contamination of the engine lubrication oil.
- b. Loss of treated fresh water that causes scale buildup in the cooling system.

Lantern Rings

Lantern rings are used to supply clean water along the shaft. This helps to prevent grit and air from reaching the area. Another component is the slinger ring. The slinger ring is an important part of the pump because it is used to protect the bearings. Other materials can be used to prevent this burier.

Wear Rings

Not all centrifugal pumps have wear rings. However, when they are included, they are usually replaceable. Wear rings can be located on the suction side and head side of the volute. Wear rings could be made of the same metal but of different alloys. The wear ring on the head side is usually a harder alloy. It's called a "WEAR RING" and what would be the purpose?



Finger is shown pointing to a Lantern Ring. This old school method of sealing a pump is still out there. Notice the packing on both sides of the ring. The packing joints need to be staggered and the purpose of this device is to allow pressurized cooling water to the Stuffing Box.

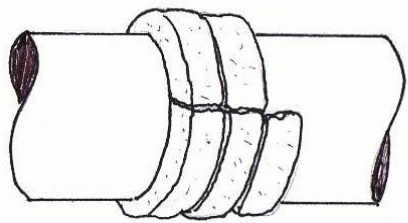

INCORRECT
(butt joint)

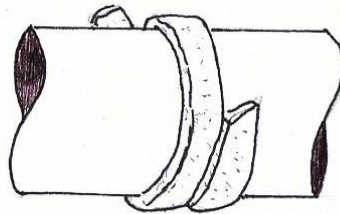

CORRECT
(skive joint)
(stagger @ 45 degree angle)

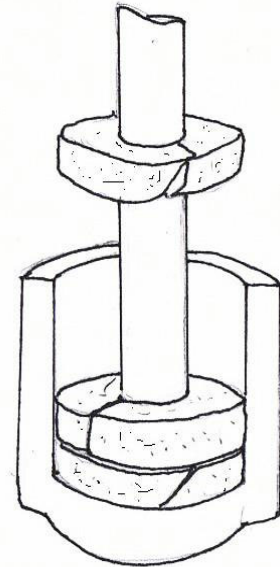

Skive Packing Procedure

Install one ring at a time: Make sure it is clean, and has not picked up any dirt in handling. If desired, lubricate the shaft inside of the stuffing box. Seat rings firmly (except PTFE filament and Graphite yarn packing, which should be snugged up very gently, then tightened gradually after the pump is on stream). Joints of successive rings should be staggered and kept at least 90° apart. Each individual ring should be firmly seated with a tamping tool. When enough rings have been individually seated so that the nose of the gland will reach them, individual tamping should be supplemented by the gland.

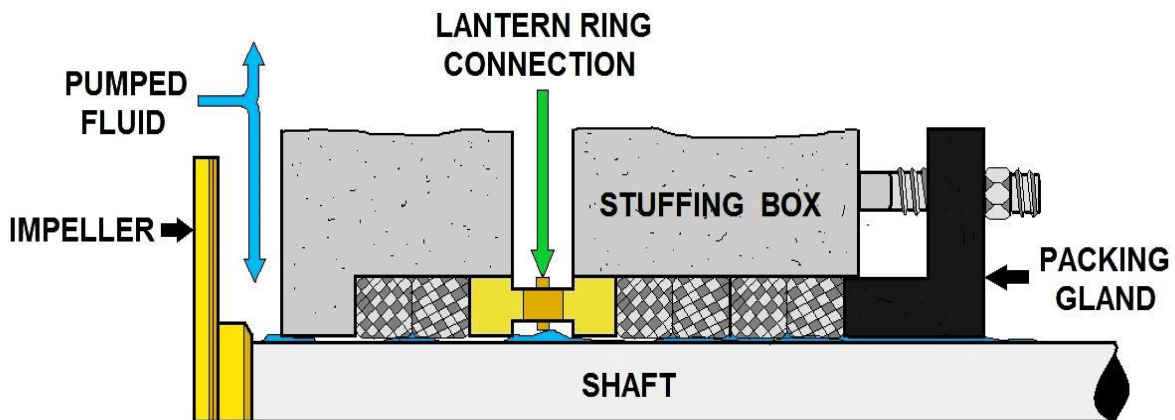

LANTERN RING BETWEEN PACKING FOR COOL / CLEAN FLUID BARRIER

Mechanical Seals

Mechanical seals are rapidly replacing conventional packing as the means of controlling leakage on rotary and positive-displacement pumps. Mechanical seals eliminate the problem of excessive stuffing box leakage, which causes failure of pump and motor bearings and motor windings.

Mechanical Seals

There are many types of mechanical seals. The photograph below illustrates the basic components of a mechanical seal. Similar to the packing seal, clean water is fed at a pressure greater than that of the liquid being pumped. There is little or no leakage through the mechanical seal. The wearing surface must be kept extremely clean. Even fingerprints on the wearing surface can introduce enough dirt to cause problems.

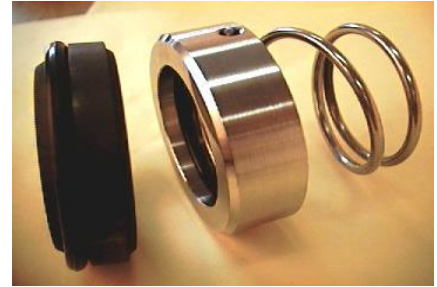

MECHANICAL SEALS

Mechanical seals are ideal for pumps that operate in closed systems (such as fuel service and air-conditioning, chilled-water, and various cooling systems). They not only conserve the fluid being pumped, but also improve system operation.

The type of material used for the seal faces will depend upon the service of the pump. Most water service pumps use a carbon material for one of the seal faces and ceramic (tungsten carbide) for the other. When the seals wear out, they are simply replaced.

You should replace a mechanical seal whenever the seal is removed from the shaft for any reason, or whenever leakage causes undesirable effects on equipment or surrounding spaces. Do not touch a new seal on the sealing face because body acid and grease or dirt will cause the seal to pit prematurely and leak.

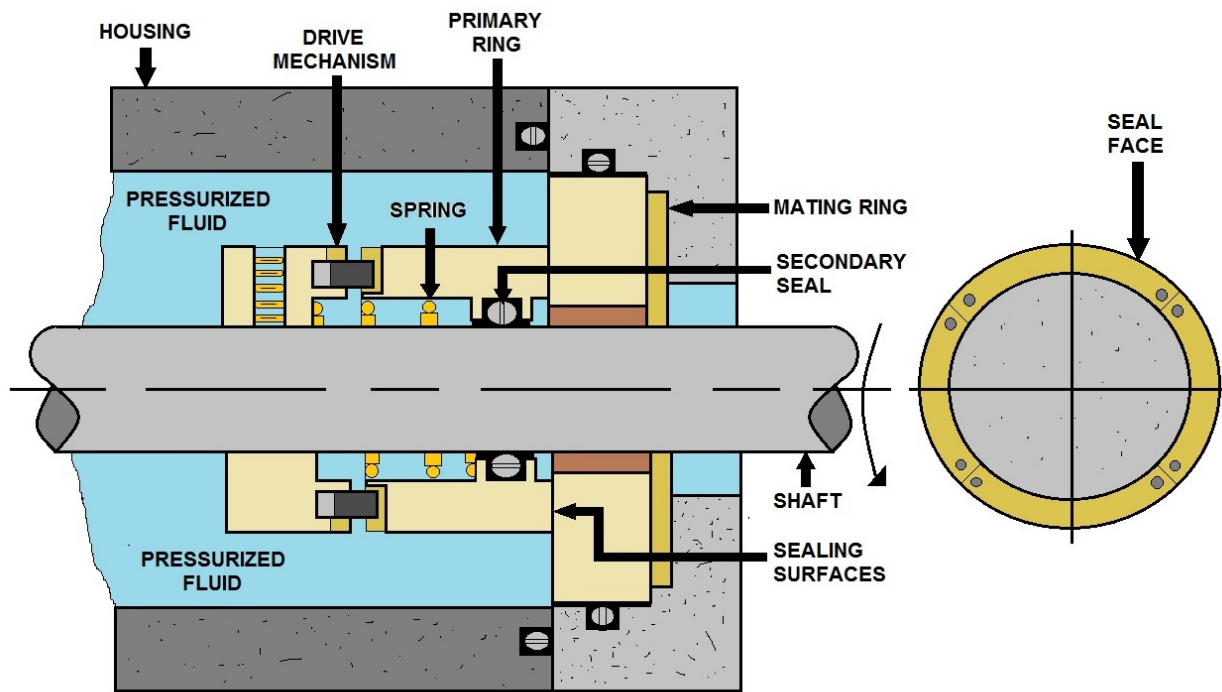

MECHANICAL SEAL

Stub or Step Sleeves

Mechanical shaft seals are positioned on the shaft by stub or step sleeves. Mechanical shaft seals must not be positioned by setscrews. Shaft sleeves are chamfered (beveled) on the outboard ends for easy mechanical seal mounting.

Mechanical shaft seals serve to ensure that position liquid pressure is supplied to the seal faces under all conditions of operation. They also ensure adequate circulation of the liquid at the seal faces to minimize the deposit of foreign matter on the seal parts.

Coupling Sub-Section

The pump coupling serves two main purposes:

- It couples or joins the two shafts together to transfer the rotation from motor to impeller.
- It compensates for small amounts of misalignment between the pump and the motor.

Remember that any coupling is a device in motion. If you have a 4-inch diameter coupling rotating at 1800 rpm, its outer surface is traveling about 20 mph. With that in mind, can you think of safety considerations?

There are three commonly used types of couplings: **Rigid, Flexible and V-belts.**

Rigid Coupling

Rigid couplings are most commonly used on vertically mounted pumps. The rigid coupling is usually specially keyed or constructed for joining the coupling to the motor shaft and the pump shaft. There are two types of rigid couplings: the flanged coupling, and the split coupling.

Flexible Coupling

The flexible coupling provides the ability to compensate for small shaft misalignments. Shafts should be aligned as close as possible, regardless. The greater the misalignment, the shorter the life of the coupling. Bearing wear and life are also affected by misalignment.

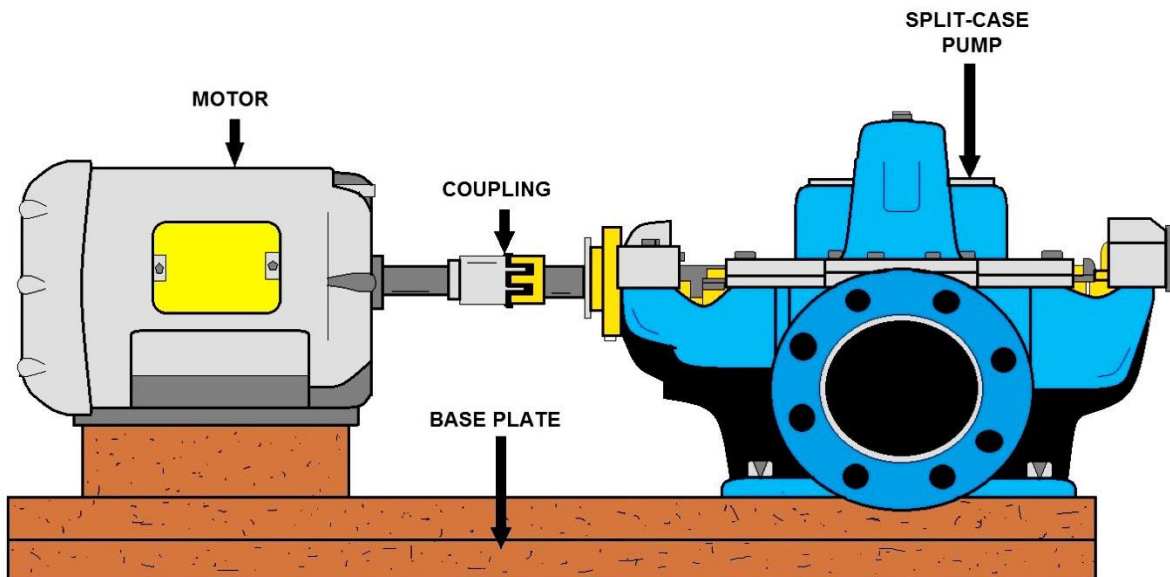

FLEXIBLE COUPLED PUMP AND MOTOR

Alignment of Flexible and Rigid Couplings

Both flexible and rigid couplings must be carefully aligned before they are connected.

Misalignment will cause excessive heat and vibration, as well as bearing wear. Usually, the noise from the coupling will warn you of shaft misalignment problems.

Three types of shaft alignment problems are shown in the pictures below:



ANGULAR MISALIGNMENT



ANGULAR AND PARALLEL



PARALLEL MISALIGNMENT

Different couplings will require different alignment procedures. We will look at the general procedures for aligning shafts.

1. Place the coupling on each shaft.
2. Arrange the units so they appear to be aligned. (Place shims under the legs of one of the units to raise it.)
3. Check the run-out, or difference between the driver and driven unit, by rotating the shafts by hand.
4. Turn both units so that the maximum run-out is on top.

Now you can check the units for both parallel and angular alignment. Many techniques are used, such as: straight edge, needle deflection (dial indicators), calipers, tapered wedges, and laser alignment.

V-Belt Drive Couplings

V-belt drives connect the pump to the motor. A pulley is mounted on the pump and motor shaft. One or more belts are used to connect the two pulleys. Sometimes a separately mounted third pulley is used. This idler pulley is located off centerline between the two pulleys, just enough to allow tensioning of the belts by moving the idler pulley. An advantage of driving a pump with belts is that various speed ratios can be achieved between the motor and the pump. Alignment is still important, but less critical using v-belts.

Shaft Bearings

There are three types of bearings commonly used: ball bearings, roller bearings, and sleeve bearings. Regardless of the particular type of bearings used within a system--whether it is ball bearings, a sleeve bearing, or a roller bearing--the bearings are designed to carry the loads imposed on the shaft.

Bearings must be lubricated. Without proper lubrication, bearings will overheat and seize.

Proper lubrication means using the correct type and the correct amount of lubrication. Similar to motor bearings, shaft bearings can be lubricated either by oil or by grease.

Motor Sub-Section

We will now refer to the motor, coupling, and bearings. The power source of the pump is usually an electric motor. The motor is connected by a coupling to the pump shaft. The purpose of the bearings is to hold the shaft firmly in place, yet allow it to rotate. The bearing house supports the bearings and provides a reservoir for the lubricant. An impeller is connected to the shaft. The pump assembly can be a vertical or horizontal set-up; the components for both are basically the same.

Motors

The purpose of this discussion on pump motors is to identify and describe the main types of motors, starters, enclosures, and motor controls, as well as to provide you with some basic maintenance and troubleshooting information. Although pumps may be driven by diesel or gasoline engines, pumps driven by electric motors are commonly used in our industry.

There are two general categories of electric motors:

- ✱ D-C motors, or direct current
- ✱ A-C motors, or alternating current

You can expect most motors at facilities to be A-C type.

D-C Motors

The important characteristic of the D-C motor is that its speed will vary with the amount of current used. There are many different kinds of D-C motors, depending on how they are wound and their speed/torque characteristics.



A-C Motors

There are a number of different types of alternating current motors, such as Synchronous, Induction, wound rotor, and squirrel cage. The synchronous type of A-C motor requires complex control equipment, since they use a combination of A-C and D-C. This also means that the synchronous type of A-C motor is used in large horsepower sizes, usually above 250 HP. The induction type motor uses only alternating current. The squirrel cage motor provides a relatively constant speed. The wound rotor type could be used as a variable speed motor.

Motor Starters

All electric motors, except very small ones such as chemical feed pumps, are equipped with starters, either full voltage or reduced voltage. This is because motors draw a much higher current when they are starting and gaining speed. The purpose of the reduced voltage starter is to prevent the load from coming on until the amperage is low enough.

Motor Enclosures

Depending on the application, motors may need special protection. Some motors are referred to as open motors. They allow air to pass through to remove heat generated when current passes through the windings. Other motors use specific enclosures for special environments or safety protection.



Two Types of Totally Enclosed Motors

- ☞ **TENV**, or totally enclosed non-ventilated motor
- ☞ **TEFC**, or totally enclosed fan cooled motor

Totally enclosed motors include dust-proof, water-proof and explosion-proof motors. An explosion proof enclosure must be provided on any motor where dangerous gases might accumulate.

Motor Controls

All pump motors are provided with some method of control, typically a combination of manual and automatic. Manual pump controls can be located at the central control panel, at the pump, or at the suction or discharge points of the liquid being pumped.

There are a number of ways in which automatic control of a pump motor can be regulated:

- ☞ Pressure and vacuum sensors
- ☞ Preset time intervals
- ☞ Flow sensors
- ☞ Level sensors

Two typical level sensors are the float sensor and the bubble regulator. The float sensor is pear-shaped and hangs in the wet well. As the height increases, the float tilts, and the mercury in the glass tube flows toward the end of the tube that has two wires attached to it. When the mercury covers the wires, it closes the circuit.



For a bubbler level sensor, a low pressure air supply is allowed to escape from a bubbler pipe in the wet well. The back-pressure on the air supply will vary with the liquid level over the pipe. Sensitive air pressure switches will detect this change and use this information to control pump operation.

Motor Maintenance

Motors should be kept clean, free of moisture, and lubricated properly. Dirt, dust, and grime will plug the ventilating spaces and can actually form an insulating layer over the metal surface of the motor.

What condition would occur if the ventilation becomes blocked?



Type of Motor Commutation

Self-Commutated		Externally Commutated		
Mechanical-Commutator Motors		Electronic-Commutator (EC) Motors	Asynchronous Machines	Synchronous Machines
AC	DC	AC	AC	
<ul style="list-style-type: none"> • Universal motor (AC commutator series motor or AC/DC motor) • Repulsion motor 	<p>Electrically excited DC motor:</p> <ul style="list-style-type: none"> • Separately excited • Series • Shunt • Compound <p>PM DC motor</p>	<p>With PM rotor:</p> <ul style="list-style-type: none"> • BLDC motor <p>With ferromagnetic rotor:</p> <ul style="list-style-type: none"> • SRM 	<p>Three-phase motors:</p> <ul style="list-style-type: none"> • SCIM • WRIM <p>AC motors:</p> <ul style="list-style-type: none"> • Capacitor • Resistance • Split • Shaded-pole 	<p>Three-phase motors:</p> <ul style="list-style-type: none"> • WRSM • PMSM or BLAC motor <ul style="list-style-type: none"> ◦ IPMSM ◦ SPMSM • Hybrid <p>AC motors:</p> <ul style="list-style-type: none"> • Permanent-split capacitor • Hysteresis • Stepper • SyRM • SyRM-PM hybrid
Simple electronics	Rectifier, linear transistor(s) or DC chopper	More elaborate electronics	Most elaborate electronics (VFD), when provided	

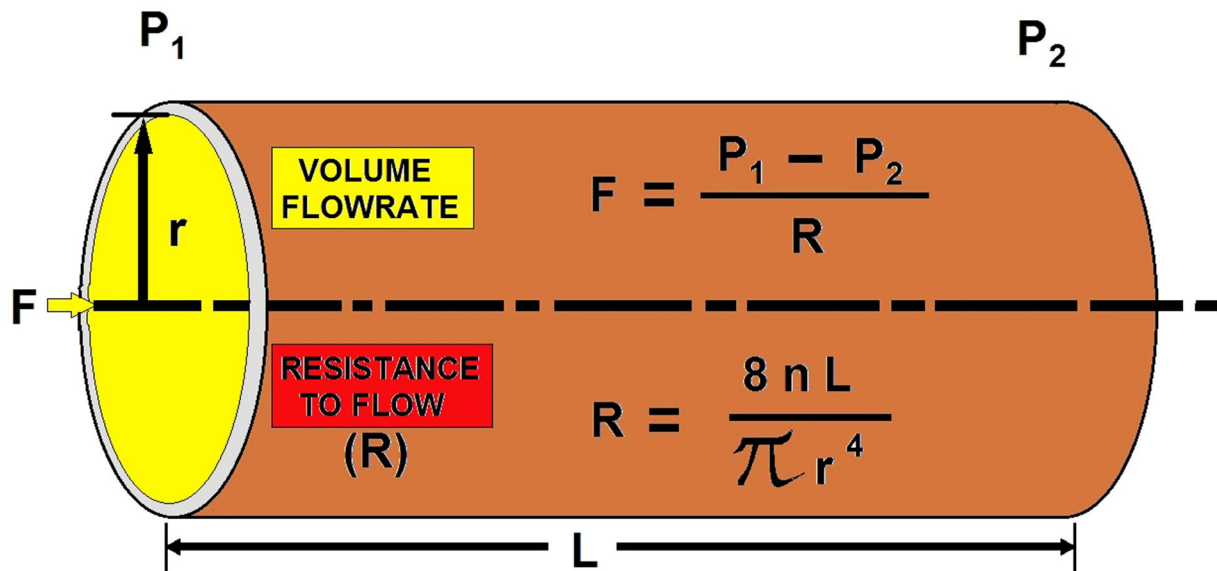

HAGEN-POISEULLE LAW

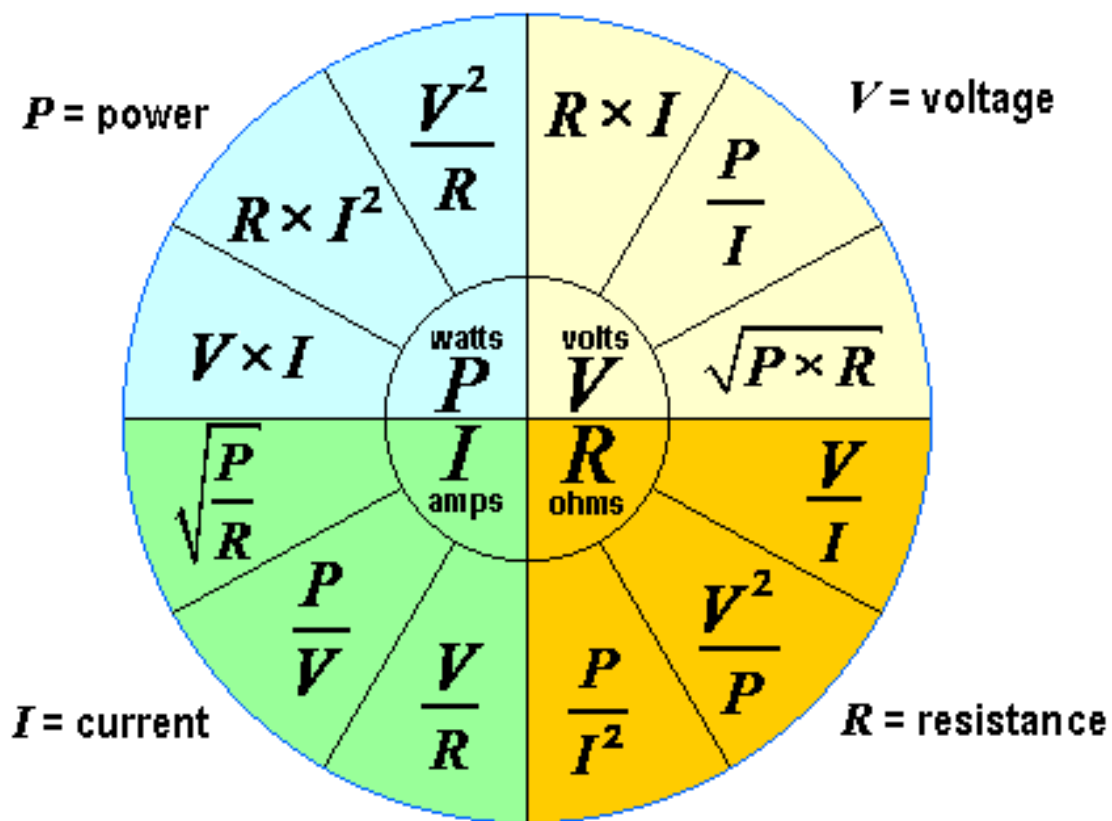

Understanding Motors

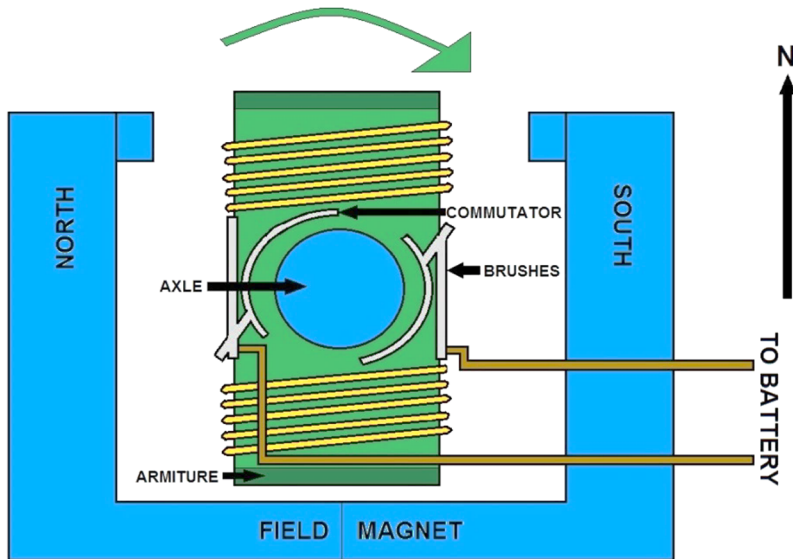

The classic division of electric motors has been that of Direct Current (**DC**) types vs. Alternating Current (**AC**) types. This is more a de facto convention, rather than a rigid distinction. For example, many classic DC motors run happily on AC power.

The ongoing trend toward electronic control further muddles the distinction; as modern drivers have moved the commutator out of the motor shell. For this new breed of motor, driver circuits are relied upon to generate sinusoidal AC drive currents, or some approximation of. The two best examples are: the brushless DC motor and the stepping motor, both being polyphase AC motors requiring external electronic control.

There is a clearer distinction between a synchronous motor and asynchronous types. In the synchronous types, the rotor rotates in synchrony with the oscillating field or current (e.g. permanent magnet motors). In contrast, an asynchronous motor is designed to slip; the most ubiquitous example being the common AC induction motor which must slip in order to generate torque.

A DC motor is designed to run on DC electric power. Two examples of pure DC designs are Michael Faraday's homopolar motor (which is uncommon), and the ball bearing motor, which is (so far) a novelty. By far the most common DC motor types are the brushed and brushless types, which use internal and external commutation respectively to create an oscillating AC current from the DC source -- so they are not purely DC machines in a strict sense.

Brushed DC motors

The classic DC motor design generates an oscillating current in a wound rotor with a split ring commutator, and either a wound or permanent magnet stator. A rotor consists of a coil wound around a rotor that is then powered by any type of battery. Many of the limitations of the classic commutator DC motor are due to the need for brushes to press against the commutator. This creates friction. At higher speeds, brushes have increasing difficulty in maintaining contact. Brushes may bounce off the irregularities in the commutator surface, creating sparks. This limits the maximum speed of the machine.

The current density per unit area of the brushes limits the output of the motor. The imperfect electric contact also causes electrical noise. Brushes eventually wear out and require replacement, and the commutator itself is subject to wear and maintenance. The commutator assembly on a large machine is a costly element, requiring precision assembly of many parts.

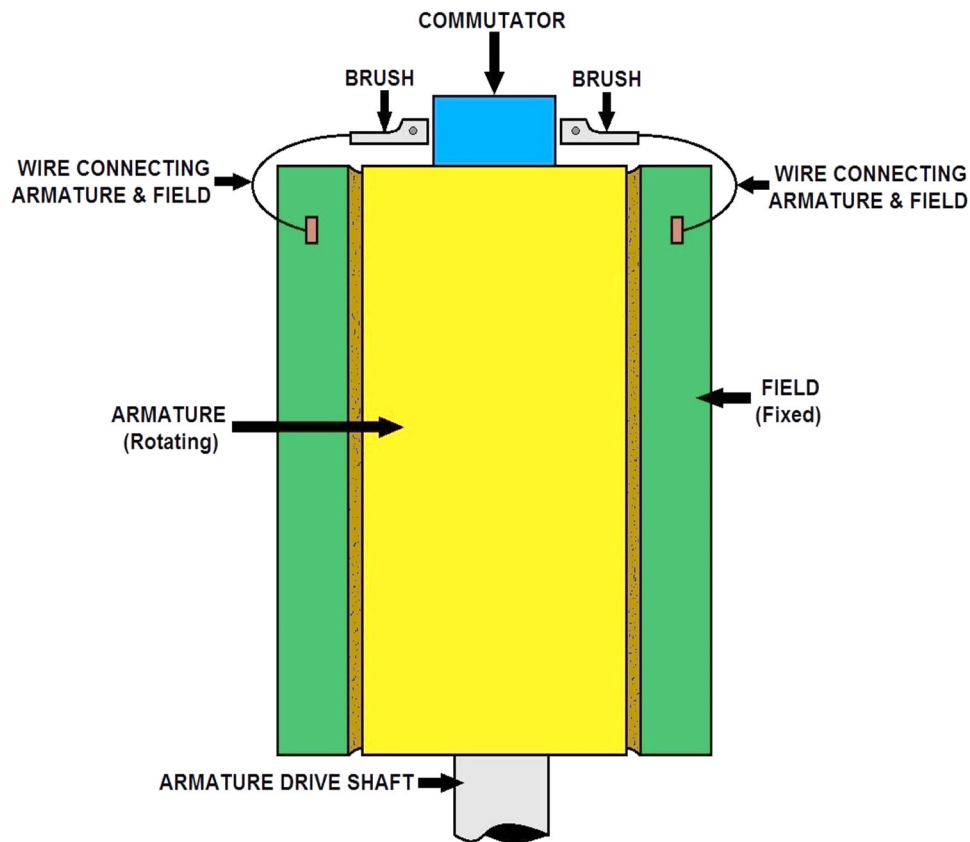
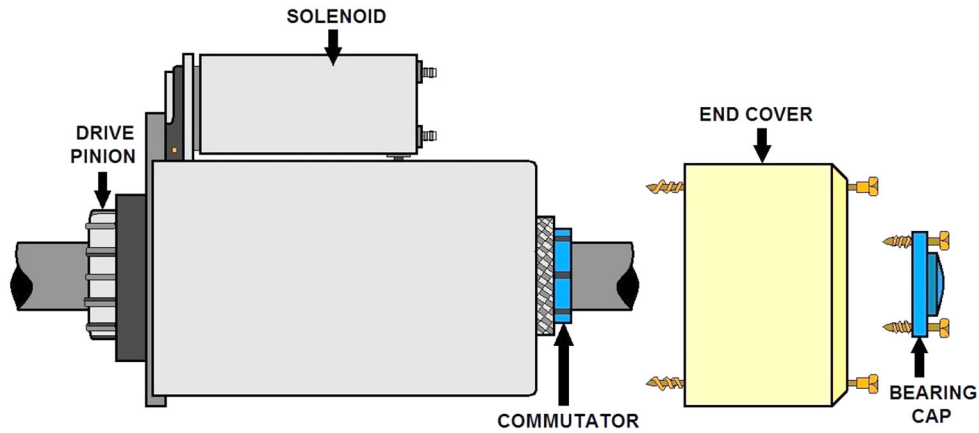

DIAGRAM SHOWING MECHANICAL CONSTRUCTION OF A DC SERIES WOUND MOTOR

Brushless DC Motors

Some of the problems of the brushed DC motor are eliminated in the brushless design. In this motor, the mechanical "rotating switch" or commutator/brush gear assembly is replaced by an external electronic switch synchronized to the rotor's position. Brushless motors are typically 85-90% efficient, whereas DC motors with brush gear are typically 75-80% efficient.

Midway between ordinary DC motors and stepper motors lies the realm of the brushless DC motor. Built in a fashion very similar to stepper motors, these often use a permanent magnet external rotor, three phases of driving coils, one or more Hall Effect sensors to sense the position of the rotor, and the associated drive electronics. The coils are activated one phase after the other by the drive electronics, as cued by the signals from the Hall effect sensors. In effect, they act as three-phase synchronous motors containing their own variable-frequency drive electronics. Brushless DC motors are commonly used where precise speed control is necessary, as in computer disk drives or in video cassette recorders, the spindles within CD, CD-ROM (etc.) drives, and mechanisms within office products such as fans, laser printers, and photocopiers.



STARTER MOTOR

Universal Motors

A variant of the wound field DC motor is the universal motor. The name derives from the fact that it may use AC or DC supply current, although in practice they are nearly always used with AC supplies.

The principle is that in a wound field DC motor the current in both the field and the armature (and hence the resultant magnetic fields) will alternate (reverse polarity) at the same time, and hence the mechanical force generated is always in the same direction. In practice, the motor must be specially designed to cope with the AC current (impedance must be taken into account, as must the pulsating force), and the resultant motor is generally less efficient than an equivalent pure DC motor.

Operating at normal power line frequencies, the maximum output of universal motors is limited and motors exceeding one kilowatt are rare. But universal motors also form the basis of the traditional railway traction motor in electric railways. In this application, to keep their electrical efficiency high, they were operated from very low frequency AC supplies, with 25 Hz and 16 2/3 hertz operation being common. Because they are universal motors, locomotives using this design were also commonly capable of operating from a third rail powered by DC.

The advantage of the universal motor is that AC supplies may be used on motors which have the typical characteristics of DC motors, specifically high starting torque and very compact design if high running speeds are used. The negative aspect is the maintenance and short life problems caused by the commutator. As a result, such motors are usually used in AC devices such as food mixers and power tools which are used only intermittently.

Continuous speed control of a universal motor running on AC is very easily accomplished using a thyristor circuit, while stepped speed control can be accomplished using multiple taps on the field coil. Household blenders that advertise many speeds frequently combine a field coil with several taps and a diode that can be inserted in series with the motor (causing the motor to run on half-wave rectified AC).

Moisture

Moisture harms the insulation on the windings to the point where they may no longer provide the required insulation for the voltage applied to the motor. In addition, moisture on windings tend to absorb acid and alkali fumes, causing damage to both insulation and metals. To reduce problems caused by moisture, the most suitable motor enclosure for the existing environment will normally be used. It is recommended to run stand by motors to dry up any condensation which accumulates in the motor.

Motor Lubrication

Friction will cause wear in all moving parts, and lubrication is needed to reduce this friction. It is very important that all your manufacturer's recommended lubrication procedures are strictly followed. You have to be careful not to add too much grease or oil, as this could cause more friction and generate heat.

To grease the motor bearings, this is the usual approach:

1. Remove the protective plugs and caps from the grease inlet and relief holes.
2. Pump grease in until fresh starts coming from the relief hole.

If fresh grease does not come out of the relief hole, this could mean that the grease has been pumped into the motor windings. The motor must then be taken apart and cleaned by a qualified service representative.

To change the oil in an oil lubricated motor, this is the usual approach:

1. Remove all plugs and let the oil drain.
2. Check for metal shearing (pieces of metal in the oil).
3. Replace the oil drain.
4. Add new oil until it is up to the oil level plug.
5. Replace the oil level and filter plug.

Never mix oils, since the additives of different oils when combined can cause breakdown of the oil.



Maintenance Sub-Section

Maintenance of Centrifugal Pumps

When properly installed, maintained and operated, centrifugal pumps are usually trouble-free. Some of the most common preventative and corrective maintenance actions that you may be required to perform are discussed in the following sections.

Repacking - Lubrication of the pump packing is extremely important. The quickest way to wear out the packing is to forget to open the water piping to the seals or stuffing boxes. If the packing is allowed to dry out, it will score the shaft. When operating a centrifugal pump, be sure there is always a slight trickle of water coming out of the stuffing box or seal. How often the packing in a centrifugal pump should be renewed depends on several factors, such as the type of pump, condition of the shaft sleeve, and hours in use.



To ensure the longest possible service from pump packing, make certain the shaft or sleeve is smooth when the packing is removed from a gland. Rapid wear of the packing will be caused by roughness of the shaft sleeve (or shaft where no sleeve is installed). If the shaft is rough, it should be sent to the machine shop for a finishing cut to smooth the surface. If it is very rough, or has deep ridges in it, it will have to be renewed. It is absolutely necessary to use the correct packing.

When replacing packing, be sure the packing fits uniformly around the stuffing box. If you have to flatten the packing with a hammer to make it fit, **YOU ARE NOT USING THE RIGHT SIZE**. Pack the box loosely, and set up the packing gland lightly. Allow a liberal leak-off for stuffing boxes that operate above atmospheric pressure.

Next, start the pump. Let it operate for about 30 minutes before you adjust the packing gland for the desired amount of leak-off. This gives the packing time to run-in and swell. You may then begin to adjust the packing gland. Tighten the adjusting nuts one flat at a time. Wait about 30 minutes between adjustments. Be sure to tighten the same amount on both adjusting nuts. If you pull up the packing gland unevenly (or cocked), it will cause the packing to overheat and score the shaft sleeves. Once you have the desired leak-off, check it regularly to make certain that sufficient flow is maintained.

Last Word on Mechanical Seals

Mechanical seals are rapidly replacing conventional packing as the means of controlling leakage on rotary and positive-displacement pumps. Mechanical seals eliminate the problem of excessive stuffing box leakage, which causes failure of pump and motor bearings and motor windings.

Mechanical seals are ideal for pumps that operate in closed systems (such as fuel service and air-conditioning, chilled-water, and various cooling systems). They not only conserve the fluid being pumped, but also improve system operation.



The type of material used for the seal faces will depend upon the service of the pump. Most water service pumps use a carbon material for one of the seal faces and ceramic (tungsten carbide) for the other. When the seals wear out, they are simply replaced.

You should replace a mechanical seal whenever the seal is removed from the shaft for any reason, or whenever leakage causes undesirable effects on equipment or surrounding spaces. Do not touch a new seal on the sealing face because body acid and grease or dirt will cause the seal to pit prematurely and leak.

Mechanical shaft seals are positioned on the shaft by stub or step sleeves. Mechanical shaft seals must not be positioned by setscrews. Shaft sleeves are chamfered (beveled) on outboard ends for easy mechanical seal mounting.

Mechanical shaft seals serve to ensure that liquid pressure is supplied to the seal faces under all conditions of operation. They also ensure adequate circulation of the liquid at the seal faces to minimize the deposit of foreign matter on the seal parts.

Pump Not Delivering Water

If your pump is not delivering water, verify that the pump shaft is turning in the direction of the arrow on the pump casing. As viewed from the motor end, the rotation is usually clockwise, but check the startup instructions that came with the pump.

On three-phase motors, swap any two power leads to change rotation. It is recommended that a qualified electrician perform this task.

If the pump does not prime, check for air leaks on discharge valves. Many all-metal gate-type valves will not seal properly to create a vacuum. Sand or other debris lodged between the rubber flap and the valve seat will prevent check valves from sealing and forming a tight joint. See if the rubber face is cracked or chipped and not seating. Replace the gate valve or check valve. Check connections between pump and primer. On a hand primer, if grass or other debris is lodged in the check valve, air is pulled back into the pump at every stroke and the pump will not prime. After proper priming, fill the system slowly.

Pump Maintenance Tasks

Twice a Year:

- Thoroughly clean suction and discharge piping and connections, removing moss and debris.
- Tighten all drain and fill plugs in the pump volute case to avoid air and water leaks. Use a pipe thread compound on all pipe threads.
- Check for cracks or holes in the pump case.
- Clean trash screening device and screens on the suction pipe.

Servicing Impeller and Wear Rings

If you suspect that your pump impeller is clogged or damaged, or that the wear rings are worn, you can dismantle the pump. This will take some work and is best done in the shop. Or have a qualified pump repair shop undertake this procedure.

Always follow the directions in the manufacturer's manual, if available, instead of the following simplified directions.

- Remove suction cover or volute case.
- Remove debris from impeller and volute. Remove pebbles lodged between vanes.
- Check wear at the impeller eye and vanes. If worn, repair or replace the impeller.
- Re-machine or replace wear ring if clearance is greater than 1/32 inch per side.
- Replace suction cover or volute. Use a new gasket.

On the Suction Side of Pump:

- A well designed and screened sump that keeps trash away.
- Suction line joints that are airtight under a vacuum.
- No high spots where air can collect.
- A suction line water velocity of five feet per second (fps) or less; two to three fps is best.
- A suction entrance at least two pipe bell diameters from sump inlet.
- A suction lift (vertical distance from water surface to pump impeller) less than 15 to 20 feet.
- An eccentric reducer to keep air from becoming trapped in the reducer fitting.
- A vacuum gauge to indicate whether the primer is pulling a vacuum or just moving air through the pump.

On the Discharge Side of Pump:

- A valve size that is the same diameter as the mainline.
- A non-slam check valve to prevent back spin when shutting off the pump.
- An air relief device when a buried mainline is used.
- A discharge line water velocity of less than seven fps. Five fps is best.
- An energy efficient 1800 rpm motor with a 15 percent safety factor.
- A simple shade over the motor.

Turbine Pump Installation

The properly constructed well should also:

- Be at least six inches in diameter larger than the outside diameter of the well casing when a gravel pack is required.
- Have horizontal well screen slots that continue below the pumping water level. The openings should hold back at least 85 percent of the surrounding material.

Control Panel for Electric Motors

The importance of a properly installed control panel cannot be overemphasized for personal safety and for protecting your investment in your pump and motor. Your control panel should:

- Have a shade over it to keep thermal breakers cool.
- Be mounted on secure poles or foundation.
- Have any missing knockout plugs and other holes in the starting switch box replaced and screened or puttied against rodents, insects, and dirt.
- Have a small hole (3/16-inch diameter) in the bottom of the panel to allow moisture to drain.

Your control panel should include the following controls at a minimum:

- Circuit breaker(s) for overload currents.
- Lightning arrester.
- Surge protector.
- Phase failure relay, to protect the motor from phase reversal or failure and from low voltage.
- A pressure switch to shut off the motor if pumping pressure drops to undesirable levels.

Casing

Casing is the tubular structure that is placed in the drilled well to maintain the well opening. Along with grout, the casing also confines the groundwater to its zone underground and prevents contaminants from mixing with the water. Some states or local governing agencies have laws that require minimum lengths for casing.

The most common materials for well casing are carbon steel, plastic (most commonly, but not exclusively, PVC), and stainless steel. Different geologic formations dictate what type of casing can be used. For example, parts of the country where hard rock lies underground are known strictly as “steel states.”

Residents in some areas have a choice between steel and PVC, both of which have advantages. PVC is lightweight, resistant to corrosion, and relatively easy for contractors to install. However, it is not as strong and not as resistant to heat as steel. Steel, though, is susceptible to corrosion, can have scale build-up, and can cost more than PVC. Some contractors also use concrete, fiberglass, and asbestos cement casing.

Caps

On the top of the casing should be an approved well cap. It should fit snugly so debris, insects, or small animals can't find their way into the well system.

Well caps are usually aluminum or a thermoplastic, and include a vented screen so that the pressure difference between the inside and outside of the well casing may be equalized when water is pumped from the well.

The casing and cap should extend at least 6 to 8 inches above the ground. If the well is near a river or stream, it should extend at least past the flood level to prevent overflows from contaminating the groundwater.

Well Screens

Well screens are filtering devices used to prevent excess sediment from entering the well. They attach to the bottom of the casing, allowing water to move through the well, while keeping out most gravel and sand. The most popular screens are continuous slot, slotted pipe, and perforated pipe.

Perforated pipe is a length of casing that has holes or slots drilled into the pipe. It is not efficient for aquifers that feature a lot of sand and gravel because it has wide openings.

There is less open area in the other two types of screens. Continuous slot screens are made of wire or plastic wrapped around a series of vertical rods. Slotted pipe screens, which have the least amount of open area, feature machine-cut slots into steel or plastic casing at set distances.

Pitless Adapters

Pitless adapters provide wells with a sanitary — and frost-proof — seal between the well casing and the water line running to the well system owner's house.

After a frost line is determined for the area where the well is being installed, the adapter is connected to the well casing below the frost line. Water from the well is then diverted horizontally at the adapter to prevent it from freezing.

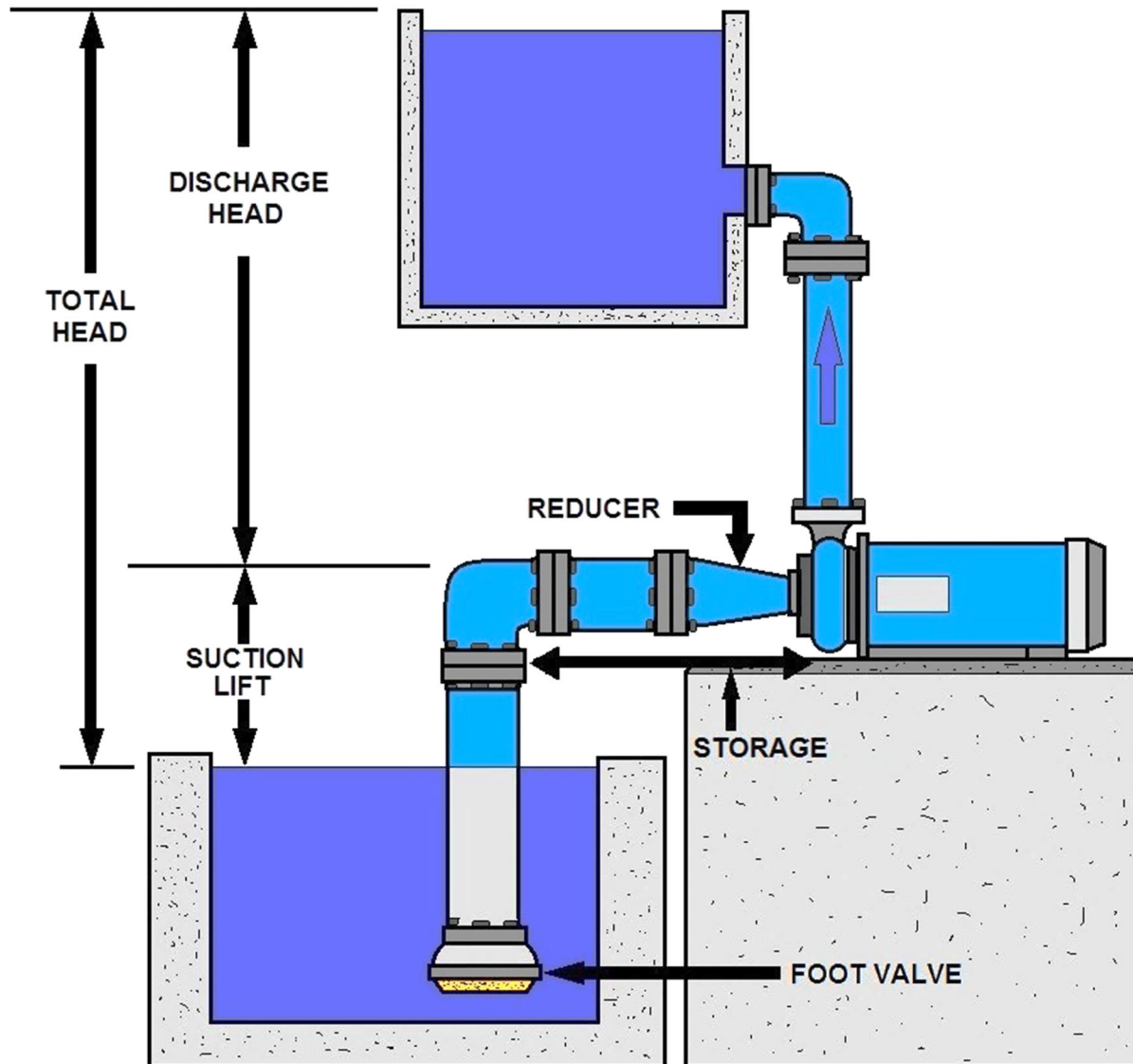

PUMPING FACTORS

Pump Troubleshooting Sub-Section

Some of the operating problems you may encounter with centrifugal pumps as an Operator, together with the probable causes, are discussed in the following paragraphs.

If a centrifugal pump **DOES NOT DELIVER ANY LIQUID**, the trouble may be caused by

- (1) insufficient priming;
- (2) insufficient speed of the pump;
- (3) excessive discharge pressure, such as might be caused by a partially closed valve or some other obstruction in the discharge line;
- (4) excessive suction lift;
- (5) clogged impeller passages;
- (6) the wrong direction of rotation (this may occur after motor overhaul);
- (7) clogged suction screen (if used);
- (8) ruptured suction line; or
- (9) loss of suction pressure.

If a centrifugal pump delivers some liquid but operates at **INSUFFICIENT CAPACITY**, the trouble may be caused by

- (1) air leakage into the suction line;
- (2) air leakage into the stuffing boxes in pumps operating at less than atmospheric pressure;
- (3) insufficient pump speed;
- (4) excessive suction lift;
- (5) insufficient liquid on the suction side;
- (6) clogged impeller passages;
- (7) excessive discharge pressure; or
- (8) mechanical defects, such as worn wearing rings, impellers, stuffing box packing, or sleeves.

If a pump **DOES NOT DEVELOP DESIGN DISCHARGE PRESSURE**, the trouble may be caused by

- (1) insufficient pump speed;
 - (2) air or gas in the liquid being pumped;
 - (3) mechanical defects, such as worn wearing rings, impellers, stuffing box packing, or sleeves;
- or
- (4) reversed rotation of the impeller (3-phase electric motor-driven pumps).

If a pump **WORKS FOR A WHILE AND THEN FAILS TO DELIVER LIQUID**, the trouble may be caused by

- (1) air leakage into the suction line;
- (2) air leakage in the stuffing boxes;
- (3) clogged water seal passages;
- (4) insufficient liquid on the suction side; or
- (5) excessive heat in the liquid being pumped.

If a motor-driven centrifugal pump **DRAWS TOO MUCH POWER**, the trouble will probably be indicated by overheating of the motor. The basic causes may be

- (1) operation of the pump to excess capacity and insufficient discharge pressure;
- (2) too high viscosity or specific gravity of the liquid being pumped; or
- (3) misalignment, a bent shaft, excessively tight stuffing box packing, worn wearing rings, or other mechanical defects.

VIBRATION of a centrifugal pump is often caused by

- (1) misalignment;
- (2) a bent shaft;
- (3) a clogged, eroded, or otherwise unbalanced impeller; or
- (4) lack of rigidity in the foundation. Insufficient suction pressure may also cause vibration and cavitation, as well as noisy operation and fluctuating discharge pressure, particularly in pumps that handle hot or volatile liquids.

If the pump fails to build up pressure when the discharge valve is opened and the pump comes up to normal operating speed, proceed as follows:

1. Shut the pump discharge valve.
2. Secure the pump.
3. Open all valves in the pump suction line.
4. Prime the pump (*fill casing with the liquid being pumped*) and be sure that all air is expelled through the air cocks on the pump casing.
5. Restart the pump. If the pump is electrically driven, be sure the pump is rotating in the correct direction.
6. Open the discharge valve to “load” the pump. If the discharge pressure is not normal when the pump is up to its proper speed, the suction line may be clogged, or an impeller may be broken. It is also possible that air is being drawn into the suction line or into the casing. If any of these conditions exist, stop the pump and continue troubleshooting according to the technical manual for that unit.

Troubleshooting Table for Well/Pump Problems

1. Well pump will not start.
2. Well pump will not shut off.
3. Well pump starts and stops too frequently (excessive cycle rate).
4. Sand sediment is present in the water.
5. Well pump operates with reduced flow.
6. Well house flooded without recent precipitation.
7. Red or black water complaints.
8. Raw water appears turbid or a light tan color following rainfall.
9. Coliform tests are positive.

Possible Causes

- 1A. Circuit breaker or overload relay tripped.
- 1B. Fuse(s) burned out.
- 1C. No power to switch box.
- 1D. Short, broken or loose wire.
- 1E. Low voltage.
- 1F. Defective motor.
- 1G. Defective pressure switch.
- 2A. Defective pressure switch.
- 2B. Cut-off pressure setting too high.
- 2C. Float switch or pressure transducer not functioning.
- 3A. Pressure switch settings too close.
- 3B. Pump foot valve leaking.
- 3C. Water-logged hydro-pneumatic tank.
- 4A. Problems with well screen or gravel envelope.
- 5A. Valve on discharge partially closed or line clogged.
- 5B. Well is over-pumped.
- 5C. Well screen clogged.
- 6A. Check valve not operating properly.
- 6B. Leakage occurring in discharge piping or valves.
- 7A. Water contains excessive iron (red brown) and/or manganese (black water).
- 7B. Complainant's hot water needs maintenance.
- 8A. Surface water entering or influencing well.
- 9A. Sample is invalid.
- 9B. Sanitary protection of well has been breached.

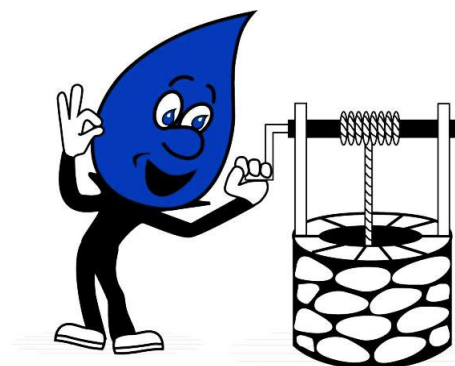

Possible Solutions

- 1A. Reset breaker or manual overload relay.
- 1B. Check for cause and correct, replace fuse(s).
- 1C. Check incoming power supply. Contact power company.
- 1D. Check for shorts and correct, tighten terminals, replace broken wires.
- 1E. Check incoming line voltage. Contact power company if low.
- 1F. Contact electrical contractor.
- 1G. Check voltage of incoming electric supply with pressure switch closed. Contact power company if voltage low. Perform maintenance on switch if voltage normal.
- 2A. Check switch for proper operation. Replace switch.
- 2B. Adjust setting.
- 2C. Check and replace components or cable as needed.
- 3A. Adjust settings.

- 3B. Check for backflow. Contact well contractor.
- 3C. Check air volume. Add air if needed. If persistent, check air compressor, relief valve, air lines and connections, and repair if needed.
- 4A. Contact well contractor.
- 5A. Open valve, unclog discharge line.
- 5B. Check static water level and compare to past readings. If significantly lower, notify well contractor.
- 5C. Contact well contractor.
- 6A. Repair or replace check valve.
- 6B. Inspect and repair/replace as necessary.
- 7A. Test for iron and manganese at well. If levels exceed 0.3 mg/L iron or 0.005mg/L manganese, contact regulatory agency, TA provider or water treatment contractor.
- 7B. Check hot water heater and flush if needed.
- 8A. Check well for openings that allow surface water to enter. Check area for sinkholes, fractures, or other physical evidence of surface water intrusion. Check water turbidity. Notify regulatory agency if >0.5 NTU. Check raw water for coliform bacteria. Notify regulatory agency immediately if positive.
- 9A. Check sampling technique, sampling container, and sampling location and tap.
- 9B. Notify regulatory agency immediately and re-sample for re-testing.



This brush is used to dislodge debris inside well casing. Just a big toilet cleaning brush.

SCADA - Simply Explained

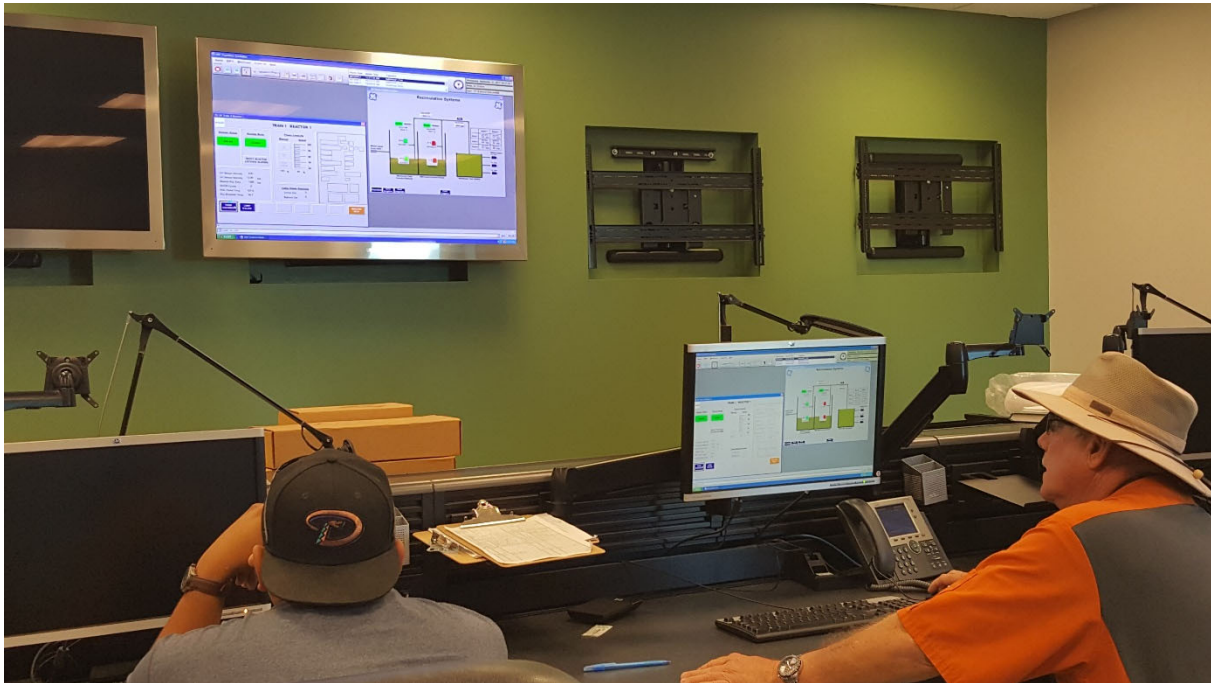

Supervisory control and data acquisition – SCADA refers to ICS (industrial control systems) used to control infrastructure processes (water treatment, wastewater treatment, gas pipelines, wind farms, etc.), facility-based processes (airports, space stations, ships, etc.), or industrial processes (production, manufacturing, refining, power generation, etc.).

Supervisory Control and Data Acquisition (SCADA) is a control system architecture that uses computers, networked data communications and graphical user interfaces for high-level process supervisory management, but uses other peripheral devices such as programmable logic controller (PLC) and discrete PID controllers to interface with the process plant or machinery. The use of SCADA has been also considered for management and operations of project-driven-process in construction.

The following subsystems are usually present in SCADA systems:

- The apparatus used by a human operator; all the processed data are presented to the operator
- A supervisory system that gathers all the required data about the process
- Remote Terminal Units (RTUs) connected to the sensors of the process, which helps to convert the sensor signals to the digital data and send the data to supervisory stream.
- Programmable Logic Controller (PLCs) used as field devices
- Communication infrastructure connects the Remote Terminal Units to supervisory system.

Generally, a SCADA system does not control the processes in real time – it usually refers to the system that coordinates the processes in real time.

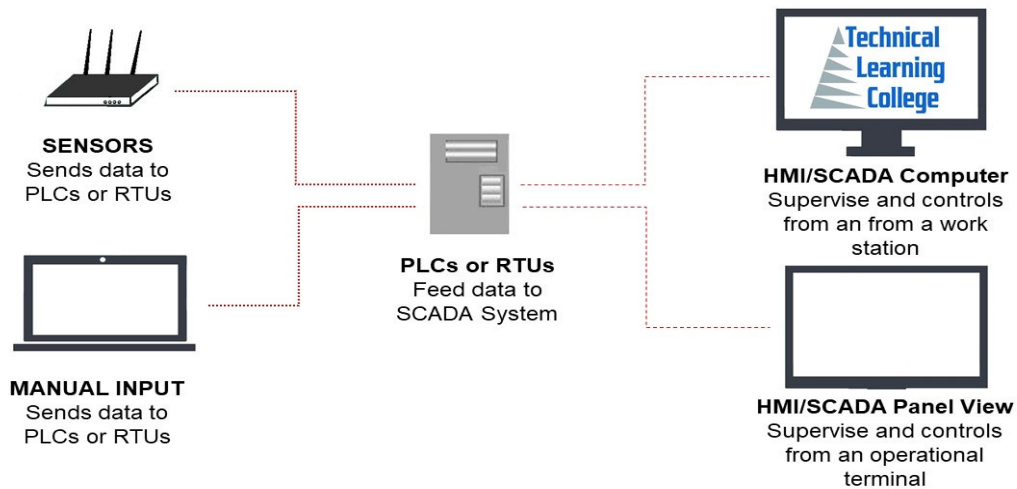

BASIC SCADA DIAGRAM

Remote Operation

SCADA is a real time control tool. It is not supposed to be a tool for detailed analysis of past performance but you the operator are able to research past performance to be able to react to current conditions. Thus, some form of trending is included with SCADA. The trending function is as close to analysis as most SCADA software get. Let us say a water treatment operator wants to examine chemical usage in GAC filters and determine how each filter behaved over the past six weeks. In this case, SCADA is your tool of choice. Some SCADA let you look at these three filters and compare their performance with some time period in the past.

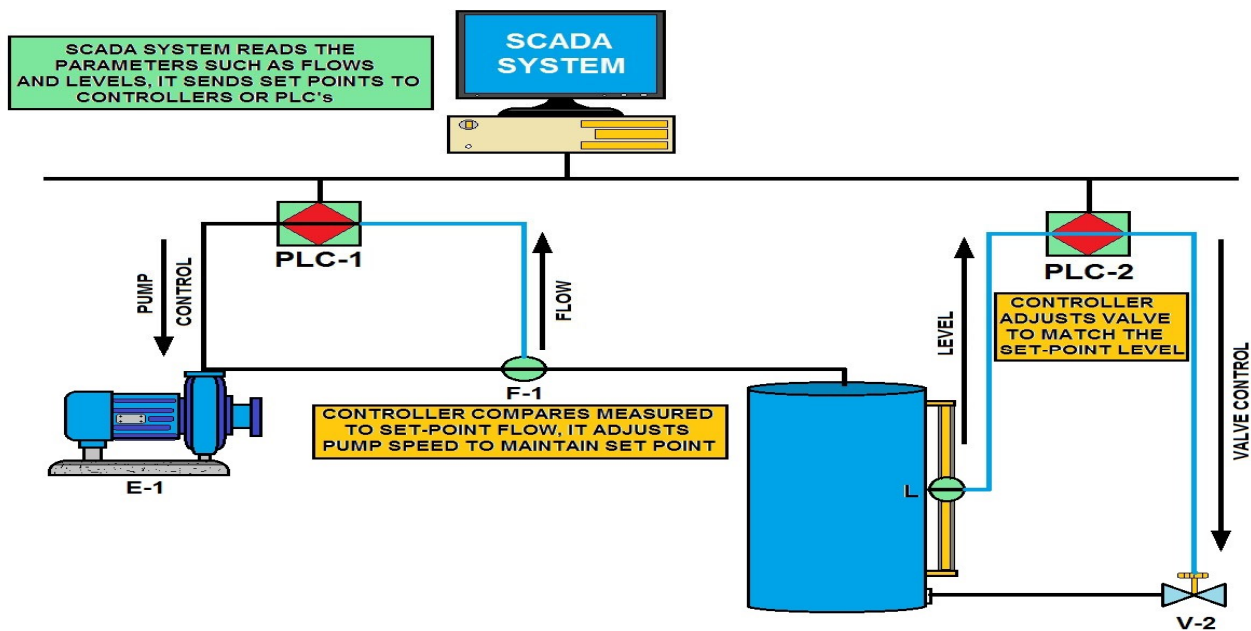

SCADA SYSTEM
(SUPERVISORY CONTROL and DATA ACQUISITION)

SCADA Systems Concepts

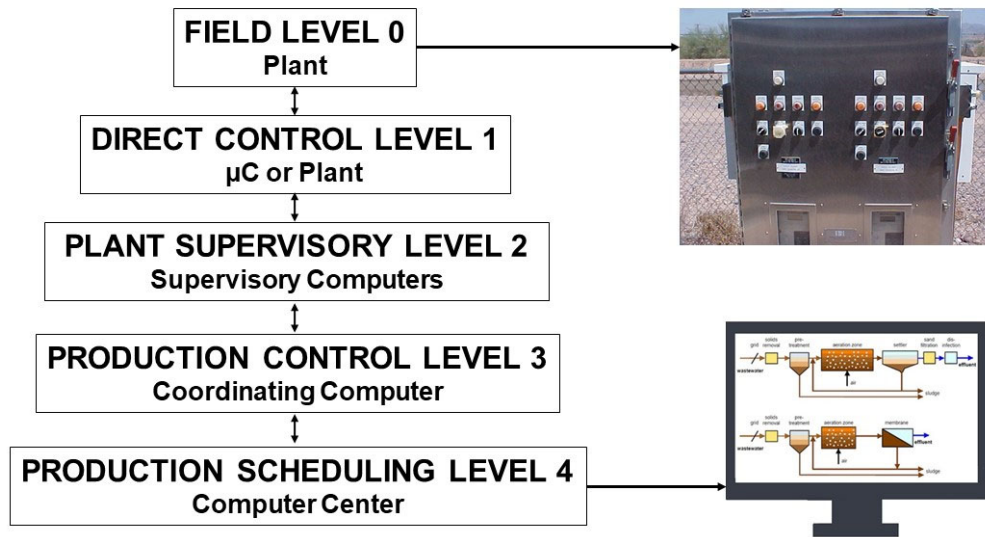

FUNCTION LEVELS OF CONTROL OPERATION

SCADA refers to the centralized systems that control and monitor the entire sites, or they are the complex systems spread out over large areas. Nearly all the control actions are automatically performed by the remote terminal units (RTUs) or by the programmable logic controllers (PLCs). The restrictions to the host control functions are supervisory level intervention or basic overriding.

For example, the PLC (in an industrial process) controls the flow of cooling water, the SCADA system allows any changes related to the alarm conditions and set points for the flow (such as high temperature, loss of flow, etc.) to be recorded and displayed.

Data acquisition starts at the PLC or RTU level, which includes the equipment status reports, and meter readings. Data is then formatted in such way that the operator of the control room can make the supervisory decisions to override or adjust normal PLC (RTU) controls, by using the HMI.

SCADA systems mostly implement the distributed databases known as tag databases, containing data elements called points or tags. A point is a single output or input value controlled or monitored by the system. Points are either 'soft' or 'hard'.

The actual output or input of a system is represented by a hard point, whereas the soft point is a result of different math and logic operations applied to other points. These points are usually stored as timestamp-value pairs.

Series of the timestamp-value pairs gives history of the particular point. Storing additional metadata with the tags is common (these additional data can include comments on the design time, alarm information, path to the field device or the PLC register).

The key attribute of a SCADA system is its ability to perform a supervisory operation over a variety of other proprietary devices.

SCADA systems typically use a tag database, which contains data elements called tags or points, which relate to specific instrumentation or actuators within the process system according to such as the Piping and instrumentation diagram. Data is accumulated against these unique process control equipment tag references.

Referring to the Diagram

Level 0 contains the field devices such as flow and temperature sensors, and final control elements, such as control valves.

Level 1 contains the industrialized input/output (I/O) modules, and their associated distributed electronic processors.

Level 2 contains the supervisory computers, which collate information from processor nodes on the system, and provide the operator control screens.

Level 3 is the production control level, which does not directly control the process, but is concerned with monitoring production and targets.

Level 4 is the production scheduling level.

Level 1 contains the programmable logic controllers (PLCs) or remote terminal units (RTUs).

Level 2 contains the SCADA software and computing platform. The SCADA software exists only at this supervisory level as control actions are performed automatically by RTUs or PLCs. SCADA control functions are usually restricted to basic overriding or supervisory level intervention.

For example, a PLC may control the flow of cooling water through part of an industrial process to a set point level, but the SCADA system software will allow operators to change the set points for the flow.

The SCADA also enables alarm conditions, such as loss of flow or high temperature, to be displayed and recorded. A feedback control loop is directly controlled by the RTU or PLC, but the SCADA software monitors the overall performance of the loop.

Levels 3 and 4 are not strictly process control in the traditional sense, but are where production control and scheduling takes place.

Data acquisition begins at the RTU or PLC level and includes instrumentation readings and equipment status reports that are communicated to level 2 SCADA as required.

Data is then compiled and formatted in such a way that a control room operator using the HMI (Human Machine Interface) can make supervisory decisions to adjust or override normal RTU (PLC) controls. Data may also be fed to a historian, often built on a commodity database management system, to allow trending and other analytical auditing.

Pumps and Motors Section Post Quiz

Definitions

1. What is the mechanical device that seals the pump stuffing box?
2. What definition represents is the energy associated with circular motion?
3. What is the fluid that leaks from the stuffing box?

Hydraulic Terms

4. What is the engineering science pertaining to liquid pressure and flow?
5. What gauge pressure means?

Pump Introduction

6. The key to understanding a pumps operation is that a pump moves water and generates the delivery _____ we call pressure.
7. Centrifugal pump operation — pressure is not usually referred to in pounds per square inch but rather as the equivalent in elevation, called?
8. According to the text, pumps may be classified on the basis of the application they serve.
A. True B. False
9. According to the text, all pumps may be divided into two major categories: (1) dynamic and (2)?

Understanding the Basic Water Pump

10. According to the text, the centrifugal pumps work by spinning water around in a circle inside a?
11. The pump makes the water spin by “pulling” it with an impeller.
A. True B. False

12. The blades of this impeller project inward from an axle like the arms of a turnstile and, as the impeller spins, the water moves through it.

A. True B. False

13. In a centrifugal pump, the water pressure at the edge of the turning impeller rises until it is able to keep water circling with the?

14. In a centrifugal pump, as water drifts outward between the _____ of the pump, it must move faster and faster because its circular path is getting larger and larger.

15. As the water slows down and its kinetic energy decreases, that water's pressure potential energy increases.

A. True B. False

16. As the water spins, the pressure near the outer edge of the pump housing becomes much lower than near the center of the impeller.

A. True B. False

Topic 3- Water Distribution Operation & Maintenance Section

Section Focus: You will learn the basics of the water distribution system including operations and maintenance concerns. At the end of this section, you will be able to describe how treated water is delivered to the customer through distribution piping and valves. There is a post quiz at the end of this section to review your comprehension and a final examination in the Assignment for your contact hours.

Scope/Background: The purpose of distribution system is to deliver potable water to consumer with appropriate quality, quantity and pressure. Distribution system is used to describe collectively the facilities/equipment used to supply water from its source to the point of usage.



The distribution system must protect water quality between the source and the customer's tap. Proper construction/repair is important in maintaining system integrity. Care must be taken that no foreign material is introduced into the system during repair or pipe laying operations.

Distribution Overview

Water supply distribution systems are rather straightforward in the majority of systems, however, proper evaluation of water supplies and distribution for larger communities or for groundwater production is no simple thing. Water distribution systems need to preform maintenance and repairs to ensure the public is provided safe drinking water at all times.

Water distribution systems consist of an interconnected series of components. They include:

- pipes
- storage facilities
- components that convey drinking water

Water distribution systems meet fire protection needs for:

- cities
- homes
- schools
- hospitals
- businesses
- industries
- other facilities

Public water systems depend on distribution systems to provide an uninterrupted supply of pressurized safe drinking water to all consumers. Distribution system mains carry water from either:

- the treatment plant to the consumer; or
- the source to the consumer when treatment is absent.

Distribution systems span almost one million miles in the United States. They represent the vast majority of physical infrastructure for water supplies. Distribution system wear and tear can pose intermittent or persistent health risks.

Water Quality and the Distribution System

New pipes are added to distribution systems as development occurs. The additions result in a wide variation in:

- Pipe sizes
- Materials
- Methods of construction
- Age within individual distribution systems and across the nation

As these systems age, deterioration can occur due to corrosion, materials erosion, and external pressures. Deteriorating water distribution systems can lead to:

- Breaches in pipes and storage facilities
- Intrusion due to water pressure fluctuation
- Main breaks

We will cover these concerns in this section.

Water Distribution System Introduction



A water service worker installing a new copper water service line on an asbestos cement water main. Notice the bronze saddle with a corporation stop, a compression type fitting and a locking nut to secure the copper pipe to the corp. Bottom photo, the saw blade hole saw type tapping machine which was used to tap the main for the new service. This was completed with the water main under pressure so that other customers on the main did not have their water service disrupted due to the new service.





Notice the corrosion inside this cast iron main.

This corrosion is caused by chemical changes produced by electricity or electrolysis. We call this type of corrosion “tuberculation”. It is a protective crust of corrosion products that have built up over a pit caused by the loss of metal due to corrosion or electrolysis. This type of corrosion will decrease the C-Factor (friction loss) and the carrying capacity in a pipe. Crenothrix bacteria or Red-Iron bacteria will live and thrive in the bioslime in this type of tuberculation.

For dealing with this bacterium, there are two methods: 1) the fast method, super chlorinate and continuously flush. Or, 2) replace the line with a nice and new plastic water main. It is up to your supervisor, but remember the nasty bacteria in the water. No one that knows about it would ever drink water from the house service. Biofilms are the result of a complex interaction among microorganisms. The organisms form micro-colonies and secrete extracellular material that makes them highly resistant to biocides.

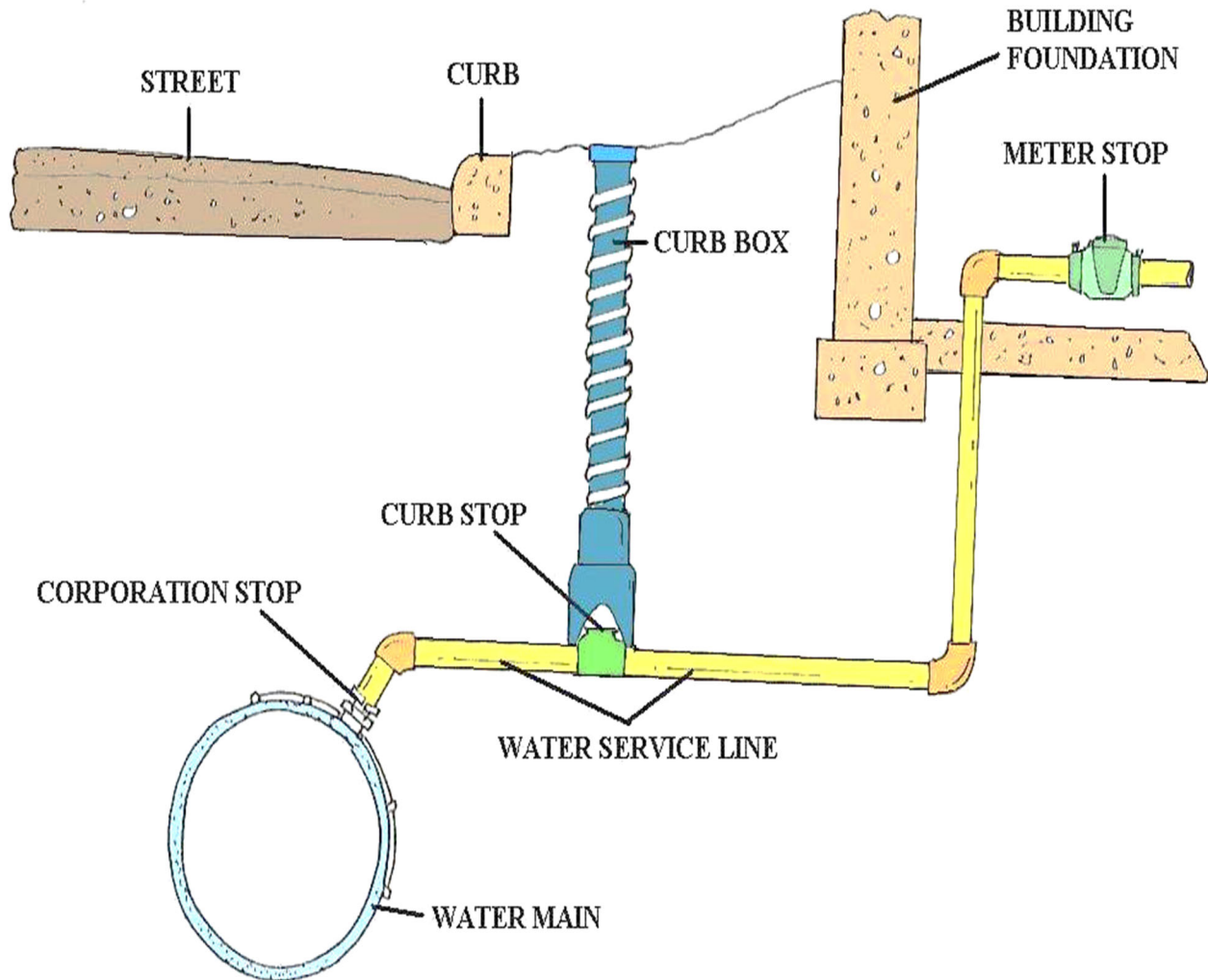

What Is Distribution's Purpose?

The water distribution system is the essential link between the water supply source and the consumer. It is an elaborate conveyance system that allows water to be moved through miles of piping before reaching the customer's tap.

Pumps allow water to move through the system or from the well; valves allow water pressure and flow direction to be regulated along the way.

The Water Distribution Department/Division is generally responsible for the maintenance of water mains, water services, fire hydrants, water valves and backflow devices located within the City's/Water Provider's service area.

In short, the Distribution Department/Division ensures that treated water is delivered to the customer's tap without any new contamination.



Wear appropriate personal protective equipment (PPE) as required for the task being performed and as required per OSHA regulations. Ensure a spotter is used if there are overhead power lines, underground utilities or tight working conditions in the work area. Verify the competent person is on site and that records are kept of all work and safety procedures.

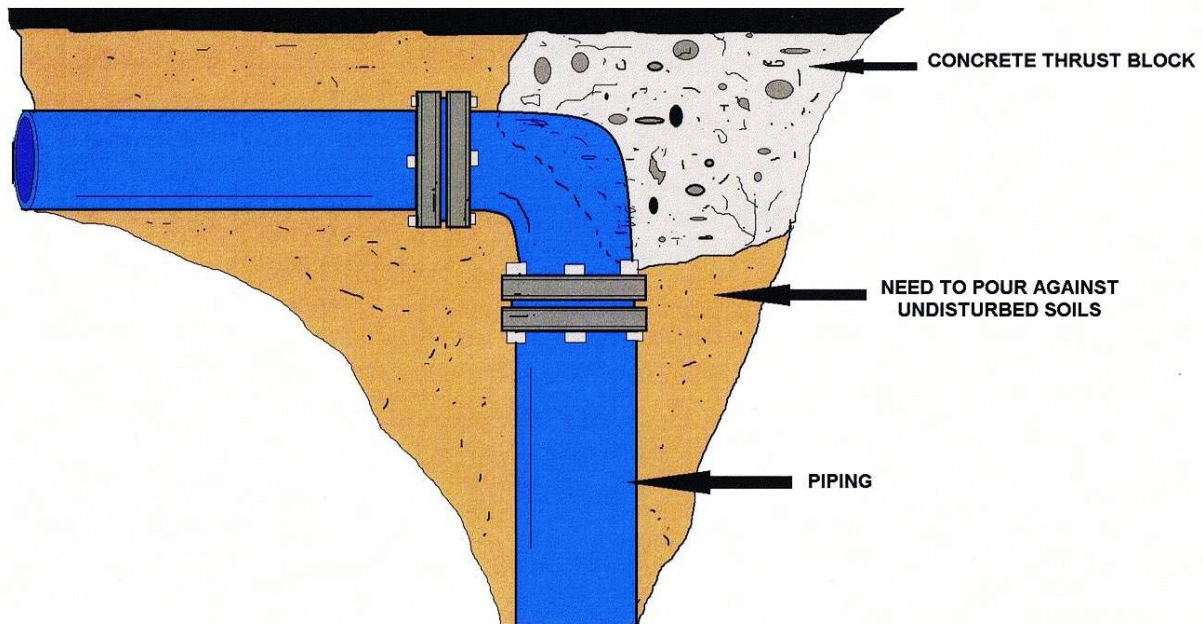

TYPICAL THRUST BLOCKING (KICKER)

Distribution System Design

System design depends on the area where you live. You may be a flatlander, or have many fluctuating elevations. Some areas may only serve residents on a part time basis and water will sit for long periods of time, while other areas may have a combination of peaks and valleys with short and long distances of service.

Before you design the system, you need to ask yourself some basic questions.

1. ***What is the source of water?***
2. ***What is the population?***
3. ***What kind of storage will I need for high demand and emergencies?***
4. ***How will the pressure be maintained?***

System Elements

The elements of a water distribution system include: distribution mains, arterial mains, storage reservoirs, and system accessories. These elements and accessories are described as follows:

Distribution Mains Distribution mains are the pipelines that make up the distribution system. Their function is to carry water from the water source or treatment works to users.

Arterial Mains Arterial mains are distribution mains of large size. They are interconnected with smaller distribution mains to form a complete gridiron system.

Storage Reservoirs Storage reservoirs are structures used to store water. They also equalize the supply or pressure in the distribution system. A common example of a storage reservoir is an aboveground water storage tank.

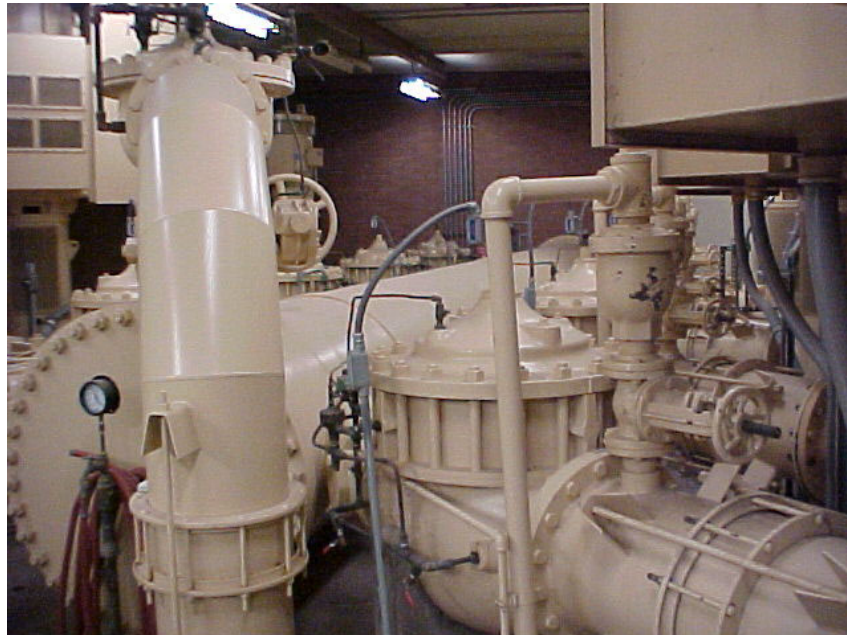

Inside a giant booster pump station.

System Accessories Include the Following

Booster stations are used to increase water pressure from storage tanks for low-pressure mains.

Valves control the flow of water in the distribution system by isolating areas for repair or by regulating system flow or pressure.



Different types of Gate Valves. (Linear)

Top photo is valve ready for a valve re-placement. It has a mechanical type joint for connection. Bottom photo is OS&Y commonly found on fire lines. This is a flange type joint. (Outside Screw and Yoke) As the gate is lifted or opened, the stem will rise.

Gate valves should be used in the distribution system for main line isolation only. Gate valve is a linear type of valve. Unused gate valves should be stored upright with the gate down.



TLC hands-on valve class

Distribution System Layouts

There are three general ways systems are laid out to deliver water (picture your quarter section layouts). They include:

Tree systems

Loop or Grid systems

Dead-end systems - *Undesirable, taste and odor problems.*

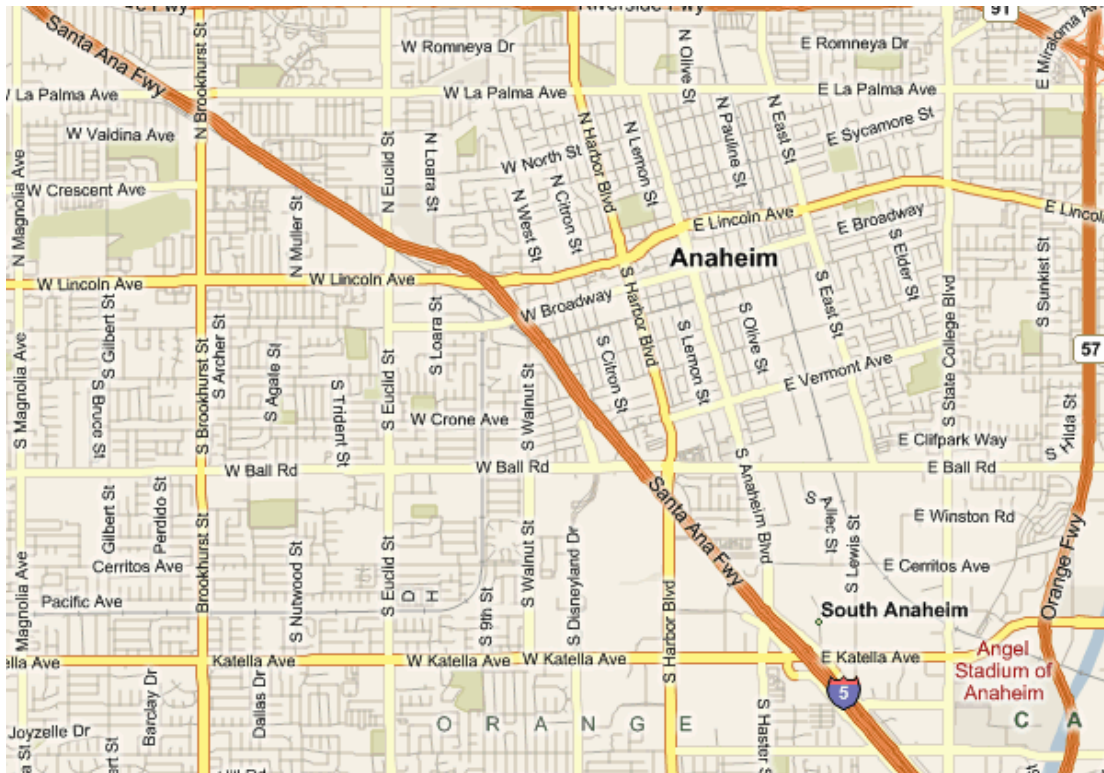

Tree System

Older water systems frequently were expanded without planning and developed into a treelike system. This consists of a single main that decreases in size as it leaves the source and progresses through the area originally served. Smaller pipelines branch off the main and divide again, much like the trunk and branches of a tree.

A treelike system is not desirable because the size of the old main limits the expansion of the system needed to meet increasing demands. In addition, there are many dead ends in the system where water remains for long periods, causing undesirable tastes and odors in nearby service lines. The most reliable means to provide water for firefighting is by designing redundancy into the system. There are several advantages gained by laying out water mains in a loop or grid, with feeder and distributor mains interconnecting at roadway intersections and other regular intervals.

Friction Loss

Water will still be distributed through the system if a single section fails. The damaged section can be isolated and the remainder of the system will still carry water.

Water supplied to fire hydrants will feed from multiple directions. Thus during periods of peak fire flow demand, there will be less impact from "friction loss" in water mains as the velocity within any given section of main will be less since several mains will be sharing the supply.



Rust and debris from cleaning a steel main.



A temporary blow-off at a dead-end line.



Water main breaks are common and are often referred as an “Emergency” because of property damage. Because of water leaks, we need to keep a free chlorine residual of at least 2 mg/l in the distribution system; another reason for chlorination is the chance of backflow.



A normal day of work for most distribution system operators. Using a Vector to pump out the hole while replacing a plastic main section.

Water Distribution Valve Section - Introduction

Water distribution valves are provided in the design of the water systems to allow for the isolation and shut-off of water when emergency conditions occur. It is important to recognize that these valves are a critical link in the management of emergencies that occur in the distribution system. Additionally, these valves are usually operated infrequently therefore, the establishment of an annual valve exercising program is essential to the viability of an utility emergency operations plan.

Emergency operations of water valves presumes that the system operators are familiar with the exact locations of many key water valves within the water system. Equal in importance is the knowledge that when these valves need to be operated in order to isolate a section of the distribution system, they will operate and close effectively in order to prevent a large loss of the water recourse and excessive property damage.

Routine valve inspections should be conducted on the water system valves and the following tasks are accomplished:

- The accuracy of all valves and valve boxes is verified against existing records.
- If inconsistencies are found, the records are updated to reflect accurate information.
- An inspection is performed on each valve stem and nut to determine if any damage exists.
- The valve is fully closed and the number of turns necessary to accomplish a full closing is recorded.
- The valve is re-opened, and the system flows are re-established.
- The valve box and cover is cleaned, inspected for damaged and painted blue.

Exercising of all valves should be accomplished at the same time as the valve inspection. The exercising program assures that the valve operates and loosens any encrustation from valve seats and gates. Many valve manufacturers recommend that the valve stem be completely opened and then backed off by one complete turn.



Portable valve exercising machine.



Top photo, two gate valves blew out, you can see the kickers or thrust blocks in the background.

Bottom photo, a tapping machine and a new gate valve. These tapping machines are very expensive.



Classification of Valves

There are two major classifications of water valves: **Rotary and Linear**. Linear is a fancy word for up and down or blade movement.

Gate Valve Linear Valve Our primary Linear valve

The most common valve in the distribution system. Primarily used for main line shut downs. Should be exercised on annual basis.

Gate valves are used when a straight-line flow of fluid and minimum flow restriction are needed. Gate valves are so-named because the part that either stops or allows flow through the valve acts somewhat like a gate.

The gate is usually wedge-shaped. When the valve is wide open, the gate is fully drawn up into the valve bonnet. This leaves an opening for flow through the valve the same size as the pipe in which the valve is installed.

Therefore, there is little pressure drop or flow restriction through the valve.

Gate valves are not suitable for throttling purposes. The control of flow is difficult because of the valve's design, and the flow of fluid slapping against a partially open gate can cause extensive damage to the valve. Except as specifically authorized, gate valves should not be used for throttling.

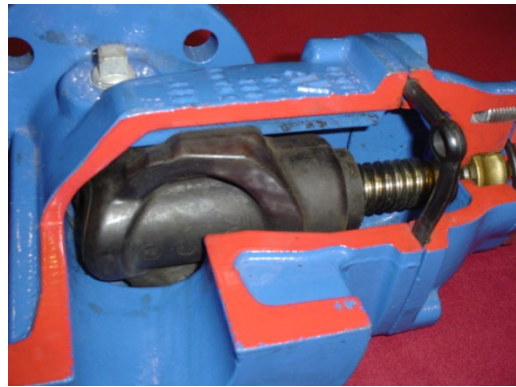

It is suggested to listen to the Valve Key when shutting down a Gate valve. You will easily hear it sing as you shut the water off or leak by. It is very easy to create a water hammer with opening or closing a Gate valve. Always take your time when operating a gate valve or any valve. I know that most of you will not listen to me and you will end up breaking plastic water services and customer's water lines at first.

Next, you will move up to water main breaks. We like to blame the Fire Department or Street Sweepers for water hammers. A great example is watching a rookie shut down or open a fire hydrant. Rookies like to turn the hydrant on or off as fast as possible, as the Firemen do. Soon, the hydrant starts chattering and pumping. The ground feels like an earthquake and the rookie pretends that nothing is happening. We have all done this and if you haven't, you've probably never worked in the field.

Installation of Valves – Assignment Notes

At intersections of distribution mains, the number of valves required is normally one less than the number of radiating mains.

All buried small- and medium-sized valves shall not be installed in the sidewalk for safety.

For large shutoff valves, it is necessary to surround the valve operator or entire valve within a vault or manhole to allow repair or replacement.

Problems

Valve Jammed Open

Dr. Rusty recommends that opened valves should not be jammed-tight on the backseat.

Always back the valve-off a quarter turn from the fully opened position.

Note that motor operated valves coast inevitably to the backseat by tripping on a limit switch. Valve should not be back seated on torque.

Valve Jammed Closed

Variations in the temperature and/or pressure of the working fluid are often the cause of a valve failing to open.

Thermal binding can occur in high temperature situations depending on the seat and wedge material, length of exposure and closing torque applied. Thermal binding can cause galling on the valve sealing surfaces as well as on the guides.

A valve can lock in the closed position when high pressure enters the cavity and has no way to escape. This is known as over-pressurization.

If Excessive Torque is Needed to Work the Valve

Variations in the temperature and/or pressure of the working fluid are often the cause of a valve failing to open.

Thermal binding can occur in high temperature situations depending on the seat and wedge material, length of exposure and closing torque applied. Thermal binding can cause galling on the valve sealing surfaces as well as on the guides.

A valve can lock in the closed position when high pressure enters the cavity and has no way to escape. This is known as over-pressurization. We will cover this in a later section.

Single direction sealing gate valves have a nameplate on the side of the valve that has a relief hole or pressure equalizer. This should be the high-pressure side when the valve is closed.

Valve Exercising

Valve exercising should be done once per year (especially main line valves) to detect malfunctioning valves and to prevent valves from becoming inoperable due to freezing or build-up of rust or corrosion. A valve inspection should include drawing valve location maps to show distances (ties) to the valves from specific reference points (telephone poles, stonelines, etc.).

Valve Exercising Machine →



Hydrants are designed to allow water from the distribution system to be used for fire-fighting purposes.

Left photograph-- the bottom of a dry barrel fire hydrant, there is a drainage hole on the back of this hydrant, sometimes referred to as a “weep hole”.

Right photograph--an “Airport Runway” type of hydrant.

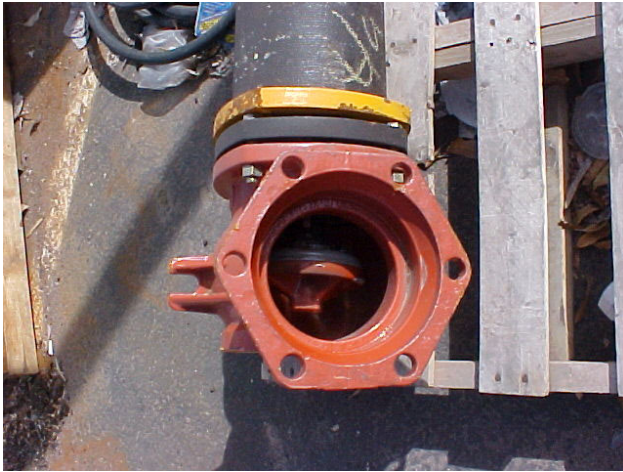

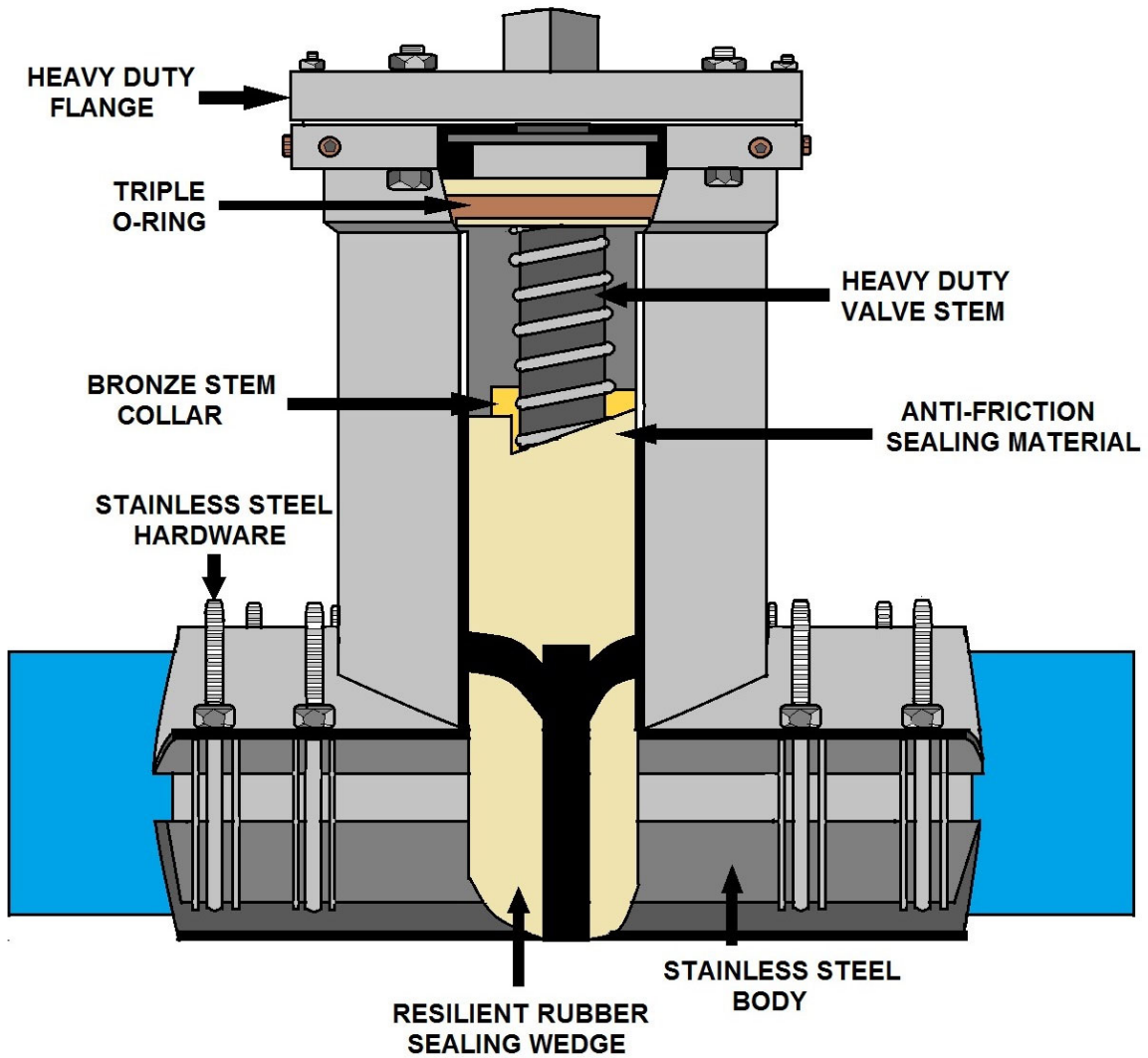

INSTA-VALVE DIAGRAM

Common Rotary Valves

Globe Valve - *Rotary Valve*

Primarily used for flow regulation, and works similar to a faucet. They are rare to find in most distribution systems, but can be found at treatment plants. Always follow standard safety procedures when working on a valve.

Most Globes have compact OS & Y type, bolted bonnet, rising stems, with renewable seat rings. The disc results with most advanced design features provide the ultimate in dependable, economical flow control.

Globe valves should usually be installed with the inlet below the valve seat. For severe throttling service, the valve may be installed so that the flow enters over the top of the seat and goes down through it.

Note that in this arrangement, the packings will be constantly pressurized. If the valve is to be installed near throttling service, verify with an outside contractor or a skilled valve technician. Globe valves, per se, are not suitable for throttling service.

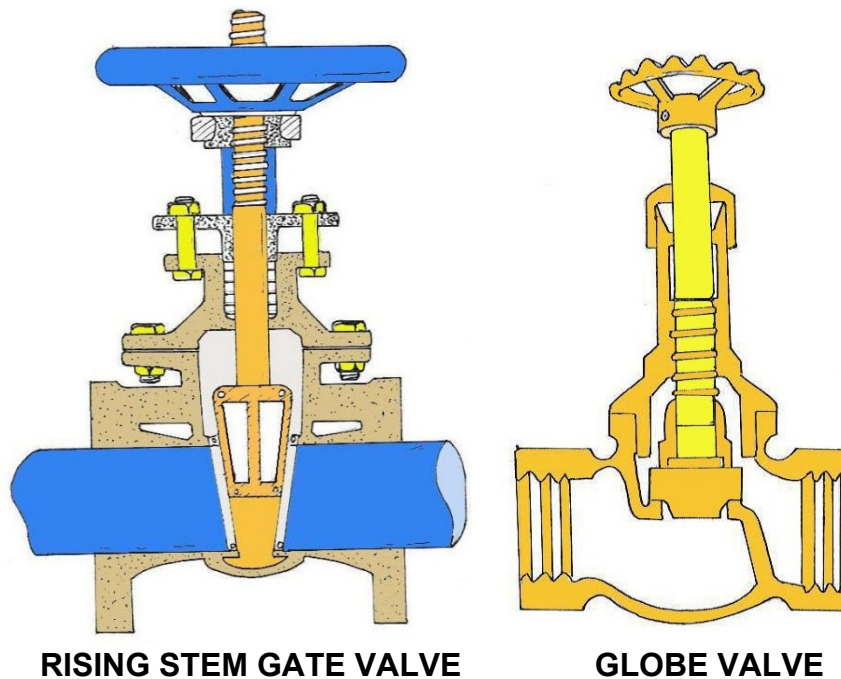

The valve should be welded onto the line with the disc in the fully closed position. Leaving it even partially open can cause distortion and leaking. Allow time for the weld to cool before operating the valve the first time in the pipeline.

The preferred orientation of a globe valve is upright. The valve may be installed in other orientations, but any deviation from vertical is a compromise. Installation upside down is not recommended because it can cause dirt to accumulate in the bonnet.

Globe Valve Problems and Solutions

If the valve stem is improperly lubricated or damaged-- Disassemble the valve and inspect the stem. Acceptable deviation from theoretical centerline, created by joining center points of the ends of the stem is 0.005"/ft. of stem.

Inspect the threads for any visible signs of damage.

Small grooves less than 0.005" can be polished with an Emory cloth. Contact specialized services or an outside contractor if run-out is unacceptable or large grooves are discovered on the surface of the stem.

If the valve packing compression is too tight--Verify the packing bolt torque and adjust if necessary.

Foreign debris is trapped on threads and/or in the packing area--This is a common problem when valves are installed outdoors in sandy areas and areas not cleaned before operating.

Always inspect threads and packing area for particle obstructions; even seemingly small amounts of sand trapped on the drive can completely stop large valves from cycling. The valve may stop abruptly when a cycle is attempted. With the line pressure removed from the valve, disconnect the actuator, gear operator or handwheel and inspect the drive nut, stem, bearings and yoke bushing.

Contaminated parts should be cleaned with a lint-free cloth using alcohol, varsol or equivalent. All parts should be re-lubricated before being re-assembled. If the valves are installed outdoors in a sandy area, it may be desirable to cover the valves with jackets.

If the valve components are faulty or damaged--contact specialized services or an outside contractor.

If the valve's handwheel is too small--Increasing the size of the handwheel will reduce the amount of torque required to operate the valve. If a larger handwheel is installed, the person operating the valve must be careful not to over-torque the valve when closing it.

Ball or Corporation Stop - Rotary Valve

Small Valves 2 inches and smaller

Most commonly found on customer or water meters. All small backflow assemblies will have two Ball valves. It is the valve that is either fully on or fully off; and the one that you use to test the abilities of a water service rookie. The best trick is to remove the ball from the Ball valve and have a rookie **Jump a Stop**. The Corp is usually found at the water main on a saddle. Some people say that the purpose of the Corp is to regulate the service. I don't like that explanation. No one likes to dig up the street to regulate the service, and Ball valves are only to be used fully on or fully off.



Most ball valves are the quick-acting type. They require only a 90-degree turn to either completely open or close the valve. However, many are operated by planetary gears. This type of gearing allows the use of a relatively small handwheel and operating force to operate a fairly large valve. Always follow standard safety procedures when working on a valve.

The gearing does, however, increase the operating time for the valve. Some ball valves also contain a swing check located within the ball to give the valve a check valve feature. The brass ball valve is often used for house appliance and industry appliance; the size range is 1/4"-4".

Brass or zinc is common for body, brass or iron for stem, brass or iron for ball, aluminum, stainless steel, or iron for handle including a Teflon seal in the ball housing. Flush the pipeline before installing the valve.



Debris allowed to remain in the pipeline (such as weld spatters, welding rods, bricks, tools, etc.) can damage the valve. After installation, cycle the valve a minimum of three times and re-torque bolts as required. Ensure that the valve is in the open position and the inside of the body bore of the valve body/body end is coated with a suitable spatter guard.



At a water treatment plant, we can see both valve actuators control devices and Butterfly valves as well. Bottom photo is a cut-away of an actuator.

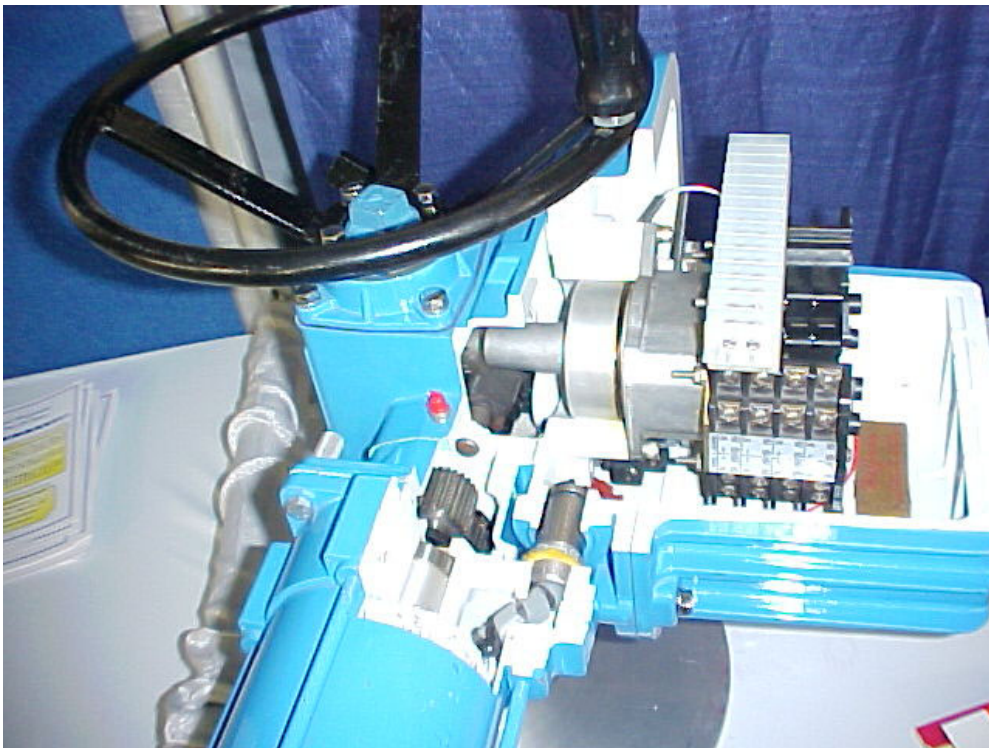

Butterfly Valve - *Rotary Valve*

Usually a huge water valve found in both treatment plants and throughout the distribution system. If the valve is not broken, it is relatively easy to operate. It is usually accompanied with a Gate valve used as a by-pass to prevent water hammer.

These are rotary type of valves usually found on large transmission lines. They may also have an additional valve beside it known as a "**bypass valve**" to prevent a water hammer.

Some of these valves can require 300-600 turns to open or close.

Most Valvemen (or the politically correct term "Valve Operators") will use a machine to open or close a Butterfly Valve. The machine will count the turns required to open or close the valve.

Butterfly valves should be installed with the valve shaft horizontal or inclined from vertical.

Always follow standard safety procedures when working on a valve.

The valve should be mounted in the preferred direction, with the "HP" marking.

Thermal insulation of the valve body is recommended for operating temperatures above 392°F (200°C). The valve should be installed in the closed position to ensure that the laminated seal in the disc is not damaged during installation.

If the pipe is lined, make sure that the valve disc does not contact the pipe lining during the opening stroke. Contact with lining can damage the valve disc.

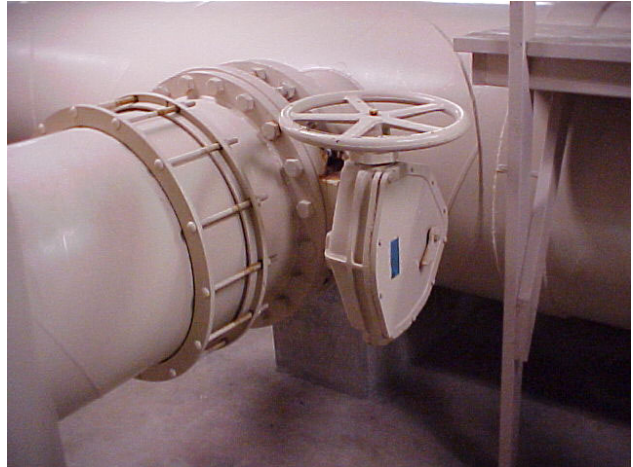

54-inch Butterfly valve on a huge transmission line. Nice job but no shoring, no ladder or valve blocking.

Butterfly Valve Problems

A butterfly valve may have jerky operation for the following reasons:

If the packing is too tight--Loosen the packing torque until it is only hand tight. Tighten to the required level and then cycle the valve. Re-tighten, if required. CAUTION: Always follow safety instructions when operating on valve.

If the shaft seals are dirty or worn out--Clean or replace components, as per assembly-disassembly procedure. CAUTION: Always follow safety instructions when operating on a valve.

If the shaft is bent or warped--The shaft must be replaced. Remove valve from service and contact an outside contractor or your expert fix-it person.

If the valve has a pneumatic actuator, the air supply may be inadequate--Increase the air supply pressure to standard operating level. Any combination of the following may prevent the valve shaft from rotating:

If the actuator is not working--Replace or repair the actuator as required. Please contact specialized services or an outside contractor for assistance.

If the valve is packed with debris--Cycle the valve and then flush to remove debris. A full cleaning may be required if flushing the valve does not improve valve shaft rotation. Flush or clean valve to remove the debris.



A broken 54-inch Butterfly and a worker inside the water main preparing the interior surface. Notice, this is a Permit Required Confined Space. Hot work permit is also required. Side note, there is a plastic version of the 54 and 60-inch butterfly valve.

Water Meter Sub-Section

Bypass, Compound, Turbine and Propeller meters.

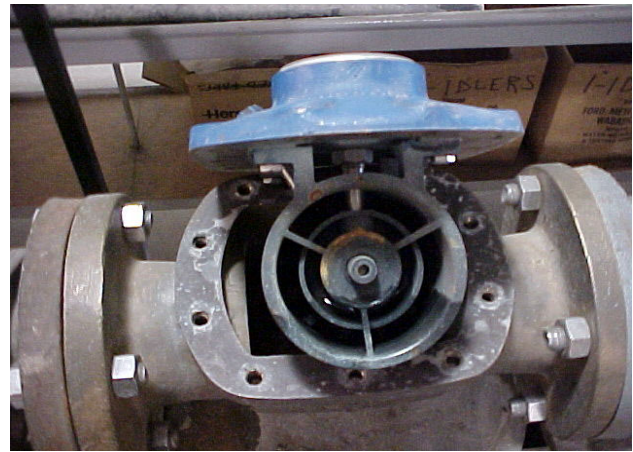

Meter Purpose: Is to properly record the flow of water in a part of the distribution system. To properly account and bring revenue to the City or Water Provider.

Water Meter Operation

It is important to account for the water produced and supplied. A master meter should be installed on each source (well), with service meters placed at each point of use or service connection. These meters should be read and recorded periodically. Totals from the master meters should be compared to totals from the service meters to compute the amount of water lost in the distribution system. This information is important in locating and eliminating leaks and unauthorized taps.

Losses of 10 to 20 percent are not uncommon in many distribution systems. Also, it has been shown that a system which is not metered is likely to have a water usage up to three times as great as a metered system. Un-metered water users tend to water freely and have little incentive to repair plumbing leaks.



Computerized handheld electronic meter reader “station”



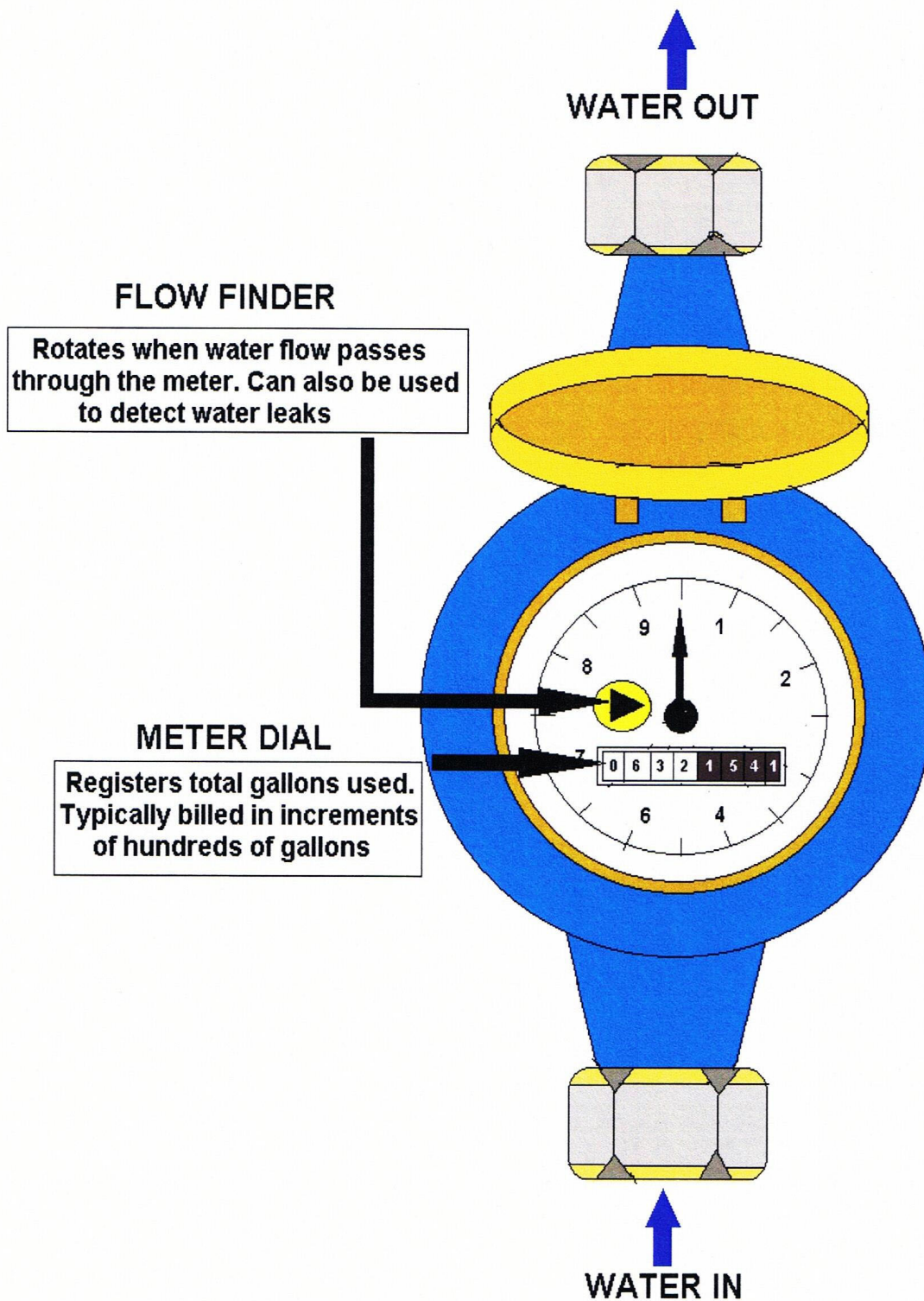

RESIDENTIAL WATER METER (5/8 OR 3/4")

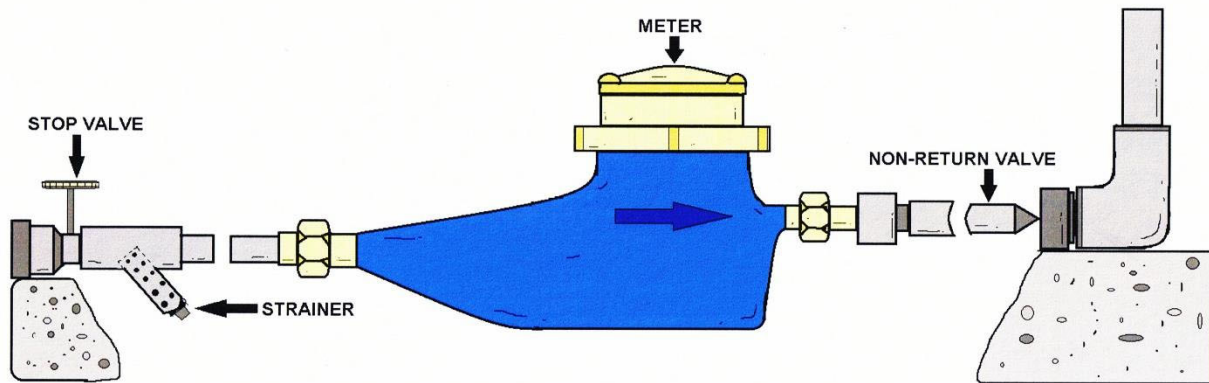

WATER METER

Water meters are used to measure the volume of water used by residential and commercial building that are supplied with water by a public water supply system.

Water meters can also be used at the water source, well, or throughout a water system to determine flow through that portion of the system.

Most of the US, water meters are calibrated in cubic feet (ft.³), or US gallons on a mechanical or electronic register and are read with electronic methods.

Some electronic meter registers can display rate-of-flow in addition to total usage. There are several types of water meters in common use.

Selection is based on different flow measurement methods, the type of end user, the required flow rates, and accuracy requirements. In North America, standards for manufacturing of water meters are made by the American Water Works Association (AWWA).

Meter Shop

Equipment used for meter calibration. Most meters will read lower than normal, never higher. All meters will create “head loss” on the water service except for a “Magnetic Meter”. The large tanks are used to measure the water in gallons that is used to calibrate or check the water meter.

Most water utilities will charge the customer a fee to check the accuracy of the meter.

Service Connections and Mains Sub-Section

Service connections are used to connect individual buildings or other plumbing systems to the distribution system mains.

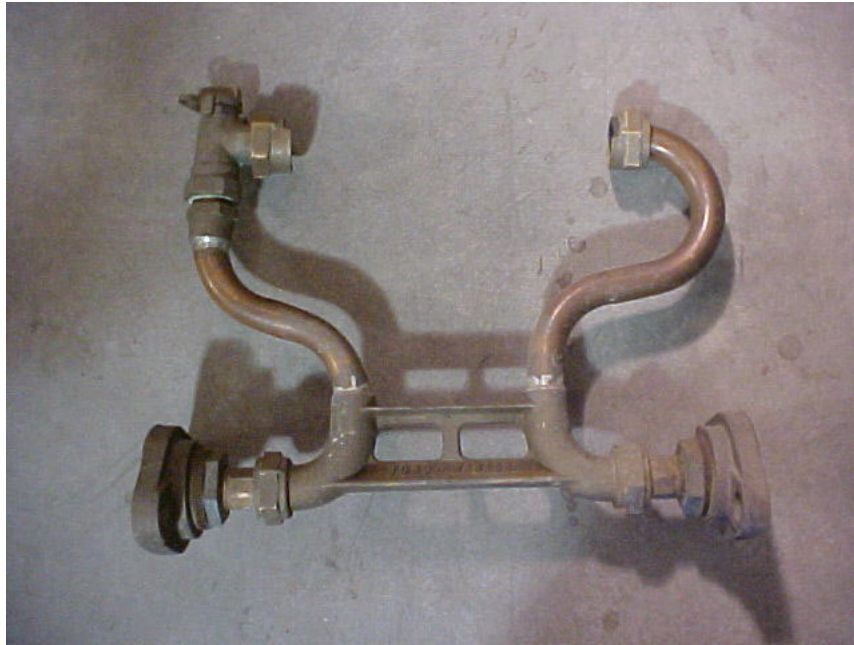

Water Meter Re-setter, Riser, or sometimes referred to as a copper yoke.



Common distribution fittings. Single check, Poly Pig, 1- inch repair clamp, 4-inch full circle clamp, T- Bolt and a corp. and bronze saddle.



Ensure policies and procedures will be followed when excavating across foreign utilities and other underground structures. Ensure that the competent person *is available* while any trenching/excavation work is being performed. Ensure that benching, sloping, and shoring practices are followed when necessary. Ensure proper protection and support of existing utilities and structures.



Types of Pipes Used in the Distribution Field

Several types of pipe are used in water distribution systems, but only the most common types used by operators will be discussed. These piping materials include copper, plastic, galvanized steel, and cast iron. Some of the main characteristics of pipes made from these materials are presented below.

Plastic Pipe (PVC)

Plastic pipe has seen extensive use in current construction. Available in different lengths and sizes, it is lighter than steel or copper and requires no special tools to install. Plastic pipe has several advantages over metal pipe. It is flexible, it has superior resistance to rupture from freezing, it has complete resistance to corrosion and, in addition, it can be installed above ground or below ground.

One of the most versatile plastic and polyvinyl resin pipes is the polyvinyl chloride (**PVC**). PVC pipes are made of tough, strong thermoplastic material that has an excellent combination of physical and chemical properties. Its chemical resistance and design strength make it an excellent material for application in various mechanical systems.

Sometimes polyvinyl chloride is further chlorinated to obtain a stiffer design, a higher level of impact resistance, and a greater resistance to extremes of temperature. A CPVC pipe (a chlorinated blend of PVC) can be used not only in cold-water systems, but also in hot-water systems with temperatures up to 210°F. Economy and ease of installation make plastic pipe popular for use in either water distribution and supply systems or sewer drainage systems.



Various types and sizes of coupons or tap cut-outs. Collect and date these cut-outs to determine the condition of the pipe or measure corrosion.

Plastic Pipe (PVC)

This is currently the most common type of pipe used in distribution systems. It is available in diameters of 1/2" and larger, and in lengths of 10', 20', and 40'. A main advantage is its light weight, allowing for easy installation. A disadvantage is its inability to withstand shock loads. Since it is non-metallic, a tracer wire must be installed with the PVC water main so that it can be located after burial.

The National Sanitation Foundation (NSF) currently lists most brands of PVC pipe as being acceptable for potable water use. This information should be stamped on the outside of the pipe, along with working pressure and temperature, diameter and pipe manufacturer. PVC pipe will have the highest C Factor of all the above pipes. The higher the C factor, the smoother the pipe.

Cast Iron (CIP)

This is another type of piping material that has been in use for a long time. It is found in diameters from 3" to 48". Advantages of this material are its long life, durability and ability to withstand working pressures up to 350 psi. Disadvantages include the fact that it is heavy, difficult to install and does not withstand shock loading. Although it is not currently the material of choice, there is still a lot of it in the ground.

Ductile Iron Pipe (DIP)

This was developed to overcome the breakage problems associated with cast iron pipe. It can be purchased in 4" to 45" diameters and lengths of 18' to 20'. Its main advantage is that it is nearly indestructible by internal or external pressures. It is manufactured by injecting magnesium into molten cast iron. It is sometimes protected from highly corrosive soils by wrapping the pipe in plastic sheeting prior to installation. This practice can greatly extend the life of this type of pipe.

Steel Pipe

This pipe is often used in water treatment plants and pump stations. It is available in various diameters and in 20' or 21' lengths. Its main advantage is the ability to form it into a variety of shapes. It also exhibits good yielding and shock resistance. It has a smooth interior surface and can withstand pressures up to 250 psi. A disadvantage is that it is easily corroded by both soil and water.

To reduce corrosion problems, steel pipe is usually galvanized or dipped in coal-tar enamel and wrapped with coal-tar impregnated felt.

At present, however, coal-tar products are undergoing scrutiny from a health standpoint and it is recommended that the appropriate regulatory agencies be contacted prior to use of this material.

Asbestos Cement Pipe (ACP)

This pipe is manufactured from Portland cement, long fibrous asbestos and silica. It is available in diameters from 3" to 36" and in 13' lengths. Its main advantages are its ability to withstand corrosion and its excellent hydraulic flow characteristics due to its smoothness.

A major disadvantage is that it is brittle and is easily broken during construction or by shock loading. There is some concern regarding the possible release of asbestos fibers in corrosive water and there has been much debate over the health effects of ingested asbestos. Of greater certainty, however, is the danger posed by inhalation of asbestos fibers. Asbestos is considered a hazardous material, and precautionary measures must be taken to protect water utility workers when cutting, tapping or otherwise handling this type of pipe.



Galvanized Pipe

Galvanized pipe is commonly used for the water distributing pipes inside a building to supply hot and cold water to the fixtures. This type of pipe is manufactured in 21-ft lengths. It is galvanized (coated with zinc) both inside and outside at the factory to resist corrosion. Pipe sizes are based on nominal **INSIDE** diameters. Inside diameters vary with the thickness of the pipe. Outside diameters remain constant so that pipe can be threaded for standard fittings.



Copper

Copper is one of the most widely used materials for tubing. This is because it does not rust and is highly resistant to any accumulation of scale particles in the pipe. This tubing is available in four different types: K, L, and M for water and DWV for sewer applications.

K has the thickest walls, and M, the thinnest walls, with L's thickness in between the other two. The thin walls of copper tubing are soldered to copper fittings. Soldering allows all the tubing and fittings to be set in place before the joints are finished. Generally, the result will be faster installation.

Type K copper tubing is available as either rigid (hard temper) or flexible (soft temper) and is primarily used for underground service in the water distribution systems.

Soft temper tubing is available in 40- or 60-ft coils, while hard temper tubing comes in 12- and 20-ft straight lengths. Type L copper tubing is also available in either hard or soft temper and either in coils or in straight lengths. The soft temper tubing is often used as replacement plumbing because of the tube's flexibility, which allows easier installation.

Type L copper tubing is widely used in water distribution systems.

Type M copper tubing is made in hard temper only and is available in straight lengths of 12 and 20 ft. It has a thin wall and is used for branch supplies where water pressure is low, but it is **NOT** used for mains and risers. It is also used for chilled water systems, for exposed lines in hot-water heating systems, and for drainage piping.

Notice that the pipe has been illegally cut with a power saw blade. Please check with OSHA on details on handling this common water pipe. ACP will not corrode like metal pipe but will become slow and stained by iron over time. It is easily cracked by heavy loads, but easily repaired with a clamp.



ACP Pipe with illegal power saw cut marks.

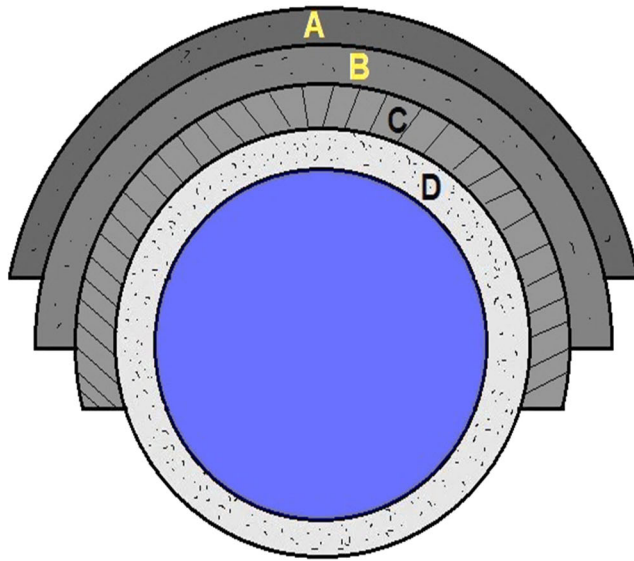

- A** - BITUMINOUS COATING
- B** - ZINC COATING
- C** - DUCTILE IRON PIPE
- D** - CEMENT MORTAR LINING

DUCTILE PIPE DETAIL DIAGRAM

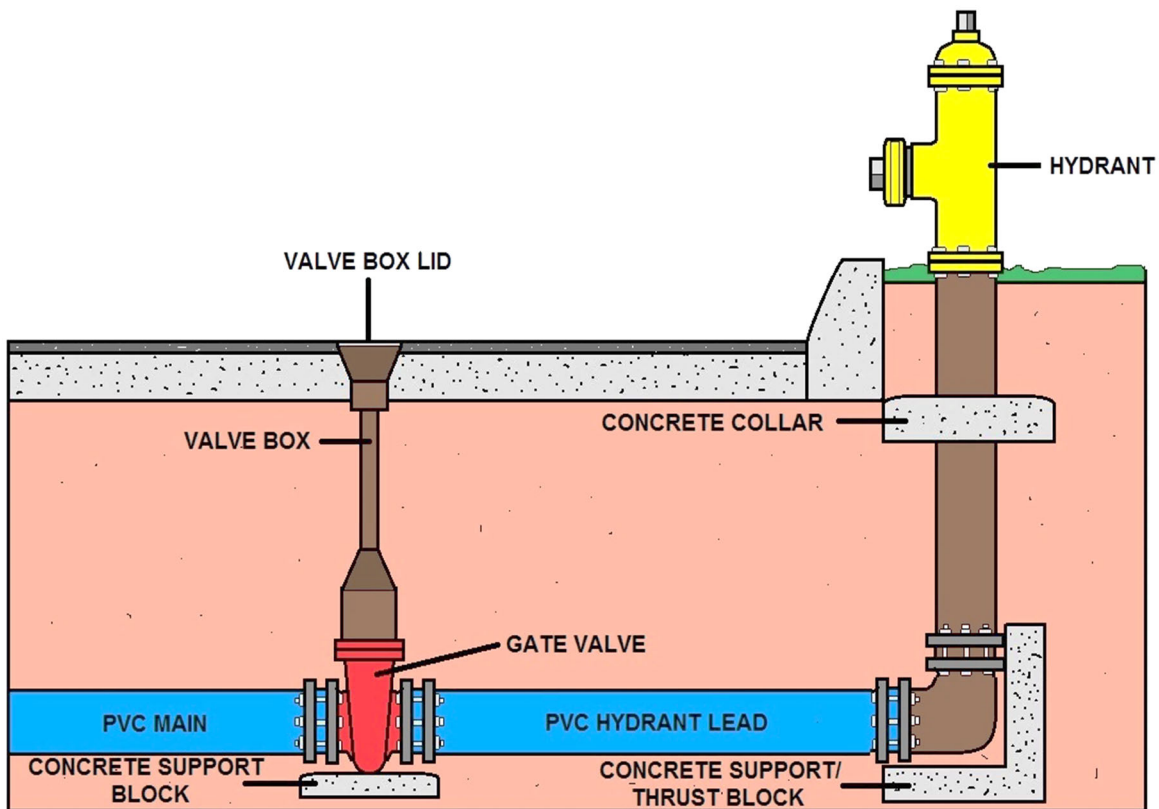

PROPER FIRE HYDRANT AND ISOLATING GATE VALVE INSTALLATION

Joists and Fittings

Fittings vary according to the type of piping material used. The major types commonly used in water service include elbows, tees, unions, couplings, caps, plugs, nipples, reducers, and adapters.

Besides bell-and-spigot joints, cast-iron water pipes and fittings are made with either flanged, mechanical, or screwed joints. The screwed joints are used only on small-diameter pipe.

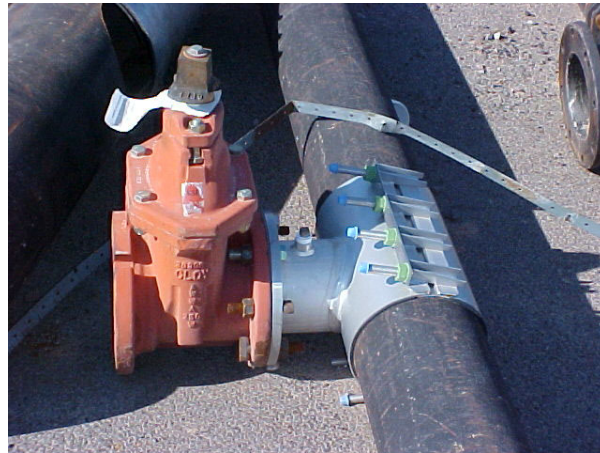

Tapping Sleeve

A gate valve is used to isolate sections of water mains, not to be used to throttle or regulate the flow. A globe valve should be used to regulate the flow. Be sure to chlorinate or disinfect all distribution parts such as valves and piping!

Caps

A pipe cap is a fitting with a female (inside) thread. It is used like a plug, except that the pipe cap screws on the male thread of a pipe or nipple.

Couplings

The three common types of couplings are straight coupling, reducer, and eccentric reducer. The **STRAIGHT COUPLING** is for joining two lengths of pipe in a straight run that do not require additional fittings. A run is that portion of a pipe or fitting continuing in a straight line in the direction of flow.

A **REDUCER** is used to join two pipes of different sizes. The **ECCENTRIC REDUCER** (also called a **BELL REDUCER**) has two female (inside) threads of different sizes with centers so designed that when they are joined, the two pieces of pipe will not be in line with each other, but they can be installed to provide optimum drainage of the line.



Elbows (or ELLS) 90° and 45°

These fittings (fig. 8-5, close to middle of figure) are used to change the direction of the pipe either 90 or 45 degrees. **REGULAR** elbows have female threads at both outlets. **STREET** elbows change the direction of a pipe in a closed space where it would be impossible or impractical to use an elbow and nipple.



Both 45 and 90-degree street elbows are available with one female and one male threaded end. The **REDUCING** elbow is similar to the 90-degree elbow except that one opening is smaller than the other is.

Nipples

A nipple is a short length of pipe (12 in. or less) with a male thread on each end. It is used for extension from a fitting. At times, you may use the **DIELECTRIC** or **INSULATING TYPE** of fittings. These fittings connect underground tanks or hot-water tanks. They are also used with pipes of dissimilar metals. These help slow down corrosion that starts inside the pipe and works to the outside of the pipe.

Do not heat or solder dielectric fittings. You may melt the plastic coating on them.

Zinc is a coating on the outside and inside of pipes to slow corrosion. This process is called "**Galvanization**".

Tees

A tee is used for connecting pipes of different diameters or for changing the direction of pipe runs. A common type of pipe tee is the **STRAIGHT** tee, which has a straight-through portion and a 90-degree takeoff on one side.



Notice the type of pipe connection device, it is known as a "Restraining Flange".

All three openings of the straight tee are of the same size. Another common type is the **REDUCING** tee, similar to the straight tee just described, except that one of the threaded openings is of a different size than the other.

Distribution System Hydrant Maintenance/Flushing

Fire hydrants provide not only fire protection, but also a method of moving large amounts of water out of various portions of the water system if microbiological and/or chemical contamination occurs and an emergency is declared. As a result, fire hydrant maintenance is conducted on all fire hydrants to assure their viability at all times.

Fire hydrant maintenance includes the following specific procedures:

- All fire hydrants are inspected for leakage and repairs are made when necessary.
- The fire hydrant is fully opened and the ease of operation is noted.
- The hydrant flow is directed to waste. During this procedure, care is taken to direct and/or disperse the flow to minimize property damage.
- All fire hydrant nozzle caps are inspected for thread damage and lubricated to provide ease of operation.
- All fire hydrant nozzle cap thread gaskets are inspected and replaced as necessary.
- If a fire hydrant is found to be inoperable, a tag is placed on the hydrant, and the “**out of service**” is immediately reported to the Fire Department.
- Accurate records related to the maintenance procedures performed on the fire hydrants are maintained by the water department.



Most distribution departments will have an assigned fire hydrant repair crew.

Water Main Installation

Installation of new or replacement pipe sections should be in accordance with good construction practices. The line must be buried a minimum of 30" below the ground surface to prevent freezing. The line must be bedded and backfilled properly, ensuring protection from weather and surface loadings.

Also, thrust blocking (*Kickers*) at all bends, tees, and valves is essential to hold the pipe in place and prevent separation of line sections. Thrust blocking is not necessary if the pipe is welded.

Disinfection of new installations or repaired sections is required prior to placing them in service. This can be accomplished by filling the line with a 25 mg/l free chlorine solution and allowing it to stand for 24 hours. Valves and fittings used in the waterworks industry are made of cast iron, steel, brass, stainless and fiberglass.

Enough gate valves should be placed throughout the system to enable problem areas (leaks, etc.) to be isolated and repaired with minimal service disruption. Air relief valves should be installed at highpoints in the system. Valves should be installed with valve boxes and covers.



Regardless of the type of pipe installed, certain maintenance routines should be performed on the distribution system to maintain water quality and optimal service. These programs should be scheduled and performed on a regular basis.

Flushing at blowoffs on dead end lines and at fire hydrants throughout the system should be done at least twice per year. Flushing is needed to remove stagnant water in dead ends and to remove accumulated sediment that results from turbidity, iron, manganese, etc.

This should also help minimize customer complaints of water quality. Flushing should always be done from the source to the ends of the system. Affected customers should be notified of this process in advance. To do an adequate job of flushing, the flow should reach a velocity of at least 2.5 feet per second, known as the "*minimum cleansing velocity*" of the system (at hydrant locations).

These tests are important to determine the adequacy of the distribution system in transmitting water, particularly during days of peak demand. Also, these tests can help determine if pipe capacity is decreasing over time due to internal corrosion or deposits.

Pressure tests should be done at various locations in the distribution system several times per year. This helps to monitor the performance of the system and alert the operator to problems such as leaks or internal deposits. It is sometimes advantageous to have certain points in the system continuously monitored to provide a constant evaluation of the system.

Disinfection of Repaired Pipeline Sections

You should recognize that the protection of the public health of its water customers is the primary role of a water provider. Accordingly, the disinfection of all repaired water appurtenances is paramount to the return of the water system to its normal operation mode. Prior to initiating the disinfection process, a thorough cleaning of all repaired pipes and or reservoirs must be accomplished. The following table indicates the amount of Sodium Hypochlorite and Calcium Hypochlorite that is necessary to disinfect 100,000 gallons of water.

Disinfection Table For 100,000 Gallons of Water

Desired Chlorine Dose in MG/L	Pounds of Liquid Chlorine Required	Gallons of Sodium Hypo Chlorite			Pounds of Calcium Hypo Chlorite Required. 65% Available
		10% Available Chlorine	15% Available Chlorine	5% Available Chlorine	
2	1.7	3.9	2.0	1.3	2.6
10	8.3	19.4	9.9	12.8	12.8
50	42	97	49.6	64	64

Spare Parts Inventory

You should maintain a complete inventory of spare parts for the maintenance and repair of all water transmission and distribution lines. The water lines in the system range in size between ¾ inch and 16 inches in diameter.

Additionally, you should maintain spare motor controls, pump ends, and motors for all wells and booster stations. Water system personnel can repair the entire range of water lines without assistance from outside contractors. Stand-by warehouse personnel should be available twenty-four hours per day to assist in the delivery of spare parts in instances requiring emergency repair.

Preventative maintenance can extend the life of any water pipeline. Pipes can deteriorate on the inside as a result of corrosion and on the outside as a result of aggressive soil and moisture. The Water Department should maintain an intense leak detection program to effectively reduce operating costs and provide revenue savings by reducing lost and unaccounted for water. Leaks can originate in joints and fittings or any corroded portion of a pipeline.

Additionally, leaks will undermine the pavement and water soak the area around the leaking section of pipeline. When leaks are discovered, they should be repaired within twenty-four hours after properly locating all underground utilities through the Underground Service Alert or “Blue Stake” procedure.

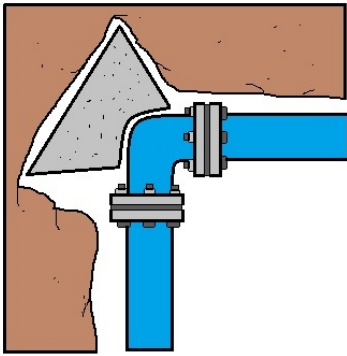

BEND

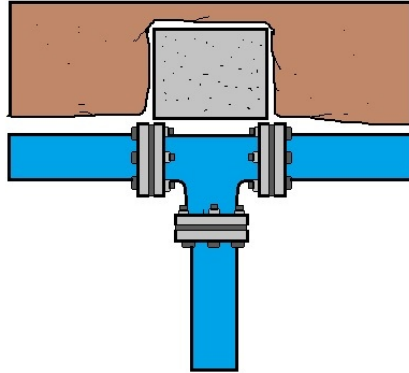

TEE

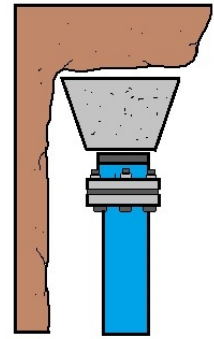

DEAD END

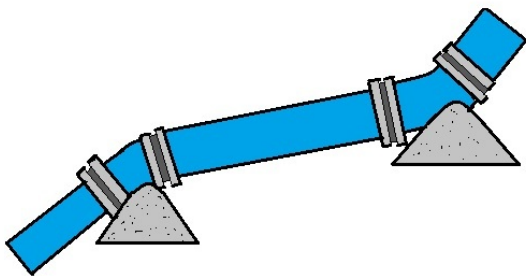

**VERTICAL THRUST
BURIED MAINS**

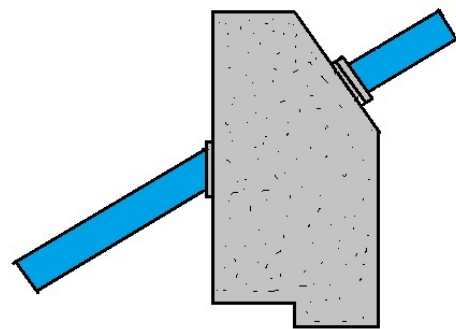

GRADIENT THRUST

PROPER THRUST BLOCKING EXAMPLES

Troubleshooting Table for Distribution System

Problem

1. Dirty water complaints
2. Red water complaints
3. No or low water pressure
4. Excessive water usage.

Possible Causes

- 1A. Localized accumulations of debris, solids/particulates in distribution mains.
- 1B. Cross connection between water system and another system carrying non-potable water.
- 2A. Iron content of water from source is high. Iron precipitates in mains and accumulates.
- 2B. Cast iron, ductile iron, or steel mains are corroding causing “rust” in the water.
- 3A. Source of supply, storage or pumping station interrupted.
- 3B. System cannot supply demands.
- 3C. Service line, meter, or connections shutoff, or clogged with debris.
- 3D. Broken or leaking distribution pipes.
- 3E. Valve in system closed or broken.
- 4A. More connections have been added to the system.
- 4B. Excessive leakage (>15% of production) is occurring, meters are not installed or not registering properly.
- 4C. Illegal connections have been made.

Possible Solutions

- 1A. Collect and preserve samples for analysis if needed. Isolate affected part of main and flush.
- 1B. Collect and preserve samples for analysis if needed. Conduct survey of system for cross connections. Contact State Drinking Water Agency.
- 2A. Collect and test water samples from water source and location of complaints for iron. If high at both sites, contact regulatory agency, TA provider, consulting engineer or water conditioning company for assistance with iron removal treatment.
- 2B. Collect and analyze samples for iron and corrosion parameters. Contact State Drinking Water Agency, TA provider, consulting engineer or water conditioning company for assistance with corrosion control treatment.
- 3A. Check source, storage and pumping stations. Correct or repair as needed.
- 3B. Check to see if demands are unusually high. If so, try to reduce demand. Contact State Drinking Water Agency, TA provider or consulting engineer.
- 3C. Investigate and open or unclog service.
- 3D. Locate and repair break or leak.
- 3E. Check and open closed isolation and pressure-reducing valves. Repair or contact contractor if valves are broken.
- 4A. Compare increase in usage over time with new connections added over same period. If correlation evident take action to curtail demand or increase capacity if needed. Contact State Drinking Water Agency, TA provider or consulting engineer.
- 4B. Conduct a water audit to determine the cause. If leakage, contact regulatory agency, and consulting engineer or leak detection contractor.
- 4C. Conduct survey to identify connections.

Water Use or Demand Introduction

Water system demand (usage) comes from a number of sources including residential, commercial, industrial and public consumers as well as some unavoidable loss and waste. If fire protection is desired, that could also represent a rather significant (although not continuous) demand upon the system. The combination of storage reservoirs and distribution lines must be capable of meeting consumers' needs for quality, quantity and pressure at all times. The quantity of water used in any community varies from 50 to 500 gallons per person per day.

A common design assumption is to use from 100 to 200 gallons per person per day for average domestic use. The maximum daily use is approximately 2 to 3 times the average daily use. Maximum daily use is usually encountered during the summer months and can vary widely depending on irrigation practices.

Water Pressure

For ordinary domestic use, water pressure should be between 25 and 45 psi. A minimum of 60 psi at a fire hydrant is usually adequate, since that allows for up to 20-psi pressure drop in fire hoses.

In commercial and industrial districts, it may be common to have 75 psi or higher. 20 psi is considered the minimum required at any point in the water system, so that backflow and infiltration is prevented.

Pressure is provided by the direct force of the water (such as water from a pump), or by the height of the water (such as a storage reservoir). 2.31 feet of water is equal to 1 psi, or 1 foot of water is equal to about a half a pound (.433 pounds to be exact).

Storage and Distribution

The cost of supplying water to the users of any water system includes the installation of storage and distribution facilities. Also, there are on-going maintenance costs associated with cleaning, repairing and replacing these facilities. The distribution system must also protect water quality between the source and the customer's tap.

Proper construction is important in maintaining system integrity. Care must be taken that no foreign material is introduced into the system during pipe laying operations. Pipe ends should be covered at the end of the work day or during interruptions of construction.

All pipes, joints and fittings should be pressure tested and disinfected with a 5% chlorine solution such as household bleach before backfilling. It is also important that all materials in contact with potable water meet the requirements of the National Sanitation Foundation (NSF) or American Water Works Association (AWWA) or have equivalent third-party certification. This includes solders (must be lead-free), pipes, joining and sealing materials, and protective coatings.

Water Storage Sub-Section

Water storage facilities and tanks are required for pressure and firefighting demands and vary in size, shape, and application. There are different types that are used in the water distribution systems, such as standpipes, elevated tanks and reservoirs, hydropneumatic tanks and surge tanks.

These tanks serve multiple purposes in the distribution system. Just the name alone can give you an idea of its purpose.

- **SURGE tanks**
- **RESERVOIRS** – Large concrete or steel underground facilities
- **ELEVATED tanks** -Water towers and Standpipes

Surge Tanks

What really causes water main breaks - **ENERGY** - when released in a confined space, such as a water distribution system? Shock waves are created when hydrants, valves, or pumps are opened and closed quickly, trapping the kinetic energy of moving water within the confined space of a piping system.

These shock waves can create a turbulence that travels at the speed of sound, seeking a point of release.

The release the surge usually finds is an elevated tank, but the surge doesn't always find this release quickly enough. Something has to give, often times, it's your pipe fittings.

Distribution operators are aware of this phenomenon! It's called **WATER HAMMER**.

This banging can be heard as water hammer.

Try it at home - turn on your tap, then turn it off very quickly. You should hear a bang, and maybe even several. If you turn the tap off more slowly, it should stay quiet, as the liquid in the pipes slows down more gradually.

A Surge tank should never be used for water storage.

The goal of the water tower or standpipe is to store water high in the air, where it has lots of gravitational potential energy. This stored energy can be converted to pressure potential energy or kinetic energy for delivery to homes.

Since height is everything, building a cylindrical water tower is inefficient. Most of the water is then near the ground. By making the tower wider near the top, it puts most of its water high up.



Storage Reservoirs

Storage reservoirs allow the system to meet the fluctuations in demand described earlier. It is recommended that the volume of storage be equal to from one to three days of the system's average daily use.

It is also recommended that storage reservoirs be located at a high enough elevation to allow the water to flow by gravity to the distribution system.

This, coupled with restricted usage on the part of the consumers, should provide an uninterrupted water supply in the event of pump failure, loss of power or an acute contamination event or cross-connection. Also, if applicable, some storage for fire protection should be provided.

Reservoirs are also used as detention basins to provide the required chlorine contact time necessary to ensure the adequacy of disinfection. As such, the contact time in a reservoir is greatly improved when the reservoir is constructed with a separate inlet and outlet pipe, preferably located on opposite sides of the reservoir and at different levels. Also, baffles inside the reservoir (walls, curtains, or spirals) increase the contact time by preventing the water from leaving the reservoir too quickly (known as "short-circuiting").

Steel Reservoirs

Steel reservoirs or tanks generally have lower construction and installation costs than concrete, but require more maintenance.

To protect against corrosion, the exterior should be kept cleaned and painted. Interiors of steel reservoirs are commonly coated with an epoxy or enamel-type finish. Some coal-tar linings used in the past have apparently degraded over time and are implicated in the release of small amounts of solvents into the stored water.

Steel reservoirs are usually welded or bolted together and are manufactured in a variety of sizes. Small steel reservoirs can be manufactured off-site and then trucked and lifted into place. Steel tanks should be inspected once a year and repainted every 5-7 years.

Steel tank should also have cathodic protection and be screened to keep birds and insects out. The maintenance program for reservoir tanks should call for annual draining for a complete inspection of the interior.

Cleaning and disinfection prior to placing the reservoir or tank back in service is necessary.

Disinfection by chlorine can be accomplished by one of three methods:

1. Fill the tank or reservoir with a 25 mg/1 chlorine solution and leave it for 24 hours.
2. Fill the reservoir with a 50 mg/1 chlorine solution and leave it for 3 hours.
3. Spray or brush on a 200 mg/1 chlorine solution and allow it to remain for 3 hours.

The chlorinated water shall be disposed of in a manner that will not have an adverse effect on the environment. Check with your state environmental, health or drinking water section.

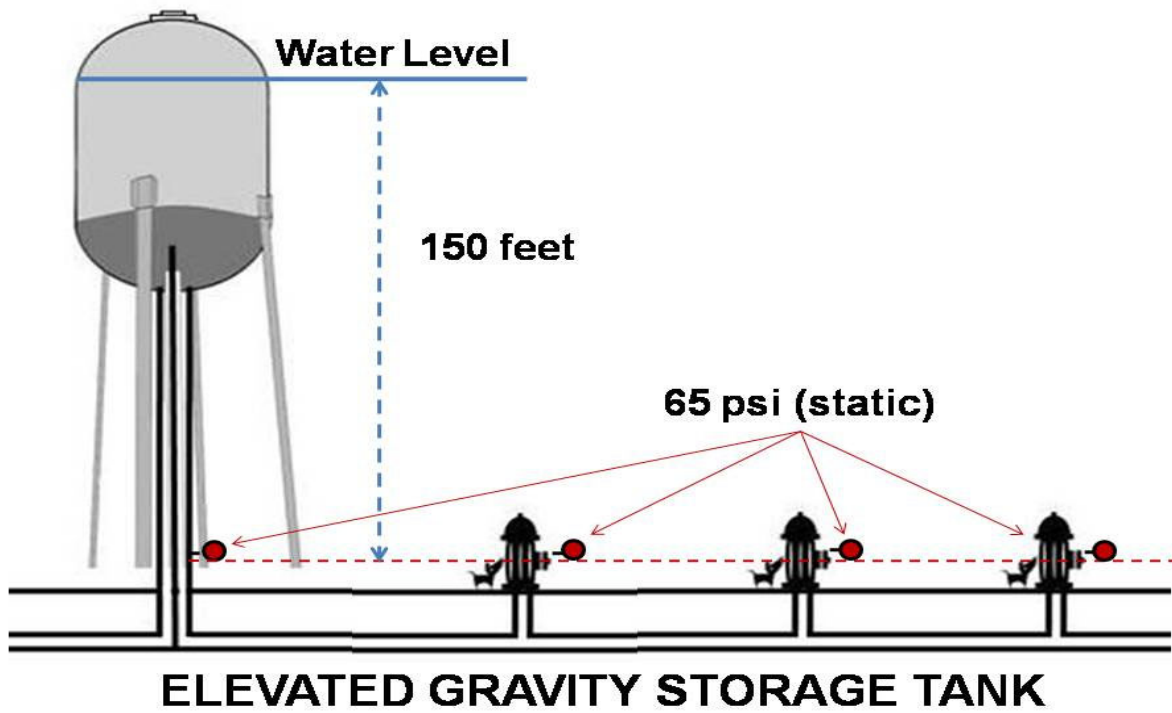
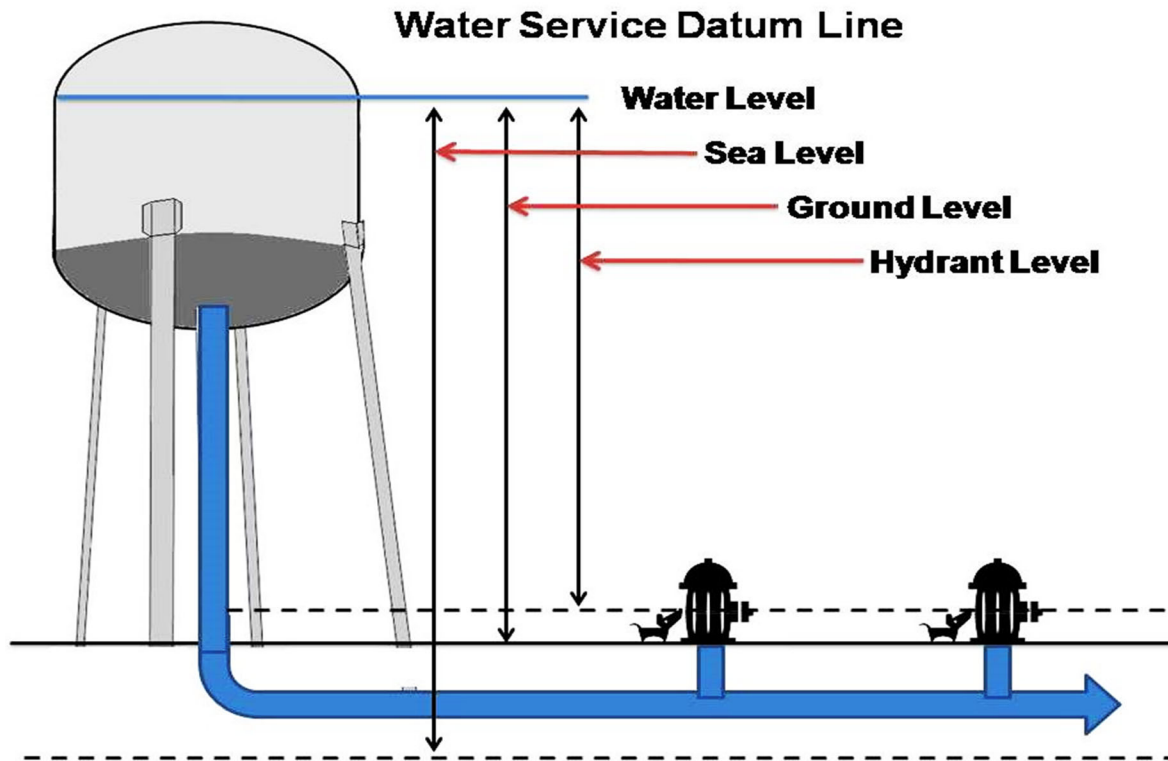

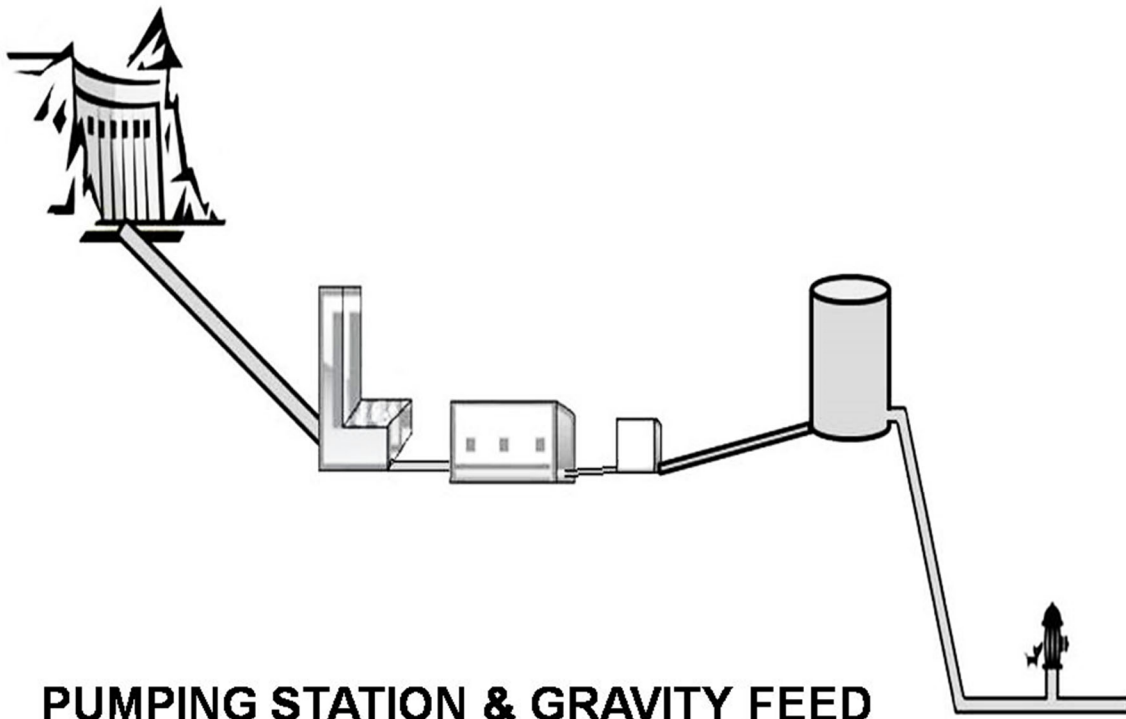

PUMPING STATION & GRAVITY FEED

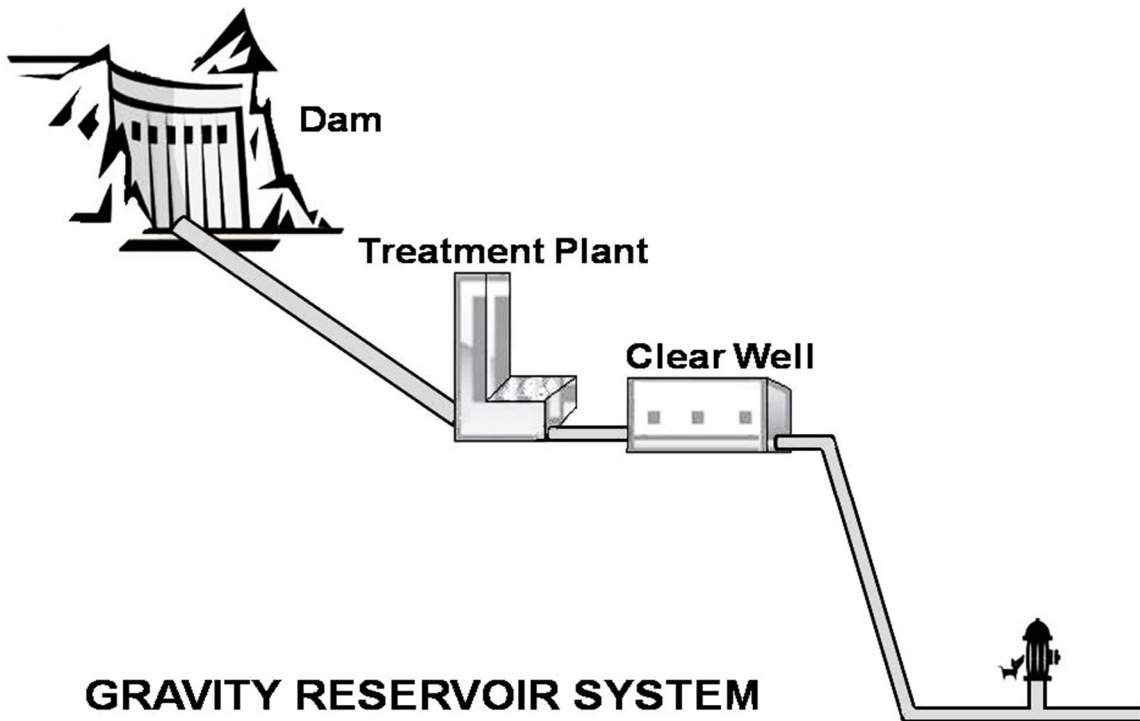

GRAVITY RESERVOIR SYSTEM

Distribution Storage Functions

Storage within a distribution system enables the system to process water at times when treatment facilities otherwise would be idle. It is then possible to distribute and store water at one or more locations in the service area that are closer to the user.



1. Advantages.

The principal advantages of distribution storage include the fact that storage equalizes demands on supply sources, production works, and transmission and distribution mains. As a result, the sizes or capacities of these elements need not be so large. Additionally, system flows and pressures are improved and stabilized to better serve the customers throughout the service area. Finally, reserve supplies are provided in the distribution system for emergencies, such as firefighting and power outages.

2. Meeting system demands and required fire flow.

The location, capacity, and elevation (if in fact elevated) of distribution storage are closely associated with system demands and the variations in demand that occur throughout the day in different parts of the distribution system. System demands can be determined only after a careful analysis of an entire distribution system. However, some general rules may serve as a guide to such analysis.

Elevated and Ground-Level Storage

Storage within the distribution system normally is provided in one of two ways: elevated storage or ground storage with high-service pumping. It should be noted that elevated storage provides the best, most reliable and most useful form of storage, particularly for structural fire suppression.

Elevated Storage

Properly sized elevated water tanks provide dedicated fire storage and are used to maintain constant pressure on the water supply distribution system.

Domestic water supplies are regularly fed to the system from the top 10 to 15 feet of water in the elevated tanks. As the water level in the tank drops, the tank controls call for additional high-service pumps to start in order to satisfy the system demand and refill the tanks. The high-service pumps are constant-speed units, which can operate at their highest efficiency point virtually all the time. The remaining water in the tanks (70 to 75 percent) normally is held in reserve as dedicated fire storage. This reserve will feed into the system automatically as the fire-flow demand and the domestic use at a specific time exceed the capacity of the system's high-service pumps.

Ground Storage

Since water kept in ground storage is not under any significant pressure, it must be delivered to the point of use by pumping equipment. This arrangement limits the water distribution system's effectiveness for fire suppression in three ways:

1. There must be sufficient excess pumping capacity to deliver the peak demand for normal uses as well as any fire demand, which requires a generally unused investment in pumping capacity. The pumps are activated periodically to redistribute the water in the holding tank to avoid stagnation of the water.
2. Standby power sources and standby pumping systems must be maintained at all times because the system cannot function without the pumps.
3. The distribution lines to all points in the water distribution system must be significantly oversized to handle peak delivery use plus fire flow, no matter where the fire might occur near one or more fire hydrants on the piping system.

However, in hilly areas it is frequently possible to install ground reservoirs at sufficient elevation so that the water would "float" on the distribution system. This eliminates the need for pumps at the ground-storage facility. If the desired overflow elevation can be achieved on a hill, a considerably larger storage capacity can be installed when compared to an elevated tank. This may result in placement of the storage facility on a hill in a less desirable location.

Such a placement would provide larger storage capacity than could be achieved by an elevated storage tank(s), or it should provide the equivalent storage more economically. When ground-level storage is used in areas of high fire risks, the energy that would be needed to deliver the water is lost on the initial delivery of water to the tank.

The water supply must be re-pumped and re-pressurized with the consequent addition of more standby generators and more standby pumps. In addition, the system's high-service pumps must be either variable speed or controlled by discharge valves to maintain constant system pressures.

This equipment is expensive, uses additional electrical power, and requires extensive operation and maintenance. Frequently, the additional capital costs for pumps, generators, and backup systems, and the long-term energy costs, significantly increase the costs of a ground-storage system.

Chemical Contaminants in Storage Tanks

Coating materials are used to prevent corrosion of steel storage tanks and to prevent moisture migration in concrete tanks. Through the 1970's, coatings used in finished water storage facilities were primarily selected because of their corrosion resistance and ease of application. This led to the use of industrial products like coal tars, greases, waxes and lead paints as interior tank coatings. These products offered exceptional corrosion performance but unknowingly contributed significant toxic chemicals to the drinking water. Grease coatings can differ greatly in their composition from vegetable to petroleum based substances and can provide a good food source for bacteria, resulting in reduced chlorine residuals and objectionable tastes and odors in the finished water (Kirmeyer et al. 1999).

Indicators of Water Quality Problems within Storage Facilities

There are several indicators that may suggest water quality problems are occurring within storage facilities. These include aesthetic considerations that may be identified by consumers, as well as the results of storage facility monitoring efforts. It should be noted that indicators can be triggered by factors other than water age, such as insufficient source water treatment, pipe materials, and condition/age of distribution system and storage facility.

Aesthetic Indicators

The following indicators may be identified during water consumption:

- Poor taste and odor – Aged, stale water provides an environment conducive to the growth and formation of taste and odor causing microorganisms and substances.
- Improperly cured coatings can impart taste and odor to the stored water.
- Sediment accumulation – Improperly applied coatings can slough off reservoirs and accumulate at the bottom. Sediment carried into the storage facility from the bulk water can accumulate within the reservoir if reservoir maintenance and cleaning are not routinely performed.

Water Temperature

Stagnant water will approach the ambient temperature. Temperature stratification within reservoirs will impede mixing. Turnover due to stratification can entrain accumulated sediment.

Monitoring Indicators

The following indicators require sample collection and analysis:

- Depressed disinfectant residual – Chlorine and chloramines undergo decay over time.
- Elevated DBP levels – The reaction between disinfectants and organic precursors occur over long periods.
- Elevated bacterial counts (i.e., heterotrophic plate count).
- Elevated nitrite/nitrate levels (nitrification) for chloraminating systems.

References

Water Supply Systems• Vol. II: Evaluation Methods October 2008 FEMA U.S. Fire Administration Harry E. Hickey, Ph.D. EPA Office of Water (4601M), Office of Groundwater and Drinking Water, Distribution System Issue Paper, Finished Water Storage Facilities

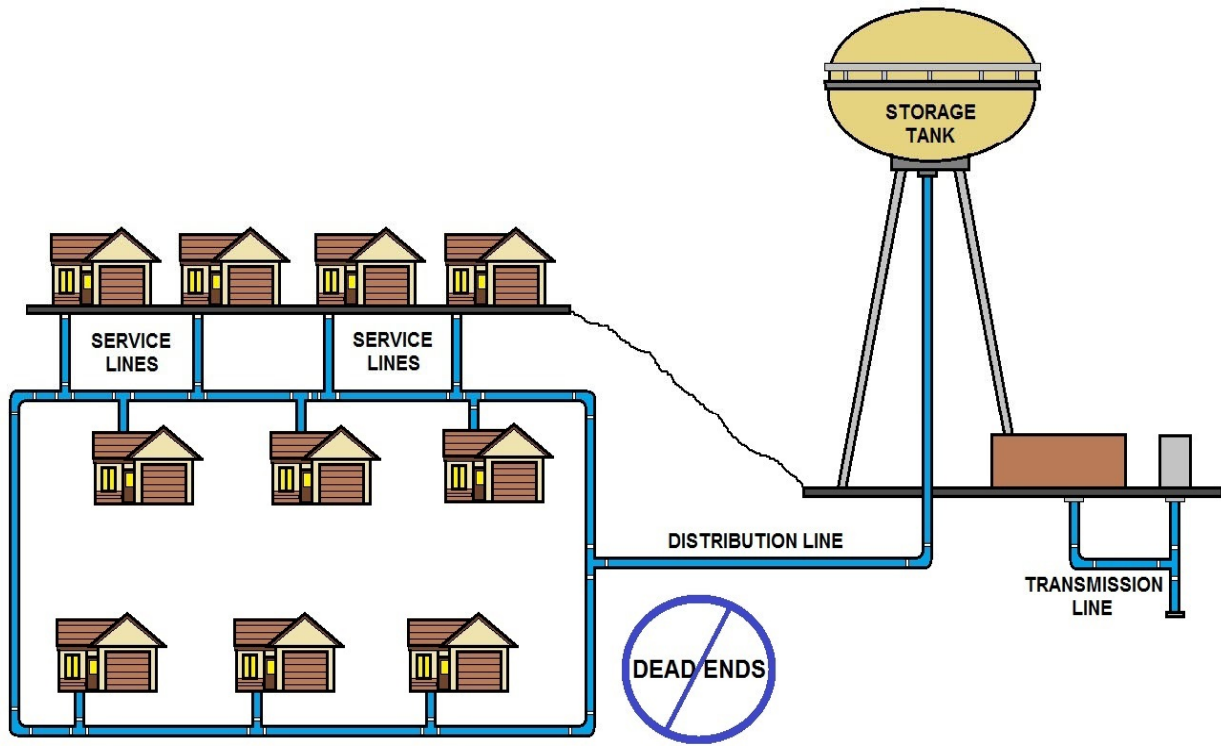

EXAMPLE OF BASIC WATER DISTRIBUTION SYSTEM

Hydropneumatic Tank Section

Hydropneumatic Tanks Out of Service for Maintenance Effects on the Water Supply

Whenever a tank must be taken out of service for maintenance, the operator should insure that the water pressure is maintained by other back-up tanks in the system. If this is not possible, customers should be given as much advance notice as possible, maintenance should be conducted during periods of low water demand, and the maintenance should be conducted as quickly as possible to reduce the time without water service.

Troubleshooting Hydropneumatic Tank Problems

The purpose of a hydropneumatic tank is to provide air for the water system. It is the responsibility of the operator to perform basic troubleshooting of problems in hydropneumatic tank systems. The operator has to decide, based on his/her own training and capability when a problem requires assistance from another operator or an outside expert.

Operators should not hesitate to seek assistance if they are uncomfortable with a particular problem or situation. Remember, the goal is to provide a safe and consistent supply of water and this cannot always be accomplished by one or two individuals who may have many other responsibilities. Corrective action should only be performed by individuals who are trained and skilled in that particular area.

Corrective actions by unskilled individuals could result in personal injury or serious damage to the water system equipment. The following troubleshooting table is provided to assist operators of small water systems to troubleshoot basic problem with hydropneumatic tanks.

It must be recognized that problems occurring in hydropneumatic tanks could also be related to the well, water supply pump and controls, and the distribution system, therefore other troubleshooting tables included in this manual should be consulted in addition to the troubleshooting table for hydropneumatic tanks.

Troubleshooting Table for Hydropneumatic Tanks Problem

1. Well pump will not start.
2. Well pump will not shut off.
3. Well pump starts and stops too frequently (Excessive cycle rate).
4. Sand / sediment is present in the water.
5. Air is present in the water.
6. Oil is present in the water.
7. Dirt and or bacteria present in the water.
8. Excessively high distribution system pressure (greater than 70 psi).
9. Excessively low distribution system pressure (normal working pressure below 40 psi or occasional pressures below 20 psi during peak usage).
10. Corrosion present on outside of tank.
11. Tank is unstable and can be easily be moved, or tank is supported by the piping.

Possible Hydropneumatic Tank Problem Causes

- 1A. Circuit breaker or overload relay tripped.
- 1B. Fuse(s) burned out.
- 1C. No power to switch box.
- 1D. Short, broken or loose wire.
- 1E. Low voltage.
- 1F. Defective motor.
- 1G. Defective pressure switch.
- 2A. Defective pressure switch.
- 2B. Cut-off pressure setting too high.
- 2C. Float switch or pressure transducer not functioning.
- 3A. Leaking foot valve or check valve.
- 3B. Defective pressure switch or automatic control system. High or Low pressure cutoff switches may need to be adjusted.
- 3C. Excessive water use or major leak in water distribution system.
- 3D. Water-logged hydropneumatic tank.
- 3E. Air-logged hydropneumatic tank.
- 4A. Problems with well screen or gravel
- 4B. If there is iron or manganese in the well water and it is not removed before the hydropneumatic tank, and the air in the hydropneumatic tank comes into direct contact with the water in the tank, then the iron and manganese could be oxidizing and settling in the tank. Also, sediment could be present in the distribution system.
- 5A. If there is a check valve between the well pump and the hydropneumatic tank, and air is present on the well side of the check valve, then the pump may be breaking suction. In this case, the water level in well is near or below the pump intake.
- 5B. If there is a check valve between the well pump and the hydropneumatic tank, and air is present only on the hydropneumatic tank side of the check valve and in the distribution system, then air from hydropneumatic may be tank entering water.
- 6A. Oil leaking from air compressor.
- 7A. Refer to troubleshooting table on "*hypochlorinators*."
- 7B. Replace filter. Also review troubleshooting table on "*hypochlorinators*." Notify water system specialist.
- 8A. See Problem Item #2 in this troubleshooting table.
- 9A. Refer to troubleshooting guide section "*Pumps*." Notify supervisor.
- 10A. Clean area with a wire brush. Prime and paint the surface with. Do not chip rust from the tank unless it is drained and out of service. If chipping is required, contact a tank corrosion specialist. The tank may not be structurally sound and re-pressurizing could cause further damage or personal injury. Note: 50 psi exerts a pressure of 3.5 tons per square foot! Never paint the tank interior without first consulting the state regulatory authority.
- 11A. Provide suitable and permanent supports so the tank cannot be moved and the piping is not supporting the weight of the tank. This may require taking the system out of service while these repairs are made. Never try to move a tank that is pressurized. Notify your water system specialist.

Possible Hydropneumatic Tank Solutions

- 1A. Reset breaker or manual overload relay.
- 1B. Check for cause and correct, replace fuse(s).
- 1C. Check incoming power supply. Contact power company.
- 1D. Check for shorts and correct, tighten terminals, replace broken wires.
- 1E. Check incoming line voltage. Contact power company if low.
- 1F. Contact electrical contractor.
- 1G. Check voltage of incoming electric supply with pressure switch closed. Contact power company if voltage low. Perform maintenance on switch if voltage normal. Refer to troubleshooting table on "*Pumps.*"
- 3A. Contact well specialist.
- 3B. Contact well specialist or electrician.
- 3C. Locate and repair leak.
- 3D. Check air-to-water ratio from sight tube (if provided). If the tube is completely filled with water or if the water level exceeds 2/3 of the volume of the tank, then air will have to be introduced into the tank. Check tank and air system for leaks. The optimum air-to-water ratio in the hydropneumatic tank should be 2/3 water to 1/3 air. If the problem persists or if there is no sight tube, notify water system specialist.
- 3E. Check air-to-water ratio from sight tube (if provided). If the tube is completely filled with air or if the water level is less than 1/2 of the volume of the tank, then air will have to be bled from the tank. The optimum air-to-water ratio should be 2/3 water to 1/3 air. If the problem persists or if there is no sight tube, notify water system specialist.
- 4A. Contact well contractor.
- 4B. Check air-to-water ratio from sight tube (if provided). If the tube is completely filled with air or if the water level is less than 1/2 of the volume of the tank, then air will have to be bled from the tank. The optimum air-to-water ratio should be 2/3 water to 1/3 air. If the problem persists or if there is no sight tube, notify water system specialist. If there is a physical separation between the air and water in the tank, then the separator could have broken. Notify water system specialist.
- 5A. Partially throttle discharge valve. Notify supervisor or well service company.
- 5B. Improve removal of iron and manganese. If the hydropneumatic tank is equipped with a drain, open the drain valve and discharge the sediment to waste.
- 6A. Check the oil separator on the discharge side to the air compressor.
Notify water system specialist. Consider replacing the unit with a non-oil lubricated type unit.
- 7A. Inadequate disinfection.
- 7B. Intake filters on air compressor broken or dirty.
- 8A. Automatic pressure controls needs adjustment or cut-out sequence is not functioning.
- 9A. Automatic pressure controls needs adjustment or cut-in sequence is not functioning.
- 10A. Inadequate protective coating (paint).
- 11A. Tank supports are inadequate.

Note: If the water supply pump is running constantly, excessive pressures can develop in the hydropneumatic tank and distribution system. The tank should be equipped with a pressure relief valve that opens at approximately 100 psi. This may protect the tank from damage but it is possible that the distribution system could be damaged if pressures exceed normal working pressures. Check for leaks throughout the service area. Notify electrician experienced with industrial controls.

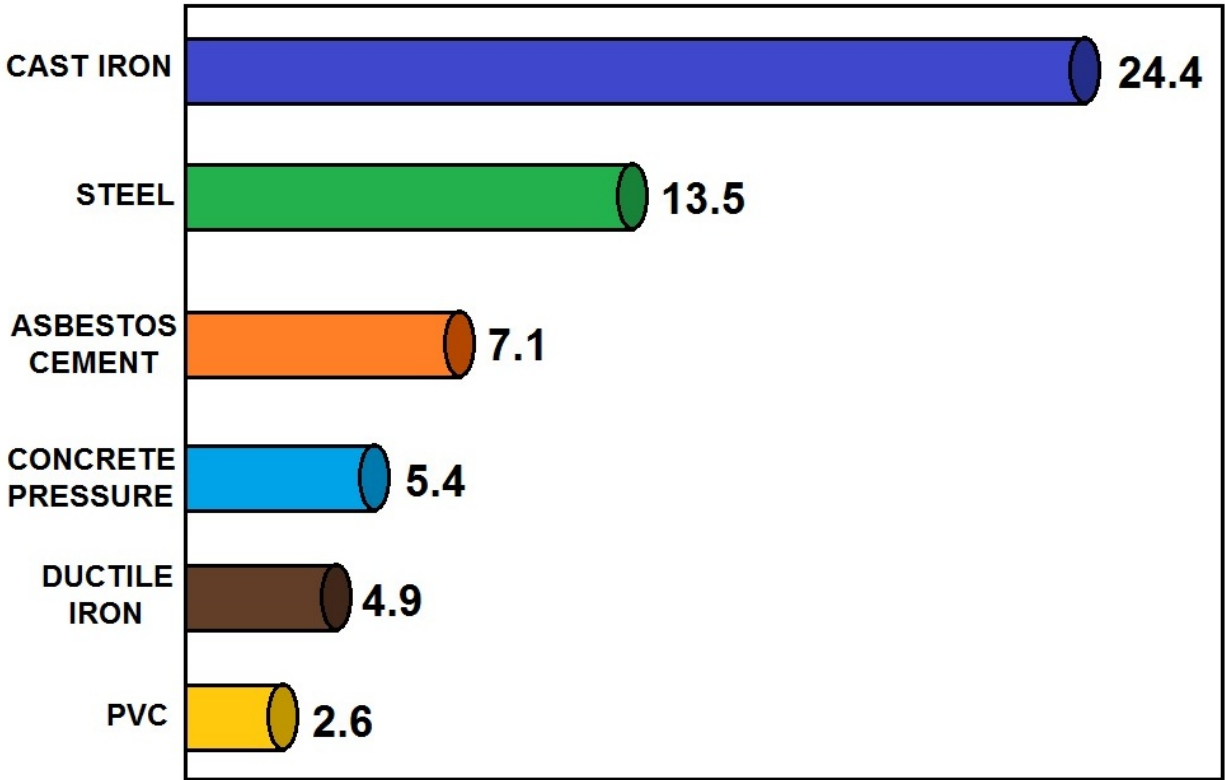

WATER MAIN BREAKS

RATES REFLECT # OF BREAKS PER 100 MILES OF INSTALLED PIPE

Water Distribution Section Post Quiz

Answers are found before the references in the very rear of manual.

System Layouts

1. Newer water systems are frequently expanded with planning and developed into a tree-like system.
A. True B. False
2. The Tree system consists of a single main that _____ as it leaves the source and progresses through the area originally served.

Friction Loss

3. The damaged section can be isolated and the remainder of the system will still carry pressure, water will not be distributed if a single section fails.
A. True B. False
4. During periods of peak fire flow demand, there will be less impact from _____ in water mains as the velocity within any given section of main.

Water Storage Facilities

5. According to the text, there are different types that are used in the water distribution systems, such as stand pipes, elevated tanks and reservoirs, hydropneumatic tanks and?
6. According to the text, which of the following terms can be converted to pressure potential energy or kinetic energy for delivery to homes?

Storage Reservoirs

7. It is recommended that _____ be located at a high enough elevation to allow the water to flow by gravity to the distribution system.
8. According to the text, some storage for this term should be provided.
9. Which of the following terms inside the reservoir increase the contact time by preventing the water from leaving the reservoir too quickly?

Water Storage Introduction

10. Which of the following terms prevents contamination of water as it travels to the customer, finished water storage facilities are an important component of the protective distribution system?

Storage and Distribution

11. Proper construction is important in maintaining system integrity and the distribution system must also protect?

Steel Reservoirs

12. Steel reservoirs or tanks generally have higher construction and installation costs than concrete, and require less maintenance.
A. True B. False

Categories of Finished Water Storage Facilities

13. Ground storage tanks or reservoirs can be below ground, and may be accompanied by pump stations if not built at elevations providing the required system pressure by?

Municipal Water Supply Systems

14. In hilly areas, it is frequently possible to install ground reservoirs at sufficient elevation so that the water would “float” on the distribution system.

A. True B. False

Troubleshooting Hydropneumatic Tank Problems

15. The purpose of a hydropneumatic tank is to provide pressure for the water system.

A. True B. False

16. It is the responsibility of the operator to perform basic troubleshooting of problems in hydropneumatic tank systems.

A. True B. False

Topic 4– Cross-Connection-Backflow Prevention Section

Section Focus: You will learn the basics of cross-connection protection and backflow prevention. At the end of this section, you will be able to describe cross-connection dangers and backflow prevention methods. There is a post quiz at the end of this section to review your comprehension and a final examination in the Assignment for your contact hours.

Scope/Background: The Environmental Protection Agency (EPA) holds local water providers responsible for maintaining a certain amount of purity in potable water systems. Many states and/or local municipalities require annual testing of backflow prevention assemblies. In most cases, the law requires a double check (DC), reduced pressure principle device (RP) device, or an air gap when backflow prevention is mandated



A Certified Backflow Tester (Jerry Durbin) examining a Double Check Detector check fire line assembly.

Notice the water meter in photo, it is to detect any un-authorized water usage used in the fire line.

Most of this section comes from the EPA's Cross-Connection Manual.



What is a Cross-Connection?

When drinking water piping connects to various plumbing fixtures (drain) or water utilizing equipment a **cross-connection** is created. If improperly protected, contamination can result when a **backflow** event occurs; allowing contaminants to reverse flow from the fixture/equipment back into the drinking water piping.

What Can Cause a Backflow

Conditions that are likely to create a **backflow** event are typically common, but unfavorable, hydraulic events that occur within the public or private segments of the water distribution system such as: an owner or worker draining down a house or building to make a plumbing repair; a broken water main or distribution pipe; severe/widespread power outages; fire fighters using large quantities of water to extinguish a fire, or; a water utilizing piece of equipment or process creating pressures greater than those present in water distribution system.

When these unfavorable hydraulic events are occurring, contaminants can be back-siphoned into the drinking water due to negative pressures; or contaminants can back-pressured into the drinking water due to excessive pressure imposed by the water utilizing piece of equipment or process

Backflow Introduction

Backflow Prevention, also referred to as Cross-Connection Control, addresses a serious health issue. This issue was addressed on the federal level by passage of the "*Federal Safe Drinking Water Act*" as developed by the Environmental Protection Agency (E.P.A.) and passed into law on December 16, 1974. This Act tasked each state with primary enforcement responsibility for a program to assure access to safe drinking water by all citizens. Such state program regulations as adopted are required to be at least as stringent as the federal regulations as developed and enforced by the E.P.A.

The official definition of a cross-connection is "*the link or channel connecting a source of pollution with a potable water supply.*" There are two distinct levels of concern with this issue. The first is protection of the general public and the second is protection of persons subject to such risks involving service to a single customer, be that customer an individual residence or business.

Sources of pollution which may result in a danger to health are not always obvious and such cross-connections are certainly not usually intentional. They are usually the result of oversight or a non-professional installation. As source examples, within a business environment the pollutant source may involve the unintentional cross-connection of internal or external piping with chemical processes or a heating boiler. In a residential environment the pollutant source may be an improper cross-connection with a landscape sprinkler system or reserve tank fire protection system. Or, a situation as simple as leaving a garden hose nozzle submerged in a bucket of liquid or attached to a chemical sprayer.

Another potential hazard source within any environment may be a cross-connection of piping involving a water well located on the property. This is a special concern with older residences or businesses, which may have been served by well water prior to connection to the developed water system. There are many other potential sources of pollutant hazards. Control of cross-connections is possible but only through knowledge and vigilance. Public education is essential, for many that are educated in piping and plumbing installations fail to recognize cross-connection dangers.



Another buried RP assembly deep inside a vault, all we can see is a test cock. All RPs need to be installed 12 inches above the ground. This device was buried in ground and not tested for over 25 years. Owners are required to test their devices once a year at a minimum.



Top photo, a Hot Box, a good method of keeping the assembly from freezing during the winter. Bottom, electrical heat tape method for freeze protection.



Recent Backflow Situations

Oregon 1993

Water from a drainage pond, used for lawn irrigation, is pumped into the potable water supply of a housing development.

California 1994

A defective backflow device in the water system of the County Courthouse apparently caused a sodium nitrate contamination that sent 19 people to the hospital.

New York 1994

An 8-inch reduced pressure principle backflow assembly in the basement of a hospital discharged under backpressure conditions, dumping 100,000 gallons of water into the basement.

Nebraska 1994

While working on a chiller unit of an air conditioning system at a nursing home, a hole in the coil apparently allowed Freon to enter the circulating water and from there into the city water system.

California 1994

The blue tinted water in a pond at an amusement park backflowed into the city water system and caused colored water to flow from homeowners' faucets.

California 1994

A film company shooting a commercial for television accidentally introduced a chemical into the potable water system.

Iowa 1994

A backflow of water from the Capitol Building chilled water system contaminated potable water with Freon.

Indiana 1994

A water main break caused a drop in water pressure allowing anti-freeze from an air conditioning unit to backsiphon into the potable water supply.

Washington 1994

An Ethylene Glycol cooling system was illegally connected to the domestic water supply at a veterinarian hospital.

Ohio 1994

An ice machine connected to a sewer sickened dozens of people attending a convention.

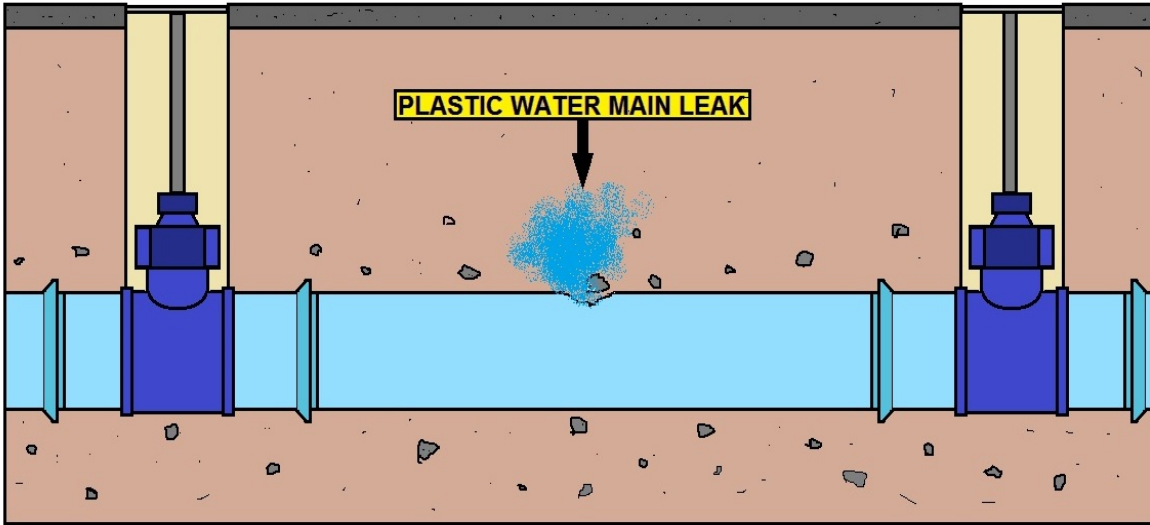

PLASTIC WATER MAIN LEAK

**MOST PLASTIC MAIN WATER LEAKS ARE CAUSED BY ROCKS OR SHARP OBJECTS
SCRAPING AGAINST PIPING / LEAKS ARE GENERALLY HORIZONTAL LEAKS**

Cross-Connection Sub-Section

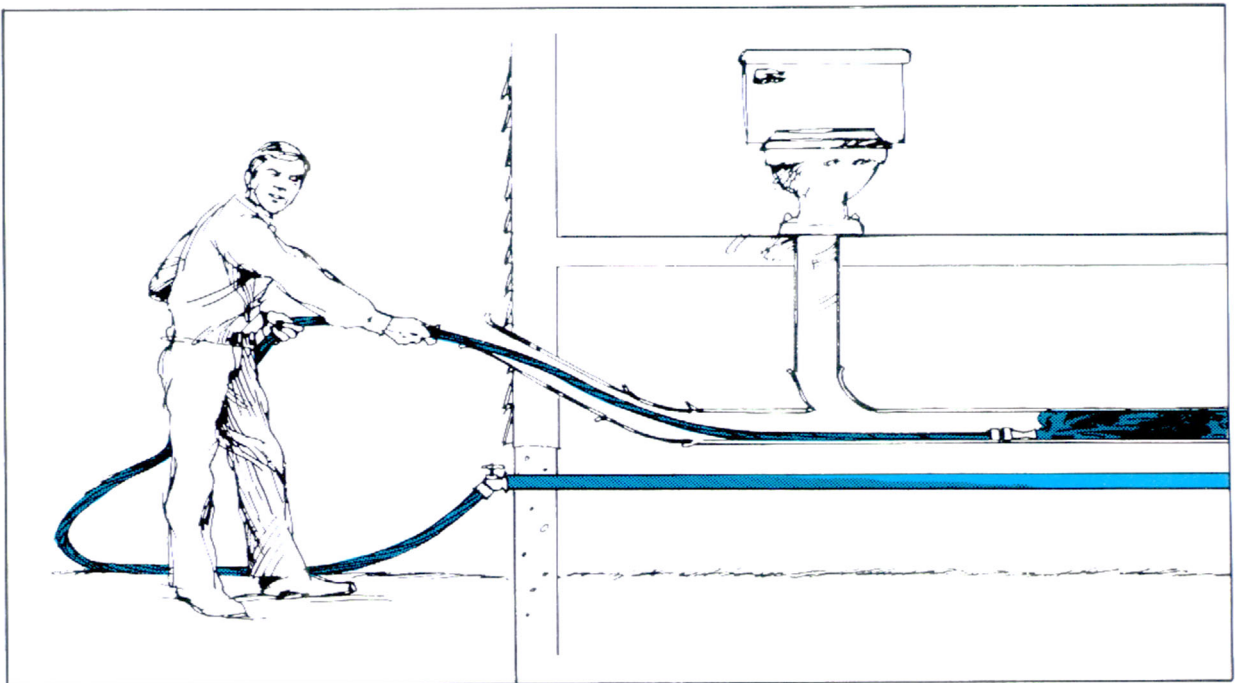
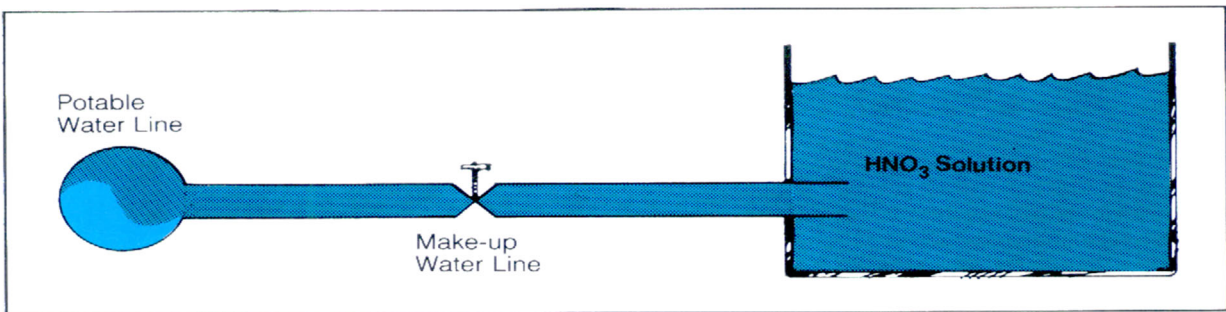
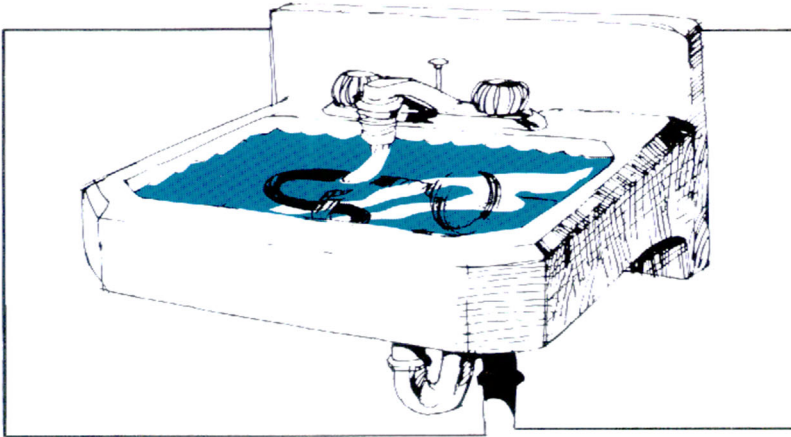

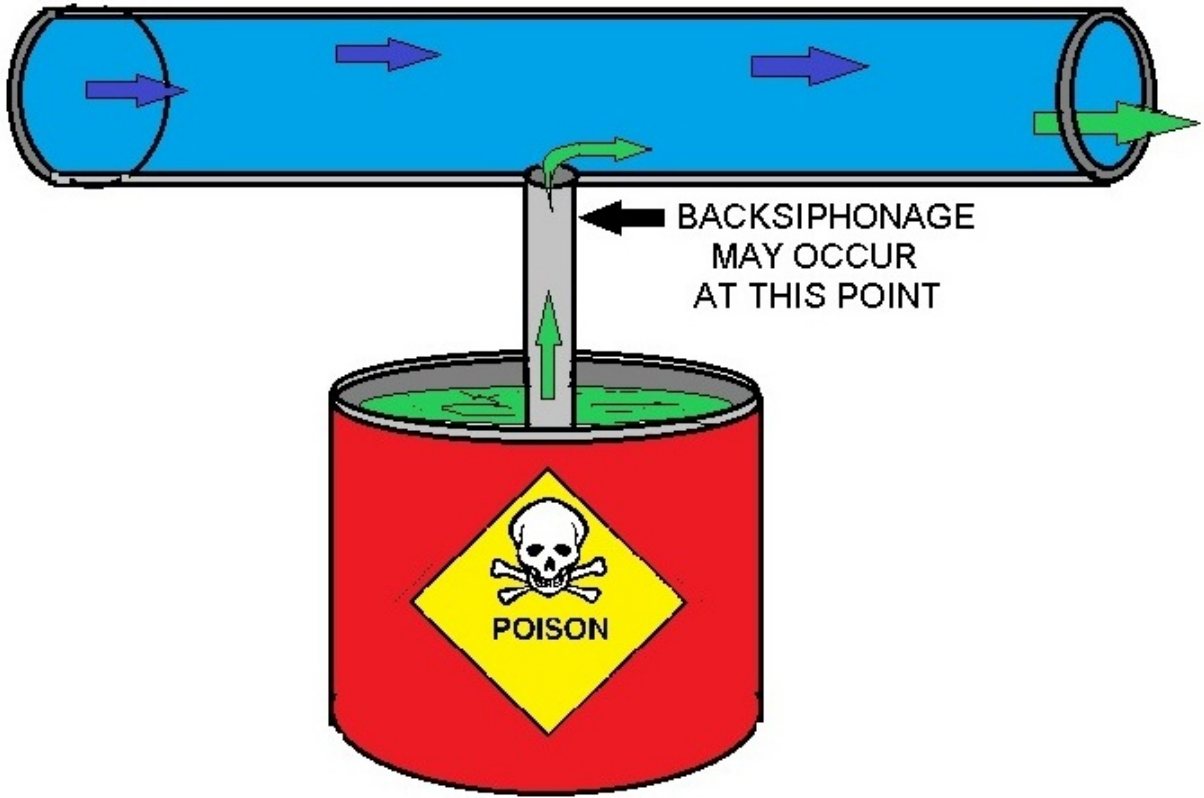

ASPIRATOR EFFECT DIAGRAM

Cross-Connection Terminology

Cross-Connection

A cross-connection is any temporary or permanent connection between a public water system or consumer's potable (i.e., drinking) water system and any source or system containing nonpotable water or other substances. An example is the piping between a public water system or consumer's potable water system and an auxiliary water system, cooling system, or irrigation system.

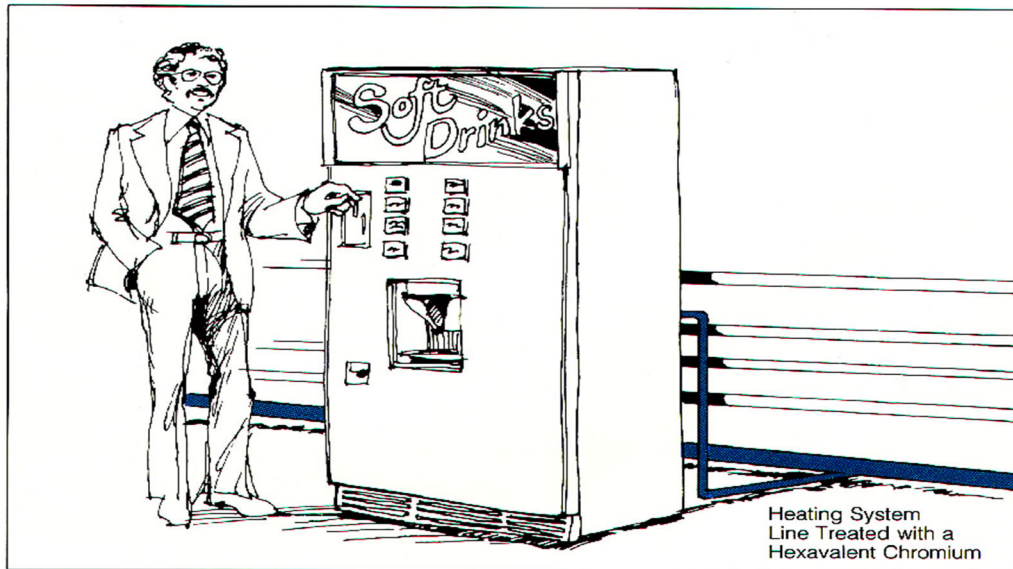

Contaminant: Any natural or man-made physical, chemical, biological, or radiological substance or matter in water, which is at a level that may have an adverse effect on public health, and which is known or anticipated to occur in public water systems.

Contamination: To make something bad; to pollute or infect something. To reduce the quality of the potable (drinking) water and create an actual hazard to the water supply by poisoning or through spread of diseases.

Corrosion: The removal of metal from copper, other metal surfaces and concrete surfaces in a destructive manner. Corrosion is caused by improperly balanced water or excessive water velocity through piping or heat exchangers.

Cross-Connection Failure: Could be the source of an organic substance causing taste and odor problems in a water distribution system.

Cross-Connection: A physical connection between a public water system and any source of water or other substance that may lead to contamination of the water provided by the public water system through backflow. The mixing of two unlike qualities of water; for example, the mixing of good water with a polluting substance like a chemical.

Backflow

Backflow is the undesirable reversal of flow of nonpotable water or other substances through a cross-connection and into the piping of a public water system or consumer's potable water system. There are two types of backflow--**backpressure** and **backsiphonage**.

Backsiphonage

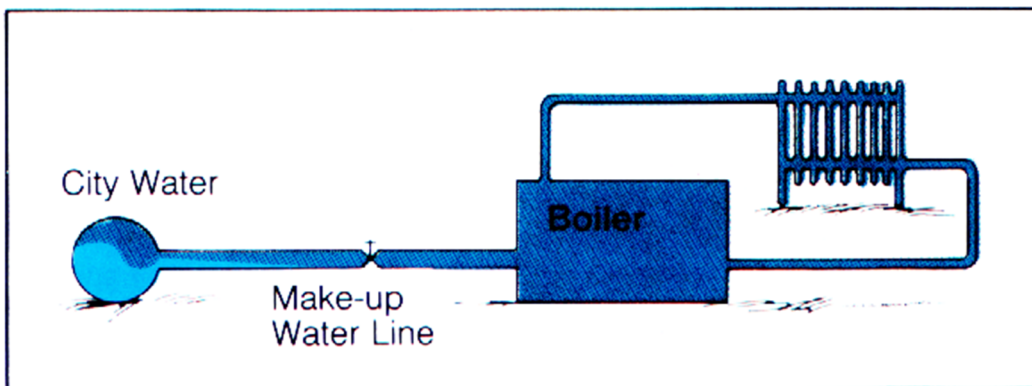

Backpressure

Backsiphonage

Backsiphonage is backflow caused by a negative pressure (i.e., a vacuum or partial vacuum) in a public water system or consumer's potable water system. The effect is similar to drinking water through a straw.

Backsiphonage can occur when there is a stoppage of water supply due to nearby firefighting, a break in a water main, etc.

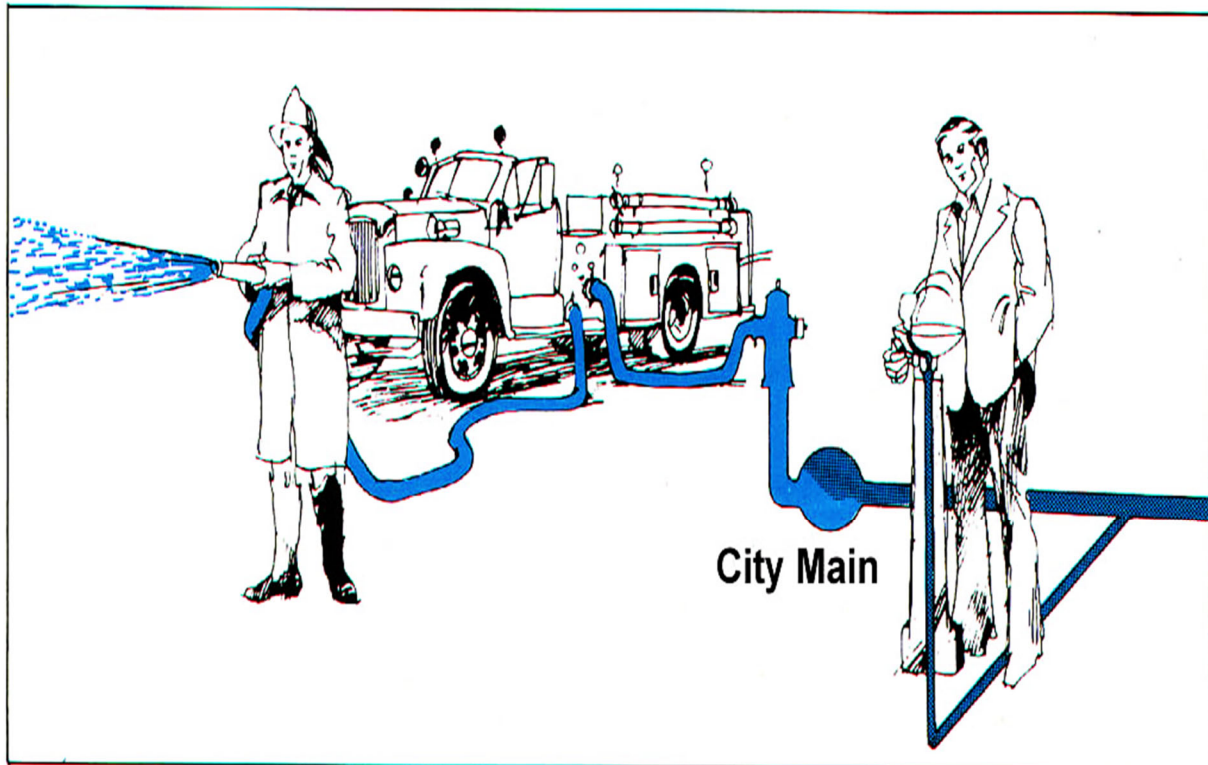

Cooling Tower - A common location for finding a cross-connection.

Backpressure

Backpressure backflow is backflow caused by a downstream pressure that is greater than the upstream or supply pressure in a public water system or consumer's potable water system.

Backpressure (i.e., downstream pressure that is greater than the potable water supply pressure) can result from an increase in downstream pressure, a reduction in the potable water supply pressure, or a combination of both.

Increases in downstream pressure can be created by pumps, temperature increases in boilers, etc.

Reductions in potable water supply pressure occur whenever the amount of water being used exceeds the amount of water being supplied, such as during water line flushing, firefighting, or breaks in water mains.

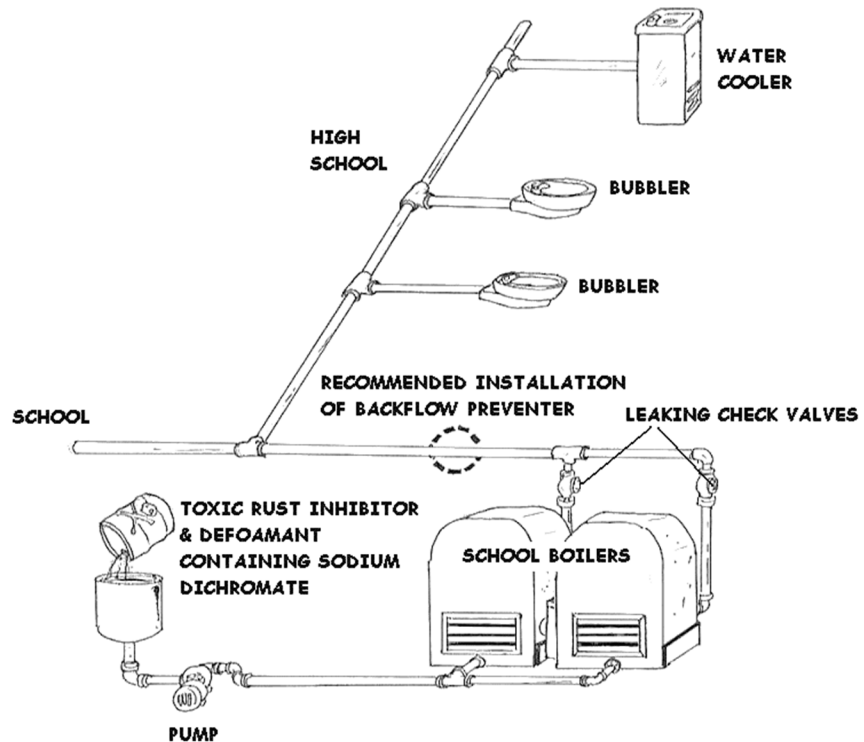

Backpressure

Example:

Booster Pumps,
Pressure Vessels,
Boilers

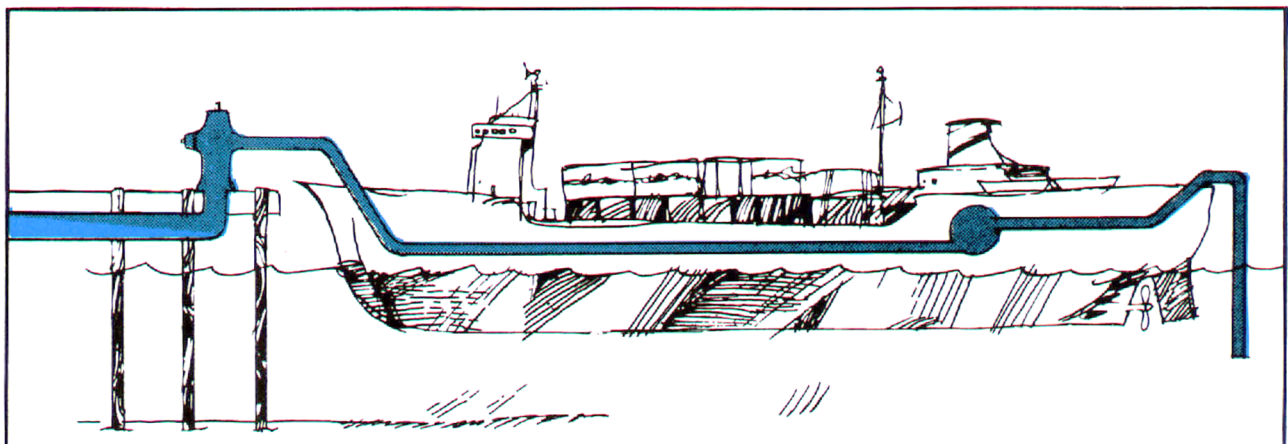

Backflow Responsibility

The Public Water Purveyor

The primary responsibility of the water purveyor is to develop and maintain a program to prevent or control contamination from water sources of lesser quality or other contamination sources from entering into the public water system. Under the provisions of the Safe Drinking Water Act of 1974, (**SDWA**) and current Groundwater Protection rules the Federal Government, through the EPA (Environmental Protection Agency), set national standards of safe drinking water. The separate states are responsible for the enforcement of these standards as well as the supervision of public water systems and the sources of drinking water. The water purveyor or supplier is held responsible for compliance to the provisions of the Safe Drinking Water Act, to provide a warranty that water quality by their operation is in conformance with EPA standards at the source, and is delivered to the customer without the quality being compromised as it is delivered through the distribution system.

This is specified in the Code of Federal Regulations (Volume 40, Para 141.2 Section c)”:

Maximum contaminant level means the permissible level of a contaminant in water which is delivered to the free flowing outlet of the ultimate user of a public water system, except in the case of turbidity where the maximum permissible level is measured at the point of entry (**POE**) to the distribution system. Contaminants added to the water under circumstances controlled by the user, except those resulting from corrosion of piping and plumbing caused by water quality, are excluded from this definition.

The Water Consumer

Has the responsibility to prevent contaminants from entering into the public water system by way of their individual plumbing system, and retain the expenses of installation, maintenance, and testing of the approved backflow prevention assemblies installed on their individual water service line.

The Certified General Backflow Tester

Has the responsibility to test, maintain, inspect, repair, and report/notify on approved backflow prevention assemblies as authorized by the persons that have jurisdiction over those assemblies.

Backflow into a public water system can pollute or contaminate the water in that system (i.e., backflow into a public water system can make the water in that system unusable or unsafe to drink), and each water supplier has a responsibility to provide water that is usable and safe to drink under all fore-seeable circumstances. Furthermore, consumers generally have absolute faith that water delivered to them through a public water system is always safe to drink. For these reasons, each water supplier must take reasonable precautions to protect its public water system against backflow.

What should water suppliers do to control cross-connections and protect their public water systems against backflow?

Water suppliers usually do not have the authority or capability to repeatedly inspect every consumer’s premises for cross-connections and backflow protection. Alternatively, each water supplier should ensure that a proper backflow preventer is installed and maintained at the water service connection to each system or premises that pose a significant hazard to the public water system.

Generally, this would include the water service connection to each dedicated fire protection system or irrigation piping system and the water service connection to each of the following types of premises:

- (1) Premises with an auxiliary or reclaimed water system.
- (2) Industrial, medical, laboratory, marine or other facilities where objectionable substances are handled in a way that could cause pollution or contamination of the public water system.
- (3) Premises exempt from the State Plumbing Code and premises where an internal backflow preventer required under the State Plumbing Code is not properly installed or maintained.
- (4) Classified or restricted facilities; and
- (5) Tall buildings.

Each water supplier should also ensure that a proper backflow preventer is installed and maintained at each water loading station owned or operated by the water supplier.

Degrees of Hazards (HAZARD RATINGS) High, *Contaminant* and Low, *Pollutional*

Containment Protection, *Secondary protection*

This approach utilizes a minimum of backflow devices and isolates the customer from the water main. It virtually insulates the customer from potentially contaminating or polluting the public water supply system. Containment protection does not protect the customer within his own building, it does effectively remove him from the possibility public water supply contamination. Containment protection is usually a backflow prevention device as close as possible to the customer's water meter and is often referred to as "**Secondary Protection**". This type of backflow protection is excellent for water purveyors and is the least expense to the water customer, but does not protect the occupants of the building.

Internal Protection, *Primary protection*

The water purveyor may elect to protect his customers on a domestic internal protective basis and/or "**fixture outlet protective basis**," in this case cross-connection-control devices (backflow preventors) are placed at internal hazard locations and at all locations where cross-connections may exist, including the "**last free flowing outlet**." This type of protection entails extensive cross-connection survey work usually performed by a plumbing inspector or a Cross-Connection Specialist.

In a large water supply system, internal protection in itself is virtually impossible to achieve and police due to the quantity of systems involved, the complexity of the plumbing systems inherent in many industrial sites, and the fact that many plumbing changes are made within commercial establishments that do not get the plumbing department's approval or require that the water department inspects when the work is completed.

Internal protection is the most expensive and best type of backflow protection for both the water purveyor and the customer alike, but is very difficult to maintain. In order for the purveyor to provide maximum protection of the water distribution system, consideration should be given to requiring the owner of the premises to provide at his own expense, adequate proof that his internal water supply system complies with the local or state plumbing code(s).

Backflow Prevention Methods and Assemblies

Approved Air Gap Separation (AG)

An approved air gap is a physical separation between the free flowing discharge end of a potable water supply pipeline, and the overflow rim of an open or non-pressure receiving vessel. These separations must be vertically orientated a distance of at least twice the inside diameter of the inlet pipe, but never less than one inch.

An obstruction around or near an air gap may restrict the flow of air into the outlet pipe and nullify the effectiveness of the air gap to prevent backsiphonage.

When the air flow is restricted, such as in the case of an air gap located near a wall, the air gap separation must be increased. Also, within a building where the air pressure is artificially increased above atmospheric, such as a sports stadium with a flexible roof kept in place by air blowers, the air gap separation must be increased.

Air gap or vacuum breaker: What should a potable water line be equipped with when connected to a chemical feeder for fluoride?

Air Gap Separation: A physical separation space that is present between the discharge vessel and the receiving vessel, for an example, a kitchen faucet.

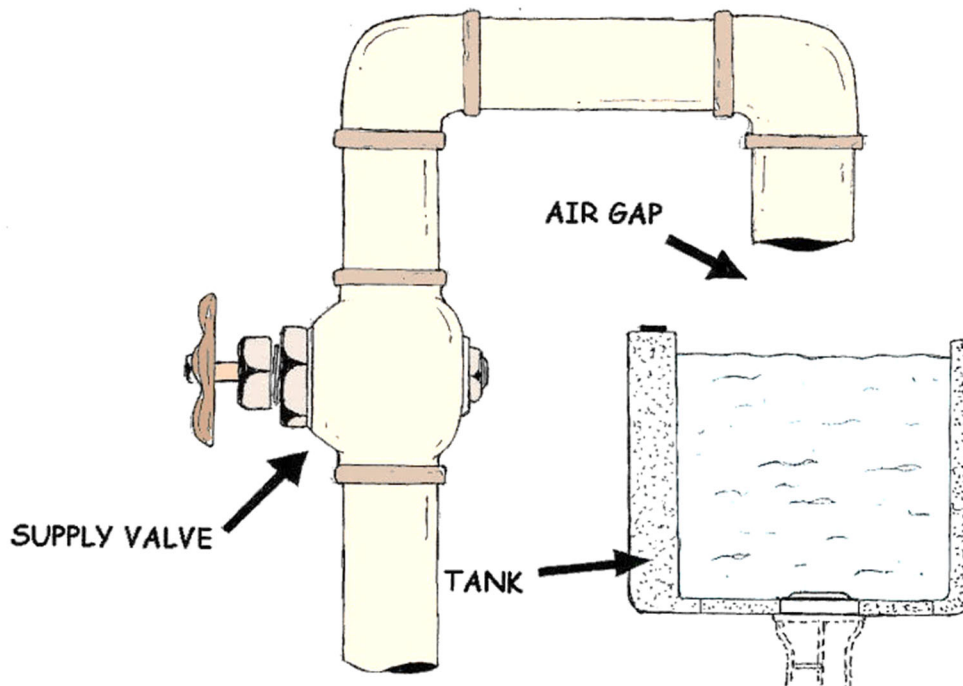

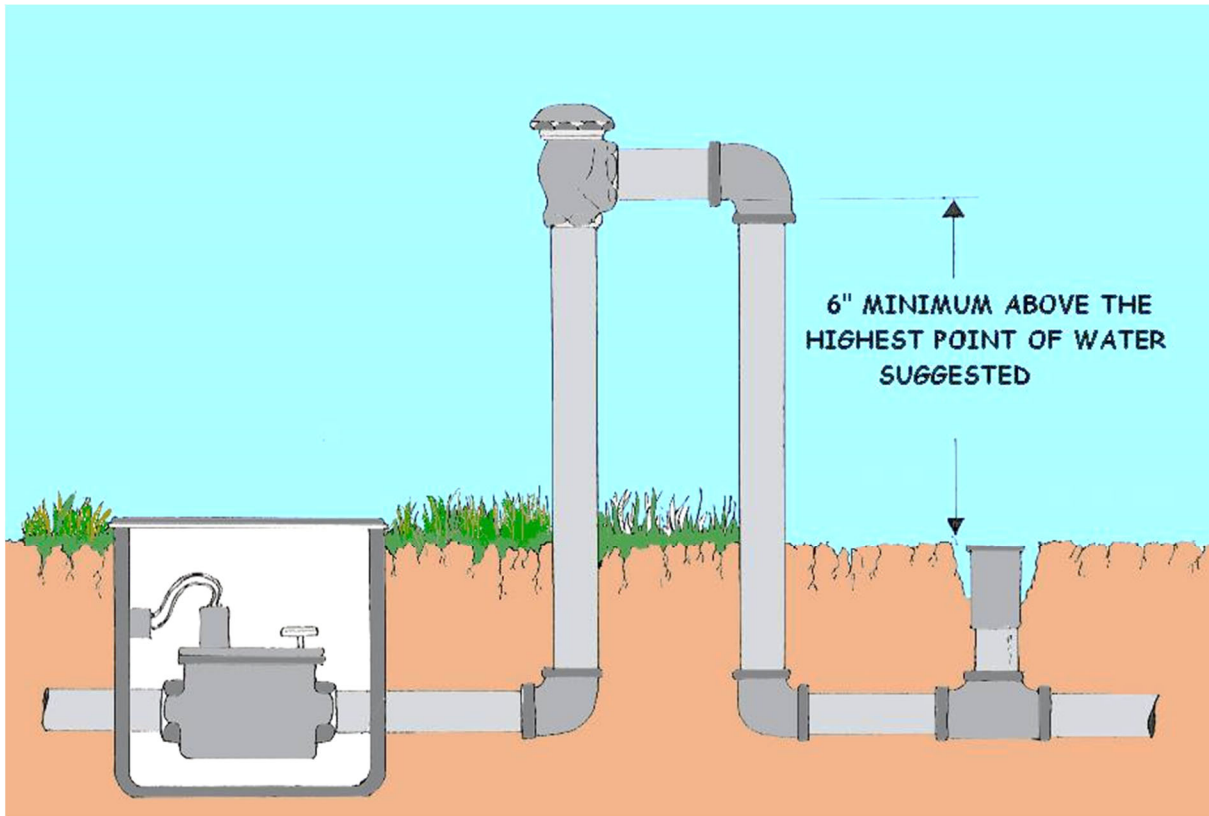

Atmospheric Vacuum Breaker (AVB)

The Atmospheric Vacuum Breaker contains a float check (poppet), a check seat, and an air inlet port. The device allows air to enter the water line when the line pressure is reduced to a gauge pressure of zero or below. The air inlet valve is not internally loaded.

To prevent the air inlet from sticking closed, the device must not be installed on the pressure side of a shutoff valve, or wherever it may be under constant pressure more than 12 hours during a 24 hour period. Atmospheric vacuum breakers are designed only to prevent backflow caused by backsiphonage from low health hazards.

Atmospheric Vacuum Breaker Uses

Irrigation systems, commercial dishwasher and laundry equipment, chemical tanks and laboratory sinks (backsiphonage only, non-pressurized connections). (Note: hazard relates to the water purveyor's risk assessment; plumbing codes may allow AVB for high hazard fixture isolation).

Pressure Vacuum Breaker Assembly (PVB)

The Pressure Vacuum Breaker Assembly consists of a spring-loaded check valve, an independently operating air inlet valve, two resilient seated shutoff valves, and two properly located resilient seated test cocks. It shall be installed as a unit as shipped by the manufacturer. The air inlet valve is internally loaded to the open position, normally by means of a spring, allowing installation of the assembly on the pressure side of a shutoff valve.

PRESSURE VACUUM BREAKER ASSEMBLY

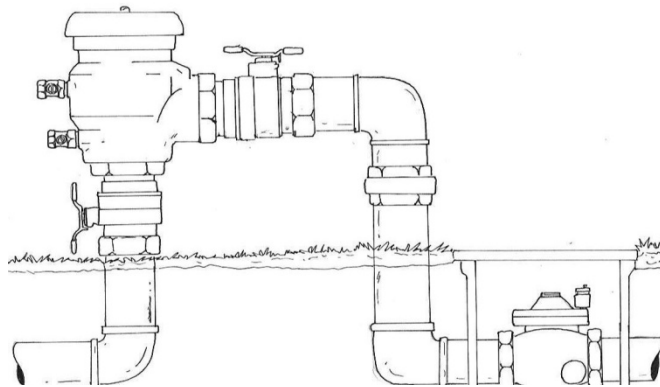

Double Check Valve Assembly (DC)

The Double Check Valve Assembly consists of two internally loaded check valves, either spring loaded or internally weighted, two resilient seated full ported shutoff valves, and four properly located resilient seated test cocks. This assembly shall be installed as a unit as shipped by the manufacturer. The double check valve assembly is designed to prevent backflow caused by backpressure and backsiphonage from low health hazards.

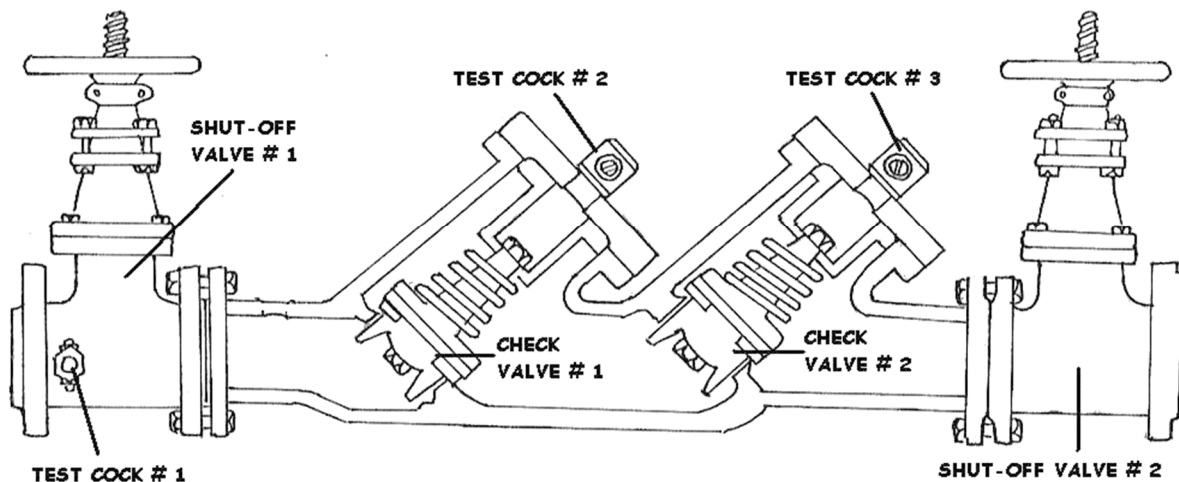

Double Check Assembly –Common on Firelines

Reduced Pressure Backflow Assembly (RP)

The reduced pressure backflow assembly consists of two independently acting spring loaded check valves separated by a spring loaded differential pressure relief valve, two resilient seated full ported shutoff valves, and four properly located resilient seated test cocks. This assembly shall be installed as a unit shipped by the manufacturer.

During normal operation, the pressure between the two check valves, referred to as the zone of reduced pressure, is maintained at a lower pressure than the supply pressure.

If either check valve leaks, the differential pressure relief valve maintains a differential pressure of at least two (2) psi between the supply pressure, and the zone between the two check valves, by discharging water to atmosphere. The reduced pressure backflow assembly is designed to prevent backflow caused by backpressure and backsiphonage from low to high health hazards.

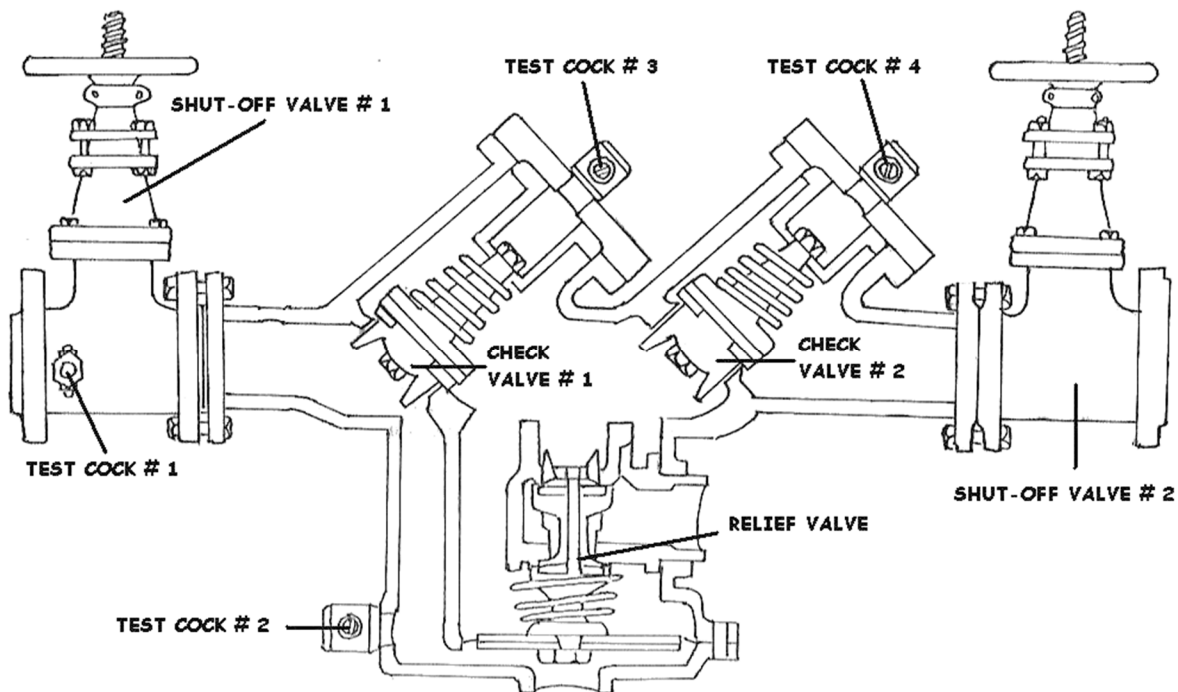

Reduced Pressure Principle Assembly
Common on commercial and Industrial facilities

Various examples of RPs and these are easy to find around most water treatment facilities. Incredibly, these devices can be found installed incorrectly, or even installed backwards with the guts removed.

Why do Backflow Preventers Have to be Tested Periodically?

Mechanical backflow preventers have internal seals, springs, and moving parts that are subject to fouling, wear, or fatigue. Also, mechanical backflow preventers and air gaps can be bypassed. Therefore, all backflow preventers have to be tested periodically to ensure that they are functioning properly. A visual check of air gaps is sufficient, but mechanical backflow preventers have to be tested with properly calibrated gauge equipment.

Backflow prevention devices must be tested annually to ensure that they work properly. It is usually the responsibility of the property owner to have this test done and to make sure that a copy of the test report is sent to the Public Works Department or Water Purveyor.

If a device is not tested annually, Public Works or the Water Purveyor will normally notify the property owner, asking them to comply. If the property owner does not voluntarily test their device, the Water provider may be forced to turn off water service to that property. State law may require the Water provider to discontinue water service until testing is complete.

Troubleshooting Table for Cross Connection Problem

1. Sudsy or soapy water.
3. Positive Coliform.
3. Coloring in the water (unusual colors such as bright blue).
4. Organic odors.

Possible Causes

- 1A. Hose connected to an unprotected hose bib with the other end in a bucket or sink of soapy water.
- 2A. Hose connected to an unprotected hose bib with the other end lying on the floor of the pump house, on the ground in the car wash area, in the wading or swimming pool or other nonpotable liquid.
- 2B. Unprotected potable water line feeding a lawn irrigation system.
- 2C. Submerged inlet, e.g. faucet submerged.
- 3A. Backflow from toilet.
- 4A. Handheld pesticide/herbicide applicator attached to unprotected hose.

Possible Solutions

- 1A. Equip all hose bibs with an AVB.
- 2A. Equip all hose bibs with an AVB.
- 2B. Install a backflow preventer on the potable water line feeding the irrigation system.
- 2C. Relocate faucet above flood level.
- 3A. Get help. Bring in someone who understands cross connections to evaluate the system.
- 4A. Don't use these devices



This PVB is not 12 inches above the ground nor the highest downstream outlet.

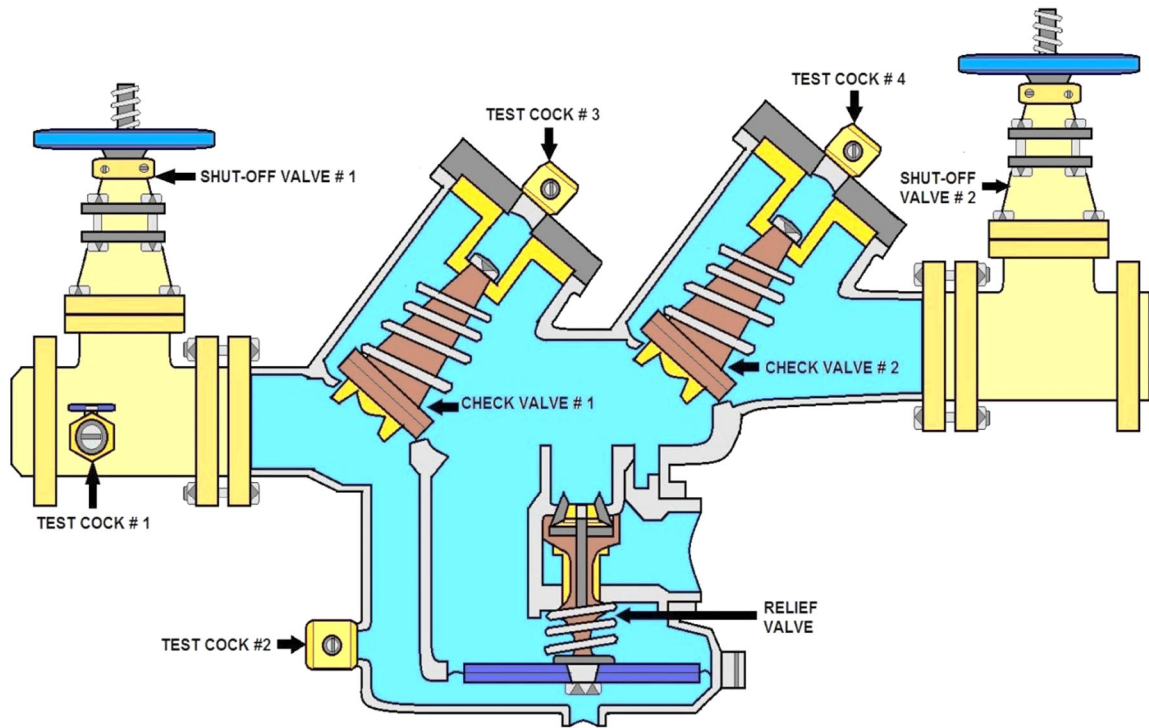

REDUCED PRESSURE PRINCIPLE BACKFLOW ASSEMBLY

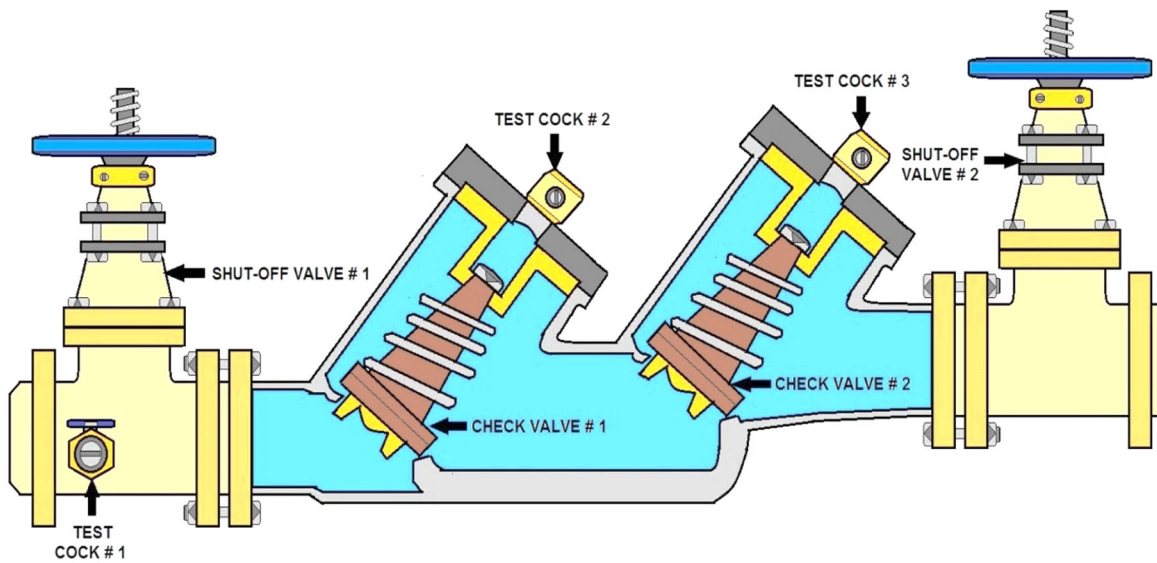

DOUBLE-CHECK BACKFLOW ASSEMBLY

Cross-Connection/Backflow Prevention Section Post Quiz

1. A continuous positive pressure in a distribution system is essential for preventing what event?
2. What might be the source of an organic substance causing taste and odor problems in a water distribution system?
3. Minimum water pressure must be maintained to ensure adequate customer service during peak flow periods. However, minimum positive pressure must be maintained in mains to protect against _____ or backsiphonage from cross-connections.
4. Backflow: To _____ the natural and normal directional flow of liquids, gases, or solid substances back in to the public potable (drinking) water supply. This is normally an undesirable effect.
5. Backsiphonage condition usually causes a reduced pressure or negative pressure on the _____.
6. What is equipment that utilizes water for cooling, lubrication, washing or as a solvent always susceptible to?
7. An operator shall ensure when installing a pressure vacuum breaker backflow device that it must be at _____ above the highest downstream outlet.

Backflow/Cross-Connection Section

8. What term represents any temporary or permanent connection between a public water system or consumer's potable water system and any source or system containing nonpotable water or other substances?
9. What term represents backflow caused by a negative pressure (i.e., a vacuum or partial vacuum) in a public water system or consumer's potable water system?
10. Backflow is the undesirable reversal of flow of nonpotable water or other substances through a _____ and into the piping of a public water system or consumer's potable water system.
11. The principal types of mechanical backflow preventer are the reduced-pressure principle assembly, the _____, and the double check valve assembly.

12. What term represents a stoppage of water supply due to nearby firefighting, a break in a water main?

13. What term represents backflow caused by a downstream pressure that is greater than the upstream or supply pressure in a public water system or consumer's potable water system?

14. What term represents two forms-backpressure and backsiphonage?

15. The basic mechanism for preventing backflow is a mechanical _____, which provides a physical barrier to backflow.

16. According to the text, basic means of preventing backflow is an _____, which either eliminates a cross-connection or provides a barrier to backflow.

Topic 5- Water Quality Section

Section Focus: You will learn the basics of the EPA’s Safe Water Drinking Act and the reasons why we need to ensure the water means federal standards. At the end of this section, you will be able to describe EPA’s Primary and Secondary standards. There is a post quiz at the end of this section to review your comprehension and a final examination in the Assignment for your contact hours.

Scope/Background: EPA identifies contaminants to regulate in drinking water to protect public health. The Agency sets regulatory limits for the amounts of certain contaminants in water provided by public water systems. These contaminant standards are required by the Safe Drinking Water Act (SDWA). Drinking water standards may apply differently based on type and size of public water systems.

FACTOR	TYPE	SOURCE(S)	PROBLEM
FECAL COLIFORM BACTERIA	BIOLOGICAL	HUMAN SEWAGE; LIVESTOCK WASTE	POSSIBLE PRESENCE OF PATHOGENIC (DISEASE-CAUSING) ORGANISMS
DISSOLVED OXYGEN (DO)	CHEMICAL	AIR; AQUATIC PLANTS	LOW LEVELS CAN KILL AQUATIC ORGANISMS
NITROGEN AND PHOSPHORUS	CHEMICAL	FERTILIZERS AND DETERGENTS FROM LAWNS AND RUNOFF	EXCESSIVE ALGAE GROWTH CAN LEAD TO LOW DO
ZINC, ARSENIC, LEAD, MERCURY, CADMIUM, NICKEL	CHEMICAL	LANDFILLS; INDUSTRIAL DISCHARGES; RUNOFF	GENETIC MUTATIONS OR DEATH IN FISH & WILDLIFE (HUMAN HEALTH THREATS AS WELL)
SALT	CHEMICAL	SALTWATER INTRUSION (IF NEAR OCEAN)	KILLS FRESHWATER SPECIES OF PLANTS AND ANIMALS
MUD, SAND, OTHER SOLID PARTICLES (TURBIDITY)	PHYSICAL	EROSION AND RUNOFF FROM DEVELOPMENT; AGRICULTURE	REDUCES PHOTOSYNTHESIS IN AQUATIC VEGETATION; INTERFERES WITH RESPIRATION IN AQUATIC ANIMALS

IMPORTANT WATER QUALITY CONCERNS

Common Water Quality Units of Measurement

mg/l = Milligrams per liter. One milligram per liter equals one packet of artificial sweetener sprinkled into 250 gallons of iced tea.

µg/l = Micrograms per liter. One microgram per liter is equal to one packet of artificial sweetener sprinkled into an Olympic-size swimming pool.

NTU = Nephelometric Turbidity Units. A measurement on the cloudiness of the water.

pCi/l = Picocuries per liter. A measure of radioactivity.

Acronyms

Maximum Contaminant Level (MCL) - The highest level of a contaminant that is allowed in drinking water.

Maximum Contaminant Level Goal (MCLG) - The level of a contaminant in drinking water below which there is no known or expected risk to health.

Treatment Technique (TT) - A required process intended to reduce the level of a contaminant in drinking water.

Action Level (AL) - The concentration of a contaminant that, if exceeded, triggers treatment or other requirements which a water system must follow.

Federal Water Drinking Water Quality Regulations Timeline

National Interim Primary Drinking Water Regulations (NIPDWR) Promulgated 1975-1981
Contained 7 contaminants, Targeted: Trihalomethanes, Arsenic, and Radionuclides
Established 22 drinking water standards.

Phase 1 Standards Promulgated 1987 Contained 8 contaminants, Targeted: VOCs.

Phase 2 Standards Promulgated 1991 Contained 36 contaminants, Targeted: VOCs, SOCs, and IOCs.

Phase 5 Standards Promulgated 1992 Contained 23 contaminants, Targeted: VOCs, SOCs, and IOCs.

Surface Water Treatment Rule (SWTR) Promulgated 1989 Contained 5 contaminants, Targeted: Microbiological and Turbidity.

Stage 1 Disinfectant/Disinfection By-product (D/DBP) Rule Promulgated 1998 Contained 14 contaminants, Targeted: DBPs and precursors.

Interim Enhanced Surface Water Treatment Rule (IESWTR) Promulgated 1998
Contained 2 contaminants, Targeted: Microbiological and Turbidity.

Radionuclide Rule Promulgated 2000 Contained 4 contaminants, Targeted: Radionuclides.

Arsenic Rule Promulgated 2001 Contained 1 contaminant, Targeted: Arsenic.

Filter Backwash Recycling Rule Promulgated 2001 Contained 2 contaminants, Targeted: Microbiological and Turbidity.

What is Water?

Water is the chemical substance with chemical formula H_2O : one molecule of water has two hydrogen atoms covalently bonded to a single oxygen atom. Water is a tasteless, odorless liquid at ambient temperature and pressure, and appears colorless in small quantities, although it has its own intrinsic very light blue hue. Ice also appears colorless, and water vapor is essentially invisible as a gas.

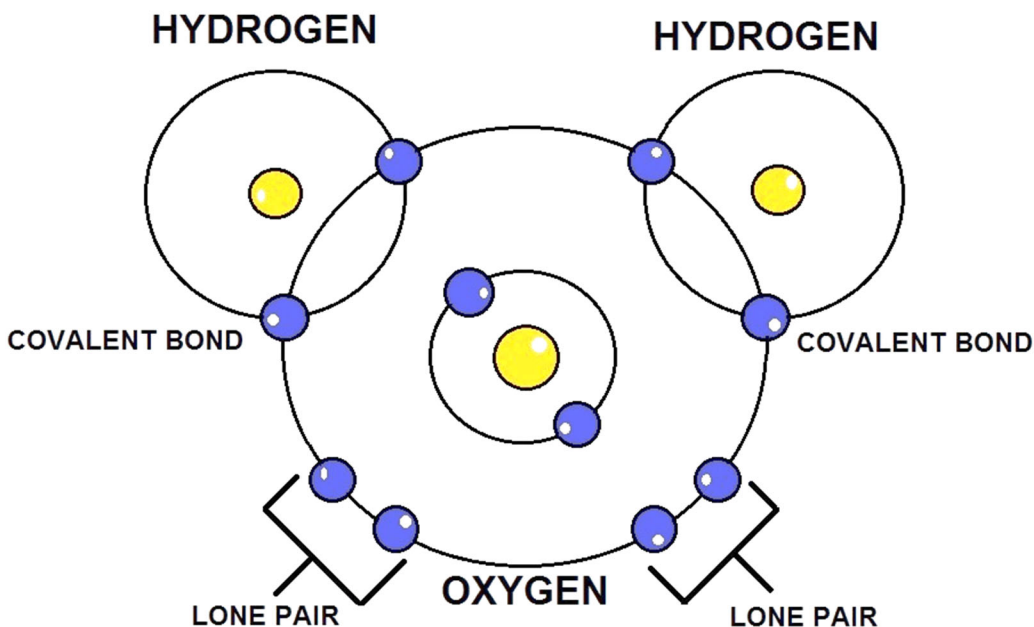

WATER MOLECULE DIAGRAM

Water is primarily a liquid under standard conditions on earth, to other analogous hydrides of the oxygen family in the periodic table, which are gases, such as hydrogen sulfide. The elements surrounding oxygen in the periodic table, nitrogen, fluorine, phosphorus, sulfur and chlorine, all combine with hydrogen to produce gases under standard conditions. The reason that water forms a liquid is that oxygen is more electronegative than all of these elements with the exception of fluorine.

Oxygen attracts electrons much more strongly than hydrogen, resulting in a net positive charge on the hydrogen atoms, and a net negative charge on the oxygen atom. The presence of a charge on each of these atoms gives each water molecule a net dipole moment.

Electrical attraction between water molecules due to this dipole pulls individual molecules closer together, making it more difficult to separate the molecules and therefore raising the boiling point.

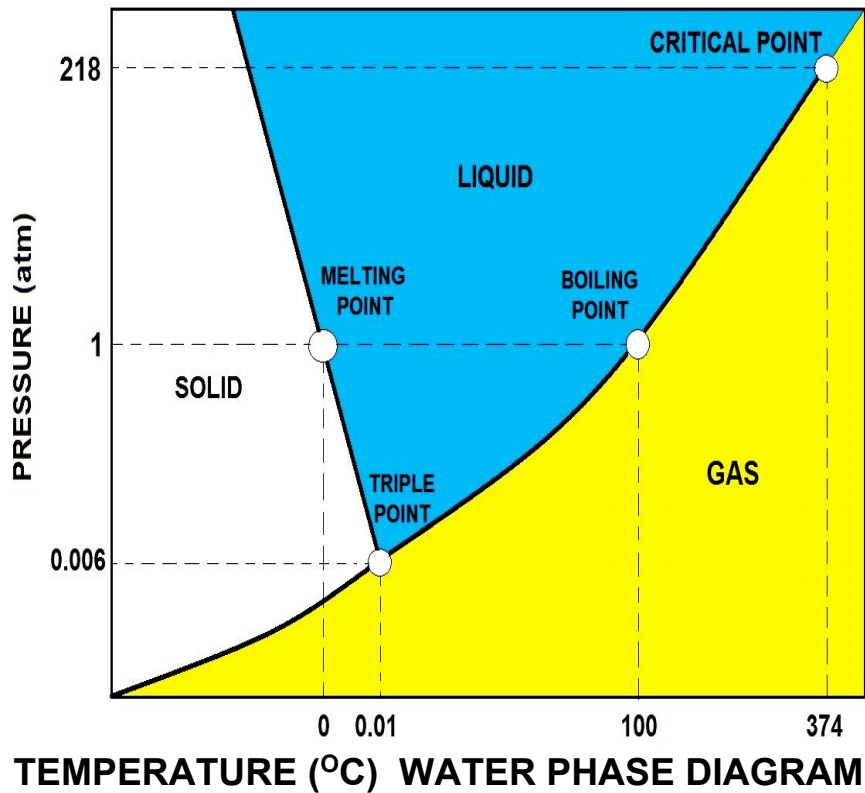



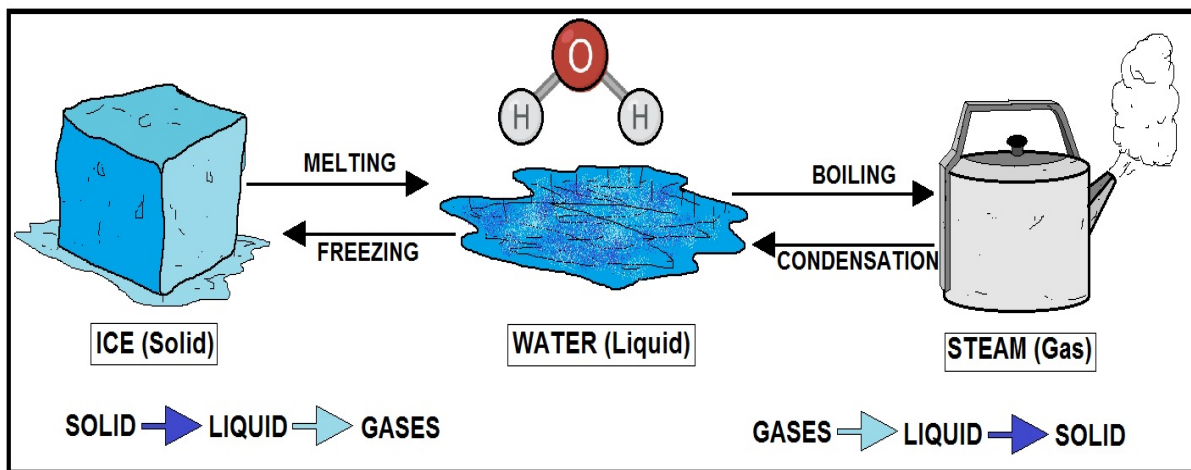

Boiling Phase

Once liquid water is heated to 212°F (100°C) it takes a significant amount of energy to change the “phase” of water from a liquid state to a gas state. That is one reason it’s easier to heat a pot of water to boiling rather than to evaporate all of it.



Surface (Raw) Water Introduction

We will go into greater detail on these concerns in the Water Analysis section.

INTRODUCTION OF RAW WATER	
Raw Water is natural water found in the Environment that has not been treated and does not have any of its Minerals, Ions, Particles, Bacteria, or Parasites removed	 
SOURCES:	 
<ul style="list-style-type: none">• Rain Water• Ground Water• Water from Infiltration Wells• Lakes and River Water	



INTRODUCTION TO RAW WATER

Because raw water (surface water) is never pure of pollution, we need to properly treat it. Most of the earth's water sources obtain their water supplies through precipitation (rain). During precipitation, water passes over (runoff) and through the ground (infiltration), acquiring a wide variety of dissolved or suspended impurities that intensely alters its usefulness. Water has unique physical, chemical and biological properties.

These characteristics have a direct influence on the most effective types of treatment methods and/or chemicals. The improvement of water quality and formation of policy measures (administrative and engineering) revolves around these characteristics.

It is important to remember that raw water will normally contains varying amounts of dissolved minerals including calcium, magnesium, sodium, chlorides, sulfates and bicarbonates, depending on its source.

It is also not uncommon to find traces of iron, manganese, copper, aluminum, nitrates, insecticides and herbicides.





Currently, we also need to deal with contaminants of emerging concern including Pharmaceuticals and Personal Care Products. EPA defines emerging contaminants as: An emerging contaminant (EC) is a chemical or material characterized by a perceived, potential, or real threat to human health or the environment or by a lack of published health standards.

The maximum allowable amounts of all these substances are strictly limited by the regulations (MCLS). These are usually referred to as contaminants and/or pollutants.

Surface water is usually contaminated and unsafe to drink without proper treatment. Depending on the region, some lakes and rivers receive discharge from sewer facilities or defective septic tanks.

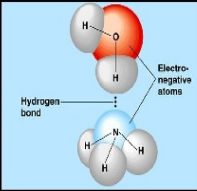
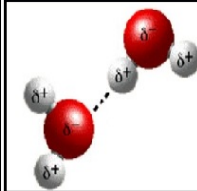
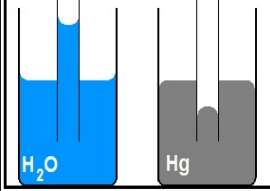
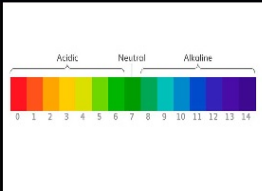
Runoff could produce mud, leaves, decayed vegetation, and human and animal refuse. The discharge from industry could increase volatile organic compounds. Some lakes and reservoirs may experience seasonal turnover. Changes in the dissolved oxygen, algae, temperature, suspended solids, turbidity, and carbon dioxide will change because of biological activities.

WATER PROPERTIES

<p style="text-align: center; background-color: #ADD8E6; margin: 0;">SURFACE TENSION</p>  <p style="font-size: small; margin-top: 10px;">WATER PROPERTY OF SURFACE TENSION ALLOWS TO HOLD A CERTAIN WEIGHT ON IT'S SURFACE</p>	<p style="text-align: center; background-color: #ADD8E6; margin: 0;">ADHESION</p>  <p style="font-size: small; margin-top: 10px;">WATER'S ADHESIVE PROPERTY IS WHY WATER STICKS TO OTHER OBJECTS, LIKE A LEAF OR YOUR SKIN WHEN IT GETS WET</p>	<p style="text-align: center; background-color: #ADD8E6; margin: 0;">COHESION</p>  <p style="font-size: small; margin-top: 10px;">WATER'S COHESIVE PROPERTY IS WHY WATER DROPLETS ARE ROUND BEFORE THEY ARE AFFECTED BY ADHESION</p>	<p style="text-align: center; background-color: #ADD8E6; margin: 0;">CAPILLARY ACTION</p>  <p style="font-size: small; margin-top: 10px;">CAPILLARY ACTION IS AN ACTION MADE POSSIBLE BY WATER'S ADHESIVE PROPERTY AND SURFACE TENSION.</p>
<p style="text-align: center; background-color: #ADD8E6; margin: 0;">NEUTRAL pH</p>  <p style="font-size: small; margin-top: 10px;">THE pH SCALE SHOWS HOW ACIDIC - BASIC A SUBSTANCE IS. PURE WATER HAS A NEUTRAL pH OF 7</p>	<p style="text-align: center; background-color: #ADD8E6; margin: 0;">3 STATES OF MATTER</p>  <p style="font-size: small; margin-top: 10px;">WATER, UNLIKE ANY OTHER MATTER, CAN EXIST IN SOLID, LIQUID OR GAS FORMS</p>	<p style="text-align: center; background-color: #ADD8E6; margin: 0;">HIGH HEAT CAPACITY</p>  <p style="font-size: small; margin-top: 10px;">WATER HAS A HIGH SPECIFIC HEAT CAPACITY, MEANING THAT IT TAKES QUITE A LOT OF ENERGY TO MAKE IT WARMER</p>	<p style="text-align: center; background-color: #ADD8E6; margin: 0;">DENSITY</p>  <p style="font-size: small; margin-top: 10px;">WATER'S DENSITY IS SLIGHTLY LESS THAN 1g/cm³</p>

PROPERTIES OF WATER



Surface Water Properties

Some of the water will be immediately impounded in lakes and reservoirs, and some will collect as runoff to form streams and rivers that will then flow into the ocean. Water is known as the universal solvent because most substances that come in contact with it will dissolve. What's the difference between lakes and reservoirs?

Reservoirs are lakes with man-made dams. Surface water is usually contaminated and unsafe to drink.

Depending on the region, some lakes and rivers receive discharge from sewer facilities or defective septic tanks. Runoff could produce mud, leaves, decayed vegetation, and human and animal refuse. The discharge from industry could increase volatile organic compounds. Some lakes and reservoirs may experience seasonal turnover.

Changes in the dissolved oxygen, algae, temperature, suspended solids, turbidity, and carbon dioxide will change because of biological activities.

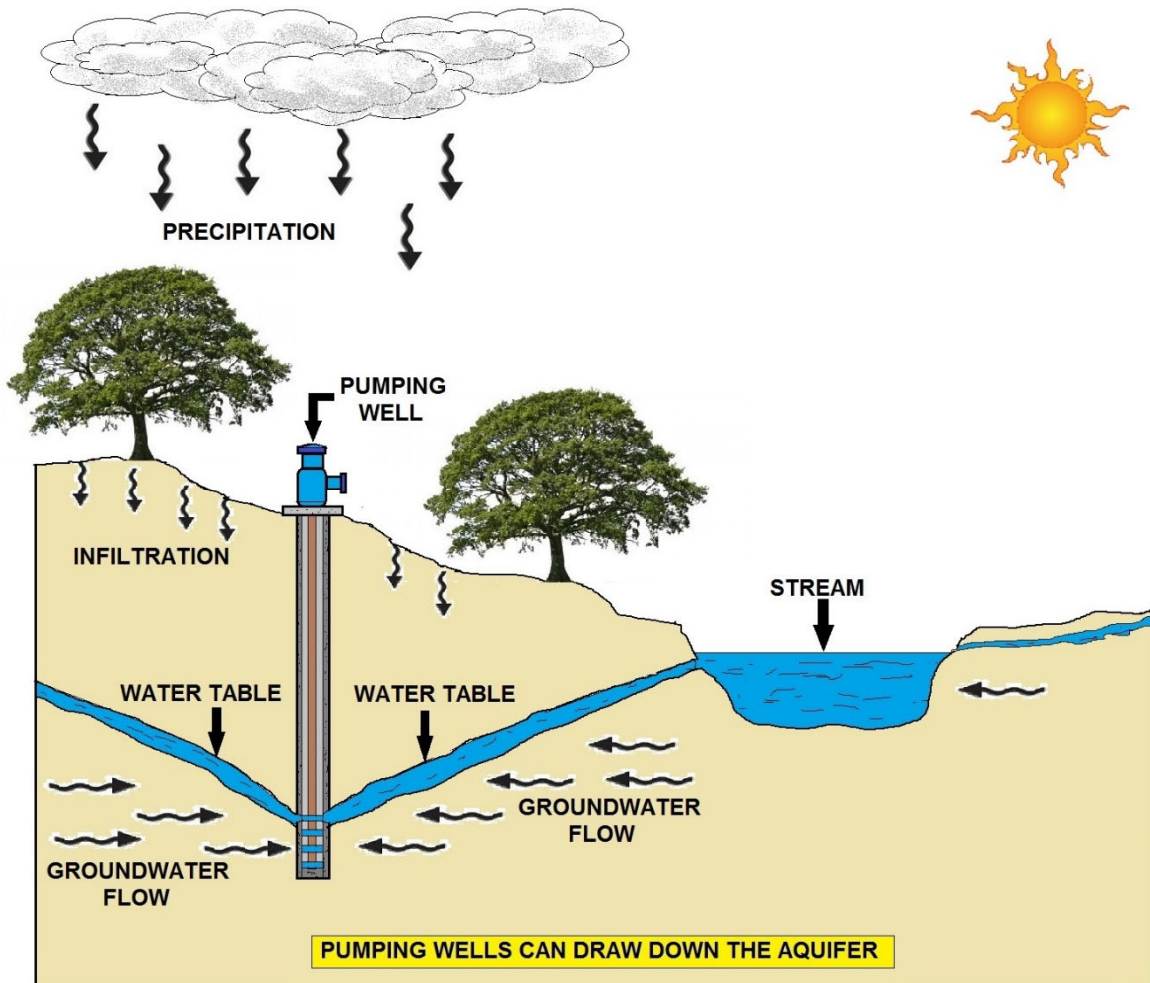

Managing Water Quality at the Source

Depending on the region, source water may have several restrictions of use as part of a Water Shed Management Plan. In some areas, it may be restricted from recreational use, discharge or runoff from agriculture, or industrial and wastewater discharge. Another aspect of quality control is aquatic plants.

The ecological balance in lakes and reservoirs plays a natural part in purifying and sustaining the life of the lake. For example, algae and rooted aquatic plants are essential in the food chain of fish and birds. Algae growth is the result of photosynthesis. Algae growth is supplied by the energy of the sun. As algae absorbs this energy, it converts carbon dioxide to oxygen.

This creates **aerobic** conditions that supply fish with oxygen. Without sun light, the algae would consume oxygen and release carbon dioxide. The lack of dissolved oxygen in water is known as **anaerobic** conditions. Certain vegetation removes the excess nutrients that would promote the growth of algae. Too much algae will imbalance the lake and kill fish.

Most treatment plant upsets such as taste and odor, color, and filter clogging is due to algae. The type of algae determines the problem it will cause, for instance slime, corrosion, color, and toxicity. Algae can be controlled in the water supply by using chemicals such as copper sulfate.

Depending on federal regulations and the amount of copper found natural in water, operators have used potassium permanganate, powdered activated carbon and chlorine to control algae blooms. The pH and alkalinity of the water will determine how these chemicals will react. Many water systems are limiting their chlorine usage because it reacts with the organics in the water to form trihalomethanes. Most treatment plants that do not use chlorine in the disinfection process will still add chlorine for a *residual* in the distribution system.

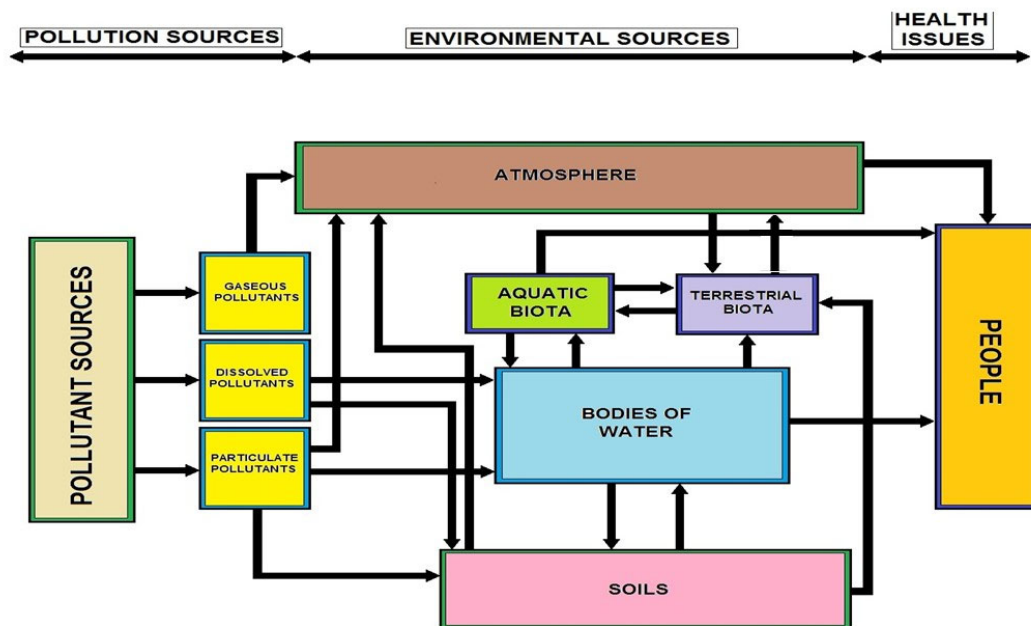

Physical Characteristics of Water

Physical characteristics such as taste, odor, temperature, pH, TDS, and turbidity; are mostly how the consumer judges how well the provider is treating the water.

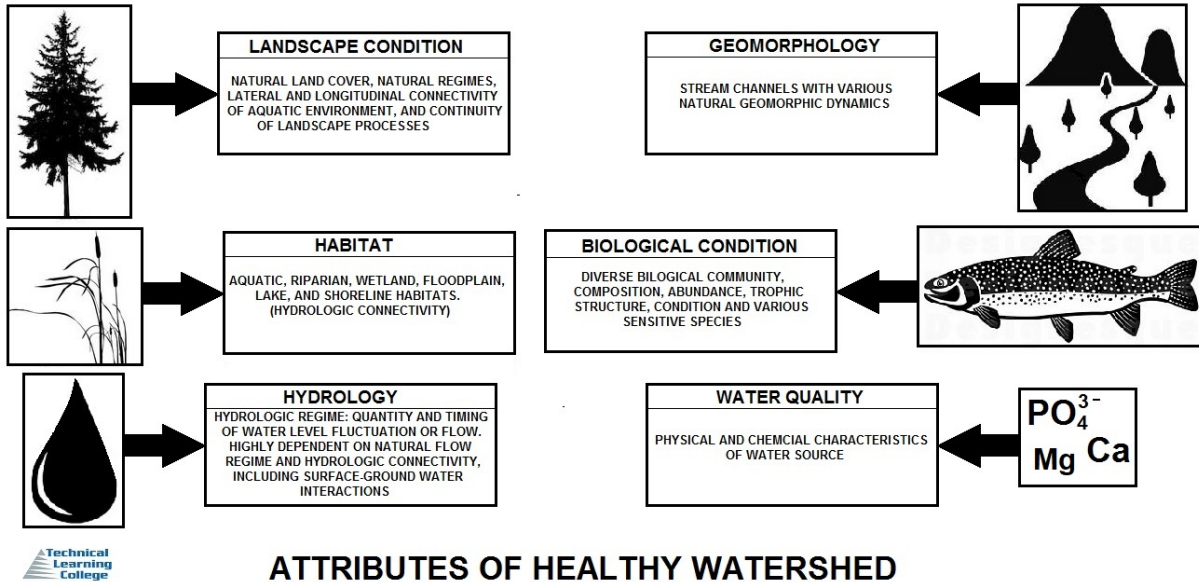

Physical characteristics are the elements found that are considered alkali, metals, and non-metals such as carbonates, fluoride, sulfides or acids. The consumer relates it to scaling of faucets or staining. Particles and rust come from the distribution system, the gradual breakdown of the lining of concrete or iron water pipes (mains) or from sediment that has accumulated over the years and is disturbed in some way.

SOLIDS

Solid material in wastewater may be dissolved, suspended, or settled.

Total dissolved solids or TDS (sometimes called filterable residue) is measured as the mass of residue remaining when a measured volume of filtered water is evaporated. The mass of dried solids remaining on the filter is called **total suspended solids** (TSS) or non-filterable residue.

Settleable solids are measured as the visible volume accumulated at the bottom of an Imhoff cone after water has settled for one hour.

Turbidity is a measure of the light scattering ability of suspended matter in the water.

Salinity measures water density or conductivity changes caused by dissolved materials.



Total Dissolved Solids (TDS) is not a primary pollutant; it is an indicator of aesthetic water characteristics such as hardness and an indication of an assortment of chemical contaminants which might be present, such as Arsenic. We will cover this in a few more pages.

pH is the negative logarithm of the hydrogen ion concentration, $[H^+]$, a measure of the degree to which a solution is acidic or alkaline. An acid is a substance that can give up a hydrogen ion (H^+); a base is a substance that can accept H^+ .

The more acidic a solution the greater the hydrogen ion concentration and the lower the pH; a pH of 7.0 indicates neutrality, a pH of less than 7 indicates acidity, and a pH of more than 7 indicates alkalinity. We will cover this subject further in the Water Analysis/Laboratory Section.

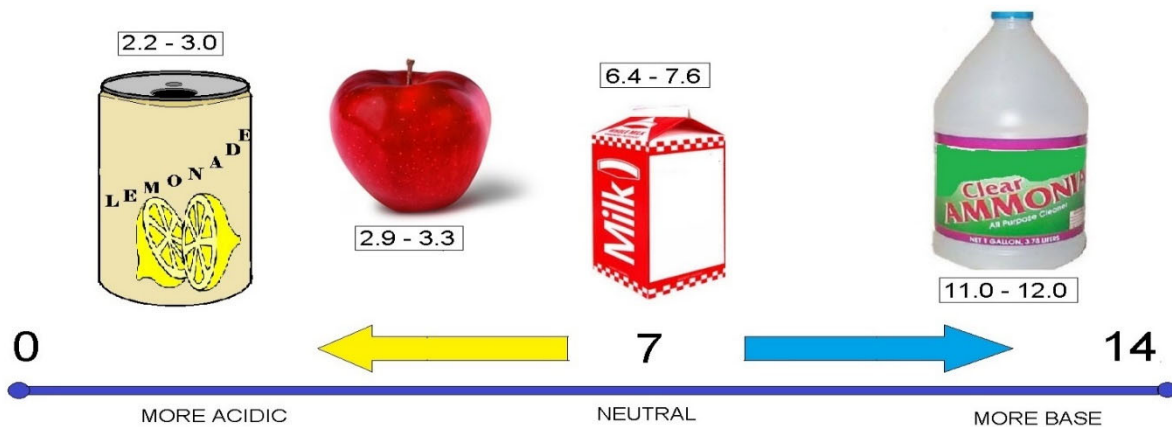

pH SCALE

Alkalinity

Alkalinity of water is its acid-neutralizing capacity. It is the sum of all the titratable bases. The measured value may vary significantly with the end-point pH used. Alkalinity is a measure of an aggregate property of water and can be interpreted in terms of specific substances only when the chemical composition of the sample is known.

Alkalinity is significant in many uses and treatments of natural waters and wastewaters. Because the alkalinity of many surface waters is primarily a function of carbonate, bicarbonate, and hydroxide content, it is taken as an indication of the concentration of these constituents. The measured values also may include contributions from borates, phosphates, silicates or other bases if these are present.

Alkalinity Measurements

Alkalinity in excess of alkaline earth metal concentrations is significant in determining the suitability of water for irrigation. Alkalinity measurements are used in the interpretation and control of water and wastewater treatment processes

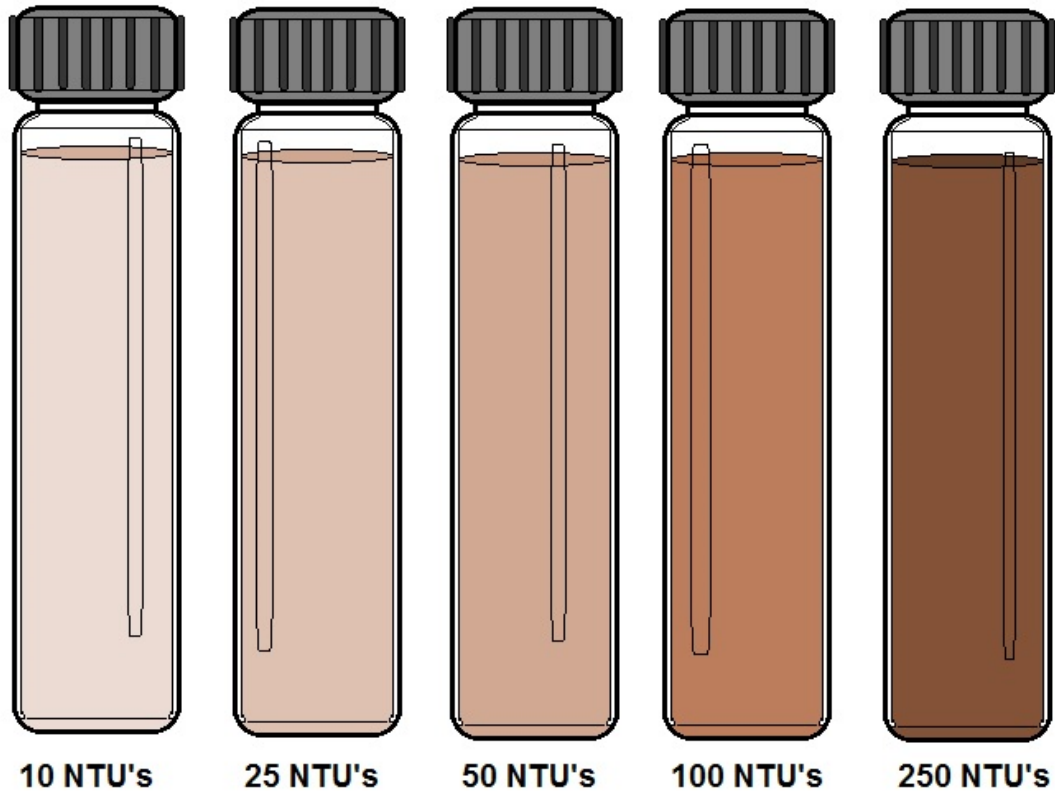

TURBIDITY SAMPLES IN NTU's (Nephelometric Turbidity Unit)

Turbidity Introduction

One physical characteristic of water is turbidity. A measure of the cloudiness of water caused by suspended particles. The cloudy appearance of water caused by the presence of tiny particles. High levels of turbidity may interfere with proper water treatment and monitoring. If high quality raw water is low in turbidity, there will be a reduction in water treatment costs. Turbidity is undesirable because it causes health hazards.

The turbidity in natural surface waters is composed of a large number of sizes of particles. The sizes of particles can be changing constantly, depending on precipitation and manmade factors.

When heavy rains occur, runoff into streams, rivers, and reservoirs occurs, causing turbidity levels to increase. In most cases, the particle sizes are relatively large and settle relatively quickly in both the water treatment plant and the source of supply. However, in some instances, fine, colloidal material may be present in the supply, which may cause some difficulty in the coagulation process.

Generally, higher turbidity levels require higher coagulant dosages. However, seldom is the relationship between turbidity level and coagulant dosage linear. Usually, the additional coagulant required is relatively small when turbidities are much higher than normal due to higher collision probabilities of the colloids during high turbidities.

Conversely, low turbidity waters can be very difficult to coagulate due to the difficulty in inducing collision between the colloids.

In this instance, floc formation is poor, and much of the turbidity is carried directly to the filters. Organic colloids may be present in a water supply due to pollution, and these colloids can be difficult to remove in the coagulation process. In this situation, higher coagulant dosages are generally required.

Turbidity MCL

An MCL for turbidity established by the EPA because turbidity interferes with disinfection. This characteristic of water changes the most rapidly after a heavy rainfall. The following conditions may cause an inaccurate measure of turbidity; the temperature variation of a sample, a scratched or unclean sample tube in the nephelometer and selecting an incorrect wavelength of a light path.

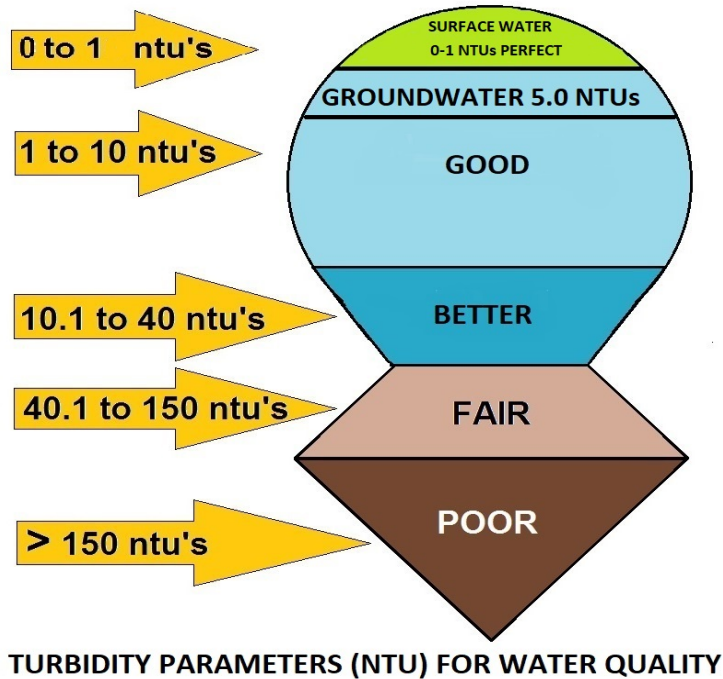

Surface Water System Compliance Information
(Depends on Systems and Rule)

- ▶ 0.34 NTU in 95% of samples, never to exceed 1.0 NTU spike
- ▶ Sample turbidity at each individual filter effluent
- ▶ Sample the combined filter turbidity at the clear well
- ▶ (Groundwater turbidity ≤ 5.0 NTU allowed)

Turbidity Key

- ▶ Turbidity can also be measured in ppm (parts per million) and its size is measured in microns. Turbidity can be particles in the water consisting of finely divided solids, larger than molecules, but not visible by the naked eye; ranging in size from .001 to .150mm (1 to 150 microns).
- ▶ 0.34 NTU in 95% of surface water samples, never to exceed 1.0 NTU spike

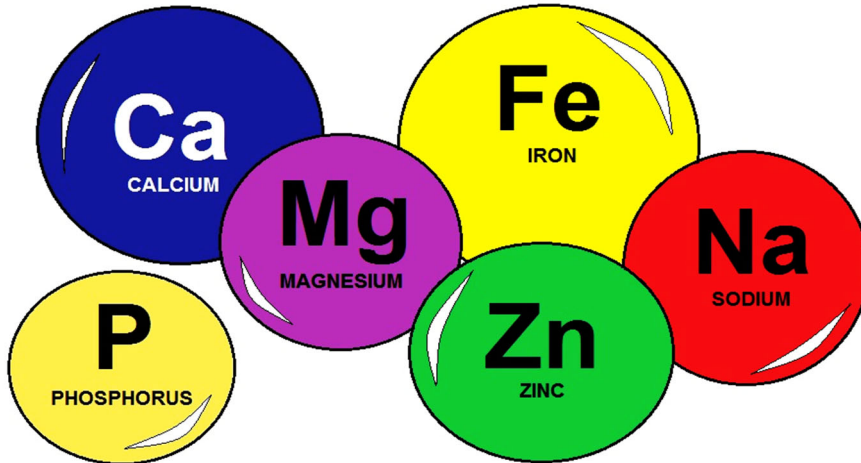

EXAMPLES OF TDS
(Total Dissolved Solids)
FOUND IN WATER SOURCES

CAN BE FROM AGRICULTURE OR URBAN RUNOFF, WHICH CARRY EXCESS MINERALS INTO THE WATER SOURCE

MINERAL SPRINGS CONTAIN HIGH LEVELS OF TDS BECAUSE THE ROCKS WHICH THE WATER SOURCE FLOWS THROUGH HAVE A HIGH SALT CONTENT



MINERALS THAT AFFECT THE QUALITY OF WATER SOURCE

Lead does not usually occur naturally in water supplies but is derived from lead distribution and domestic pipework and fittings. Water suppliers (distribution systems) have removed most of the original lead piping from the mains distribution system, however many older properties still have lead service pipes and internal lead pipework. The pipework (including the service pipe) within the boundary of the property is the responsibility of the owner of the property, not the water supplier.

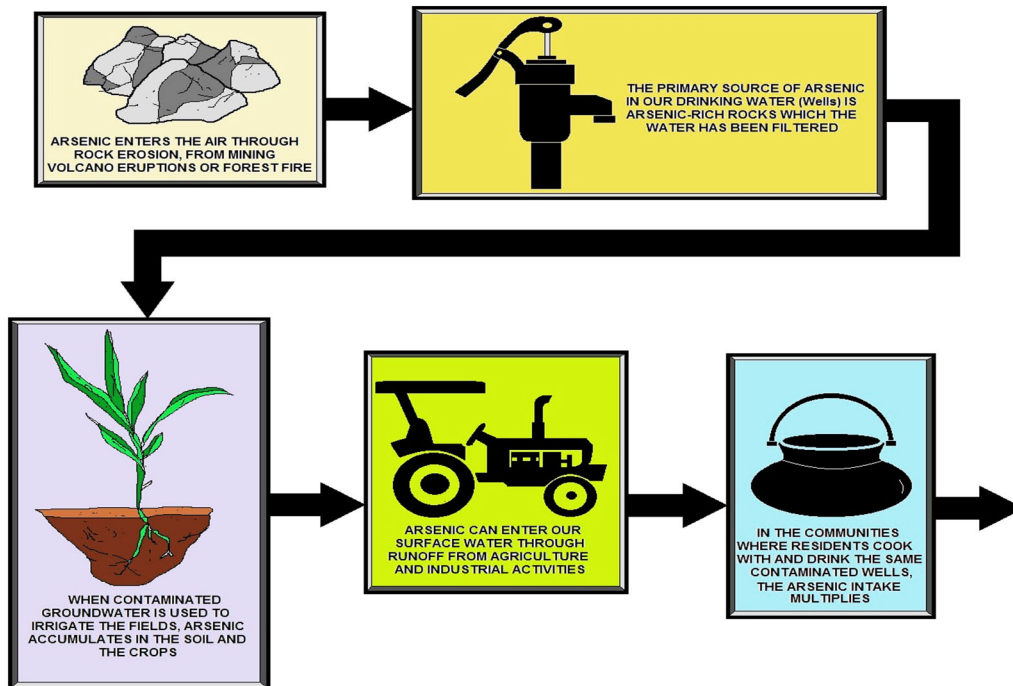

ARSENIC IN DRINKING WATER

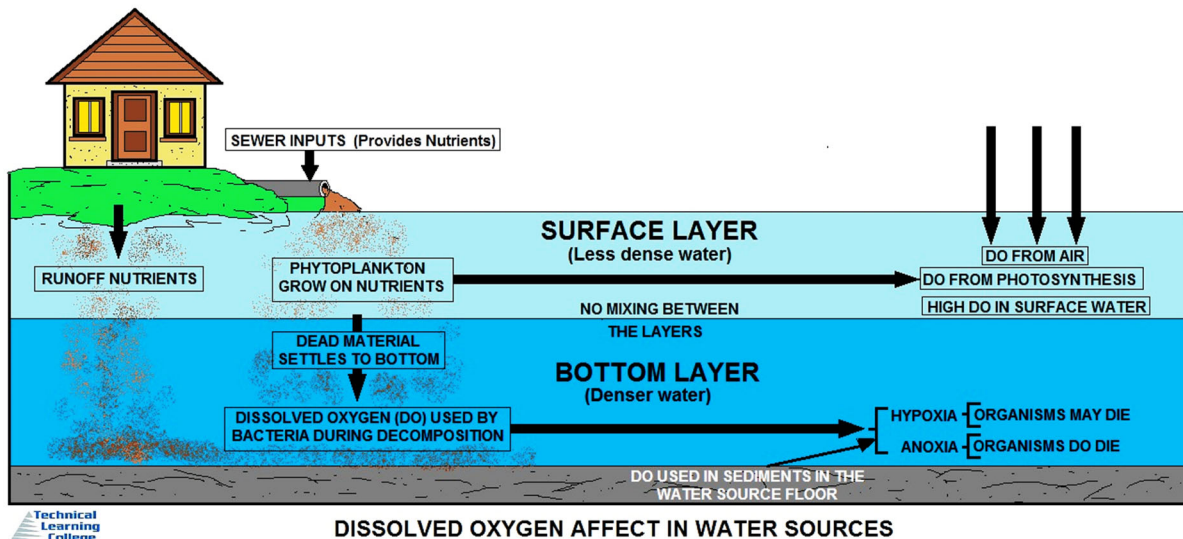

Dissolved Oxygen

The level of dissolved oxygen in natural waters is often a direct indication of quality, since aquatic plants produce oxygen, while microorganisms generally consume it as they feed on pollutants. At low temperatures the solubility of oxygen is increased, so that in winter, concentrations as high as 20 ppm may be found in natural waters; during summer, saturation levels can be as low as 4 or 5 ppm. Dissolved oxygen is essential for the support of fish and other aquatic life and aids in the natural decomposition of organic matter.

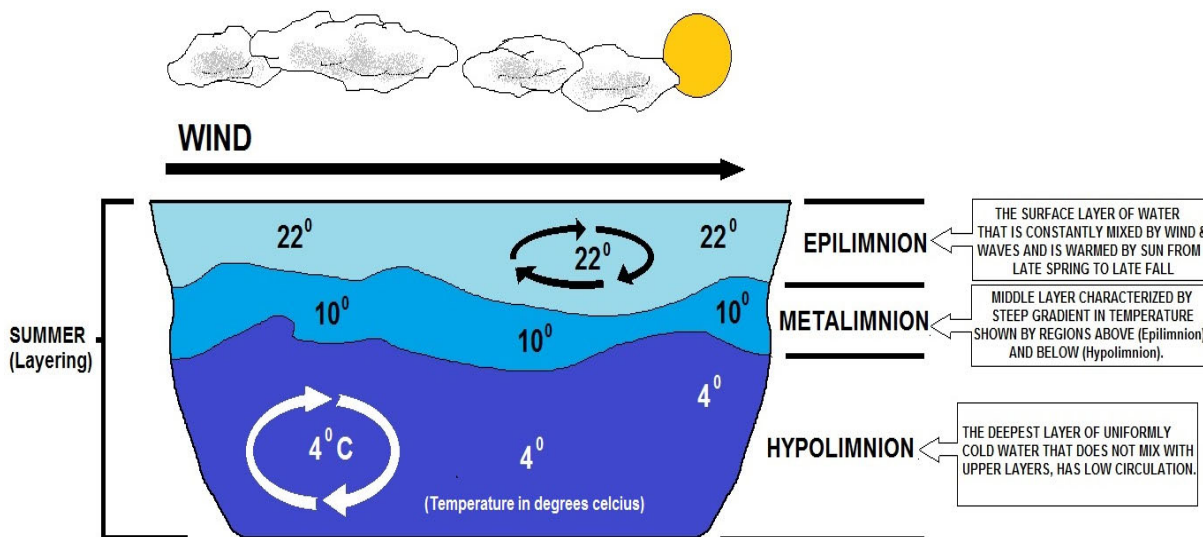

THERMAL STRATIFICATION (Temperature Transition Zones)

Thermal stratification is possible as **water becomes less dense when heated**, meaning water weighs less per unit volume. Therefore, warmer water will be lighter and colder water will be heavier. Due to this, there will always be a level of “self-induced” thermal stratification in a water storage.

pH Sub-Section

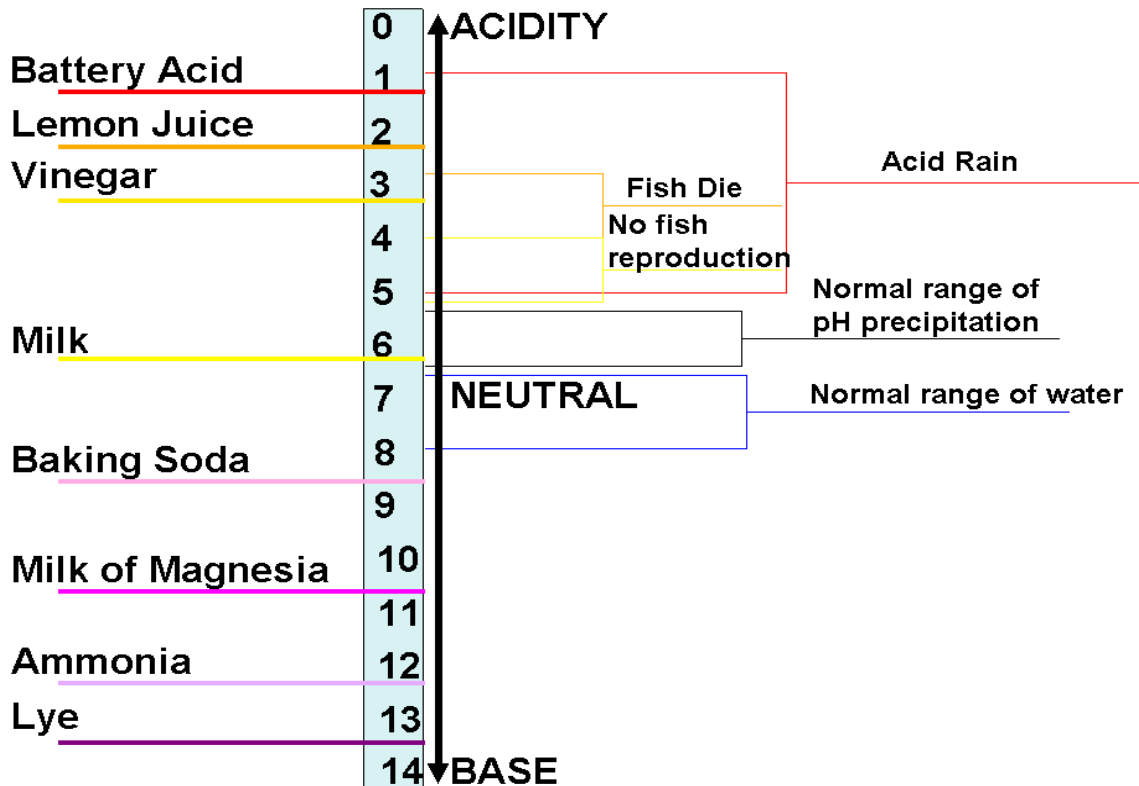

Basics

pH: A measure of the acidity of water. The pH scale runs from 0 to 14 with 7 being the mid-point or neutral.

A pH of less than 7 is on the acid side of the scale with 0 as the point of greatest acid activity.

A pH of 7, there are an equal amount or number of hydroxyl (OH⁻) and Hydrogen (H⁺) ions in the solution.

A pH of more than 7 is on the basic (alkaline) side of the scale with 14 as the point of greatest basic activity. Normal rain has a pH of **5.6** – slightly acidic because of the carbon dioxide picked up in the earth's atmosphere by the rain.

pH = (Power of Hydroxyl Ion Activity).

The acidity of a water sample is measured on a pH scale. This scale ranges from **0** (maximum acidity) to **14** (maximum alkalinity). The middle of the scale, **7**, represents the neutral point. The acidity increases from neutral toward **0**.

Because the scale is logarithmic, a difference of one pH unit represents a tenfold change. For example, the acidity of a sample with a pH of **5** is ten times greater than that of a sample with a pH of **6**. A difference of 2 units, from **6** to **4**, would mean that the acidity is one hundred times greater, and so on.

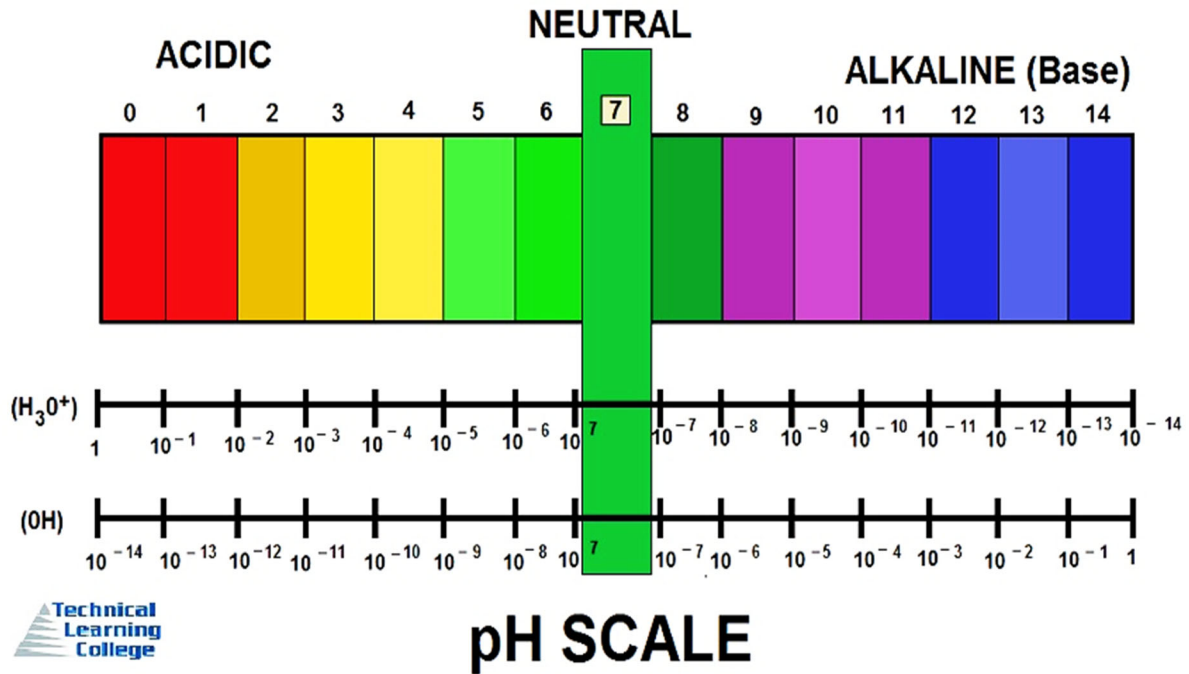

Hydrogen Ion pH Comparison Chart

pH	Hydrogen Ion Concentration, mmol/L
14	0.00000000000001
13	0.0000000000001
12	0.000000000001
11	0.00000000001
10	0.000000001
9	0.00000001
8	0.0000001
7	0.0000001
6	0.000001
5	0.00001
4	0.0001
3	0.001
2	0.01
1	0.1

pH Testing Section

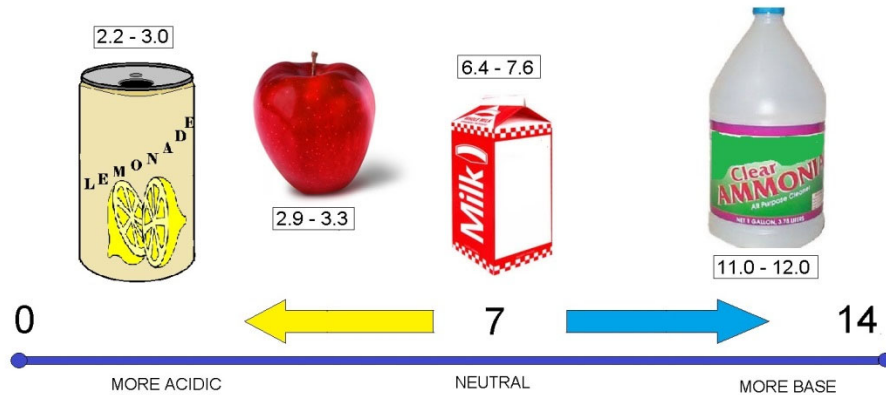

pH SCALE

As a water treatment operator, you will need to master pH sampling and testing. pH measurements are important in water and wastewater processes (sampling) but also in medicine, biology, chemistry, agriculture, forestry, food science, environmental science, oceanography, civil engineering, chemical engineering, nutrition, and many other applications.

In water and wastewater processes, **pH** is a measure of the acidity or basicity of an aqueous solution.

The pH scale is traceable to a set of standard solutions whose pH is established by international agreement.

Primary pH standard values are determined using a concentration cell with transference, by measuring the potential difference between a hydrogen electrode and a standard electrode such as a silver chloride electrode. Measurement of pH for aqueous solutions can be done with a glass electrode and a pH meter, or using indicators like strip test paper.

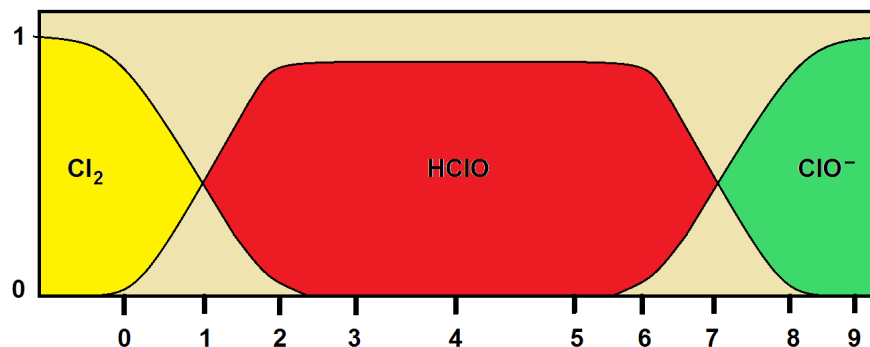

pH VALUES CHANGE WITH THE ADDITION OF DIFFERENT TYPES OF CHLORINE

Mathematically, pH is the measurement of hydroxyl ion (H^+) activity and expressed as the negative logarithm of the activity of the (solvated) hydronium ion, more often expressed as the measure of the hydronium ion concentration.

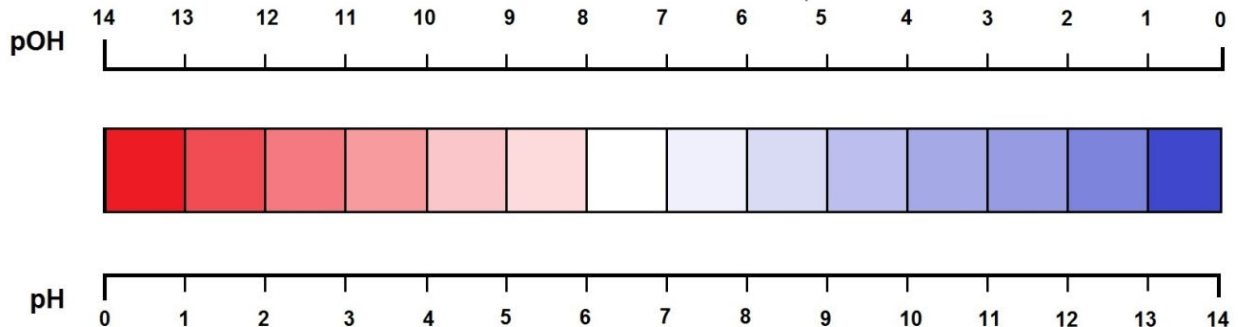

**RELATIONSHIP BETWEEN $p(OH^-)$ & $p(H^+)$
red = ACIDIC / blue = BASIC)**

History

The scientific discovery of the $p[H]$ concept was first introduced by Danish chemist Søren Peder Lauritz Sørensen at the Carlsberg Laboratory back in 1909 and revised to the modern pH in 1924 to accommodate definitions and measurements in terms of electrochemical cells. In the first papers, the notation had the "H" as a subscript to the lowercase "p", as so: pH .

Alkalinity

Alkalinity is the quantitative capacity of an aqueous solution to neutralize an acid. Measuring alkalinity is important in determining a stream's ability to neutralize acidic pollution from rainfall or wastewater. It is one of the best measures of the sensitivity of the stream to acid inputs. There can be long-term changes in the alkalinity of rivers and streams in response to human disturbances.

Reference. Bates, Roger G. Determination of pH: theory and practice. Wiley, 1973.

pH Definition and Measurement

CONCENTRATION OF HYDROGEN IONS COMPARED TO DISTILLED H ₂ O	1/10,000,000	14	LIQUID DRAIN CLEANER CAUSTIC SODA	EXAMPLES OF SOLUTIONS AND THEIR RESPECTIVE pH
	1/1,000,000	13	BLEACHES OVEN CLEANERS	
	1/100,000	12	SOAPY WATER	
	1/10,000	11	HOUSEHOLD AMMONIA (11.9)	
	1/1,000	10	MILK OF MAGNESIUM (10.5)	
	1/100	9	TOOTHPASTE (9.9)	
	1/10	8	BAKING SODA (8.4) / SEA WATER EGGS	
	0	7	"PURE" WATER (7)	
	10	6	URINE (6) / MILK (6.6)	
	100	5	ACID RAIN (5.6) BLACK COFFEE (5)	
	1000	4	TOMATO JUICE (4.1)	
	10,000	3	GRAPEFRUIT & ORANGE JUICE SOFT DRINK	
	100,000	2	LEMON JUICE (2.3) VINEGAR (2.9)	
	1,000,000	1	HYDROCHLORIC ACID SECRETED FROM STOMACH LINING (1)	
	10,000,000	0	BATTERY ACID	

pH Scale

Technical Definition of pH

In technical terms, pH is defined as the decimal logarithm of the reciprocal of the hydrogen ion activity, a_{H^+} , in a solution.

$$pH = -\log_{10}(a_{H^+}) = \log_{10}\left(\frac{1}{a_{H^+}}\right)$$

Ion-selective electrodes are often used to measure pH, respond to activity.

In this calculation of electrode potential, E , follows the Nernst equation, which, for the hydrogen ion can be written as

$$E = E^0 + \frac{RT}{F} \ln(a_{H^+}) = E^0 - \frac{2.303RT}{F} pH$$

where E is a measured potential, E^0 is the standard electrode potential, R is the gas constant, T is the temperature in kelvin, F is the Faraday constant. For H^+ number of electrons transferred is one. It follows that electrode potential is proportional to pH when pH is defined in terms of activity.

International Standard ISO 31-8 is the standard for the precise measurement of pH as follows: A galvanic cell is set up to measure the electromotive force (EMF) between a reference electrode and an electrode sensitive to the hydrogen ion activity when they are both immersed in the same aqueous solution.

The reference electrode may be a silver chloride electrode or a calomel electrode. The hydrogen-ion selective electrode is a standard hydrogen electrode.

Reference electrode | concentrated solution of KCl || test solution | H₂ | Pt

Firstly, the cell is filled with a solution of known hydrogen ion activity and the emf, E_s , is measured. Then the emf, E_x , of the same cell containing the solution of unknown pH is measured.

$$pH(X) = pH(S) + \frac{E_s - E_x}{Z}$$

The difference between the two measured emf values is proportional to pH. This method of calibration avoids the need to know the standard electrode potential. The proportionality

constant, $1/z$ is ideally equal to $\frac{1}{2.303RT/F}$ the "Nernstian slope".

If you were to apply this practice the above calculation, a glass electrode is used rather than the cumbersome hydrogen electrode. A combined glass electrode has an in-built reference electrode. It is calibrated against buffer solutions of known hydrogen ion activity. IUPAC has proposed the use of a set of buffer solutions of known H⁺ activity.

Two or more buffer solutions should be used in order to accommodate the fact that the "slope" may differ slightly from ideal.

The electrode is first immersed in a standard solution and the reading on a pH meter is adjusted to be equal to the standard buffer's value, to implement the proper calibration. The reading from a second standard buffer solution is then adjusted, using the "slope" control, to be equal to the pH for that solution. Further details, are given in the IUPAC recommendations.

When more than two buffer solutions are used the electrode is calibrated by fitting observed pH values to a straight line with respect to standard buffer values. Commercial standard buffer solutions usually come with information on the value at 25 °C and a correction factor to be applied for other temperatures. The pH scale is logarithmic and pH is a dimensionless quantity.

pH Indicators

Visual comparison of the color of a test solution with a standard color chart provides a means to measure pH accurate to the nearest whole number. Indicators may be used to measure pH, by making use of the fact that their color changes with pH.

More precise measurements are possible if the color is measured spectrophotometrically, using a colorimeter or spectrophotometer. Universal indicator consists of a mixture of indicators such that there is a continuous color change from about pH 2 to pH 10. Universal indicator paper is made from absorbent paper that has been impregnated with universal indicator.

pOH

pOH is sometimes used as a measure of the concentration of hydroxide ions, OH^- , or alkalinity. pOH values are derived from pH measurements. The concentration of hydroxide ions in water is related to the concentration of hydrogen ions by

$$[\text{OH}^-] = \frac{K_w}{[\text{H}^+]}$$

where K_w is the self-ionization constant of water. Taking logarithms

$$\text{pOH} = \text{p}K_w - \text{pH}$$

At room temperature $\text{pOH} \approx 14 - \text{pH}$. However, this relationship is not strictly valid in other circumstances, such as in measurements of soil alkalinity.

Extremes of pH

Measurement of pH below about 2.5 (ca. $0.003 \text{ mol dm}^{-3}$ acid) and above about 10.5 (ca. $0.0003 \text{ mol dm}^{-3}$ alkali) requires special procedures because, when using the glass electrode, the Nernst law breaks down under those conditions.

Extreme pH measurements imply that the solution may be concentrated, so electrode potentials are affected by ionic strength variation. At high pH the glass electrode may be affected by "alkaline error", because the electrode becomes sensitive to the concentration of cations such as Na^+ and K^+ in the solution. Specially constructed electrodes are available which partly overcome these problems. Runoff from industrial outfalls, restaurant grease, mines or mine tailings can produce some very low pH values.

Applications

Water has a pH of $\text{p}K_w/2$, so the pH of pure water is about 7 at 25°C ; this value varies with temperature. When an acid is dissolved in water, the pH will be less than that of pure water. When a base, or alkali, is dissolved in water, the pH will be greater than that of pure water.

A solution of a strong acid, such as hydrochloric acid, at concentration 1 mol dm^{-3} has a pH of 0. A solution of a strong alkali, such as sodium hydroxide, at concentration 1 mol dm^{-3} , has a pH of 14. Thus, measured pH values will lie mostly in the range 0 to 14, though negative pH values and values above 14 are entirely possible.

Since pH is a logarithmic scale, a difference of one pH unit is equivalent to a tenfold difference in hydrogen ion concentration.

The pH of an aqueous solution of pure water is slightly different from that of a salt such as sodium chloride even though the salt is neither acidic nor basic.

In this case, the hydrogen and hydroxide ions' activity is dependent on ionic strength, so K_w varies with ionic strength. The pH of pure water decreases with increasing temperatures. One example is the pH of pure water at 50 °C is 6.55.

Seawater

The pH of seawater plays an important role in the ocean's carbon cycle, and there is evidence of ongoing ocean acidification caused by human caused carbon dioxide emissions. pH measurement can be complicated by the chemical properties of seawater, and several distinct pH scales exist in chemical oceanography.

These solutions have a relatively low ionic strength (~0.1) compared to that of seawater (~0.7), and, as a consequence, are not recommended for use in characterizing the pH of seawater, since the ionic strength differences cause changes in electrode potential.

To resolve this problem, an alternative series of buffers based on artificial seawater was developed. This new series resolves the problem of ionic strength differences between samples and the buffers. The newest pH scale is referred to as the **total scale**, often denoted as **pH_T**. The bottom line: do not use a fresh water pH meter to measure the pH of seawater.

Calculation of pH

The calculation of the pH of a solution containing acids and/or bases is an example of a chemical speciation calculation, that is, a mathematical procedure for calculating the concentrations of all chemical species that are present in the solution. The complexity of the procedure depends on the nature of the solution.

If the pH of a solution contains a weak acid requires the solution of a quadratic equation.

If the pH of a solution contains a weak base may require the solution of a cubic equation.

For strong acids and bases no calculations are necessary except in extreme situations.

The general case requires the solution of a set of non-linear simultaneous equations.

A complicating factor is that water itself is a weak acid and a weak base. It dissociates according to the equilibrium

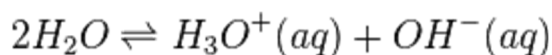

with a dissociation constant, K_w defined as

$$K_w = [H^+][OH^-]$$

where $[H^+]$ represents for the concentration of the aquated hydronium ion and $[OH^-]$ stands for the concentration of the hydroxide ion.

K_w has a value of about 10^{-14} at 25 °C, so pure water has a pH of approximately 7.

This equilibrium needs to be considered at high pH and when the solute concentration is extremely low.

Strong Acids and Bases

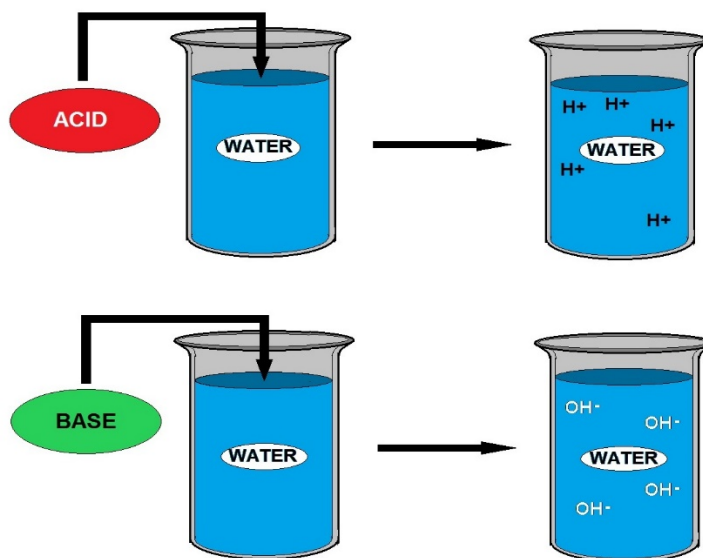

Strong Acids and Bases

Strong acids and bases are compounds that, for practical purposes, are completely dissociated in water. Under normal circumstances, this means that the concentration of hydrogen ions in acidic solution can be taken to be equal to the concentration of the acid. The pH is then equal to minus the logarithm of the concentration value.

Hydrochloric acid (HCl) is an example of a strong acid. The pH of a 0.01M solution of HCl is equal to $-\log_{10}(0.01)$, that is, $\text{pH} = 2$.

Sodium hydroxide, NaOH, is an example of a strong base. The $\text{p}[\text{OH}]$ value of a 0.01M solution of NaOH is equal to $-\log_{10}(0.01)$, that is, $\text{p}[\text{OH}] = 2$.

From the definition of $\text{p}[\text{OH}]$ above, this means that the pH is equal to about 12. For solutions of sodium hydroxide at higher concentrations, the self-ionization equilibrium must be taken into account.

Weak Acids and Bases

A weak acid or the conjugate acid of a weak base can be treated using the same formalism.

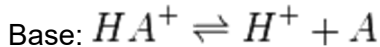
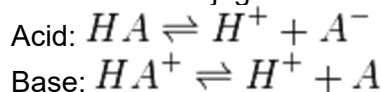

First, an acid dissociation constant is defined as follows. Electrical charges are omitted from subsequent equations for the sake of generality

$$K_a = \frac{[H][A]}{[HA]}$$

and its value is assumed to have been determined by experiment. This being so, there are three unknown concentrations, $[HA]$, $[H^+]$ and $[A^-]$ to determine by calculation. Two additional equations are needed.

One way to provide them is to apply the law of mass conservation in terms of the two "reagents" H and A.

$$\begin{aligned}C_A &= [A] + [HA] \\C_H &= [H] + [HA]\end{aligned}$$

C stands for analytical concentration. In some texts one mass balance equation is replaced by an equation of charge balance. This is satisfactory for simple cases like this one, but is more difficult to apply to more complicated cases as those below.

Together with the equation defining K_a , there are now three equations in three unknowns. When an acid is dissolved in water $C_A = C_H = C_a$, the concentration of the acid, so $[A] = [H]$. After some further algebraic manipulation an equation in the hydrogen ion concentration may be obtained.

$$[H]^2 + K_a[H] - K_aC_a = 0$$

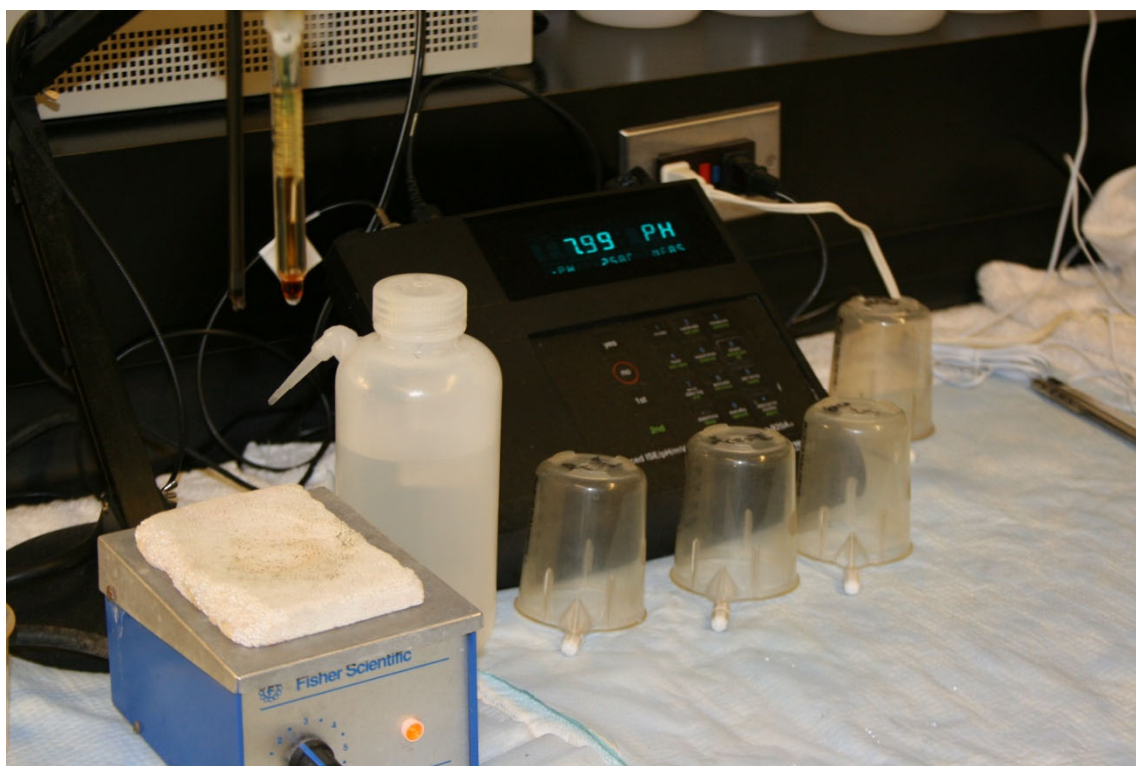

Digital pH Meter

Alkalinity Sub-Section

Introduction

Alkalinity of water is its acid-neutralizing capacity. It is the sum of all the titratable bases. The measured value may vary significantly with the end-point pH used. Alkalinity is a measure of an aggregate property of water and can be interpreted in terms of specific substances only when the chemical composition of the sample is known.

Alkalinity and pH Adjustment

Adjusting pH and alkalinity is the most common corrosion control method because it is simple and inexpensive. pH is a measure of the concentration of hydrogen ions present in water; alkalinity is a measure of water's ability to neutralize acids.

Generally, water pH less than 6.5 is associated with uniform corrosion, while pH between 6.5 and 8.0 can be associated with pitting corrosion. Some studies have suggested that systems using only pH to control corrosion should maintain a pH of at least 9.0 to reduce the availability of hydrogen ions as electron receptors. However, pH is not the only factor in the corrosion equation; carbonate and alkalinity levels affect corrosion as well.

Generally, an increase in pH and alkalinity can decrease corrosion rates and help form a protective layer of scale on corrodible pipe material.

Chemicals commonly used for pH and alkalinity adjustment are hydrated lime (CaOH_2 or calcium hydroxide), caustic soda (NaOH or sodium hydroxide), soda ash (Na_2CO_3 or sodium carbonate), and sodium bicarbonate (NaHCO_3 , essentially baking soda).

Care must be taken, however, to maintain pH at a level that will control corrosion but not conflict with optimum pH levels for disinfection and control of disinfection by-products.



Corrosion Inhibitors

Inhibitors reduce corrosion by forming protective coatings on pipes. The most common corrosion inhibitors are inorganic phosphates, sodium silicates and mixtures of phosphates and silicates. These chemicals have proven successful in reducing corrosion in many water systems.

The phosphates used as corrosion inhibitors include polyphosphates, orthophosphates, glassy phosphates and bimetallic phosphates. In some cases, zinc is added in conjunction with orthophosphates or polyphosphates.

Glassy phosphates, such as sodium hexametaphosphate, effectively reduce iron corrosion at dosages of 20 to 40 mg/l.

Glassy phosphate has an appearance of broken glass and can cut the operator. Sodium silicates have been used for over 50 years to inhibit corrosion. The effectiveness depends on the water pH and carbonate concentration.

Sodium silicates are particularly effective for systems with high water velocities, low hardness, low alkalinity and a pH of less than 8.4.

Typical coating maintenance doses range from 2 to 12 mg/l. They offer advantages in hot water systems because of their chemical stability. For this reason, they are often used in the boilers of steam heating systems.

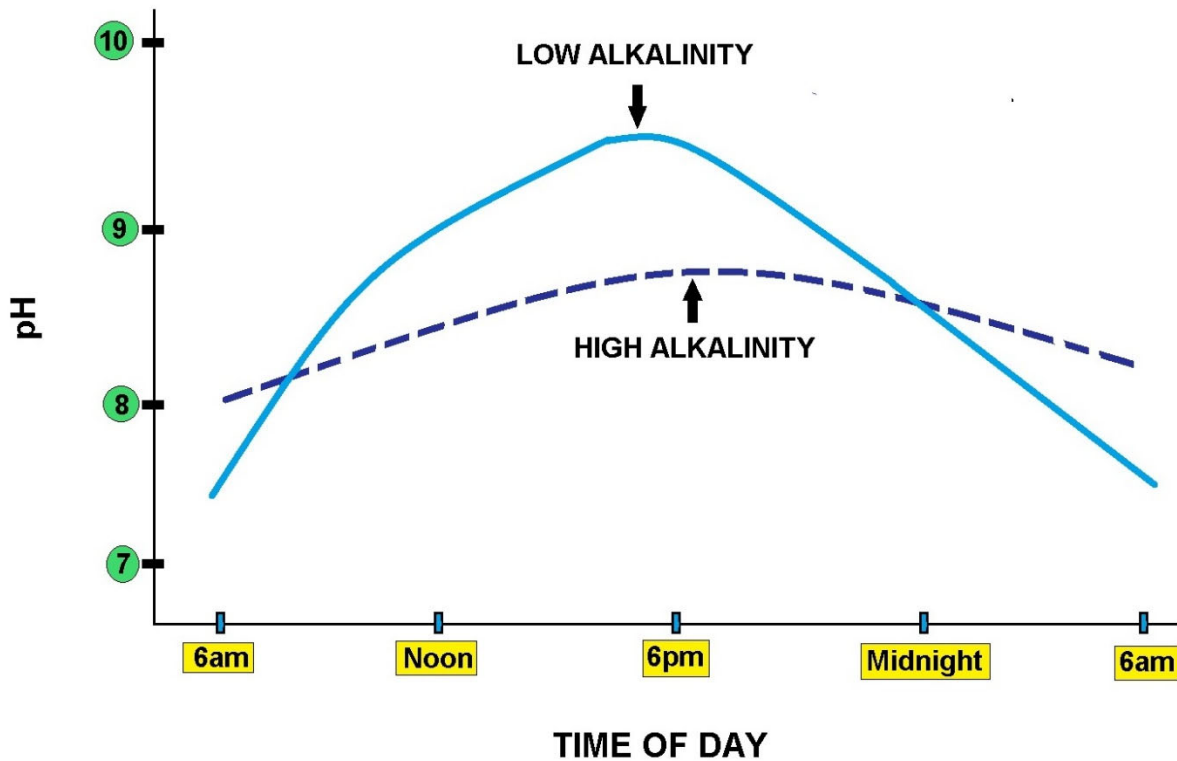

ALKALINITY CAN CHANGE THROUGHOUT THE DAY DIAGRAM

Hardness Introduction

Temporary and Permanent

There are two types of hardness: temporary and permanent. Temporary hardness comes out of the water when it is heated and is deposited as scale and “fur” on kettles, coffee makers and taps and appears as a scum or film on tea and coffee. Permanent hardness is unaffected by heating. We will cover this in the advanced water treatment section

WATER HARDNESS (Salt Types)	
CARBONATE HARDNESS COMPOUNDS	NON-CARBONATE HARDNESS COMPOUNDS
CALCIUM CARBONATE (CaCO_3)	CALCIUM SULPHATE (CaSO_4)
MAGNESIUM CARBONATE (MgCO_3)	MAGNESIUM SULPHATE (MgSO_4)
CALCIUM BICARBONATE ($\text{Ca}(\text{HCO}_3)_2$)	CALCIUM CHLORIDE (CaCl_2)
MAGNESIUM BICARBONATE ($\text{Mg}(\text{HCO}_3)_2$)	MAGNESIUM CHLORIDE (MgCl_2)
CALCIUM HYDROXIDE ($\text{Ca}(\text{OH})_2$)	
MAGNESIUM HYDROXIDE ($\text{Mg}(\text{OH})_2$)	



CAUSES OF HARDNESS THAT AFFECTS WATER QUALITY

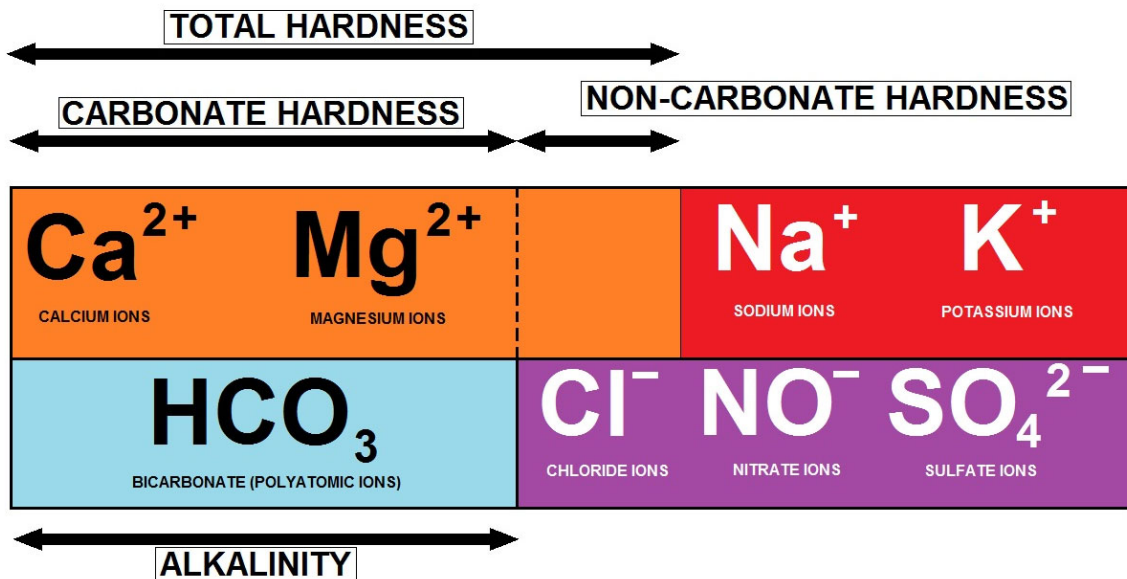

CARBONATE HARDNESS CHART

Objections to Hard Water

Scale Formation

Hard water forms scale, usually calcium carbonate, which causes a variety of problems. Left to dry on the surface of glassware and plumbing fixtures, including showers doors, faucets, and sink tops; hard water leaves unsightly white scale known as water spots. Scale that forms on the inside of water pipes will eventually reduce the flow capacity or possibly block it entirely. Scale that forms within appliances and water meters causes wear on moving parts.



When hard water is heated, scale forms much faster. In particular, when the magnesium hardness is more than about 40 mg/l (as CaCO_3), magnesium hydroxide scale will deposit in hot water heaters that are operated at normal temperatures of 140-150°F (60-66°C).

A coating of only 0.04 in. (1 mm) of scale on the heating surfaces of a hot water heater creates an insulation effect that will increase heating costs by about 10 percent.

Effect on Soap

The historical objection to hardness has been its effect on soap. Hardness ions form precipitates with soap, causing unsightly “**curd**,” such as the familiar bathtub ring, as well as reduced efficiency in washing and laundering. To counteract these problems, synthetic detergents have been developed and are now used almost exclusively for washing clothes and dishes.

These detergents have additives known as sequestering agents that “**tie up**” the hardness ions so that they cannot form the troublesome precipitates. Although modern detergents counteract many of the problems of hard water, many customers prefer softer water. These customers can install individual softening units or use water from another source, such as a cistern, for washing.

Total Dissolved Solids (TDS)

Total dissolved solids (TDS) represents the combined total of all organic and inorganic substances found in drinking water. The total dissolved solids present in water is one of the leading causes of particles and sediments in drinking water, which give water its color, odor, and flavor, and can be a general indicator of water quality.

Organic substances found in drinking water may include:

- Algae
- Bacteria
- Fungi
- Hair
- Pesticides
- Herbicides
- Fertilizers
- Disinfectants
- Pharmaceuticals

Inorganic substances found in drinking water may include:

- Arsenic
- Lead
- Mercury
- Chlorine
- Sodium
- Calcium
- Potassium
- Magnesium
- Fluoride

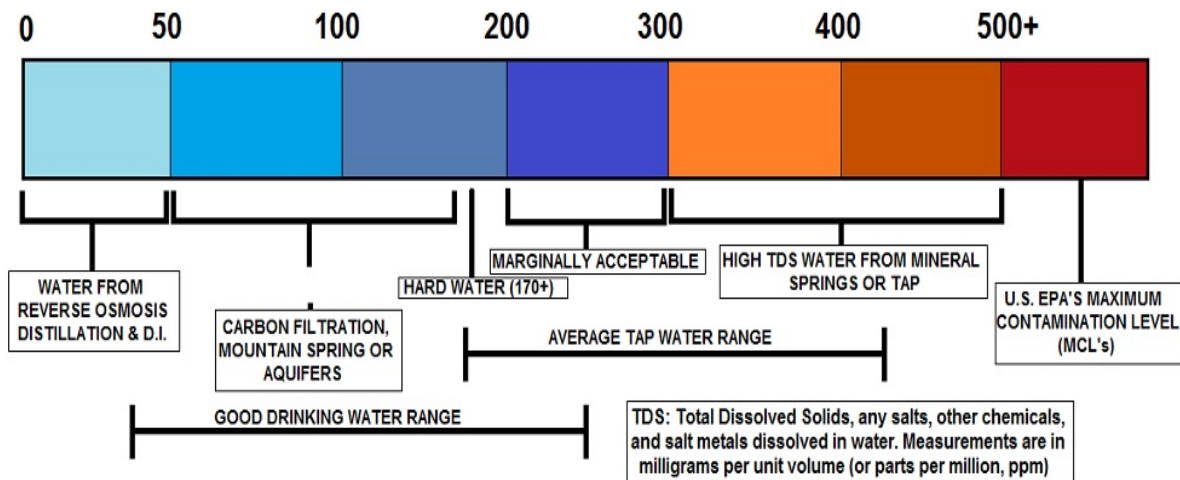

TDS (Total Dissolved Solids) Explained

Secondary Standard

TDS is most often measured in parts per million (ppm) or milligrams per liter of water (mg/L). The normal TDS level ranges from 50 ppm to 1,000 ppm. The Environmental Protection Agency (EPA), which is responsible for drinking water regulations in the United States, has identified TDS as a secondary standard, meaning that it is a voluntary guideline. While the United States set legal standards for many harmful substances, TDS, along with other contaminants that cause aesthetic, cosmetic, and technical effects, has only a guideline.

Levels of TDS (milligrams per litre)	Rating
Less than 300	Excellent
300 - 600	Good
600 - 900	Fair
900 - 1,200	Poor
Above 1,200	Unacceptable

Increased concentrations of dissolved solids can also have technical effects. Dissolved solids can produce hard water, which leaves deposits and films on fixtures and can corrode the insides of hot water pipes and boilers.

PARAMETERS	CLARITY	TURBIDITY	TOTAL SUSPENDED SOLIDS (TSS)
DEFINITION	HOW FAR LIGHT CAN PASS THROUGH THE WATER COLUMN	MEASURES THE DEGREE TO WHICH WATER LOSES IT'S TRANSPARENCY	PARTICLES THAT ARE LARGER THAN 2 MICRONS FOUND IN THE WATER COLUMN
COMMENTS	TURBIDITY AND CLARITY ARE DIRECTLY RELATED. TURBIDITY IS A MEASURE OF THE WATER'S CLARITY High Turbidity = Low Clarity Low Turbidity = High Clarity		WHILE TSS DIRECTLY AFFECTS TURBIDITY, TURBIDITY IS NOT A DIRECT MEASUREMENT OF TOTAL SUSPENDED SOLIDS
WHAT IS MEASURED?	ORGANIC AND INORGANIC SUSPENDED SOLIDS, LIKE CLAY, SILT, SEDIMENT, ALGAE AND BATERIA + DISSOLVED COLORED MATERIALS (Smaller than 2 Microns)		ORGANIC AND INORGANIC SUSPENDED SOLIDS SETTLABLE SOLIDS (Solids that are moved along the bottom of water by strong flow)
HOW IS IT MEASURED?	<u>DIRECT MEASUREMENT</u> : TURBIDIMETER or TURBIDITY SENSOR <u>INDIRECT MEASUREMENT</u> : SECCHI DISK or TURBIDITY TUBE Indirect Methods are Quick and Expensive but are Dependent on the Visual Acuity of the Observer		TO MEASURE TSS, A WATER SAMPLE IS FILTERED, DRIED AND WEIGHED

TOTAL DISSOLVED SOLIDS / WATER TREATMENT



Langelier Saturation Index

The Langelier Saturation index (LSI) is an equilibrium model derived from the theoretical concept of saturation and provides an indicator of the degree of saturation of water with respect to calcium carbonate. It can be shown that the Langelier saturation index (LSI) approximates the base 10 logarithm of the calcite saturation level. The Langelier saturation level approaches the concept of saturation using pH as a main variable. The LSI can be interpreted as the pH change required to bring water to equilibrium.

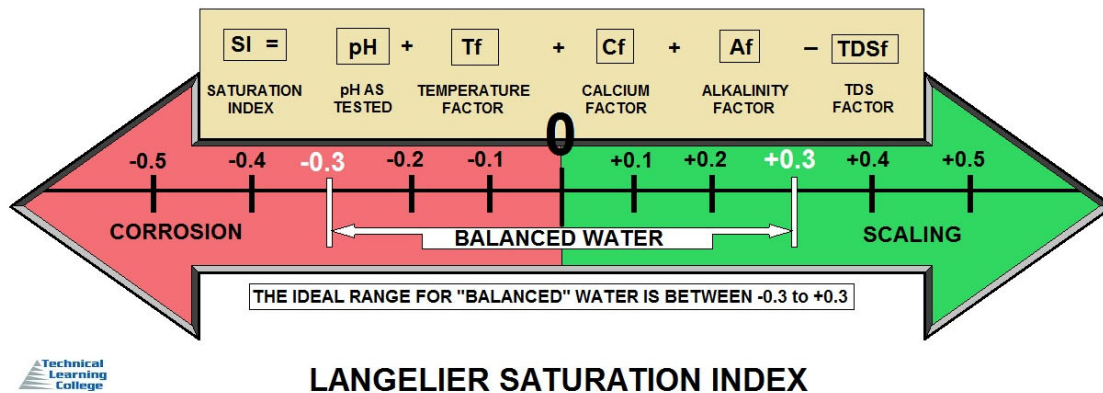

Water with a Langelier saturation index of 1.0 is one pH unit above saturation. Reducing the pH by 1 unit will bring the water into equilibrium. This occurs because the portion of total alkalinity present as CO_3^{2-} decreases as the pH decreases, according to the equilibria describing the dissociation of carbonic acid:

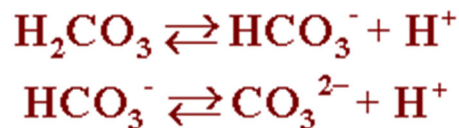

- If LSI is negative: No potential to scale, the water will dissolve CaCO_3
- If LSI is positive: Scale can form and CaCO_3 precipitation may occur
- If LSI is close to zero: Borderline scale potential.
- Water quality or changes in temperature, or evaporation could change the index.

The LSI is probably the most widely used indicator of cooling water scale potential. It is purely an equilibrium index and deals only with the thermodynamic driving force for calcium carbonate scale formation and growth. It provides no indication of how much scale or calcium carbonate will actually precipitate to bring water to equilibrium.

It simply indicates the driving force for scale formation and growth in terms of pH as a master variable. In order to calculate the LSI, it is necessary to know the alkalinity (mg/l as CaCO_3), the calcium hardness (mg/l Ca^{2+} as CaCO_3), the total dissolved solids (mg/l TDS), the actual pH, and the temperature of the water ($^{\circ}\text{C}$).

If TDS is unknown, but conductivity is, one can estimate mg/L TDS using a conversion table.
LSI is defined as:

$$\text{LSI} = \text{pH} - \text{pH}_s$$

Where:

pH is the measured water pH

pH_s is the pH at saturation in calcite or calcium carbonate and is defined as:

$$\text{pH}_s = (9.3 + \text{A} + \text{B}) - (\text{C} + \text{D})$$

Where:

$$\text{A} = (\text{Log}_{10} [\text{TDS}] - 1) / 10$$

$$\text{B} = -13.12 \times \text{Log}_{10} (^\circ\text{C} + 273) + 34.55$$

$$\text{C} = \text{Log}_{10} [\text{Ca}^{2+} \text{ as CaCO}_3] - 0.4$$

$$\text{D} = \text{Log}_{10} [\text{alkalinity as CaCO}_3]$$

Radiological Characteristics

Radiological characteristics are the result of water coming in contact with radioactive materials. This could be associated with atomic energy.

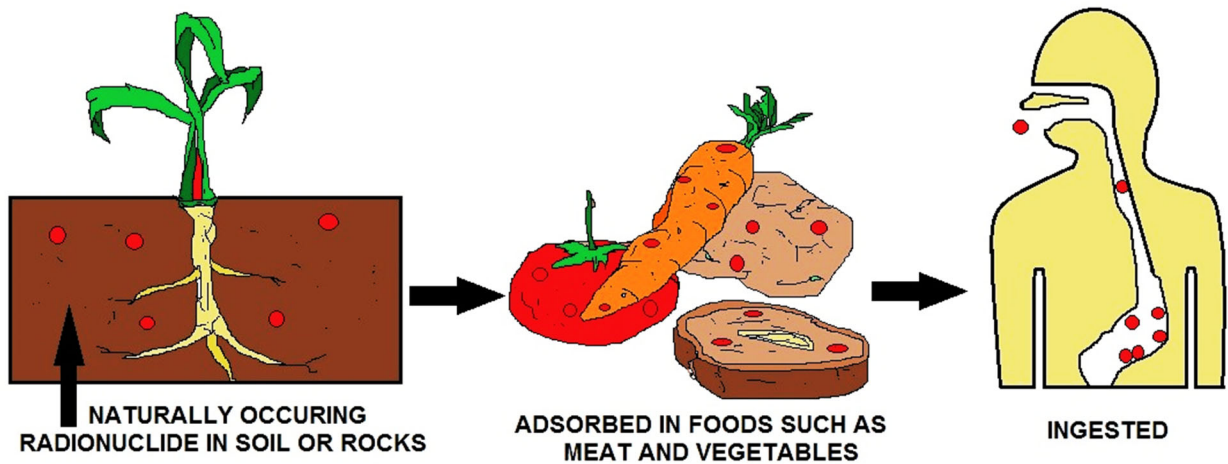

RADIONUCLIDES

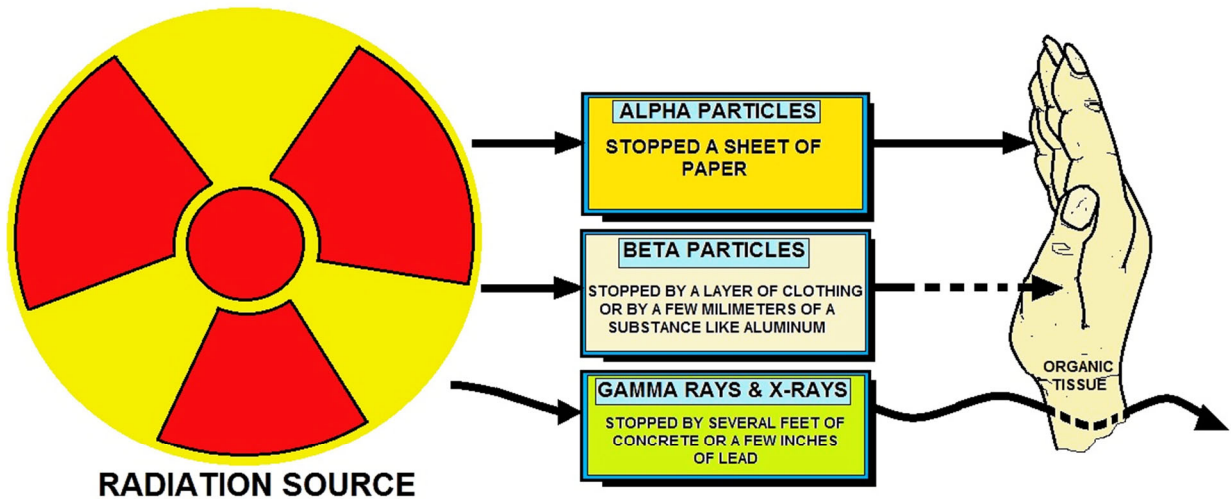

PENETRATING POWER OF ALPHA / BETA PARTICLES AND GAMMA RAYS AND X-RAYS

Most of these substances are of natural origin and are picked up as water passes around the water cycle. Some are present due to the treatment processes that are used to make the water suitable for drinking and cooking.

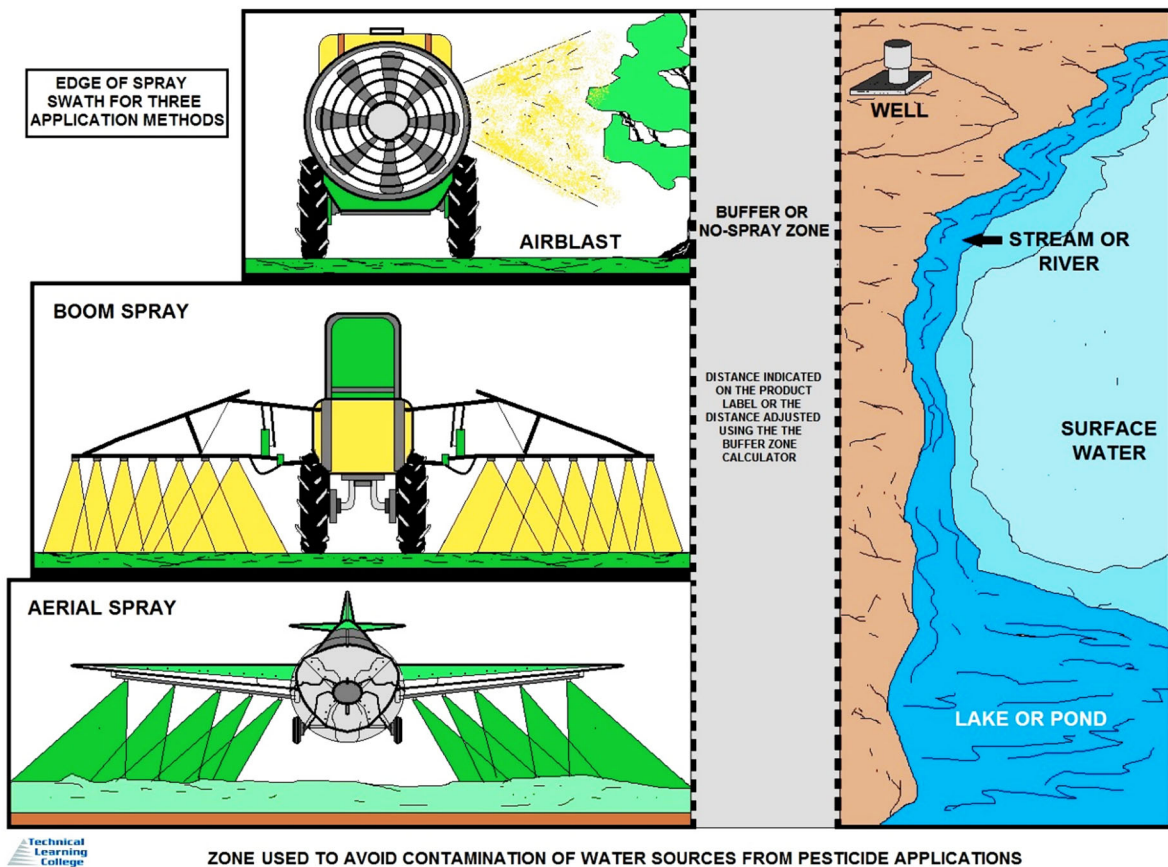

Insecticides and Herbicides

Insecticides and herbicides (sometimes referred to as pesticides) are widely used in agriculture, industry, leisure facilities and gardens to control weeds and insect pests and may enter the water cycle in many ways. Aluminum salts are usually added during water treatment to remove color and suspended solids and may reduce any residual insecticides in the water.

Biological Characteristics of Water

Biological characteristics are the presence of living or dead organisms. Biological characteristics will also interact with the chemical composition of the water. The consumer will become sick or complain about hydrogen sulfide odors, the rotten egg smell. We will cover the Total Coliform Rule in detail in the Water Monitoring Section - Microbiological section and again in the Appendix.

Pathogen Definition

A pathogen is an organism capable of causing disease. Pathogens include parasites, bacteria and viruses.

Biological Parameters

- Biological parameters are important factor that determine quality of drinking water. It is more important than physical and chemical parameters in term of direct effect on human health.
- Some important biological characteristics affecting quality of drinking water includes bacteria, protozoa, virus and algae.

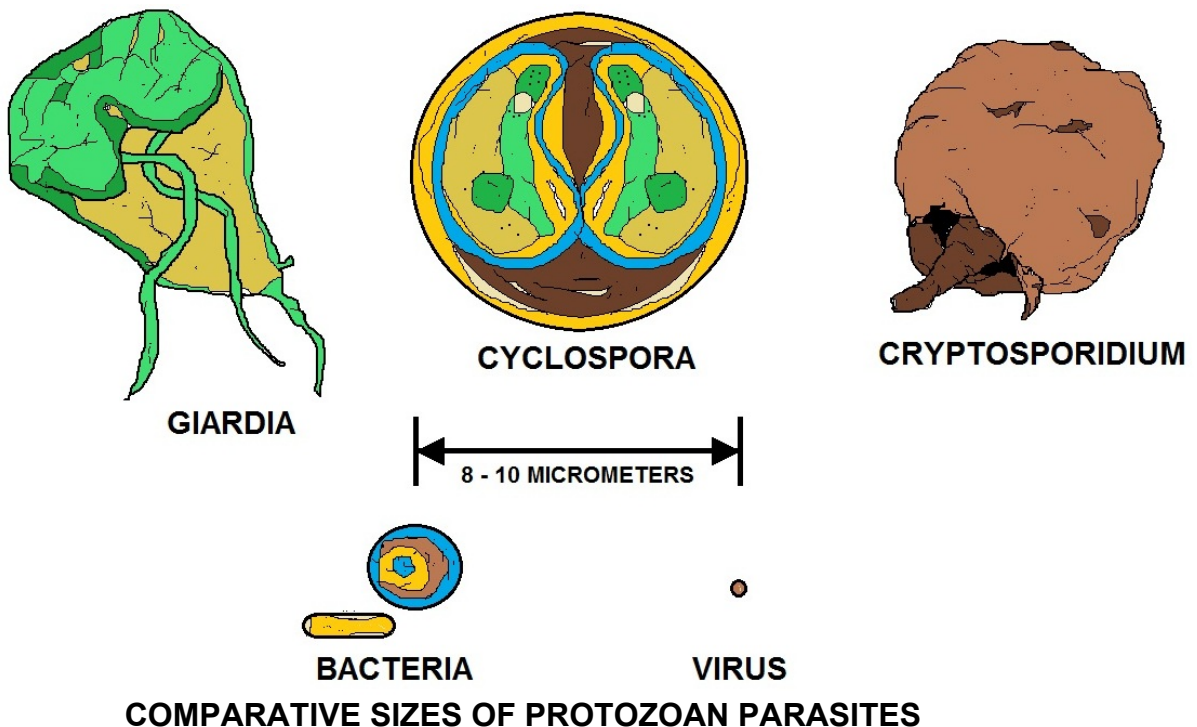

Bacteriological Aspects of Water Pollution

- Human beings and other animals discharge large number of intestinal bacteria into stool and urine. Therefore, bacteria appears in drinking water when water source is contaminated with feces.
- Some intestinal bacteria which are normal flora of intestine are not pathogenic while other bacteria causes serious disease when they are present in drinking water.
- Some pathogenic bacteria includes- *Salmonella*, *Shigella*, *Vibrio cholera*, *Yersinia enterocolitica*.

- These bacteria are only present in drinking water if source of water is contaminated with feces.
- Drinking water must be regularly check to detect intestinal pathogens. However all intestinal pathogens are difficult to cultivate and identify in routine examination. Therefore, presence of pathogenic intestinal bacteria is indirectly checked by detecting intestinal normal flora. Such organism which are routinely checked for quality of water is known as indicator organism for fecal contamination.
- Some indicator organism are fecal coliform (*E. coli*), fecal Streptococci (*Enterococcus*), *Clostridium perfringens*

Cysts

Cysts are associated with the reproductive stages of parasitic microorganisms (protozoans) which can cause acute diarrhea type illnesses; they come from farm animals, wild animals and people. Cysts are very resistant to normal disinfection processes but can be removed by advanced filtration processes installed in water treatment works. Cysts are rarely present in the public water supply. We will cover this area in the water monitoring section.

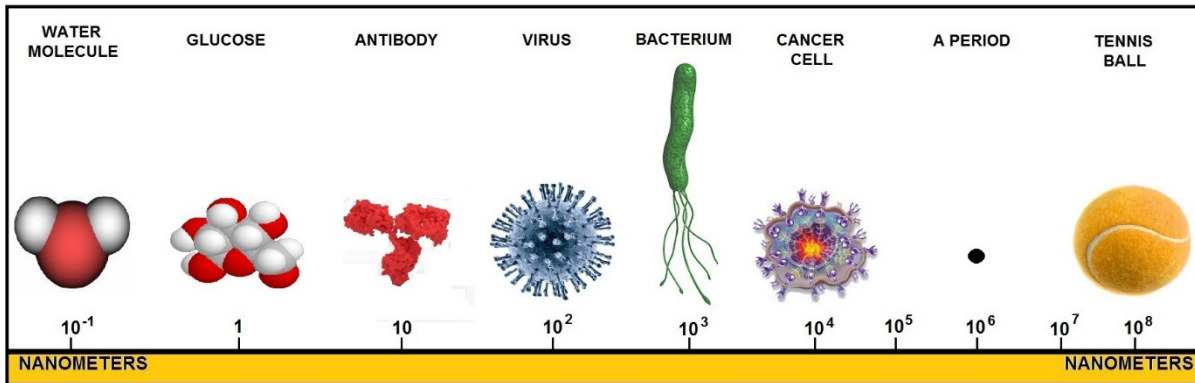

SIZE COMPARISON
HOW SMALL IS SMALL ?









PRESENCE OF PATHOGENS IN WATER	TYPES OF PATHOGENS FOUND IN WATER
THE PRESENCE OF COLIFORM BACTERIA CAN INDICATE THERE MAY BE HARMFUL BACTERIA PATHOGENS IN THE WATER	
THE PRINCIPAL REMOVAL PROCESSES ARE THOSE LIKELY USED TO REMOVE THE MAJORITY OF THE MICROBES IN WATER BEING TREATED	
THE REMOVAL PROCESSES BEING UTILIZED ARE SEDIMENTATION, FLOTATION AND THE USE OF HIGH RATE GRANULAR MEDIA FILTRATION	
DISINFECTION WITH IODINE OR CHLORINE IS THE MOST EFFECTIVE AT KILLING VIRUSES FOUND IN WATER.	



PATHOGENS FOUND IN WATER SUPPLIES

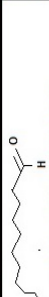

Drinking Water Tastes and Odors

Health concerns are not the only criteria that we use to judge our drinking water. In fact, often the most noticeable qualities that determine whether water is acceptable to consumers are unpleasant taste or odor, staining, poor reaction with soap, or mineral buildup in pipes and plumbing. These problems result from elevated concentrations of "nuisance" constituents.

CHEMICAL / HYDROCARBON / MISC.		MEDICINAL / PHENOLIC	FISHY / RANCID	FRAGRANT / FRUITY / FLOWERY		MARSHY / SWAMPY / SEPTIC / SULFUROUS		GRASSY / HAY / STRAW / WOODY						
LICORICE	SWEET SOLVENT	SWEET (TUTTL-FRUITT)	MEDICINAL	RANCID / SWEATY SOCKS	FISHY	SWEET / BUTTERY	CUCUMBER	VIOLET	MARSHY / SWAMPY / GARLICKY	DECAYING VEGETABLES	CANNED CORN	DECAYING CABBAGE	GRASSY	HAY / WOODY
			CHLOROPHENOLS, BROMOPHENOLS						DIMETHYL TRISULFIDE	DIMETHYL SULFIDE (high - conc.)	DIMETHYL SULFIDE (low - conc.)	METHYL MERCAPTAN		

CHLORINOUS / OZONOUS		EARTHY / MUSTY			MOUTHFEEL / NOSEFEEL		BITTER	SALTY	SWEET	SOUR / ACIDIC	
CHLORINOUS	SWIMMING POOL	MUSTY	MOLDY CORK	EARTHY	COOLING	CHALKY	ASTRINGENT	BITTER	SALTY	SWEET	SOUR / ACIDIC
FREE CHLORINE	DICHLORAMINE				MENTHOL	CALCIUM CARBONATE	ALUMINIUM SULFATE	CAFFEINE, QUININE HYDROCHLORIDE	SODIUM CHLORIDE	SUGAR, LEAD SALTS	CITRIC ACID, MAGNESIUM SULFATE



WATER AND TASTE DECODER

Most nuisance constituents occur naturally. These constituents are more likely to occur at nuisance concentrations in groundwater than surface water, because they result from the reaction of groundwater with aquifer rocks and sediments as the water moves underground.

Yellow Water Complaints

Dissolved iron in groundwater can stain laundry, sinks, bathtubs, and toilets a brownish red, and can degrade plumbing and heating systems. Iron also gives drinking water an unpleasant taste, making it undrinkable for many well owners. Manganese often co-occurs with iron and causes many of the same problems.

Hard Water

Hard water—defined by high concentrations of calcium and magnesium—causes water pipes and fixtures to become coated with scale, limits the ability of soaps and detergents to form suds, and can cause premature failure of plumbing and heating fixtures. pH outside of acceptable ranges can give water a metallic taste and can cause corrosion of pipes. A high dissolved solids concentration—a measure of all dissolved substances in water, also referred to as salinity—makes water taste disagreeably salty.

EPA Guidelines for Nuisance Constituents

The EPA recommends limits, called Secondary Maximum Contaminant Levels (SMCLs), for nuisance constituents in public water supplies. The SMCLs are non-health-based, non-enforceable guidelines for concentrations of 15 constituents in drinking water. These guidelines are designed to assist public water systems in managing their drinking water for aesthetic considerations, such as taste, color, and odor. These contaminants are not considered to present a risk to human health at the SMCL.

Because they can be smelled, tasted, or seen, nuisance constituents may be more likely to be noticed by consumers than contaminants that actually are a health risk. However, some constituents that have an SMCL also have a higher human-health benchmark. Manganese is one example—the black staining caused by manganese might be just a nuisance or might signal a concentration high enough to be a health risk.

Dissolved Solids

In other situations, the presence of nuisance constituents can signal geochemical conditions that promote high concentrations of other, more harmful contaminants. For example, high concentrations of dissolved solids are considered a nuisance because they cause water to taste salty, but high dissolved solids is not in itself a health concern. However, high dissolved solids can be an indication that there are elevated concentrations of arsenic, uranium, or other trace elements in the groundwater as well. The occurrence of nuisance constituents in drinking water therefore can indicate that testing for a broader range of constituents could be warranted to assess possible risks and to determine options for reducing those risks.

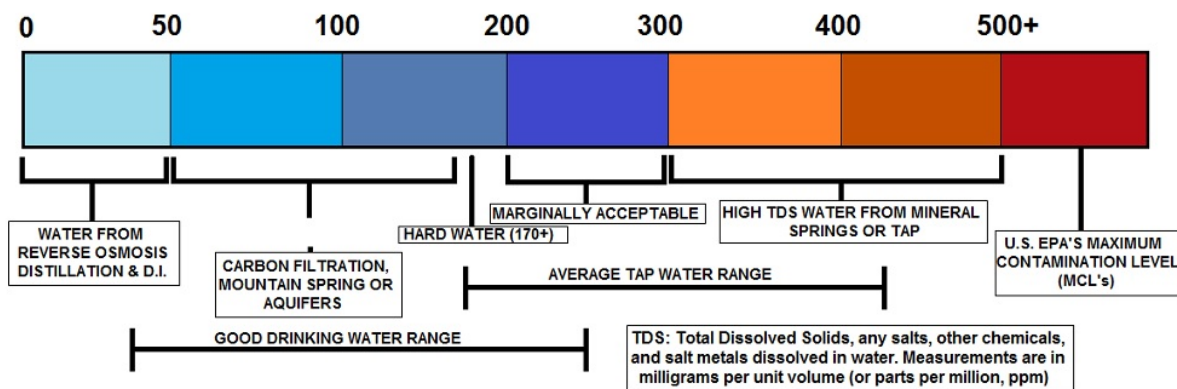

TDS (Total Dissolved Solids) Explained

Safe Drinking Water Act (SDWA) Introduction

On August 6, 1996, President Clinton signed the Reauthorization of the Safe Drinking Water Act, bringing a successful conclusion to years of work on the part of water professionals and a broad range of public interest groups throughout the nation.

This law strikes a balance among federal, state, local, urban, rural, large and small water systems in a manner that improves the protection of public health and brings reason and good science to the regulatory process.

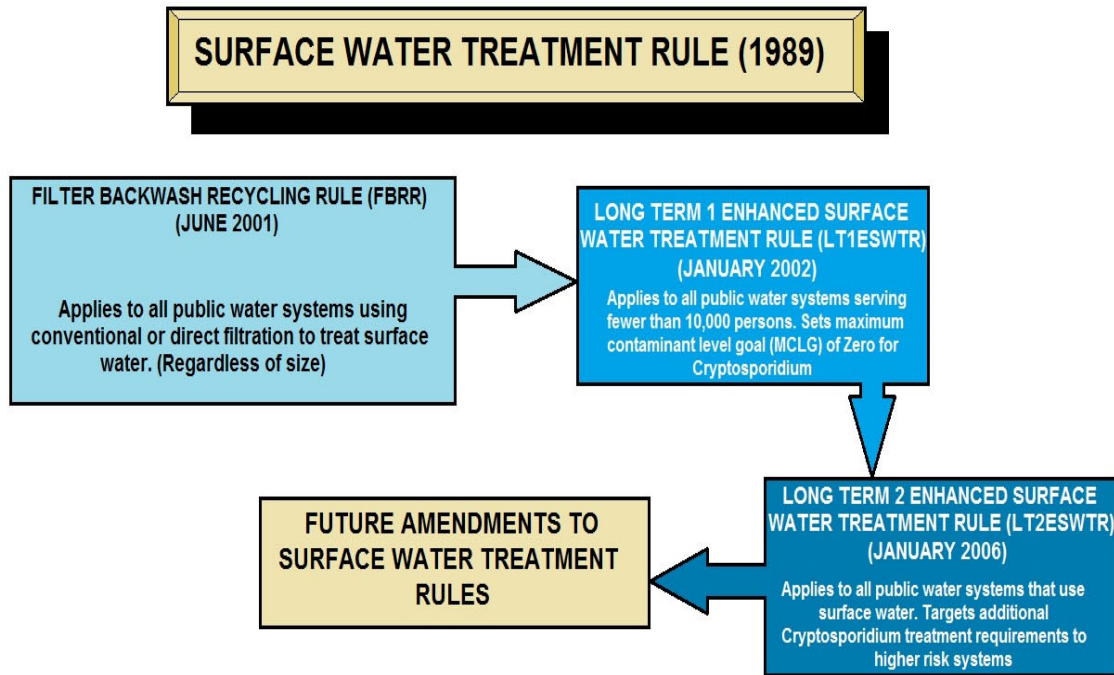

SURFACE WATER TREATMENT RULES

The major elements of this law include:

- The law updates the standard-setting process by focusing regulations on contaminants known to pose greater public health risks.
- It replaces the current law's demand for 25 new standards every three years with a new process based on occurrence, relative risk and cost-benefit considerations.
- It also requires the EPA to select at least five new candidate contaminants to consider for regulation every five years.
- The EPA is directed to require public water systems to provide customers with annual "**Consumer Confidence Reports**" in newspapers and by direct mail.
- The reports must list levels of regulated contaminants along with Maximum Contaminant Levels (**MCLs**) and Maximum Contaminant Level Goals (**MCLGs**), along with plainly worded definitions of both.
- The reports must also include a plainly worded statement of the health concerns for any contaminants for which there has been a violation, describe the utility's sources of

drinking water and provide data on unregulated contaminants for which monitoring is required, including *Cryptosporidium* and radon.

- The EPA must establish a toll-free hot line customers can call to get additional information.
- The EPA is required to publish guidelines for states to develop water source assessment programs that delineate protection areas and assess contamination risks.
- The EPA is required to identify technologies that are affordable for small systems to comply with drinking water regulations.
- Technical assistance funds and Small System Technical Assistance Centers are authorized to meet the training and technical needs of small systems.
- States are authorized to grant variances for compliance with drinking water regulations for systems serving 3,300 or fewer persons.
- The EPA is required to publish certification guidelines for operators of community and nontransient noncommunity public water systems.
- States that do not have operator certification programs that meet the requirements of the guidelines will lose 20 percent of their SRLF grant.
- A source water petition program for voluntary, incentive-based partnerships among public water systems and others to reduce contamination in source water is authorized.
- The law establishes a new State Revolving Loan Fund (**SRLF**) of \$1 billion per year to provide loans to public water systems to comply with the new SDWA.
- It also requires states to allocate 15 percent of the SRLF to systems serving 10,000 or fewer people unless no eligible projects are available for loans.
- It also allows states to jointly administer SDWA and Clean Water Act loan programs and transfer up to 33 percent between the two accounts.
- States must ensure that all new systems have compliance capacity and that all current systems maintain capacity, or lose 20 percent of their SRLF grant.

Although the EPA will continue to provide policy, regulations and guidance, state governments will now have more regulatory flexibility allowing for improved communication between water providers and their local regulators. Increased collaboration will result in solutions that work better and are more fully supported by the regulated community. States that have a source water assessment program may adopt alternative monitoring requirements to provide permanent monitoring relief for public water systems in accordance with EPA guidance.

Risk Assessment

P.L. 104-182 adds risk assessment and communication provisions to SDWA. When developing regulations, the EPA is now required to: (1) use the best available, peer-reviewed science and supporting studies and data; and (2) make publicly available a risk assessment document that discusses estimated risks, uncertainties, and studies used in the assessment. When proposing drinking water regulations, the EPA must publish a health risk reduction and cost analysis. The law permits the EPA to promulgate an interim standard without first preparing a benefit-cost analysis or making a determination as to whether the benefits of a regulation would justify the costs if the EPA determines that a contaminant presents an urgent threat to public health.

New regulations generally become effective 3 years after promulgation. Up to 2 additional years may be allowed if the EPA (or a state in the case of an individual system) determines the time is needed for capital improvements. Section 1412 includes specific provisions for arsenic, sulfate, and radon. The law authorizes states to grant Systems variances from a regulation if raw water quality prevents meeting the standards despite application of the best technology (Section 1415). A new provision authorizes small system variances based on best affordable technology.

States may grant these variances to systems serving 3,300 or fewer persons if the system cannot afford to comply (through treatment, an alternative water source, or restructuring) and the variance ensures adequate protection of public health; states may grant variances to systems serving between 3,300 and 10,000 persons with EPA approval. To receive a small system variance, the system must install a variance technology identified by the EPA. The variance technology need not meet the MCL, but must protect public health. The EPA must identify variance technologies for existing regulations. Variances are not available for microbial contaminants. The Act also provides for exemptions if a regulation cannot be met for other compelling reasons (including costs) and if the system was in operation before the effective date of a standard or treatment requirement (Section 1416). An exemption is intended to give a public water system more time to comply with a regulation and can be issued only if it will not result in an unreasonable health risk. Small systems may receive exemptions for up to 9 years.

State Primacy

The primary enforcement responsibility for public water systems lies with the states, provided they adopt regulations as stringent as the national requirements, adopt authority for administrative penalties, develop adequate procedures for enforcement, maintain records, and create a plan for providing emergency water supplies (Section 1413). Currently, 55 of 57 states and territories have primacy authority. P.L. 104-182 authorizes \$100 million annually for EPA to make grants to states to carry out the public water system supervision program. States may also use a portion of their SRF grant for this purpose (Section 1443).

Whenever the EPA finds that a public water system in a state with primary enforcement authority does not comply with regulations, the Agency must notify the state and the system and provide assistance to bring the system into compliance. If the state fails to commence enforcement action within 30 days after the notification, the EPA is authorized to issue an administrative order or commence a civil action.

Nonprimacy State

In a non-primacy state, the EPA must notify an elected local official (if any has jurisdiction over the water system) before commencing an enforcement action against the system (Section 1414). Primacy states may establish alternative monitoring requirements to provide interim monitoring relief for systems serving 10,000 or fewer persons for most contaminants, if a contaminant is not detected in the first quarterly sample. States with approved source water protection programs may adopt alternative monitoring requirements to provide permanent monitoring relief to qualified systems for chemical contaminants (Section 1418).

P.L. 104-182 requires states to adopt programs for training and certifying operators of community and nontransient noncommunity systems. The EPA must publish guidelines specifying minimum standards for operator certification by February 1999. Two years thereafter, the EPA must withhold 20% of a state's SRF grant unless the state has an operator certification program (Section 1419). States are also required to establish capacity development programs based on EPA guidance.

State programs must include: 1) legal authority to ensure that new systems have the technical, financial, and managerial capacity to meet SDWA requirements; and 2) a strategy to assist existing systems that are experiencing difficulties to come into compliance. Beginning in 2001, the EPA is required to withhold a portion of SRF grants from states that do not have compliance development strategies (Section 1420).

Underground Injection Control

Another provision of the Act requires the EPA to promulgate regulations for state underground injection control (**UIC**) programs to protect underground sources of drinking water. These regulations contain minimum requirements for the underground injection of wastes in five well classes to protect underground sources of drinking water and to require that a state prohibit, by December 1977, any underground injection that was not authorized by state permit (Section 1421).

Groundwater Protection Grant Programs

The Act contains three additional groundwater protection programs. Added in 1986, Section 1427 established procedures for demonstration programs to develop, implement, and assess critical aquifer protection areas already designated by the Administrator as sole source aquifers. Section 1428, also added in 1986, and established an elective state program for protecting wellhead areas around public water system wells.

If a state established a wellhead protection program by 1989, and the EPA approved the state's program, then the EPA may award grants covering between 50% and 90% of the costs of implementing the program. Section 1429, added by P.L. 104-182, authorizes the EPA to make 50% grants to states to develop programs to ensure coordinated and comprehensive protection of groundwater within the states. Appropriations for these three programs and for LYIC state program grants are authorized starting back in FY2003.

Source Water Protection Programs

P.L. 104-182 broadens the pollution prevention focus of the Act to embrace surface water as well as groundwater protection. New Section 1453 directs the EPA to publish guidance for states to implement source water assessment programs that delineate boundaries of assessment areas from which systems receive their water, and identify the origins of contaminants in delineated areas to determine systems' susceptibility to contamination. States with approved assessment programs may adopt alternative monitoring requirements to provide systems with monitoring relief under Section 1418.

New Section 1454 authorizes a source water petition program based on voluntary partnerships between state and local governments. States may establish a program under which a community water system or local government may submit a source water quality partnership petition to the state requesting assistance in developing a voluntary partnership to: (1) reduce the presence of contaminants in drinking water; (2) receive financial or technical assistance; and (3) develop a long-term source water protection strategy. This section authorizes \$5 million each year for grants to states to support petition programs. Also, states may use up to 10% of their annual SRF capitalization grant for the source water assessment activities or for the petition program.

State Revolving Funds

Section 1452, added by P.L. 104-182 authorizes a State Revolving Loan Fund (**SRF**) program to help systems finance improvements needed to comply with drinking water regulations. The law authorizes the EPA to make grants to states to capitalize SDWA SRFs, which states then use to make loans to public water systems. States must match 20% of the federal grant.

Grants will be allotted to states using the formula for distributing state PWSS grants through FY1997; then, grants will be allotted based on a needs survey. Each state will receive at least 1% of funds.

Drinking water SRFs may be used to provide loan and grant assistance for expenditures that the EPA has determined will facilitate compliance or significantly further the Act's health protection objectives. States must make available 15% of their annual allotment for loan assistance to systems that serve 10,000 or fewer persons. States may use up to 30% of their SRF grant to provide grants or forgive loan principle to help economically disadvantaged communities. Also, states may use a portion of funds for technical assistance, source water protection and capacity development programs, and for operator certification.



Other Provisions

Public water systems must notify customers of violations with potential for serious health effects within 24 hours. Systems must also issue to customers' annual reports on contaminants detected in their drinking water (Section 1414). Section 1417 requires any pipe, solder, or flux used in the installation or repair of public water systems or of plumbing in residential or nonresidential facilities providing drinking water to be "**lead free**" (as defined in the Act).

As of August 1998, it will be unlawful to sell pipes, plumbing fittings or fixtures that are not "**lead free**" or to sell solder or flux that is not lead free (unless it is properly labeled); with the exception of pipes used in manufacturing or industrial processing. P.L. 104-182 sets limits on the amount of lead that may leach from new plumbing fixtures, and allows one year for a voluntary standard to be established before requiring EPA to take regulatory action.

The Administrator has emergency powers to issue orders and commence civil action if a contaminant likely to enter a public drinking water supply system poses a substantial threat to public health and state or local officials have not taken adequate action (Section 1431).

If a chemical necessary for water treatment is not reasonably available, the Administrator can issue a "**certification of need**," in which case the President can order an allocation of the chemical to those needing it (Section 1441).

EPA is provided authority to conduct research, studies, and demonstrations related to the causes, treatment, control, and prevention of diseases resulting from contaminants in water. The Agency is directed to provide technical assistance to the states and municipalities in administering their public water system regulatory responsibilities. The law authorizes annually, \$15 million for technical assistance to small systems and Indian Tribes, and \$25 million for health effects research (Section 1442). P.L. 104-182 authorizes additional appropriations for drinking water research, not to exceed \$26.6 million annually.

The Administrator may make grants to develop and demonstrate new technologies for providing safe drinking water and to investigate health implications involved in the reclamation/reuse of waste waters (Section 1444).

Also, suppliers of water who may be subject to regulation under the Act are required to establish and maintain records, monitor, and provide any information that the Administrator requires to carry out the requirements of the Act (Section 1445).

The Administrator may also enter and inspect the property of water suppliers to enable him/her to carry out the purposes of the Act. Failure to comply with these provisions may result in criminal penalties.

The Act established a National Drinking Water Advisory Council, composed of 15 members (with at least 2 representing rural systems), to advise, consult, and make recommendations to the Administrator on activities and policies derived from the Act (Section 1446).

National Security

Any federal agency having jurisdiction over federally owned and maintained public water systems must comply with all federal, state, and local drinking water requirements, as well as any underground injection control programs (Section 1447). The Act provides for waivers in the interest of national security. Procedures for judicial review are outlined (Section 1448), and provision for citizens' civil actions is made (Section 1449).

Three Types of Public Water Systems

Community Water Systems (CWSs)

- Provides water to the same population year-round for example: homes, apartment buildings.
- Approximately 52,000 systems serving the majority of the U.S. population.

Non-Transient Non-Community Water Systems (NTNCWSs)

- Provides water to the same people at least six months a year, but not all year for example: schools, factories, churches, office buildings that have their own water system.
- Approximately 85,000 systems

Transient Non-Community Water System (TNCWS)

- Provides water where people do not remain for long periods of time for example: gas stations, campgrounds.
- Approximately 18,000 systems

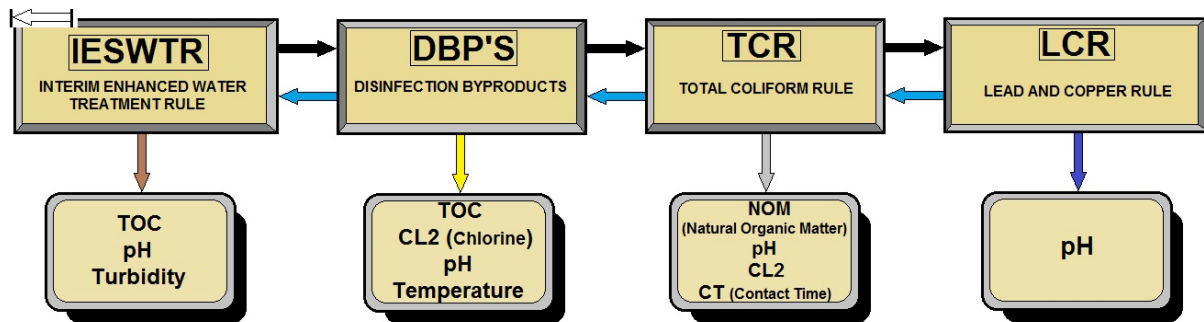

PARAMETERS THAT AFFECT SURFACE WATER TREATMENT RULES



SDWA MCLs Introduction

Radionuclides

Alpha Emitters Certain minerals are radioactive and may emit a form of radiation known as alpha radiation. Some people who drink water containing alpha emitters in excess of EPA standards over many years may have an increased risk of getting cancer.

Beta/photon Emitters Certain minerals are radioactive and may emit forms of radiation known as photons and beta radiation. Some people who drink water containing beta and photon emitters in excess of EPA standards over many years may have an increased risk of getting cancer.

Combined Radium 226/228 Some people who drink water containing radium 226 or 228 in excess of EPA standards over many years may have an increased risk of getting cancer.

Radon gas can dissolve and accumulate in undergroundwater sources, such as wells, and concentrate in the air in your home. Breathing radon can cause lung cancer. Drinking water containing radon presents a risk of developing cancer. Radon in air is more dangerous than radon in water. Radon in water is typically released into the air while showering.



Water Sampling Bottles

These are commonly found examples of various water sampling bottles. VOC and THM bottles are in the front.

You will have to make sure there is absolutely no air inside these tiny bottles. Any air bubble can ruin the sample. There are several ways to get the air out. The best one is slowly overfill the bottle to get a reverse meniscus. Second, is to fill the cap with water before screwing it onto the bottle. The third one is to use a thin copper tube and slowly fill the bottle.

Inorganic Contaminants

Antimony	Cadmium	Cyanide	Nitrite
Asbestos	Chromium	Mercury	Selenium
Barium	Copper	Nitrate	Thallium
Beryllium			

Inorganic Contaminants

Arsenic. Some people who drink water containing arsenic in excess of EPA standards over many years could experience skin damage or problems with their circulatory system, and may have an increased risk of getting cancer.

Fluoride. Many communities add fluoride to their drinking water to promote dental health. Each community makes its own decision about whether or not to add fluoride. The EPA has set an enforceable drinking water standard for fluoride of 4 mg/L. Some people who drink water-containing fluoride in excess of this MCL level over many years could get bone disease, including pain and tenderness of the bones. The EPA has also set a secondary fluoride standard of 2 mg/L to protect against dental fluorosis.

Dental fluorosis, in its moderate or severe forms, may result in a brown staining and/or pitting of the permanent teeth. This problem occurs only in developing teeth, before they erupt from the gums. Children under nine should not drink water that has more than 2 mg/L of fluoride.

Lead. Typically leaches into water from plumbing in older buildings. Lead pipes and plumbing fittings have been banned since August 1998. Children and pregnant women are most susceptible to lead health risks. For advice on avoiding lead, see the EPA's "*Lead in Your Drinking Water*" fact sheet.

Synthetic Organic Contaminants, including Pesticides & Herbicides

2,4-D	Dibromochloropropane	Hexachlorobenzene
2,4,5-TP (Silvex)	Dinoseb	Hexachlorocyclopentadiene
Acrylamide	Dioxin (2,3,7,8-TCDD)	Lindane
Alachlor	Diquat	Methoxychlor
Atrazine	Endothall	Oxamyl [Vydate]
Benzoapyrene	Endrin	PCBs [Polychlorinated biphenyls]
Carbofuran	Epichlorohydrin	Pentachlorophenol
Chlordane	Ethylene dibromide	Picloram
Dalapon	Glyphosate	Simazine
Di 2-ethylhexyl adipate	Heptachlor	Toxaphene
Di 2-ethylhexyl phthalate	Heptachlor epoxide	

Volatile Organic Contaminants

Benzene	trans-1,2-Dichloroethylene	1,2,4-Trichlorobenzene
Carbon Tetrachloride	Dichloromethane	1,1,1,-Trichloroethane
Chlorobenzene	1,2-Dichloroethane	1,1,2-Trichloroethane
o-Dichlorobenzene	1,2-Dichloropropane	Trichloroethylene
p-Dichlorobenzene	Ethylbenzene	Toluene
1,1-Dichloroethylene	Styrene	Vinyl Chloride
cis-1,2-Dichloroethylene	Tetrachloroethylene	Xylenes

Commonly Found Distribution System Water Quality Problems

Turbidity

Turbidity is caused by particles suspended in water. These particles scatter or reflect light rays, making the water appear cloudy. Turbidity is expressed in nephelometric turbidity units (ntu) and a reading in excess of 5 ntu is generally noticeable to water system customers.

Besides the appearance being unpleasant to customers, turbidity in water is significant from a public health standpoint because suspended particles could shelter microorganisms from the disinfectant and allow them to still be viable when they reach the customer.

EPA regulations direct that, for most water systems, the turbidity of water entering the distribution system must be equal or less than 0.5 ntu in at least 95 percent of the measurements taken each month. At no time may the turbidity exceed 5 ntu.



Turbidity changes in the distribution system can indicate developing problems. Increases in turbidity may be caused by changes in velocity or inadequate flushing following main replacement or repairs.

Hardness

Hardness is a measure of the concentration of calcium and magnesium in water. Water hardness usually comes from water contacting rock formations, such as water from wells in limestone formations. Soft groundwater may occur where topsoil is thin and limestone formations are sparse or absent. Most surface water is of medium hardness.

Hard and soft water are both satisfactory for human consumption, but customers may object to very hard water because of the scale it forms in plumbing fixtures and on cooking utensils. Hardness is also a problem for some industrial and commercial users because of scale buildup in boilers and other equipment.

Water generally is considered most satisfactory for household use when the hardness is between 75 and 100 mg/L as calcium carbonate (CaCO_3). Water with 300 mg/L of hardness usually is considered **hard**. Very soft water of 30 mg/L or less is found in some section of the United States. Soft water usually is quite corrosive, and may have to be treated to reduce the corrosivity.

Iron

Iron occurs naturally in rocks and soils and is one of the most abundant elements. It occurs in two forms. Ferrous iron (Fe^{+2}) is in a dissolved state, and water containing ferrous iron is colorless. Ferric iron (Fe^{+3}) has been oxidized, and water containing it is rust-colored.

Water from some well sources contains significant levels of dissolved iron, which is colorless, but rapidly turns brown as air reaches the water and oxidizes the iron.

There are no known harmful effects to humans from drinking water containing iron, but NSDWR suggest a limit of 0.5 mg/L. At high levels, the staining of plumbing fixtures and clothing becomes objectionable. Iron also provides nutrient source for some bacteria that grow in distribution systems and wells. Iron bacteria, such as Gallionella, cause red water, tastes and odors, clogged pipes, and pump failure.

Whenever tests on water samples show increased iron concentrations between the point where water enters the distribution system and the consumer's tap, either corrosion, iron bacteria, or both are probably taking place. If the problem is caused by bacteria, flushing mains, shock chlorination, and carrying increased residual chlorine are alternatives to consider.

Manganese

Manganese in groundwater creates problems similar to iron. It does not usually discolor the water, but will stain washed clothes and plumbing fixtures black; this is very unpopular with customers. Consumption of manganese has no known harmful effects on humans, but the NSDWR recommend a concentration not to exceed 0.05 mg/L to avoid customer complaints.

Water Quality Safeguards

The **critical** safeguard for water distribution system operations are

- continuous positive pressure in the mains; 20 pounds per square inch (psi) minimum residual pressure is recommended;
- maintenance of chlorine residual;
- cross-connection control; and
- frequent testing.

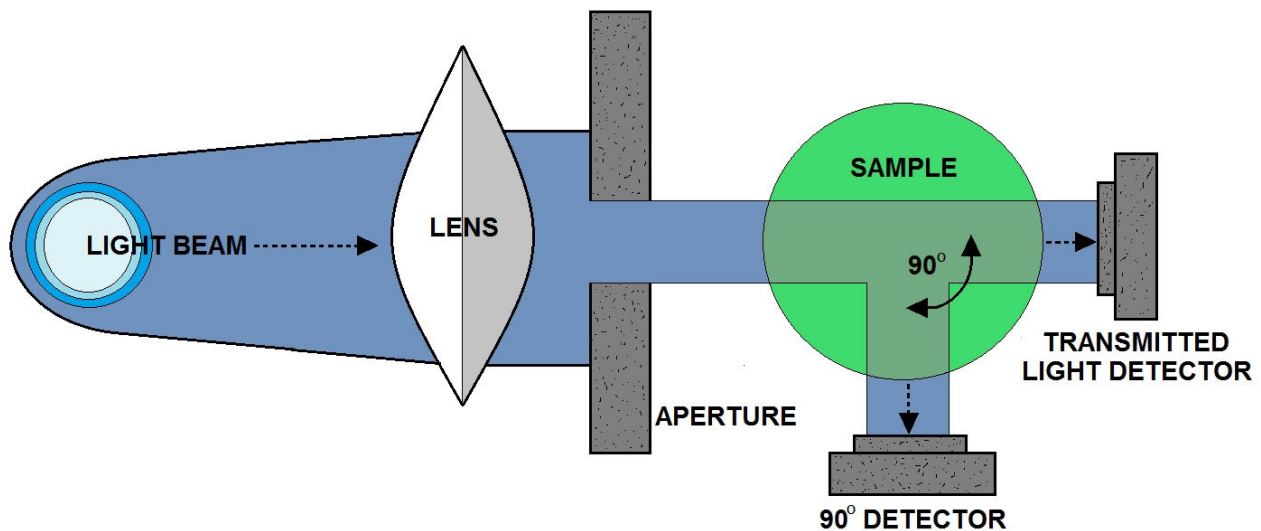

BASICS OF A TURBIDIMETER

Sampling Plan Introduction

A written sampling plan must be developed by the water system. These plans will be reviewed by the Health Department or State Drinking Water agency during routine field visits for sanitary surveys or technical assistance visits. This plan should include:

1. The location of routine sampling sites on a system distribution map. You will need to locate more routine sampling sites than the number of samples required per month or quarter. A minimum of three sites is advised and the sites should be rotated on a regular basis.
2. Map the location of repeat sampling sites for the routine sampling sites. Remember that repeat samples must be collected within five (5) connections upstream and downstream from the routine sample sites.
3. Establish a sampling frequency of the routine sites.
4. Sampling technique, establish a minimum flushing time and requirements for free chlorine residuals at the sites (if you chlorinate continuously).

The sampling sites should be representative of the distribution network and pressure zones. If someone else, e.g., the lab, collects samples for you, you should provide them with a copy of your sampling plan and make sure they have access to all sample sites.

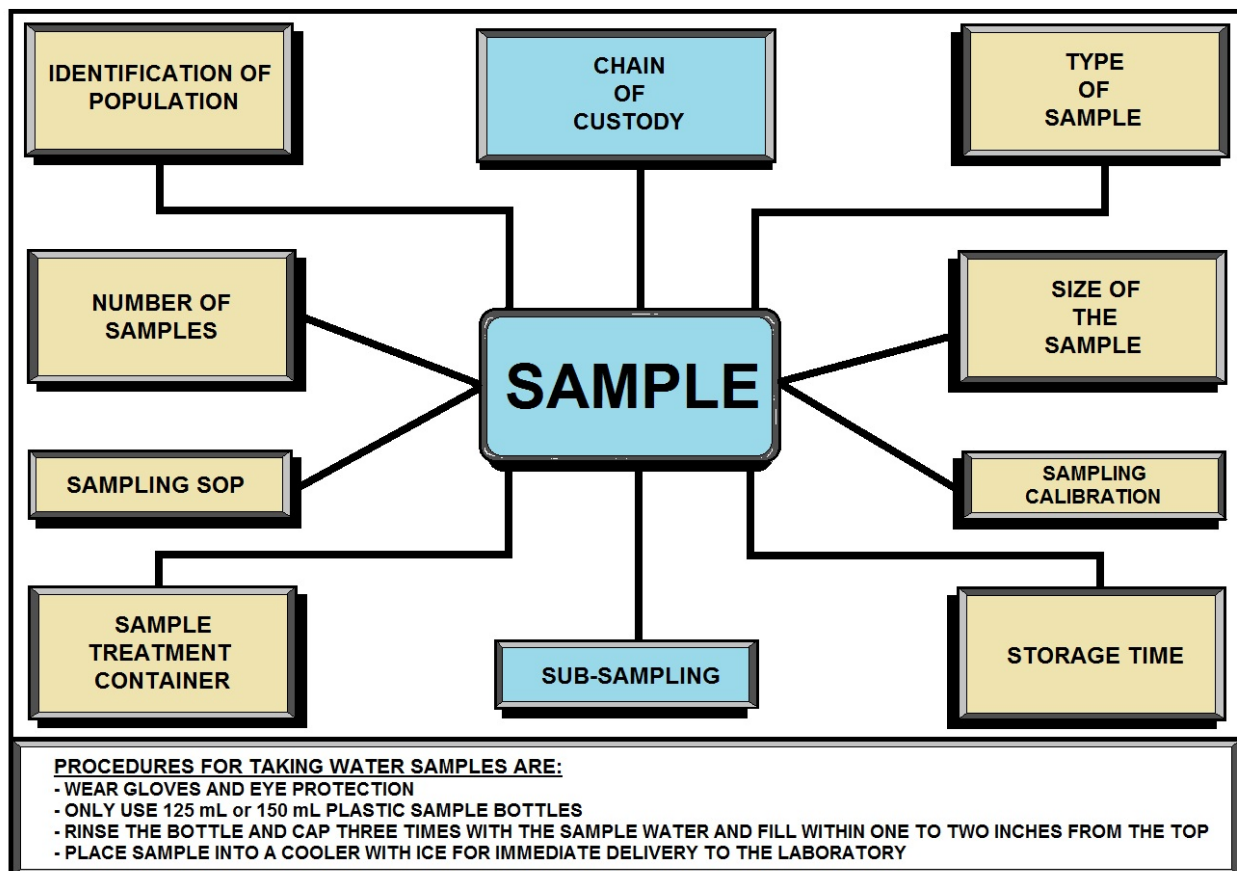

PROPER SAMPLING PROCEDURES (WATER)



**WATER TESTING LAB
456 SOMEWHERE ST.
ANYWHERE, AZ 85002**

TEST REPORT:

**WATER COMPANY
123 ANYWHERE ST.
SOMEWHERE, AZ 85001**

**DRINKING WATER
ANALYSIS RESULTS
FOR MODEL : RO103TDS**

NOTE:

ND - THIS CONTAMINANT WAS NOT DETECTED AT OR ABOVE OUR STATED DETECTION LEVEL

NBS - NO BACTERIA SUBMITTED NBR - NO BACTERIA REQUIRED

* THE MCL (Maximum Contaminant Level) OR AN ESTABLISHED GUIDELINE HAS BEEN EXCEEDED FOR THIS CONTAMINANT

** BACTERIA RESULTS MAY BE INVALID DUE TO LACK OF COLLECTION INFORMATION OR BECAUSE SAMPLE HAS EXCEEDED THE 30-HOUR HOLDING TIMES

ANALYSIS PERFORMED: P-PRESENCE A - ABSENCE EP - E.COLI PRESENCE EA - E.COLI ABSENCE NA: NOT ANALYZED

ANALYSIS	MCL (mg/l)	Det. Level	Level Detected
TOTAL COLIFORM	P	P	A
INORGANIC CHEMICALS - Metals			
Aluminum	0.2	0.1	ND
Arsenic	0.05	0.020	ND
Barium	2	0.30	ND
Cadmium	0.005	0.002	ND
Chromium	0.1	0.010	ND
Copper	1.3	0.004	ND
Iron	0.3	0.020	ND
Lead	0.015	0.002	ND
Manganese	0.05	0.004	ND
Mercury	0.002	0.001	ND
Nickel	0.1	0.02	ND
Selenium	0.05	0.020	ND
Silver	0.1	0.02	ND
Sodium	-----	1.0	ND
Zinc	5	0.004	ND
INORGANIC CHEMICALS - Other, and Physical Factors			
Alkalinity (Total as CaCO)	-----	0.1	ND
Chloride	250	5.0	ND
Fluoride	4	0.5	ND
Nitrate as N	10	0.5	ND
Nitrite as N	1	0.5	ND
Sulfate	250	5.0	ND
Hardness (suggested limit - 100)		10	ND
pH (Standard Units)	6.5 - 8.5	-----	7.7
Total Dissolved Solids	500	20	ND
Turbidity (Turbidity Units)	1.0	0.1	ND
ORGANIC CHEMICALS - Trihalomethanes:			
T THMS	0.080	0.004	ND

WATER ANALYSIS REPORT EXAMPLE

Older Stage 1 DBPR Information

Disinfection Byproduct Regulations

In December 1998, the EPA established the Stage 1 Disinfectants/Disinfection Byproducts Rule that requires public water systems to use treatment measures to reduce the formation of disinfection byproducts and to meet the following specific standards:

Total Trihalomethanes (TTHM) = 80 parts per billion (ppb)

Haloacetic Acids (HAA5) = 60 ppb

Bromate = 10 ppb

Chlorite = 1.0 parts per million (ppm)

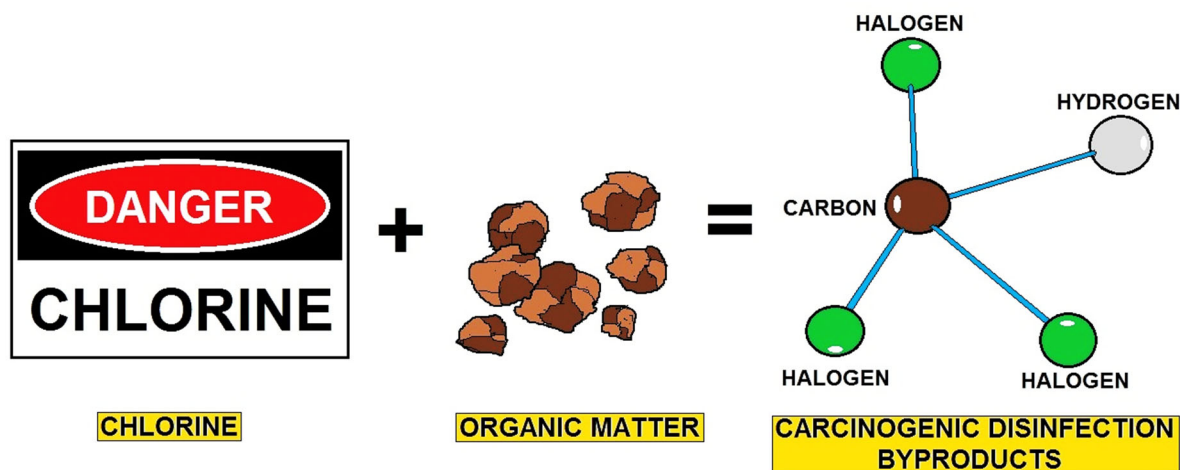

DISINFECTION BYPRODUCT PRODUCTION DIAGRAM

Disinfection byproducts are formed when disinfectants used in water treatment plants react with bromide and/or natural organic matter (i.e., decaying vegetation) present in the source water. Different disinfectants produce different types or amounts of disinfection byproducts.

Disinfection byproducts for which regulations have been established have been identified in drinking water, including trihalomethanes, haloacetic acids, bromate, and chlorite.

Trihalomethanes were regulated at a maximum allowable annual average level of 100 parts per billion for water systems serving over 10,000 people under the Total Trihalomethane Rule finalized by the EPA in 1979.

The Stage 1 Disinfectant/Disinfection Byproduct Rule standards became effective for trihalomethanes and other disinfection byproducts listed above in December 2001 for large surface water public water systems. Those standards became effective in December 2003 for small surface water and all groundwater public water systems.

Trihalomethanes (THM) are a group of four chemicals that are formed along with other disinfection byproducts when chlorine or other disinfectants used to control microbial contaminants in drinking water react with naturally occurring organic and inorganic matter in water. The trihalomethanes are chloroform, bromodichloromethane, dibromochloromethane, and bromoform. The EPA has

published the Stage 1 Disinfectants/Disinfection Byproducts Rule to regulate total trihalomethanes (TTHM) at a maximum allowable annual average level of 80 parts per billion. This new standard replaced the old standard of a maximum allowable annual average level of 100 parts per billion back in December 2001 for large surface water public water systems. The standard became effective for the first time back in December 2003 for small surface water and all groundwater systems.

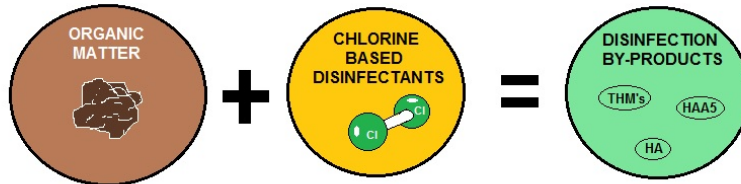

DISINFECTION TREATMENT	DISINFECTION BYPRODUCTS	HEALTH EFFECTS
CHLORINATION	TRIHALOMETHANES (THM's) HALOACETIC ACIDS (HAA's) CHLORATE	INCREASED RISK OF CANCER; PROBLEMS IN THE KIDNEY, LIVER AND THE CENTRAL NERVOUS SYSTEM. REDUCED ABILITY FOR RED BLOOD CELLS TO CARRY OXYGEN.
CHLORINE DIOXIDE	CHLORATE CHLORITE	REDUCED ABILITY FOR RED BLOOD CELLS TO CARRY OXYGEN. ANEMIA AND NERVOUS SYSTEM EFFECTS (for infants and young children)
CHLORAMINE	CHLORATE	REDUCED ABILITY FOR RED BLOOD CELLS TO CARRY OXYGEN
OZONATION	BROMATE	INCREASED RISK OF CANCER



DISINFECTION BYPRODUCT FORMATION AND EFFECTS

Haloacetic Acids (HAA5) are a group of chemicals that are formed along with other disinfection byproducts when chlorine or other disinfectants used to control microbial contaminants in drinking water react with naturally occurring organic and inorganic matter in water.

The regulated haloacetic acids, known as HAA5, are: monochloroacetic acid, dichloroacetic acid, trichloroacetic acid, monobromoacetic acid, and dibromoacetic acid. EPA has published the Stage 1 Disinfectants/Disinfection Byproducts Rule to regulate HAA5 at 60 parts per billion annual average.

This standard became effective for large surface water public water systems back in December 2001 and for small surface water and all groundwater public water systems back in December 2003.

Drinking water standards may apply differently based on type and size of public water systems.

Disinfection Rules Stages 1 & 2 DBPR Introduction

The following are EPA's federal rule requirements. Please be aware that each state implements drinking water regulations that may be more stringent than EPA's regulations. Check with your state environmental agency for more information.

Stage 2 DBPR

EPA finalized the Stage 2 Disinfectants and Disinfection Byproduct Rule (DBPR) to reduce potential health risks from DBPs. The Long Term 2 Enhanced Surface Water Treatment Rule (LT2ESWTR) implemented at the same time as the Stage 2 DBPR to ensure that drinking water is safe from both microbial pathogens and DBPs.

General Requirements

To comply with the Stage 2 Disinfectants and Disinfection Byproducts Rule (Stage 2 DBPR), published on January 4, 2006 (71 FR 388) systems must do the following:

- **Conduct an Initial Distribution System Evaluation (IDSE)** to find locations in the distribution system that have high levels of TTHM and HAA5 and that can be used as compliance monitoring sites for the Stage 2 DBPR.
- **Use a locational running annual average (LRAA) calculation to determine compliance** with the Stage 2 DBPR maximum contaminant levels (MCLs) of:
 - 0.080 mg/L (80 ppb) for total trihalomethanes (TTHM), and
 - 0.060 mg/L (60 ppb) for five haloacetic acids (HAA5).

Note: The MCL values are the same as the Stage 1 MCLs; only the calculation method changes.

- **Monitor for Stage 2 compliance** at the required number of locations for each system's retail population
- **Identify when TTHM or HAA5 levels exceed the operational evaluation level** and, when this happens, look at source water, operational practices, and treatment to find ways to reduce TTHM and HAA5 concentrations in the distribution system. Each of these general requirements are covered in more detail in the rest of this guidance manual. The Stage 2 DBPR is an extension of the Stage 1 Disinfectants and Disinfection Byproducts Rule (Stage 1 DBPR). Systems must also continue to comply with the other requirements of the Stage 1 DBPR in addition to meeting the requirements of the Stage 2 DBPR. This includes compliance with the MCLs for bromate (for systems using ozone) and chlorite (for systems using chlorine dioxide), the MRDLs for chlorine or chloramine (depending on the residual disinfectant used), as well as TOC removal requirements.

Compliance Timeline

Your compliance schedule for the Stage 2 DBPR are based on whether your system is part of a *combined distribution system*:

- If your system **is** part of a combined distribution system, you must comply with the revised MCLs by the same date as required for the largest system in your combined distribution system. Example: if your system serves 8,000 people, but you purchase water from a system that serves 250,000 people, you must comply by the dates shown in Schedule 1.
- If your system **is not** part of a combined distribution system, compliance dates are based on the population served by your system.

If you are using this guidance manual, you likely serve fewer than 10,000 people and you must comply by the dates shown in Schedule 4.

Your State (or EPA) should have sent you a letter telling you what schedule you are on. If you did not receive this letter or you have questions about your schedule, contact your State (contact information is listed in Appendix C).

Note: You are on the same schedule for Stage 2 DBPR compliance as you were on for the IDSE.

The timeline on the next page shows important dates for the Stage 2 DBPR as well as periods for *Cryptosporidium* and *E. coli* required under the LT2ESWTR.

Note: The figure shows the 2-year period after systems must begin compliance as a “possible extension.” States may give you up to an additional 2 years to comply if you need time to install capital improvements.

How Does this Rule Relate to Other Federal, State, and Local Requirements?

As noted earlier, the Stage 2 DBPR is an extension of the Stage 1 Disinfectants and Disinfection Byproducts Rule (Stage 1 DBPR). The Stage 2 DBPR and the Long Term 2 Enhanced Surface Water Treatment Rule (LT2ESWTR) were published together to address the balance between protection from microbial pathogens and the potential health effects from disinfectants and their byproducts. You are still required to continue to meet all existing federal requirements. You may call the Safe Drinking Water Hotline at (800) 426-4791 (e-mail: hotline-sdwa@epa.gov) for more information on other drinking water rules.

Where do DBPs come from?

Chlorine and other chemical disinfectants have been widely used by public water systems (along with filtration) to protect the public from microbial pathogens in drinking water. DBPs are formed when certain disinfectants react with DBP precursors (organic and inorganic materials) in source waters. In most cases, natural organic matter (NOM) is an important factor that affects the levels of DBPs that form. NOM is usually measured as Total Organic Carbon (TOC).

The levels of DBPs in drinking water can vary significantly from one point in a distribution system to another, as many continue to form in the distribution system. DBP levels are generally higher in surface water systems because surface water usually contains higher DBP precursor levels and requires stronger disinfection.

Ensuring Safe Drinking Water

All drinking water systems want to provide water that is safe. One aspect of providing safe drinking water is limiting the levels of DBPs in it. Long-term exposure to DBPs has been linked to bladder cancer, and possibly colon and rectal cancers. More recent studies have shown that shorter-term exposure to high levels of DBPs may be associated with adverse reproductive and developmental health effects.

Limiting the levels of DBPs in your drinking water may require you to make some adjustments to your current operations, such as:

- Making operational improvements at the plant or in the distribution system
- Modifying current treatment operations to remove more DBP precursors or form lower levels of DBPs
- Upgrading or installing a new treatment technology

What Does Compliance Monitoring Involve?

Monitoring requirements for TTHM and HAA5 are based on your source water type and the population your system serves. Note that this is different than the Stage 1 DBPR monitoring requirements that were based on the number of treatment plants in your system.

With population-based monitoring, there are five categories of small systems under the Stage 2 DBPR:

- Subpart H systems that serve fewer than 500 people.
- Subpart H systems that serve 500 to 3,300 people.
- Subpart H systems that serve 3,301 to 9,999 people.
- Groundwater systems that serve fewer than 500 people.
- Groundwater systems that serve 500 to 9,999 people.

If you do not know what type of system you are, you should contact your State to confirm this information.

DISINFECTANTS AND DISINFECTION BYPRODUCTS RULE			
DISINFECTION RESIDUAL	MRDLG (mg/L)	MRDL (mg/L)	COMPLIANCE BASED ON:
CHLORINE	4 (as Cl₂)	4.0 (as Cl₂)	ANNUAL AVERAGE
CHLORAMINE	4 (as Cl₂)	4.0 (as Cl₂)	ANNUAL AVERAGE
CHLORINE DIOXIDE	0.8 (as ClO₂)	0.8 (as ClO₂)	ANNUAL AVERAGE
DISINFECTION BYPRODUCTS	MCLG (mg/L)	MCL (mg/L)	COMPLIANCE BASED ON:
TOTAL TRIHALOMETHANES (TTHM)¹	N/A	0.080	ANNUAL AVERAGE
- CHLOROFORM	***		
- BROMODICHLOROMETHANE	0		
- DIBROMOCHLOROMETHANE	0.06		
- BROMOFORM	0		
HALOACETIC ACIDS (five) (HAA5)²	N/A	0.60	ANNUAL AVERAGE
- DICHLOROACETIC ACID	0		
- TRICHLOROACETIC ACID	0.3		
CHLORITE	0.8	1.0	MONTHLY AVERAGE
BROMATE	0	0.010	ANNUAL AVERAGE

DISINFECTION BYPRODUCTS RULE PARAMETERS EXAMPLE



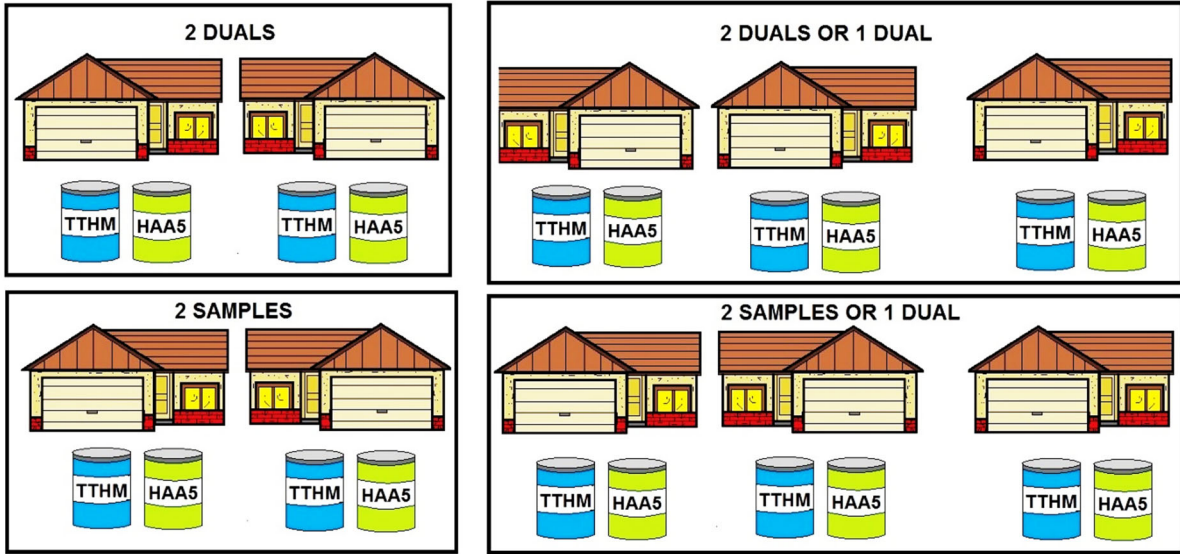

**STAGE 2 DISINFECTION BYPRODUCT RULE
REPEAT (TRIGGERED) SAMPLING DIAGRAM**

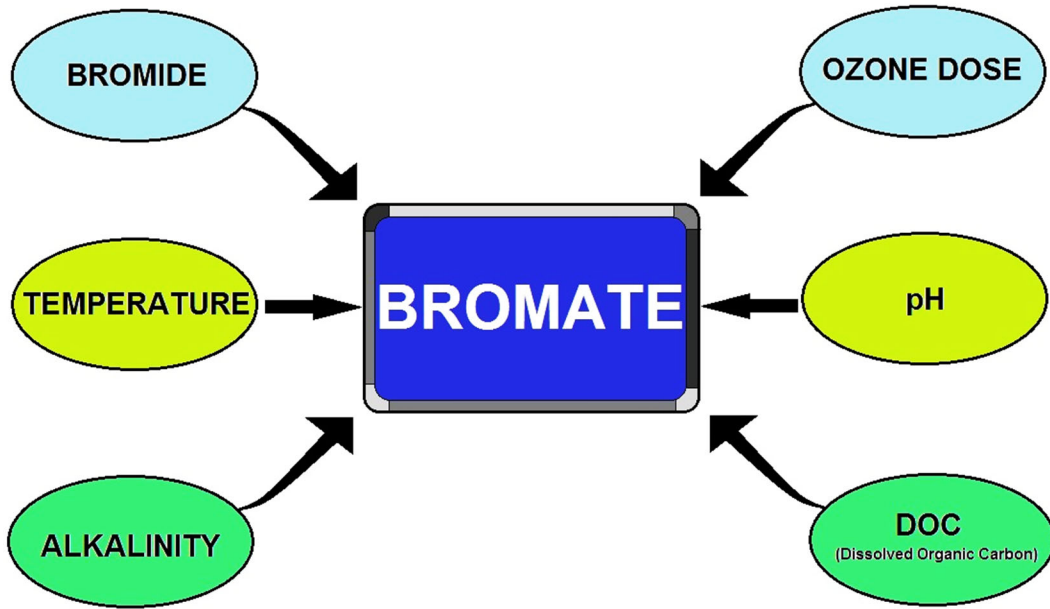

BROMATE FORMATION FACTORS

More on the Stage 2 DBP Rule

The following are EPA's federal rule requirements. Please be aware that each state implements drinking water regulations that may be more stringent than EPA's regulations. Check with your state environmental agency for more information.

The Stage 2 DBP rule is one part of the Microbial and Disinfection Byproducts Rules (MDBPs), which are a set of interrelated regulations that address risks from microbial pathogens and disinfectants/disinfection byproducts.

The Stage 2 DBP rule focuses on public health protection by limiting exposure to DBPs, specifically total trihalomethanes (TTHM) and five haloacetic acids (HAA5), which can form in water through disinfectants used to control microbial pathogens. This rule will apply to all community water systems and nontransient noncommunity water systems that add a primary or residual disinfectant other than ultraviolet (UV) light or deliver water that has been disinfected by a primary or residual disinfectant other than UV.

Amendments to the SDWA in 1996 require EPA to develop rules to balance the risks between microbial pathogens and disinfection byproducts (DBPs). The Stage 1 Disinfectants and Disinfection Byproducts Rule and Interim Enhanced Surface Water Treatment Rule, promulgated in December 1998, were the first phase in a rulemaking strategy required by Congress as part of the 1996 Amendments to the Safe Drinking Water Act.

The Stage 2 Disinfectants and Disinfection Byproducts Rule (Stage 2 DBPR) builds upon the Stage 1 DBPR to address higher risk public water systems for protection measures beyond those required for existing regulations. The Stage 2 DBPR and the Long Term 2 Enhanced Surface Water Treatment Rule are the second phase of rules required by Congress. These rules strengthen protection against microbial contaminants, especially *Cryptosporidium*, and at the same time, reduce potential health risks of DBPs.

What is the Stage 2 DBPR?

The Stage 2 Disinfection Byproducts Rule will reduce potential cancer and reproductive and developmental health risks from disinfection byproducts (DBPs) in drinking water, which form when disinfectants are used to control microbial pathogens. Over 260 million individuals are exposed to DBPs. This final rule strengthens public health protection for customers in the US by tightening compliance monitoring requirements for two groups of DBPs, trihalomethanes (TTHM) and haloacetic acids (HAA5). The rule targets systems with the greatest risk and builds incrementally on existing rules. This regulation will reduce DBP exposure and related potential health risks and provide more equitable public health protection. The Stage 2 DBPR is being promulgated simultaneously with the Long Term 2 Enhanced Surface Water Treatment Rule to address concerns about risk tradeoffs between pathogens and DBPs.

What does the rule require?

Under the Stage 2 DBPR, systems will conduct an evaluation of their distribution systems, known as an Initial Distribution System Evaluation (IDSE), to identify the locations with high disinfection byproduct concentrations. These locations will then be used by the systems as the sampling sites for Stage 2 DBPR compliance monitoring. Compliance with the maximum contaminant levels for two groups of disinfection byproducts (TTHM and HAA5) will be calculated for each monitoring location in the distribution system. This approach, referred to as the locational running annual average (LRAA), differs from previous requirements, which determine compliance by calculating the running annual average of samples from all monitoring locations across the system.

The Stage 2 DBPR also requires each system to determine if they have exceeded an operational evaluation level, which is identified using their compliance monitoring results. The operational evaluation level provides an early warning of possible future MCL violations, which allows the system to take proactive steps to remain in compliance.

A system that exceeds an operational evaluation level is required to review their operational practices and submit a report to their state that identifies actions that may be taken to mitigate future high DBP levels, particularly those that may jeopardize their compliance with the DBP MCLs.

Who must comply with the rule?

Entities potentially regulated by the Stage 2 DBPR are community and nontransient noncommunity water systems that produce and/or deliver water that is treated with a primary or residual disinfectant other than ultraviolet light.

A community water system (CWS) is a public water system that serves year-round residents of a community, subdivision, or mobile home park that has at least 15 service connections or an average of at least 25 residents.

A nontransient noncommunity water system (NTNCWS) is a water system that serves at least 25 of the same people more than six months of the year, but not as primary residence, such as schools, businesses, and day care facilities.

What are disinfection byproducts (DBPs)?

Disinfectants are an essential element of drinking water treatment because of the barrier they provide against waterborne disease-causing microorganisms. Disinfection byproducts (DBPs) form when disinfectants used to treat drinking water react with naturally occurring materials in the water (e.g., decomposing plant material).

Total trihalomethanes (TTHM - chloroform, bromoform, bromodichloromethane, and dibromochloromethane) and haloacetic acids (HAA5 - monochloro-, dichloro-, trichloro-, monobromo-, dibromo-) are widely occurring classes of DBPs formed during disinfection with chlorine and chloramine.

The amount of trihalomethanes and haloacetic acids in drinking water can change from day to day, depending on the season, water temperature, amount of disinfectant added, the amount of plant material in the water, and a variety of other factors.

More on Evolving Disinfection Rules

In the past 40 years, the Safe Drinking Water Act (SDWA) has been highly effective in protecting public health and has also evolved to respond to new and emerging threats to safe drinking water. Disinfection of drinking water is one of the major public health advances in the 20th century. One hundred years ago, typhoid, dysentery and cholera epidemics were common through American cities; disinfection was a major factor in reducing these epidemics.

However, the disinfectants themselves can react with naturally-occurring materials in the water to form unintended byproducts which may pose health risks. In addition, in the past thirty years though, we have learned that there are specific microbial pathogens, such as *Cryptosporidium*, which can cause illness and is resistant to traditional disinfection practices.

Chlorine is the most widely used water disinfectant due to its effectiveness and cost. Most states require community water systems to use chlorination. However, research shows that chlorine has side effects. It reacts with organic matter present in water and forms a series of compounds that have been linked to cancer in animals.

These compounds are called disinfection by-products (DBPs). All disinfectants form DBPs in one of two reactions:

- (1) chlorine and chlorine-based compounds (halogens) react with organics in water causing the chlorine atom to substitute other atoms, resulting in halogenated by-products and
- (2) oxidation reactions, where chlorine oxidizes compounds present in water. Secondary by-products are also formed when multiple disinfectants are used.

All living organisms have carbon as an essential element in their cells. When trees shed their leaves, the leaves start decomposing and are ultimately broken down by bacteria into carbon-containing compounds. Similarly, dead animals on land and fish and other aquatic life decompose and disintegrate into compounds that contain carbon as an essential element. Hence, all surface water and groundwater contain varying amounts of carbon-containing compounds called organic matter (primarily humic and fulvic acids).

The EPA Surface Water Treatment Rule (SWTR) requires systems using public water supplies from either surface water or groundwater under the direct influence of surface water to disinfect. In addition, since some disinfectants produce chemical by-products, the dual objective of disinfection is to provide the required level of organism destruction and remain within the maximum contaminant level (MCL) for the SWTR disinfection set by EPA. An MCL is set for Total Trihalomethanes and additional disinfection byproducts.

What are the microbial/disinfection byproducts (MDBP) rules and which ones apply to me?

The MDBP requirements have been in place for close to 30 years and include the following federal rules:

- Total Trihalomethanes monitoring and MCL, promulgated Nov 1979
- Surface Water Treatment Rule, promulgated June 1989
- Interim Enhanced Surface Water Treatment Rule and Stage 1 Disinfectants / Disinfection Byproducts Rule, promulgated Dec 1998
- Filter Backwash Rule, promulgated June 2001
- Long Term 1 Enhanced Surface Water Treatment Rule, promulgated Jan 2002
- Long Term 2 Enhanced Surface Water Treatment Rule and Stage 2 Disinfectants / Disinfection Byproducts Rule, promulgated Jan 2006
- Groundwater Rule, promulgated Nov 2006

The Disinfectants and Disinfection Byproducts (DBP) rules apply to all community and non-community water systems using a disinfectant such as chlorine, chloramines, ozone and chlorine dioxide.

Compliance with the Stage 1 DBP requirements began in 2000. The Stage 2 DBP requirements began in 2006 with the Initial Distribution System Evaluation (IDSE). Compliance monitoring for the Stage 2 DBP begins in April 2012. See phased compliance schedule dependent on system population below.

The Long Term 2 Enhanced Surface Water Treatment Rule (LT2) rule applies to all water systems using surface water, groundwater under the influence of a surface water, as well as groundwater/surface water blends. The LT2 requirements began in 2006 with the characterization of raw water *Cryptosporidium* and *E.coli* levels. Systems serving <10,000 monitor for *E.coli* only every two weeks for one year. Compliance with the LT2 requirements begin in April 2013.

The Groundwater Rule (GWR) applies to all public water systems using groundwater. The GWR requirements begin in March 2009 with 6-months investigative monitoring (IM) for source water *E.coli*, for systems currently applying disinfection only. All other requirements for the GWR began back in Dec 2009.

Amendments to the SDWA in 1996 require EPA to develop rules to balance the risks between microbial pathogens and disinfection byproducts (DBPs). It is important to strengthen protection against microbial contaminants, especially *Cryptosporidium*, and at the same time, reduce potential health risks of DBPs.

The Stage 1 Disinfectants and Disinfection Byproducts Rule and Interim Enhanced Surface Water Treatment Rule, announced in December 1998, are the first of a set of rules under the 1996 SDWA Amendments. This fact sheet focuses on the Stage 1 Disinfectants and Disinfection Byproducts Rule. A separate fact sheet focuses on the Interim Enhanced Surface Water Treatment Rule (EPA 815-F-98-009).

Public Health Concerns

While disinfectants are effective in controlling many microorganisms, they react with natural organic and inorganic matter in source water and distribution systems to form DBPs. Results from toxicology studies have shown several DBPs (e.g., bromodichloromethane, bromoform, chloroform, dichloroacetic acid, and bromate) to be carcinogenic in laboratory animals.

Other DBPs (e.g., chlorite, bromodichloromethane, and certain haloacetic acids) have also been shown to cause adverse reproductive or developmental effects in laboratory animals.

Several epidemiology studies have suggested a weak association between certain cancers (e.g., bladder) or reproductive and developmental effects, and exposure to chlorinated surface water. More than 200 million people consume water that has been disinfected. Because of the large population exposed, health risks associated with DBPs, even if small, need to be taken seriously.

Disinfection Byproduct Research and Regulations Summary

Drinking water chlorination has contributed to a dramatic decline in waterborne disease rates and increased life expectancy in the United States. Largely because of this success, many Americans take it for granted that their tap water will be free of disease-causing organisms.

In recent years, regulators and the public have focused greater attention on potential health risks from chemical contaminants in drinking water. One such concern relates to disinfection byproducts (DBPs), chemical compounds formed unintentionally when chlorine and other disinfectants react with certain organic matter in water.

In the early 1970s, EPA scientists first determined that drinking water chlorination could form a group of byproducts known as trihalomethanes (THMs), including chloroform. Concerned that these chemicals may be carcinogenic to humans, EPA set the first regulatory limits for THMs in 1979. Since that time, a wealth of research has improved our understanding of how DBPs are formed, their potential health risks, and how they can be controlled. It is now recognized that all chemical disinfectants form some potentially harmful byproducts. The byproducts of chlorine disinfection are by far the most thoroughly studied.

While the available evidence does not prove that DBPs in drinking water cause adverse health effects in humans, high levels of these chemicals are certainly undesirable. Cost-effective methods to reduce DBP formations are available and should be adopted where possible.

The health risks from these byproducts at the levels at which they occur in drinking water are extremely small in comparison with the risks associated with inadequate disinfection. Thus, it is important that disinfection not be compromised in attempting to control such byproducts.

Recent EPA regulations have further limited THMs and other DBPs in drinking water. Most water systems are meeting these new standards by controlling the amount of natural organic matter prior to disinfection, while ensuring that microbial protection remains the top priority.

Based largely on these animal data, EPA considers individual THMs and HAAs to be either possible or probable human carcinogens, although any risk from the low levels found in drinking water would be slight. After reviewing the full body of toxicology studies, the IPCS concluded, "None of the chlorination byproducts studied to date is a potent carcinogen at concentrations normally found in drinking water" (IPCS 2000, p. 376).

Some epidemiology studies have reported an association between human exposure to DBPs and elevated cancer risks, while other studies have found no association. EPA evaluated the existing cancer epidemiology studies and found that only for bladder cancer were associations with chlorinated water somewhat consistent.

Even in these studies, cancer risks were not strongly correlated to measured THM levels, indicating that other factors cannot be ruled out (Craun et al., 2001). EPA has concluded, "The present epidemiologic data do not support a causal relationship between exposure to chlorinated drinking water and development of cancer at this time" (EPA 1998). The IPCS reached a similar conclusion in 2000, noting that a causal relationship between DBPs and increased cancer remains an open question (IPCS 2000).

Balancing DBP and Microbial Risks

Continuing evidence of waterborne disease occurrence suggests that microbial risks should receive a much higher level of attention than disinfection byproducts. For this reason, The American Academy of Microbiology (Ford and Colwell, 1996) has recommended, the health risks posed by microbial pathogens should be placed as the highest priority in water treatment to protect public health. A report published by the International Society of Regulatory Toxicology and Pharmacology (Coulston and Kolbye, 1994) stated “The reduction in mortality due to waterborne infectious diseases, attributed largely to chlorination of potable water supplies, appears to outweigh any theoretical cancer risks (which may be as low as zero) posed by the minute quantities of chlorinated organic chemicals reported in drinking waters disinfected with chlorine.”

The IPCS (IPCS 2000, p. 375) reached similar conclusions:

Disinfection is unquestionably the most important step in the treatment of water for drinking water supplies. The microbial quality of drinking water should not be compromised because of concern over the potential long-term effects of disinfectants and DBPs. The risk of illness and death resulting from exposure to pathogens in drinking water is very much greater than the risks from disinfectants and DBPs.

Controlling Disinfection Byproducts

Treatment techniques are available that provide water suppliers the opportunity to maximize potable water safety and quality while minimizing the risk of DBP risks. Generally, the best approach to reduce DBP formation is to remove natural organic matter precursors prior to disinfection. EPA has published a guidance document for water system operators entitled, Controlling Disinfection byproducts and Microbial Contaminants in Drinking Water (EPA, 2001).

The EPA guidance discusses three processes to effectively remove natural organic matter prior to disinfection:

1. Coagulation and Clarification

Most treatment plants optimize their coagulation process for turbidity (particle) removal. However, coagulation processes can also be optimized for natural organic matter removal with higher doses of inorganic coagulants (such as alum or iron salts), and optimization of pH.

2. Absorption

Activated carbon can be used to absorb soluble organics that react with disinfectants to form byproducts.

3. Membrane Technology

Membranes, used historically to desalinate brackish waters, have also demonstrated excellent removal of natural organic matter. Membrane processes use hydraulic pressure to force water through a semi-permeable membrane that rejects most contaminants. Variations of this technology include reverse osmosis (RO), nanofiltration (low pressure RO), and microfiltration (comparable to conventional sand filtration).

Other conventional methods of reducing DBP formation include changing the point of chlorination and using chloramines for residual disinfection. EPA predicted that most water systems will be able to achieve compliance with new DBP regulations through the use of one or more of these relatively low cost methods (EPA, 1998). Water system managers may also consider switching from chlorine to alternative disinfectants to reduce formation of THMs and HAAs.

National Primary Drinking Water Regulations

Inorganic Chemicals	MCLG ¹ (mg/L) ₄	MCL ² or TT ³ (mg/L) ₄	Potential Health Effects from Ingestion of Water	Sources of Contaminant in Drinking Water
Antimony	0.006	0.006	Increase in blood cholesterol; decrease in blood glucose	Discharge from petroleum refineries; fire retardants; ceramics; electronics; solder
Arsenic	none ⁵	0.010	Skin damage; circulatory system problems; increased risk of cancer	Discharge from semiconductor manufacturing; petroleum refining; wood preservatives; animal feed additives; herbicides; erosion of natural deposits
Asbestos (fiber >10 micrometers)	7 million fibers per Liter	7 MFL	Increased risk of developing benign intestinal polyps	Decay of asbestos cement in water mains; erosion of natural deposits
Barium	2	2	Increase in blood pressure	Discharge of drilling wastes; discharge from metal refineries; erosion of natural deposits
Beryllium	0.004	0.004	Intestinal lesions	Discharge from metal refineries and coal-burning factories; discharge from electrical, aerospace, and defense industries
Cadmium	0.005	0.005	Kidney damage	Corrosion of galvanized pipes; erosion of natural deposits; discharge from metal refineries; runoff from waste batteries and paints
Chromium (total)	0.1	0.1	Some people who use water containing chromium well in excess of the MCL over many years could experience allergic dermatitis	Discharge from steel and pulp mills; erosion of natural deposits
Copper	1.3	Action Level= 1.3; TT ⁶	Short term exposure: Gastrointestinal distress. Long term exposure: Liver or kidney damage. Those with Wilson's Disease should consult their personal doctor if their water systems exceed the copper action level.	Corrosion of household plumbing systems; erosion of natural deposits; leaching from wood preservatives
Cyanide (as free cyanide)	0.2	0.2	Nerve damage or thyroid problems	Discharge from steel/metal factories; discharge from plastic and fertilizer factories
Fluoride	4.0	4.0	Bone disease (pain and tenderness of the bones); Children may get mottled teeth.	Water additive which promotes strong teeth; erosion of natural deposits; discharge from fertilizer and aluminum factories
Lead	zero	Action Level= 0.015; TT ⁶	Infants and children: Delays in physical or mental development. Adults: Kidney problems; high blood pressure	Corrosion of household plumbing systems; erosion of natural deposits
Inorganic Mercury	0.002	0.002	Kidney damage	Erosion of natural deposits; discharge from refineries and factories; runoff from landfills and cropland

Nitrate (measured as Nitrogen)	10	10	"Blue baby syndrome" in infants under six months - life threatening without immediate medical attention. Symptoms: Infant looks blue and has shortness of breath.	Runoff from fertilizer use; leaching from septic tanks, sewage; erosion of natural deposits
Nitrite (measured as Nitrogen)	1	1	"Blue baby syndrome" in infants under six months - life threatening without immediate medical attention. Symptoms: Infant looks blue and has shortness of breath.	Runoff from fertilizer use; leaching from septic tanks, sewage; erosion of natural deposits
Selenium	0.05	0.05	Hair or fingernail loss; numbness in fingers or toes; circulatory problems	Discharge from petroleum refineries; erosion of natural deposits; discharge from mines
Thallium	0.0005	0.002	Hair loss; changes in blood; kidney, intestine, or liver problems	Leaching from ore-processing sites; discharge from electronics, glass, and pharmaceutical companies

PRIMARY DRINKING WATER REGULATIONS

PRIMARY DRINKING WATER REGULATIONS ARE LEGALLY ENFORCEABLE PRIMARY STANDARD AND TREATMENT TECHNIQUES THAT APPLY TO PUBLIC WATER SYSTEMS.

PRIMARY STANDARDS AND TREATMENT TECHNIQUES PROTECT PUBLIC HEALTH BY LIMITING THE LEVEL OF CONTAMINANTS IN DRINKING WATER.

EXAMPLES OF CONTAMINANTS INCLUDE:

- Microorganisms
- Disinfectants
- Disinfection Byproducts (DBPs)
- Inorganic Chemicals
- Organic Chemicals
- Radionuclides

The diagram shows a horizontal blue pipe representing a water supply. Six callout circles point to different contaminants: Radionuclides (top left), Disinfection Byproducts (top middle), Microbes (top right), VOCs (bottom left), Arsenic (bottom middle), and Disinfectants (bottom right, shown as a bottle of chlorine tablets).

PRIMARY DRINKING WATER REGULATIONS / STANDARDS



Organic Chemicals	MCLG₁ (mg/L) 4	MCL₂ or TT₃ (mg/L) 4	Potential Health Effects from Ingestion of Water	Sources of Contaminant in Drinking Water
Acrylamide	zero	TT ²	Nervous system or blood problems; increased risk of cancer	Added to water during sewage/wastewater treatment
Alachlor	zero	0.002	Eye, liver, kidney or spleen problems; anemia; increased risk of cancer	Runoff from herbicide used on row crops
Atrazine	0.003	0.003	Cardiovascular system problems; reproductive difficulties	Runoff from herbicide used on row crops
Benzene	zero	0.005	Anemia; decrease in blood platelets; increased risk of cancer	Discharge from factories; leaching from gas storage tanks and landfills
Benzo(a)pyrene	zero	0.0002	Reproductive difficulties; increased risk of cancer	Leaching from linings of water storage tanks and distribution lines
Carbofuran	0.04	0.04	Problems with blood or nervous system; reproductive difficulties.	Leaching of soil fumigant used on rice and alfalfa
Carbon tetrachloride	zero	.005	Liver problems; increased risk of cancer	Discharge from chemical plants and other industrial activities
Chlordane	zero	0.002	Liver or nervous system problems; increased risk of cancer	Residue of banned termiticide
Chlorobenzene	0.1	0.1	Liver or kidney problems	Discharger from chemical and agricultural chemical factories
2,4-D	0.07	0.07	Kidney, liver, or adrenal gland problems	Runoff from herbicide used on row crops
Dalapon	0.2	0.2	Minor kidney changes	Runoff from herbicide used on rights of way
1,2-Dibromo-3-chloropropane (DBCP)	zero	0.0002	Reproductive difficulties; increased risk of cancer	Runoff/leaching from soil fumigant used on soybeans, cotton, pineapples, and orchards
o-Dichlorobenzene	0.6	0.6	Liver, kidney, or circulatory system problems	Discharge from industrial chemical factories
p-Dichlorobenzene	0.075	0.075	Anemia; liver, kidney or spleen damage; changes in blood	Discharge from industrial chemical factories
1,2-Dichloroethane	zero	0.005	Increased risk of cancer	Discharge from industrial chemical factories
1-1-Dichloroethylene	0.007	0.007	Liver problems	Discharge from industrial chemical factories
cis-1, 2-Dichloroethylene	0.07	0.07	Liver problems	Discharge from industrial chemical factories
trans-1,2-Dichloroethylene	0.1	0.1	Liver problems	Discharge from industrial chemical factories
Dichloromethane	zero	0.005	Liver problems; increased risk of cancer	Discharge from pharmaceutical and chemical factories
1-2-Dichloropropane	zero	0.005	Increased risk of cancer	Discharge from industrial chemical factories
Di(2-ethylhexyl)adipate	0.4	0.4	General toxic effects or reproductive difficulties	Leaching from PVC plumbing systems; discharge from chemical factories
Di(2-ethylhexyl)phthalate	zero	0.006	Reproductive difficulties; liver problems; increased risk of cancer	Discharge from rubber and chemical factories
Dinoseb	0.007	0.007	Reproductive difficulties	Runoff from herbicide used on soybeans and vegetables

Dioxin (2,3,7,8-TCDD)	zero	0.0000003	Reproductive difficulties; increased risk of cancer	Emissions from waste incineration and other combustion; discharge from chemical factories
Diquat	0.02	0.02	Cataracts	Runoff from herbicide use
Endothall	0.1	0.1	Stomach and intestinal problems	Runoff from herbicide use
Endrin	0.002	0.002	Nervous system effects	Residue of banned insecticide
Epichlorohydrin	zero	TT ²	Stomach problems; reproductive difficulties; increased risk of cancer	Discharge from industrial chemical factories; added to water during treatment process
Ethylbenzene	0.7	0.7	Liver or kidney problems	Discharge from petroleum refineries
Ethylene dibromide	zero	0.00005	Stomach problems; reproductive difficulties; increased risk of cancer	Discharge from petroleum refineries
Glyphosate	0.7	0.7	Kidney problems; reproductive difficulties	Runoff from herbicide use
Heptachlor	zero	0.0004	Liver damage; increased risk of cancer	Residue of banned termiticide
Heptachlor epoxide	zero	0.0002	Liver damage; increased risk of cancer	Breakdown of heptachlor
Hexachlorobenzene	zero	0.001	Liver or kidney problems; reproductive difficulties; increased risk of cancer	Discharge from metal refineries and agricultural chemical factories
Hexachlorocyclopentadiene	0.05	0.05	Kidney or stomach problems	Discharge from chemical factories
Lindane	0.0002	0.0002	Liver or kidney problems	Runoff/leaching from insecticide used on cattle, lumber, gardens
Methoxychlor	0.04	0.04	Reproductive difficulties	Runoff/leaching from insecticide used on fruits, vegetables, alfalfa, livestock
Oxamyl (Vydate)	0.2	0.2	Slight nervous system effects	Runoff/leaching from insecticide used on apples, potatoes, and tomatoes
Polychlorinated biphenyls (PCBs)	zero	0.0005	Skin changes; thymus gland problems; immune deficiencies; reproductive or nervous system difficulties; increased risk of cancer	Runoff from landfills; discharge of waste chemicals
Pentachlorophenol	zero	0.001	Liver or kidney problems; increased risk of cancer	Discharge from wood preserving factories
Picloram	0.5	0.5	Liver problems	Herbicide runoff
Simazine	0.004	0.004	Problems with blood	Herbicide runoff
Styrene	0.1	0.1	Liver, kidney, and circulatory problems	Discharge from rubber and plastic factories; leaching from landfills
Tetrachloroethylene	zero	0.005	Liver problems; increased risk of cancer	Discharge from factories and dry cleaners
Toluene	1	1	Nervous system, kidney, or liver problems	Discharge from petroleum factories
Total Trihalomethanes (TTHMs)	none ⁵	0.10	Liver, kidney or central nervous system problems; increased risk of cancer	Byproduct of drinking water disinfection
Toxaphene	zero	0.003	Kidney, liver, or thyroid problems; increased risk of cancer	Runoff/leaching from insecticide used on cotton and cattle
2,4,5-TP (Silvex)	0.05	0.05	Liver problems	Residue of banned herbicide
1,2,4-Trichlorobenzene	0.07	0.07	Changes in adrenal glands	Discharge from textile finishing factories
1,1,1-Trichloroethane	0.20	0.2	Liver, nervous system, or circulatory problems	Discharge from metal degreasing sites and other factories
1,1,2-Trichloroethane	0.003	0.005	Liver, kidney, or immune system problems	Discharge from industrial chemical factories

Trichloroethylene	zero	0.005	Liver problems; increased risk of cancer	Discharge from petroleum refineries
Vinyl chloride	zero	0.002	Increased risk of cancer	Leaching from PVC pipes; discharge from plastic factories
Xylenes (total)	10	10	Nervous system damage	Discharge from petroleum factories; discharge from chemical factories
Radionuclides	MCLG₁ (mg/L) ₄	MCL₂ or TT₃ (mg/L) ₄	Potential Health Effects from Ingestion of Water	Sources of Contaminant in Drinking Water
Beta particles and photon emitters	none ⁵	4 millirems per year	Increased risk of cancer	Decay of natural and man-made deposits
Gross alpha particle activity	none ⁵	15 picocuries per Liter (pCi/L)	Increased risk of cancer	Erosion of natural deposits
Radium 226 and Radium 228 (combined)	none ⁵	5 pCi/L	Increased risk of cancer	Erosion of natural deposits
Microorganisms	MCLG₁ (mg/L) ₄	MCL₂ or TT₃ (mg/L) ₄	Potential Health Effects from Ingestion of Water	Sources of Contaminant in Drinking Water
<i>Giardia lamblia</i>	zero	TT ⁸	Giardiasis, a gastroenteric disease	Human and animal fecal waste
Heterotrophic plate count	N/A	TT ⁸	HPC has no health effects, but can indicate how effective treatment is at controlling microorganisms.	n/a
<i>Legionella</i>	zero	TT ⁸	Legionnaire's Disease, commonly known as pneumonia	Found naturally in water; multiplies in heating systems
Total Coliforms (including fecal coliform and <i>E. Coli</i>)	zero	5.0% ⁹	Used as an indicator that other potentially harmful bacteria may be present ¹⁰	Human and animal fecal waste
Turbidity	N/A	TT ⁸	Turbidity has no health effects but can interfere with disinfection and provide a medium for microbial growth. It may indicate the presence of microbes.	Soil runoff
Viruses (enteric)	zero	TT ⁸	Gastroenteric disease	Human and animal fecal waste



Common water sample bottles for distribution systems.

Radiochems, VOCs, (Volatile Organic Compounds), TTHMs, Total Trihalomethanes), Nitrate, Nitrite.

Most of these sample bottles will come with the preservative already inside the bottle.

Some bottles will come with a separate preservative (acid) for the field preservation.

Slowly add the acid or other preservative to the water sample; not water to the acid or preservative.

Drinking water standards may apply differently based on type and size of public water systems.

National Secondary Drinking Water Regulations

National Secondary Drinking Water Regulations (NSDWRs or secondary standards are non-enforceable guidelines regulating contaminants that may cause cosmetic effects (such as skin or tooth discoloration) or aesthetic effects (such as taste, odor, or color) in drinking water.

The EPA recommends secondary standards to water systems but does not require systems to comply. However, states may choose to adopt them as enforceable standards.

Contaminant	Secondary Standard
Aluminum	0.05 to 0.2 mg/L
Chloride	250 mg/L
Color	15 (color units)
Copper	1.0 mg/L
Corrosivity	noncorrosive
Fluoride	2.0 mg/L
Foaming Agents	0.5 mg/L
Iron	0.3 mg/L
Manganese	0.05 mg/L
Odor	3 threshold odor number
pH	6.5-8.5
Silver	0.10 mg/L
Sulfate	250 mg/L
Total Dissolved Solids	500 mg/L
Zinc	5 mg/L

Notes

¹ Maximum Contaminant Level Goal (**MCLG**) - The maximum level of a contaminant in drinking water at which no known or anticipated adverse effect on the health effect of persons would occur, and which allows for an proper margin of safety. MCLGs are non-enforceable public health goals.

² Maximum Contaminant Level (**MCL**) - The maximum permissible level of a contaminant in water which is delivered to any user of a public water system. MCLs are enforceable standards. The margins of safety in MCLGs ensure that exceeding the MCL slightly does not pose significant risk to public health.

³ Treatment Technique - An enforceable procedure or level of technical performance which public water systems must follow to ensure control of a contaminant.

⁴ Units are in milligrams per Liter (mg/L) unless otherwise noted.

⁵ MCLGs were not established before the 1986 Amendments to the Safe Drinking Water Act. Therefore, there is no MCLG for this contaminant.

⁶ Lead and copper are regulated in a Treatment Technique which requires systems to take tap water samples at sites with lead pipes or copper pipes that have lead solder and/or are served by lead service lines. The action level, which triggers water systems into taking treatment steps, if exceeded in more than 10% of tap water samples, for copper is 1.3 mg/L, and for lead is 0.015mg/L.

⁷ Each water system must certify, in writing, to the state (using third-party or manufacturer's certification) that when acrylamide and epichlorohydrin are used in drinking water systems, the combination (or product) of dose and monomer level does not exceed the levels specified, as follows:

- **Acrylamide** = 0.05% dosed at 1 mg/L (or equivalent)
- **Epichlorohydrin** = 0.01% dosed at 20 mg/L (or equivalent)

⁸ The Surface Water Treatment Rule requires systems using surface water or groundwater under the direct influence of surface water to (1) disinfect their water, and (2) filter their water or meet criteria for avoiding filtration so that the following contaminants are controlled at the following levels:

- **Giardia lamblia**: 99.9% killed/inactivated
Viruses: 99.99% killed/inactivated
- **Legionella**: No limit, but EPA believes that if **Giardia** and viruses are inactivated, **Legionella** will also be controlled.
- **Turbidity**: At no time can turbidity (**cloudiness of water**) go above 5 nephelometric turbidity units (NTU); systems that filter must ensure that the turbidity go no higher than 1 NTU (0.5 NTU for conventional or direct filtration) in at least 95% of the daily samples in any month.
- **HPC**: NO more than 500 bacterial colonies per milliliter.

⁹ No more than 5.0% samples total coliform-positive in a month. (For water systems that collect fewer than 40 routine samples per month, no more than one sample can be total coliform-positive). Every sample that has total coliforms must be analyzed for fecal coliforms. There cannot be any fecal coliforms.

¹⁰ Fecal coliform and *E. coli* are bacteria whose presence indicates that the water may be contaminated with human animal wastes. Microbes in these wastes can cause diarrhea, cramps, nausea, headaches, or other symptoms.

Chemical Monitoring Sub-Section

The final federal rules regarding Phase II and V contaminants were promulgated by the U.S. EPA in 1992 and initial monitoring began in January 1993. This group of contaminants consists of Inorganic Chemicals (IOC), Volatile Organic Chemicals (VOC) and Synthetic Organic Chemicals (SOC) and the rule applies to all community and non-transient non-community public water systems.

The monitoring schedule for these contaminants is phased in by water system population size according to a “standardized monitoring framework” established by the U.S. EPA. This standardized monitoring framework establishes nine-year compliance cycles consisting of three 3-year compliance periods.

The first compliance cycle began back in January 1993 and ended December 31, 2001, with subsequent compliance cycles following the nine-year timeframe. The three-year compliance period of each cycle is the standard monitoring period for the water system.

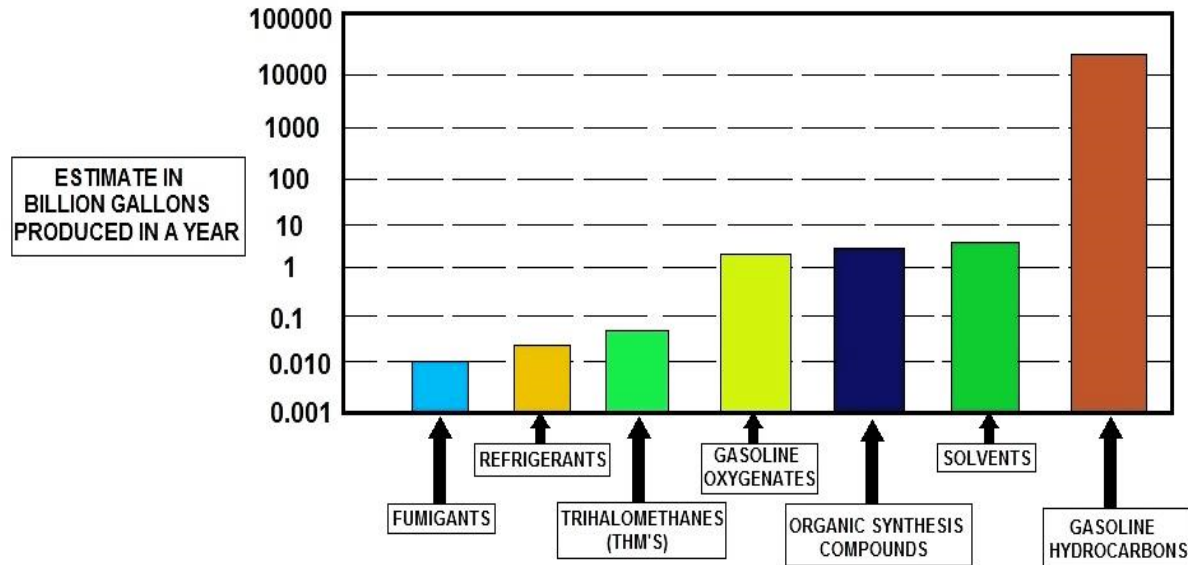

VOLATILE ORGANIC COMPOUNDS FOUND IN GROUNDWATER CHART

Turbidity Monitoring

Monitoring for turbidity is applicable to all public water systems using surface water sources or groundwater sources under the direct influence of surface water in whole or part. Check with your state drinking water section or health department for further instructions.

The maximum contaminant level for turbidity for systems that provide filtration treatment:

1. Conventional or direct filtration: less than or equal to 0.5 NTU in at least 95% of the measurements taken each month. Conventional filtration treatment plants should be able to achieve a level of 0.1 NTU with proper chemical addition and operation.
2. Slow sand filtration, cartridge and alternative filtration: less than or equal to 1 NTU in at least 95% of the measurements taken each month. The turbidity levels must not exceed 5 NTU at any

turbidity measurements must be performed on representative samples of the filtered water every four (4) hours that the system serves water to the public.

A water system may substitute continuous turbidity monitoring for grab sample monitoring if it validates the continuous measurement for accuracy on a regular basis using a protocol approved by the Health or Drinking Water Agency, such as confirmation by a bench top turbidimeter. For systems using slow sand filtration, cartridge, or alternative filtration treatment the Health or Drinking Water Agency may reduce the sampling frequency to once per day if it determines that less frequent monitoring is sufficient to indicate effective filtration performance.

Inorganic Chemical Monitoring

All systems must monitor for inorganics. The monitoring for these contaminants is also complex with reductions, waivers and detections affecting the sampling frequency. Please refer to the monitoring schedules provided by your state health or drinking water sections for assistance in determining individual requirements. All transient non-community water systems are required to complete a one-time inorganic chemical analysis. The sample is to be collected at entry points (**POE**) to the distribution system representative of each source after any application of treatment.



Nitrates

Nitrate is an inorganic chemical that occurs naturally in some groundwater but most often is introduced into ground and surface waters by man. The most common sources are from fertilizers and treated sewage or septic systems.

At high levels (over 10 mg/l) it can cause the “**blue baby**” syndrome in young infants, which can lead to serious illness and even death. It is regarded as an “**acute health risk**” because it can quickly cause illness.

Every water system must test for **Nitrate** at least yearly. Systems that use groundwater only must test yearly. Systems that use surface water and those that mix surface and groundwater must test every quarter. A surface water system may go to yearly testing if community and nontransient noncommunity water must do quarterly monitoring whenever they exceed 5 mg/l in a test. After 4 quarters of testing and if the results show that the nitrate level has not exceeded 5 mg/L, they may go back to yearly testing.

Radiological Contaminants

All community water systems shall monitor for gross alpha activity every four years for each source. Depending on your state rules, compliance will be based on the annual composite of 4 consecutive quarters or the average of the analyses of 4 quarterly samples. If the average annual concentration is less than one half the MCL, an analysis of a single sample may be substituted for the quarterly sampling procedure.

Total Trihalomethanes (TTHM)

All community water systems serving a population of 10,000 or more and which add a disinfectant in any part of the drinking water treatment process shall monitor for total trihalomethanes (**TTHM**). The MCL is 0.08 mg/l (80 ppb) and consists of a calculation of the running average of quarterly analyses of the sum of the concentrations of bromodichloromethane, di-bromochloromethane, bromoform and chloroform.

Lead and Copper Rule

The Lead and Copper Rule was promulgated by the U.S. EPA on June 7, 1991, with monitoring to begin in January 1992 for larger water systems. This rule applies to all community and nontransient, noncommunity water systems and establishes action levels for these two contaminants at the consumer's tap. Action levels of 0.015 mg/l for lead and 1.3 mg/l for copper have been established.

This rule establishes maximum contaminant level goals (**MCLGs**) for lead and copper, treatment technique requirements for optimal corrosion control, source water treatment, public education and lead service line replacement. Whenever an action level is exceeded, the corrosion control treatment requirement is triggered. This is determined by the concentration measured in the 90th percentile highest sample from the samples collected at consumers' taps.

Sample results are assembled in ascending order (lowest to highest) with the result at the 90th percentile being the action level for the system. For example, if a water system collected 20 samples, the result of the 18th highest sample would be the action level for the system.

The rule also includes the best available technology (**BAT**) for complying with the treatment technique requirements, mandatory health effects language for public notification of violations and analytical methods and laboratory performance requirements.

Initial monitoring began in January 1992 for systems with a population of 50,000 or more, in July 1992 for medium-sized systems (3,300 to 50,000 population) and in July 1993 for small-sized systems (less than 3,300 population),

One-liter tap water samples are to be collected at high-risk locations by either water system personnel or residents.

Generally, high-risk locations are homes with lead-based solder installed after 1982 or with lead pipes or service lines. If not enough of these locations exist in the water system, the rule provides specific guidelines for selecting other sample sites.

The water must be allowed to stand motionless in the plumbing pipes for at least six (6) hours and collected from a cold water tap in the kitchen or bathroom. It is a first draw sample, which means the line is not to be flushed prior to sample collection.

The number of sampling sites is determined by the population of the system and sample collection consists of two, six-month monitoring periods; check with your state rule or drinking water section for more information.

Sampling Sites by Population

System size - No. of sites - No. of sites

(no. of persons served) (standard monitoring) (reduced monitoring)

>100,000	100	50
10,001-100,000	60	30
3,301 to 10,000	40	20
501 to 3,300	20	10
101 to 500	10	5
< 100	5	5

If a system meets the lead and copper action levels or maintains optimal corrosion control treatment for two consecutive six-month monitoring periods, then reduced monitoring is allowed and sampling frequency drops to once per year.

After three consecutive years of reduced monitoring, sample frequency drops to once every three years. In addition to lead and copper testing, all large water systems and those medium- and small-sized systems that exceed the lead or copper action levels will be required to monitor for the following water quality parameters: pH, alkalinity, calcium, conductivity, orthophosphate, silica and water temperature.

These parameters are used to identify optimal corrosion control treatment and determine compliance with the rule once treatment is installed.

The sampling locations for monitoring water quality parameters are at entry points and representative taps throughout the distribution system.

Coliform sampling sites can be used for distribution system sampling. The number of sites required for monitoring water quality during each six-month period is shown below.

Number of Water Quality Parameters per Population

System size # (no. of persons served) no. of sites for water quality parameters

>100,000	25
10,001-100,000	10
3,301 to 10,000	3
501 to 3,300	2
101 to 500	1
<100	1

Water systems which maintain water quality parameters reflecting optimal corrosion control for two consecutive six-month monitoring periods qualify for reduced monitoring. After three consecutive years, the monitoring frequency can drop to once per year.

All large water systems must demonstrate that their water is minimally corrosive or install corrosion control treatment regardless of lead and copper sampling results.

Quality Assurance /Quality Control Measures - Introduction

In addition to standard samples, the field technicians collect equipment blanks (**EB**), field cleaned equipment blanks (**FB**), split samples (**SS**), and field duplicate samples (**FD**).

Overall care must be taken in regards to equipment handling, container handling/storage, decontamination, and record keeping. Sample collection equipment and non-preserved sample containers must be rinsed three times with sample water before the actual sample is taken. Exceptions to this are any pre-preserved container or bac-t type samples.

If protective gloves are used, they shall be clean, new and disposable. These should be changed upon arrival at a new sampling point. Highly contaminated samples shall never be placed in the same ice chest as environmental samples. It is good practice to enclose highly contaminated samples in a plastic bag before placing them in ice chests. The same is true for wastewater and drinking water samples.

Ice chests or shipping containers with samples suspected of being highly contaminated shall be lined with new, clean, plastic bags. If possible, one member of the field team should take all the notes, fill out labels, etc., while the other member does all of the sampling.

Preservation of Samples

Proper sample preservation is the responsibility of the sampling team, not the lab providing sample containers. The best reference for preservatives is Standard Methods or your local laboratory.

It is the responsibility of the field team to assure that all samples are appropriately preserved.

Follow the preservative solution preparation instructions.

Always use strong safety precautions when diluting any acid.

Slowly add the acid or other preservative to the water sample; not water to the acid or preservative.

Put a new label on the dispensing bottle with the current date.

Wait 3-4 hours for the preservative to cool most samples down to 4 degrees Celsius.

Most preservatives have a shelf life of one year from the preparation date.

When samples are analyzed for TKN, TP, NH₄ and NO_x 1 mL of 50% Trace Metal grade sulfuric acid is added to each discrete auto sampler bottles/bags in the field lab before sampling collection. The preservative maintains the sample at 1.5<pH<2 after collection. To meet maximum holding time for these preserved samples (28 days), pull and ship samples every 14 days.

Narrow range pH paper (test strips) can be used to test an aliquot of the preserved sample.

Place the pH paper into the container and compare the color with the manufacturer's color chart.



FINISHED WATER REPORT	UNITS OF MEASURE
FINISHED WATER TURBIDITY	NTU Neophelometric Turbidity Unit
FINISHED WATER TEMPERATURE	Deg. C Degrees Celcius
FINISHED WATER pH	SU Standard Units
FINISHED WATER ALKALINITY	mg/l Milligrams per Liter
FINISHED WATER HARDNESS	mS/cm Millisiemens per Centimeter
FINISHED WATER CONDUCTIVITY	mg/l Milligrams per Liter
FINISHED WATER TOTAL DISSOLVED SOLIDS	mg/l Milligrams per Liter
FINISHED WATER FLUORIDE	mg/l Milligrams per Liter
FINISHED WATER IRON	mg/l Milligrams per Liter
FINISHED WATER MANGANESE	mg/l Milligrams per Liter
FINISHED WATER PHOSPHATE	mg/l Milligrams per Liter
HARDNESS PER GALLON	GRAINS

WATER QUALITY REPORT INCLUDING UNITS OF MEASUREMENT

FINISHED WATER REPORTING INFO	UNITS OF MEASUREMENT
FINISHED WATER TURBIDITY	NTU – NEOPHELOMETRIC TURBIDITY UNIT
FINISHED WATER TEMPERATURE	DEGREES CELCIUS
FINISHED WATER pH	SU – STANDARD UNITS
FINISHED WATER ALKALINITY	PPM or GRAINS PER GALLON
FINISHED WATER HARDNESS	Degrees of general hardness (dGH or °GH) Milligrams of CaCO ₃ per Liter
FINISHED WATER CONDUCTIVITY	Millimhos per Centimeter [mmho/cm]
FINISHED WATER TOTAL DISSOLVED SOLIDS	Mg/L - Milligrams per Liter
FINISHED WATER FLUORIDE	Mg/L - Milligrams per Liter
FINISHED WATER IRON	Mg/L - Milligrams per Liter
FINISHED WATER MANGANESE	Mg/L - Milligrams per Liter
FINISHED WATER PHOSPHATE	Mg/L - Milligrams per Liter
HARDNESS PER GALLON	GRAINS PER GALLON

Water quality reports are used not only to satisfy state and federal compliance. It is a great reference tool for evaluating changes to source water due to human influence and unforeseen weather changes.

Since the Lead and Copper rule was enacted by EPA water systems analyze the water to see if it will leach the metals from the pipe, causing corrosion, or chemicals will precipitate out causing scaling in pipes and industrial processes such as boilers.

Drinking Water Sampling - Analysis Charts

<u>ANALYSIS</u>	<u>METHOD</u>	<u>HOLDING TIME</u>
Inorganic Compounds (IOC) Antimony, Arsenic, Barium, Beryllium, Cadmium, Chromium, Copper, Iron, Lead, Manganese, Mercury, Nickel, Selenium, Silver, Sodium, Thallium, Zinc, Hardness, Conductivity, Turbidity, Color, Chloride, Cyanide, Fluoride, Nitrate, Nitrite, Sulfate, and Total Dissolved Solids.	(various)	48 hours
Primary Pollutants (Short IOC) Antimony, Arsenic, Barium, Beryllium, Cadmium, Chromium, Lead, Mercury, Selenium, Silver, Sodium, Thallium, Turbidity, Fluoride, Cyanide, Nitrate, and Nitrite.	(various)	48 hours
Municipal Testing		
Lead and Copper	EPA 200.9 for Pb EPA 200.7 for Cu	14 days
Public or Individual Water Source Testing		
Nitrate	SM-4500 NO3 D	48 hours
Total Coliform & E. Coli	SM-9223 B	30 Hours
Metals Analysis on Drinking Water (per element)		
GFAA (As, Pb, Sb, Se, Tl)	EPA 200.9	6 months
ICP (Ag, Al, B, Ba, Be, Cd, Cr, Cu, Fe, Mn, Mo, Na, Ni, Zn)	EPA 200.7	6 months
CVAA (Hg)	EPA 245.1	6 months
Primary Pollutant Metals	GFAA/ICP/CVAA	6 months

Drinking Water Analysis

PH	EPA 150.1	
Acidity	SM-2310 B (4b)	14 days
Alkalinity (Bicarbonate & Carbonate)	SM-2320 B (4a)	14 days
BOD	SM-5210 B	48 hours
Calcium	EPA 200.7	6 months
Chloride	SM-4500 Cl	8 days
Chlorine, total	SM-4500 Cl	5 hours
Color	SM-2120 B	8 hours
COD	EPA 410.4 (7.3)	28 days
Cyanide	EPA 335.2 (8.7)	28 days
Dissolved Oxygen	SM-4500 O C	8 hours
Fluoride	SM-4500 F C	28 days
Hardness	SM-2340 B	6 months

Magnesium	EPA 200.7	6 months
Nitrogen, ammonia	SM-4500 NH3 E	28 days
	SM-4500 NH3 H	
Nitrogen, nitrate	SM-4500 NO3 D	48 hours
Nitrogen, nitrite	SM-4500 NO2	48 hours
Nitrate + Nitrite	SM-4500 NO3 E	48 hours
Nitrogen, TKN	EPA 351.4	28 days
Odor	SM-2150	6 days
Phosphorous, ortho	EPA 200.7	48 hours
Phosphorous, total	SM-4500 P	28 days
Solids, settle able	SM-2540	7 days
Solids, suspended	SM-2540 D	7 days

<u>Drinking Water Analysis</u>		
Solids, total dissolved	SM-2540 B	7 days
Solids, volatile	SM-2540 E	7 days
Specific Conductance	SM-2510 B	28 days
Sulfate	SM-4500 SO-4 E	28 days
Sulfide	SM-4500 S-2 D	28 days
Sulfite	EPA 377.1	28 days
Silica	SM-4500 SI E	28 days
Total Organic Carbon	EPA 415.1	28 days
Turbidity	SM- 2130 B	48 hours

<u>ORGANICS</u>		
Semi-volatile Organics in Water (SOC)*	(various)	7 days
Volatile Organics in Water*	(various)	7 days
Trihalomethanes*	EPA 501.1	7 days
Gross Alpha & Beta (Radionuclides)*	(various)	7 days
BOD	SM-5210 B	48 hours
COD	EPA 410.4(7.3)	28 days
Oil and Grease	EPA 413.1(1.2)	28 days
Hardness W/digestion	SM-2340 B	6 months
Nitrogen, TKN	EPA 351.4	28 days
Nitrogen, ammonia	SM-4500 NH3 F	28 days
Nitrogen, Total Organic	SM-4500 NorgNH3	28 days
Nitrogen, nitrate	SM-4500 NO3 D	48 hours
Nitrogen, nitrite	SM-4500 NO2 B	48 hours
Phosphorous, ortho	SM-4500 P E	48 hours
Sulfate	SM-4500 SO4 E	28 days
Solids, dissolved	SM-2540	7 days
Solids, settle able	SM-2540 F	7 days
Solids, suspended	SM-2540 D	7 days
Solids, total	SM-2540 B	7 days
Solids, volatile	SM-2540 E	7 days
Total Organic Carbon	EPA 415.1	28 days
PH	EPA 150.1	
Metals (per element)		

ICP (Ag, Al, Ca, Cd, Co, Cr, Cu, Fe, K, Mg, Mn, Mo, Na, Ni, Sb, V, Zn)	EPA 200.7	6 months
GFAA (As, Pb, Ba, Se, Tl)	EPA 200.9	6 months
CVAA (Hg)	EPA 245.1	6 months

Definitions:

Action level - the concentration of a contaminant which, if exceeded, triggers treatment or other requirements which a water system must follow.

Maximum Contaminant Level - the “Maximum Allowed” (MCL) is the highest level of a contaminant that is allowed in drinking water. MCLs are set as close to the MCLGs as feasible using the best available treatment technology.

Maximum Contaminant Level Goal - the “Goal” (MCLG) is the level of a contaminant in drinking water below which there is no known or expected risk to health. MCLGs allow for a margin of safety.

Non-Detects (ND) - laboratory analysis indicates that the constituent is not present.

Parts per million (ppm) or Milligrams per liter (mg/L) - one part per million corresponds to one minute in two years or a single penny in \$10,000.

Parts per billion (ppb) or Micrograms per liter (ug/L) - one part per billion corresponds to one minute in 2,000 years, or a single penny in \$10,000,000.

Picocuries per liter (pCi/L) - picocuries per liter is a measure of the radioactivity in water.

This course contains EPA’s federal rule requirements. Please be aware that each state implements drinking water regulations that may be more stringent than EPA’s regulations. Check with your state environmental agency for more information.

SAMPLE CONTAINERS and PRESERVATION

Methods used by the laboratory usually specify what type of container and how much sample is required to run an analysis. The following table provides a summary of the sample handling and preservation requirements for some of the most common tests.

Parameter	Bottle Type	Minimum Sample Size	Maximum Holding Time	Storage & Preservation
Acidity	P or G ^B	100ml	24 hrs/14 days	refrigerate
Alkalinity	P or G	200ml	24 hrs/14 days	refrigerate
BOD (5 day)	P or G	1L	6 hrs/48 hrs	refrigerate
Boron	P	100ml	28 days/6 months	
Chloride	P or G	250ml	28 days	
Chlorine, residual	P or G	500ml	0.5 hr/stat	analyze on site ASAP
COD	P or G	500ml	28 days/28 days	analyze on site ASAP
Color	P or G	500ml	48 hrs/48 hrs	refrigerate
Coliform, Total	P or G	125ml	30 hrs	refrigerate
Conductivity	P or G	500ml	48 hrs/48 hrs	refrigerate
Cyanide, Total	P or G	500ml	28 days/28 days	add NaOH to pH>12
				refrigerate in dark
Fluoride	P	300ml	28days/ 28 days	
Hardness	P or G	100ml	6 months/6 months	add HNO ₃ to pH<2
Metals, general	P ^A or G ^A	250ml	6 months/6 months	add HNO ₃ to pH<2
<i>Furnace</i>	P ^A or G ^A	250ml	6 months/6 months	
<i>Flame</i>	P ^A or G ^A	250ml	6 months/6 months	
Mercury	P ^A or G ^A	500ml	28 days/28 days	add HNO ₃ to pH<2
Nitrogen	P or G	500ml	7 days/ 28 days	ASAP or add H ₂ SO ₄ to pH<2 & refrigerate
<i>Ammonia</i>				
<i>Nitrate</i>	P or G	100ml	48 hrs/48 hrs	ASAP & refrigerate
<i>Nitrate + Nitrite</i>	P or G	200ml	48 hrs/28 days	ASAP & refrigerate
<i>Nitrite</i>	P or G	100ml	none/48 hrs	ASAP & refrigerate

<i>TKN</i>	P or G	500ml	7 days/28 days	add H ₂ SO ₄ to pH<2
Oxygen, dissolved	G (BOD)	300ml		
<i>Electrode</i>			0.5 hrs/stat	ASAP on site
<i>Winkler</i>			8hrs/8 hrs	ASAP on site
pH	P or G	50ml	2 hrs/stat	ASAP on site
Phosphate,	G ^A			
<i>Ortho</i>		100ml	48hrs	filter ASAP refrigerate
<i>Total</i>		100ml	28 days/28 days	refrigerate
Solids,	P or G			
<i>Dissolved</i>		250ml	7 days	refrigerate
<i>Settleable</i>		1L	48 hrs	refrigerate
<i>Suspended</i>		250ml	7 days	refrigerate
<i>Total</i>		250ml	7 days	refrigerate
<i>Volatile</i>		250ml	7 days	refrigerate
Silica	P	200ml	28 days/28 days	refrigerate
Sulfate	P or G	100ml	28 days/28 days	refrigerate
Turbidity	P or G	100ml	24 hrs/48 hrs	ASAP/refrigerate, store in dark up to 24 hrs

Refrigerate = storage at 4 degrees C, in the dark. P = plastic (polyethylene or equivalent); G = glass, G^A or P^A = rinsed with 1:1 HNO₃; G^B = glass, borosilicate, G^S = glass rinsed with organic solvents; NS = not stated in cited reference; stat = no storage allowed; analyze immediately.



Inorganic Compound (IOC) Sub-Section

Periodic Table of the Elements

Element Categories

- alkali metals
- alkaline metals
- other metals
- transition metals
- lanthanoids
- actinoids
- metalloids
- nonmetals
- halogens
- noble gases
- unknown elements

Electron Configuration Blocks

s, p, d, f

Callout for Iron (Fe):

- atomic number → 26
- white metal - gas state at 0°C
- chemical symbol → Fe
- chemical name → Iron
- standard atomic weight → 55.85
- (lower upper bounds)
- (closest no stable isotopes)

Natural Occurrence

- primordial
- from decay
- synthetic

1	2											13	14	15	16	17	18
1	2											3	4	5	6	7	8
3	4											5	6	7	8	9	10
11	12											13	14	15	16	17	18
19	20	21	22	23	24	25	26	27	28	29	30	31	32	33	34	35	36
37	38	39	40	41	42	43	44	45	46	47	48	49	50	51	52	53	54
55	56	57-71	72	73	74	75	76	77	78	79	80	81	82	83	84	85	86
87	88	89-103	104	105	106	107	108	109	110	111	112	113	114	115	116	117	118
57	58	59	60	61	62	63	64	65	66	67	68	69	70	71			
89	90	91	92	93	94	95	96	97	98	99	100	101	102	103			

Inorganic Compound

Inorganic Contaminants (IOCs) are elements or compounds found in water supplies and may be natural in the geology or caused by activities of man through mining, industry or agriculture. An inorganic compound is typically a chemical compound that lacks Carbon-Hydrogen bonds, that is, a compound that is not an organic compound, but the distinction is not defined or even of particular interest. Some simple compounds that contain carbon are often considered inorganic.

Examples include many toxic or poisonous compounds like:

carbon monoxide, carbon dioxide, carbonates, cyanides, cyanates, carbides, and thiocyanates. Many of these are normal parts of mostly organic systems, including organisms, which means that describing a chemical as inorganic does not obligately mean that it does not occur within living things.

It is common to have trace amounts of many Inorganic Contaminants in water supplies. Amounts above the Maximum Contaminant Levels may cause a variety of damaging effects to the liver, kidney, nervous system circulatory system, blood, gastrointestinal system, bones, or skin depending upon the inorganic contaminant and level of exposure.

IOC Sample Collection – Things to Remember

Sample instructions should be supplied with the sample containers from the laboratory. If the laboratory fails to include sample instructions, contact the laboratory and request sample instructions.

Some general practices to remember:

- Samples should be collected at the entry point to the distribution system after all treatment (finished water)
- Select a sampling faucet that does NOT have an aerator (sampling must be done with minimum aeration)
- Run the water until the temperature is as cold as it gets (except for Pb and Cu samples.)
- Just before sample collection, adjust to a very low flow. Do not change the flow while collecting the sample
- Routine nitrate and nitrite samples should be collected on a Monday or a Tuesday
- When filling sample bottle, tip bottle slightly so that water flows down the side wall of the container. Bring bottle to an upright position as it fills
- Call the laboratory if bottles are received broken (or break while collecting samples)
- The owner or operator of a water supply must maintain chemical analysis reports (results) or a summary of those reports for at least 10 years



Inorganic Chemicals

Contaminant	MCLG ¹ (mg/L) ²	MCL or TT ¹ (mg/L) ²	Potential Health Effects from Long-Term Exposure Above the MCL (unless specified as short-term)	Sources of Contaminant in Drinking Water
Antimony	0.006	0.006	Increase in blood cholesterol; decrease in blood sugar	Discharge from petroleum refineries; fire retardants; ceramics; electronics; solder
Arsenic	0 ²	0.010 as of 01/23/06	Skin damage or problems with circulatory systems, and may have increased risk of getting cancer	Erosion of natural deposits; runoff from orchards, runoff from glass & electronics production wastes
Asbestos (fiber >10 micrometers)	7 million fibers per liter	7 MFL	Increased risk of developing benign intestinal polyps	Decay of asbestos cement in water mains; erosion of natural deposits
Barium	2	2	Increase in blood pressure	Discharge of drilling wastes; discharge from metal refineries; erosion of natural deposits
Beryllium	0.004	0.004	Intestinal lesions	Discharge from metal refineries and coal-burning factories; discharge from electrical, aerospace, and defense industries
Cadmium	0.005	0.005	Kidney damage	Corrosion of galvanized pipes; erosion of natural deposits; discharge from metal refineries; runoff from waste batteries and paints
Chromium (total)	0.1	0.1	Allergic dermatitis	Discharge from steel and pulp mills; erosion of natural deposits
Copper	1.3	TT ² ; Action Level=1.3	Short term exposure: Gastrointestinal distress Long term exposure: Liver or kidney damage People with Wilson's Disease should consult their personal doctor if the amount of copper in their water exceeds the action level	Corrosion of household plumbing systems; erosion of natural deposits

Inorganic Chemicals

Contaminant	MCLG ¹ (mg/L) ²	MCL or TT ¹ (mg/L) ²	Potential Health Effects from Long-Term Exposure Above the MCL (unless specified as short-term)	Sources of Contaminant in Drinking Water
Cyanide (as free cyanide)	0.2	0.2	Nerve damage or thyroid problems	Discharge from steel/metal factories; discharge from plastic and fertilizer factories
Fluoride	4.0	4.0	Bone disease (pain and tenderness of the bones); Children may get mottled teeth	Water additive which promotes strong teeth; erosion of natural deposits; discharge from fertilizer and aluminum factories
Lead	zero	TT ² ; Action Level=0.015	Infants and children: Delays in physical or mental development; children could show slight deficits in attention span and learning abilities Adults: Kidney problems; high blood pressure	Corrosion of household plumbing systems; erosion of natural deposits
Mercury (inorganic)	0.002	0.002	Kidney damage	Erosion of natural deposits; discharge from refineries and factories; runoff from landfills and croplands
Nitrate (measured as Nitrogen)	10	10	Infants below the age of six months who drink water containing nitrate in excess of the MCL could become seriously ill and, if untreated, may die. Symptoms include shortness of breath and blue-baby syndrome.	Runoff from fertilizer use; leaking from septic tanks, sewage; erosion of natural deposits
Nitrite (measured as Nitrogen)	1	1	Infants below the age of six months who drink water containing nitrite in excess of the MCL could become seriously ill and, if untreated, may die. Symptoms include shortness of breath and blue-baby syndrome.	Runoff from fertilizer use; leaking from septic tanks, sewage; erosion of natural deposits
Selenium	0.05	0.05	Hair or fingernail loss; numbness in fingers or toes; circulatory problems	Discharge from petroleum refineries; erosion of natural deposits; discharge from mines

Synthetic Organic Chemicals (SOCs) Sub-Section

SOC/VOC bottles are the smaller, thin bottles with the septum tops. Be careful not to get any air bubbles in the SOC/VOC bottles. It may take a few weeks to learn to collect a proper sample.

SOC

Synthetic Organic Chemicals (SOCs) are organic (carbon based) chemicals that are less volatile than Volatile Organic Compounds (VOCs). SOCs are used as pesticides, defoliants, fuel additives and as ingredients for other organic compounds. They are all man made and do not naturally occur in the environment. Some of the more well-known SOCs are Atrazine, 2,4-D, Dioxin and Polychlorinated Biphenyls (PCBs).

SOCs most often enter the natural environment through application of pesticide (including runoff from areas where they are applied), as part of a legally discharged waste stream, improper or illegal waste disposal, accidental releases or as a byproduct of incineration. Some SOCs are very persistent in the environment, whether in soil or water.

SOCs are generally toxic and can have substantial health impacts from both acute (short-term) and chronic (long-term) exposure. Many are known carcinogens (cancer causing). EPA has set Maximum Contaminant Levels (MCL) for 30 SOCs under the Safe Drinking Water Act.

The Safe Drinking Water Act requires that all water sources of all public water systems be periodically monitored for regulated SOCs. The monitoring frequency can be adjusted through a waiver if SOCs are not detected.

EPA established Maximum Contaminant Levels (MCL), Maximum Contaminant Level Goals (MCLG), monitoring requirements and best available technologies for removal for 65 chemical contaminants over a five-year period as EPA gathered and analyzed occurrence and health effects data. This series of rules are known as the Chemical Phase Rules and they define regulations for three contaminant groups:

- ✓ Inorganic Chemicals (IOC),
- ✓ Synthetic Organic Chemicals (SOC), and
- ✓ Volatile Organic Chemicals (VOC).

The Chemical Phase rules provide public health protection through the reduction of chronic risks from:

- ✓ cancer;
- ✓ organ damage; and
- ✓ circulatory,
- ✓ nervous, and
- ✓ reproductive system disorders.

They also help to reduce the occurrence of Methemoglobinemia or "blue baby syndrome" from ingestion of elevated levels of nitrate or nitrite. All public water systems must monitor for Nitrate and Nitrite.

Community water systems and Non-transient non-community water systems must also monitor for IOCs, SOCs, and VOCs.

These lists of the organic chemicals—which include pesticides, industrial chemicals, and disinfection by-products—that are tested for in public water systems (those that provide water to the public), along with the maximum standard for the contaminant, and a brief description of the potential health effects associated with long-term consumption of elevated levels of the contaminants.

The federal standard for most contaminants is listed as a Maximum Contaminant Level (MCL), the lowest concentration at which that particular contaminant is believed to represent a potential health concern. Unless otherwise noted, the MCL is expressed as parts per billion (ppb).

Also, because of technological limitations or other factors, it is not possible to test for some contaminants in a reliable fashion. Instead, public water systems are required to use specific Treatment Techniques (TT) that are designed to remove these particular contaminants from the water.

Unregulated Chemicals

In addition to the chemicals listed, monitoring is done for approximately 60 organic chemicals for which MCLs have not been established. If unacceptable levels are found of these “unregulated” contaminants—based on established state health standards and an assessment of the risks they pose—the response is the same as if an MCL has been exceeded: the public water system must notify those served by the system.

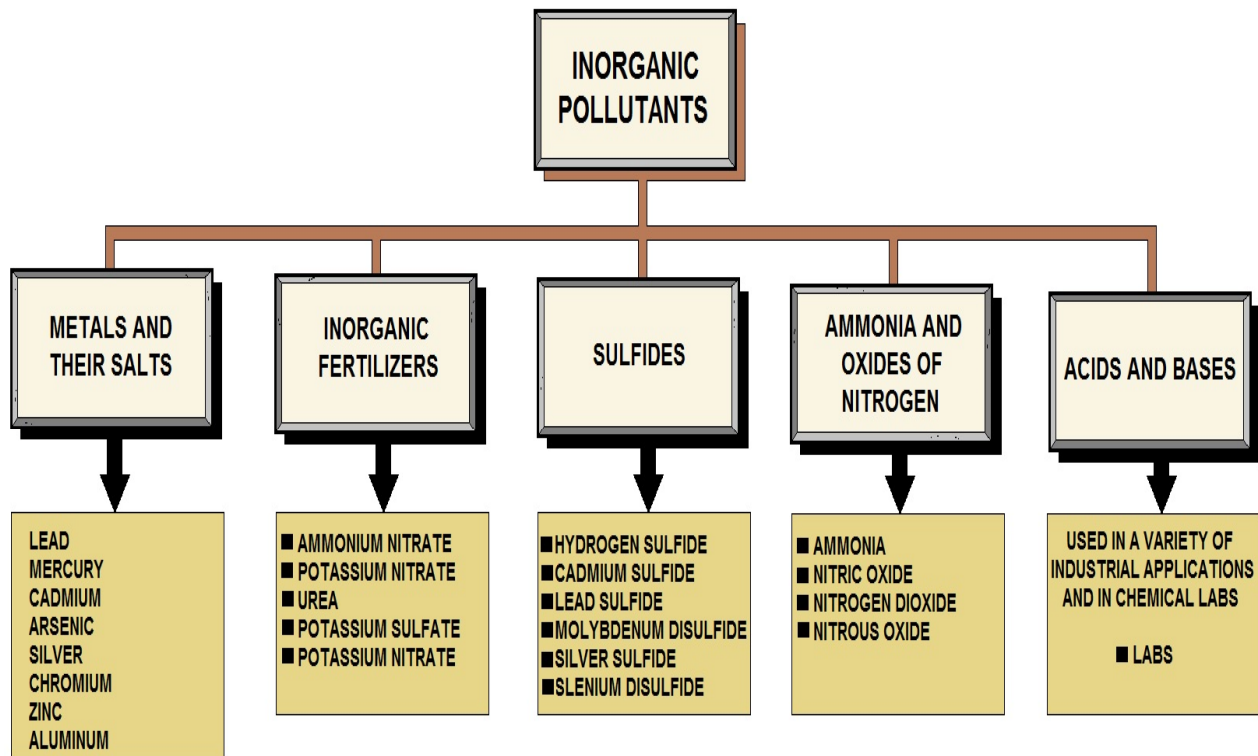

INORGANIC CONTAMINANTS OF WATER EXAMPLES



Synthetic Organic Chemicals	MCL (ppb)	Potential Health Effects
Acrylamide	TT	Cancer, nervous system effects
Alachlor	2	Cancer
Aldicarb	3	Nervous system effects
Aldicarb sulfoxide	4	Nervous system effects
Aldicarb sulfone	2	Nervous system effects
Atrazine	3	Liver, kidney, lung, cardiovascular effects; possible carcinogen
Benzo(a)pyrene (PAHs)	0.2	Liver, kidney effects, possible carcinogen
Carbofuran	40	Nervous system, reproductive system effects
Chlordane	2	Cancer
2,4-D	70	Liver, kidney effects
Di(2-ethylhexyl) adipate	400	Reproductive effects
Di(2-ethylhexyl) phthalate	6	Cancer
Dibromochloro-propane (DBCP)	0.2	Cancer
Dinoseb	7	Thyroid, reproductive effects
Diquat	20	Ocular, liver, kidney effects
Endothall	100	Liver, kidney, gastrointestinal effects
Endrin	2	Liver, kidney effects
Epichlorohydrin	TT	Cancer
Ethylene dibromide (EDB)	0.05	Cancer
Glyphosate	700	Liver, kidney effects
Heptachlor	0.4	Cancer
Heptachlor epoxide	0.2	Cancer
Hexachlorobenzene	1	Cancer
Hexachlorocyclopentadiene (HEX)	50	Kidney, stomach effects

Lindane	0.2	Liver, kidney, nervous system, immune system, circulatory system effects
Methoxychlor	40	Developmental, liver, kidney, nervous system effects
Oxamyl (Vydate)	200	Kidney effects
Pentachlorophenol	1	Cancer
Picloram	500	Kidney, liver effects
Polychlorinated biphenyls (PCBs)	0.5	Cancer
Simazine	4	Body weight and blood effects, possible carcinogen
2,3,7,8-TCDD (Dioxin)	0.00003	Cancer
Toxaphene	3	Cancer
2,4,5-TP (Silvex)	50	Liver, kidney effects

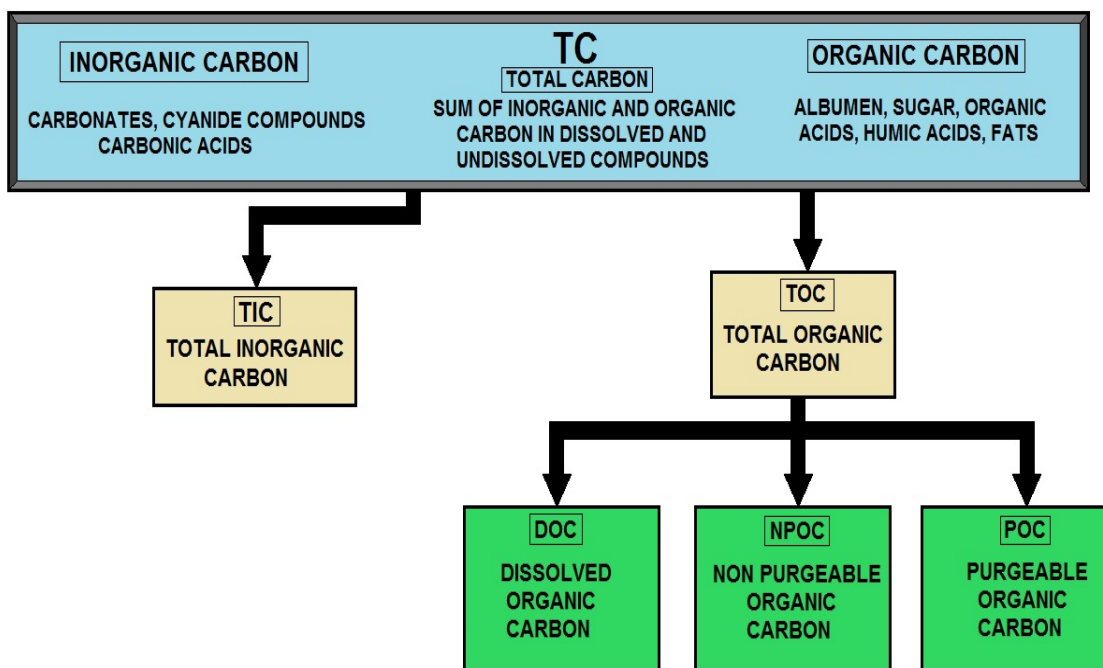

TOTAL ORGANIC COMPOUNDS (CARBON)



Volatile Organic Compounds (VOCs) Sub-Section

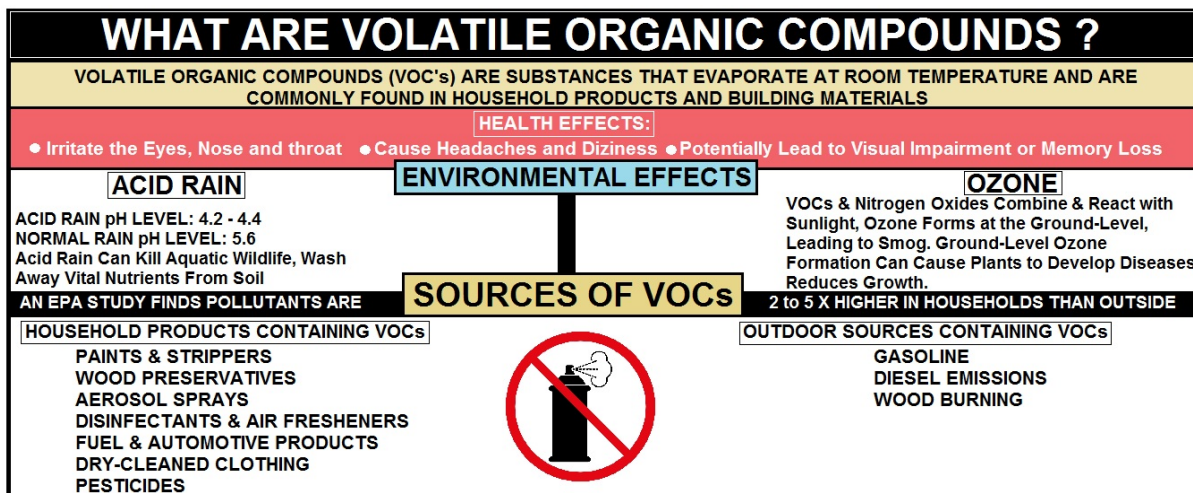

VOLATILE ORGANIC COMPOUNDS (VOCs)

Definitions

Volatile Organic Compounds (VOCs) – “VOCs are groundwater contaminants of concern because of very large environmental releases, human toxicity, and a tendency for some compounds to persist in and migrate with groundwater to drinking-water supply well ... In general, VOCs have high vapor pressures, low-to-medium water solubilities, and low molecular weights. Some VOCs may occur naturally in the environment, other compounds occur only as a result of manmade activities, and some compounds have both origins.” - Zogorski and others, 2006

Volatile Organic Compounds (VOCs) – “Volatile organic compounds released into the atmosphere by anthropogenic and natural emissions which are important because of their involvement in photochemical pollution.” - Lincoln and others, 1998

Volatile Organic Compounds (VOCs) – “Hydrocarbon compounds that have low boiling points, usually less than 100°C, and therefore evaporate readily. Some are gases at room temperature. Propane, benzene, and other components of gasoline are all volatile organic compounds.” - Art, 1993

Volatile Organic Compounds (VOCs) – “VOCs are organic compounds that can be isolated from the water phase of a sample by purging the water sample with inert gas, such as helium, and, subsequently, analyzed by gas chromatography.

Many VOCs are human-made chemicals that are used and produced in the manufacture of paints, adhesives, petroleum products, pharmaceuticals, and refrigerants. They often are compounds of fuels, solvents, hydraulic fluids, paint thinners, and dry-cleaning agents commonly used in urban settings. VOC contamination of drinking water supplies is a human-health concern because many are toxic and are known or suspected human carcinogens.” - U.S. Geological Survey, 2005

VOCs Explained

Volatile organic compounds (VOCs) are organic chemicals that have a high vapor pressure at ordinary, room-temperature conditions. Their high vapor pressure results from a low boiling point, which causes large numbers of molecules to evaporate or sublime from the liquid or solid form of the compound and enter the surrounding air. An example is formaldehyde, with a boiling point of $-19\text{ }^{\circ}\text{C}$ ($-2\text{ }^{\circ}\text{F}$), slowly exiting paint and getting into the air.

VOCs are numerous, varied, and ubiquitous. They include both human-made and naturally occurring chemical compounds. Most scents or odors are of VOCs. VOCs play an important role in communication between plants. Some VOCs are dangerous to human health or cause harm to the environment.

Anthropogenic VOCs are regulated by law, especially indoors, where concentrations are the highest. Harmful VOCs are typically not acutely toxic, but instead have compounding long-term health effects. Because the concentrations are usually low and the symptoms slow to develop, research into VOCs and their effects is difficult.

Specific Components

Paints and Coatings

A major source of man-made VOCs are coatings, especially paints and protective coatings. Solvents are required to spread a protective or decorative film. Approximately 12 billion liters of paints are produced annually. Typical solvents are aliphatic hydrocarbons, ethyl acetate, glycol ethers, and acetone. Motivated by cost, environmental concerns, and regulation, the paint and coating industries are increasingly shifting toward aqueous (water-based) solvents.

Chlorofluorocarbons and Chlorocarbons

Chlorofluorocarbons, which are banned or highly regulated, were widely used cleaning products and refrigerants. Tetrachloroethene is used widely in dry cleaning and by industry. Industrial use of fossil fuels produces VOCs either directly as products (e.g., gasoline) or indirectly as byproducts (e.g., automobile exhaust).

Benzene

One VOC that is a known human carcinogen is benzene, which is a chemical found in environmental tobacco smoke, stored fuels, and exhaust from cars in an attached garage. Benzene also has natural sources such as volcanoes and forest fires. It is frequently used to make other chemicals in the production of plastics, resins, and synthetic fibers. Benzene evaporates into the air quickly and the vapor of benzene is heavier than air allowing the compound to sink into low-lying areas. Benzene has also been known to contaminate food and water and if digested can lead to vomiting, dizziness, sleepiness, rapid heartbeat, and at high levels, even death may occur.

Methylene Chloride

Methylene chloride is another VOC that is highly dangerous to human health. It can be found in adhesive removers and aerosol spray paints and the chemical has been proven to cause cancer in animals. In the human body, methylene chloride is converted to carbon monoxide and a person will suffer the same symptoms as exposure to carbon monoxide. If a product that contains methylene chloride needs to be used the best way to protect human health is to use the product outdoors. If it must be used indoors, proper ventilation is essential to keeping exposure levels down.

Perchloroethylene

Perchloroethylene is a volatile organic compound that has been linked to causing cancer in animals. It is also suspected to cause many of the breathing related symptoms of exposure to VOC's. Perchloroethylene is used mostly in dry cleaning.

Studies show that people breathe in low levels of this VOC in homes where dry-cleaned clothes are stored and while wearing dry-cleaned clothing. While dry cleaners attempt to recapture perchloroethylene in the dry cleaning process to reuse it in an effort to save money, they can't recapture it all. To avoid exposure to perchloroethylene, if a strong chemical odor is coming from clothing when picked up from the dry cleaner, do not accept them and request that less of the chemical be used as well as a complete drying of the garments

MTBE

MTBE was banned in the US around 2004 in order to limit further contamination of drinking water aquifers primarily from leaking underground gasoline storage tanks where MTBE was used as an octane booster and oxygenated-additive.

Formaldehyde

Many building materials such as paints, adhesives, wall boards, and ceiling tiles slowly emit formaldehyde, which irritates the mucous membranes and can make a person irritated and uncomfortable. Formaldehyde emissions from treated wood are in the range of 0.02 – 0.04 ppm. Relative humidity within an indoor environment can also affect the emissions of formaldehyde. High relative humidity and high temperatures allow more vaporization of formaldehyde from wood materials.

Health Risks

Respiratory, allergic, or immune effects in infants or children are associated with man-made VOCs and other indoor or outdoor air pollutants. Some VOCs, such as styrene and limonene, can react with nitrogen oxides or with ozone to produce new oxidation products and secondary aerosols, which can cause sensory irritation symptoms. Unspecified VOCs are important in the creation of smog.

Health Effects Include:

Eye, nose, and throat irritation; headaches, loss of coordination, nausea; damage to liver, kidney, and central nervous system. Some organics can cause cancer in animals; some are suspected or known to cause cancer in humans. Key signs or symptoms associated with exposure to VOCs include conjunctival irritation, nose and throat discomfort, headache, allergic skin reaction, dyspnea, declines in serum cholinesterase levels, nausea, emesis, epistaxis, fatigue, dizziness.

The ability of organic chemicals to cause health effects varies greatly from those that are highly toxic, to those with no known health effects. As with other pollutants, the extent and nature of the health effect will depend on many factors including level of exposure and length of time exposed.

Routes of Entry

Eye and respiratory tract irritation, headaches, dizziness, visual disorders, and memory impairment are among the immediate symptoms that some people have experienced soon after exposure to some organics. At present, not much is known about what health effects occur from the levels of organics usually found in homes.

Many organic compounds are known to cause cancer in animals; some are suspected of causing, or are known to cause, cancer in humans.

Reducing Exposure

To reduce exposure to these toxins, one should buy products that contain Low-VOC's or No VOC's. Only the quantity which will soon be needed should be purchased, eliminating stockpiling of these chemicals. Use products with VOC's in well ventilated areas. When designing homes and buildings, design teams can implement the best possible ventilation plans, call for the best mechanical systems available, and design assemblies to reduce the amount of infiltration into the building.

These methods will help improve indoor air quality, but by themselves they cannot keep a building from becoming an unhealthy place to breathe. While proper building ventilation is a key component to improving indoor air quality, it cannot do the job on its own. As stated earlier, awareness is the key component to improving air quality, when choosing building materials, furnishings, and decorations. When architects and engineers implement best practices in ventilation and mechanical systems, the owner must maintain good air quality levels thereafter.

Chemical Fingerprinting

The exhaled human breath contains a few hundred volatile organic compounds and is used in breath analysis to serve as a VOC biomarker to test for diseases such as lung cancer. One study has shown that "volatile organic compounds ... are mainly blood borne and therefore enable monitoring of different processes in the body." And it appears that VOC compounds in the body "may be either produced by metabolic processes or inhaled/absorbed from exogenous sources" such as environmental tobacco smoke. Research is still in the process to determine whether VOCs in the body are contributed by cellular processes or by the cancerous tumors in the lung or other organs.

Volatile Organic Chemicals	MCL (ppb)	Potential Health Effects
Benzene	5	Cancer
Carbon tetrachloride	5	Liver effects, cancer
Chlorobenzene	100	Liver, kidney, nervous system effects
o-Dichlorobenzene	600	Liver, kidney, blood cell effects
para-Dichlorobenzene	175	Kidney effects, possible carcinogen
1,2-Dichloroethane	5	Cancer
1,1-Dichloroethylene	7	Liver, kidney effects, possible carcinogen
cis-1,2-Dichloroethylene	70	Liver, kidney, nervous system, circulatory system effects
trans-1,2-Dichloroethylene	100	Liver, kidney, nervous system, circulatory system effects
1,2-Dichloropropane	5	Cancer
Ethylbenzene	700	Liver, kidney, nervous system effects
Methylene chloride	5	Cancer
Styrene	100	Liver, nervous systems effects, possible carcinogen
Tetrachloroethylene (PCE)	5	Cancer
Toluene	1,000	Liver, kidney, nervous system, circulatory system effects
Total trihalomethanes		
Chloroform		
Bromoform	100	Cancer
Bromodichloromethane		
Chlorodibromomethane		
1,2,4-Trichlorobenzene	70	Liver, kidney effects
1,1,1-Trichloroethane	200	Liver, nervous system effects
1,1,2-Trichloroethane	5	Kidney, liver effects, possible carcinogen
Trichloroethylene (TCE)	5	Cancer
Vinyl chloride	2	Nervous system, liver effects, cancer

Xylenes (total) 10,000 Liver, kidney, nervous system effects

Disinfection By-products	MCL (ppb)	Potential Health Effects
Bromate	10	Cancer
Chlorate	1,000	Anemia, nervous system effects
Haloacetic Acids (HAA5)*	60	Cancer
Total trihalomethanes (TTHMs)**	80	Cancer

*Haloacetic acids consist of monochloroacetic acid, dichloroacetic acid, trichloroacetic acid, monobromoacetic acid, and dibromoacetic acid.

**Total trihalomethanes consist of chloroform, bromoform, bromodichloromethane, and chlorodibromomethane.

Safe Drinking Water Act (SDWA) Summary

In 1974, Congress passed the Safe Drinking Water Act (SDWA) setting up a regulatory program among local, state, and federal agencies to help ensure the provision of safe drinking water in the U.S. The states are expected to administer and enforce these regulations for public water systems (systems that either have 15 or more service connections or regularly serve an average of 25 or more people daily for at least 60 days each year). Public water systems must provide water treatment, ensure proper drinking water quality through monitoring, and provide public notification of contamination problems.

Relating to prevention of waterborne disease, the SDWA required EPA to:

- 1) set numerical standards, referred to as Maximum Contaminant Levels (MCLs — the highest allowable contaminant concentrations in drinking water) or treatment technique requirements for contaminants in public water supplies;
- 2) issue regulations requiring monitoring of all regulated and certain unregulated contaminants, depending on the number of people served by the system, the source of the water supply, and the contaminants likely to be found;
- 3) set criteria under which systems are obligated to filter water from surface water sources; it must also develop procedures for states to determine which systems have to filter;
- 4) develop disinfection rules for all public water supplies; and
- 5) require all states to develop Wellhead Protection Programs designed to protect from sources of contamination areas around wells that supply public drinking water systems.

Through the Surface Water Treatment Rule (SWTR), EPA has set treatment requirements to control microbiological contaminants in public water systems using surface water sources (and groundwater sources under the direct influence of surface water). These requirements include the following:

- 1) treatment must remove or inactivate at least 99.9% of *Giardia lamblia* cysts and 99.99% of viruses;
- 2) all systems must disinfect, and are required to filter if certain source water quality criteria and site-specific criteria are not met;
- 3) the regulations set criteria for determining if treatment, including turbidity (suspended particulate matter) removal and disinfection requirements, is adequate for filtered systems; and
- 4) all systems must be operated by qualified operators as determined by the states.

Current EPA Research –Barriers to Contamination

Although water treatment and disinfection techniques are quite effective at microbe reduction, finished drinking water is not sterile. Survival and regrowth of microorganisms in drinking water distribution systems can lead to the deterioration of water quality and even noncompliance of a supply.

Regrowth has largely been associated with heterotrophic bacteria (i.e., those bacteria – including pathogens – that require preformed organic compounds as carbon and energy sources).

Bacterial growth occurs on the walls of the distribution system (referred to as “biofilms”) and in the water either as free living cells or cells attached to suspended solids. A multi-faceted phenomenon, bacterial regrowth is influenced primarily by temperature, residence time in mains and storage units, the efficacy of disinfection, and nutrients.

Assimilable Organic Carbon (AOC)

Assimilable organic carbon (AOC) is the portion of the total organic carbon (TOC) dissolved in water that is easily used by microorganisms as a carbon source (i.e., nutrients). Researchers are currently investigating treatment processes to control AOC.

One promising process is biologically active filtration wherein bacterial communities are intentionally established in the filters to use up, or biodegrade, the AOC as it passes through. This treatment process must be employed before final disinfection so that bacteria escaping from the filter can be properly controlled.

Most water utilities do not disinfect with chlorine until late in the treatment train. This limits the formation of disinfection by-products (i.e., those compounds like chloroform produced when chlorine reacts with naturally occurring organic carbon).

To accomplish disinfection earlier in treatment, some water utilities employ ozonation. While ozone is a very strong disinfectant, it also converts a portion of the TOC into AOC. Researchers are examining the advantages (e.g., disinfection of bacteria, viruses and protozoan cysts, control of color, control of taste and odor, enhancement of coagulation, and partial oxidation of the naturally occurring organic carbon that reacts with chlorine) and disadvantages of ozone (e.g., enhancement of AOC, conversion of bromide to bromate, and formation of its own disinfection byproducts like formaldehyde).

EPANET

The project entitled “EPANET” involves the development and testing of a water quality model for drinking water distribution systems. The EPANET model is a computer program that performs extended period simulation of hydraulic and water quality behavior within water distribution networks. It tracks the flow of water in each pipe, the pressure at each pipe junction, the height of water in each tank, and the concentration of a contaminant throughout the network during a multiple time period simulation. Water age and source tracing can also be simulated.

EPANET can be useful for analyzing the loss of disinfectant residual, designing water quality sampling programs, performing drinking water exposure risk assessments, and calibrating network hydraulic models. It can provide insight into how changes in water source utilization, pumping water storage levels, use of satellite treatment and targeted pipe cleaning and replacement would affect drinking water quality. In support of small community and non-community (less than 3,300 people) drinking water treatment systems, researchers are designing, modifying and testing “Hybrid Drinking Water Treatment Package Plants.”

These package plants are factory-built, skid-mounted, and ready to be operated in the field with minimal site preparation. They exhibit lower capital cost than custom designed facilities built onsite and can incorporate any drinking water treatment process. Promising technologies being considered for incorporation include membranes, advanced oxidation, bag filters, and photocatalytic oxidation.

By merging, modifying, and adapting conventional treatment trains with innovative treatment technologies, a broader variety of contaminants (including pathogens) can be removed and SDWA compliance can be facilitated. Concern has recently mounted over the ability of certain pathogenic protozoan (*Cryptosporidium*) cysts to survive treatment processes and enter the distribution system.

Water Quality Post Quiz

The answers for the post quiz are located in the rear before the References.

1. Define TDS?
2. What is the substance or compound forms especially strong complexes with Mn(II), Cu(II), Fe(III), Pb (II) and Cr(III)?
3. Which compound/element can dissolve and accumulate in undergroundwater sources, such as wells, and in the air in your home?
4. The EPA set a standard limit or the amount of what element in drinking water to 10 ppb?
5. Which compound/element/substance is a chemical that occurs naturally in the earth's crust. When rocks, minerals, and soil erode, they release this compound/element/substance into water supplies?

ICR

6. The EPA has collected data required by the Information Collection Rule (ICR) to support future regulation of *Microbial contaminants*, disinfectants, and disinfection byproducts. True or False
7. The rule is intended to provide EPA with information on chemical byproducts that form when disinfectants used for microbial control react with chemicals already present in source water (disinfection byproducts (DBPs)); *Disease-causing microorganisms (pathogens)*, including Cryptosporidium; and engineering data to control these contaminants. True or False

Stage 2 DBP Rule Federal Register Notices

8. Which rule is one part of the Microbial and Disinfection Byproducts Rules, which are a set of interrelated regulations that address risks from microbial pathogens and disinfectants/disinfection byproducts?

9. Which rule focuses on public health protection by limiting exposure to DBPs, specifically total trihalomethanes and five haloacetic acids, which can form in water through disinfectants used to control microbial pathogens?

10. There are specific microbial pathogens, such as _____, which can cause illness, and are highly resistant to traditional disinfection practices.

11. Which rule and the Long Term 2 Enhanced Surface Water Treatment Rule are the second phase of rules required by Congress?

12. Which rule is being promulgated simultaneously with the Long Term 2 Enhanced Surface Water Treatment Rule to address concerns about risk tradeoffs between pathogens and DBPs?

13. Which term requires systems to conduct an evaluation of their distribution systems, known as an Initial Distribution System Evaluation?

Topic 6- Bacteriological Monitoring Section

Section Focus: You will learn the basics of the EPA's Total Coliform Rule and bacteriological sampling. At the end of this section, you will be able to describe the Total Coliform Rule. There is a post quiz at the end of this section to review your comprehension and a final examination in the Assignment for your contact hours.

Scope/Background: The Environmental Protection Agency (EPA) published the Revised Total Coliform Rule (RTCR) in the Federal Register (FR) on February 13, 2013 (78 FR 10269) and minor corrections on February 26, 2014 (79 FR 10665). The RTCR is the revision to the 1989 Total Coliform Rule (TCR) and is intended to improve public health protection. The RTCR applies to all PWSs.

Microbiology Introduction

Microorganisms of greatest significance to water professionals can be classified into four groups:

1. Bacteria - Prokaryotes
2. Protozoans
3. Metazoans
4. Viruses

Each of these groups plays a key role in the complex world of wastewater biology.

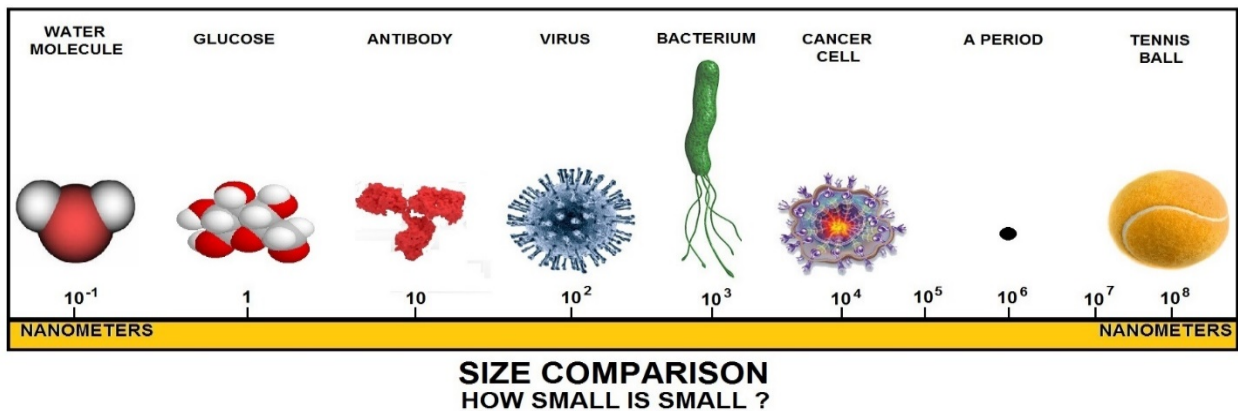

Bacteria Introduction

Bacteria are highly designed creatures formed in a variety of shapes. The simplest shape is a round sphere or ball.

Bacteria formed like this are called cocci (singular coccus). The next simplest shape is cylindrical.

Cylindrical bacteria are called rods (singular rod). Some bacteria are basically rods but instead of being straight they are twisted, bent or curved, sometimes in a spiral. These bacteria are called spirilla (singular spirillum). Spirochaetes are tightly coiled up bacteria.

Organisms Descriptors and Meanings Chart

Description	Meaning
Aerobic	With air
Anaerobic	Without air
Auto	Self (Inorganic carbon)
Facultative	With air or without air
Hetero	Other (Organic carbon)
Troph	Feed or nourish
Photo	Light
Chemo	Chemical
Organo	Organic
Litho	Rock



Coccus



Bacillus



Spirillum

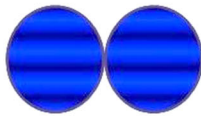

Diplo-

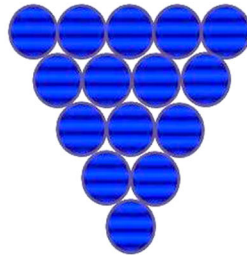

Staphylo-



Strepto-

BASIC BACTERIA SHAPES DIAGRAM

Bacteria Biofilm or Colonies

Bacteria tend to live together in clumps, chains or planes. When they live in chains, one after the other, they are called filamentous bacteria - these often have long thin cells. When they tend to collect in a plane or a thin layer over the surface of an object, they are called a biofilm. Many bacteria exist as a biofilm and the study of biofilms is very important. Biofilm bacteria secrete sticky substances that form a sort of gel in which they live. The plaque on your teeth that causes tooth decay is a biofilm.

Bacteria Diagram

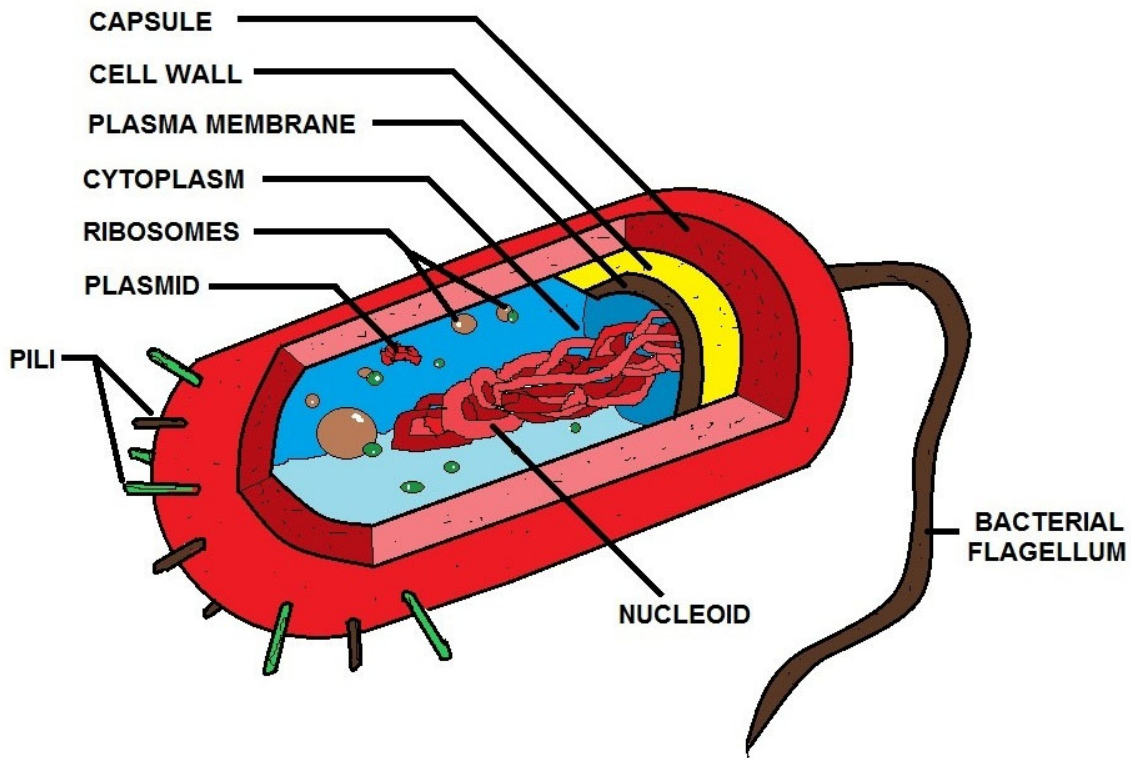

PROKARYOTIC CELL

Above is a typical bacterial cell has a rigid outer coating that gives them structure and maintains their shape. This is the cell wall. Bacteria also have an inner, flexible membrane called the *periplasmic membrane* or *cell membrane*. This dual-layered covering has been compared to a balloon inside a box.

The cell membrane is very important because it controls the intake of food and other nutrients and discharge of waste products. It keeps "in" what needs to be inside (e.g., enzymes, nutrients, and food) and keeps "out" what should be outside (e.g., excess water). The box is the cell wall. The cell wall provides the structural support and maintains the shape of the cell.

Much of the cellular contents are large protein molecules, known as enzymes, which are manufactured by the cell. Other cellular contents may include granules of polyphosphate, sulfur, or stored organic material.

Bacteria are somewhat predictable and, at a basic level, can be compared to miniature combustion engines. For an engine to function, it requires both a fuel and oxygen source. The oxygen sources is used to chemically burn fuel to release energy. The technically correct term for this process is oxidation. The byproducts of combustion when burning organic fuel with oxygen are carbon dioxide (CO₂) and water (H₂O).

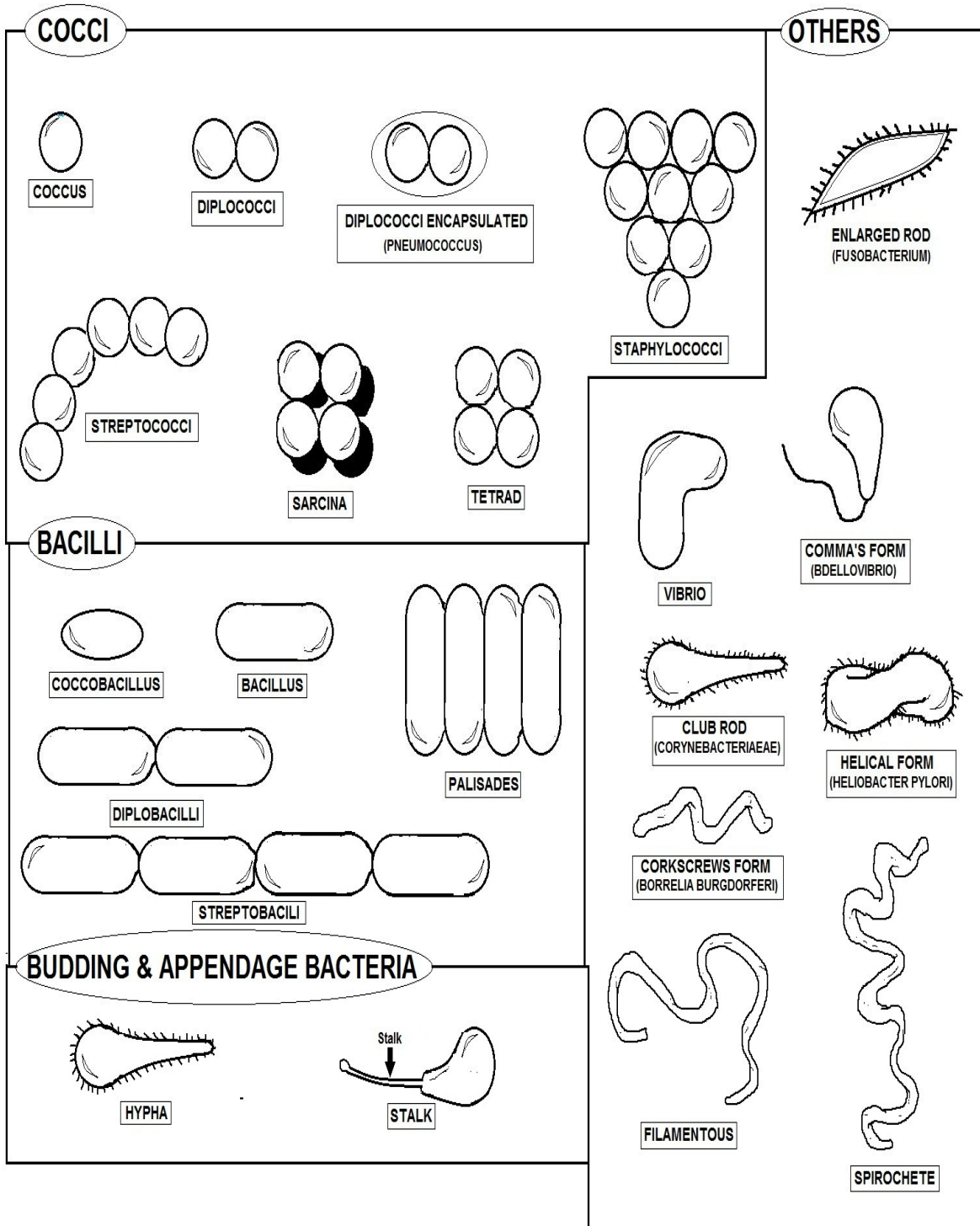

BACTERIA SHAPES

Microbiological Contaminant Information

The sources of drinking water include rivers, lakes, streams, ponds, reservoirs, springs, and wells. As water travels over the surface of the land or through the ground, it dissolves naturally occurring minerals and in some cases, radioactive material, and can pick up substances resulting from the presence of animals or human activity.

Contaminants that may be present in sources of drinking water include:

Microbial contaminants, such as viruses and bacteria, which may come from sewage treatment plants, septic systems, agricultural livestock operations and wildlife;

Inorganic contaminants, such as salts and metals, which can be naturally occurring or result from urban stormwater runoff, industrial or domestic wastewater discharges, oil and gas production, mining or farming;

Pesticides and herbicides, which may come from a variety of sources such as agriculture, urban stormwater run-off, and residential uses;

Organic chemical contaminants, including synthetic and volatile organic chemicals, which are by-products of industrial processes and petroleum production, and can also come from gas stations, urban stormwater run-off, and septic systems;

Radioactive contaminants, which can be naturally occurring or be the result of oil and gas production and mining activities.

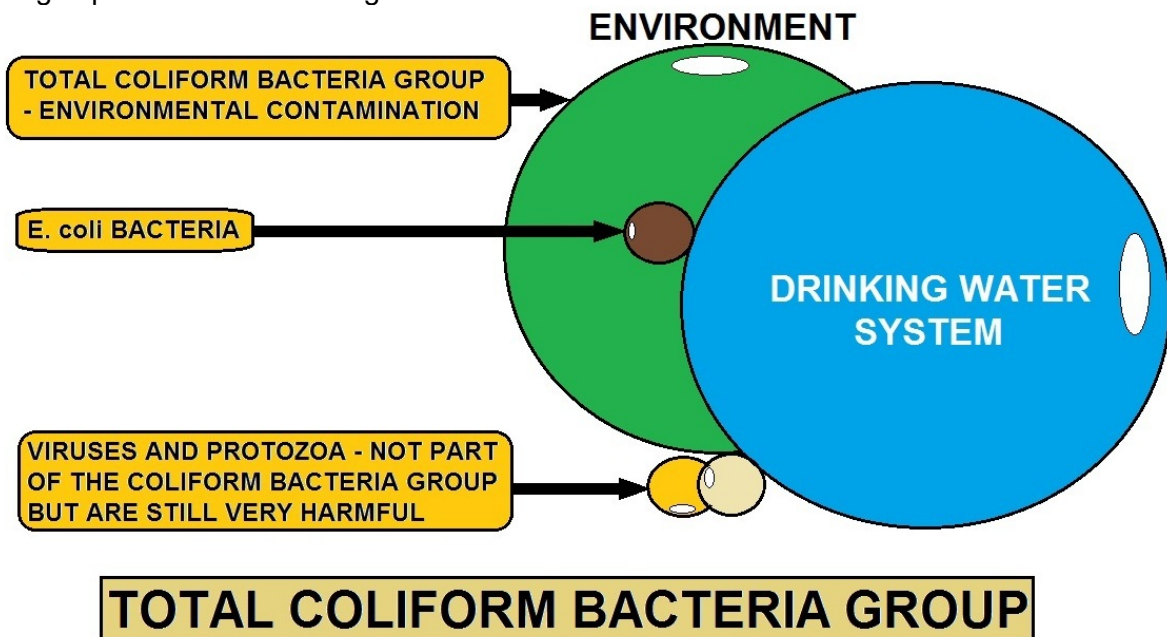

Background

Coliform bacteria and chlorine residual are the only routine sampling and monitoring requirements for small groundwater systems with chlorination. The coliform bacteriological sampling is governed by the Total Coliform Rule (**TCR**) of the SDWA. Although there is presently no requirement for chlorination of groundwater systems under the SDWA, State regulations require chlorine residual monitoring of those systems that do chlorinate the water.

TCR

The TCR requires all Public Water Systems (**PWS**) to monitor their distribution system for coliform bacteria according to the written sample sitting plan for that system. The sample sitting plan identifies sampling frequency and locations throughout the distribution system that are selected to be representative of conditions in the entire system.

Coliform contamination can occur anywhere in the system, possibly due to problems such as; low pressure conditions, line breaks, or well contamination, and therefore routine monitoring is required. A copy of the sample sitting plan for the system should be kept on file and accessible to all who are involved in the sampling for the water system.

Number of Monthly Samples

The number of samples to be collected monthly depends on the size of the system. The TCR specifies the minimum number of coliform samples collected, but it may be necessary to take more than the minimum number in order to provide adequate monitoring.

This is especially true if the system consists of multiple sources, pressure zones, booster pumps, long transmission lines, or extensive distribution system piping. Since timely detection of coliform contamination is the purpose of the sample-sitting plan, sample sites should be selected to represent the varying conditions that exist in the distribution system. The sample sitting plan should be updated as changes are made in the water system, especially the distribution system.

Sampling Procedures

The sample-sitting plan must be followed and all operating staff must be clear on how to follow the sampling plan. In order to properly implement the sample-sitting plan, staff must be aware of how often sampling must be done, the proper procedures and sampling containers to be used for collecting the samples, and the proper procedures for identification, storage and transport of the samples to an approved laboratory. In addition, proper procedures must be followed for repeat sampling whenever a routine sample result is positive for total coliform.

Routine Sampling Requirements

Total coliform samples must be collected by PWSs at sites which are representative of water quality throughout the distribution system according to a written sample sitting plan subject to state review and revision.

For PWSs collecting more than one sample per month, collect total coliform samples at regular intervals throughout the month, except that groundwater systems serving 4,900 or fewer people may collect all required samples on a single day if the samples are taken from different sites.

Each total coliform-positive (TC+) routine sample must be tested for the presence of E. coli.

- ▶ If any TC+ sample is also E. coli-positive (EC+), then the EC+ sample result must be reported to the state by the end of the day that the PWS is notified.
- ▶ If any routine sample is TC+, repeat samples are required. – PWSs on quarterly or annual monitoring must take a minimum of three additional routine samples (known as additional routine monitoring) the month following a TC+ routine or repeat sample.
- ▶ Reduced monitoring may be available for PWSs using only groundwater and serving 1,000 or fewer persons that meet certain additional PWS criteria.

Coliform Bacteria Introduction

Total coliforms are a group of related bacteria that are (with few exceptions) not harmful to humans. A variety of bacteria, parasites, and viruses, known as pathogens, can potentially cause health problems if humans ingest them. EPA considers total coliforms a useful indicator of other pathogens for drinking water because they are easier to measure and associate with water contamination.

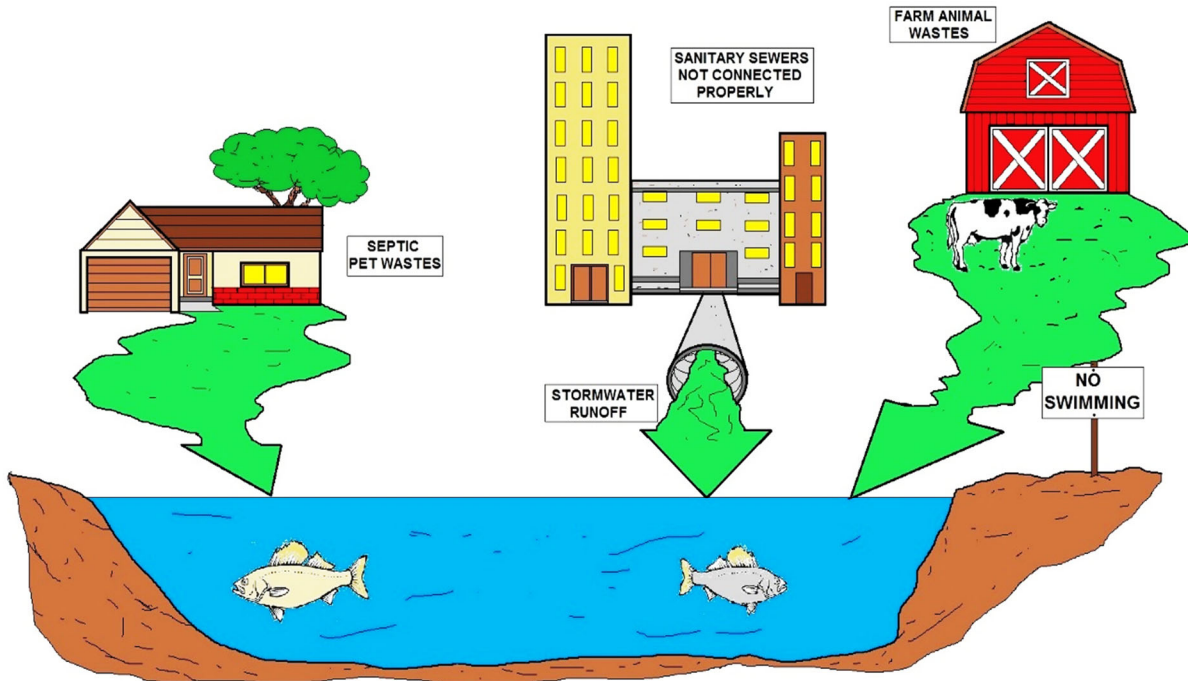

SOURCES OF FECAL COLIFORM BACTERIA

Total coliforms are used to determine the adequacy of water treatment and the integrity of the distribution system.

All bacteriological samples are analyzed for the coliform group; however, a positive reaction to these coliform analyses may be from sources other than fecal. In order to differentiate between these sources, all samples that are total coliform positive must be analyzed again to determine if fecal coliform or *E. coli* are present.

Key provisions of the RTCR include:

- Setting a maximum contaminant level goal (MCLG) and maximum contaminant level (MCL) for *E. coli* for protection against potential fecal contamination.
- Setting a total coliform treatment technique (TT) requirement.
- Requirements for monitoring total coliforms and *E. coli* according to a sample siting plan and schedule specific to the PWS.
- Provisions allowing PWSs to transition to the RTCR using their existing Total Coliform Rule (TCR) monitoring frequency, including PWSs on reduced monitoring under the existing TCR.

- Requirements for seasonal systems (such as Non-Community Water Systems not operated on a year-round basis) to monitor and certify the completion of a state-approved start-up procedures.
- Requirements for assessments and corrective action when monitoring results show that PWSs may be vulnerable to contamination.
- Public notification (PN) requirements for violations.
- Specific language for CWSs to include in their Consumer Confidence Reports (CCRs) when they must conduct an assessment or if they incur an E. coli MCL violation.

TCR Key Provisions

- To comply with the monthly MCL for total coliforms (TC), PWSs must not find coliforms in more than five percent of the samples they take each month to meet EPA’s standards. If more than five percent of the samples contain coliforms, PWS operators must report this violation to the state and the public.
- If a sample tests positive for TC, the system must collect a set of repeat samples located within 5 or fewer sampling sites adjacent to the location of the routine positive sample within 24 hours.
- When a routine or repeat sample tests positive for total coliforms, it must also be analyzed for fecal coliforms or E. coli, which are types of coliform bacteria that are directly associated with feces. A positive result for fecal coliforms or E. coli can signify an acute MCL violation, which necessitates rapid state and public notification because it represents a direct health risk.
- At times, an acute violation due to the presence of fecal coliform or E. coli may result in a “boil water” notice. The system must also take at least 5 routine samples the next month of operation if any sample tests positive for total coliforms.

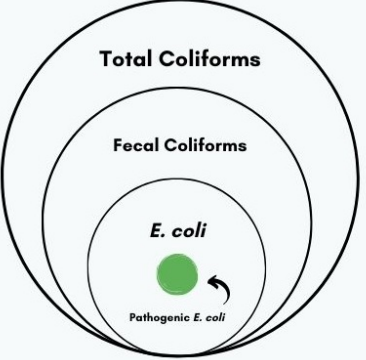
<p style="text-align: center;">TOTAL COLIFORM RULE (TCR) REVISIONS</p> <p>REVISED TOTAL COLIFORM RULE (RTCR) THIS REVISES THE 1989 TOTAL COLIFORM RULE (TCR) AND IS INTENDED TO IMPROVE PUBLIC HEALTH PROTECTION. THIS ESTABLISHED A "FIND-AND-FIX" APPROACH FOR INVESTIGATING AND CORRECTING CAUSES OF COLIFORM PROBLEMS WITHIN WATER DISTRIBUTION SYSTEMS.</p> <p>THE MAXIMUM CONTAMINANT LEVEL (MCL) FOR BACTERIA IN DRINKING WATER IS ZERO TOTAL COLIFORM COLONIES PER 100 MILLILITERS OF WATER.</p> <p>BEGINNING JULY 1st, 2021, ALL RESAMPLES SUBMITTED IN RESPONSE TO A PREVIOUS POSITIVE COLIFORM RESULT MUST BE ANALYZED TO DETERMINE COLIFORM AND E.coli DENSITY</p>	<p style="text-align: center;">Coliforms Explained</p> 
---	--



TOTAL COLIFORM RULE (TCR) REVISIONS

All public water systems (PWSs), except aircraft PWSs subject to the Aircraft Drinking Water Rule (ADWR) (40 CFR 141 Subpart X), must comply with the RTCR starting April 1, 2016, or an earlier state effective date. Until then, PWSs must continue complying with the 1989 TCR.

Related and Dangerous Waterborne Microbes

Coliform Bacteria are common in the environment and are generally not harmful. However, the presence of these bacteria in drinking water are usually a result of a problem with the treatment system or the pipes which distribute water, and indicates that the water may be contaminated with germs that can cause disease.

Fecal Coliform and E. coli are bacteria whose presence indicates that the water may be contaminated with human or animal wastes. Microbes in these wastes can cause short-term effects, such as diarrhea, cramps, nausea, headaches, or other symptoms.

Cryptosporidium is a parasite that enters lakes and rivers through sewage and animal waste. It causes cryptosporidiosis, a mild gastrointestinal disease. However, the disease can be severe or fatal for people with severely weakened immune systems. The EPA and CDC have prepared advice for those with severely compromised immune systems who are concerned about **Cryptosporidium**.

Giardia lamblia is a parasite that enters lakes and rivers through sewage and animal waste. It causes gastrointestinal illness (e.g. diarrhea, vomiting, and cramps).

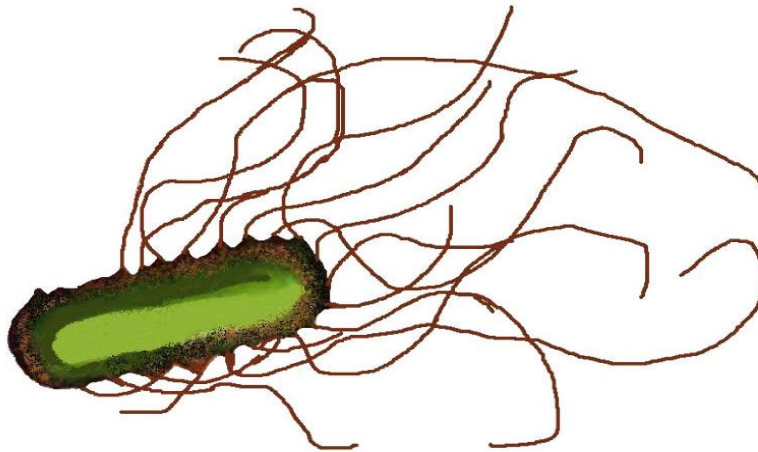

PERITRICHOUS SHAPED BACTERIA EXAMPLE

Microbiologists broadly classify bacteria according to their shape: spherical, rod-shaped, and spiral-shaped. Pleomorphic bacteria can assume a variety of shapes. Bacteria may be further classified according to whether they require oxygen (aerobic or anaerobic) and how they react to a test with Gram's stain.

Bacteria in which alcohol washes away Gram's stain are called gram-negative, while bacteria in which alcohol causes the bacteria's walls to absorb the stain are called gram-positive.

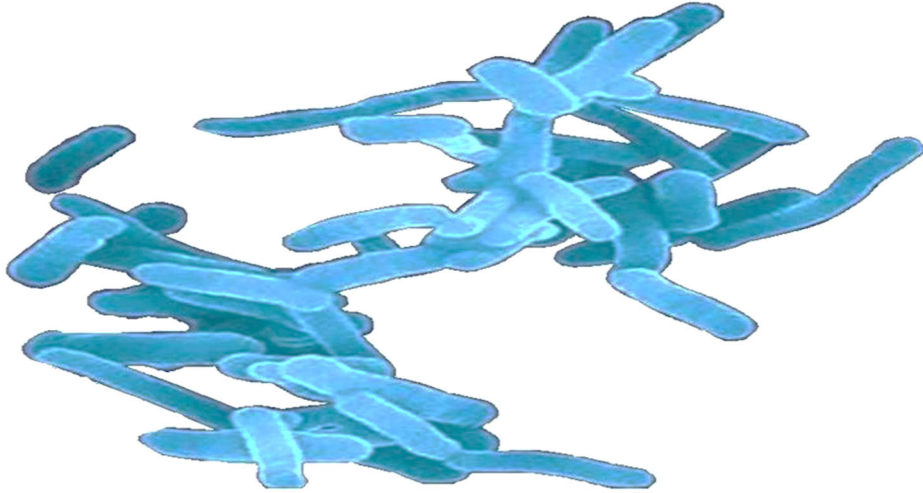

SHIGELLA DYSENTERIAE EXAMPLE

Shigella dysenteriae is a species of the rod-shaped bacterial genus Shigella. Shigella can cause shigellosis (bacillary dysentery). Shigellae are Gram-negative, non-spore-forming, facultatively anaerobic, non-motile bacteria.

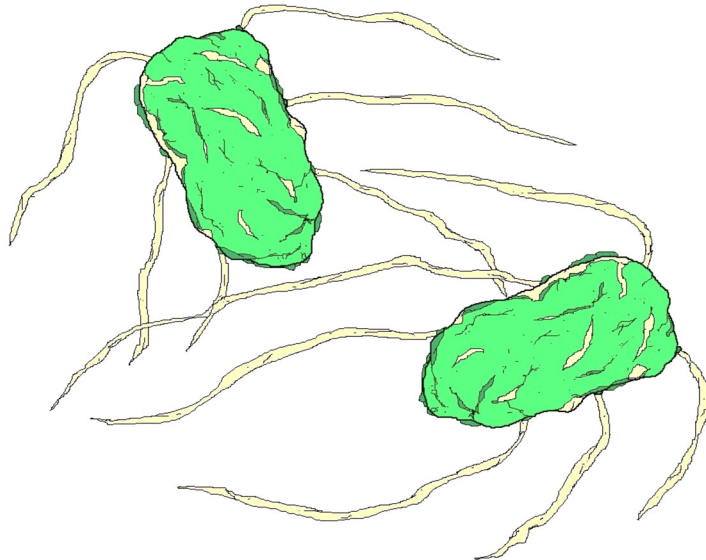

SALMONELLA EXAMPLE

Salmonellae usually do not ferment lactose; most of them produce hydrogen sulfide that in media containing ferric ammonium citrate reacts to form a black spot in the center of the creamy colonies.

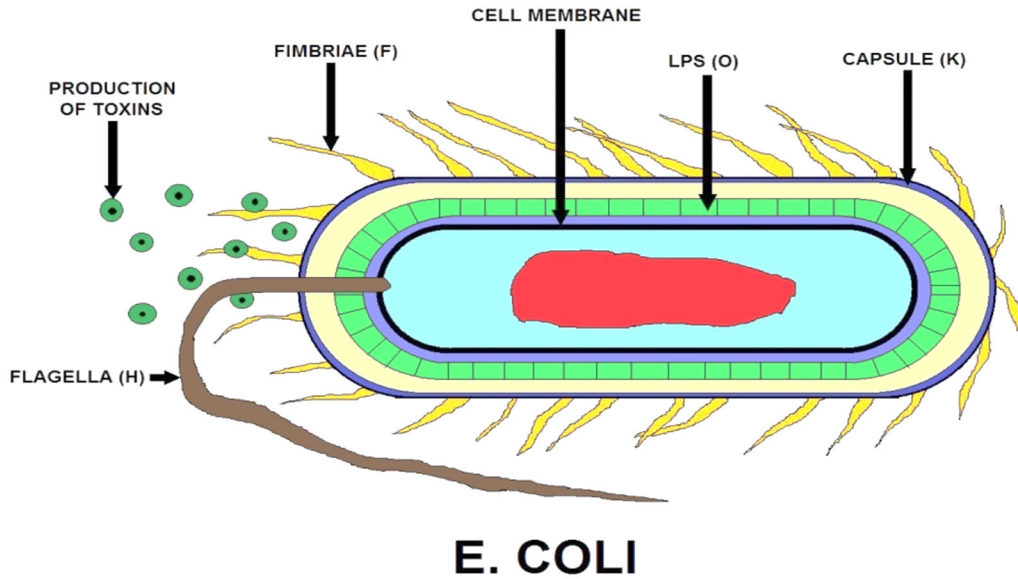

Fecal Coliform Bacteria

Fecal coliform bacteria are microscopic organisms that live in the intestines of warm-blooded animals. They also live in the waste material, or feces, excreted from the intestinal tract. When fecal coliform bacteria are present in high numbers in a water sample, it means that the water has received fecal matter from one source or another. Although not necessarily agents of disease, fecal coliform bacteria may indicate the presence of disease-carrying organisms, which live in the same environment as the fecal coliform bacteria.

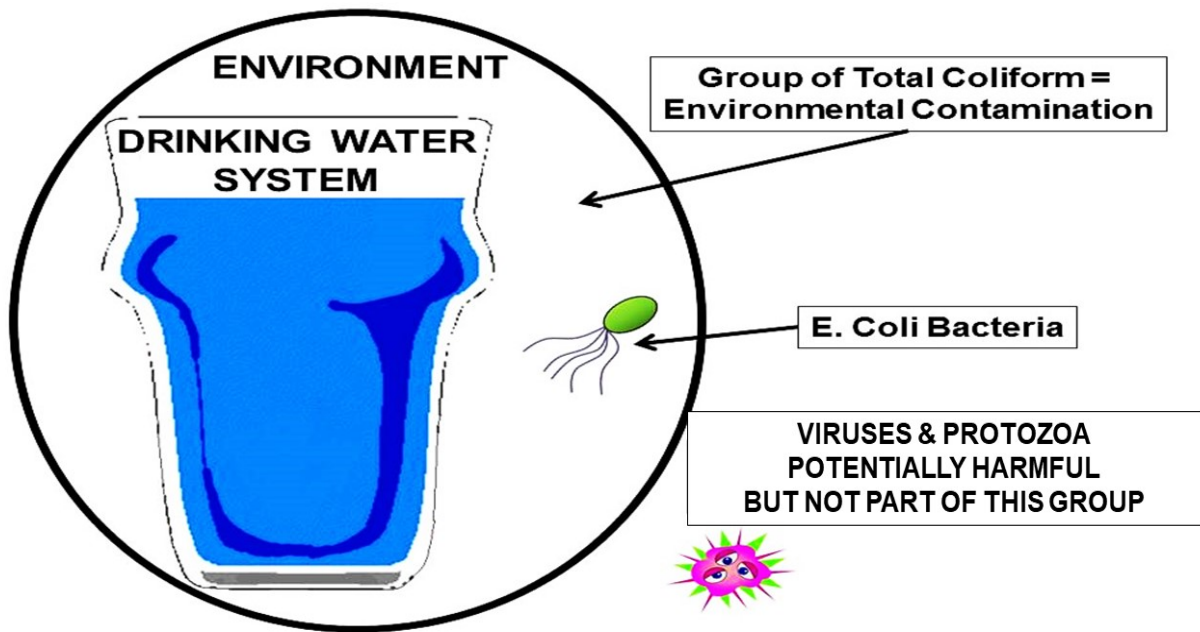

GROUP OF TOTAL COLIFORM BACTERIA

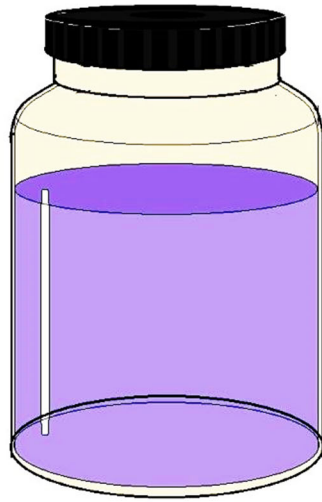

COLIFORM POSITIVE
SAMPLE

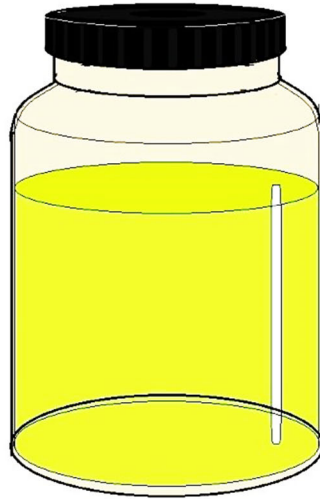

COLIFORM NEGATIVE
SAMPLE

COLIFORM BACTERIA PRESENCE TEST EXAMPLE

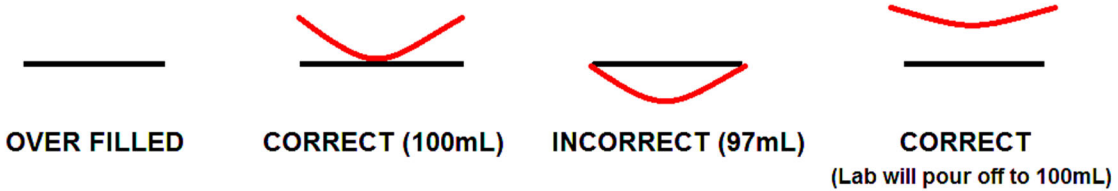
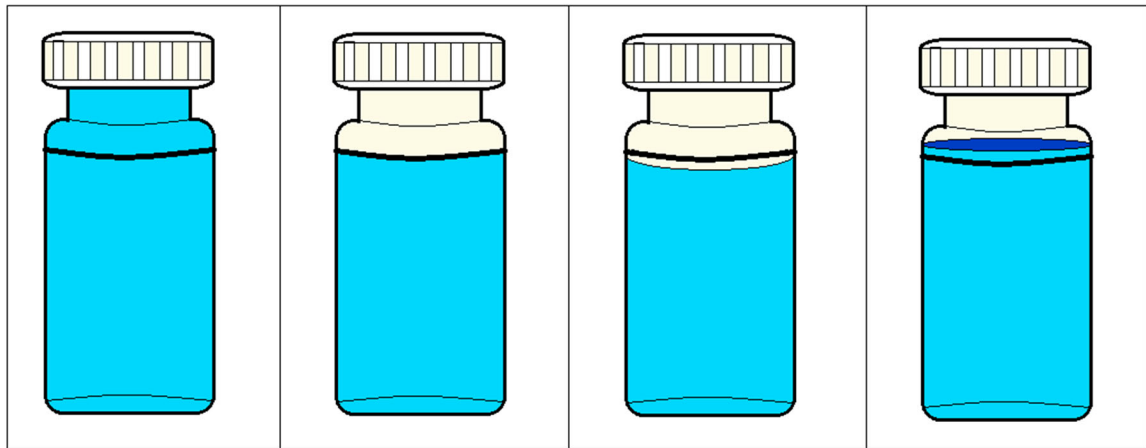

BAC-T SAMPLE BOTTLE DIAGRAM

Bacteriological Monitoring Introduction

Most waterborne diseases and illnesses have been related to the microbiological quality of drinking water. The routine microbiological analysis of your water is for coliform bacteria. The coliform bacteria group is used as an indicator organism to determine the biological quality of your water. The presence of an indicator or pathogenic bacteria in your drinking water is an important health concern. Indicator bacteria signal possible fecal contamination, and therefore, the potential presence of pathogens. They are used to monitor for pathogens because of the difficulties in determining the presence of specific disease-causing microorganisms.

Indicator bacteria are usually harmless, occur in high densities in their natural environment, and are easily cultured in relatively simple bacteriological media. Indicators in common use today for routine monitoring of drinking water include total coliforms, fecal coliforms, and *Escherichia coli* (*E. coli*).



Bacteria Sampling - 1 Example

Water samples for bacteria tests must always be collected in a sterile container. Take the sample from an outside faucet with the aerator removed. Sterilize by spraying a 5% Household bleach or alcohol solution or flaming the end of the tap with a propane torch. Run the water for five minutes to clear the water lines and bring in fresh water. Do not touch or contaminate the inside of the bottle or cap. Carefully open the sample container and hold the outside of the cap. Fill the container and replace the top. Refrigerate the sample and transport it to the testing laboratory within six hours (in an ice chest). Many labs will not accept bacteria samples on Friday so check the lab's schedule. Mailing bacteria samples is not recommended because laboratory analysis results are not as reliable. Iron bacteria forms an obvious slime on the inside of pipes and fixtures. A water test is not needed for identification. Check for a reddish-brown slime inside a toilet tank or where water stands for several days.

Bac-T Sample Bottle Often referred to as a Standard Sample, 100 mls, notice the white powder inside the bottle. That is Sodium Thiosulfate, a de-chlorination agent. Be careful not to wash-out this chemical while sampling. Notice the custody seal on the bottle.

Coliform bacteria are common in the environment and are generally not harmful. However, the presence of these bacteria in drinking water is usually a result of a problem with the treatment system or the pipes which distribute water, and indicates that the water may be contaminated with germs that can cause disease.

Laboratory Procedures

The laboratory may perform the total coliform analysis in one of four methods approved by the U.S. EPA and your local environmental or health division:

Methods

The MMO-MUG test, a product marketed as Colilert, is the most common. The sample results will be reported by the laboratories as simply coliforms present or absent. If coliforms are present, the laboratory will analyze the sample further to determine if these are fecal coliforms or *E. coli* and report their presence or absence.

Microbial Regulations

One of the key regulations developed and implemented by the United States Environmental Protection Agency (USEPA) to counter pathogens in drinking water is the Surface Water Treatment Rule.

Among its provisions, the rule requires that a public water system, using surface water (or groundwater under the direct influence of surface water) as its source, have sufficient treatment to reduce the source water concentration of *Giardia* and viruses by at least 99.9% and 99.99%, respectively. The Surface Water Treatment Rule specifies treatment criteria to assure that these performance requirements are met; they include turbidity limits, disinfectant residual and disinfectant contact time conditions.

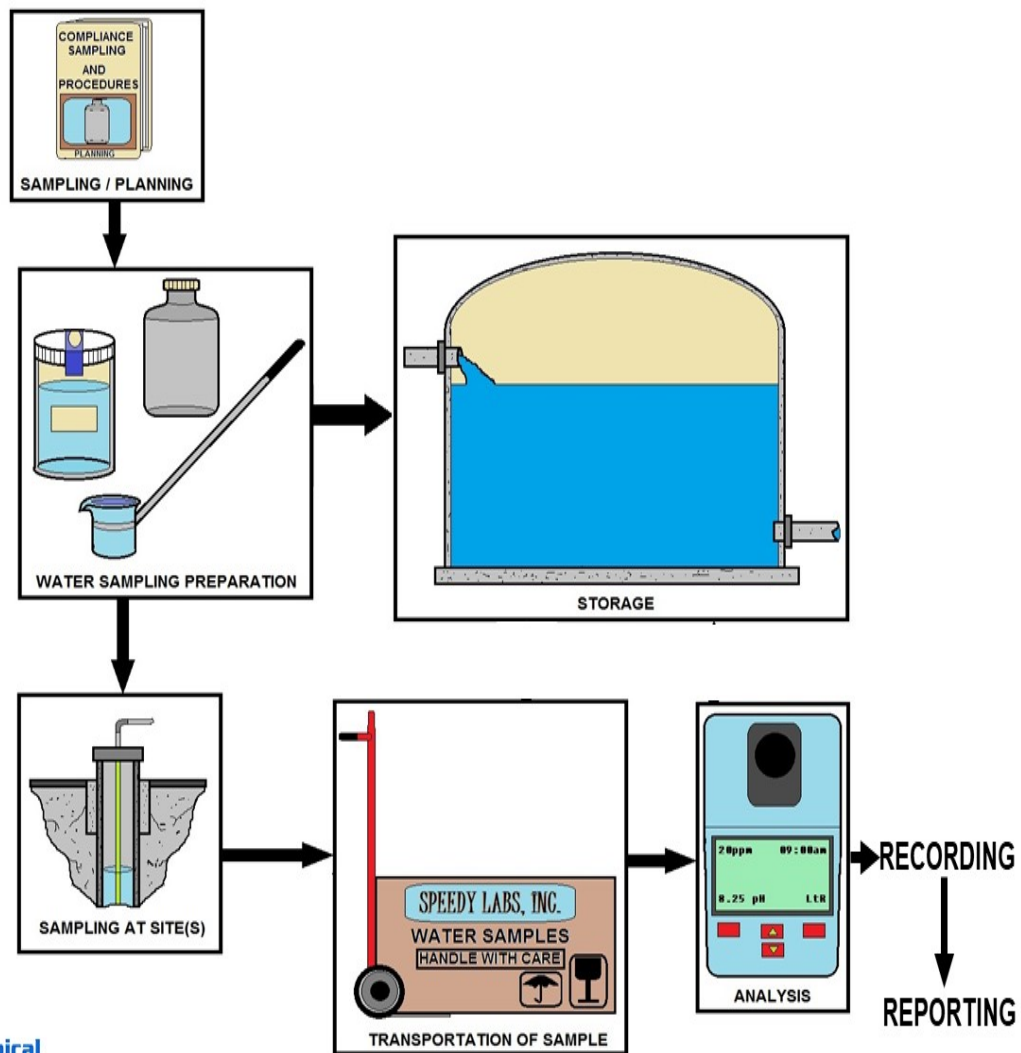

WATER SAMPLING FLOW CHART

Basic Types of Bac-T Water Samples

It is important to properly identify the type of sample you are collecting. Please indicate in the space provided on the laboratory form the type of sample.

The three (3) primary types of samples are:

1. **Routine:** Samples collected on a routine basis to monitor for contamination. Collection should be in accordance with an approved sampling plan.

2. **Repeat:** Samples collected following a '**coliform present**' routine sample. The number of repeat samples to be collected is based on the number of routine samples you normally collect.

3. **Special:** Samples collected for other reasons.

Examples would be a sample collected after repairs to the system and before it is placed back into operation or a sample collected at a wellhead prior to a disinfection injection point.

a. **Trigger: Level 1 Assessment** is triggered if any one of the following occurs:

- ▶ A PWS collecting fewer than 40 samples per month has 2 or more TC+ routine/repeat samples in the same month.
- ▶ A PWS collecting at least 40 samples per month has greater than 5.0 percent of the routine/repeat samples in the same month that are TC+.
- ▶ A PWS fails to take every required repeat sample after any single TC+ sample

b. **Trigger: Level 2 Assessment** is triggered if any one of the following occurs:

- ▶ A PWS incurs an E. coli MCL violation.
- ▶ A PWS has a second Level 1 Assessment within a rolling 12-month period.
- ▶ A PWS on state-approved annual monitoring has a Level 1 Assessment trigger in 2 consecutive years.

Routine Coliform Sampling

The number of routine samples and frequency of collection for community public water systems is shown in Table 3-1 below.

Noncommunity and nontransient noncommunity public water systems will sample at the same frequency as a like sized community public water system if:

1. It has more than 1,000 daily population and has groundwater as a source, or
2. It serves 25 or more daily population and utilizes surface water as a source or groundwater under the direct influence of surface water as its source.

Noncommunity and nontransient, noncommunity water systems with less than 1,000 daily population and groundwater as a source will sample on a quarterly basis.

No. of Samples per System Population

Persons served - Samples per month

<u>up to 1,000</u>	<u>1</u>
<u>1,001-2,500</u>	<u>2</u>
<u>2,501-3,300</u>	<u>3</u>
<u>3,301 to 4,100</u>	<u>4</u>
<u>4,101 to 4,900</u>	<u>5</u>
<u>4,901 to 5,800</u>	<u>6</u>
<u>5,801 to 6,700</u>	<u>7</u>
<u>6,701 to 7,600</u>	<u>8</u>
<u>7,601 to 8,500</u>	<u>9</u>
<u>8,501 to 12,900</u>	<u>10</u>
<u>12,901 to 17,200</u>	<u>15</u>
<u>17,201 to 21,500</u>	<u>20</u>
<u>21,501 to 25,000</u>	<u>25</u>
<u>25,001 to 33,000</u>	<u>30</u>
<u>33,001 to 41,000</u>	<u>40</u>
<u>41,001 to 50,000</u>	<u>50</u>
<u>50,001 to 59,000</u>	<u>60</u>
<u>59,001 to 70,000</u>	<u>70</u>
<u>70,001 to 83,000</u>	<u>80</u>
<u>83,001 to 96,000</u>	<u>90</u>
<u>96,001 to 130,000</u>	<u>100</u>
<u>130,001 to 220,000</u>	<u>120</u>
<u>220,001 to 320,000</u>	<u>150</u>
<u>320,001 to 450,000</u>	<u>180</u>
<u>450,001 to 600,000</u>	<u>210</u>
<u>600,001 to 780,000</u>	<u>240</u>



Repeat Sampling Introduction

Repeat sampling replaces the old check sampling with a more comprehensive procedure to try to identify problem areas in the system. Whenever a routine sample has total coliform or fecal coliform present, a set of repeat samples must be collected within 24 hours after being notified by the laboratory. The follow-up for repeat sampling is:

1. If only one routine sample per month or quarter is required, four (4) repeat samples must be collected.
2. For systems collecting two (2) or more routine samples per month, three (3) repeat samples must be collected.
3. Repeat samples must be collected from:
 - a. The original sampling location of the coliform present sample.
 - b. Within five (5) service connections upstream from the original sampling location.
 - c. Within five (5) service connections downstream from the original sampling location.
 - d. Elsewhere in the distribution system or at the wellhead, if necessary.
4. If the system has only one service connection, the repeat samples must be collected from the same sampling location over a four-day period or on the same day.
5. All repeat samples are included in the MCL compliance calculation.
6. If a system which normally collects fewer than five (5) routine samples per month has a coliform present sample, it must collect five (5) routine samples the following month or quarter regardless of whether an MCL violation occurred or if repeat sampling was coliform absent.

Positive or Coliform Present Results

What do you do when your sample is positive or coliform present?

When you are notified of a positive test result you need to contact either the Drinking Water Program or your local county health department within 24 hours, or by the next business day after the results are reported to you. The Drinking Water Program contracts with many of the local health departments to provide assistance to water systems.

After you have contacted an agency for assistance, you will be instructed as to the proper repeat sampling procedures and possible corrective measures for solving the problem. It is very important to initiate the repeat sampling immediately as the corrective measures will be based on those results.



Some examples of typical corrective measures to coliform problems are:

1. Shock chlorination of a groundwater well. The recommended dose of 5% household bleach is 2 cups per 100 gallons of water in the well. This should be done anytime the well is opened for repair (pump replacement, etc.). If you plan to shock the entire system, calculate the total gallonage of storage and distribution.
2. Conduct routine distribution line flushing. Install blowoffs on all dead end lines.
3. Conduct a cross connection program to identify all connections with non-potable water sources. Eliminate all of these connections or provide approved backflow prevention devices.
4. Upgrade the wellhead area to meet current construction standards as set by your state environmental or health agency.
5. If you continuously chlorinate, review your operation and be sure to maintain a detectable residual (0.2 mg/l free chlorine) at all times in the distribution system.
6. Perform routine cleaning of the storage system.

This list provides some basic operation and maintenance procedures that could help eliminate potential bacteriological problems, check with your state drinking water section or health department for further instructions.

Maximum Contaminant Levels (MCLs)

State and federal laws establish standards for drinking water quality. Under normal circumstances when these standards are being met, the water is safe to drink with no threat to human health. These standards are known as maximum contaminant levels (**MCL**). When a particular contaminant exceeds its MCL a potential health threat may occur.

The MCLs are based on extensive research on toxicological properties of the contaminants, risk assessments and factors, short term (**acute**) exposure, and long term (**chronic**) exposure. You conduct the monitoring to make sure your water is in compliance with the MCL.

There are two types of MCL violations for coliform bacteria. The first is for total coliform; the second is an acute risk to health violation characterized by the confirmed presence of fecal coliform or *E. coli*.

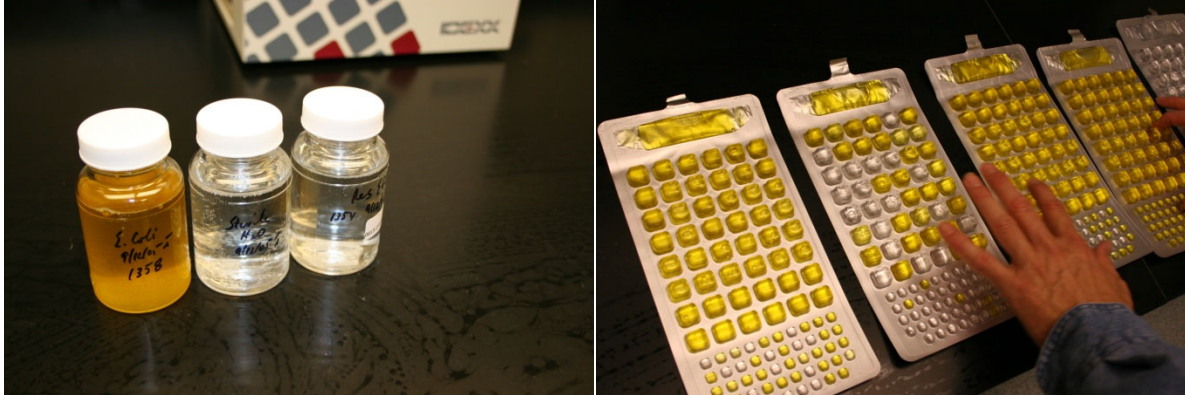

Looking under a black light to identify the presence of E. coli.

Colilert tests simultaneously detect and confirm coliform and E. coli in water samples in 24 hours or less.

Simply add the Colilert reagent to the sample, incubate for 24 hours, and read results.

Colilert is easy to read, as positive coliform samples turn yellow or blue, and when E. coli is present, samples fluoresce under UV light.

Heterotrophic Plate Count - Introduction

Heterotrophic organisms utilize organic compounds as their carbon source (food or substrate). In contrast, autotrophic organisms use inorganic carbon sources. The Heterotrophic Plate Count provides a technique to quantify the bacteriological activity of a sample. The R2A agar provides a medium that will support a large variety of heterotrophic bacteria. After an incubation period, a bacteriological colony count provides an estimate of the concentration of heterotrophs in the sample of interest.

Heterotrophic Plate Count (HPC) --- formerly known as the standard plate count, is a procedure for estimating the number of live heterotrophic bacteria and measuring changes during water treatment and distribution in water or in swimming pools. Colonies may arise from pairs, chains, clusters, or single cells, all of which are included in the term "*colony-forming units*" (CFU).

Method:

There are three methods for standard plate count:

1. Pour Plate Method

The colonies produced are relatively small and compact, showing less tendency to encroach on each other than those produced by surface growth. On the other hand, submerged colonies often are slower growing and are difficult to transfer.

2. Spread Plate Method

All colonies are on the agar surface where they can be distinguished readily from particles and bubbles. Colonies can be transferred quickly, and colony morphology can be easily discerned and compared to published descriptions. See next page

3. Membrane Filter Method

This method permits testing large volumes of low-turbidity water and is the method of choice for low-count waters.

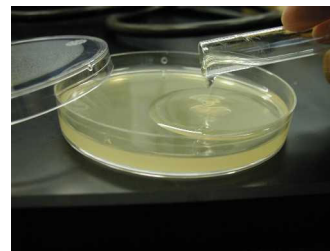

Material

- i) Apparatus
 - Glass rod
 - Erlenmeyer flask
 - Graduated Cylinder
 - Pipette
 - Petri dish
 - Incubator
- ii) Reagent and sample
 - Reagent-grade water
 - Nutrient agar
 - Sample

Procedure*

1. Boil mixture of nutrient agar and nutrient broth for 15 minutes, then cool for about 20 minutes.
2. Pour approximately 15 ml of medium in each Petri dish, let medium solidify.

3. Pipette 0.1 ml of each dilution onto surface of pre-dried plate, starting with the highest dilution.
4. Distribute inoculum over surface of the medium using a sterile bent glass rod.
5. Incubate plates at 35°C for 48h.
6. Count all colonies on selected plates promptly after incubation, consider only plates having 30 to 300 colonies in determining the plate count.

*Duplicate samples

Computing and Reporting

Compute bacterial count per milliliter by the following equation:

CFU/ml = colonies counted / actual volume of sample in dish a) If there is no plate with 30 to 300 colonies, and one or more plates have more than 300 colonies, use the plate(s) having a count nearest 300 colonies.

b) If plates from all dilutions of any sample have no colony, report the count as less than 1/actual volume of sample in dish estimated CFU/ml.

c) Avoid creating fictitious precision and accuracy when computing CFU by recording only the first two left-hand digits.

Heterotrophic Plate Count (Spread Plate Method)

Laboratory Equipment Needed

100 x 15 Petri Dishes

Turntable

Glass Rods: Bend fire polished glass rod 45 degrees about 40 mm from one end. Sterilize before using.

Pipette: Glass, 1.1 mL. Sterilize before using.

Quebec Colony Counter

Hand Tally Counter

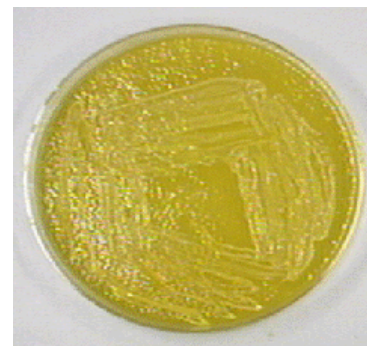

Reagents

1) R2A Agar: Dissolve and dilute 0.5 g of yeast extract, 0.5 g of proteose peptone No. 3, 0.5 g of casamino acids, 0.5 g of glucose, 0.5 g of soluble starch, 0.3 g of dipotassium hydrogen phosphate, 0.05 g of magnesium sulfate heptahydrate, 0.3 g of sodium pyruvate, 15.0 g of agar to 1 L. Adjust pH to 7.2 with dipotassium hydrogen phosphate **before adding agar**. Heat to dissolve agar and sterilize at 121 C for 15 minutes.

2) Ethanol: As needed for flame sterilization.

Preparation of Spread Plates

Immediately after agar sterilization, pour 15 mL of R2A agar into sterile 100 x 15 Petri dishes; let agar solidify. Pre-dry plates inverted so that there is a 2 to 3 g water loss overnight with the lids on. Use pre-dried plates immediately or store up to two weeks in sealed plastic bags at 4°C.

Sample Preparation

Mark each plate with sample type, dilution, date, and any other information before sample application.

Prepare at least duplicate plates for each volume of sample or dilution examined.

Thoroughly mix all samples by rapidly making about 25 complete up-and-down movements.

Sample Application

Uncover pre-dried agar plate. Minimize time plate remains uncovered. Pipette 0.1 or 0.5 mL sample onto surface of pre-dried agar plate.

Record Volume of Sample Used.

Using a sterile bent glass rod, distribute the sample over surface of the medium by rotating the dish by hand on a turntable. Let the sample be absorbed completely into the medium before incubating. Put cover back on Petri dish and invert for duration of incubation time. Incubate at 28°C for 7 days. Remove Petri dishes from incubator for counting.



Counting and Recording

After incubation period, promptly count all colonies on the plates. To count, uncover plate and place on Quebec colony counter. Use a hand tally counter to maintain count. Count all colonies on the plate, regardless of size. Compute bacterial count per milliliter by the following equation:

$$\text{CFU/mL} = \frac{\text{colonies counted}}{\text{actual volume of sample in dish, mL}}$$

To report counts on a plate with no colonies, report the count as less than one (<1) divided by the sample volume put on that plate (remember to account for any dilution of that sample).

If plates of all dilutions for a sample have no colonies, report the count as less than one (<1) divided by the largest sample volume used. Example: if 0.1 mL of a 100:1 and 10000:1 dilution of a sample both turned up with no colonies formed, the reported result would be <1 divided by the largest sample volume 0.001 mL (0.1 mL divided by 100). The final reported result for the sample is <1000 CFU per mL.

Assignment

1. Report the number of colony forming units (**CFU**) found on each plate.
2. Calculate the **CFU** per mL for each plate.
3. The aim of diluting samples is to produce a plate having 30 to 300 colonies, which plates meet these criteria. If no sample produces a plate with a count in this range, use the plate(s) with a count closest to 300. Based on these criteria, use your calculated results to report the CFU per mL for each sample.

In the conclusion of your lab report, comment on your final results for each sample type as well as the quality of your application of this analysis technique. Feel free to justify your comments using statistical analysis. Also, comment on the general accuracy of this analytical technique and the factors that affect its accuracy and or applicability.

Data Table for Samples

Sample ID	Volume of Sample, mL	Colonies Counted per plate

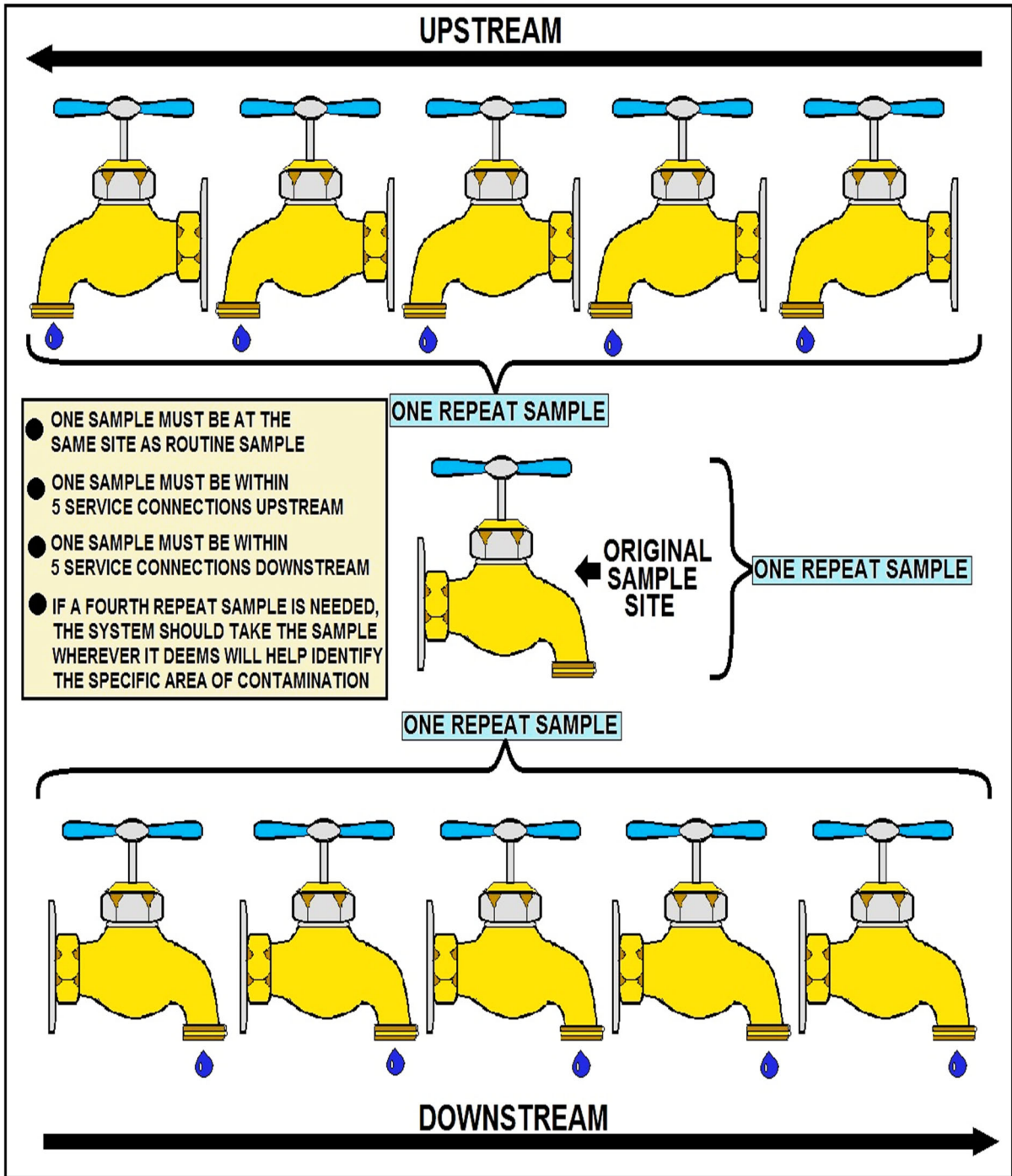

EXAMPLE OF WHAT HAS TO BE DONE IF A PRESENCE OF COLIFORMS ARE DETECTED WHEN CONDUCTING ROUTINE SAMPLES AT DESIGNATED SAMPLE SITES

Total Coliforms

This MCL is based on the presence of total coliforms, and compliance is on a monthly or quarterly basis, depending on your water system type and state rule. For systems which collect *fewer* than 40 samples per month, no more than one sample per month may be positive. In other words, the second positive result (repeat or routine) in a month or quarter results in an MCL violation.

For systems which collect 40 or more samples per month, no more than five (5) percent may be positive. Check with your state drinking water section or health department for further instructions.

Acute Risk to Health (Fecal Coliforms and E. coli)

An acute risk to human health violation occurs if either one of the following happen:

1. A routine analysis shows total coliform present and is followed by a repeat analysis which indicates fecal coliform or E. coli present.

2. A routine analysis shows total and fecal coliform or E. coli present and is followed by a repeat analysis which indicates total coliform present.

An acute health risk violation requires the water system to provide public notice via radio and television stations in the area. This type of contamination can pose an immediate threat to human health and notice must be given as soon as possible, but no later than 24 hours after notification from your laboratory of the test results.

Certain language may be mandatory for both these violations and is included in your state drinking water rule.

Public Notice

A public notice is required to be issued by a water system whenever it fails to comply with an applicable MCL or treatment technique, or fails to comply with the requirements of any scheduled variance or permit. This will inform users when there is a problem with the system and give them information.

A public notice is also required whenever a water system fails to comply with its monitoring and/or reporting requirements or testing procedure.

Each public notice must contain certain information, be issued properly and in a timely manner and contain certain mandatory language. The timing and place of posting of the public notice depends on whether an acute risk is present to users. Check with your state drinking water section or health department for further instructions.

The following are Acute Violations

1. Violation of the MCL for nitrate.
2. Any violation of the MCL for total coliforms, when fecal coliforms or E. coli are present in the distribution system.
3. Any outbreak of waterborne disease, as defined by the rules.

Sim Plate Method



IDEXX's SimPlate for HPC method is used for the quantification of heterotrophic plate count (HPC) in water.

It is based on the Multiple Enzyme Technology which detects viable bacteria in water by testing for the presence of key enzymes known to be present in these little organisms.

This technique uses enzyme substrates that produce a blue fluorescence when metabolized by waterborne bacteria. The sample and media are added to a SimPlate Plate, incubated and then examined for fluorescing wells.

The number of wells corresponds to a Most Probable Number (MPN) of total bacteria in the original sample.

The MPN values generated by the SimPlate for HPC method correlate with the Pour Plate method using the Total Plate Count Agar, incubated at 35°C for 48 hours as described in *Standard Methods for the Examination of Water and Wastewater, 19th Edition*.

Revised Total Coliform Rule (RTCR) Sub-Section

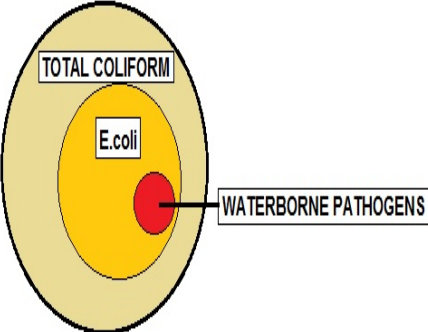
REVISED RULE OVERVIEW		MAJOR RULE CHANGES	
TITLE:	REVISED TOTAL COLIFORM RULE (RTCR) 78 FR 10269, FEBRUARY 13th, 2013, Vol. 78, No. 30	CURRENT TCR Non-Accute MCL Violation	REVISED TCR Level 1 Assessment Trigger
PURPOSE:	INCREASE PUBLIC HEALTH PROTECTION THROUGH THE REDUCTION OF POTENTIAL PATHWAYS OF ENTRY FOR FECAL CONTAMINATION INTO DISTRIBUTION SYSTEM	FOR A SYSTEM COLLECTING AT LEAST 40 SAMPLES PER MONTH, MORE THAN 5.0% OF SAMPLES COLLECTED ARE TC POSITIVE	FOR A SYSTEM COLLECTING AT LEAST 40 SAMPLES PER MONTH, MORE THAN 5.0% OF SAMPLES COLLECTED ARE TC POSITIVE
GENERAL DESCRIPTION:	THE RTCR ESTABLISHES AN MCL FOR E.coli AND USES E.coli AND TOTAL COLIFORMS TO INITIATE AND "FIND A FIX" APPROACH TO ADDRESS FECAL CONTAMINATION THAT COULD ENTER DISTRIBUTION SYSTEM	FOR A SYSTEM COLLECTING FEWER THAN 40 SAMPLES PER MONTH, MORE THAN 1 SAMPLE TC POSITIVE	FOR A SYSTEM COLLECTING FEWER THAN 40 SAMPLES PER MONTH, MORE THAN 1 SAMPLE TC POSITIVE
UTILITIES COVERED:	THE REVISED TOTAL COLIFORM RULE APPLIES TO <u>ALL</u> PUBLIC WATER SYSTEMS	PUBLIC NOTICE IS REQUIRED	NO PUBLIC NOTICE MUST PERFORM LEVEL 1 ASSESSMENT
PUBLIC HEALTH BENEFITS			
IMPLEMENTATION OF THE REVISED TOTAL COLIFORM RULE <u>WILL</u> RESULT IN:			
<ul style="list-style-type: none"> ▶ A DECREASE IN THE PATHWAY BY WHICH FECAL CONTAMINATION CAN ENTER THE DRINKING WATER DISTRIBUTION SYSTEM ▶ REDUCTION IN FECAL CONTAMINATION <u>SHOULD</u> REDUCE THE POTENTIAL RISK FROM ALL WATERBORNE PATHOGENS INCLUDING BACTERIA, VIRUSES, PROTOZOA, AND ASSOCIATED ILLNESSES. 			



REVISED TOTAL COLIFORM RULE (RTCR)

The following are EPA's federal rule requirements. Please be aware that each state implements drinking water regulations that may be more stringent than EPA's regulations. Check with your state environmental agency for more information.

EPA published the Revised Total Coliform Rule (RTCR) in the Federal Register (FR) on February 13, 2013 (78 FR 10269). It is the revision to the 1989 Total Coliform Rule (TCR).

Why revise the 1989 TCR?

The 1996 amendments to the Safe Drinking Water Act [Section 1412(b) (9)] require the Administrator to review and revise, as appropriate, each national primary drinking water regulation not less often than every six years. EPA published its decision to revise the TCR in July 2003 as part of its National Primary Drinking Water Regulation (NPDWR) review.

The RTCR:

- Upholds the purpose of the 1989 TCR to protect public health by ensuring the integrity of the drinking water distribution system and monitoring for the presence of microbial contamination.

- Requires public water systems (PWSs) to meet a legal limit for E. coli, as demonstrated by required monitoring.
- Specifies the frequency and timing of required microbial testing based on population served, public water system type and source water type: groundwater or surface water.

When must PWSs comply with the RTCR requirements?

Unless a State determines an earlier effective date, all PWSs must comply with the RTCR requirements starting April 1, 2016. All PWSs include:

- Community Water Systems (CWSs),
- Non-Transient Non-Community Water Systems (NTNCWSs), and
- Transient Non-Community Water Systems (TNCWSs).

Minor Corrections to the Revised Total Coliform Rule (RTCRC)

Minor corrections to the final RTCR became effective on April 28, 2014. No comments were received on the Direct Final Rule published on February 26, 2014 and the corrections therefore became effective without further notice. See the **Direct Final Rule** Federal Register Notice.

Revised Total Coliform Rule (RTCRC) – Final Rule

On February 13, 2013, EPA published in the Federal Register the revisions to the 1989 TCR. EPA anticipates greater public health protection under the Revised Total Coliform Rule (RTCRC) requirements.

The RTCRC:

- Requires public water systems that are vulnerable to microbial contamination to identify and fix problems; and
- Establishes criteria for systems to qualify for and stay on reduced monitoring, which could reduce water system burden and provide incentives for better system operation.

Public water systems (PWSs) and primacy agencies must comply with the revised requirements by April 2016. Until then, PWSs and primacy agencies must continue complying with the 1989 TCR.



ONE AT THE SAME SITE AS THE ROUTINE SAMPLE.
 ONE WITHIN 5 SERVICE CONNECTIONS UPSTREAM.
 ONE WITHIN 5 SERVICE CONNECTIONS DOWNSTREAM.

IF A FOURTH REPEAT SAMPLE IS REQUIRED THE SYSTEM SHOULD TAKE THE SAMPLE WHEREVER IT FEELS IT WILL HELP IDENTIFY THE AREA OF CONTAMINATION.

REPEAT SAMPLING PROCEDURES

RTCR Key Provisions *Most of this section comes from the USEPA.*

Provision Category	Key Provisions
Contaminant Level	<p>Addresses the presence of total coliforms and E. coli in drinking water.</p> <p>For E. coli (EC), the Maximum Contaminant Level Goal (MCLG) is set at zero. The Maximum Contaminant Level (MCL) is based on the occurrence of a condition that includes routine and repeat samples.</p> <p>For total coliforms (TC), PWSs must conduct a Level 1 or Level 2 assessment of their system when they exceed a specified frequency of total coliform occurrences.</p> <p>An MCL violation or failure to take repeat samples following a routine total coliform-positive sample will trigger a Level 1 or Level 2 assessment.</p> <p>Any sanitary defect identified during a Level 1 or Level 2 assessment must be corrected by the PWS. These are the treatment technique requirements of the RTCR.</p>
Monitoring	<p>Develop and follow a sample-siting plan that designates the PWS's collection schedule. This includes location of routine and repeat water samples.</p> <p>Collect routine water samples on a regular basis (monthly, quarterly, annually). Have samples tested for the presence of total coliforms by a state certified laboratory.</p> <p>Analyze all routine or repeat samples that are total coliform positive (TC+) for E. coli.</p> <p>Collect repeat samples (at least 3) for each TC+ positive routine sample.</p> <p>For PWSs on quarterly or annual routine sampling, collect additional routine samples (at least 3) in the month after a TC+ routine or repeat sample.</p>

RTCR Key Provisions <i>Most of this section comes from the USEPA.</i>	
	Seasonal systems must monitor and certify the completion of a state-approved start-up procedures.
Level 1 and Level 2 Assessments and Corrective Actions	PWSs are required to conduct a Level 1 or Level 2 assessment if conditions indicate they might be vulnerable to contamination. PWSs must fix any sanitary defects within a required timeframe.
Reporting and Recordkeeping	PWSs are required to report certain items to their states. These reporting and recordkeeping requirements are essentially the same as under TCR. The addition to the Requirements is the Level 1 and Level 2 requirements.
Violations, Public Notification (PN) and Consumer Confidence Report (CCR)	<p>PWSs incur violations if they do not comply with the requirements of the RTCR. The violation types are essentially the same as under the TCR with few changes. The biggest change is no acute or monthly MCL violation for total coliform positive samples only.</p> <p>PN is required for violations incurred. Within required timeframes, the PWS must use the required health effects language and notify the public if they did not comply with certain requirements of the RTCR. The type of PN depends on the severity of the violation.</p> <p>Community water systems (CWSs) must use specific language in their CCRs when they must conduct an assessment or if they incur an E. coli MCL violation.</p>

Disinfection Key

- ▶ Contact time is required
 - ▶ 99% or 2 log inactivation of crypto
 - ▶ 99.9% or 3 log inactivation of giardia lamblia cysts
 - ▶ 99.99% or 4 log inactivation of enteric viruses
- ▶ CT = Concentration of disinfectant x contact time

The chlorine residual leaving the plant must be = or > 0.2 mg/L and measurable throughout the system

Troubleshooting Table for Bacteriological Monitoring

Problems

1. Positive Total Coliform.
2. Chlorine taste and odor.
3. Inability to maintain an adequately free chlorine residual at the furthest points of the distribution system or at dead end lines.

Possible Causes

- 1A. Improper sampling technique.
- 1B. Contamination entering distribution system.
- 1C. Inadequate chlorine residual at the sampling site.
- 1D. Growth of biofilm in the distribution system.
- 2A. High total chlorine residual and low free residual.
- 3A. Inadequate chlorine dose at treatment plant.
- 3B. Problems with chlorine feed equipment.
- 3C. Ineffective distribution system flushing program.
- 3D. Growth of biofilm in the distribution system.

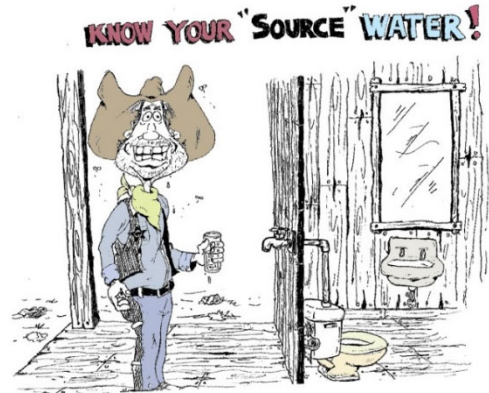

Possible Solutions

- 1A/ Check distribution system for low-pressure conditions, possibly due to line breaks or excessive flows that may result in a backflow problem.
- 1B. Insure that all staff are properly trained in sampling and transport procedures as described in the TCR.
- 1C. Check the operation of the chlorination feed system. Refer to issues described in the sections on pumps and hypochlorination systems. Insure that residual test is being performed properly.
- 1D. Thoroughly flush effected areas of the distribution system. Superchlorination may be necessary in severe cases.
- 2A. The free residual should be at least 85% of the total residual. Increase the chlorine dose rate to get past the breakpoint in order to destroy some of the combined residual that causes taste and odor problems. Additional system flushing may also be required.
- 3A. Increase chlorine feed rate at point of application.
- 3B. Check operation of chlorination equipment.
- 3C. Review distribution system flushing program and implement improvements to address areas of inadequate chlorine residual.
- 3D. Increase flushing in area of biofilm problem.

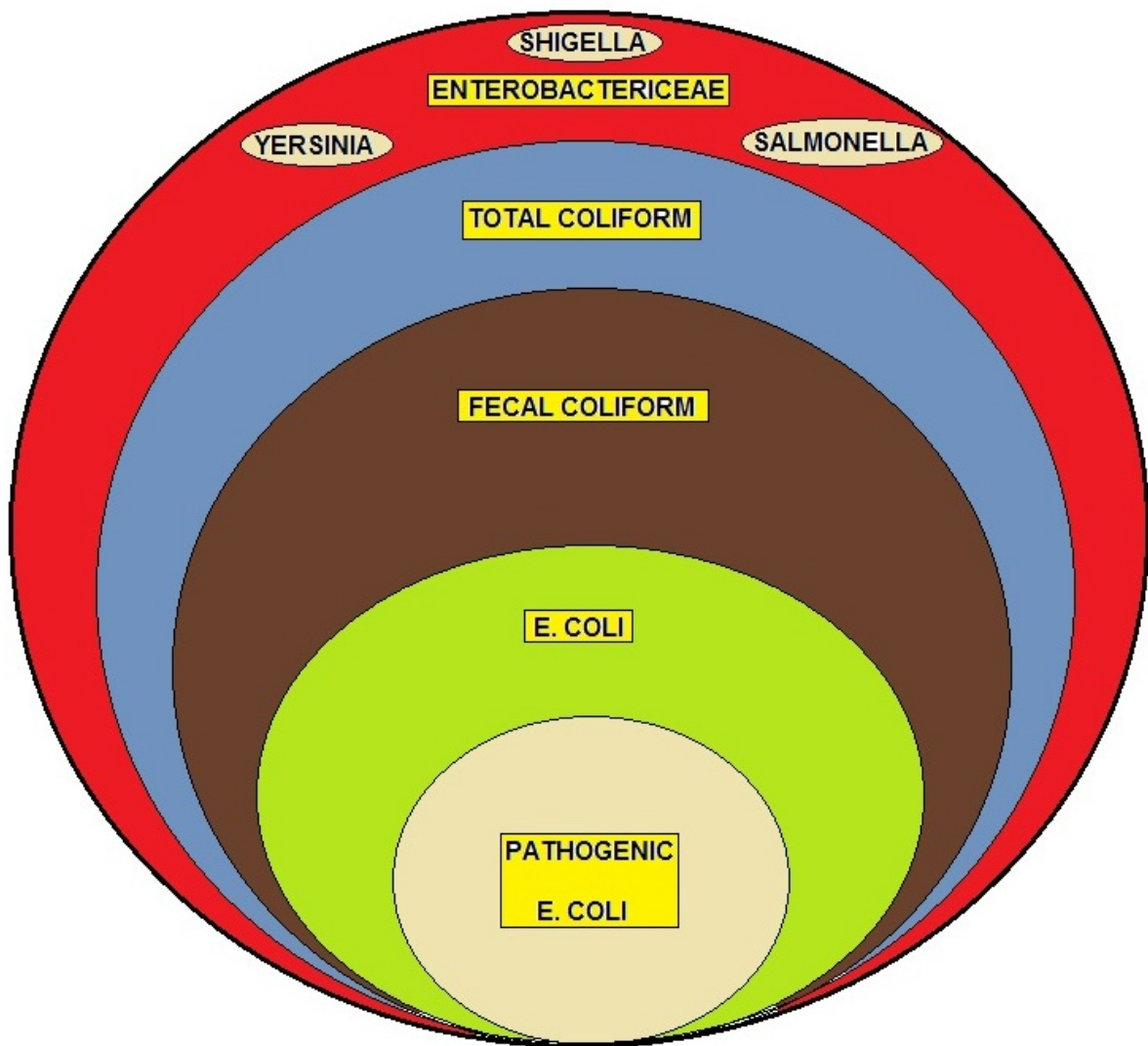

**COLIFORM BACTERIA SUB-SET #1
INDICATOR ORGANISMS**

Waterborne Pathogen Section - Introduction

Bacteria, viruses, and protozoans that cause disease are known as pathogens. Most waterborne pathogens are generally associated with diseases that cause intestinal illness and affect people in a relatively short amount of time, generally a few days to two weeks. They can cause illness through exposure to small quantities of contaminated water or food or from direct contact with infected people or animals.

Pathogens that may cause waterborne outbreaks through drinking water have one thing in common: they are spread by the fecal-oral (or feces-to-mouth) route. Pathogens may get into water and spread when infected humans or animals pass the bacteria, viruses, and protozoa in their stool. For another person to become infected, he or she must take that pathogen in through the mouth.

Waterborne pathogens are different from other types of pathogens such as the viruses that cause influenza (the flu) or the bacteria that cause tuberculosis. Influenza virus and tuberculosis bacteria are spread by secretions that are coughed or sneezed into the air by an infected person.

Human or animal wastes in watersheds, failing septic systems, failing sewage treatment plants or cross-connections of water lines with sewage lines provide the potential for contaminating water with pathogens. The water may not appear to be contaminated because feces has been broken up, dispersed and diluted into microscopic particles. These particles, containing pathogens, may remain in the water and be passed to humans or animals unless adequately treated.

Only proper treatment and a safe distribution system can ensure eliminating the spread of waterborne disease. In addition to water, other methods exist for spreading pathogens by the fecal-oral route. The foodborne route is one of the more common methods. A frequent source is a food handler who does not wash his hands after a bowel movement and then handles food with “unclean” hands. The individual who eats feces-contaminated food may become infected and ill. It is interesting to note the majority of foodborne diseases occur in the home, not restaurants.

Day care centers are another common source for spreading pathogens by the fecal-oral route. Here, infected children in diapers may get feces on their fingers, then put their fingers in a friend’s mouth or handle toys that other children put into their mouths. You will usually be asked to sample for **Giardia** at these facilities.



Giardia

The general public and some of the medical community usually refer to diarrhea symptoms as “**stomach flu.**” Technically, influenza is an upper respiratory illness and rarely has diarrhea associated with it; therefore, stomach flu is a misleading description for foodborne or waterborne illnesses, yet is accepted by the general public. So the next time you get the stomach flu, you may want to think twice about what you’ve digested within the past few days.

Chain of Transmission

This chain lists the events that must occur for the transmission of disease via drinking water. By breaking the chain at any point, the transmission of disease will be prevented. Water is contaminated with feces. This contamination may be of human or animal origin. The feces must contain pathogens (disease-causing bacteria, viruses or protozoa). If the human or animal source is not infected with a pathogen, no disease will result.

The pathogens must survive in the water. This depends on the temperature of the water and the length of time the pathogens are in the water. Some pathogens will survive for only a short time in water, others, such as *Giardia* or *Cryptosporidium*, may survive for months.

The pathogens in the water must enter the water system's intake in numbers sufficient to infect people. The water is either not treated or inadequately treated for the pathogens present. A susceptible person must drink the water that contains the pathogen; then illness (disease) will occur.

Emerging Waterborne Pathogens

Emerging waterborne pathogens constitute a major health hazard in both developed and developing nations. A new dimension to the global epidemiology of cholera-an ancient scourge-was provided by the emergence of *Vibrio cholerae* O139. Also, waterborne enterohemorrhagic *Escherichia coli* (*E. coli* O157:H7), although regarded as a problem of the industrialized west, has recently caused outbreaks in Africa.

Outbreaks of chlorine-resistant *Cryptosporidium* in the US have motivated water authorities to reassess the adequacy of current water-quality regulations. Of late, a host of other organisms, such as hepatitis viruses (including hepatitis E virus), *Campylobacter jejuni*, microsporidia, cyclospora, *Yersinia enterocolitica*, calciviruses and environmental bacteria like *Mycobacterium* spp, aeromonads, *Legionella pneumophila* and multidrug-resistant *Pseudomonas aeruginosa* have been associated with water-borne illnesses.

The protection and enhancement of our nation's water quality remains a chief concern of the U.S. Environmental Protection Agency. The Office of Research and Development is committed, through the extensive waterborne disease research efforts earlier described, to ensure that the most effective and efficient methods are developed to identify, detect, and inactivate/remove pathogens that may be present in our drinking water supplies.

Life cycles, mechanisms of infection, protective or dormant states, emergence of disinfection resistant variants, optimal pathogen removal techniques, regrowth in distribution lines...all are areas that must be investigated and understood to afford the water quality safeguards that are so often taken for granted. The successes and failures of these research efforts, relayed to the public and appropriate federal, state, and local agencies, have helped to ensure safe drinking water.

More on this subject in the *Microorganism Appendix*. Hyperlink to the Glossary and Appendix <http://www.abctlc.com/downloads/PDF/WTGlossary.pdf>

Primary Waterborne Diseases Section - Alphabetical Order

Campylobacter

Campylobacter, the basics. It is a bacterium. It causes diarrheal illness. Campylobacter is primarily associated with poultry, animals, and humans.

Campylobacter prevention: Prevention strategies for this pathogen include source protection, halogenation of water, and boiling water for one minute.

Cryptosporidium

Cryptosporidium, the basics. It is a parasite. It causes diarrheal illness known as cryptosporidiosis. It is typically associated with animals and humans, and it can be acquired through consuming fecally contaminated food, contact with fecal contaminated soil and water.

Cryptosporidium, prevention: Prevention strategies for this pathogen include source protection. A CT value of 9,600 is required when dealing with fecal accidents. CT equals a concentration, in parts per million, while time equals a contact time in minutes. Cryptosporidium can also be prevented or eliminated by boiling water for one minute.

Filtration with an "*absolute*" pore size of one micron or smaller can eliminate Cryptosporidium, and reverse osmosis is known to be effective as well.

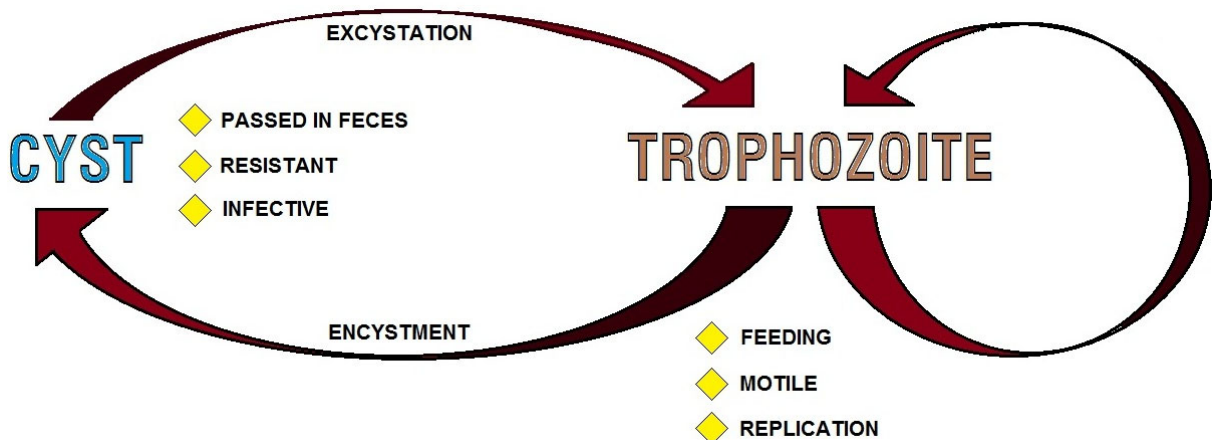

TYPICAL FECAL-ORAL LIFE CYCLE DIAGRAM

E-Coli Section

Escherichia coli. Escherichia coli O157:H7, the basics. It's a bacteria. There are several pathogenic strains of Escherichia coli, which are classified under enterovirulent E. coli. They are enterohemorrhagic, enteroinvasive, enterotoxigenic, enteropathogenic, and enteroaggregative causes diarrheal illness, and it's classified as an enterohemorrhagic E. coli. In its most severe form, it can cause hemorrhagic colitis. The reservoir for this bacteria are cattle, deer, goats, and sheep. Humans can also be a reservoir. It is typically associated with contaminated food and water.

E. coli O157:H7 prevention: Prevention strategies for this pathogen include source protection, halogenation of water, or boiling water for one minute.

Giardia

Giardia, the basics. It is a parasite. It causes diarrheal illness known as giardiasis. It is typically associated with water. It is the most common pathogen in waterborne outbreaks. It can also be found in soil and food, and humans and animals are the reservoir for this pathogen.

Giardia prevention: Prevention strategies for this pathogen include source protection; filtration, coagulation, and halogenation of drinking water.

Hepatitis A

Hepatitis A, the basics. It is a virus. It causes inflammation of the liver, and the reservoir for Hepatitis A virus is humans.

Hepatitis A, Prevention: Prevention strategies for this pathogen include source protection and adequate disinfection. Fecal matter can protect Hepatitis A virus from chlorine. Additionally, Hepatitis A virus is resistant to combined chlorines, so it is important to have an adequate free chlorine residual.

Legionella

Legionella, the basics. It is a bacterium. It causes a respiratory illness known as Legionellosis. There are two illnesses associated with Legionellosis: the first, Legionnaire's disease, which causes a severe pneumonia, and the second, Pontiac fever, which is a non-pneumonia illness; it is typically an influenza-like illness, and it's less severe. Legionella is naturally found in water, both natural and artificial water sources.

Legionella, prevention: Maintaining hot water systems at or above 50 degrees Centigrade and cold water below 20 degrees Centigrade can prevent or control the proliferation of Legionella in water systems. Hot water in tanks should be maintained between 71 and 77 degrees Centigrade.

Proper recreational water system maintenance and disinfection can prevent the proliferation of Legionella in recreational water systems. It is important to prevent water stagnation. This can be accomplished by eliminating dead ends in distribution systems and in recreational water systems. Additionally, preventing biofilm development is important to control this particular pathogen in water systems.

Norovirus

Norovirus, the basics. It is a virus. It causes diarrheal illness, and humans are the reservoir for this virus.

Norovirus, prevention: Prevention strategies for this pathogen include source protection.

Pseudomonas

Pseudomonas, the basics. It is a bacterium. It is caused by dermal contact with water. It can cause dermatitis, which is an inflammation of the skin, or it can cause otitis, which is an infection of the ear. Pseudomonas is typically associated with soil and water.

Pseudomonas prevention: Proper maintenance and disinfection of recreational water systems is important in preventing Pseudomonas.

Salmonella Typhi

Salmonella typhi, the basics. It is a bacterium. It causes diarrheal illness, also known as typhoid fever. Humans are the reservoir for this pathogen. Salmonella species, the basics. It is a bacterium. It causes diarrheal illness known as salmonellosis.

Humans and animals are the reservoir, and it has typically associated with contaminated food and water. Salmonella species, prevention. Prevention strategies for this pathogen include source protection, halogenation of water, and boiling water for one minute.

Salmonella typhi, prevention: Prevention strategies for this pathogen include source protection, chlorination or halogenation of water, and boiling water for one minute.

Schistosomatidae

Schistosomatidae, the basics. It is a parasite. It is acquired through dermal contact, cercarial dermatitis. It is commonly known as swimmer's itch. The reservoir for this pathogen are aquatic snails and birds.

Schistosomatidae prevention: Prevention strategies for this pathogen include eliminating snails with a molluscicide or interrupting the life cycle of the parasite by treating birds with an antihelminthic drug.

Shigella Species

Shigella species, the basics. It is a bacterium. It causes diarrheal illness known as shigellosis. Humans and primates are the reservoir for this pathogen. Shigella species, in the United States two-thirds of the shigellosis in the U.S. is caused by Shigella sonnei, and the remaining one-third is caused by Shigella flexneri. In developing countries, Shigella dysenteriae is the primary cause of illness associated with this pathogen.

Shigella species prevention: Prevention strategies for this pathogen include source protection, halogenation of water, and boiling water for one minute.

Vibrio Cholerae

Vibrio cholerae, the basics. It is a bacterium. It causes diarrheal illness, also known as cholera. It is typically associated with aquatic environments, shell stocks, and human. Vibrio cholerae has also been associated with ship ballast water, and there will be a discussion later on in this presentation of an outbreak associated with ship ballast water.

Vibrio cholerae prevention: Prevention strategies for this pathogen include source protection, halogenation of water, and boiling water for one minute.

PRESENCE OF PATHOGENS IN WATER	TYPES OF PATHOGENS FOUND IN WATER
THE PRESENCE OF COLIFORM BACTERIA CAN INDICATE THERE MAY BE HARMFUL BACTERIA PATHOGENS IN THE WATER	
THE PRINCIPAL REMOVAL PROCESSES ARE THOSE LIKELY USED TO REMOVE THE MAJORITY OF THE MICROBES IN WATER BEING TREATED	
THE REMOVAL PROCESSES BEING UTILIZED ARE SEDIMENTATION, FLOTATION AND THE USE OF HIGH RATE GRANULAR MEDIA FILTRATION	
DISINFECTION WITH IODINE OR CHLORINE IS THE MOST EFFECTIVE AT KILLING VIRUSES FOUND IN WATER.	



PATHOGENS FOUND IN WATER SUPPLIES

MICROBIOLOGICAL CONTAMINANTS FOUND IN WATER	
THESE ARE OFTEN OF FECAL NATURE RELATED TO HUMANS, DOMESTIC ANIMALS OR WILDLIFE	
<p><u>CALIVIVIRUS:</u></p> <p>SIGNS OF THIS VIRUS INCLUDE SNEEZING, NASAL DISCHARGE, OCULAR DISCHARGE, CONJUNCTIVITIS, ULCERATION OF THE TONGUE, LETHARGY, INAPPETENCE (Lack of Appetite) AND FEVER</p>	
<p><u>CAMPYLOBACTER JEJUNI:</u></p> <p>THIS IS ONE OF THE MOST COMMON CAUSES OF FOOD POISONING. IT IS CHARACTERIZED BY DIARRHEA, ABDOMINAL PAIN, FEVER, NAUSEA AND SOMETIMES VOMITING</p>	
<p><u>ENTEROVIRUS:</u></p> <p>SYMPTOMS OF THIS VIRUS INFECTION MAY INCLUDE FEVER, RUNNY NOSE, SNEEZING, COUGH, SKIN RASH, MOUTH BLISTERS, AND BODY AND MUSCLE ACHES</p>	
<p><u>ESCHERICHIA COLI:</u></p> <p>NORMALLY LIVES IN THE INTESTINES OF HEALTHY PEOPLE AND ANIMALS. MOST E.Coli ARE HARMLESS OR RELATIVELY BRIEF DIARRHEA. SOME E.Coli CAN CAUSE SEVERE STOMACH CRAMPS, BLOODY DIARRHEA AND VOMITING</p>	



MICROBIOLOGICAL CONTAMINANTS

Waterborne Bacterial Diseases

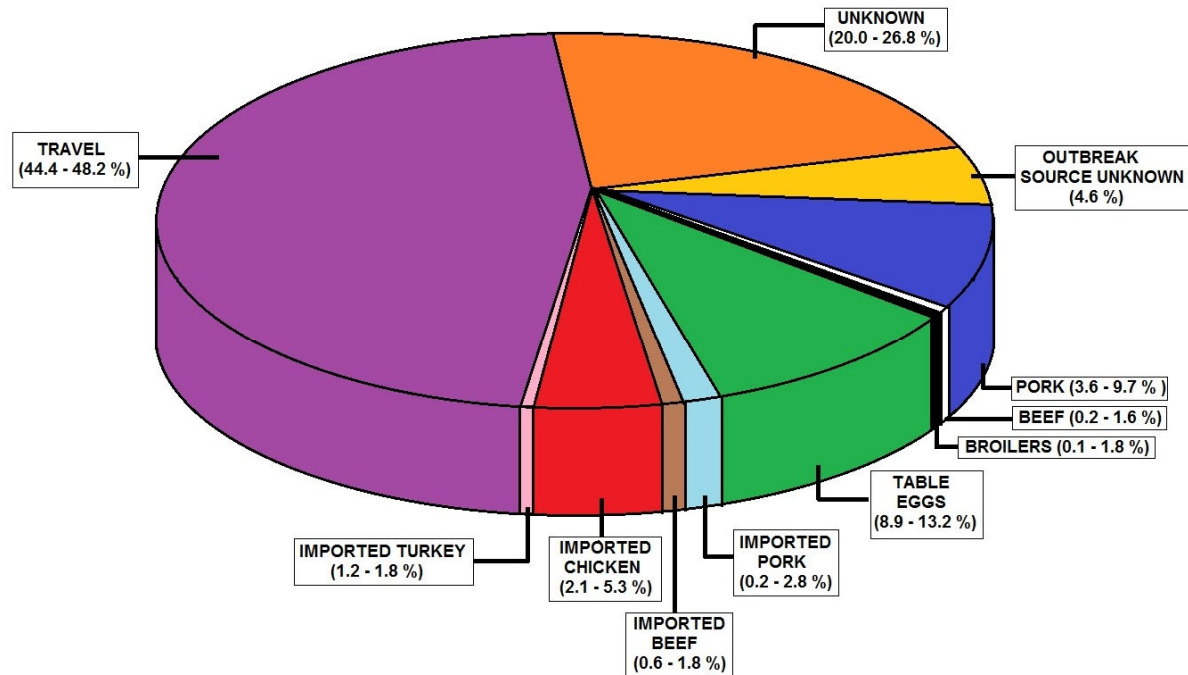

COURSES OF SAMONELLA PIE CHART

Campylobacteriosis is the most common diarrheal illness caused by bacteria. Other symptoms include abdominal pain, malaise, fever, nausea and vomiting; and begin three to five days after exposure. The illness is frequently over within two to five days and usually lasts no more than 10 days.

Campylobacteriosis outbreaks have most often been associated with food, especially chicken and un-pasteurized milk, as well as un-chlorinated water. These organisms are also an important cause of “**travelers’ diarrhea.**” Medical treatment generally is not prescribed for campylobacteriosis because recovery is usually rapid.

Cholera, Legionellosis, salmonellosis, shigellosis, yersiniosis, are other bacterial diseases that can be transmitted through water. All bacteria in water are readily killed or inactivated with chlorine or other disinfectants.

Gastroenteritis is an intestinal infection marked by watery diarrhea, abdominal cramps, nausea or vomiting, and sometimes fever. The most common way to develop viral gastroenteritis — often called stomach flu — is through contact with an infected person or by ingesting contaminated food or water. Because the symptoms are similar, it's easy to confuse viral diarrhea with diarrhea caused by bacteria, such as *Clostridium difficile*, salmonella and *E. coli*, or parasites, such as giardia.

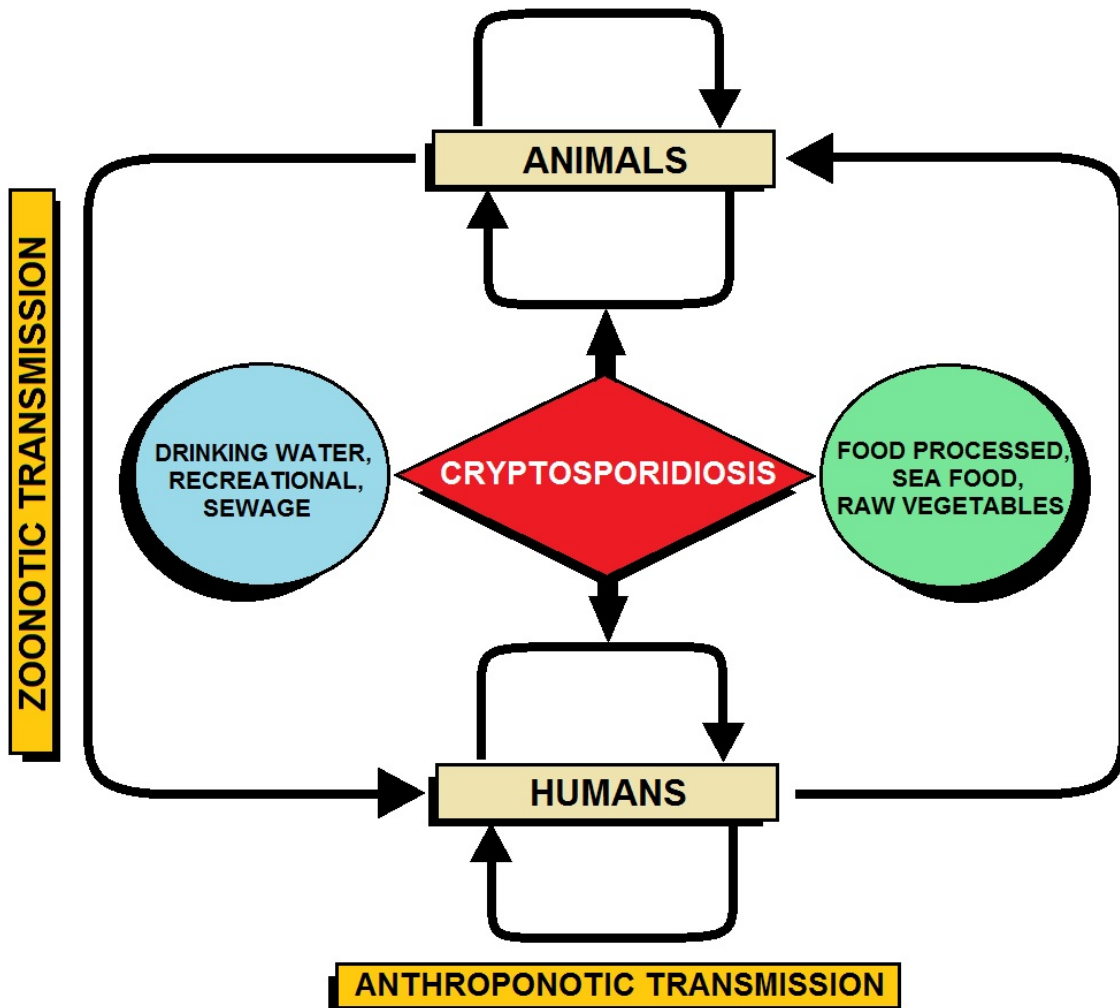

TRANSMISSION OF CRYPTOSPORIDIOSIS



Waterborne Viral Diseases

- Drinking water must be free from viruses.
- Sometime viruses from intestinal tract of infected person get access to water along with feces.
- Some intestinal pathogenic viruses which are transmitted through contaminated water are- Rotavirus, Poliovirus, Hepatitis A and E, etc.

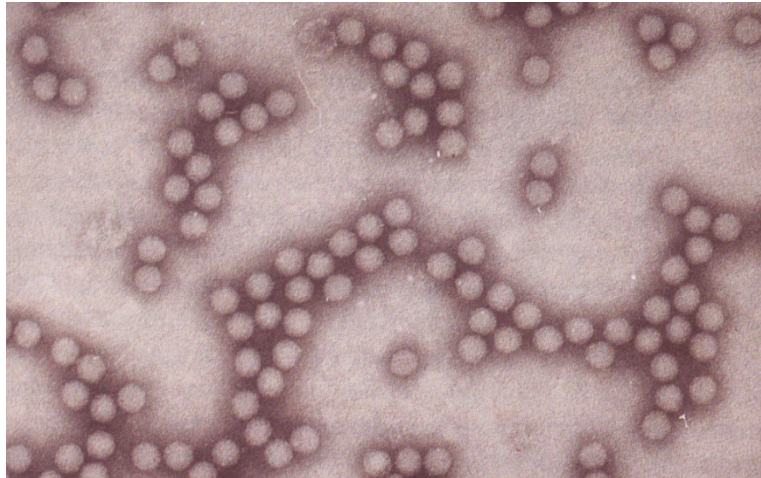

Hepatitis A is an example of a common viral disease that may be transmitted through water. The onset is usually abrupt with fever, malaise, loss of appetite, nausea and abdominal discomfort, followed within a few days by jaundice. The disease varies in severity from a mild illness lasting one to two weeks, to a severely disabling disease lasting several months (rare). The incubation period is 15-50 days and averages 28-30 days.

Hepatitis A outbreaks have been related to fecally contaminated water; food contaminated by infected food handlers, including sandwiches and salads that are not cooked or are handled after cooking, and raw or undercooked mollusks harvested from contaminated waters. Aseptic meningitis, polio and viral gastroenteritis (**Norwalk agent**) are other viral diseases that can be transmitted through water. Most viruses in drinking water can be inactivated by chlorine or other disinfectants.

Norovirus

Norovirus, sometimes referred to as the winter vomiting bug, is the most common cause of gastroenteritis. Infection is characterized by non-bloody diarrhea, vomiting, and stomach pain. Fever or headaches may also occur. Symptoms usually develop 12 to 48 hours after being exposed, and recovery typically occurs within 1 to 3 days. Complications are uncommon, but may include dehydration, especially in the young, the old, and those with other health problems.

The virus is usually spread by the fecal–oral route. This may be through contaminated food or water or person-to-person contact. It may also spread via contaminated surfaces or through air from the vomit of an infected person. Risk factors include unsanitary food preparation and sharing close quarters.

Diagnosis is generally based on symptoms. Confirmatory testing is not usually available but may be performed during outbreaks by public health agencies.

Norovirus results in about 685 million cases of disease and 200,000 deaths globally a year. It is common both in the developed and developing world. Those under the age of five are most often affected, and in this group it results in about 50,000 deaths in the developing world. Norovirus infections occur more commonly during winter months. It often occurs in outbreaks, especially among those living in close quarters. In the United States, it is the cause of about half of all foodborne disease outbreaks. The virus is named after the city of Norwalk, Ohio, where an outbreak occurred in 1968.

Coronavirus

It looks like the COVID-19 coronavirus may be able to live in water for a few days, potentially even a few weeks. Consider what is known about the severe acute respiratory syndrome coronavirus 2 (SARS-CoV-2) in water. Indeed studies have suggested that the SARS-CoV2 could actually hang out in the wet stuff for a little while.

SARS Virus

For example, a study published in the journal Water Research in 2009 found that two viruses that have similarities to the original SARS virus, the transmissible gastroenteritis (TGEV) and mouse hepatitis (MHV) viruses, could survive up to days and even weeks in water. The University of North Carolina team (Lisa Casanova, William A. Rutal, David J. Weber, and Mark D. Sobsey) that conducted the study concluded that “coronaviruses can remain infectious for long periods in water and pasteurized settled sewage, suggesting contaminated water is a potential vehicle for human exposure if aerosols are generated.”

A. SOURCE OF NOROVIRUS

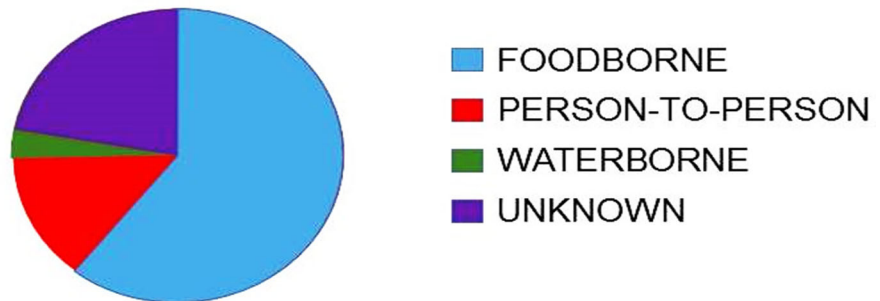

B. SETTING FOR OUTBREAK

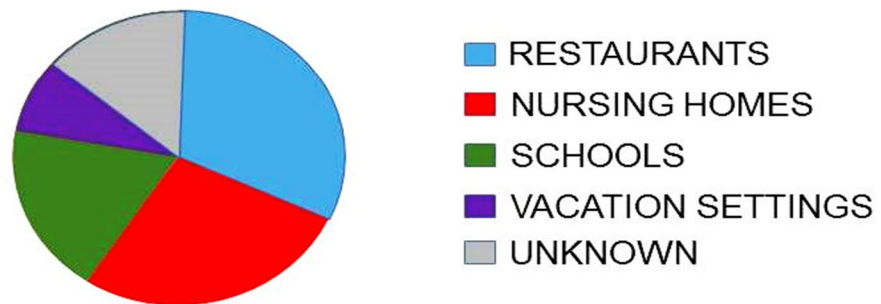

Waterborne Protozoan Diseases

Protozoan pathogens are larger than bacteria and viruses, but still microscopic. They invade and inhabit the gastrointestinal tract. Some parasites enter the environment in a dormant form, with a protective cell wall called a “cyst.” The cyst can survive in the environment for long periods of time and be extremely resistant to conventional disinfectants such as chlorine. Effective filtration treatment is therefore critical to removing these organisms from water sources.

Giardiasis is a commonly reported protozoan-caused disease. It has also been referred to as “backpacker’s disease” and “beaver fever” because of the many cases reported among hikers and others who consume untreated surface water.

Symptoms include chronic diarrhea, abdominal cramps, bloating, frequent loose and pale greasy stools, fatigue and weight loss. The incubation period is 5-25 days or longer, with an average of 7-10 days.

Many infections are asymptomatic (no symptoms). Giardiasis occurs worldwide. Waterborne outbreaks in the United States occur most often in communities receiving their drinking water from streams or rivers without adequate disinfection or a filtration system.

- Drinking water should be free from disease causing parasites.
- Many species of protozoa and helminthes that causes water borne disease contaminates water through feces of infected patients.

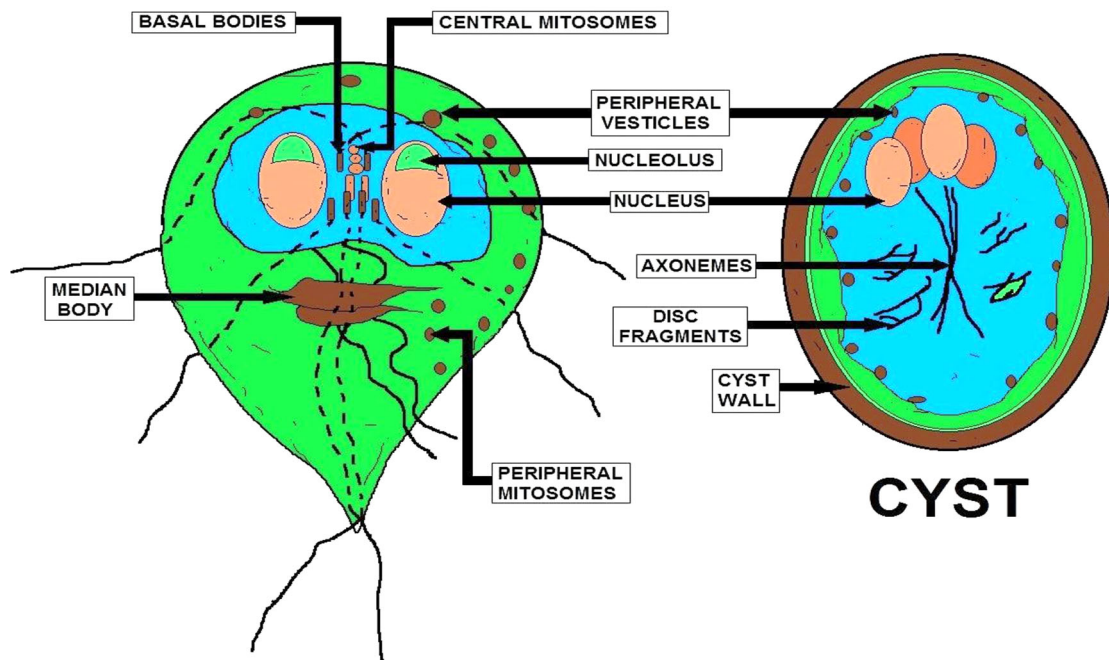

The organism, *Giardia lamblia*, has been responsible for more community-wide outbreaks of disease in the U.S. than any other pathogen. Drugs are available for treatment, but these are not 100% effective.

Cryptosporidiosis

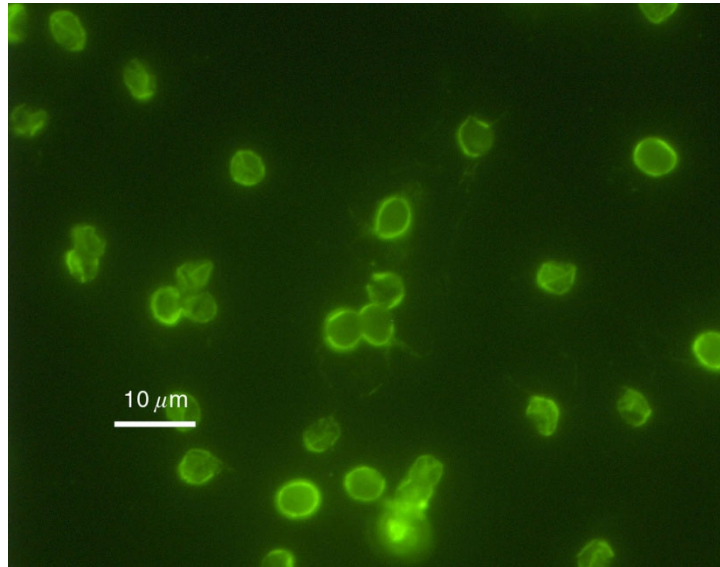

Cryptosporidiosis is an example of a protozoan disease that is common worldwide, but was only recently recognized as causing human disease. The major symptom in humans is diarrhea, which may be profuse and watery.

The diarrhea is associated with cramping abdominal pain. General malaise, fever, anorexia, nausea, and vomiting occur less often. Symptoms usually come and go, and end in fewer than 30 days in most cases. The incubation period is 1-12 days, with an average of about seven days. *Cryptosporidium* organisms have been identified in human fecal specimens from more than 50 countries on six continents.

The mode of transmission is fecal-oral, either by person-to-person or animal-to-person. There is no specific treatment for *Cryptosporidium* infections. All these diseases, with the exception of hepatitis A, have one symptom in common: diarrhea. They also have the same mode of transmission, fecal-oral, whether through person-to-person or animal-to-person contact, and the same routes of transmission, being either foodborne or waterborne.

Although most pathogens cause mild, self-limiting disease, on occasion, they can cause serious, even life threatening illness. Particularly vulnerable are persons with weak immune systems, such as those with HIV infections or cancer.

By understanding the nature of waterborne diseases, the importance of properly constructed, operated and maintained public water systems becomes obvious. While water treatment cannot achieve sterile water (no microorganisms), the goal of treatment must clearly be to produce drinking water that is as pathogen-free as possible at all times.

For those who operate water systems with inadequate source protection or treatment facilities, the potential risk of a waterborne disease outbreak is real. For those operating systems that currently provide adequate source protection and treatment, operating and maintaining the system at a high level on a continuing basis is critical to prevent disease.

Common Waterborne Diseases Chart

Name	Causative organism	Source of organism	Disease
Viral gastroenteritis	Rotavirus (mostly in young children)	Human feces	Diarrhea or vomiting
Norwalk Agent	Noroviruses (genus <i>Norovirus</i> , family <i>Caliciviridae</i>) *1	Human feces; also, shellfish; lives in polluted waters	Diarrhea and vomiting
Salmonellosis	Salmonella (bacterium)	Animal or human feces	Diarrhea or vomiting
Gastroenteritis <i>Escherichia coli</i>	-- <i>E. coli</i> O157:H7 (bacterium): Other <i>E. coli</i> organisms:	Human feces	Symptoms vary with type caused
Typhoid	Salmonella typhi (bacterium)	Human feces, urine	Inflamed intestine, enlarged spleen, high temperature—sometimes fatal
Shigellosis	Shigella (bacterium)	Human feces	Diarrhea
Cholera	Vibrio cholerae (bacterium)	Human feces; also, shellfish; lives in many coastal waters	Vomiting, severe diarrhea, rapid dehydration, mineral loss—high mortality
Hepatitis A	Hepatitis A virus	Human feces; shellfish grown in polluted waters	Yellowed skin, enlarged liver, fever, vomiting, weight loss, abdominal pain—low mortality, lasts up to four months
Amebiasis	Entamoeba histolytica (protozoan)	Human feces	Mild diarrhea, dysentery, extra intestinal infection
Giardiasis	Giardia lamblia (protozoan)	Animal or human feces	Diarrhea, cramps, nausea, and general weakness — lasts one week to months
Cryptosporidiosis	Cryptosporidium parvum	Animal or human feces	Diarrhea, stomach pain — lasts (protozoan) days to weeks

Notes:

*1 <http://www.cdc.gov/ncidod/dvrd/revb/gastro/norovirus.htm>

<http://www.cdc.gov/mmwr/preview/mmwrhtml/rr5009a1.htm>

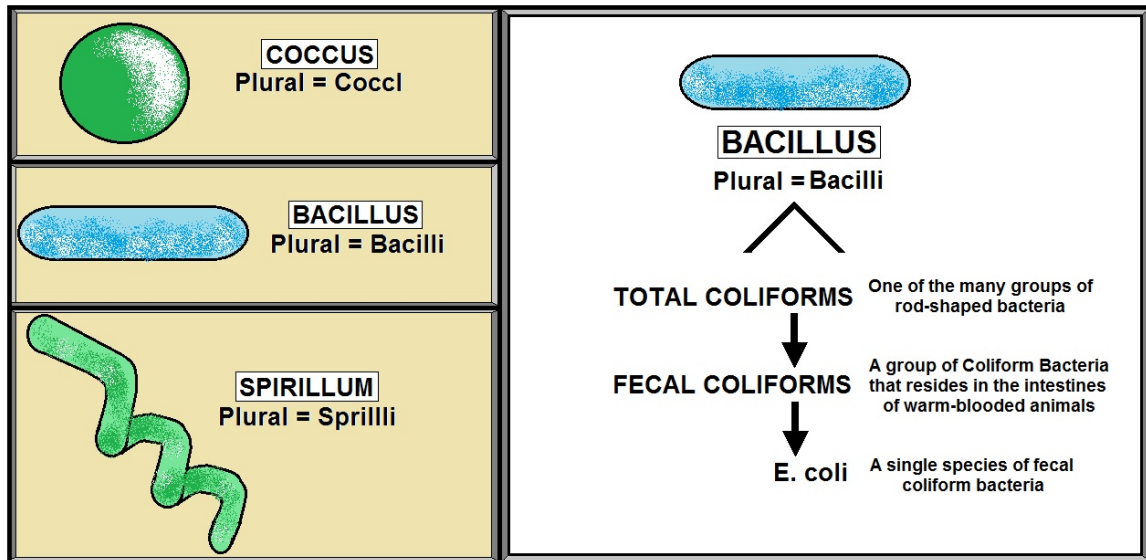

COLIFORM BACTERIA EXAMPLE

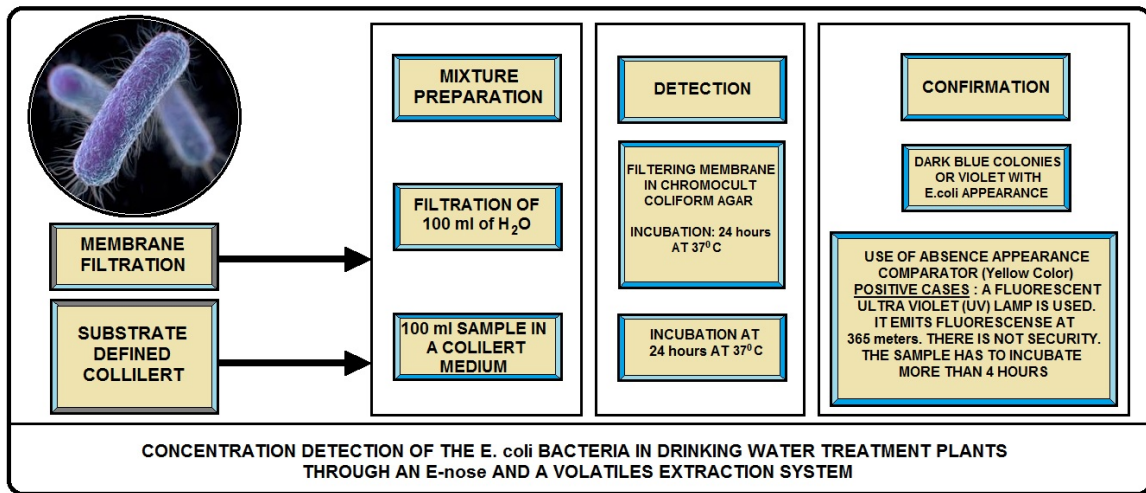

CONVENTIONAL BACTERIOLOGICAL MONITORING



Sampling Siting Procedures –Sub-Section

The sample siting plan must be followed and all operating staff must be clear on how to follow the sampling plan. In order to properly implement the sample-siting plan, staff must be aware of how often sampling must be done, the proper procedures and sampling containers to be used for collecting the samples, and the proper procedures for identification, storage and transport of the samples to an approved laboratory.

In addition, proper procedures must be followed for repeat sampling whenever a routine sample result is positive for total coliform.

What is a Sample Siting Plan?

A written sample siting plan specifies the routine sampling schedule and the locations (i.e., routine and repeat) in the distribution system where TC samples are collected. The locations selected must be representative of the finished water supplied to consumers. The purpose of sampling is to identify any coliform contamination so it can be dealt with quickly. Sample siting plans are subject to primacy agency review and revision. A sample siting plan must include the:

- PWS's sample sites (i.e., the location) where routine and repeat samples are collected: if approved by the primacy agency, also include sample sites for dual purpose samples that are used to meet the requirements for the RTCR repeat sampling and the Groundwater Rule (GWR) triggered source water monitoring.
- PWS's schedule for collecting the routine samples: For example, "[PWS_ID] will collect one routine TC sample every first Tuesday of the calendar month." The sample siting plan is a living document and should be updated to reflect changes to the PWS such as: major changes in population; new or additional water sources; infrastructure changes, such as a change in the distribution system (i.e., extended/ abandoned lines or pressure zones); or changes in disinfection or other treatment.



Most everyone can learn and master many of the basic lab procedures. Don't be intimidated, learn to take samples and analysis; it is an excellent career.

Chain of Custody Procedures

Because a sample is physical evidence, chain of custody procedures are used to maintain and document sample possession from the time the sample is collected until it is introduced as evidence.

Chain of custody requirements will vary from agency to agency. However, these procedures are similar and the chain of custody procedure outlined in this course manual is only a guideline. Consult your project manager or state agency for specific requirements.

If you have physical possession of a sample, have it in view, or have physically secured it to prevent tampering then it is defined as being in **“custody.”** A chain of custody record, therefore, begins when the sample containers are obtained from the laboratory. From this point on, a chain of custody record will accompany the sample containers.

Handle the samples as little as possible in the field. Each custody sample requires a chain of custody record and may require a seal. If you do not seal individual samples, then seal the containers in which the samples are shipped.

When the samples transfer possession, both parties involved in the transfer must sign, date and note the time on the chain of custody record. If a shipper refuses to sign the chain-of-custody you must seal the samples and chain of custody documents inside a box or cooler with bottle seals or evidence tape.

The recipient will then attach the shipping invoices showing the transfer dates and times to the custody sheets. If the samples are split and sent to more than one laboratory, prepare a separate chain of custody record for each sample. If the samples are delivered to after-hours night drop-off boxes, the custody record should note such a transfer and be locked with the sealed samples inside sealed boxes.



Using alcohol to disinfect a special sample tap before obtaining a sample.

Laboratory 123 W. Main St Sun City, Arizona 85541										LAB I.D. NUMBER	
Sampler:										PAGE 1 OF 1	
DATE:											
Company:											
Department:											
Address:											
Contact:											
Telephone:											
Metals* See Attached											
TSS											
Lead/Copper											
BOD/COD											
Nitrate											
Nitrate + Nitrite											
TKN / Amonia											
VOC / THM's											
Semi Volital Organics (625)											
Chloride											
Cyanide											
Floride											
Surfactants (MBAS)											
Tot. Coliform MPN											
Fecal Coliform MPN-HPC											
Organo-Phosphorus Pest. (8141)											
Sulfate											
EC Conductivity											
Number/Containers											
Sample Receipt											
Project Name											
No. Containers:											
Custody Seals:											
Received Intact:											
Received Cold:											
Temperature:											
PRIORITY:											
Field Measurements:											
pH:											
Temp:											
RELINQUISHED BY:											
Signature:										Signature:	
Printed Name:										Printed Name:	
Company:										Company:	
SAMPLED RECEIVED BY:											
Signature:										Signature:	
Printed Name:										Printed Name:	
Company:										Company:	

Chain of Custody Example.



Various water sample bottles and chain-of-custody form.

Summary

Factors in Chlorine Disinfection: Concentration and Contact Time

In an attempt to establish more structured operating criteria for water treatment disinfection, the CXT concept came into use in 1980. Based on the work of several researchers, CXT values [final free chlorine concentration (mg/L) multiplied by minimum contact time (minutes)], offer water operators guidance in computing an effective combination of chlorine concentration and chlorine contact time required to achieve disinfection of water at a given temperature.

The CXT formula demonstrates that if an operator chooses to decrease the chlorine concentration, the required contact time must be lengthened. Similarly, as higher strength chlorine solutions are used, contact times may be reduced (Connell, 1996).

Detection and investigation of waterborne disease outbreaks is the primary responsibility of local, state and territorial public health departments, with voluntary reporting to the CDC. The CDC and the U.S. Environmental Protection Agency (EPA) collaborate to track waterborne disease outbreaks of both microbial and chemical origins. Data on drinking water and recreational water outbreaks and contamination events have been collected and summarized since 1971.

While useful, statistics derived from surveillance systems do not reflect the true incidence of waterborne disease outbreaks because many people who fall ill from such diseases do not consult medical professionals.

For those who do seek medical attention, attending physicians and laboratory and hospital personnel are required to report diagnosed cases of waterborne illness to state health departments. Further reporting of these illness cases by state health departments to the CDC is voluntary, and statistically more likely to occur for large outbreaks than small ones.

Despite these limitations, surveillance data may be used to evaluate the relative degrees of risk associated with different types of source water and systems, problems in current technologies and operating conditions, and the adequacy of current regulations. (Craun, Nwachuku, Calderon, and Craun, 2002).

Understanding Cryptosporidiosis

Cryptosporidium is an emerging parasitic protozoan pathogen because its transmission has increased dramatically over the past two decades. Evidence suggests it is newly spread in increasingly popular day-care centers and possibly in widely distributed water supplies, public pools and institutions such as hospitals and extended-care facilities for the elderly.

Recognized in humans largely since 1982 and the start of the AIDS epidemic, Cryptosporidium is able to cause potentially life-threatening disease in the growing number of immunocompromised patients.

Cryptosporidium was the cause of the largest reported drinking water outbreak in U.S. history, affecting over 400,000 people in Milwaukee in April 1993. More than 100 deaths are attributed to this outbreak. Cryptosporidium remains a major threat to the U.S. water supply (Ibid.).

The EPA is developing new drinking water regulations to reduce *Cryptosporidium* and other resistant parasitic pathogens. Key provisions of the Long Term 2 Enhanced Surface Water Treatment Rule include source water monitoring for *Cryptosporidium*; inactivation by all unfiltered systems; and additional treatment for filtered systems based on source water

Cryptosporidium concentrations. EPA will provide a range of treatment options to achieve the inactivation requirements. Systems with high concentrations of *Cryptosporidium* in their source water may adopt alternative disinfection methods (e.g., ozone, UV, or chlorine dioxide).

However, most water systems are expected to meet EPA requirements while continuing to use chlorination. Regardless of the primary disinfection method used, water systems must continue to maintain residual levels of chlorine-based disinfectants in their distribution systems.

Understanding *Giardia lamblia*

Giardia lamblia, discovered approximately 20 years ago, is another emerging waterborne pathogen. This parasitic microorganism can be transmitted to humans through drinking water that might otherwise be considered pristine. In the past, remote water sources that were not affected by human activity were thought to be pure, warranting minimal treatment. However, it is known now that all warm-blooded animals may carry *Giardia* and that beaver are prime vectors for its transmission to water supplies.

There is a distinct pattern to the emergence of new pathogens. First, there is a general recognition of the effects of the pathogen in highly susceptible populations such as children, cancer patients and the immunocompromised.

Next, practitioners begin to recognize the disease and its causative agent in their own patients, with varied accuracy. At this point, some may doubt the proposed agent is the causative agent, or insist that the disease is restricted to certain types of patients.

Finally, a single or series of large outbreaks result in improved attention to preventive efforts. From the 1960's to the 1980's this sequence of events culminated in the recognition of *Giardia lamblia* as a cause of gastroenteritis (Lindquist, 1999).

Bacteriological Monitoring Section Post Quiz

True or False

1. Total coliforms are a group of closely related viruses that are (with few exceptions) not harmful to humans. They are an indicator of other pathogens that can be present in water.
2. Fecal coliform bacteria are present in warm-blooded animals and they are shed from the body in the feces. Because these organisms are shed from the body in large numbers and are relatively easy to detect in the laboratory, they have been accepted as a guideline of water or food contamination.
3. All bacteriological samples are analyzed for the coliform group; however, a positive reaction to these coliform analyses may be from sources other than fecal. In order to differentiate between these sources, all samples that are total coliform positive must be analyzed again to determine if fecal coliform or *E. coli* are present.
4. To comply with the monthly MCL for total coliforms (TC), PWSs must not find coliforms in more than fifty percent of the samples they take each month to meet EPA's standards. If more than twenty percent of the samples contain coliforms, PWS operators must report this violation to the state and the public.
5. If a sample tests positive for TC, the system must collect a set of repeat samples located within 10 or fewer sampling sites adjacent to the location of the routine positive sample within 48 hours.
6. When a routine or repeat sample tests positive for total coliforms, it must also be analyzed for fecal coliforms or *E. coli*, which are types of coliform bacteria that are directly associated with feces.
7. A positive result for fecal coliforms or *E. coli* can signify an acute MCL violation, which necessitates rapid state and public notification because it represents a direct health risk.
8. At times, an acute violation due to the presence of fecal coliform or *E. coli* may result in a "boil water" notice. The system must also take at least 5 routine samples the next month of operation if any sample tests positive for total coliforms.

9. A coliform sample site plan is a list of sites by street address, lot number, or other permanent description, that identifies all the approved locations where your routine (monthly) coliform samples may be collected. The list of sites must be plotted on a map of your service area.

10. Small water systems shall divide their distribution system into specific sample areas.

Topic 7 -Advanced Water Treatment Section

Section Focus: You will learn the basics of dealing with hard water, related issues and advanced water treatment methods. At the end of this section, you will be able to describe various treatment methods including Microfiltration and Reverse Osmosis to alternative disinfection methods. There is a post quiz at the end of this section to review your comprehension and a final examination in the Assignment for your contact hours.

Scope/Background: Water contains Endocrine-Disrupting Compounds (EDCs), contaminants and various amounts of dissolved minerals, some of which impart a quality known as hardness. It is necessary for many water treatment facilities to treat these concerns without conventional water treatment methods. EPA has promulgated many rules and regulations as a result of the SDWA that require drinking water utilities to meet specific guidelines and numeric standards for water quality, some of which are enforceable and collectively referred to as maximum contaminant levels (MCLs).

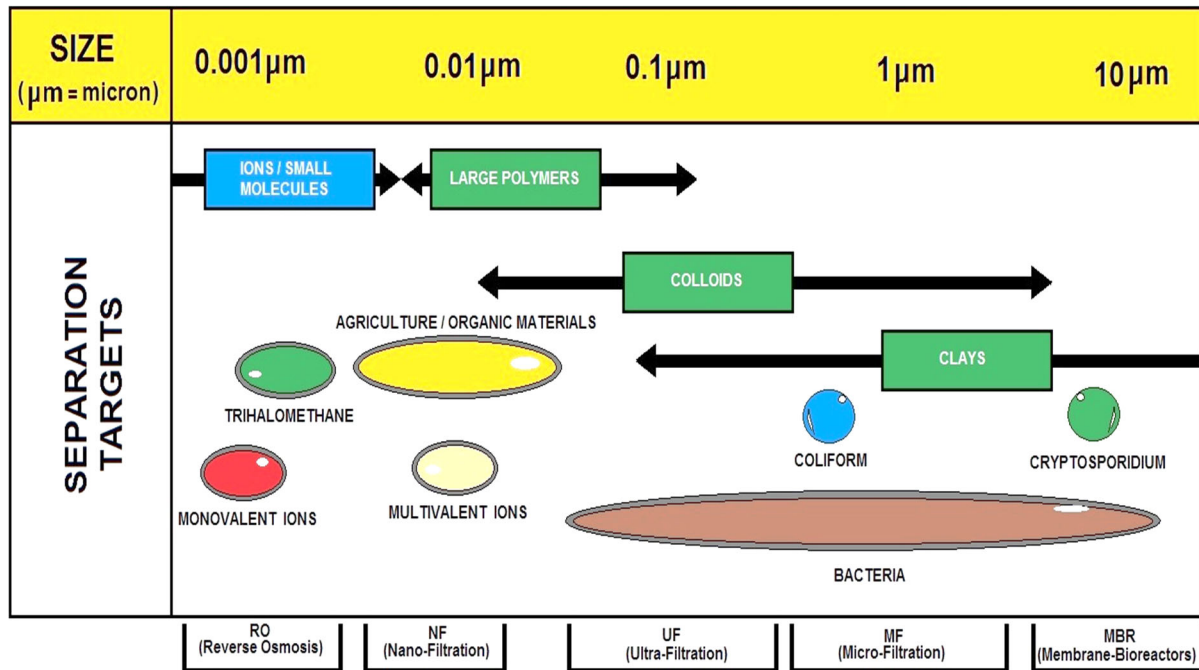

ADVANCED TREATMENT REMOVAL METHOD DIAGRAM

We will cover the primary advanced water treatment applications, advantages, and disadvantages of various processes arranged in such a way as to provide a ready comparison between alternative treatment processes.

There are a number of different treatments used in various configurations to make up an advanced water treatment system. The particular situation and/or contaminant determines the most applicable process design, for example, removal of Arsenic, metals, or endocrine-disrupting compounds (EDCs).

Many advanced processes, although selected on the basis of their effectiveness in removal of a particular pollutant, obtain additional benefits in the control of other pollutants and contaminants.

The advanced water treatment processes, include: chemical water treatment processes, advanced oxidation processes, desalination and membrane technology.

Endocrine-Disrupting Compounds (EDCs)

Compounds that can alter the endocrine system of humans and animals have been detected in water supplies around the world as the result of human activities. These substances are known as endocrine-disrupting compounds (EDCs) and have been linked to a variety of adverse effects in both humans and wildlife including hormone dependent cancers, reproductive tract disorders, and reduction in reproductive fitness.

Pharmaceutical compounds and personal care products have been collectively termed as PPCPs. Many EDCs and PPCPs have been detected in surface waters, a few of which have been detected in finished drinking water, fish and invertebrates. The detection of EDCs and PPCPs in source waters is of great concern since these compounds have known physiological responses at low concentrations.

Heavy Metals

Heavy metals can be removed by using aluminum-based coagulants. There are also other ways like using Iron/iron oxide based coagulants, zeolites etc. but they may be expensive compared to aluminum-based coagulants. Activated carbon can be used as adsorbent for removing heavy metals.

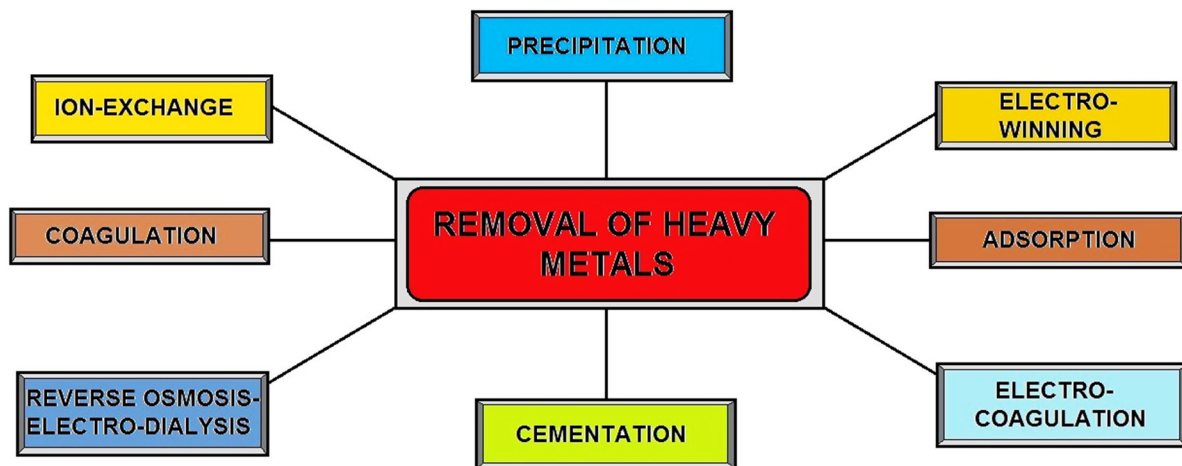

METHODS TO REMOVE HEAVY METALS IN WATER

Hard Water Sub-Section

Water contains various amounts of dissolved minerals, some of which impart a quality known as hardness. Consumers frequently complain about problems attributed to hard water, such as the formation of scale on cooking utensils and hot water heaters. In this document, we will examine the occurrences, and effects of hard water and the hard water treatment or softening process that removes the hardness-causing minerals.

GENERAL HARDNESS	
TEMPORARY HARDNESS or CARBONATE HARDNESS (KH)	PERMANENT HARDNESS or NON-CARBONATE HARDNESS (NCH)
CALCIUM (Ca) Carbonate and MAGNESIUM (Mg) Carbonate	CALCIUM (Ca) & MAGNESIUM (Mg) SULFATES
	CALCIUM (Ca) & MAGNESIUM (Mg) CHLORIDES
	CALCIUM (Ca) & MAGNESIUM (Mg) NITRATES



FORMS OF HARDNESS IN WATER

Occurrence of Hard Water

Hard water is caused by soluble, divalent, metallic cations, (positive ions having valence of 2). The principal chemicals that cause water hardness are calcium (**Ca**) and magnesium (**Mg**). Strontium, aluminum, barium, and iron are usually not present in large enough concentrations to contribute significantly to the total hardness.

WATER HARDNESS (Salt Types)	
CARBONATE HARDNESS COMPOUNDS	NON-CARBONATE HARDNESS COMPOUNDS
CALCIUM CARBONATE (CaCO_3)	CALCIUM SULPHATE (CaSO_4)
MAGNESIUM CARBONATE (MgCO_3)	MAGNESIUM SULPHATE (MgSO_4)
CALCIUM BICARBONATE ($\text{Ca}(\text{HCO}_3)_2$)	CALCIUM CHLORIDE (CaCl_2)
MAGNESIUM BICARBONATE ($\text{Mg}(\text{HCO}_3)_2$)	MAGNESIUM CHLORIDE (MgCl_2)
CALCIUM HYDROXIDE ($\text{Ca}(\text{OH})_2$)	
MAGNESIUM HYDROXIDE ($\text{Mg}(\text{OH})_2$)	



CAUSES OF HARDNESS THAT AFFECTS WATER QUALITY

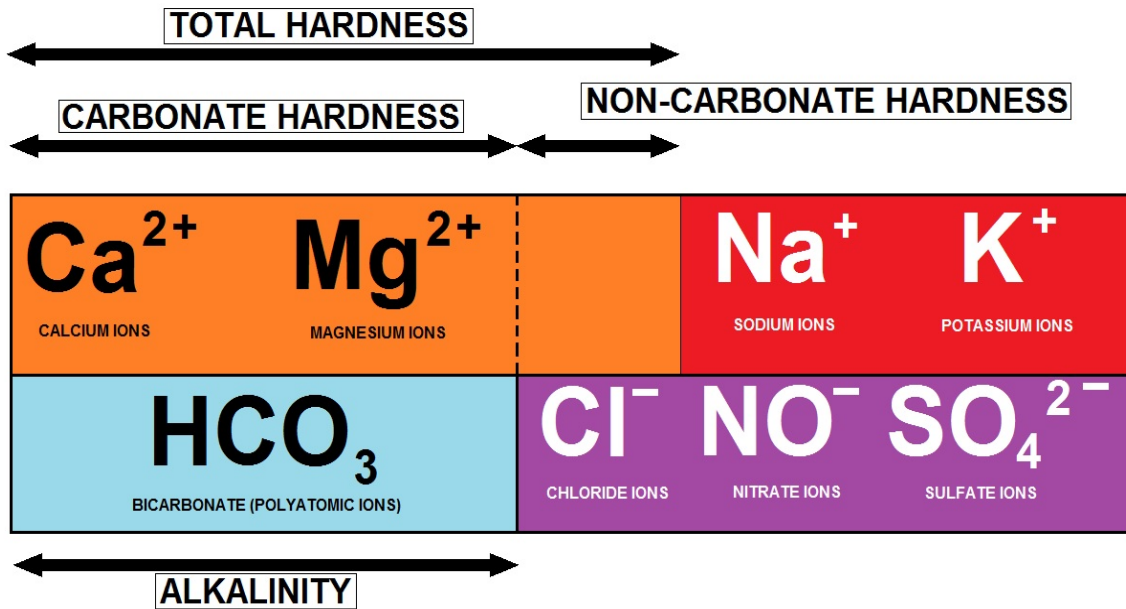

CARBONATE HARDNESS CHART

WATER HARDNESS SCALE		
Grains/Gal.	mg/L or PPM	Classification
LESS THAN 1	LESS THAN 17.1	SOFT
1 - 3.5	17.1 - 60	SLIGHTLY HARD
3.5 - 7	60 - 120	MODERATELY HARD
7 - 10	120 - 180	HARD
Over 10	Over 180	VERY HARD

1 gpg = 17.1 mg/L = 17.1 ppm

Expressing Water Hardness Concentration

Water hardness is generally expressed as a concentration of calcium carbonate, in terms of milligrams per liter as CaCO₃. The degree of hardness that consumers consider objectionable will vary, depending on other qualities of the water and on the hardness to which they have become accustomed. We will show two different classifications of the relative hardness of water:

Comparative classifications of water for softness and hardness

Classification	mg/L as CaCO ₃ *	mg/L as CaCO ₃ +
Soft	0 – 75	0 – 60
Moderately hard	75 – 150	61 – 120
Hard	150 – 300	121 – 180
Very hard	Over 300	Over 180

Source: Adapted from sawyer 1960 and Briggs and Ficke 1977.

* Per Sawyer (1960)

+ Per Briggs and Ficke (1977)

German Hardness °dH	mg/l calcium oxide	mg/l calcium carbonate	Water conditions
0 - 3	0 - 30	0 - 50	Soft
3 - 6	30 - 60	50 - 100	Moderately soft
6 - 12	60 - 120	100 - 200	Slightly hard
12 - 18	120 - 180	200 - 300	Moderately hard
18 - 25	180 - 250	300 - 450	Hard
25 +	250 +	450 +	Very hard

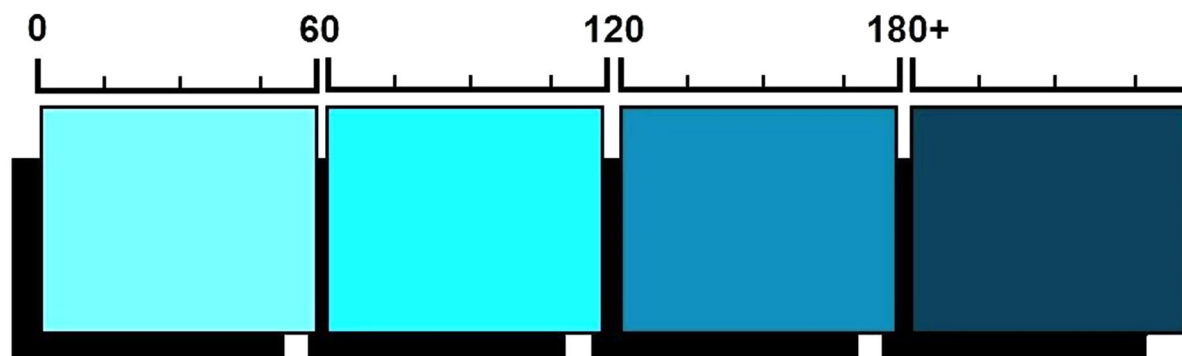

MEASURING HARDNESS –CALCIUM IONS CHART

Types of Water Hardness

Hardness can be categorized by either of two methods: calcium versus magnesium hardness and carbonate versus non-carbonate hardness. The calcium-magnesium distinction is based on the minerals involved.

Calcium Hardness

Hardness caused by calcium is called calcium hardness, regardless of the salts associated with it, which include calcium sulfate (**CaSO₄**), calcium chloride (**CaCl₂**), and others. Likewise, hardness caused by magnesium is called magnesium hardness. Calcium and magnesium are normally the only significant minerals that cause hardness, so it is generally assumed that

$$\text{Total hardness} = \text{calcium hardness} + \text{magnesium hardness}$$

The carbonate-noncarbonate distinction, however, is based on hardness from either the bicarbonate salts of calcium or the normal salts of calcium and magnesium involved in causing water hardness.

Carbonate hardness is caused primarily by the bicarbonate salts of calcium and magnesium, which are calcium bicarbonate, Ca(HCO₃)₂, and magnesium bicarbonate Mg(HCO₃)₂.

Calcium and magnesium combined with carbonate (CO₃) also contribute to carbonate hardness.

Noncarbonate hardness is a measure of calcium and magnesium salts other than carbonate and bicarbonate salts. These salts are calcium sulfate, calcium chloride, magnesium sulfate (MgSO₄), and magnesium chloride (MgCl₂).

Calcium and magnesium combined with nitrate may also contribute to noncarbonate hardness, although it is a very rare condition.

For carbonate and noncarbonate hardness,

$$\text{Total hardness} = \text{carbonate hardness} + \text{noncarbonate hardness}$$

When hard water is boiled, carbon dioxide (CO₂) is driven off, and Bicarbonate salts of calcium and magnesium then settle out of the water to form calcium and magnesium carbonate precipitates. These precipitates form the familiar chalky deposits on teapots.

Because it can be removed by heating, carbonate hardness is sometimes called “**Temporary hardness.**”

Because noncarbonated hardness cannot be removed or precipitated by prolonged boiling, it is sometimes called “**permanent hardness.**”

HARD WATER LEVELS THROUGHOUT THE U.S.

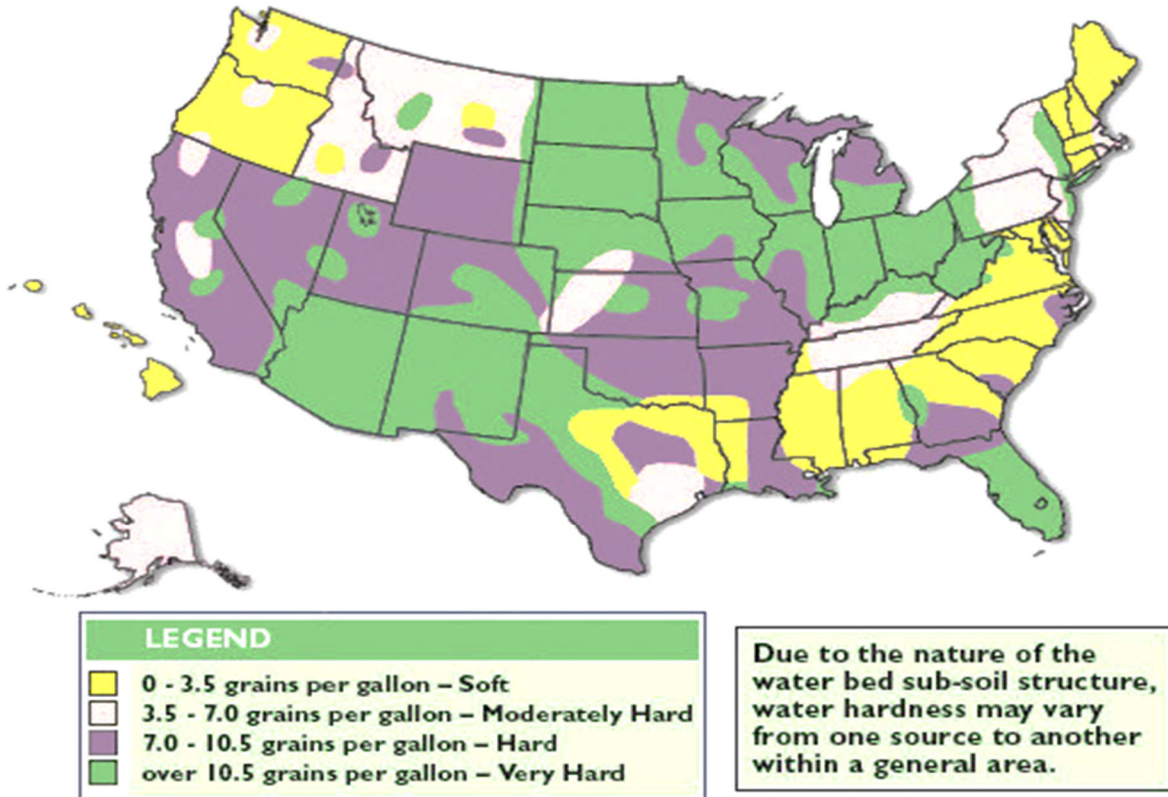

Note: 1 grain/gallon = 17.1 ppm hardness as CaCO₃.

Geologic Formations

Water hardness varies considerably in different geographic areas of the contiguous 48 states. This is due to different geologic formations, and is also a function of the contact time between water and limestone deposits, which leech calcium into the water.

Magnesium

Magnesium is dissolved as water passes over and through dolomite and other magnesium-bearing minerals. Because groundwater is in contact with these formations for a longer period of time than surface water, groundwater is normally harder than surface water.

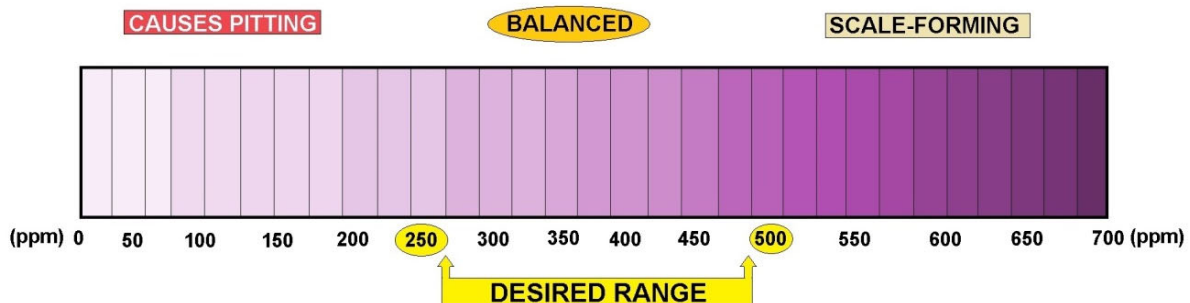

CALCIUM HARDNESS MEASUREMENT

Water Softening Processes

Precipitation Process

The precipitation process most frequently used is generally known as the lime process or lime soda process. Because of the special facilities required and the complexity of the process, it is generally applicable only to medium- or large-size water systems where all treatment can be accomplished at a central location. This process will provide softened water at the lowest cost. Lime softening can be used for treatment of either groundwater or surface water sources.

Distillers

Various sizes of distillers are available for home use. They all work on the principle of vaporizing water and then condensing the vapor. In the process, dissolved solids such as salt, metals, minerals, asbestos fibers, and other particles are removed. Some organic chemicals are also removed, but those that are more volatile are often vaporized and condensed with the product water. Distillers are effective in killing all microorganisms.



The principal problem with a distiller is that a small unit can produce only 2-3 gal (7.5 -11 Lt) a day, and that the power cost for operation will be substantially higher than the operating cost of other types of treatment devices.

Water Distillers have a high energy cost (approximately 20-30 cents per gallon). They must be carbon filtered before and/or after to remove volatile chemicals. It is considered "**dead**" water because the process removes all extra oxygen and energy. It has no taste. It is still second only to reverse osmosis water for health. The diet of a person drinking distilled water should be rich in electrolytes because as the aggressive nature of distilled water can "**leach**" electrolytes from the body.

Water softening is a method of removing from water the minerals that make it hard. Hard water does not dissolve soap readily. It forms scale in pipes, boilers, and other equipment in which it is used. The principal methods of softening water are the lime soda process and the ion exchange process.

In the **lime soda process**, soda ash and lime are added to the water in amounts determined by chemical tests. These chemicals combine with the calcium and magnesium in the water to make insoluble compounds that settle to the bottom of the water tank.

Ion Exchange Processes Introduction

The other commonly used method of softening involves the ion exchange process. This process has the advantages of a considerably lower initial cost and ease of use by small systems or by large systems at multiple locations. The principal disadvantage is that operating costs are considerably higher.

Ion exchange processes can typically be used for direct treatment of groundwater, so long as turbidity and iron levels are not excessive. For treatment of surface water, the process normally must be preceded by conventional treatment. Softening can also be accomplished using membrane technology, electrodialysis, distillation, and freezing. Of these, membrane methods seem to have the greatest potential.

In the **ion exchange process**, the water filters through minerals called **zeolites**. As the water passes through the filter, the sodium ions in the zeolite are exchanged for the calcium and magnesium ions in the water, and the water is softened. After household softeners become exhausted, a strong solution of **sodium chloride** (salt) is passed through the filter to replace the sodium that has been lost.



The use of two exchange materials makes it possible to remove both metal and acid ions from water. Some cities and towns, however, prohibit or restrict the use of ion exchange equipment on drinking water, pending the results of studies on how people are affected by the consumption of the added sodium in softened water. The commercial ion exchange containers hold the resin for the deionization.

Calcium and magnesium in water create hard water, and high levels can clog pipes. The best way to soften water is to use a water softener unit connected into the water supply line. You may want to consider installing a separate faucet for unsoftened water for drinking and cooking. Water softening units also remove iron.

The most common way to soften household water is to use a water softener. Softeners may also be safely used to remove up to about 5 milligrams per liter of dissolved iron if the water softener is rated for that amount of iron removal. Softeners are automatic, semi-automatic, or manual. Each type is available in several sizes and is rated on the amount of hardness it can remove before regeneration is necessary.

Using a softener to remove iron in naturally soft water is not advised; a green-sand filter is a better method. When the resin is filled to capacity, it must be recharged. Fully automatic softeners regenerate on a preset schedule and return to service automatically. Regeneration is usually started by a preset time clock; some units are started by water use meters or hardness detectors.

Semi-automatic softeners have automatic controls for everything except for the start of regeneration. Manual units require manual operation of one or more valves to control back washing, brining and rinsing.

In many areas, there are companies that provide a water softening service. For a monthly fee the company installs a softener unit and replaces it periodically with a freshly charged unit.

The principle behind water softening is really just simple chemistry. A water softener contains resin beads which hold electrically charged ions. When hard water passes through the softener, calcium and magnesium ions are attracted to the charged resin beads.

It's the resulting removal of calcium and magnesium ions that produces "**soft water**." The diagram shows the exchange that takes place during the water softening process. When the resin beads in your softener become saturated with calcium and magnesium ions, they need to be recharged.

Sodium ions from the water softening salt reactivate the resin beads so they can continue to do their job. Without sufficient softening salt, your water softener is less efficient. As a rule, you should check your water softener once a week to be sure the salt level is always at least one quarter full.

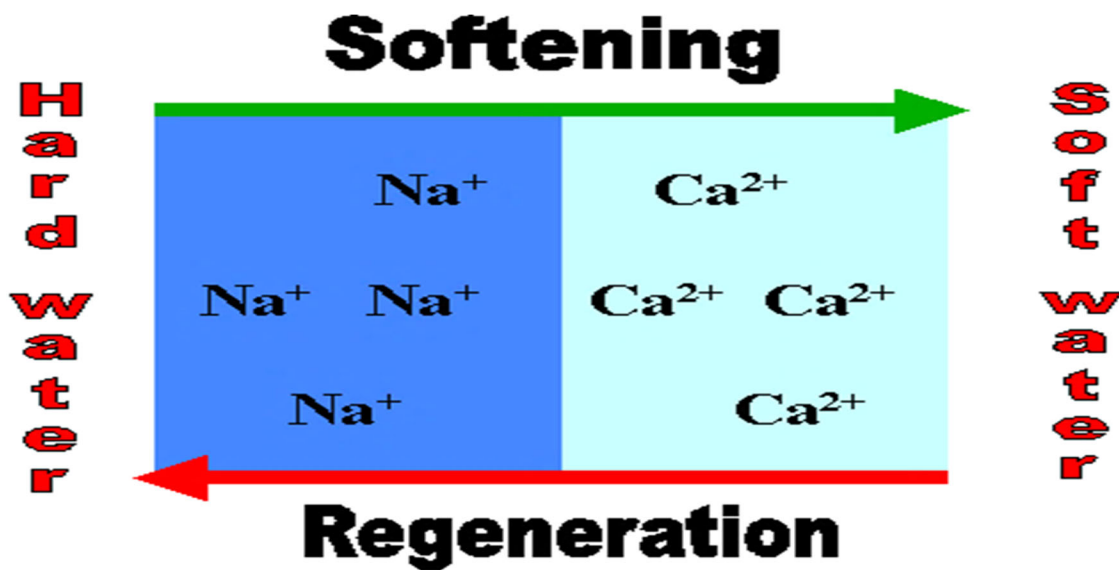

PROPERTY of WATER BEING TESTED	RECOMMENDED LEVEL PARAMETERS
pH	6.5 - 9.0 pH
HARDNESS as CaCO	30 - 750 ppm
ALKALINITY as CaCO	500 ppm Maximum
TOTAL DISSOLVED SOLIDS (TDS)	1500 ppm Maximum
CONDUCTIVITY	2400 micromhos
CHLORIDES	250 ppm Maximum Cl (Chloride) (410 ppm Maximum as NaCl (Sodium Chloride))
SULPHATES	250 ppm
SILICA	5 - 25 milligrams/l Maximum



WATER QUALITY PARAMETERS TO CONTROL CORROSION AND SCALE (Recommended levels)

Advanced Water Treatment Methods Sub-Section

Membrane Filtration Processes

In 1748, the French physicist Nollet first noted that water would diffuse through a pig bladder membrane into alcohol. This was the discovery of osmosis, a process in which water from a dilute solution will naturally pass through a porous membrane into a concentrate solution.

Over the years, scientists and engineers have attempted to develop a membrane that would be useful in industrial processes or for difficult contaminants, but it wasn't until the late 1950s that membranes were produced that could be used for what is known as reverse osmosis. In reverse osmosis, water is forced to move through a membrane from a concentrate solution to a dilute solution.

Since that time, continual improvements and new developments have been made in membrane technology, resulting in ever-increasing uses in many industries. In potable water treatment, membranes have been used for desalinization, removal of dissolved inorganic and organic chemicals, water softening, and removal of fine solids.

In particular, membrane technology enables some water systems having contaminated water sources to meet new, more stringent regulations. In some cases, it can also allow secondary sources, such as brackish groundwater, to be used. There is great potential for the continuing wide use of membrane filtration processes in potable water treatment, especially as technology is improved and costs are reduced.

Description of Membrane Filtration Processes

In the simplest membrane processes, water is forced through a porous membrane under pressure, while suspended solids, large molecules, or ions are held back or rejected.

Types of Membrane Filtration Processes

The two general classes of membrane processes, based on the driving force used to make the process work, are:

- Pressure-driven processes
- Electric-driven processes

Pressure-Driven Processes

The four general membrane processes that operate by applying pressure to the raw water are:

- Microfiltration
- Ultrafiltration
- Nanofiltration
- Reverse Osmosis



Membrane Filtration System

Microfiltration

Microfiltration (MF) is a process in which water is forced under pressure through a porous membrane. Membranes with a pore size of 0.45 μm (microns) are normally used; this size is relatively large compared with the other membrane filtration processes. This process has not been generally applicable to drinking water treatment because it either does not remove substances that require removal from potable water, or the problem substances can be removed more economically using other processes.

μm Definition

The symbol μm stands for micron. There are 1000 μm in one millimeter. A human hair is 40 to 50 μm across and bacteria may be only 0.5- μm wide and 1- μm long.

The current primary use of MF is by industries to remove very fine particles from process water, such as in electronic manufacturing. In addition, the process has also been used as a pretreatment for other membrane processes. In particular, Reverse Osmosis (RO) membranes are susceptible to clogging or binding unless the water being processed is already quite clean.

However, in recent years, microfiltration has been proposed as a filtering method for particles resulting from the direct filtration process. Traditionally, this direct filtration process has used the injection of coagulants such as alum or polymers into the raw water stream to remove turbidity such as clay or silts. The formed particles were then removed by rapid sand filters. Their suggested use is to improve filtering efficiency, especially for small particles that could contain bacterial and protozoan life.

Ultrafiltration

Ultrafiltration (UF) is a process that uses a membrane with a pore size generally below 0.1 μm . The smaller pore size is designed to remove colloids and substances that have larger molecules, which are called high-molecular-weight materials. UF membranes can be designed to pass material that weigh less than or equal to a certain molecular weight. This weight is called the molecular weight cutoff (MWC) of the membrane. Although UF does not generally work well for removal of salt or dissolved solids, it can be used effectively for removal of most organic chemicals.

Nanofiltration

Nanofiltration (NF) is a process using membrane that will reject even smaller molecules than UF. The process has been used primarily for water softening and reduction of total dissolved solids (TDS). NF operates with less pressure than reverse osmosis and is still able to remove a significant proportion of inorganic and organic molecules. This capability will undoubtedly increase the use of NF for potable water treatment.

Reverse Osmosis

Reverse Osmosis (RO) is a membrane process that has the highest rejection capability of all the membrane processes. RO membranes have a very low pore size that can reject ions at very high rates, including chloride and sodium. Water from this process is very pure due to the high reject rates. The process has been used primarily in the water industry for desalinization of seawater because the capital and operating costs are competitive with other processes for this service.

The RO also works for most organic chemicals, radionuclides and microorganisms. Industrial water uses such as semiconductor manufacturing, also use the RO process. RO is discussed in more detail later.

Water Treatment Process

Perhaps the most prominent use of microfiltration membranes pertains to the treatment of potable water supplies. The membranes are a key step in the primary disinfection of the uptake water stream. Such a stream might contain pathogens such as the protozoa *Cryptosporidium* and *Giardia lamblia* which are responsible for numerous disease outbreaks. Both species show a gradual resistance to traditional disinfectants (i.e. chlorine).

The use of MF membranes presents a physical means of separation (a barrier) as opposed to a chemical alternative. In this sense, both filtration and disinfection take place in a single step, reducing the cost of chemical dosage and the corresponding equipment needed for handling and storage.

Similarly, the MF membranes are used in secondary wastewater effluents to remove turbidity but also to provide treatment for disinfection. At this stage, coagulants (iron or aluminum) may potentially be added to precipitate species such as phosphorus and arsenic which would otherwise have been soluble.

Sterilization

Another crucial application of MF membranes lies in the cold sterilization of beverages and pharmaceuticals. Historically, heat was used to sterilize refreshments such as juice, wine and beer in particular, however a palatable loss in flavor was clearly evident upon heating. Similarly, pharmaceuticals have been shown to lose their effectiveness upon heat addition. MF membranes are employed in these industries as a method to remove bacteria and other undesired suspensions from liquids, a procedure termed as 'cold sterilization', which negates the use of heat.

Driving Force, Retentate Stream and Permeate Streams

Membrane filtration processes can be distinguished by three major characteristics; Driving force, retentate stream and permeate streams.

The microfiltration process is pressure driven with suspended particles and water as retentate and dissolved solutes plus water as permeate. The use of hydraulic pressure accelerates the separation process by increasing the flow rate (flux) of the liquid stream but does not affect the chemical composition of the species in the retentate and product streams.

Fouling

A major characteristic that limits the performance of microfiltration or any membrane technology is a process known as fouling. Fouling describes the deposition and accumulation of feed components such as suspended particles, impermeable dissolved solutes or even permeable solutes, on the membrane surface and or within the pores of the membrane.

Fouling of the membrane during the filtration processes decreases the flux and thus overall efficiency of the operation. This is indicated when the pressure drop increases to a certain point. It occurs even when operating parameters are constant (pressure, flow rate, temperature and concentration). Fouling is eventually complete and irreversible although a portion of the fouling layer can be reversed by repeatedly cleaning the membranes.

Membrane Configurations

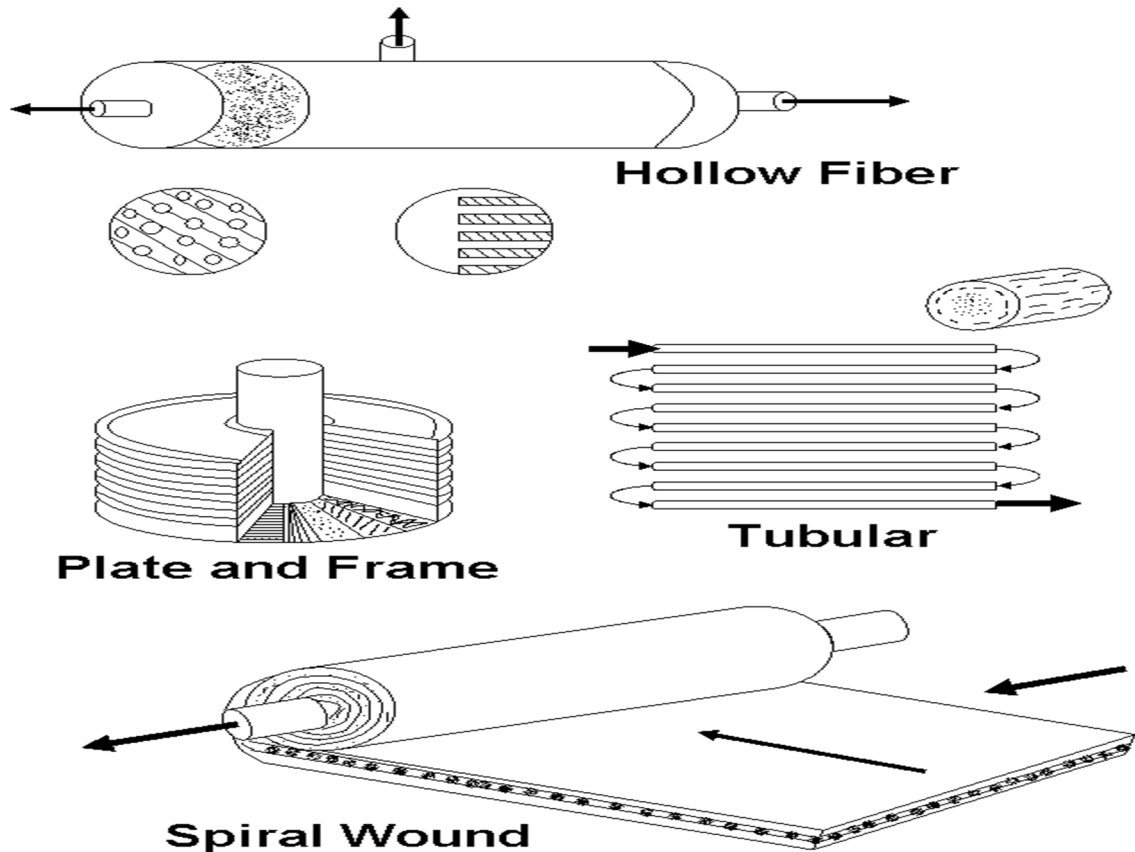

Types of Processes

Membrane separation processes operate without heating and therefore use less energy than conventional thermal separation processes such as distillation, sublimation or crystallization. The separation process is purely physical and both fractions (permeate and retentate) can be used.

Cold separation using membrane technology is widely used in the food technology, biotechnology and pharmaceutical industries. Using membranes enables separations to take place that would be impossible using thermal separation methods. For example, it is impossible to separate the constituents of azeotropic liquids or solutes which form isomorphous crystals by distillation or recrystallization but such separations can be achieved using membrane technology.

Nanofiltration is also becoming more widely used in food processing applications such as dairy, for simultaneous concentration and partial (monovalent ion) demineralization.

Electric-Driven Processes

There are two membrane processes that purify a water stream by using an electric current to move ions across a membrane.

These processes are

- Electrodialysis
- Electrodialysis Reversal

Electrodialysis

Electrodialysis (ED) is a process in which ions are transferred through a membrane as a result of direct electric current applied to the solution. The current carries the ions through a membrane from the less concentrated solution to the more concentrated one.

Electrodialysis Reversal

Electrodialysis Reversal (EDR) is a process similar to ED, except that the polarity of the direct current is periodically reversed. The reversal in polarity reverses the flow of ions between demineralizing compartments, which provides automatic flushing of scale-forming materials from the membrane surface.

As a result, EDR can often be used with little or no pretreatment of feedwater to prevent fouling. So far, ED and EDR have been used at only a few locations for drinking water treatment.

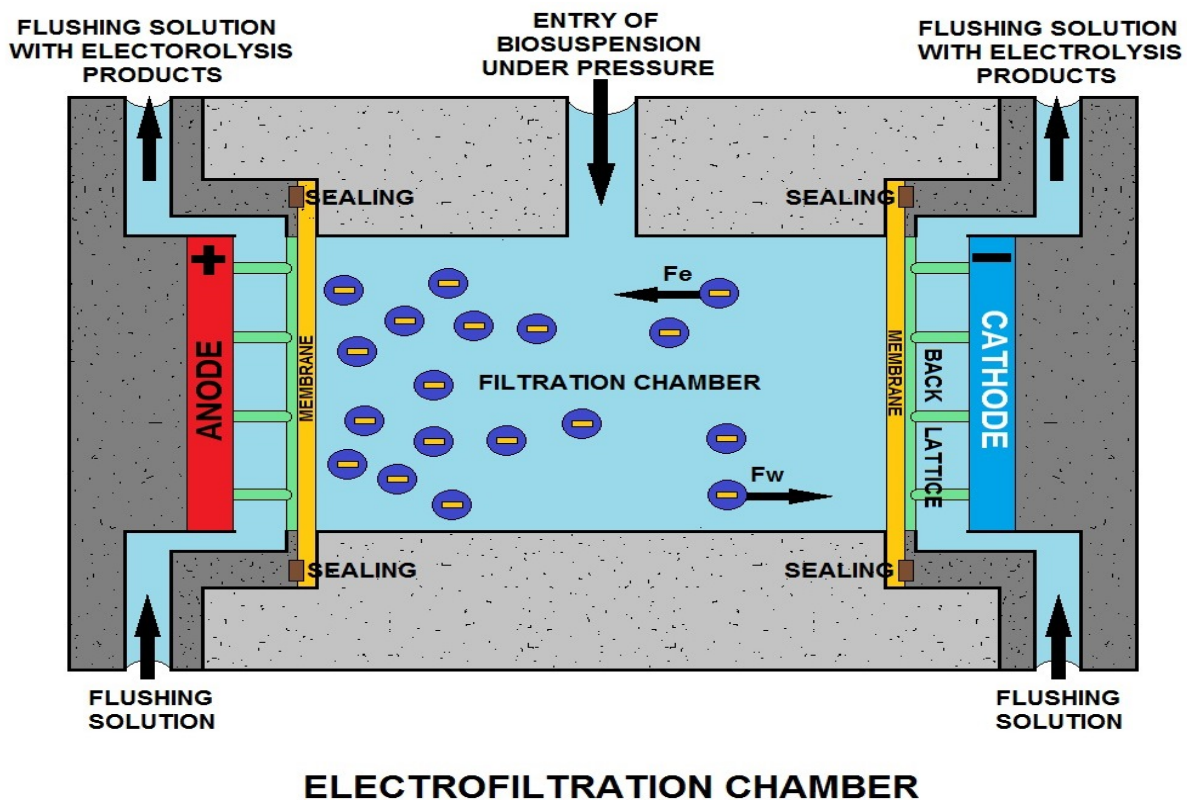

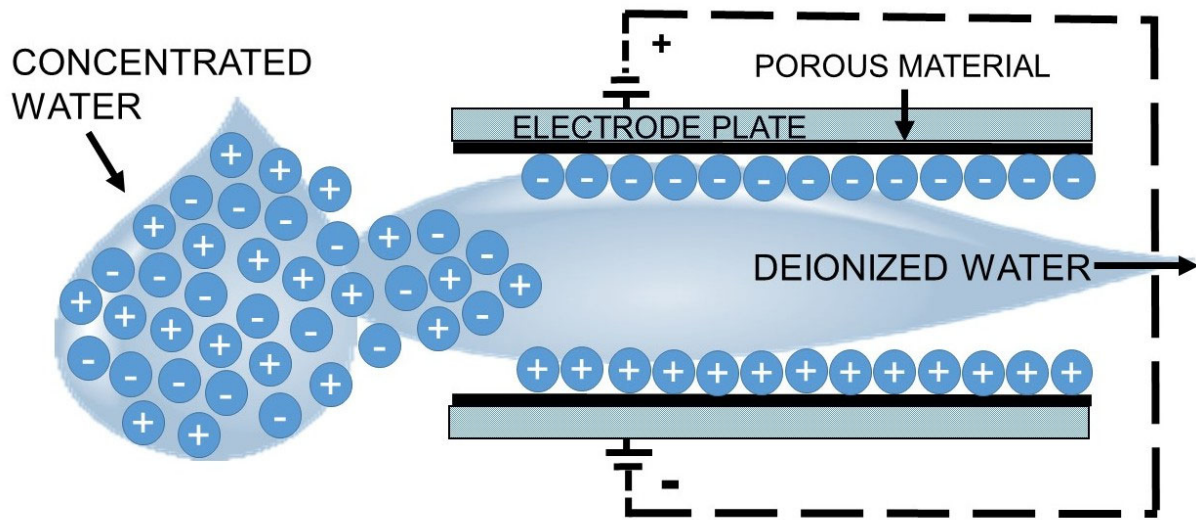

CAPACITIVE DEIONIZATION PROCESS

Desalination Sub-Section

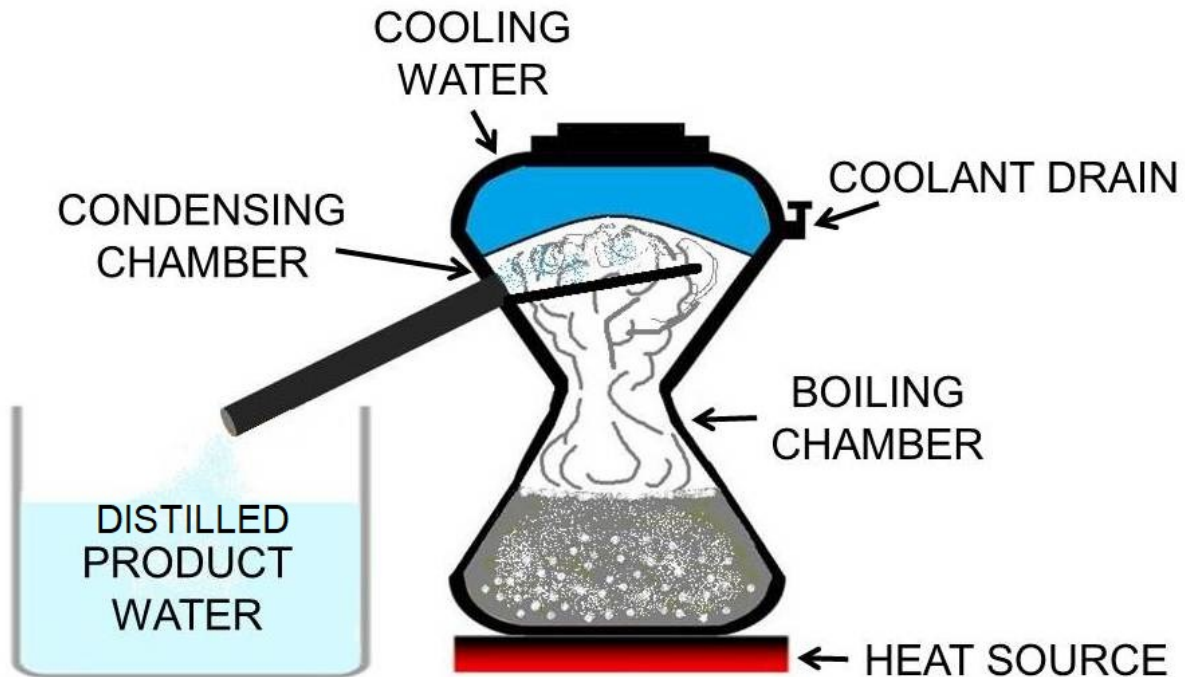

DESALINATION – DISTILLATION PROCESSES

Desalinated water can be produced from the diluted draw / osmotic agent solution, using a second process. This may be by membrane separation, thermal method, physical separation or a combination of these processes.

The process has the feature of inherently low fouling because of the forward osmosis first step, unlike conventional reverse osmosis desalination plants where fouling is often a problem.

Landfill Leachate Treatment

In the case where the desired product is fresh water which does not contain draw solutes, a second separation step is required. The first separation step of FO, driven by an osmotic pressure gradient, does not require a significant energy input (only unpressurized stirring or pumping of the solutions involved). The second separation step, however does typically require energy input.

One method used for the second separation step is to employ RO. This approach has been used, for instance, in the treatment of landfill leachate. An FO membrane separation is used to draw water from the leachate feed into a saline (NaCl) brine.

The diluted brine is then passed through a RO process to produce fresh water and a reusable brine concentrate. The advantage of this method is not a savings in energy, but rather in the fact that the FO process is more resistant to fouling from the leachate feed than a RO process alone.

Brine Concentration

Brine concentration using forward osmosis may be achieved using a high osmotic pressure draw solution with a means to recover and regenerate it.

One unexploited application is to 'soften' or pre-treat the feedwater to multi stage flash (MSF) or multiple effect distillation (MED) plants by osmotically diluting the recirculating brine with the cooling water. This reduces the concentrations of scale forming calcium carbonate and calcium sulfate compared to the normal process, thus allowing an increase in top brine temperature (TBT), output and gained output ratio (GOR). Darwish et al. showed that the TBT could be raised from 110 °C to 135 °C whilst maintaining the same scaling index for calcium sulfate.

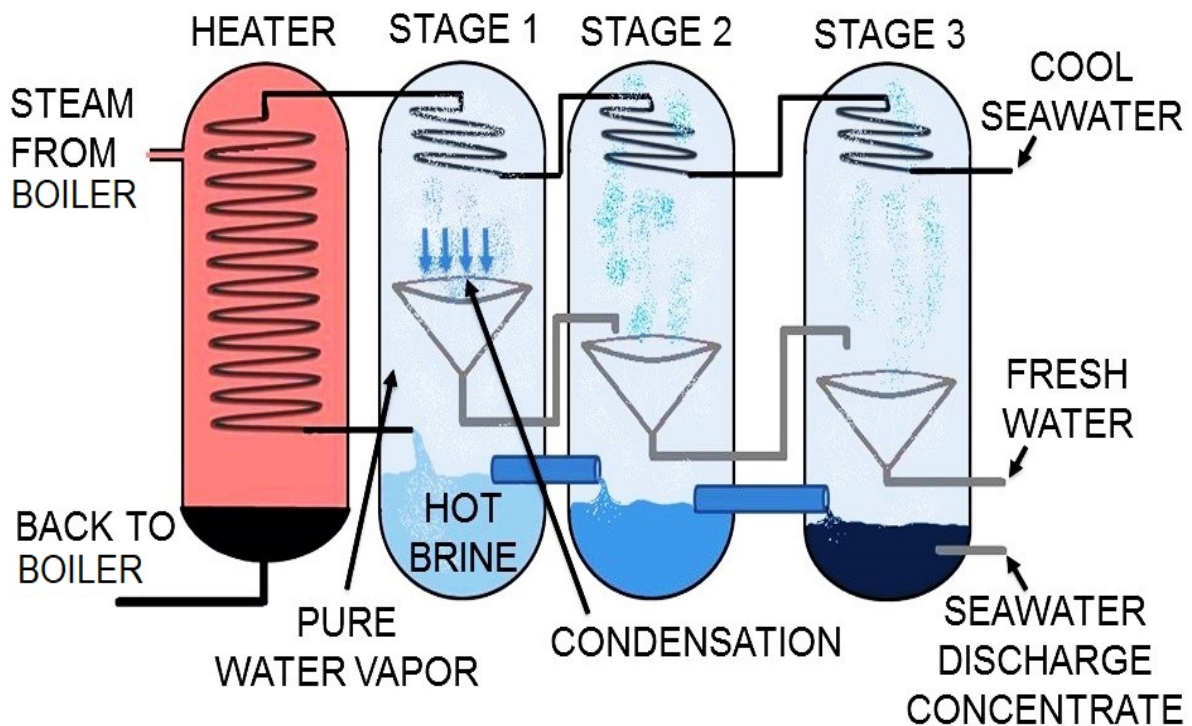

MULTISTAGE FLASH DISTILLATION PROCESS

Osmotic Processes Sub-Section

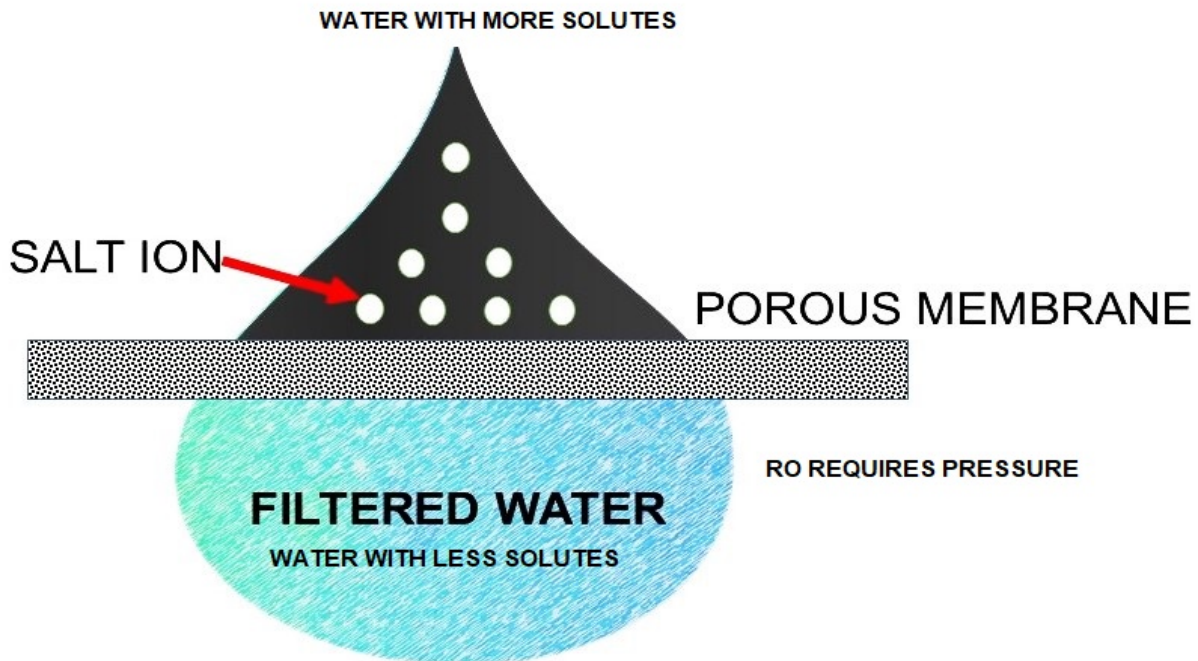

OSMOSIS PROCESS DIAGRAM # 1

In this section, will explain Forward and Reverse Osmosis treatment methods and terminology.

- a. Forward Osmosis
- b. Reverse Osmosis
- c. Brine Channel
- d. R/O Components
- e. Clean-in-place System

Osmotic processes manipulate the osmotic pressure gradient between solutions. Osmotic processes include reverse osmosis (RO), forward osmosis (FO), pressure enhanced osmosis (PEO) and pressure retarded osmosis (PRO).

Forward Osmosis (FO)

Forward osmosis (FO) is an osmotic process that, like reverse osmosis (RO), uses a semi-permeable membrane to effect separation of water from dissolved solutes. The driving force for this separation is an osmotic pressure gradient, such that a "draw" solution of high concentration (relative to that of the feed solution), is used to induce a net flow of water through the membrane into the draw solution, thus effectively separating the feed water from its solutes.

In contrast, the reverse osmosis process uses hydraulic pressure as the driving force for separation, which serves to counteract the osmotic pressure gradient that would otherwise favor water flux from the permeate to the feed. Hence significantly more energy is required for reverse osmosis compared to forward osmosis.

	TASTE AND ODOR	CHLORINE	ORGANICS	INORGANICS	BIOLOGICALS
BOTTLED WATER	●	○	○	○	○
ULTRA VIOLET (UV)	○	○	○	●	○
CARBON FILTERS	●	●	●	○	◐
REVERSE OSMOSIS SYSTEM	●	●	●	●	●

○ NO ● YES ◐ PARTIAL

TYPES OF WATER QUALITY FILTRATION TECHNOLOGIES AND EFFECTIVE USES

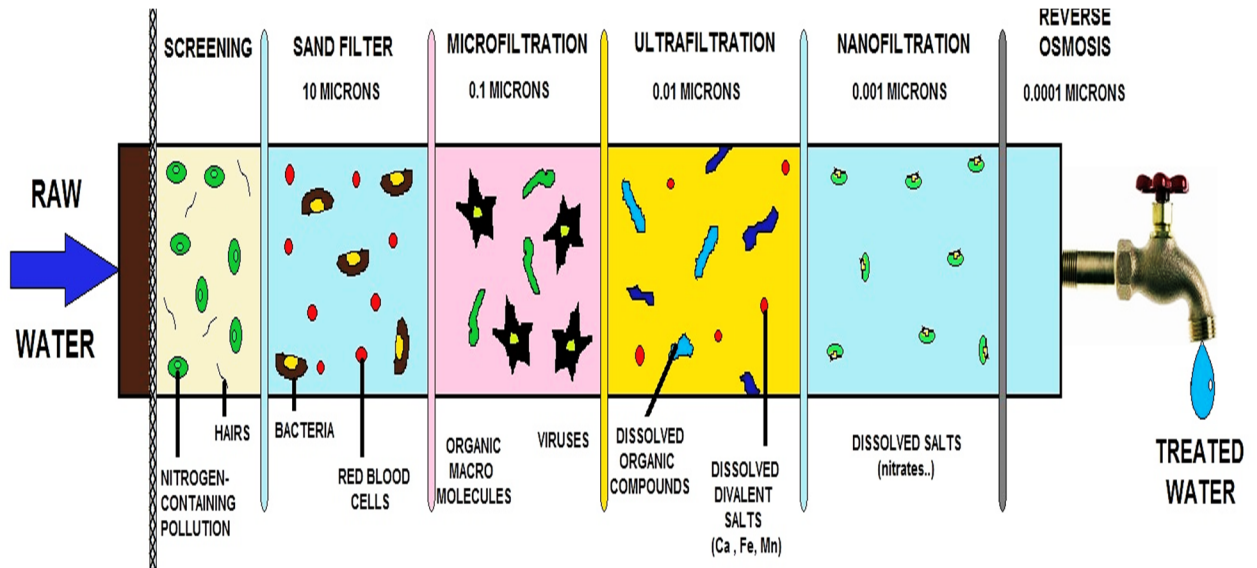

FILTRATION METHODS AND REMOVAL SIZES

In FO processes we may have solute diffusion in both directions depending on the composition of the draw solution and the feed water. This does two things; the draw solution solutes may diffuse to the feed solution and the feed solution solutes may diffuse to the draw solution.

Clearly this phenomenon has consequences in terms of the selection of the draw solution for any particular FO process. For instance, the loss of draw solution may affect the feed solution perhaps due to environmental issues or contamination of the feed stream, such as in osmotic membrane bioreactors.

An additional distinction between the reverse osmosis (RO) and forward osmosis (FO) processes is that the permeate water resulting from an RO process is in most cases, fresh water ready for use. In the FO process, this is not the case. The membrane separation of the FO process in effect results in a "trade" between the solutes of the feed solution and the draw solution.

Depending on the concentration of solutes in the feed (which dictates the necessary concentration of solutes in the draw) and the intended use of the product of the FO process, this step may be all that is required. The osmotic pressure gradient is used to induce a net flow of water through the membrane into the draw, thus effectively concentrating the feed. The draw solution can consist of a single or multiple simple salts or can be a substance specifically tailored for forward osmosis applications. The feed solution can be a dilute product stream, a waste stream or seawater.

The forward osmosis process is also known as osmosis or in the case of a number of companies who have coined their own terminology 'engineered osmosis' and 'manipulated osmosis'. Most of the applications of FO, thus fall into three broad categories: product concentration, waste concentration or production of cleaner water as a bi-product of the concentration process. The most efficient FO applications combine all three. At its best, FO can concentrate waste, turning waste into a product all while producing clean water.

The Forward Osmosis process has applications in many different industries, including but not limited to: Water Reuse and Desalination; Food and Beverage; Mining; Oil and Gas; and the Power Industry.

FO Applications in Different Industries:

- ✓ Water Reuse
- ✓ Water Desalination
- ✓ Brine Concentration
- ✓ Product concentration (examples: juice, chemicals)
- ✓ Produced water treatment

RO produces clean water, FO produces clean draw, while PRO produces power.

Distinction Between RO and FO Processes

A major distinction between the RO and FO processes is that the water permeating the RO process is, in most cases, fresh water ready for use. In the FO process, this is not the case.

The membrane separation of the FO process in effect results in a "trade" between the solutes of the feed solution and the draw solution.

- ✓ Pressure Retarded Osmosis (PRO) may be used to convert salinity gradient into power.
- ✓ Forward osmosis is not a replacement for reverse osmosis.

In some applications, FO complements RO. In others, specialized draw or salt is concentrated using different technologies. FO can also be used without the draw concentration step as an FO Concentrator if a brine stream with high osmotic pressure is available.

FO can concentrate waters with higher total dissolved solids (TDS) than RO using a high osmotic draw.

- ✓ Membranes used for RO do not work well for FO.
- ✓ Different materials and membrane structure are required to achieve good membrane productivity.
- ✓ FO fouls less than RO.

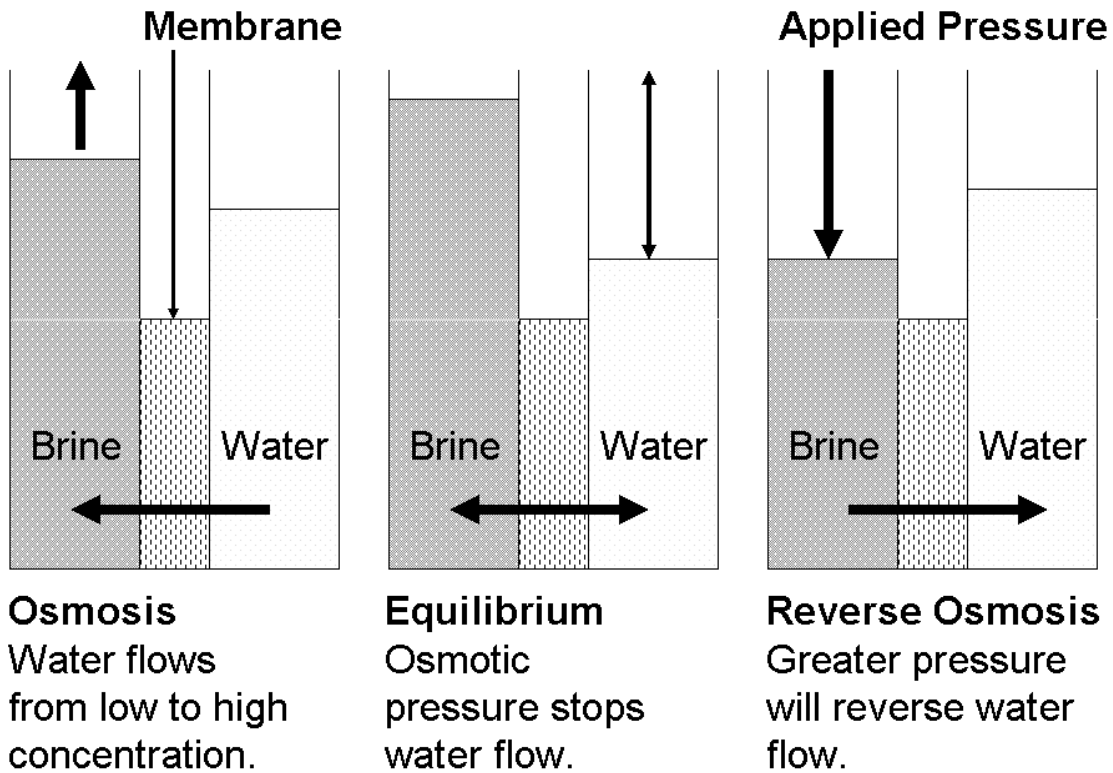

Reverse Osmosis Process Sub-Section

In contrast with forward osmosis, the reverse osmosis process uses hydraulic pressure as the driving force for separation, which serves to counteract the osmotic pressure gradient that would otherwise favor water flux from the permeate to the feed. One of the reasons that FO membranes are considerably less prone to fouling than membranes used in pressure driven processes is the absence of external pressure that compacts foulants into the membrane surface, restricting flow.

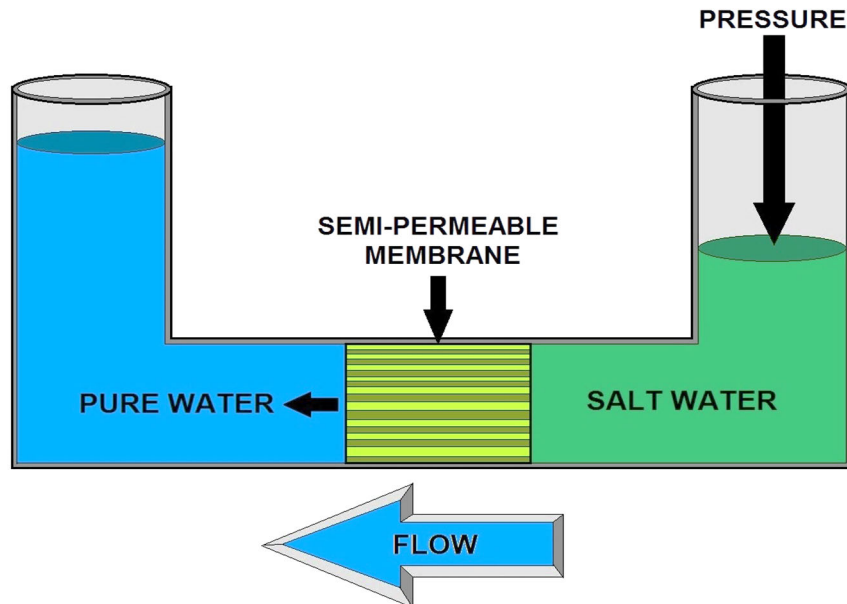

REVERSE OSMOSIS

Reverse Osmosis and Nanofiltration processes work in a similar way to an extremely fine filter but use a "*membrane*" to remove atoms which are larger than water molecules.

The mechanism requires sophisticated pumping and control. RO is therefore used to remove a wide range of contaminants, typically salts, hardness and large organic molecules where a very high level of purity is required. It is, of course, more expensive than conventional filtration and is used only where high purity is essential.

Reverse Osmosis has proven to be the most reliable and cost effective method of desalinating water, and hence its use has become more and more widespread. Energy consumption is usually some 70% less than for comparable evaporation technologies. Reverse osmosis, also known as hyperfiltration, is the finest filtration known. This process will allow the removal of particles as small as ions from a solution.

Advancements have been made in membrane technology, resulting in stable, long-lived membrane elements. Component parts have been improved as well, reducing maintenance and down time. Additional advancements in pretreatment have been made in recent years, further extending membrane life and improving performance.

Reverse Osmosis delivers product water or permeate having essentially the same temperature as the raw water source (an increase of 1° C or 1.8° F may occur due to pumping and friction in the

pipng). This is more desirable than the hot water produced by evaporation technologies. R/O Systems can be designed to deliver virtually any required product water quality. For these and other reasons, R/O is usually the preferred method of desalination today.

Reverse osmosis is capable of rejecting bacteria, salts, sugars, proteins, particles, dyes, and other constituents that have a molecular weight of greater than 150-250 Daltons. The separation of ions with reverse osmosis is aided by charged particles. This means that dissolved ions that carry a charge, such as salts, are more likely to be rejected by the membrane than those that are not charged, such as organics. The larger the charge and the larger the particle, the more likely it will be rejected.

A Reverse Osmosis System removes virtually all of the following: bad taste, odor, turbidity, organic compounds, herbicides, insecticides, pesticides, chlorine and THM's, bacteria, virus, cysts, parasites, arsenic, heavy metals, lead, cadmium, aluminum, dissolved solids, sodium, calcium, magnesium, inorganic dead dirt minerals, fluoride, sulfates, nitrates, phosphates, detergents, radioactivity and asbestos.

Disadvantages of using ultrafiltration, nanofiltration or reverse osmosis to treat water?

Reverse osmosis removes a number of healthy minerals from water, in addition to the harmful minerals and particles.

The removal of these minerals, including calcium and magnesium, can actually make water unhealthy, especially for people with inadequate diets and people who live in hot climates, as water can provide these necessary minerals. The addition of calcium and magnesium, can resolve these concerns.

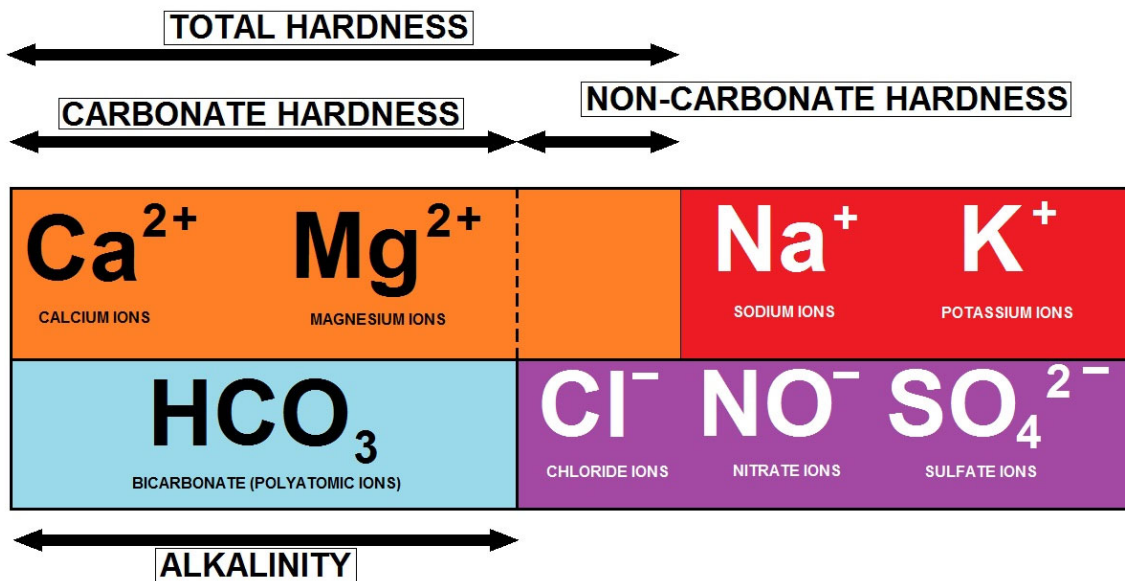

CARBONATE HARDNESS CHART

Reverse Osmosis Described

Osmosis is a natural phenomenon in which a liquid - water in this case - passes through a semi-permeable membrane from a relatively dilute solution toward a more concentrated solution. This flow produces a measurable pressure, called osmotic pressure.

If pressure is applied to the more concentrated solution, and if that pressure exceeds the osmotic pressure, water flows through the membrane from the more concentrated solution toward the dilute solution. This process, called reverse osmosis, or RO, removes up to 98% of dissolved minerals, and virtually 100% of colloidal and suspended matter. RO produces high quality water at a relatively low cost compared to other purification processes.

The membrane must be physically strong to stand up to high osmotic pressure - in the case of sea water, 2500 kg/m. Most membranes are made of cellulose acetate or polyamide composites cast into a thin film, either as a sheet or fine hollow fibers. The membrane is constructed into a cartridge called a reverse osmosis module.



RO Skid

After filtration to remove suspended particles, incoming water is pressurized with a pump to 200 - 400 psi (1380 - 2760 kPa) depending on the RO system model.

This exceeds the water's osmotic pressure. A portion of the water (permeate) diffuses through the membrane, leaving dissolved salts and other contaminants behind with the remaining water where they are sent to drain as waste (concentrate).

Pretreatment

Pretreatment is important because it influences permeate quality and quantity. It also affects the module's life because many water-borne contaminants can deposit on the membrane and foul it. Generally, the need for pretreatment increases as systems become larger and operate at higher pressures, and as permeate quality requirements become more demanding. Because reverse osmosis is the principal membrane filtration process used in water treatment, it is described here in greater detail.

To understand Reverse Osmosis, one must begin by understanding the process of osmosis, which occurs in nature. In living things, osmosis is frequently seen. The component parts include a pure or relatively pure water solution and a saline or contaminated water solution, separated by a semi-permeable membrane, and a container or transport mechanism of some type.

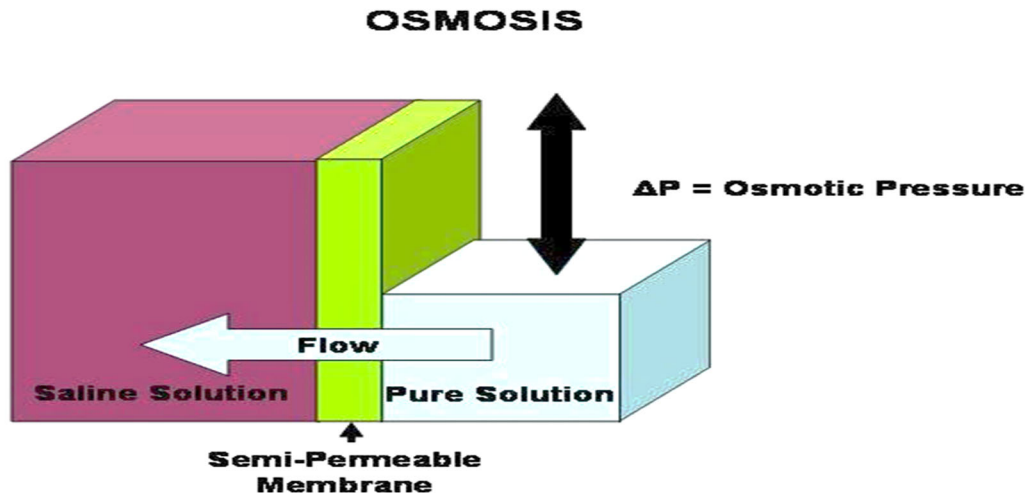

The semi-permeable membrane is so designated because it permits certain elements to pass through, while blocking others. The elements that pass through include water, usually smaller molecules of dissolved solids, and most gases. The dissolved solids are usually further restricted based on their respective electrical charge. In osmosis, naturally occurring in living things, the pure solution passes through the membrane until the osmotic pressure becomes equalized, at which point osmosis ceases. The osmotic pressure is defined as the pressure differential required to stop osmosis from occurring. This pressure differential is determined by the total dissolved solids content of the saline solution, or contaminated solution on one side of the membrane. The higher the content of dissolved solids, the higher the osmotic pressure. Each element that may be dissolved in the solution contributes to the osmotic pressure, in that the molecular weight of the element affects the osmotic pressure.

Generally, higher molecular weights result in higher osmotic pressures. Hence, the formula for calculating osmotic pressure is very complex. However, approximate osmotic pressures are usually sufficient to design a system.

Tap Water Osmotic Pressure

Common tap water, as found in most areas, may have an osmotic pressure of about 10 PSI (Pounds per Square Inch), or about 1.68 Bar. Seawater at 36,000 PPM typically has an osmotic pressure of about 376 PSI (26.75 Bar). Thus, to reach the point at which osmosis stops for tap water, a pressure of 10 PSI would have to be applied to the saline solution. To stop osmosis in seawater, a pressure of 376 PSI would have to be applied to the seawater side of the membrane.

Several decades ago, U.S. Government scientists had the idea that the principles of osmosis could be harnessed to purify water from various sources, including brackish water and seawater. In order to transform this process into one that purifies water, osmosis would have to be reversed, and suitable synthetic membrane materials would have to be developed. Additionally, ways of configuring the membranes would have to be engineered to handle a continuous flow of raw and processed water without clogging or scaling the membrane material. These ideas were crystallized

and, fueled by U.S. Government funding, usable membrane materials and designs resulted. One of the membrane designs was the spiral wound membrane element. This design enabled the engineers to construct a membrane element that could contain a generous amount of membrane area in a small package, and to permit the flow of raw water to pass along the length of the membrane. This permits flows and pressures to be developed to the point that ample processed or purified water is produced, while keeping the membrane surface relatively free from particulate, colloidal, bacteriological or mineralogical fouling.

The design features a perforated tube in the center of the element, called the product or permeate tube. Wound around this tube are one or more "*envelopes*" of membrane material, opening at the permeate tube. Each envelope is sealed at the incoming and exiting edge. Thus, when water penetrates or permeates through the membrane, it travels, aided by a fine mesh called the permeate channel, around the spiral and collects in the permeate tube. The permeate or product water is collected from the end of each membrane element, and becomes the product or result of the purification process.

Brine Channel

Meanwhile, as the raw water flows along the "*brine channel*" or coarse medium provided to facilitate good flow characteristics, it gets more and more concentrated. This concentrated raw water is called the reject stream or concentrate stream. It may also be called brine if it is coming from a salt water source. The concentrate, when sufficient flows are maintained, serves to carry away the impurities removed by the membrane, thus keeping the membrane surface clean and functional. This is important, as buildup on the membrane surface, called fouling, impedes or even prevents the purification process.

Thin Film Composite (TFC) Polyamide Material

The membrane material itself is a special thin film composite (**TFC**) polyamide material, cast in a microscopically thin layer on another, thicker cast layer of Polysulfone, called the microporous support layer. The microporous support layer is cast on sheets of paper-like material that are made from synthetic fibers such as polyester, and manufactured to the required tolerances.

Each sheet of membrane material is inspected at special light tables to ensure the quality of the membrane coating, before being assembled into the spiral wound element design. To achieve Reverse Osmosis, the osmotic pressure must be exceeded, and to produce a reasonable amount of purified water, the osmotic pressure is generally doubled. Thus with seawater osmotic pressure of 376 PSI, a typical system operating pressure is about 800 PSI. Factors that affect the pressure required include raw water temperature, raw water TDS (Total Dissolved Solids), membrane age, and membrane fouling.

The effect of temperature is that with higher temperatures, the salt passage increases, flux (permeate flow) increases, and operating pressure required is lower. With lower temperatures, the inverse occurs, in that salt passage decreases (reducing the TDS in the permeate or product water), while operating pressures increase. Or, if operating pressures do not increase, then the amount of permeate or product water is reduced. In general, Reverse Osmosis (R/O) systems are designed for raw water temperatures of 25° C (77° F). Higher temperatures or lower temperatures can be accommodated with appropriate adjustments in the system design.

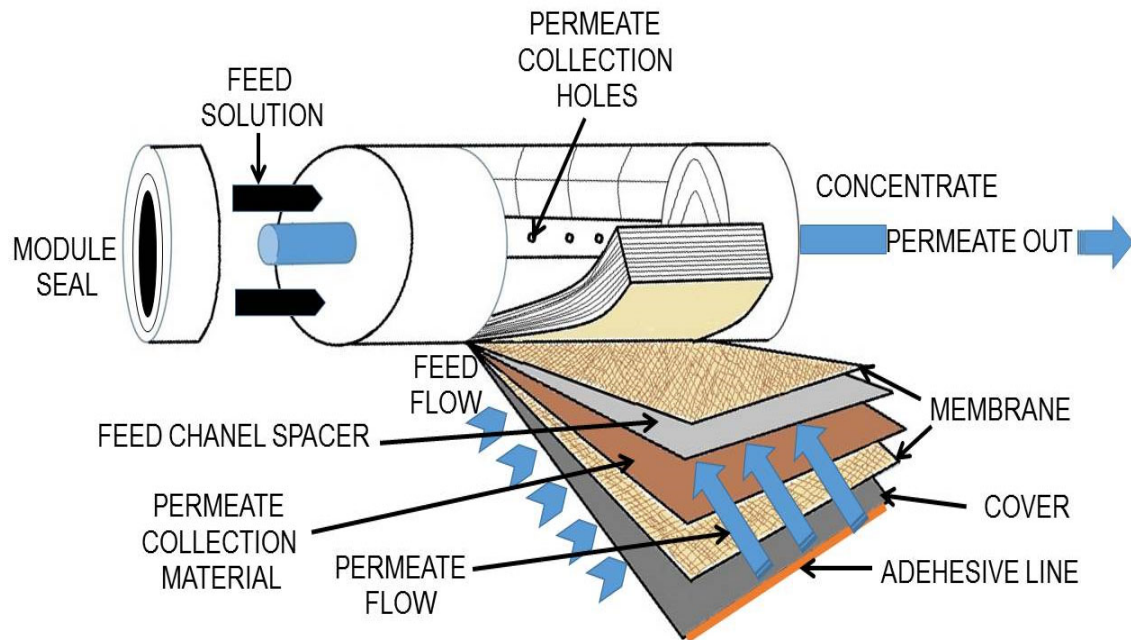

REVERSE OSMOSIS MEBRANE DIAGRAM

Membranes are available in "standard rejection" or "high rejection" models for seawater and brackish water. The rejection rate is the percentage of dissolved solids rejected, or prevented from passing through the membrane. For example, a membrane with a rejection rate of 99% (usually based on Na (Sodium)) will allow only 1% of the concentration of dissolved solids to pass through into the permeate.

Hence, product water from a source containing 10,000 PPM would have 100 PPM remaining. Of course, as the raw water is processed, the concentrations of TDS increase as it passes along the membrane's length, and usually multiple membranes are employed, with each membrane in the series seeing progressively higher dissolved solids levels.

Typically, starting with seawater of 36,000 PPM, standard rejection membranes produce permeate below 500 PPM, while high rejection membranes under the same conditions produce drinking water TDS of below 300 PPM.

There are many considerations when designing R/O systems that competent engineers are aware of. These include optimum flows and pressures, optimum recovery rates (the percentage of permeate from a given stream of raw water), prefiltration and other pretreatment considerations, and so forth.

Membrane systems in general cannot handle the typical load of particulate contaminants without prefiltration. Often, well designed systems employ multiple stages of prefiltration, tailored to the application, including multi-media filtration and one or more stages of cartridge filtration. Usually the last stage would be 5 microns or smaller, to provide sufficient protection for the membranes.

R/O systems typically have the following components:

A supply pump or pressurized raw water supply; prefiltration in one or more stages; chemical injection of one or more pretreatment agents; a pressure pump suited to the application, a membrane array including one or more membranes installed in one or more pressure tubes (also called vessels, R/O pressure vessels); various gauges and flow meters; a pressure regulating valve, relief valve(s) and/or safety pressure switches; and usually some form of post treatment.

Post treatment should usually include a form of sterilization such as Chlorine, Bromine, Ultra-Violet (U-V), or Ozone. Other types of post treatment may include carbon filters, pH adjustment, or mineral injection for some applications.

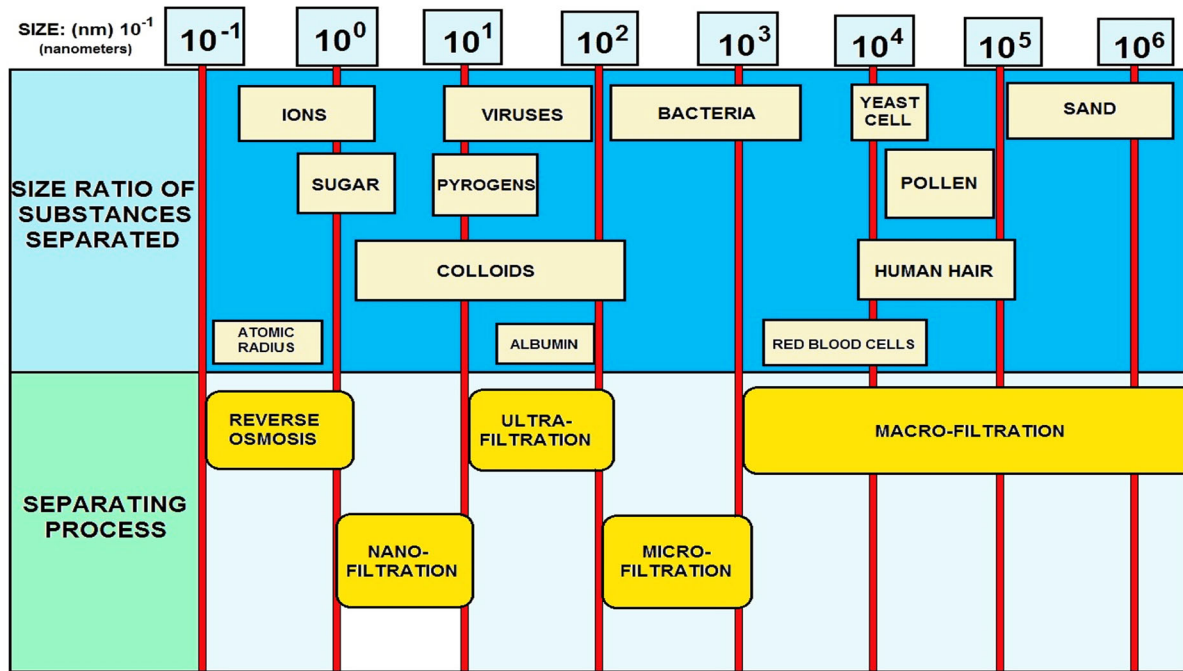

FILTRATION SPECTRUM

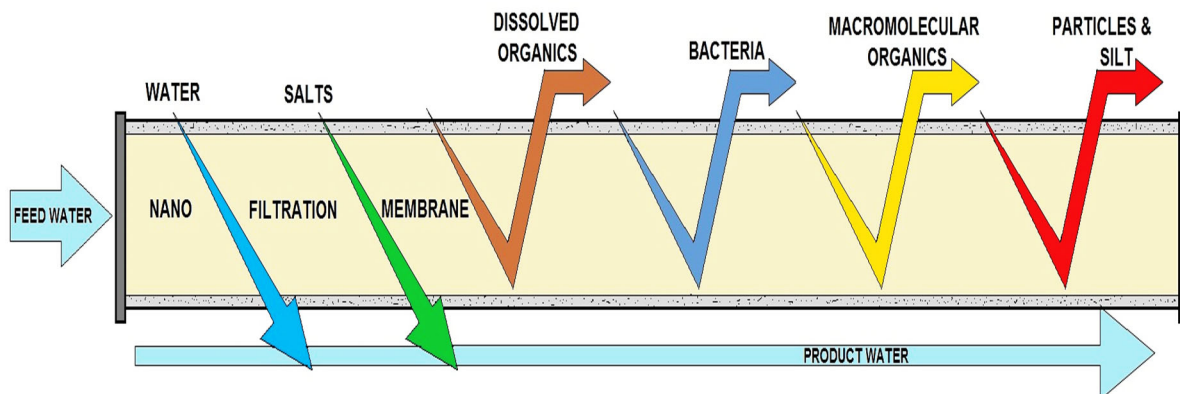

NANOFILTRATION

Nanofiltration and Reverse Osmosis Comparisons

Nanofiltration and Reverse Osmosis are both techniques to bring into action univalent and bivalent ions.

Nanofiltration

Nanofiltration is a technique that has prospered over the past few years. Today, nanofiltration is mainly applied in drinking water purification process steps, such as water softening, decoloring and micro pollutant removal. During industrial processes nanofiltration is applied for the removal of specific components, such as coloring agents.

Nanofiltration is a pressure related process, during which separation takes place, based on molecule size. Membranes bring about the separation. The technique is mainly applied for the removal of organic substances, such as micro pollutants and multivalent ions. Nanofiltration membranes have a moderate retention for univalent salts.

Other Applications of Nanofiltration are:

- ✓ The removal of pesticides from groundwater
- ✓ The removal of heavy metals from wastewater
- ✓ Wastewater recycling in laundries
- ✓ Water softening
- ✓ Nitrates removal

Reverse Osmosis (RO)

Reverse Osmosis is based upon the fundamental pursuit for balance. Two fluids containing different concentrations of dissolved solids that come in contact with each other will mix until the concentration is uniform. When these two fluids are separated by a semi permeable membrane (which lets the fluid flow through, while dissolved solids stay behind), a fluid containing a lower concentration will move through the membrane into the fluids containing a higher concentration of dissolved solids. (Binnie 2002)

After a while the water level will be higher on one side of the membrane. The difference in height is called the osmotic pressure.

By pursuing pressure upon the fluid column, which exceeds the osmotic pressure, one will get a reversed effect. Fluids are pressed back through the membrane, while dissolved solids stay behind in the column.

Using this technique, a larger part the salt content of the water can be removed.

1. Water flows from a column with a low dissolved solids content to a column with a high dissolved solids content
2. Osmotic pressure is the pressure that is used to stop the water from flowing through the membrane, in order to create balance
3. By pursuing pressure that exceeds the osmotic pressure, the water flow will be reversed; water flows from the column with a high dissolved solids content to the column with a low dissolved solids content

Reverse Osmosis is a technique that is mainly applied during drinking water preparation. The process of drinking water preparation from salty seawater is commonly known. Besides that, Reverse Osmosis is applied for the production of ultra-pure water and boiler feed water.

It is also applied in the food sector (concentration of fruit juice, sugar and coffee), in the galvanic industry (concentration of wastewater) and in the dairy industry (concentration of milk for cheese production).

Summarized, the applications of Reverse Osmosis application are:

- ✓ Water softening
- ✓ Drinking water production
- ✓ Process water production
- ✓ Ultra-pure water production (electronic industries)
- ✓ Concentration of molecular solvents for food and dairy industries

The pre-treatment of feed water for nanofiltration or Reverse Osmosis installations greatly influences the performance of the installation.

The required form of pre-treatment depends on the feed water quality. The purpose of pre-treatment is reducing the organic matter content and the amount of bacteria, as well as lowering the MFI.

The organic matter content and the amounts of bacteria should be as low as possible to prevent the biofouling of membranes.

The application of a pre-treatment has several benefits:

- ✓ Membranes have a longer life-span when pre-treatment is performed
- ✓ The production time of the installation is extended
- ✓ The management tasks become simpler
- ✓ The employment costs are lower

Next to pre-treatment one can perform a chemical dosage (acid, anti-scalent), to prevent scaling and precipitation of insoluble solids, such as calcium carbonate and barium sulfate on the membrane surface. The applied acids are hydrochloric acid (HCl) and sulfuric acid (H₂SO₄).

Sulfuric acid is the most widely used chemical for this purpose. However, hydrochloric acid is applied more and more because sulfuric acid can negatively influence the fouling speed of a membrane. When the feed water contains high amounts of sulfate ions, hydrochloric acid replaces sulfuric acid. The dosage of sulfuric acid would enhance the chances of scaling by sulfate ions on the membranes in this case. (Baker, 2000)

Reverse Osmosis Summary

Reverse osmosis (RO) has been known for more than a century, but it did not become a commercial process until the early sixties when a special membrane was developed. Because RO operates at a comparatively low temperature and is relatively energy efficient, it is employed in various applications, e.g., desalination, treatment of wastewater, reclamation of minerals, and concentration of whey and other food products, and purification of water.

In recent years, RO has been used increasingly in making processed water for dialysis in hospitals and for certain cosmetics and drugs by pharmaceutical manufacturers. In addition to these applications, RO is capable of producing water of sufficient purity to be used as Water For Injection (WFI) and for the preparation of parenteral solutions. This ITG will focus on the chemical and microbiological quality of water produced by reverse osmosis.

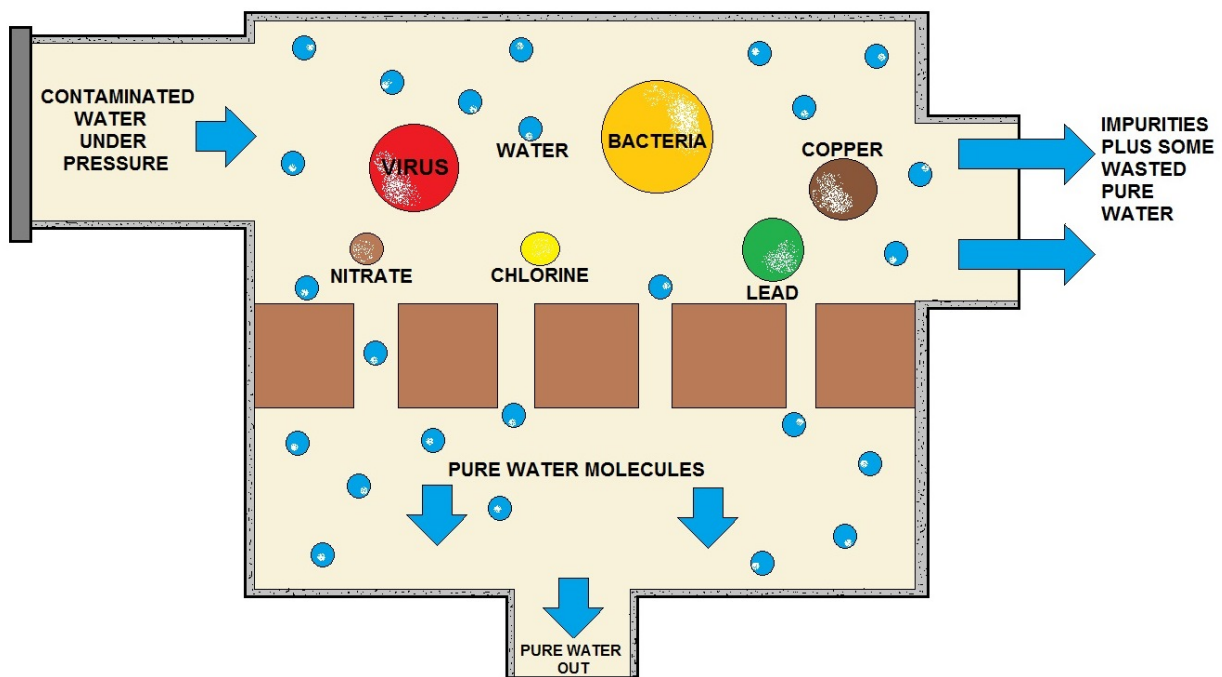

REVERSE OSMOSIS SYSTEM BASIC DESIGN

Definition and Operating Principle

Reverse osmosis is a process which uses a membrane under pressure to separate relatively pure water (or other solvent) from a less pure solution. When two aqueous solutions of different concentrations are separated by a semi-permeable membrane, water passes through the membrane in the direction of the more concentrated solution as a result of osmotic pressure. If enough counter pressure is applied to the concentrated solution to overcome the osmotic pressure, the flow of water will be reversed.

Water molecules can form hydrogen bonds in the RO membrane and fit into the membrane matrix. The water molecules that enter the membrane by hydrogen bonding can be pushed through under pressure. Most organic substances with a molecular weight over 100 are sieved out, i.e., oils, pyrogens and particulates including bacteria and viruses.

Salt ions, on the other hand, are rejected by a mechanism related to the valence of the ion. Ions are repelled by dielectric interactions; ions with higher charges are repelled to a greater distance from the membrane surface. Monovalent ions such as chloride ions will not be rejected as efficiently as, for example, divalent sulfate ions. The nominal rejection ratio of common ionic salts is 85 - 98%.

Membranes

The majority of the commercially manufactured RO membranes are made from cellulose acetate, polysulfonate, and polyamide. Many other kinds of membrane made of a single polymer or a copolymer are also available for specific purposes. The membrane consists of a skin about 0.25 microns and a support layer about 100 microns. The skin is the active barrier and primarily allows water to pass through.

Two types of RO construction are commonly used:

1. spiral wound ---sheets of membrane sandwiched with mesh spacers are connected and wound around a permeate tube; and
2. hollow fiber. Either of these modules is assembled into a pressure housing.

Quality of RO Product Water

The amount of dissolved solids in water produced by reverse osmosis is approximately a constant percentage of those in the feed water. For example, when the feed water contains 300 ppm total dissolved solids (TDS), the product water may have 15 to 30 ppm (95% and 90% rejection ratio respectively). A RO system design is based on a certain range of feed water TDS, the percentage of rejection and percentage of recovery desired. For a given system, the higher the percentage of recovery or the lower the percentage of rejection, the poorer the quality of product water becomes.

A RO water purification system with a deionizer and/or several modules connected in series can produce water containing less than 0.1 ppm TDS (resistivity about 1 megaohm-cm). In defining water for use parenterally, Remington's Pharmaceutical Sciences emphasizes that besides meeting USP pyrogen standards, there are several acceptable levels for total solids which may be used to evaluate or grade the product water for particular applications. The USP Monograph limits total solids to 10 PPM for WFI. However, to preclude stability problems from interfering with manufacturing, the parenteral drug industry commonly establishes a limit of 0.1 PPM or less of ionic contaminants.

Extensive Investigations on Bacterial Contamination

It has been reported that bacteria can "grow" through membranes. The mechanism by which bacteria pass through a RO membrane is not known and no correlation exists between a dye leak test of the membrane and its bacterial retention efficiency. Researchers at the Center for Disease Control (CDC) conducted extensive investigations on the bacterial contamination of RO systems used in producing purified water for dialysis.

They reported:

1. certain naturally occurring Gram- negative bacteria can multiply in relatively pure RO water;
2. thorough periodic disinfection of the entire RO system is essential in producing water with acceptable bacterial counts;
3. stagnant water in pipes downstream of the membrane is the major source of bacteria and endotoxin in the product water; and
4. the efficiency of a membrane in rejecting bacteria is better in continuous operation than in intermittent use.

Advanced Treatment Section Post Quiz

1. Who was the French physicist who first noted that water would diffuse through a pig bladder membrane into alcohol back in 1748?
2. In reverse osmosis, water is forced to move through _____ from a concentrate solution to a dilute solution.
3. Membranes have been used for desalinization, removal of dissolved inorganic and organic chemicals, water softening, and removal of fine solids.
True or False
4. In the simplest membrane processes, water is forced through a porous membrane under pressure, while suspended solids, large molecules, or ions are dissolved.
True or False
5. Which process has not been generally applicable to drinking water treatment because it either does not remove substances that require removal from potable water, or the problem substances can be removed more economically using other processes?
6. Reverse Osmosis (RO) membranes are not susceptible to clogging or binding.
True or False
7. Although _____ does not generally work well for removal of salt or dissolved solids, it can be used effectively for removal of most organic chemicals.
8. _____ operates with less pressure than reverse osmosis and is still able to remove a significant proportion of inorganic and organic molecules.
9. Reverse Osmosis (RO) membranes have a very low pore size that can reject ions at very high rates, including _____ and _____.
10. Another crucial application of MF membranes lies in the _____ of beverages and pharmaceuticals.
11. The microfiltration process is pressure driven with suspended particles and water as retentate and dissolved solutes plus water as _____.

12. _____ describes the deposition and accumulation of feed components such as suspended particles, impermeable dissolved solutes or even permeable solutes, on the membrane surface and or within the pores of the membrane.

Topic 8- Disinfection Section

Section Focus: You will learn the basics of water disinfection with an emphasis on Chlorine. At the end of this section, you will be able to describe chlorination. There is a post quiz at the end of this section to review your comprehension and a final examination in the Assignment for your contact hours.

Scope/Background: Traditionally, the use of chlorine gas was the most common method of water disinfection. Chlorine gas itself is relatively inexpensive but is a highly toxic chemical that must be transported and handled with extreme caution. It is stored under pressure in large tanks and is released into the water as a gas. Sodium hypochlorite is a diluted liquid form of chlorine that is also commonly used, primarily by groundwater wells but also as a safer alternative to chlorine gas.

CHLORINE
DO NOT TAKE INTERNALLY

AVOID CONTACT WITH EYES, MOUTH OR CLOTHING **WARNING** AVOID BREATHING FUMES

FLAMMABLE - KEEP FIRE AWAY
USE ONLY IN WELL VENTILATED AREAS.
USE ONLY WHERE THERE ARE NO OPEN FLAMES OR OTHER SOURCES OF IGNITION

EXTREMELY FLAMMABLE
KEEP AWAY FROM HEAT, SPARKS AND OPEN FLAME
KEEP CONTAINER CLOSED

HAZARD IDENTIFICATION

CODE NUMBERS

- 4 - SEVERE
- 3 - SERIOUS
- 2 - MODERATE
- 1 - SLIGHT
- 0 - MINIMAL

The hazard diamond shows a 3 in the blue section (left), a 0 in the red section (top), and a 0 in the yellow section (right). The white section (bottom) is empty.

Chlorine Introduction

Chlorine gas is the most widely used water disinfectant in the U.S., and it kills most bacteria, viruses, and other microorganisms that cause disease.

Chlorine is introduced to water in the form of gas, hypochlorites (tablets, solutions, or powder), and other compounds.

The different forms of chlorine used at water treatment plants are gaseous chlorine, sodium hypochlorite solution, calcium hypochlorite, and bromium chloride.

Chlorine's Appearance and Odor

Chlorine is a greenish-yellow gas with a characteristic pungent odor. It condenses to an amber liquid at approximately -34 degrees C (-29.2 degrees F) or at high pressures. Odor thresholds ranging from 0.3-0.5 parts per million (ppm) of air have been reported. Prolonged exposures may result in olfactory fatigue. Prolonged, low-level exposures, such as those that occur in the workplace, can lead to olfactory fatigue and tolerance of chlorine's irritant effects.

Reactivity

1. **Conditions Contributing to Instability:** Cylinders of chlorine may burst when exposed to elevated temperatures. Chlorine in solution forms a corrosive material.

2. **Incompatibilities:** Flammable gases and vapors form explosive mixtures with chlorine. Contact between chlorine and many combustible substances (such as gasoline and petroleum products, hydrocarbons, turpentine, alcohols, acetylene, hydrogen, ammonia, and sulfur), reducing agents, and finely divided metals may cause fires and explosions. Contact between chlorine and arsenic, bismuth, boron, calcium, activated carbon, carbon disulfide, glycerol, hydrazine, iodine, methane, oxomonosilane, potassium, propylene, and silicon should be avoided. Chlorine reacts with hydrogen sulfide and water to form hydrochloric acid, and it reacts with carbon monoxide and sulfur dioxide to form phosgene and sulfuryl chloride. Chlorine is also incompatible with moisture, steam, and water.

3. **Hazardous Decomposition Products:** None reported.

4. **Special Precautions:** Chlorine will attack some forms of plastics, rubber, and coatings.

Safety Information- Brief and Critical Points

Chlorine is a greenish-yellow, noncombustible gas at room temperature and atmospheric pressure. The intermediate water solubility of chlorine accounts for its effect on the upper airway and the lower respiratory tract.

Exposure to chlorine gas may be prolonged, because its moderate water solubility may not cause upper airway symptoms for several minutes. In addition, the density of the gas is greater than that of air, causing it to remain near ground level and increasing exposure time. The odor threshold for chlorine is approximately 0.3-0.5 parts per million (ppm); however, distinguishing toxic air levels from permissible air levels may be difficult until irritative symptoms are present.

Death is possible from asphyxia, shock, reflex spasm in the larynx, or massive pulmonary edema. Populations at special risk from chlorine exposure are individuals with pulmonary disease, breathing problems, bronchitis, or chronic lung conditions.

Chlorine gas reacts with water producing a strongly oxidizing solution causing damage to the moist tissue lining the respiratory tract when the tissue is exposed to chlorine. The respiratory tract is rapidly irritated by exposure to 10-20 ppm of chlorine gas in air, causing acute discomfort that warns of the presence of the toxicant. Even brief exposure to 1,000 ppm of Cl₂ can be fatal.



These are 1- ton chlorine gas containers. Notice the five-gallon bucket of motor oil (OSHA Violation) in the bottom photograph. Do you have an eye wash and emergency shower readily available? If not, it is a very common OSHA safety violation.



Flammability

Chlorine is a non-combustible gas.

The National Fire Protection Association has assigned a flammability rating of 0 (no fire hazard) to chlorine; however, most combustible materials will burn in chlorine.

1. **Flash point:** Not applicable.
2. **Autoignition temperature:** Not applicable.
3. **Flammable limits in air:** Not applicable.
4. **Extinguishant:** For small fires use water only; do not use dry chemical or carbon dioxide. Contain and let large fires involving chlorine burn. If fire must be fought, use water spray or fog.

Fires involving chlorine should be fought upwind from the maximum distance possible.

Keep unnecessary people away; isolate the hazard area and deny entry. For a massive fire in a cargo area, use unmanned hose holders or monitor nozzles; if this is impossible, withdraw from the area and let the fire burn. Emergency personnel should stay out of low areas and ventilate closed spaces before entering.

Containers of chlorine may explode in the heat of the fire and should be moved from the fire area if it is possible to do so safely. If this is not possible, cool fire exposed containers from the sides with water until well after the fire is out. Stay away from the ends of containers. Firefighters should wear a full set of protective clothing and self-contained breathing apparatus when fighting fires involving chlorine.

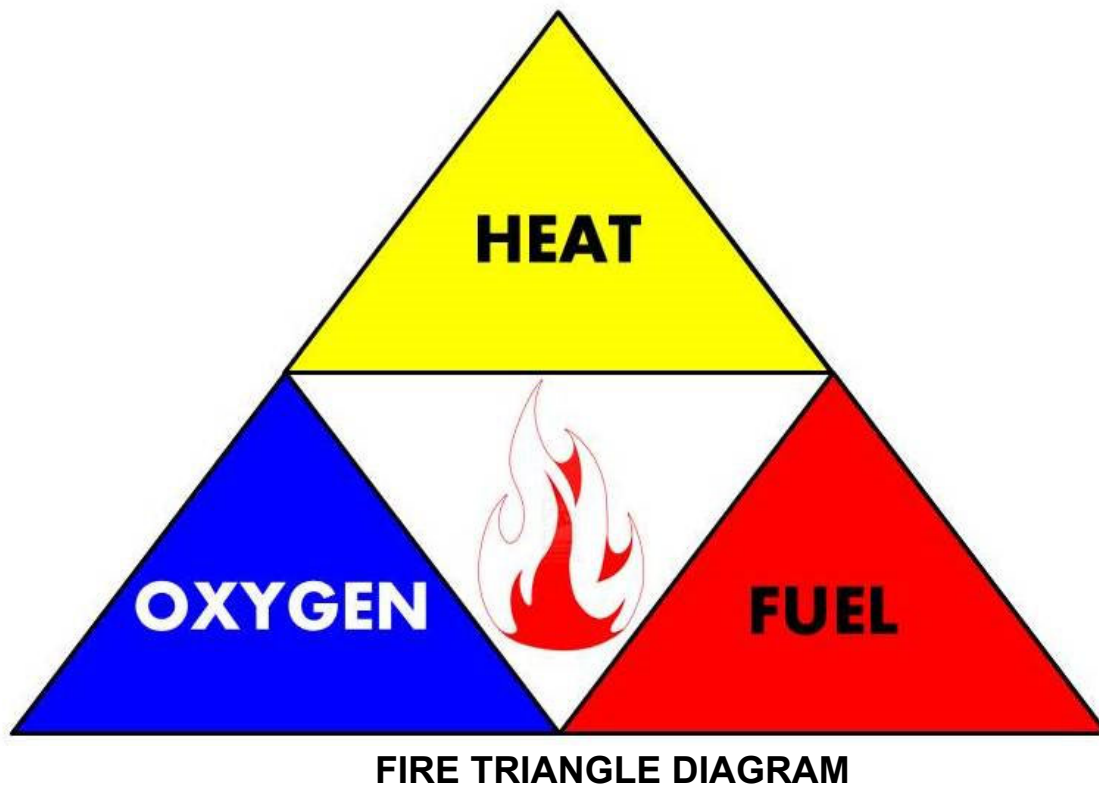

Chlorine Gas Introduction

Today, most of our drinking water supplies are free of the microorganisms — viruses, bacteria, and protozoa — that cause serious and life-threatening diseases, such as cholera and typhoid fever. This is largely due to the introduction of water treatment, particularly chlorination, at the turn of the century.

Living cells react with chlorine and reduce the free chlorine residual concentration while they die. Their organic matter and other substances that are present convert to chlorinated derivatives, some of which are marginally effective killing agents.

Background

Chlorine gas is a pulmonary irritant with intermediate water solubility that causes acute damage in the upper and lower respiratory tract. Chlorine gas was first used as a chemical weapon at Ypres, France in 1915. Of the 70,552 American soldiers poisoned with various gasses in World War I, 1843 were exposed to chlorine gas. Approximately 10.5 million tons and over 1 million containers of chlorine are shipped in the U.S. each year, so it can and is handled safely.

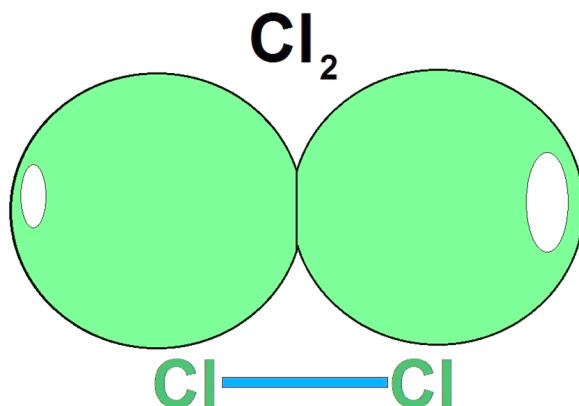

CHLORINE MOLECULAR STRUCTURE

Chlorine is a yellowish-green gas at standard temperature and pressure. It is extremely reactive with most elements. Because its density is greater than that of air, the gas settles low to the ground. It is a respiratory irritant, and it burns the skin. Just a few breaths of it are fatal. Cl_2 gas does not occur naturally, although chlorine can be found in a number of compounds.

Atomic Number: 17

Standard State: Gas at 298K

Melting Point: 171.6K (-101.5 C)

Boiling Point: 239.11K (-34.04 C)

Density: N/A

Molar Volume: 17.39 cm^3

Electronegativity: 3.16 Pauling Units

Crystal Structure: The Diatomic Chlorine molecules arrange themselves in an orthorhombic structure.

Chlorine is a highly reactive gas. It is stable in many naturally occurring compounds, such as table salt. Chlorine is produced in very large amounts (23 billion pounds in 1992) by eighteen companies in the United States. US demand for chlorine is expected to increase slightly over the next several years and then decline. The expected decline in US demand is due to environmental concerns for chlorinated organic chemicals.

The largest users of chlorine are companies that make ethylene dichloride and other chlorinated solvents, polyvinyl chloride (PVC) resins, chlorofluorocarbons, and propylene oxide. Paper companies use chlorine to bleach paper. Water and wastewater treatment plants use chlorine to reduce water levels of microorganisms that can spread disease to humans.

Exposure to chlorine can occur in the workplace or in the environment following releases to air, water, or land. People who use laundry bleach and swimming pool chemicals containing chlorine products are usually not exposed to elemental chlorine itself. Pure chlorine is generally found only in industrial settings.

Chlorine enters the body when breathed in with contaminated air or when consumed with contaminated food or water. It does not remain in the body as chlorine due to its reactivity – it forms destructive acids.

Chlorine gas is greenish yellow in color and very toxic. It is heavier than air and will therefore sink to the ground if released from its container. It is the toxic effect of chlorine gas that makes it a good disinfectant, but it is toxic to more than just waterborne pathogens; it is also toxic to humans and virtually all life. It is a respiratory irritant and it can also irritate skin and mucus membranes.

Exposure to high volumes of chlorine gas fumes can cause serious health problems, including death.

However, it is important to realize that chlorine gas, once entering the water, changes into hypochlorous acid and hypochlorite ions, and therefore its human toxic properties are not found in the drinking water we consume.

Chlorine gas is sold as a compressed liquid, which is amber in color. Chlorine, as a liquid, is heavier (more dense) than water. If the chlorine liquid is released from its container, it will quickly return back to its gas state. Chlorine gas is the least expensive form of chlorine to use. The typical amount of chlorine gas required for water treatment is 1-16 mg/L of water. Different amounts of chlorine gas are used depending on the quality of water that needs to be treated.

If the water quality is poor, a higher concentration of chlorine gas will be required to disinfect the water if the contact time cannot be increased.

Oxidizing Microbicide

Chlorine gas is likely the most widely used oxidizing microbicide. Besides water and wastewater disinfection, it has traditionally been the biocide of choice in many cooling water treatment systems.

It is a strong oxidizer that is relatively easy to feed and is quite inexpensive. Upon introduction into the water stream, chlorine hydrolyzes into hypochlorous acid (HOCl) and hydrochloric acid (HCl). We will master this chemistry in a few more pages.

Alkaline Conditions

This hydrolyzation provides the active toxicant, HOCl, which is pH-dependent. In alkaline conditions, it readily dissociates to form the hypochlorite ion (OCl⁻). This dissociation phenomenon is important to remember.

In alkaline conditions, OCl⁻ becomes the predominant species and lacks the biocidal efficacy of the non-dissociated form. Considerably more HOCl is present at a pH of 7.0 than at pH 8.5.

Non-Selective

It is also widely known that chlorine is non-selective, making it very sensitive to combining with many other compounds or from in-plant process leaks. Ammonia, organic acids and organic compounds, sulfides, iron and manganese all easily react with HOCl. The amount of chlorine needed to react with these contamination species is referred to as chlorine demand and it must be satisfied before active HOCl is available to provide a free chlorine residual.

The combination of high chlorine demand in process-contaminated systems and the dissociation process in alkaline systems creates the need for greater chlorine feed to obtain the same microbial efficacy.

Pathophysiology

Chlorine is a greenish-yellow, noncombustible gas at room temperature and atmospheric pressure. The intermediate water solubility of chlorine accounts for its effect on the upper airway and the lower respiratory tract. Exposure to chlorine gas may be prolonged because its moderate water solubility may not cause upper airway symptoms for several minutes. In addition, the density of the gas is greater than that of air, causing it to remain near ground level and potentially increasing exposure time.

The odor threshold for chlorine is approximately 0.3-0.5 parts per million (ppm); however, distinguishing toxic air levels from permissible air levels may be difficult until irritative symptoms are present.

Immediate Effects

The immediate effects of chlorine gas toxicity include acute inflammation of the conjunctivae, nose, pharynx, larynx, trachea, and bronchi. Irritation of the airway mucosa leads to local edema secondary to active arterial and capillary hyperemia. Plasma exudation results in filling the alveoli with edema fluid, resulting in pulmonary congestion.

Pathological Findings

Pathologic findings are nonspecific. They include severe pulmonary edema, pneumonia, hyaline membrane formation, multiple pulmonary thromboses, and ulcerative tracheo-bronchitis.

The hallmark of pulmonary injury associated with chlorine toxicity is pulmonary edema, manifested as hypoxia. Non-cardiogenic pulmonary edema is thought to occur when there is a loss of pulmonary capillary integrity. Inhalation of chlorine gas is often fatal.

Mechanism of Activity

The mechanisms of the above biological activity are poorly understood and the predominant anatomic site of injury may vary, depending on the chemical species produced. Cellular injury is believed to result from the oxidation of functional groups in cell components, from reactions with tissue water to form hypochlorous and hydrochloric acid, and from the generation of free oxygen radicals. Although the idea that chlorine causes direct tissue damage by generating free oxygen radicals was once accepted, this idea is now controversial.

The cylinders on the right contain chlorine gas. The gas comes out of the cylinder through a gas regulator. The cylinders are on a scale that operators use to measure the amount used each day. The chains are used to prevent the tanks from falling over.

Chlorine gas is stored in vented rooms that have panic bar equipped doors. Operators have the equipment necessary to reduce the impact of a gas leak, but usually rely on trained emergency response teams to contain leaks.

Solubility Effects

Hydrochloric acid is highly soluble in water. The predominant targets of the acid are the epithelia of the ocular conjunctivae (covering of the eye) and upper respiratory mucus membranes.

Hypochlorous acid is also highly water soluble with an injury pattern similar to hydrochloric acid.

Hypochlorous acid may account for the toxicity of elemental chlorine and hydrochloric acid to the human body.

Early Response to Chlorine Gas

Chlorine gas which is highly toxic when mixed with ammonia, reacts to form chloramine gas. In the presence of water, chloramines decompose to ammonia and hypochlorous acid or hydrochloric acid.

The early response to chlorine exposure depends on the

- (1) concentration of chlorine gas,
- (2) duration of exposure,
- (3) water content of the tissues exposed, and
- (4) individual susceptibility.



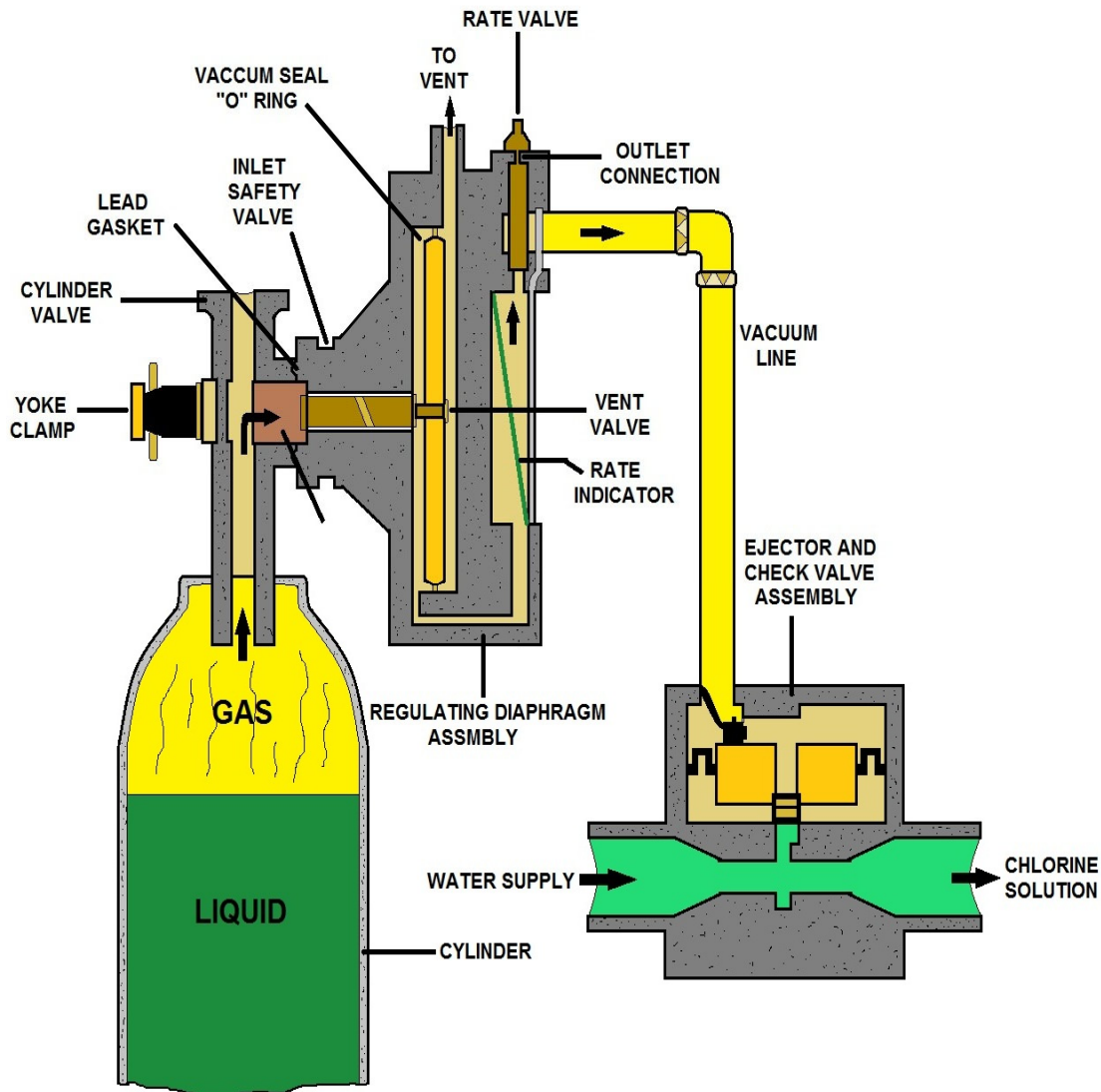

150 Lb. SINGLE CYLINDER CHLORINATOR

Weight of Chlorine

The weight refers to the weight of chlorine that is being supplied, not the weight of the full cylinder. Full 150 pound cylinders will weigh from 235 pounds to 290 pounds. Full ton containers will weigh from 3,300 pounds to 3,650 pounds.

To equal the chlorine available from one 150 lb. chlorine cylinder, you would need to use:

- 180 gal. of sodium hypochlorite or
- 228 lb. of calcium hypochlorite.

To equal the chlorine available from a one-ton chlorine container, you would need to use:

- 2,400 gal. of sodium hypochlorite or
- 3,040 lb. of calcium hypochlorite.



1-ton chlorine gas containers

Unbelievably, this facility uses between 20 and 30 containers per day. 3 shifts are required to handle the chlorine change-outs each day. Normally this is a slow boring job if everything is working properly. This crew is also responsible for any and all chlorine leaks which is a little more exciting. Even when the fire crews show up for a Cl_2 leak, the fire crews are often too scared to touch a leaking cylinder and will ask the water treatment personnel to fix the leak.

Chemistry of Chlorination Sub-Section

Chlorine can be added as sodium hypochlorite, calcium hypochlorite or chlorine gas. When any of these is added to water, chemical reactions occur as these equations show:

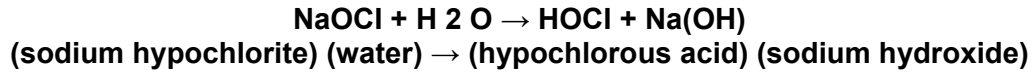
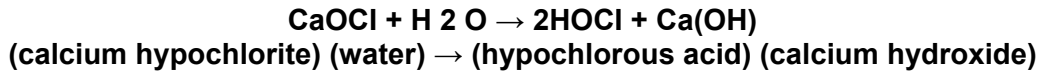
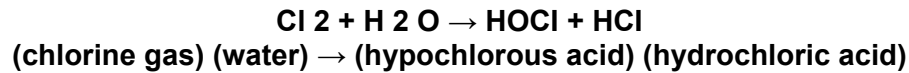

All three forms of chlorine produce hypochlorous acid (HOCl) when added to water. Hypochlorous acid is a weak acid but a strong disinfecting agent. The amount of hypochlorous acid depends on the pH and temperature of the water. Under normal water conditions, hypochlorous acid will also chemically react and break down into a hypochlorite ion. The direction of this reaction is highly pH and temperature dependent.

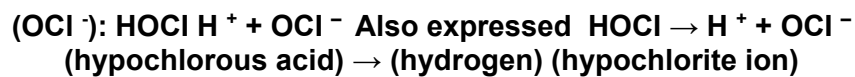

The hypochlorite ion is a much weaker disinfecting agent than hypochlorous acid; about 100 times less effective.

Let's now look at how pH and temperature affect the ratio of hypochlorous acid to hypochlorite ions. As the temperature is decreased, the ratio of hypochlorous acid increases. Temperature plays a small part in the acid ratio.

Although the ratio of hypochlorous acid is greater at lower temperatures, pathogenic organisms are actually harder to kill. All other things being equal, higher water temperatures and a lower pH are more conducive to chlorine disinfection.

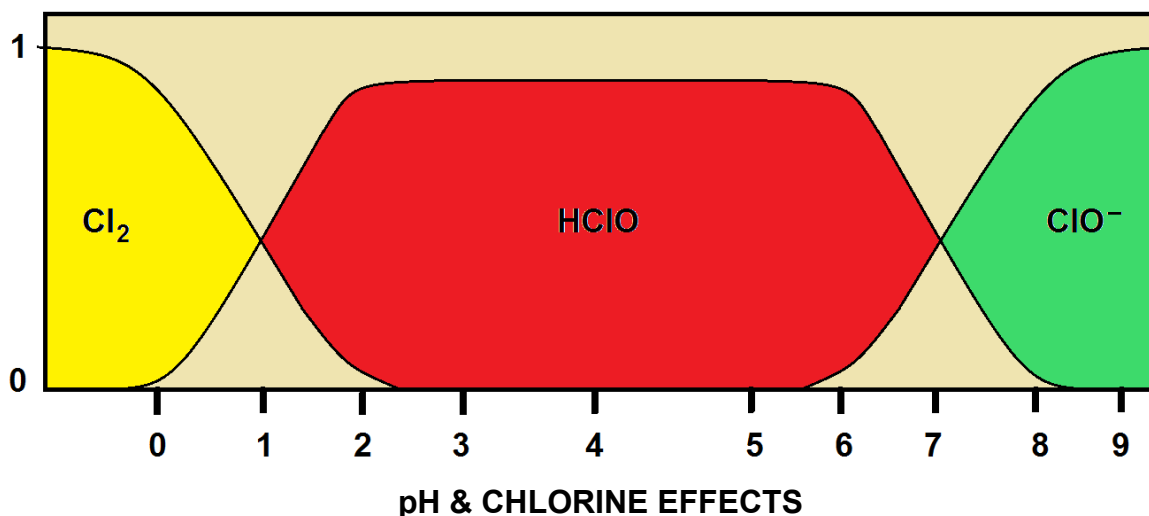

Chlorine present as Cl, HOCl, and OCl⁻ is called *free available chlorine* and that which is bound but still effective is *combined chlorine*. A particularly important group of compounds with combined chlorine is the chloramines formed by reactions with ammonia.

One especially important feature of disinfection using chlorine is the ease of creating a "residual" concentration. There is a constant danger that safe water leaving the treatment plant may become contaminated later. There may be breaks in water mains, loss of pressure that permits an inward leak, or plumbing errors.

This residual concentration of chlorine provides significant of protection right to the water faucet. With free available chlorine, a typical residual is from 0.1 to 0.5 ppm. Because chlorinated organic compounds are less effective, a typical residual is 2 ppm for combined chlorine.

There will be no chlorine residual unless there is an excess over the amount that reacts with the organic matter present. However, reaction kinetics complicates interpretation of chlorination data. The correct excess is obtained in a method called "*Breakpoint Chlorination*".

BACTERIA / VIRUS	DISINFECTION TIME FOR FECAL CONTAMINANTS IN CHLORINATED WATER
E. COLI (BACTERIUM)	LESS THAN 1 MINUTE OF CONTACT TIME
HEPATITUS A (VIRUS)	APPROXIMATELY 16 MINUTES CONTACT TIME
GIARDIA (PARASITE)	APPROXIMATELY 45 MINUTES CONTACT TIME
CRYPTOSPORIDIUM (PARASITE)	APPROXIMATELY 10.6 DAYS (15,300 minutes)

CHLORINE TIMETABLE FOR PROPER DISINFECTION

Chlorine Residual Sub- Section

Types of Residual

If water were pure, the measured amount of chlorine in the water should be the same as the amount added. Nevertheless, water is not 100% pure. There are always other substances (interfering agents) such as iron, manganese, turbidity, etc., which will combine chemically with the chlorine.



$$\text{CHLORINE IN USE} + \text{FREE CHLORINE} = \text{TOTAL CHLORINE}$$

This is called the **chlorine demand**. Naturally, once chlorine molecules are combined with these interfering agents, they are not capable of disinfection. It is free chlorine that is much more effective as a disinfecting agent.

Chlorine Demand

The minimum amount of chlorine needed to react in a water purification system; used as a monitoring measurement by system operators.

Chlorine Residual

The concentration of chlorine in the water after the chlorine demand has been satisfied. The concentration is normally expressed in terms of total chlorine residual, which includes both the free and combined or chemically bound chlorine residuals.

Combined Chlorine Residual

The amount of chlorine used up in a water purification system; used as a monitoring measurement by system operators. Combined chlorine is defined as the residual chlorine existing in water in chemical combination with ammonia or organic amines that can be found in natural or polluted waters.

Ammonia is sometimes deliberately added to chlorinated public water supplies to provide inorganic chloramines.

Free Chlorine

Free chlorine is defined as the concentration of residual chlorine in water present as dissolved gas (Cl_2), hypochlorous acid (HOCl), and/or hypochlorite ion (OCl^-). The three forms of free chlorine exist together in equilibrium.

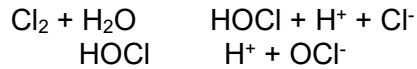

Their relative proportions are determined by the pH value and temperature. Regardless of whether pre-chlorination is practiced or not, a free chlorine residual of at least 1.0 mg/L should be maintained in the clear well or distribution reservoir immediately downstream from the point of post-chlorination and .2 mg/L in the distribution system to guard against backflow.

Total Chlorine Residual

The total of free residual and combined residual chlorine in a water purification system; used as a monitoring measurement by system operators.

Total chlorine is the sum of free and combined chlorine. When chlorinating most potable water supplies, total chlorine is essentially equal to free chlorine since the concentration of ammonia or organic nitrogen compounds (needed to form combined chlorine) will be very low.

When chloramines are present in the municipal water supply, then total chlorine will be higher than free chlorine.

Free, Total, and Combined Chlorine

When a chlorine residual test is taken, either a total or a free chlorine residual can be read.

Total residual is all chlorine that is available for disinfection.

Total chlorine residual = free + combined chlorine residual.

Free chlorine residual is a much stronger disinfecting agent. Therefore, most water regulating agencies will require that your daily chlorine residual readings be of free chlorine residual.

Break-point chlorination is where the chlorine demand has been satisfied, and any additional chlorine will be considered **free chlorine**.

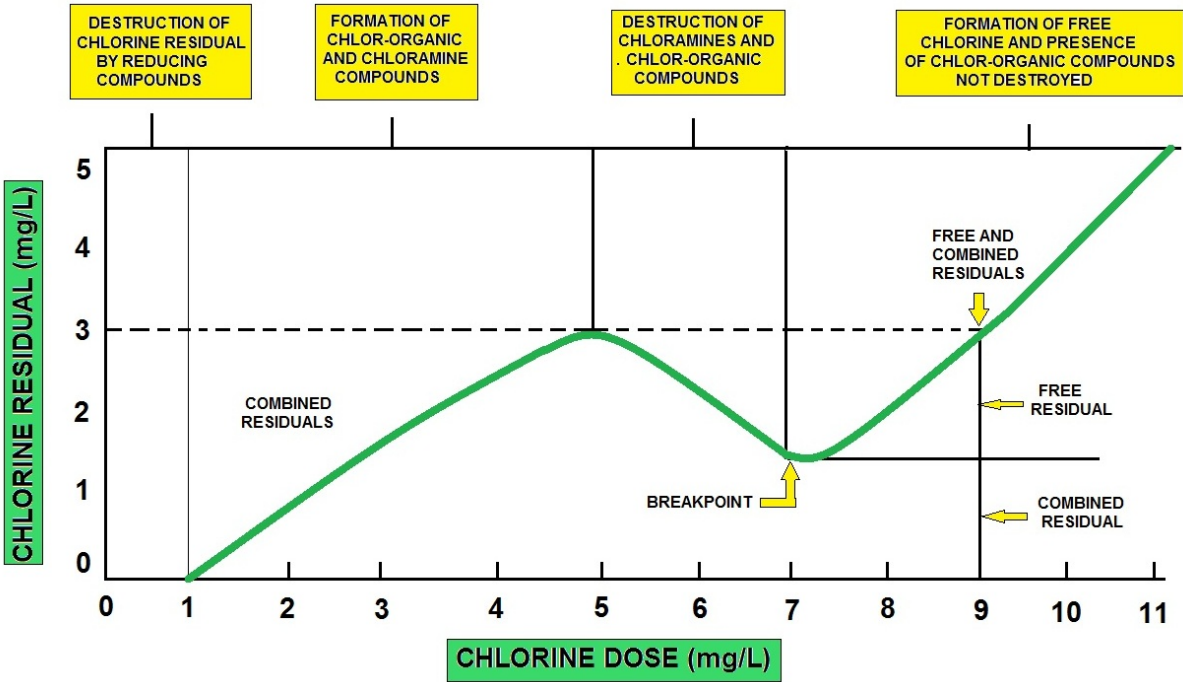

CHLORINE BREAKPOINT CHART #1

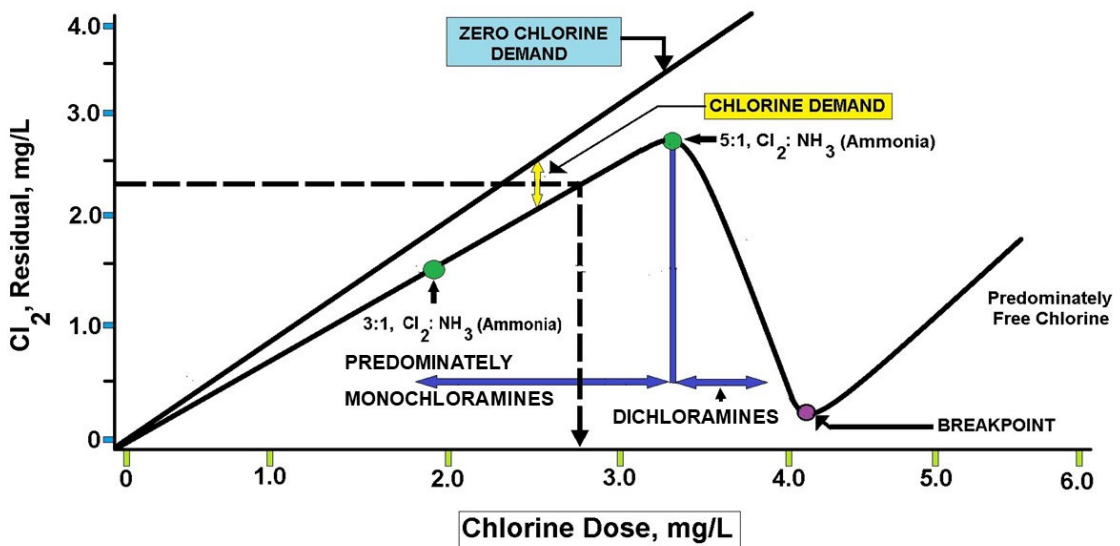

CHLORAMINATION DOSING CURVE

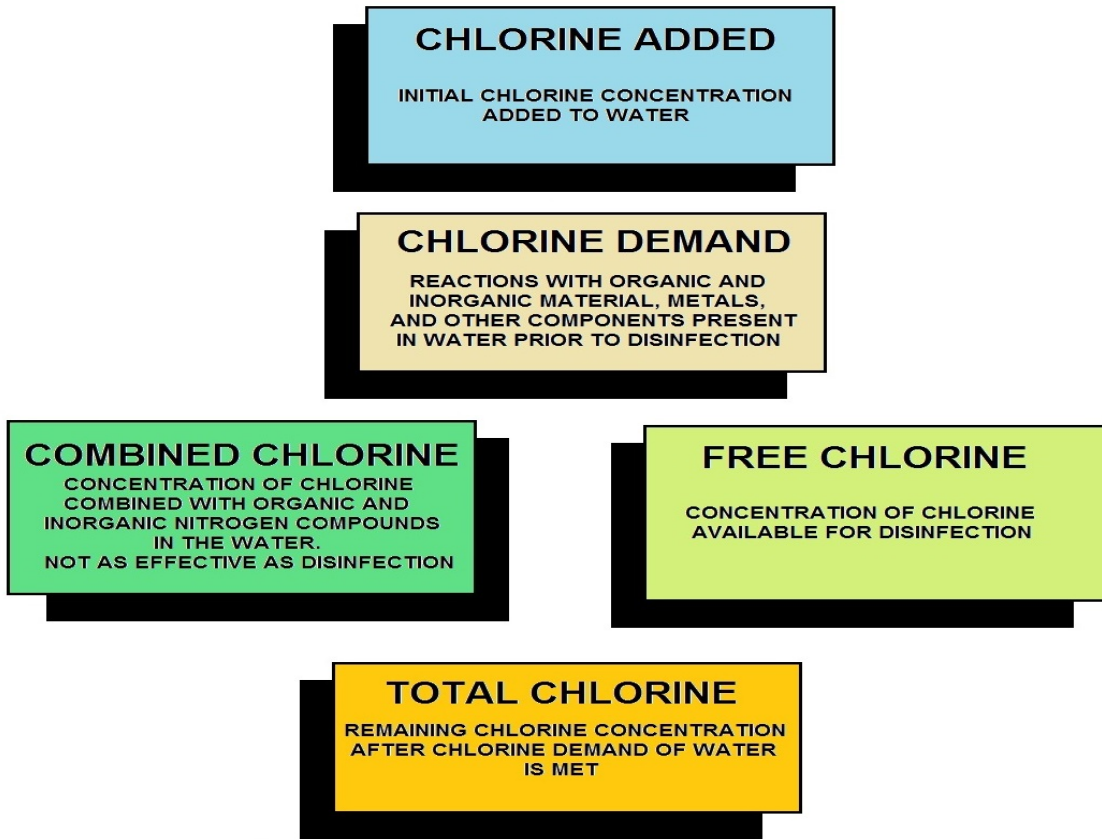

CHLORINE RESIDUAL ORDER CHART

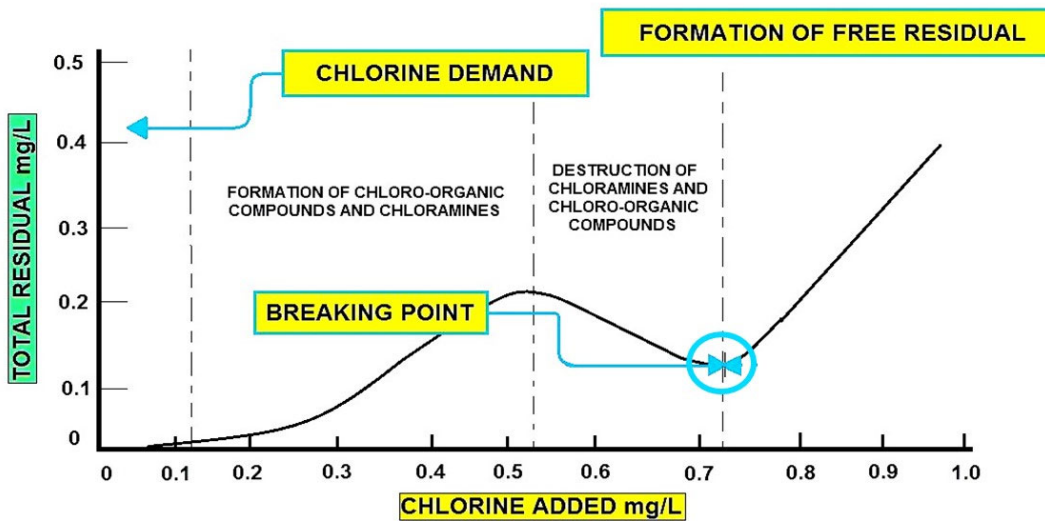

REACTION OF CHLORINE IN WATER

Disinfection to eliminate fecal and coliform bacteria may not be sufficient to adequately reduce pathogens such as Giardia or viruses to desired levels. Use of the "CT" disinfection concept is recommended to demonstrate satisfactory treatment, since monitoring for very low levels of pathogens in treated water is analytically very difficult.

The CT concept, as developed by the United States Environmental Protection Agency (Federal Register, 40 CFR, Parts 141 and 142, June 29, 1989), uses the combination of disinfectant residual concentration (mg/L) and the effective disinfection contact time (in minutes) to measure effective pathogen reduction. The residual is measured at the end of the process, and the contact time used is the T10 of the process unit (time for 10% of the water to pass).

$$\text{CT (Contact time)} = \text{Concentration (mg/L)} \times \text{Time (Minutes)}$$

Required Giardia/Virus Reduction

All surface water treatment systems shall ensure a minimum reduction in pathogen levels: 3-log reduction in Giardia and 4-log reduction in viruses. These requirements are based on unpolluted raw water sources with Giardia levels of = 1 cyst/100 L, and a finished water goal of 1 cyst/100,000 L (equivalent to 1 in 10,000 risk of infection per person per year). Higher raw water contamination levels may require greater removals as shown on Table 4.1.

BACTERIA / VIRUS	DISINFECTION TIME FOR FECAL CONTAMINANTS IN CHLORINATED WATER
E. COLI (BACTERIUM)	LESS THAN 1 MINUTE OF CONTACT TIME
HEPATITUS A (VIRUS)	APPROXIMATELY 16 MINUTES CONTACT TIME
GIARDIA (PARASITE)	APPROXIMATELY 45 MINUTES CONTACT TIME
CRYPTOSPORIDIUM (PARASITE)	APPROXIMATELY 10.6 DAYS (15,300 minutes)

CHLORINE TIMETABLE FOR PROPER DISINFECTION

**TABLE 4.1
LEVEL OF GIARDIA REDUCTION**

Raw Water Giardia Levels*
**Recommended Giardia Log
Reduction**

- < 1 cyst/100 L 3-log
- 1 cyst/100 L - 10 cysts/100 L 3-log - 4-log
- 10 cysts/100 L - 100 cysts/100 L 4-log - 5-log
- > 100 cysts/100 L > 5-log

*Use geometric means of data to determine raw water Giardia levels for compliance.

Required CT Value

Required CT values are dependent on pH, residual concentration, temperature, and the disinfectant used.

Calculation and Reporting of CT Data

Disinfection CT values shall be calculated daily, using either the maximum hourly flow and the disinfectant residual at the same time, or by using the lowest CT value if it is calculated more frequently. Actual CT values are then compared to required CT values.

Results shall be reported as a reduction Ratio, along with the appropriate pH, temperature, and disinfectant residual. The reduction Ratio must be greater than 1.0 to be acceptable. Users may also calculate and record actual log reductions.

$$\text{Reduction Ratio} = \text{CT actual} \div \text{CT required}$$

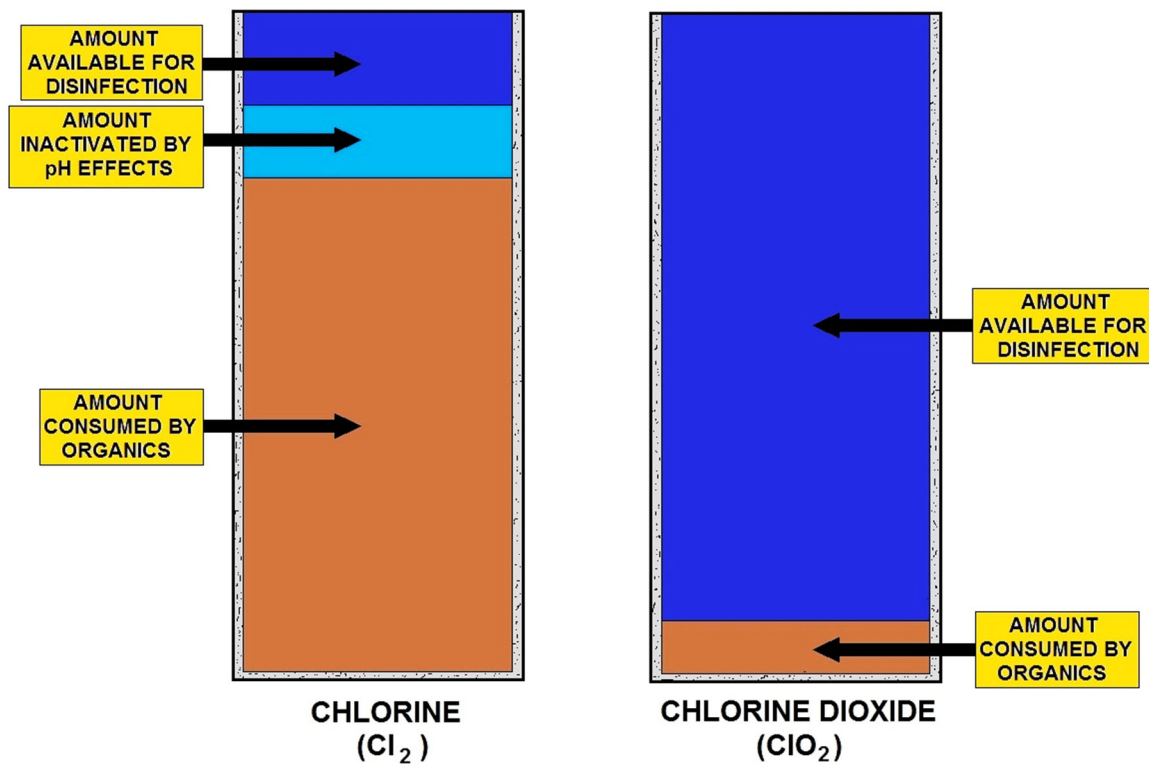

THE DIFFERENCE IN USING CHLORINE AND CHLORINE DIOXIDE AS A DISINFECTANT

Understanding Chlorine Residual

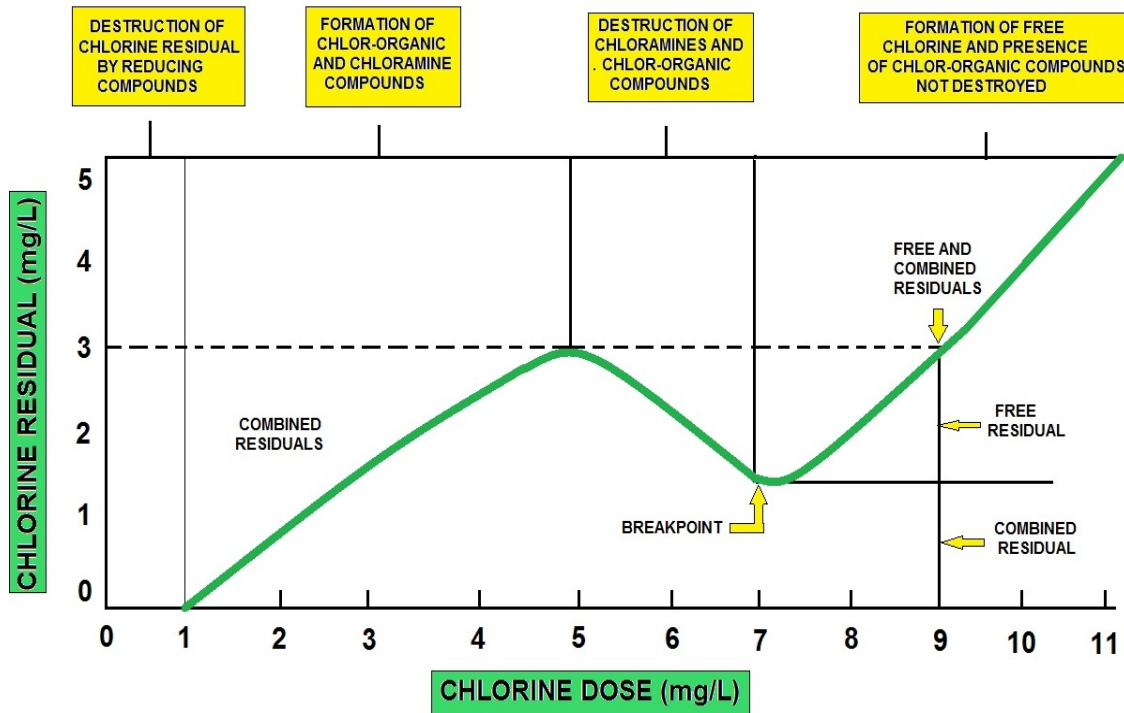

CHLORINE BREAKPOINT

The amount of available chlorine present in wastewater after a given contact time (20 minutes at peak flow; 30 minutes at average flow), and under specific conditions including pH and temperature. For effective water treatment, the water supply industry has recognized the need for adequate exposure to the disinfectant and sufficient disinfectant dosage for a certain amount of time. In the 1980s, the two functions were combined with the development of the CT values for various disinfectants.

CT represents the combination of the disinfectant dosage and the length of time water has been exposed to a minimum amount of the disinfectant residual.

Mathematically it is represented as $CT = \text{concentration} \times \text{time}$
 concentration = final disinfectant concentration in mg/l
 time = minimum exposure time in minutes

In an assessment of disinfection effectiveness, two types of organisms have been chosen as disinfection surrogates – the protozoan *Giardia* and viruses. CT values established for disinfection of surface waters require treatment plants to achieve a three-log or 99.9% reduction in *Giardia* and a four-log or 99.99% virus reduction. It is important to recognize that the use of chlorine as the disinfectant is only one part of the treatment process. Equally important is the need for improved filtration to remove organisms.

A combination of proper disinfection and filtration is most effective in providing safe drinking water. Recent experiments in controlling *Cryptosporidium* also suggest the effectiveness of filtration in the water treatment process.

Free residual chlorination involves the application of chlorine to water to produce--either directly or by first destroying any naturally present ammonia--a free available chlorine residual and to maintain this residual through part or all of the water treatment plant and distribution system. Free available residual forms have higher oxidation potentials than combined available chlorine forms and are more effective as disinfectants.

When free available chlorine residuals are desired, the characteristics of the water will determine how this will be accomplished. This may have to be considered:

1. If the water contains no ammonia or other nitrogen compounds, any application of chlorine will yield a free residual once it has reacted with any bacteria, virus and other microorganisms present in the water.
2. If the water contains ammonia, it results in the formation of a combined residual, which must be destroyed by applying an excess of chlorine.

Breakpoint Chlorination

Breakpoint chlorination is the name of the process of adding chlorine to water until the chlorine demand has been satisfied. Chlorine demand equals the amount of chlorine used up before a free available chlorine residual is produced. Further additions of chlorine will result in a chlorine residual that is directly proportional to the amount of chlorine added beyond the breakpoint. Public water supplies normally chlorinate past the breakpoint.

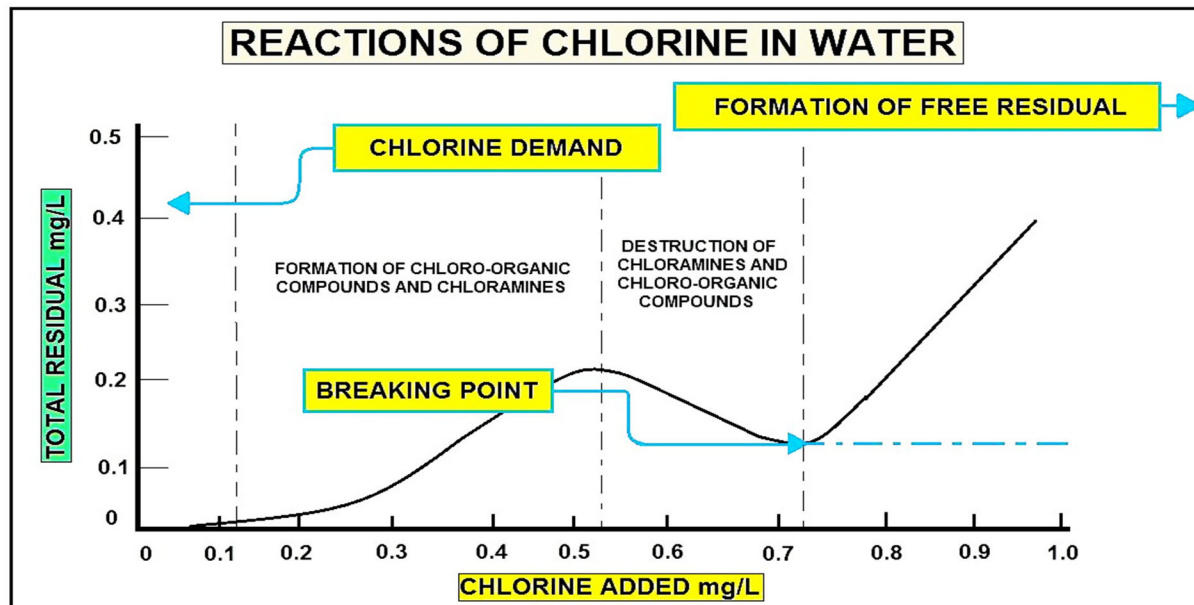

When chlorine is initially added to water, the following may happen:

1. If the water contains some iron, manganese, organic matter, and ammonia, the chlorine reacts with these materials and no residual is formed, meaning that no disinfection has taken place.
2. If additional chlorine is added at this point, it will react with the organics and ammonia to form chloramines. The chloramines produce a combined chlorine residual. As the chlorine is combined with other substances, it loses some of the disinfection strength. Combined residuals have poor disinfection power and may be the cause of taste and odor problems.
3. With a little more chlorine added, the chloramines and some of the chlororganics are destroyed.
4. With still more chlorine added, a free chlorine residual is formed, free in the sense that it can react quickly.

Free available chlorine is the best residual for disinfection. It disinfects faster and without the swimming-pool odor of combined residual chlorine. The free available residual forms at the breakpoint; therefore, the process is called breakpoint chlorination. The common practice today is to go just beyond the breakpoint to a residual of about .2 to .5 ppm.

A variety of reactions take place during chlorination. When chlorine is added to a water containing ammonia (NH_3), the ammonia reacts with hypochlorous acid (HOCL) to form monochloramine, dichloramine, and trichloramine. The formation of these chloramines depends on the pH of the water and the initial chlorine-ammonia ratio.

Ammonia + Hypochlorous acid ----> Chloramine + Water

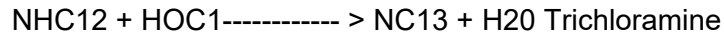
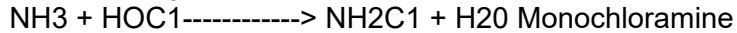

At the pH of most natural water (pH 6.5 to 7.5), monochloramine and dichloramine exist together. At pH levels below 5.5, dichloramine exists by itself. Below pH 4.0, trichloramine is the only compound found. The monochloramine and dichloramine forms have a definite disinfection power. Dichloramine is a more effective disinfecting agent than monochloramine. However, dichloramine is not recommended as a disinfectant due to the possibility of the formation of taste and odor compounds. Chlorine reacts with phenol and salicylic acid to form chlorophenol, which has an intense medicinal odor. This reaction is much slower in the presence of monochloramines.

Both the chlorine residual and the contact time are essential for effective disinfection. It is important to have complete mixing. The operator also needs to be aware that changes in the pH may affect the ability of the chlorine to disinfect the water. The operator must examine the application and select the best point of feed and the best contact time to achieve the results desired. The operator needs to consider:

1. Whether the injection point and the method of mixing is designed so that the disinfectant is able to get into contact with all of the water to be disinfected. This also depends on whether pre- and/or post-chlorination is being used.
2. Contact time. In situations of good initial mixing, the longer the contact time, the more effective the disinfection.
3. Effectiveness of upstream treatment processes. The lower the turbidity of the water, the more effective the disinfection.
4. Temperature. At higher temperatures the rate of disinfection is more rapid.
5. Dosage and type of chemical. Usually the higher the dose, the quicker the disinfection rate. The form of disinfectant (chloramine or free chlorine) and the type of chemical used influence the disinfection rate.
6. pH. The lower the pH, the better the disinfection.

Chlorine Demand

Chlorine combines with a wide variety of materials. These side reactions complicate the use of chlorine for disinfecting purposes. Their demand for chlorine must be satisfied before chlorine becomes available to accomplish disinfection. The amount of chlorine required to react on various water impurities before a residual is obtained. In addition, it means the amount of chlorine required to produce a free chlorine residual of 0.1 mg/l after a contact time of fifteen minutes as measured by Iodometric method of a sample at a temperature of twenty degrees in conformance with Standard methods.

Disinfection Information

- ▶ Contact time is required
 - ▶ 99% or 2 log inactivation of crypto
 - ▶ 99.9% or 3 log inactivation of giardia lamblia cysts
 - ▶ 99.99% or 4 log inactivation of enteric viruses
- ▶ CT = Concentration of disinfectant x contact time
- ▶ The chlorine residual leaving the plant must be = or > 0.2 mg/L and measurable throughout the system.

Measuring Chlorine Residual Sub-Section

Amperometric Titration

Amperometric titrations have been successfully used for accurate determination of residual chlorine in water at many plants to maintain regulatory compliance. Different species of chlorine have also been determined, with suitable modification of the method, as free available chlorine, chloramine, chlorine dioxide, and chlorite.

Various dual polarizable electrodes have been used for the amperometric titration of low concentrations of residual chlorine in water. In particular, amperometric (iodometric) titrations with dual platinum electrodes have gained considerable interest in the determination of total residual chlorine in water. Selective iodometric titrations with dual polarizable electrodes have also been found to be useful for the speciation of chlorine in water, providing the ability to distinguish between free and combined residual chlorine, and between monochloramine and dichloramine in water.

In the amperometric determination of free chlorine, chlorine is titrated with a standard reducing agent such as thiosulfate or phenyl arsine oxide (PAO) at pH 7. As long as the oxidant (free chlorine) is present in the titrated sample, a current flows through the cell.

The standard amperometric sensor design consists of two electrodes (anode and cathode) that measure a change in current caused by the chemical reduction of hypochlorous acid at the cathode. The current that flows because of this reduction is proportional to the chlorine concentration. A membrane and electrolyte help to control the reaction. Flow rate and pressure must be carefully controlled for accurate measurement.

The effect of pH on the disassociation of hypochlorous acid to the hypochlorite ion is quite significant. A standard sensor design is suitable for a constant pH in the range of 6.8-8.0. Calibration of the system enables compensation for the pH of the sample.



Varying pH

For applications with varying pH, or pH values beyond this range, an extended pH range sensor is available using a 4.0 pH electrolyte in the membrane cap. This enables conversion of the hypochlorite ion to hypochlorous acid, enabling accurate chlorine readings in solutions between pH 4.0-12.0.

Time for Measurement

The amount of time to achieve an accurate reading is only 30 seconds for a standard sensor, two minutes for an extended pH range sensor. Flow to the sensor must be consistently controlled in the range of 8-26.4 gal/hr; with a maximum pressure of 1 atm (discharge of sensor must be to atmospheric pressure). Each sensor typically has a required flow cell configuration to enable accurate measurements. During initial start-up, the sensor must be conditioned in the flow stream for 12-24 hours before attempting any calibration.

Using DPD Method for Chlorine Residuals N, N – diethyl-p-phenylenediamine



Small portable chlorine measuring kit. The redder the mixture the “hotter” or stronger the chlorine in solution.

Measuring Chlorine Residual

Chlorine residual is the amount of chlorine remaining in water that can be used for disinfection. A convenient, simple and inexpensive way to measure chlorine residual is to use a small portable kit with pre-measured packets of chemicals that are added to water. (Make sure you buy a test kit using the **DPD method**, and not the outdated orthotolidine method.)

Chlorine test kits are very useful in adjusting the chlorine dose you apply. You can measure what chlorine levels are being found in your system (especially at the far ends).

Free chlorine residuals need to be checked and recorded daily. These results should be kept on file for a health or regulatory agency inspection during a regular field visit.

The most accurate method for determining chlorine residuals is to use the laboratory amperometric titration method.

Additional Drinking Water Methods (Non-EPA) for Chemical Parameters

Method	Method Focus	Title	Location	Source
4500-Cl ⁻ B	Chloride by Silver Nitrate Titration	Standard Methods for the Examination of Water and Wastewater, 18th & 19th Ed.	Included in Standard Methods	American Water Works Assn. (AWWA)
4500-Cl ⁻ D	Chloride by Potentiometric Method	Standard Methods for the Examination of Water and Wastewater, 18th, 19th & 20th Editions	Included in Standard Methods	American Water Works Assn. (AWWA)
4500-Cl D	Chlorine Residual by Amperometric Titration (Stage 1 DBP use SM 19th Ed. only)	Standard Methods for the Examination of Water and Wastewater, 18th, 19th & 20th Editions	Included in Standard Methods	American Water Works Assn. (AWWA)
4500-Cl E	Chlorine Residual by Low Level Amperometric Titration (Stage 1 DBP use SM 19th Ed. only)	Standard Methods for the Examination of Water and Wastewater, 18th, 19th & 20th Editions	Included in Standard Methods	American Water Works Assn. (AWWA)
4500-Cl F	Chlorine Residual by DPD Ferrous Titration (Stage 1 DBP use SM 19th Ed. only)	Standard Methods for the Examination of Water and Wastewater, 18th, 19th & 20th Editions	Included in Standard Methods	American Water Works Assn. (AWWA)
4500-Cl G	Chlorine Residual by DPD Colorimetric Method (Stage 1 DBP use SM 19th Ed. only)	Standard Methods for the Examination of Water and Wastewater, 18th, 19th & 20th Editions	Included in Standard Methods	American Water Works Assn. (AWWA)
4500-Cl H	Chlorine Residual by Syringaldazine (FACTS) Method (Stage 1 DBP use SM 19th Ed. only)	Standard Methods for the Examination of Water and Wastewater, 18th, 19th & 20th Editions	Included in Standard Methods	American Water Works Assn. (AWWA)
4500-Cl I	Chlorine Residual by Iodometric Electrode Technique (Stage 1 DBP use SM 19th Ed. only)	Standard Methods for the Examination of Water and Wastewater, 18th, 19th & 20th Editions	Included in Standard Methods	American Water Works Assn. (AWWA)
4500-ClO ₂ C	Chlorine Dioxide by the Amperometric Method I	Standard Methods for the Examination of Water and Wastewater, 18th, 19th & 20th Editions	Included in Standard Methods	American Water Works Assn. (AWWA)
4500-ClO ₂ D	Chlorine Dioxide by the DPD Method (Stage 1 DBP use SM 19th Ed. only)	Standard Methods for the Examination of Water and Wastewater, 18th, 19th & 20th Editions	Included in Standard Methods	American Water Works Assn. (AWWA)
4500-ClO ₂ E	Chlorine Dioxide by the Amperometric Method II (Stage 1 DBP use SM 19th Ed. only)	Standard Methods for the Examination of Water and Wastewater, 18th, 19th & 20th Editions	Included in Standard Methods	American Water Works Assn. (AWWA)

1. Do The Basics

- TEST WATER CHEMISTRY
- CHECK WATER FLOW RATE
- ESTIMATE CHLORINE DEMAND
- DETERMINE CONTACT TANK SIZE
- NOTE THE LINE PRESSURE WHERE CHLORINE WILL BE INJECTED INTO



2. Choose A Chlorinator

- LIQUID CHLORINATOR OR DRY FEED
- WHERE TO INSTALL CHLORINATOR BEFORE / AFTER PRESSURE TANK
- PERISTALTIC METERING PUMP OR DIAPHRAGM PUMP



3. Installation

- BUY DIRECTLY AND INSTALL
OR
- BUY DIRECTLY AND HIRE PLUMBER
OR
- BUY FROM WATER TREATMENT DEALER

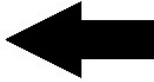

4. Quality Control

- SET-UP MAINTENANCE SCHEDULE
- CLIPBOARD WITH CHECKLIST
- TEST THE WATER ANNUALLY

HOW TO DETERMINE A CHLORINATION SYSTEM

Chlorination Equipment Requirements

For all water treatment facilities, chlorine gas under pressure shall not be permitted outside the chlorine room. The chlorine room is the room where chlorine gas cylinders and/or ton containers are stored. Vacuum regulators shall also be located inside the chlorine room. The chlorinator, which is the mechanical gas proportioning equipment, may or may not be located inside the chlorine room.

For new and upgraded facilities, from the chlorine room, chlorine gas vacuum lines should be run as close to the point of solution application as possible. Injectors should be located to minimize the length of pressurized chlorine solution lines.

A gas pressure relief system shall be included in the gas vacuum line between the vacuum regulator(s) and the chlorinator(s) to ensure that pressurized chlorine gas does not enter the gas vacuum lines leaving the chlorine room.

The gas pressure relief system shall vent pressurized gas to the atmosphere at a location that is not hazardous to plant personnel; the vent line should be run in such a manner that moisture collecting traps are avoided. The vacuum regulating valve(s) shall have positive shutdown in the event of a break in the downstream vacuum lines. As an alternative to chlorine gas, it is permissible to use hypochlorite with positive displacement pumping. Anti-siphon valves shall be incorporated in the pump heads or in the discharge piping.

Capacity

The chlorinator shall have the capacity to dose enough chlorine to overcome the demand and maintain the required concentration of the "**free**" or "**combined**" chlorine.

Methods of Control

The chlorine feed system shall be automatic proportional controlled, automatic residual controlled, or compound loop controlled. In the automatic proportional controlled system, the equipment adjusts the chlorine feed rate automatically in accordance with the flow changes to provide a constant pre-established dosage for all rates of flow. In the automatic residual controlled system, the chlorine feeder is used in conjunction with a chlorine residual analyzer which controls the feed rate of the chlorine feeders to maintain a particular residual in the treated water. In the compound loop control system, the feed rate of the chlorinator is controlled by a flow proportional signal and a residual analyzer signal to maintain particular chlorine residual in the water.

Manual chlorine feed systems may be installed for groundwater systems with constant flow rate.

Standby Provision

As a safeguard against malfunction and/or shut-down, standby chlorination equipment having the capacity to replace the largest unit shall be provided. For uninterrupted chlorination, gas chlorinators shall be equipped with an automatic changeover system. In addition, spare parts shall be available for all chlorinators.



Weigh Scales

Scales for weighing cylinders shall be provided at all plants using chlorine gas to permit an accurate reading of total daily weight of chlorine used. At large plants, scales of the recording and indicating type are recommended. At a minimum, a platform scale shall be provided. Scales shall be of corrosion-resistant material. Read the scales daily and at the same time.

Securing Cylinders

All chlorine cylinders shall be securely positioned to safeguard against movement. Tag the cylinder “**empty**” and store upright and chained. Ton containers may not be stacked.



In the photo, we have a 1-ton chlorine gas container and 150-pound Cl₂ gas cylinders. The 1-ton is on a scale. Cylinders stand up-right and containers on their sides.



Here is an operator checking for Cl₂ leaks with Ammonia. If there is a Cl₂ leak, you will be able to see a white smoke. Even if you cannot smell the chlorine, the ammonia will find the leak.



Chlorine measurement devices or Rotameters.

Chlorine is only slightly soluble in water; its maximum solubility is approximately one percent at 49° C. At temperatures below this point it combines with water to form chlorine ice, a crystalline substance. When the water supply to a gas chlorinator is below normal room temperature, it may cool the chlorine gas to the point at which chlorine ice is formed and accumulates on the needle valve and gas outlet tube, resulting in erratic feed results. Because the vapor pressure of chlorine increases with rising temperatures, its solubility also decreases. At 212° F. chlorine is insoluble in water.



Safety Information: There is a fusible plug on every chlorine gas cylinder. This metal plug will melt at 158° to 165° F. This is to prevent a build-up of excessive pressure and the possibility of cylinder rupture due to fire or high temperatures.

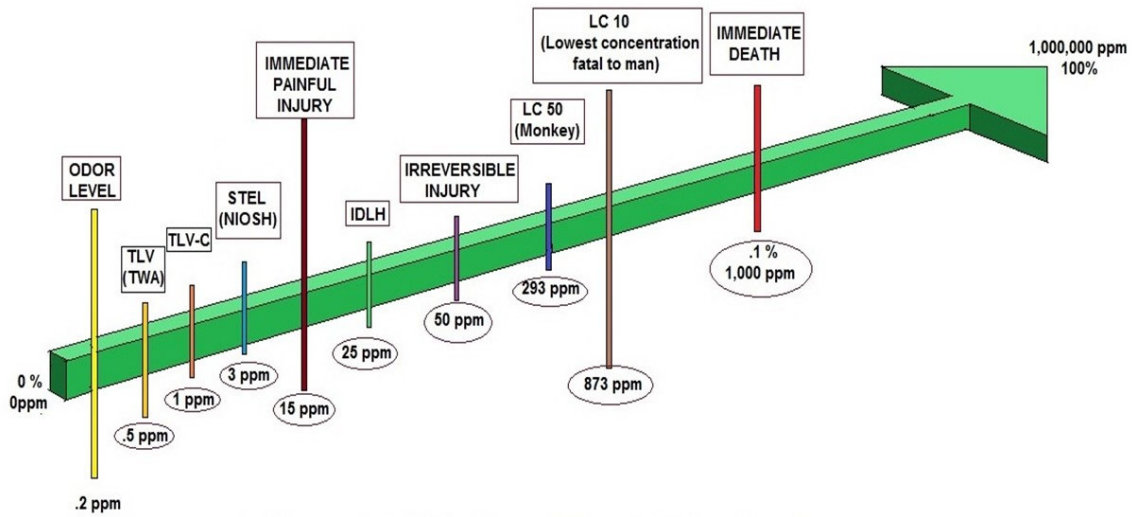

LOGARITHMIC SCALE OF CHLORINE EXPOSURE



Small chlorine storage shed in the foreground; notice the vents at the bottom and top. The bottom vent will allow the gas to ventilate because Cl_2 gas is heavier than air.

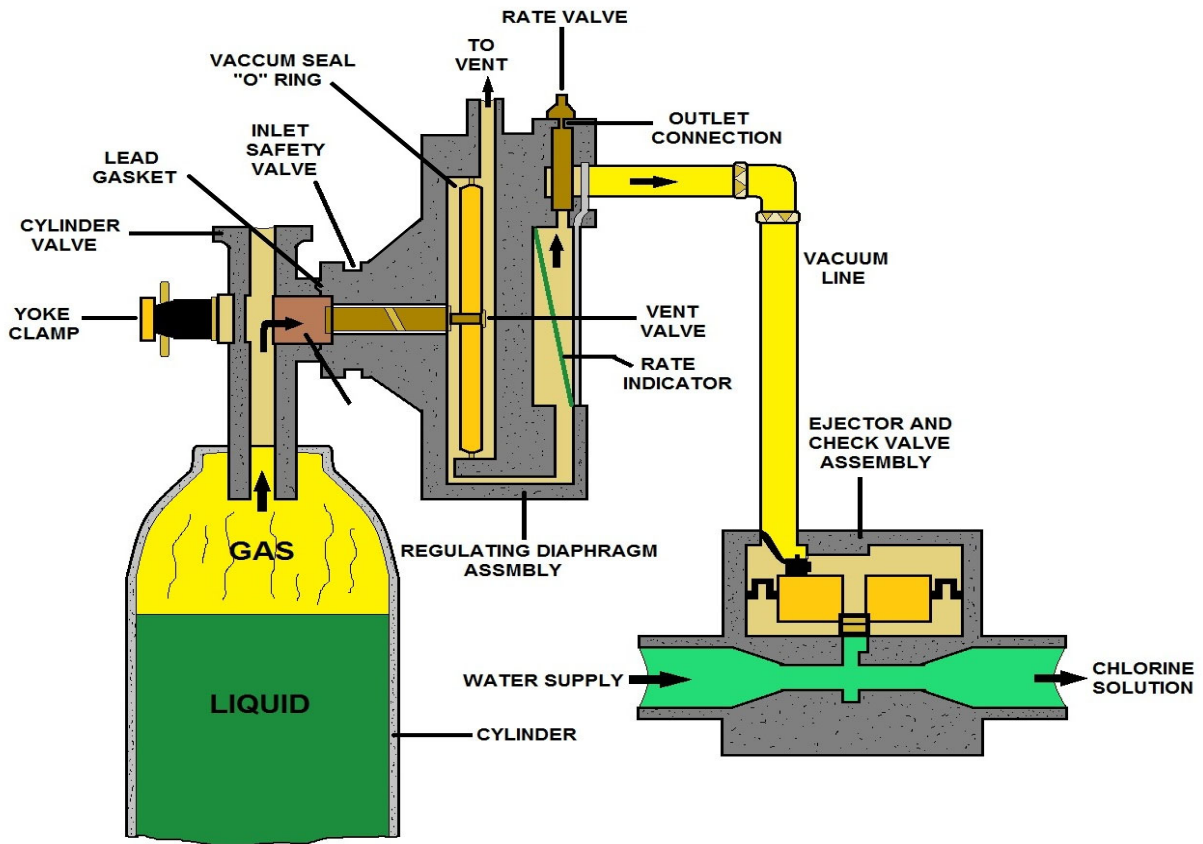

150 LB SINGLE CHLORINE CYLINDER CHLORINATOR DIAGRAM #1

Cylinder Procedures

When replacing the connection from a chlorine cylinder to a chlorinator always use a new, approved gasket on the connector and follow the manufacturer's instructions.

Safety precautions when using chlorine gas:

In addition to protective clothing and goggles, chlorine gas should be used only in a well-ventilated area so that any leaking gas cannot concentrate.

Approved method for storing a chlorine cylinder:

Secure each cylinder in an upright position, attach the protective bonnet over the valve and firmly secure each cylinder.

Emergency procedures in the case of a large uncontrolled chlorine leak:

Notify local emergency response team, warn and evacuate people in adjacent areas, be sure that no one enters the leak area without adequate self-contained breathing equipment.

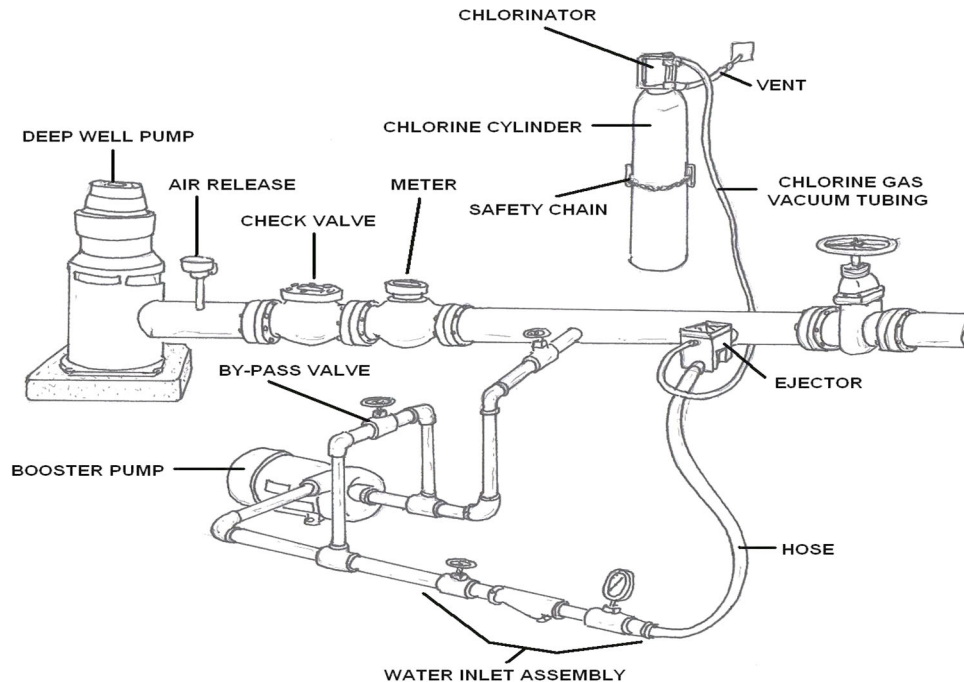

150 LB SINGLE CHLORINE CYLINDER CHLORINATOR DIAGRAM #2

Changing 100- and 150-Pound Cylinder Instructions

1. Turn valve stem clockwise to close cylinder valve.
2. Allow float in flow meter to drop to zero. Indicator on front of gas feeder should indicate no gas.
3. Wait about one minute. Float should remain at zero. If the float flutters or does not drop to zero, the valve is not closed tightly. Make sure the valve is closed before proceeding.
4. Turn off ejector, and make certain the gas supply indicator stays in the "No Gas" position by turning the "Reset" knob. If the indicator resets, either gas pressure is still present or there is an air leak in the system. Refer to instruction manual if an air leak is evident.
5. Loosen gas feeder yoke screw. Remove gas feeder from valve.
6. Replace gas cylinder. Be sure to use a chain or cable to secure the new cylinder properly.
7. Remove old lead gasket. Inspect and clean mating surfaces of gas feeder and valve. Install new lead gasket.
8. Position gas feeder on new gas cylinder and tighten yoke screw. Do not tighten excessively.
9. Crack open gas cylinder valve and close quickly.
10. Use ammonia solution to check for leaks. If a white cloud or vapor appears, turn on ejector and repeat steps 2, 3, 4, and correct leaks.
11. After you verify there are no leaks, open gas cylinder valve, about ¼-turn only, and leave cylinder wrench on valve.
12. Turn on the ejector.

Notes:

- A. See your gas feeder manufacturer's guide for more detailed instructions.
- B. Immediately contact your gas supplier if the cylinder valve or cylinder is defective.

Chlorine Leak Detection

Automatic chlorine leak detection and related alarm equipment shall be installed at all water treatment plants using chlorine gas. Leak detection shall be provided for the chlorine rooms. Chlorine leak detection equipment should be connected to a remote audible and visual alarm system and checked on a regular basis to verify proper operation.

Leak detection equipment shall not automatically activate the chlorine room ventilation system in such a manner as to discharge chlorine gas. During an emergency if the chlorine room is unoccupied, the chlorine gas leakage shall be contained within the chlorine room itself in order to facilitate a proper method of clean-up.

Consideration should also be given to the provision of caustic soda solution reaction tanks for absorbing the contents of leaking one-ton cylinders where such cylinders are in use. Chlorine leak detection equipment may not be required for very small chlorine rooms with an exterior door (i.e., floor area less than 10 feet squared (3m²)). You can use a spray solution of ammonia or a rag soaked with ammonia to detect a small Cl₂ leak. If there is a leak, the ammonia will create a white colored smoke, ammonium chloride. Check with OSHA and the chlorine manufacturer for specific information.

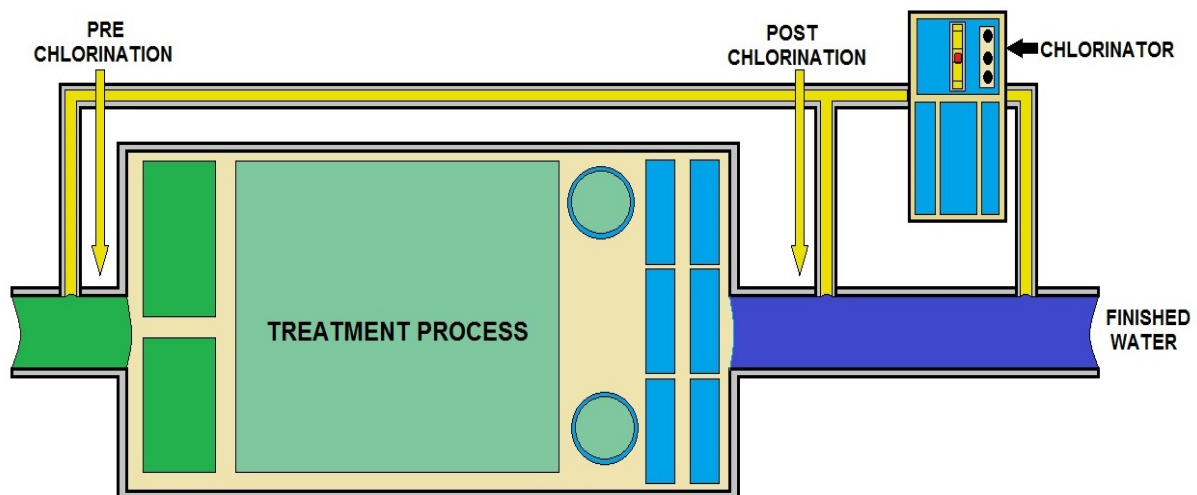

CHLORINE FLOW IN A TREATMENT PLANT

Safety Equipment

The facility shall be provided with personnel safety equipment to include the following: Respiratory equipment, safety shower, eyewash, gloves, eye protection, protective clothing, cylinder and/or ton repair kits.

Respiratory equipment shall be provided which has been approved under the Occupational Health and Safety Act, General Safety Regulation - Selection of Respiratory Protective Equipment. Equipment shall be in close proximity to the access door(s) of the chlorine room.

Chlorine Room Design Requirements

Where gas chlorination is practiced, the gas cylinders and/or the ton containers up to the vacuum regulators shall be housed in a gas-tight, well illuminated, corrosion resistant and mechanically ventilated enclosure. The chlorinator may or may not be located inside the chlorine room. The chlorine room shall be located at the ground floor level.

Ventilation

Gas chlorine rooms shall have entirely separate exhaust ventilation systems capable of delivering one complete air change per minute during periods of chlorine room occupancy only - there shall be no continuous ventilation. The air outlet from the room shall be 6 inches (150 mm) above the floor and the point of discharge located to preclude contamination of air inlets to buildings or areas used by people. The vents to the outside shall have insect screens.

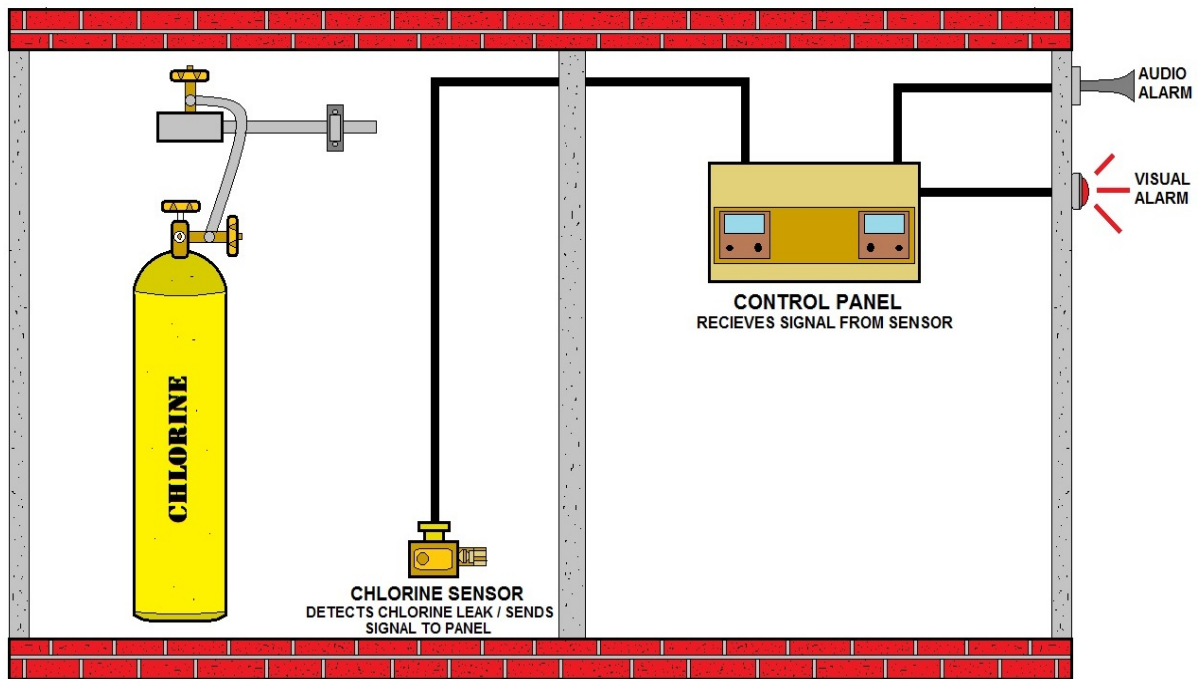

CHLORINE STORAGE ROOM

Air inlets should be louvered near the ceiling, the air being of such temperature as to not adversely affect the chlorination equipment. Separate switches for fans and lights shall be outside the room at all entrance or viewing points, and a clear wire-reinforced glass window shall be installed in such a manner as to allow the operator to inspect from the outside of the room. Check with OSHA and the Chlorine manufacturer for specific information.

Heating

Chlorine rooms shall have separate heating systems, if a forced air system is used to heat the building. Hot water heating system for the building will negate the need for a separate heating system for the chlorine room. The heat should be controlled at approximately 60° F or 15°C. Check with OSHA and the Chlorine manufacturer for specific information.

Cylinders or containers shall be protected to ensure that the chlorine maintains its gaseous state when entering the chlorinator.

Access

All access to the chlorine room shall only be from the exterior of the building. Visual inspection of the chlorination equipment from inside may be provided by the installation of glass window(s) in the walls of the chlorine room. Windows should be at least 2 foot squared (0.20 m²) in area, and be made of clear wire reinforced glass. There should also be a 'panic bar' on the inside of the chlorine room door for emergency exit.



Storage of Chlorine Cylinders/Containers

If necessary, a separate storage room may be provided to simply store the chlorine gas cylinders, with no connection to the line. The chlorine cylinder/container storage room shall have access either to the chlorine room or from the plant exterior, and arranged to prevent the uncontrolled release of spilled gas.

Chlorine gas storage room shall have provision for ventilation at thirty air changes per hour. Viewing glass windows and a panic button on the inside of door should also be provided. In very large facilities, entry into the chlorine rooms may be through a vestibule from outside.

Scrubbers

For facilities located within residential or densely populated areas, consideration shall be given to provide scrubbers for the chlorine room.



1-TON CHLORINE CONTAINER VALVES

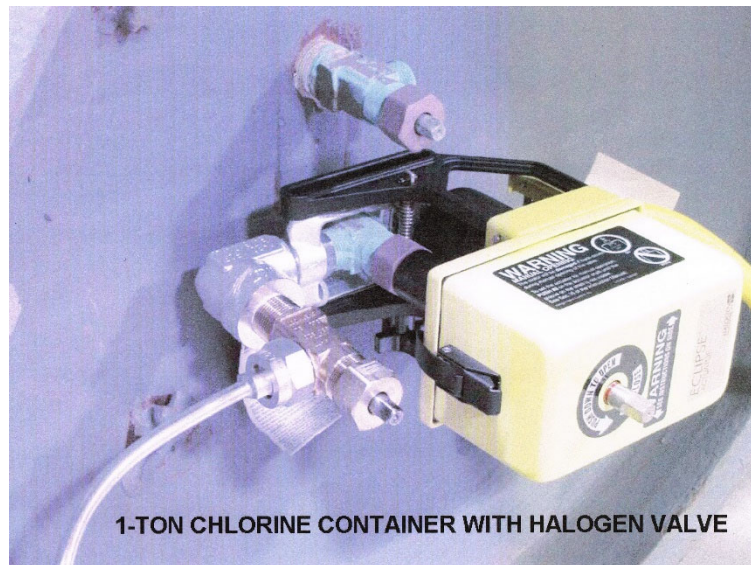

1-TON CHLORINE CONTAINER WITH HALOGEN VALVE

Safety precautions when using chlorine gas:

In addition to protective clothing and goggles, chlorine gas should be used only in a well-ventilated area so that any leaking gas cannot concentrate.

Emergency procedures in the case of a large uncontrolled chlorine leak:

Notify local emergency response team, warn and evacuate people in adjacent areas, be sure that no one enters the leak area without adequate self-contained breathing equipment.

Water Disinfectant Health Cautions

Water suppliers add a disinfectant to drinking water to kill germs such as giardia and e coli. Especially after heavy rainstorms, your water system may add more disinfectant to guarantee that these germs are killed.

Chlorine

Some people who use drinking water containing chlorine well in excess of the EPA standard could experience irritating effects to their eyes and nose. Some people who drink water containing chlorine well in excess of the EPA standard could experience stomach discomfort.

Chloramine

Some people who use drinking water containing chloramines well in excess of the EPA standard could experience irritating effects to their eyes and nose. Some people who drink water containing chloramines well in excess of the EPA standard could experience stomach discomfort or anemia.

Chlorine Dioxide

Some infants and young children who drink water containing chlorine dioxide in excess of the EPA standard could experience nervous system effects. Similar effects may occur in fetuses of pregnant women who drink water containing chlorine dioxide in excess of the EPA standard. Some people may experience anemia.

Disinfection Byproducts Section

Disinfection byproducts form when disinfectants added to drinking water to kill germs react with naturally-occurring organic matter in water.

Total Trihalomethanes

Some people who drink water containing trihalomethanes in excess of the EPA standard over many years may experience problems with their liver, kidneys, or central nervous systems, and may have an increased risk of getting cancer.

Haloacetic Acids

Some people who drink water containing haloacetic acids in excess of the EPA standard over many years may have an increased risk of getting cancer.

Bromate

Some people who drink water containing bromate in excess of the EPA standard over many years may have an increased risk of getting cancer.

Chlorite

Some infants and young children who drink water containing chlorite in excess of EPA standard could experience nervous system effects. Similar effects may occur in fetuses of pregnant women who drink water containing chlorite in excess of the EPA's standard. Some people may experience anemia.

Health advisories provide additional information on certain contaminants. Health advisories are guidance values based on health effects other than cancer. These values are set for different durations of exposure (e.g., one-day, ten-day, longer-term, and lifetime).

SYMPTOM OF CHLORINE POISONING:
DIFFICULTY IN BREATHING, ACCUMULATION IN LUNGS
BURNING SENSATION IN MOUTH, THROAT SWELLING
THROAT AND STOMACH PAIN, VOMITING
ACIDITY LEVELS IN BODY CHANGE, LOW BLOOD PRESSURE
BURNING AND IRRITATION OF EYES, TEMPORARY LOSS OF VISION
TISSUE DAMAGE, BURNS AND IRRITATION OF THE SKIN

EXPOSURE LEVELS (ppm)	EFFECTS OF CHLORINE ON HUMANS
0.2 - 0.4 ppm	ODOR THRESHOLD (VARIES BY INDIVIDUAL)
Less than 0.5 ppm	NO KNOWN ACUTE OR CHRONIC EFFECT
0.5 ppm	ACGIH 8-HOUR TIME WEIGHTED AVERAGE
1.0 ppm	OSHA CEILING LEVEL (PEL) TLV-STEL ERPG - 1
1.0 - 10 ppm	IRRITATION OF THE EYES AND MUCOUS MEMBRANES OF THE UPPER RESPIRATORY TRACT. SEVERITY OF SYMPTOMS DEPENDS ON THE CONCENTRATIONS AND LENGTHS OF EXPOSURE
3 ppm	ERPG-2 (EMERGENCY RESPONSE PLANNING GUIDELINES AS VALUES DEVELOPED BY AIHA) IS THE MAXIMUM AIRBORNE CONCENTRATION BELOW WHICH IT IS BELIEVED THAT NEARLY ALL INDIVIDUALS COULD BE EXPOSED FOR UP TO 1-HOUR WITHOUT EXPERIENCING OR DEVELOPING IRREVERSABLE OR OTHER SERIOUS HEALTH EFFECTS THAT COULD IMPAIR AN INDIVIDUAL'S ABILITY TO TAKE PROTECTIVE ACTION.
10 ppm	NIOSH IDLH (IMMEDIATELY DANGEROUS TO LIFE AND HEALTH)
20 ppm	ERPG-3 IS THE MAXIMUM AIRBORNE CONCENTRATION BELOW WHICH IT IS BELIEVED THAT NEARLY ALL INDIVIDUALS COULD BE EXPOSED FOR UP TO 1-HOUR WITHOUT EXPERIENCING OR DEVELOPING LIFE-THREATENING HEALTH EFFECTS.

EFFECTS OF CHLORINE EXPOSURE IN PARTS PER MILLION

Risks and Benefits of Chlorine

Current evidence indicates that the benefits of chlorinating our drinking water — reduced incidence of water-borne diseases — are much greater than the risks of health effects from THMs.

Although other disinfectants are available, chlorine continues to be the choice of water treatment experts. When used with modern water filtration practices, chlorine is effective against virtually all infective agents — bacteria, viruses, and protozoa. It is easy to apply, and most importantly, small amounts of chlorine remain in the water and continue to disinfect throughout the distribution system. This ensures that the water remains free of microbial contamination on its journey from the treatment plant to the consumer's tap.

A number of cities use ozone to disinfect their source water and to reduce THM formation. Although ozone is a highly effective disinfectant, it breaks down quickly, so that small amounts of chlorine or other disinfectants must be added to the water to ensure continued disinfection as the water is piped to the consumer's tap. Modifying water treatment facilities to use ozone can be expensive, and ozone treatment can create other undesirable by-products that may be harmful to health if they are not controlled (i.e., bromate).

DISINFECTANTS AND DISINFECTION BYPRODUCTS RULE			
DISINFECTION RESIDUAL	MRDLG (mg/L)	MRDL (mg/L)	COMPLIANCE BASED ON:
CHLORINE	4 (as Cl ₂)	4.0 (as Cl ₂)	ANNUAL AVERAGE
CHLORAMINE	4 (as Cl ₂)	4.0 (as Cl ₂)	ANNUAL AVERAGE
CHLORINE DIOXIDE	0.8 (as ClO ₂)	0.8 (as ClO ₂)	ANNUAL AVERAGE
DISINFECTION BYPRODUCTS	MCLG (mg/L)	MCL (mg/L)	COMPLIANCE BASED ON:
TOTAL TRIHALOMETHANES (TTHM)¹	N/A	0.080	ANNUAL AVERAGE
- CHLOROFORM	***		
- BROMODICHLOROMETHANE	0		
- DIBROMOCHLOROMETHANE	0.06		
- BROMOFORM	0		
HALOACETIC ACIDS (five) (HAA5)²	N/A	0.60	ANNUAL AVERAGE
- DICHLOROACETIC ACID	0		
- TRICHLOROACETIC ACID	0.3		
CHLORITE	0.8	1.0	MONTHLY AVERAGE
BROMATE	0	0.010	ANNUAL AVERAGE

DISINFECTION BYPRODUCTS RULE PARAMETERS EXAMPLE



Examples of other disinfectants include chloramines and chlorine dioxide. Chloramines are weaker disinfectants than chlorine, especially against viruses and protozoa; however, they are very persistent and, as such, can be useful for preventing re-growth of microbial pathogens in drinking water distribution systems.

Chlorine dioxide can be an effective disinfectant, but it forms chlorate and chlorite, compounds whose toxicity has not yet been fully determined.

Assessments of the health risks from these and other chlorine-based disinfectants and chlorination by-products are currently under way. In general, the preferred method of controlling chlorination by-products is removal of the naturally occurring organic matter from the source water so it cannot react with the chlorine to form by-products. Removal of the precursors can be by adsorption on activated carbon beds. It is extremely important that water treatment plants ensure the methods used to control chlorination by-products do not compromise the effectiveness of water disinfection.

Chlorine By-Products

Chlorination by-products are the chemicals formed when the chlorine used to kill disease-causing microorganisms reacts with naturally occurring organic matter (i.e., decay products of vegetation) in the water. The most common chlorination by-products found in U.S. drinking water supplies are the trihalomethanes (THMs).

The Principal Trihalomethanes are:

Chloroform, bromodichloromethane, chlorodibromomethane, and bromoform. Other less common chlorination by-products includes the haloacetic acids and haloacetonitriles. The amount of THMs formed in drinking water can be influenced by a number of factors, including the season and the source of the water.

For example, THM concentrations are generally lower in winter than in summer, because concentrations of natural organic matter are lower and less chlorine is required to disinfect at colder temperatures.

THM levels are also low when wells or large lakes are used as the drinking water source, because organic matter concentrations are generally low in these sources. The opposite — high organic matter concentrations and high THM levels — is true when rivers or other surface waters are used as the source of the drinking water.

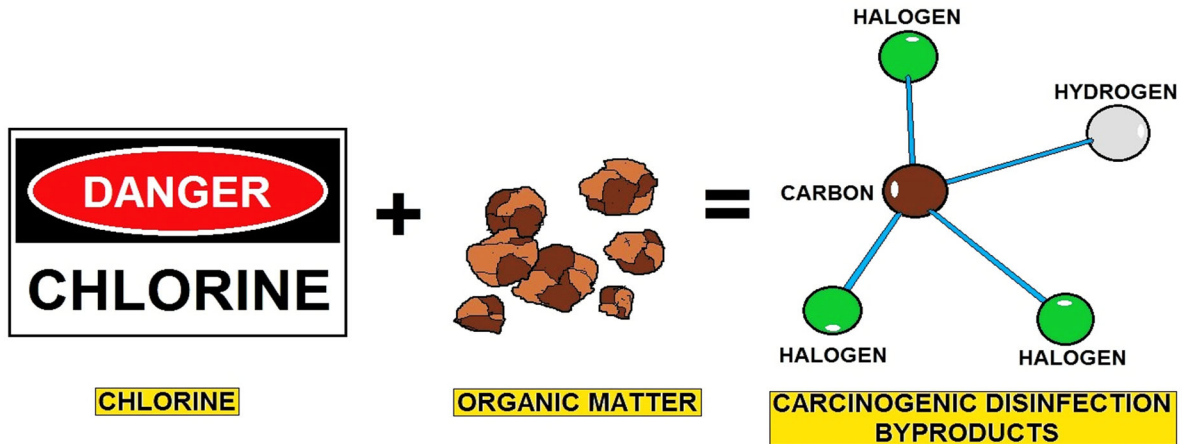

DISINFECTION BYPRODUCT PRODUCTION DIAGRAM

Health Effects

Laboratory animals exposed to very high levels of THMs have shown increased incidences of cancer. In addition, several studies of cancer incidence in human populations have reported associations between long-term exposure to high levels of chlorination by-products and an increased risk of certain types of cancer.

For instance, a recent study conducted in the Great Lakes basin reported an increased risk of bladder and possibly colon cancer in people who drank chlorinated surface water for 35 years or more.

Haloacetic Acids (HAA5)

Haloacetic Acids (HAA5) are a group of chemicals that are formed along with other disinfection byproducts when chlorine or other disinfectants used to control microbial contaminants in drinking water react with naturally occurring organic and inorganic matter in water. The regulated haloacetic acids, known as HAA5, are: monochloroacetic acid, dichloroacetic acid, trichloroacetic acid, monobromoacetic acid, and dibromoacetic acid. EPA has published the Stage 1 Disinfectants/Disinfection Byproducts Rule to regulate HAA5 at 60 parts per billion annual average. This standard became effective for large surface water public water systems in December 2001 and for small surface water and all groundwater public water systems in December 2003.

Bromate is a chemical that is formed when ozone used to disinfect drinking water reacts with naturally occurring bromide found in source water. EPA has established the Stage 1 Disinfectants/Disinfection Byproducts Rule to regulate bromate at annual average of 10 parts per billion in drinking water. This standard became effective for large public water systems by December 2001 and for small surface water and all ground public water systems in December 2003.

Chlorite

Chlorite is a byproduct formed when chlorine dioxide is used to disinfect water. EPA has published the Stage 1 Disinfectants/Disinfection Byproducts Rule to regulate chlorite at a monthly average level of 1 part per million in drinking water. This standard became effective for large surface water public water systems in December 2001 and for small surface water and all groundwater public water systems in December 2003.

Chloroform

Chloroform, typically the most prevalent THM measured in chlorinated water, is probably the most thoroughly studied disinfection byproduct. Toxicological studies have shown that high levels of chloroform can cause cancer in laboratory animals. Extensive research conducted since the early 1990s provides a clearer picture of what this means for humans exposed to far lower levels through drinking water.

One study (Larson et al. 1994a) conducted by the Centers for Health Research (CIIT) observed that a very large dose of chloroform, when given to mice once per day into the stomach (a procedure known as gavage), produced liver damage and eventually cancer. In a second CIIT cancer study (Larson et al., 1994b), mice were given the same daily dose of chloroform through the animals' drinking water.

This time, no cancer was produced. Follow-up research showed that the daily gavage doses overwhelmed the capability of the liver to detoxify the chloroform, causing liver damage, cell death and regenerative cell growth, thereby increasing risks for cell mutation and cancer in exposed organs. When chloroform was given through drinking water, however, the liver could continually detoxify the chloroform as the mice sipped the water throughout the day. Without the initial liver toxicity, there was no cancer in the liver, kidney or other exposed organs (Butterworth et al., 1998).

In its most recent risk assessment, EPA considered the wealth of available information on chloroform, including the important work done at CIIT. EPA concludes that exposure to chloroform below the threshold level that causes cell damage is unlikely to increase the risk of cancer. While chloroform is likely to be carcinogenic at a high enough dose, exposures below a certain dose range are unlikely to pose any cancer risk to humans (US EPA, 2002a). For drinking water meeting EPA standards, chloroform is unlikely to be a health concern.

Sodium Chlorate

Sodium chlorate is a chemical compound with the chemical formula (NaClO_3). When pure, it is a white crystalline powder that is readily soluble in water. It is hygroscopic. It decomposes above $250\text{ }^\circ\text{C}$ to release oxygen and leave sodium chloride. Industrially, sodium chlorate is synthesized from the electrolysis of a hot sodium chloride solution in a mixed electrode tank:

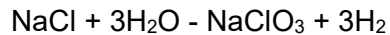

It can also be synthesized by passing chlorine gas into a hot sodium hydroxide solution. It is then purified by crystallization.

Chemical Oxygen Generation

Chemical oxygen generators, such as those in commercial aircraft, provide emergency oxygen to passengers to protect them from drops in cabin pressure by catalytic decomposition of sodium chlorate. The catalyst is normally iron powder.

Barium peroxide (BaO_2) is used to absorb the chlorine which is a minor product in the decomposition. Iron powder is mixed with sodium chlorate and ignited by a charge which is activated by pulling on the emergency mask. The reaction produces more oxygen than is required for combustion. Similarly, the Solidox welding system used pellets of sodium chlorate mixed with combustible fibers to generate oxygen.

Possible relationships between exposure to high levels of THMs and adverse reproductive effects in humans have also been examined recently. In a California study, pregnant women who consumed large amounts of tap water containing elevated levels of THMs were found to have an increased risk of spontaneous abortion.

The available studies on health effects do not provide conclusive proof of a relationship between exposure to THMs and cancer or reproductive effects, but indicate the need for further research to confirm their results and to assess the potential health effects of chlorination by-products other than THMs.

Sodium Hypochlorite Sub-Section

CHEMICAL NAME	CHEMICAL FORMULA	FORM	% CHLORINE	STORAGE	QUALITY	ADVANTAGE	DISADVANTAGE
CHLORINE GAS	Cl ₂	GAS	100%	MAY STORE FOR LONG PERIODS	CONSISTENTLY HIGH QUALITY	COST EFFECTIVE	BY-PRODUCT FORMATIONS (THM'S, HAA)
SODIUM HYPOCHLORITE	NaOCl	LIQUID	~ 12%	LIMITED DUE TO DECOMPOSITION	POOR QUALITY DUE TO LIMITED CONTROL	LESS TRAINING REQUIRED TO HANDLE DUE TO FEWER REGULATIONS	LIMITED SHELF LIFE AND HIGHER COST

CHLORINE GAS VS. SODIUM HYPOCHLORITE (BLEACH)

Physical Properties - Sodium Hypochlorite

Description: Clear greenish yellow liquid.

Warning properties: Chlorine odor; inadequate warning of hazardous concentrations.

Molecular weight: 74.44 daltons

Boiling point (760 mm Hg): Decomposes above 40°C (HSDB 2001)

Freezing point: 6°C (21°F)

Specific gravity: 1.21 (14% NaOCl solution) (water=1)

Water solubility: 29.3 g/100 g at 32°F (0°C)

Flammability: Not flammable

Alternative Names

Bleach; Clorox; Carrel-Dakin solution

Incompatibilities

Calcium or sodium hypochlorite react explosively or form explosive compounds with many common substances such as ammonia, amines, charcoal, or organic sulfides

Introduction

The world's most universal and reliable means of water and wastewater disinfection is chlorination. Two fundamental methods include gas chlorination (Cl₂) and liquid chlorination (NaOCl) otherwise known as Sodium Hypochlorite. Sodium hypochlorite (NaOCl) is a solution made from reacting chlorine with a sodium hydroxide solution. These two reactants are the major co-products from most chlor-alkali cells.

Sodium hypochlorite has a variety of uses and is an excellent disinfectant/antimicrobial agent. Sodium hypochlorite also significantly increases the pH of the water. When sodium hypochlorite is used, it must be counterbalanced by a strong acid like sodium bisulfate or muriatic acid to keep the pH within the ideal range.

The hypochlorite form of chlorine has been used since 1850. The most widely used form of hypochlorite is the liquid, sodium hypochlorite (NaOCl), with more than 150 tons per day consumed in the United States.

Sodium hypochlorite application in cooling water is essentially the same as with gas chlorine; HOCl is produced as the active toxicant. The HOCl is equally susceptible to process contamination, has the same chlorine demand as gas chlorine and displays the same tendency to dissociate.

Sodium hypochlorite differs from chlorine gas in two respects: method of feed and hydrolyzation properties. Sodium hypochlorite can either be gravity-fed or applied with a metering pump. The latter is generally recognized as a consistently more accurate method. The second difference, in hydrolysis, lies in the end products. The NaOCl reaction with water liberates sodium hydroxide (NaOH).

The addition of NaOH differs in that it tends to add alkalinity to the water. In large concentrations it may artificially elevate pH, leading to precipitation of calcium carbonate. While NaOCl eliminates low pH corrosion as a concern, the use of large quantities in contaminated systems still introduces a high concentration of the chloride ion, which can be very aggressive to cooling system metals. Many of the other problems associated with chlorine remain present with sodium hypochlorite.

When was Sodium Hypochlorite Discovered?

Sodium hypochlorite has a long history. Around 1785 the Frenchman Berthollet developed liquid bleaching agents based on sodium hypochlorite. The Javel company introduced this product and called it 'liqueur de Javel'. At first, it was used to bleach cotton. Because of its specific characteristics it soon became a popular compound. Hypochlorite can remove stains from clothes at room temperature. In France, sodium hypochlorite is still known as 'eau de Javel'.

Characteristics of Sodium hypochlorite

Sodium hypochlorite is a clear, slightly yellowish solution with a characteristic odor.

Sodium hypochlorite has a relative density of is 1.1 (5.5% watery solution).

As a bleaching agent for domestic use it usually contains 5% sodium hypochlorite (with a pH of around 11, it is irritating). If it is more concentrated, it contains a concentration 10-15% sodium hypochlorite (with a pH of around 13, it burns and is corrosive).

Sodium hypochlorite is unstable. Chlorine evaporates at a rate of 0,75 gram active chlorine per day from the solution. Then heated sodium hypochlorite disintegrates. This also happens when sodium hypochlorite comes in contact with acids, sunlight, certain metals and poisonous and corrosive gasses, including chlorine gas. Sodium hypochlorite is a strong oxidator and reacts with flammable compounds and reductors. Sodium hypochlorite solution is a weak base that is inflammable. These characteristics must be kept in mind during transport, storage and use of sodium hypochlorite.

pH value When Sodium Hypochlorite is Added to Water

Due to the presence of caustic soda in sodium hypochlorite, the pH of the water is increased. When sodium hypochlorite dissolves in water, two substances form, which play a role in oxidation and disinfection. These are hypochlorous acid (HOCl) and the less active hypochlorite ion (OCl⁻). The pH of the water determines how much hypochlorous acid is formed. While sodium hypochlorite is used, hydrochloric (HCl) is used to lower the pH. Sulfuric acid (H₂SO₄) can be used as an alternative for acetic acid. Less harmful gasses are produced when sulfuric acid is used. Sulfuric acid is a strong acid that strongly reacts with bases and is very corrosive.

How Can Sodium Hypochlorite be produced?

Sodium hypochlorite can be produced in two ways:

- By dissolving salt in softened water, which results in a concentrated brine solution. The solution is electrolyzed and forms a sodium hypochlorite solution in water. This solution contains 150 g active chlorine (Cl₂) per liter. During this reaction the explosive hydrogen gas is also formed.
- By adding chlorine gas (Cl₂) to caustic soda (NaOH). When this is done, sodium hypochlorite, water (H₂O) and salt (NaCl) are produced according to the following reaction:

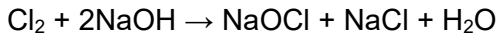

Applications of Sodium Hypochlorite

Sodium hypochlorite is used on a large scale; for example agriculture, chemical industries, paint- and lime industries, food industries, glass industries, paper industries, pharmaceutical industries, synthetics industries and waste disposal industries all use it. In the textile industry sodium hypochlorite is used to bleach textile. It is sometimes added to industrial waste water--this is done to reduce odors.

Hypochlorite neutralizes sulfur hydrogen gas (SH) and ammonia (NH₃). It is also used to detoxify cyanide baths in metal industries. Hypochlorite can be used to prevent algae and shellfish growth in cooling towers. In water treatment, hypochlorite is used to disinfect water. In households, hypochlorite is used frequently for the purification and disinfection of the house.

How does Sodium Hypochlorite Disinfection Work?

By adding hypochlorite to water, hypochlorous acid (HOCl) is formed:

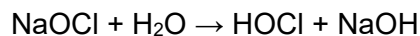

Hypochlorous acid is divided into hydrochloric acid (HCl) and oxygen (O). The oxygen atom is a very strong oxidant.

Sodium hypochlorite is effective against bacteria, viruses and fungi. Sodium hypochlorite disinfects the same way as chlorine does.

There are various ways to use sodium hypochlorite. For on-site salt electrolysis, a solution of salt (NaCl) in water is applied. Sodium (Na⁺) and chloride (Cl⁻) ions are produced.



Subsequently, chlorine and hydroxide react to form hypochlorite:

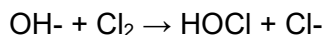

Salt Electrolysis System

The advantage of the salt electrolysis system is that no transport or storage of sodium hypochlorite is required. When sodium hypochlorite is stored for a long time, it becomes inactive. Another advantage of the onsite process is that chlorine lowers the pH and no other acid is required to lower pH.

The hydrogen gas that is produced is explosive and as a result ventilation is required for explosion prevention. This system is slow and a buffer of extra hypochlorous acid needs to be used. The maintenance and purchase of the electrolysis system is much more expensive than sodium hypochlorite.

When sodium hypochlorite is used, acetic or sulfuric acid are added to the water. An overdose can produce poisonous gasses. If the dosage is too low, the pH becomes too high and can irritate the eyes.

Because sodium hypochlorite is used both to oxidize pollutants (urine, sweat, cosmetics) and to remove pathogenic microorganisms, the required concentration of sodium hypochlorite depends on the concentrations of these pollutants. Especially the amount of organic pollutants helps determine the required concentration. If the water is filtered before sodium hypochlorite is applied, less sodium hypochlorite is needed.

Theory

Disinfection with chlorine is very popular in water and wastewater treatment because of its low cost, ability to form a residual, and its effectiveness at low concentrations. Although it is used as a disinfectant, it is a dangerous and potentially fatal chemical if used improperly.

Despite the fact the disinfection process may seem simple, it is actually a quite complicated process. Chlorination in wastewater treatment systems is a fairly complex science which requires knowledge of the plant's effluent characteristics.

When free chlorine is added to the water, it takes on various forms depending on the pH of the wastewater. It is important to understand the forms of chlorine which are present because each has a different disinfecting capability. The acid form, HOCl, is a much stronger disinfectant than the hypochlorite ion, OCl⁻.

Ammonia present in the effluent can also cause problems as chloramines are formed, which have very little disinfecting power. Some methods to overcome the types of chlorine formed are to adjust the pH of the water prior to chlorination or to simply add a larger amount of chlorine. An adjustment in the pH would allow the operators to form the most desired form of chlorine, hypochlorous acid, which has the greatest disinfecting power.

Adding larger amounts of chlorine would be an excellent method to combat the chloramines because the ammonia present would bond to the chlorine but further addition of chlorine would stay in the hypochlorous acid or hypochlorite ion state.

a) Chlorine gas, when exposed to water reacts readily to form hypochlorous acid, HOCl, and hydrochloric acid. $\text{Cl}_2 + \text{H}_2\text{O} \rightarrow \text{HOCl} + \text{HCl}$

b) If the pH of the water is greater than 8, the hypochlorous acid will dissociate to yield hypochlorite ion. $\text{HOCl} \leftrightarrow \text{H}^+ + \text{OCl}^-$ If however, the pH is much less than 7, and then HOCl will not dissociate.

c) If ammonia is present in the wastewater effluent, then the hypochlorous acid will react to form one three types of chloramines depending on the pH, temperature, and reaction time.

Sodium Hypochlorite Solutions

Recommendations for Preparing/Handling/Feeding

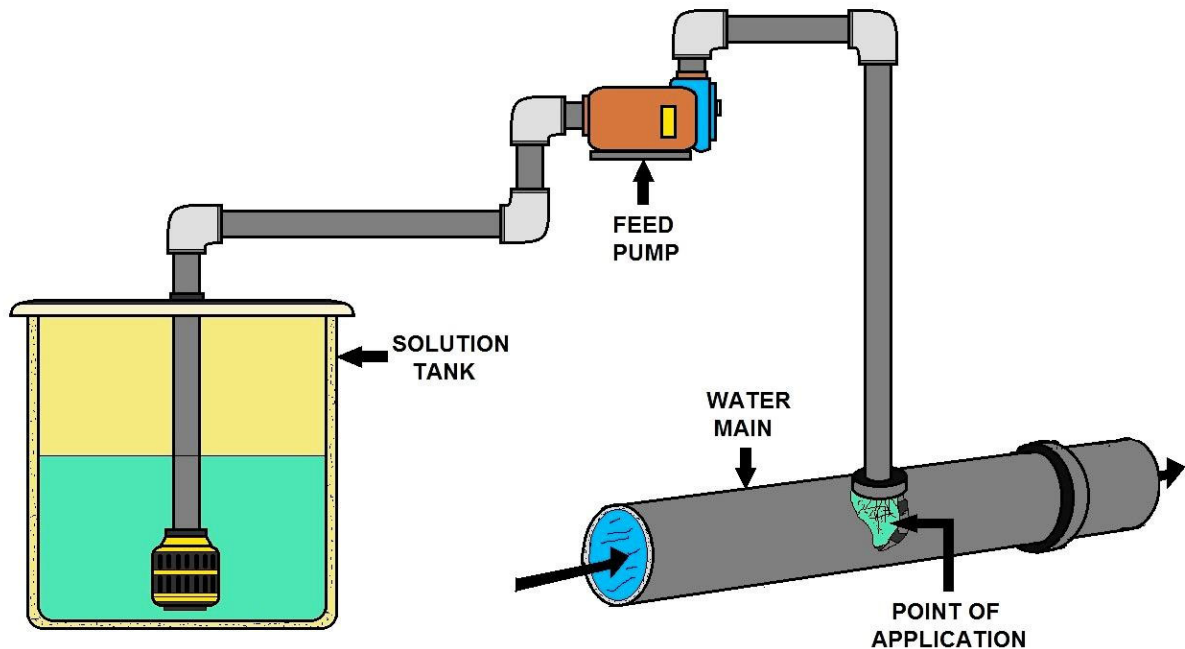

SODIUM HYPOCHLORITE FEEDING

As a result of the pressures brought to bear by Health and Safety requirements, some users of gas have chosen to seek alternative forms of disinfectants for their water and wastewater treatment plants. One of these alternative forms is sodium hypochlorite (**NaOCl**). This is often purchased commercially at 10 to 15% strength.

The handling and storage of NaOCl presents the plant with a new and sometimes unfamiliar, set of equipment installation configurations and operating conditions.

Product Stability The oxidizing nature of this substance means that it should be handled with extreme care. As NaOCl is relatively unstable, it degrades over time.

There are Three Ways in Which NaOCl Solutions Degrade

- Chlorate-forming reaction due to age, temperature, light and minor reduction in pH.
- Oxygen-producing reaction that occurs when metals, such as iron, copper or nickel, or metal oxides are brought into contact with the solution.
- Chlorine-producing reaction when solution pH falls below 6.

There are Many Factors that Affect the Stability of a NaOCl Solution

- Initial solution strength.
- pH solution.
- Temperature of the solution.
- Exposure of the solution to sunlight.

Exposure

There is no threshold value for sodium hypochlorite exposure. Various health effects occur after exposure to sodium hypochlorite. People are exposed to sodium hypochlorite by inhalation of aerosols. This causes coughing and a sore throat. After swallowing sodium hypochlorite the effects are stomach ache, a burning sensation, coughing, diarrhea, a sore throat and vomiting. Sodium hypochlorite on skin or eyes causes redness and pain. After prolonged exposure, the skin can become sensitive. Sodium hypochlorite is poisonous for water organisms. It is mutagenic and very toxic when it comes in contact with ammonium salts.

Routes of Exposure

Inhalation

Hypochlorite solutions can liberate toxic gases such as chlorine. Chlorine's odor or irritant properties generally provide adequate warning of hazardous concentrations. However, prolonged, low-level exposures, such as those that occur in the workplace, can lead to olfactory fatigue and tolerance of chlorine's irritant effects.

Chlorine is heavier than air and may cause asphyxiation in poorly ventilated, enclosed, or low-lying areas. Children exposed to the same levels of gases as adults may receive a larger dose because they have greater lung surface area/body weight ratios and higher minute volumes/weight ratios. Children may be more vulnerable to corrosive agents than adults because of the smaller diameter of their airways. In addition, they may be exposed to higher levels than adults in the same location because of their short stature and the higher levels of chlorine found nearer to the ground.

Skin/Eye Contact

Direct contact with hypochlorite solutions, powder, or concentrated vapor causes severe chemical burns, leading to cell death and ulceration. Because of their relatively larger surface area/weight ratio, children are more vulnerable to toxicants affecting the skin.

Ingestion

Ingestion of hypochlorite solutions causes vomiting and corrosive injury to the gastrointestinal tract. Household bleaches (3 to 6% sodium hypochlorite) usually cause esophageal irritation, but rarely cause strictures or serious injury such as perforation. Commercial bleaches may contain higher concentrations of sodium hypochlorite and are more likely to cause serious injury. Metabolic acidosis is rare, but has been reported following the ingestion of household bleach. Pulmonary complications resulting from aspiration may also be seen after ingestion.

Sources/Uses

Sodium and calcium hypochlorite are manufactured by the chlorination of sodium hydroxide or lime. Sodium and calcium hypochlorite are used primarily as oxidizing and bleaching agents or disinfectants. They are components of commercial bleaches, cleaning solutions, and disinfectants for drinking water and waste water purification systems and swimming pools.

Sodium Hypochlorite as a Disinfectant has the Following Advantages:

It can be easily stored and transported when it is produced on-site. Dosage is simple; transport and storage of sodium hypochlorite are safe. Sodium hypochlorite is as effective as chlorine gas for disinfection. Sodium hypochlorite produces residual disinfectant.

Disadvantages

Sodium hypochlorite is a dangerous and corrosive substance. While working with sodium hypochlorite, safety measures have to be taken to protect workers and the environment. Sodium hypochlorite should not come in contact with air, because that will cause it to disintegrate. Both sodium hypochlorite and chlorine do not deactivate *Giardia Lambia* and *Cryptosporidium*. The regulation for sodium hypochlorite is the same as the regulation considering chlorine. Household bleaches usually contain sodium hypochlorite in a 3% to 6% solution. Some sodium hydroxide (lye) is added to keep the pH high to avoid decomposition. If the solution is made more acidic, sodium hypochlorite will dissociate, producing chlorine gas and oxygen. It is made by bubbling chlorine gas through a solution of sodium hydroxide. In the environment, it breaks down into water, oxygen, and table salt.

Conditions that tend to increase gassing in Sodium Hypochlorite Solutions are:

- * Elevated temperatures
- * High concentration solution
- * Exposure to sunlight or UV rays
- * Reduction in pressure
- * Cavitation
- * Poor piping conditions
- * Contact with metallic impurities
- * Contact with organic impurities
- * Age of solution
- * Quality of solution

Reciprocating Piston Metering Pumps

When handling sodium hypochlorite and acids, be certain to wear gloves and a face shield for protection. Sodium hypochlorite is introduced to treated water by a chemical feeder (pump.) Chemical feeders tend to clog often, so it's important to clean the feeder regularly. Sodium Hypochlorite is subject to degradation within the piping and pump systems as it releases oxygen gas and results in crystallization of the residual. If the oxygen gas or vapor is allowed to build up within the piping and reagent head in sufficient volume, a typical reciprocating piston metering pump, used for accurately feeding chlorine to the process, will not function properly as gas in the pump head is compressed, minimizing the discharge check valve to open upon discharge stroke of the pump.

Consequently, this effect could require that the pump be re-primed for operation. Reciprocating piston metering pumps or diaphragm metering pumps have been historically preferred in the dispensing of Sodium Hypochlorite because of their superior ability to accurately dose chemicals into a process stream with great precision and repeatability at a constant pressure. Additionally, the diaphragm metering pump is seal-less and leak proof by design with negligible maintenance and simple commissioning.

Traditionally, the diaphragm metering pump industry has promoted the use of degas valves on the discharge port of the pump which diverts gas back to the suction supply source of the bleach. This method has been widely accepted and successful in many applications. However, the small diameter ports in the valve system tend to plug and require continuous flushing or cleaning through human intervention since the system is open to atmosphere on the discharge side of the orifice. Additionally, an external bypass piping system and degas valve assembly require additional costs and maintenance while presenting more opportunities for undesired chlorine leak paths.

Calcium Hypochlorite Sub-Section (CaCl₂O₂)



Physical Properties - Calcium Hypochlorite

Description: White powder, pellets or flat plates

Warning properties: Chlorine odor; inadequate warning of hazardous concentrations

Molecular weight: 142.98 daltons

Boiling point (760 mm Hg): Decomposes at 100°C (HSDB 2001)

Freezing point: Not applicable

Specific gravity: 2.35 (water = 1)

Water solubility: 21.4% at 76°F (25°C)

Flammability: Not flammable

Calcium Hypochlorite: Powder and Tablets

There are two forms of calcium hypochlorite: powder and tablets. Tablets range in size from 5 mg about the size of an Aspirin to 3-inch tablets. Synonyms of calcium hypochlorite include Losantin, hypochlorous acid, calcium salt, BK powder, Hy-Chlor, chlorinated lime, lime chloride, chloride of lime, calcium oxychloride, HTH, mildew remover X-14, perchloron, and pittchlor.

Calcium hypochlorite is generally available as a white powder, pellets, or flat plates; sodium hypochlorite is usually a greenish yellow, aqueous solution. Although not flammable, they may react explosively.

Calcium hypochlorite decomposes in water to release chlorine and oxygen; sodium hypochlorite solutions can react with acids or ammonia to release chlorine or chloramine. Odor may not provide an adequate warning of hazardous concentrations.

Toxic

Both hypochlorites are toxic by the oral and dermal routes and can react to release chlorine or chloramine which can be inhaled. The toxic effects of sodium and calcium hypochlorite are primarily due to the corrosive properties of the hypochlorite moiety. Systemic toxicity is rare, but metabolic acidosis may occur after ingestion.

Description

Solid chlorine stands alone as the safest form of chlorine disinfection. Requiring only minimal safety equipment for handling, users can breathe easy knowing our tablets are safe for both people and the environment. The elimination of costly scrubbers, containment, or hazard response capability, guarantees lower initial costs and reduced operating expense. Calcium hypochlorite is generally available as a white powder, pellets, or flat plates. It decomposes readily in water or when heated, releasing oxygen and chlorine. It has a strong chlorine odor, but odor may not provide an adequate warning of hazardous concentrations. Calcium hypochlorite is not flammable, but it acts as an oxidizer with combustible material and may react explosively with ammonia, amines, or organic sulfides. Calcium hypochlorite should be stored in a dry, well-ventilated area at a temperature below 120°F (50°C) separated from acids, ammonia, amines, and other chlorinating or oxidizing agents.

Chlorine Tablet Feeder

These feed systems are low maintenance and an extremely effective means to treat water or wastewater. Dry tablet feeder may or may not have mechanical components and most require no electricity. The dry tablet feeding system is a good alternative to liquid bleach and potential gas hazards. With no chlorine gas cylinders to handle, chlorine releases are non-existent. Process safety Management and Risk Management Program compliance worries disappear.

Chlorine Tablet Feeder Capacities: range - 1,500 to 200,000 (GPD)

Chlorine tablets are stable for 3 years or more.

If a tablet produces 1000 PPM in a liter of water when first off the press, the tablet will produce 1000 PPM plus. This guarantees the activity will be at least 100% 3 years later and probably for much longer than that. In fact, tablets have been stored for 6 years at 6% C and 42% C and still contained the specified levels of available chlorine.

Sodium hypochlorite liquid, on the other hand, is inherently unstable and degrades with age until all the active strength disappears. This degradation accelerates in conditions of high temperature or strong sunlight.





These two different tablet chlorinator feeding systems are installed as a sidestream (see the clear plastic line) to the mainstream water flow or directly in the well casing. Using a flow meter or timed device, a chlorine tablet is dropped or delivered inside the well casing or to another location in the distribution system. Sometimes, the chlorinated balance is piped to an integrated solution tank. Then the resulting concentrated chlorine solution is pumped into a pressurized line or holding tank. By mixing chlorinated water from the solution tank with unchlorinated water from the main stream, a controllable level of available chlorine is achieved.



Accuracy

Because of their stability, chlorine tablets are an accurate dose, always yielding the stated level of available chlorine in water or very slightly over, never under. Liquid chlorine strengths vary so widely and are mostly unknown (the container usually says "less than 5%") that it is impossible to make up accurate in-use solutions without access to laboratory equipment.

Storage and Distribution

In recent years, concern regarding the safety hazards associated with liquid chlorine has grown to such an extent that several major cities now restrict transportation of chlorine within their boundaries. Tablets, on the other hand, are easy and convenient to store and transport. One pallet containing 600 jars each of 200 tablets is equivalent to 120,000 x 1 liter in use bleach solutions of 1,000 PPM active chlorine concentration.

Liquid chlorine is bulky, heavy and prone to leakage and spillage. Chlorine tablets are compact, economical and safe to ship and can even be sent by airfreight.

Effectiveness

Both chlorine tablets and liquid Sodium hypochlorite produce Hypochlorous Acid (HOCl) and Hypochlorite ion (OCl⁻) in solution. It has been postulated by Ortenzio and Stuart in 1959 and again by Trueman in 1971 that Hypochlorous Acid is the predominantly active species whilst Hypochlorite ion has little activity due to its negative charge impeding penetration of the cell wall and membrane. The ratio of Hypochlorous Acid to Hypochlorite ion increases with acidity. Chlorine tablets have a pH of 6.7 and liquid hypochlorite a pH of between 9 and 12. Ergo; tablets have a greater disinfection capacity and are less prone to inactivation due to soiling.

Safety

Chlorine tablets in dry form will not leak or splash and do not damage clothing. Liquid chlorine can affect eyes, skin and mucous membranes; it is easily splashed and rots clothing.

Corrosion

Chlorine tablets are much less corrosive than liquid chlorine, which is highly corrosive to most metals

Comparison

The final very important comparison to be made between Sodium hypochlorite (NaOCl) and Sodium dichloroisocyanurate (NaDCC) is their neutralization by organic matter. They are both prone to this but by using horse serum, it has been shown (Coates 1988) that the degree of neutralization is directly proportional to the concentration of serum present.

However, the degree of neutralization of NaOCl disinfectant is much greater than that of NaDCC disinfectant and the disparity increases with the concentration of serum. Hence, where there is a high concentration of organic material present, NaDCC will be very much more effective than NaOCl.

The degree of inactivation of NaOCl and NaDCC solutions by different concentrations of horse serum demonstrates that NaDCC solutions are less prone to inactivation by serum than are NaOCl solutions. For example, in 30% serum it required only 4000 PPM av. Cl of NaDCC as opposed to 17000 PPM av Cl of NaOCl to exhibit similar bactericidal activity.

Chlorine Facts Review

This information is necessary to pass your post-quiz.

* OSHA PEL 1 PPM - IDLH 10 PPM and Fatal Exposure Limit 1,000 PPM

The current Occupational Safety and Health Administration (**OSHA**) permissible exposure limit (**PEL**) for chlorine is 1 ppm (3 milligrams per cubic meter ($\text{mg}/\text{m}^{(3)}$)) as a ceiling limit. A worker's exposure to chlorine shall at no time exceed this ceiling level. * **IDLH 10 PPM**

Physical and chemical properties of chlorine: A yellowish green, nonflammable and liquefied gas with an unpleasant and irritating smell. Can be readily compressed into a clear, amber-colored liquid, it is a noncombustible gas, and a strong oxidizer.

Liquid chlorine is about 1.5 times heavier than water and gaseous chlorine is about 2.5 times heavier than air. Atomic number of chlorine is 17. Cl is the elemental symbol and Cl_2 is the chemical formula.

Monochloramine, dichloramine, and trichloramine are also known as Combined Available Chlorine. $\text{Cl}_2 + \text{NH}_4$.

HOCl and OCl^- ; The **OCL-** is the hypochlorite ion and both of these species are known as free available chlorine. These are the two main chemical species formed by chlorine in water and they are known collectively as hypochlorous acid and the hypochlorite ion.

When chlorine gas is added to water, it rapidly hydrolyzes. The chemical equation that best describes this reaction is $\text{Cl}_2 + \text{H}_2\text{O} \rightarrow \text{H}^+ + \text{Cl}^- + \text{HOCl}$. Hypochlorous acid is the most germicidal of the chlorine compounds with the possible exception of chlorine dioxide.

Yoke-type connectors should be used on a chlorine cylinder's valve, as a safer connection in case the threads on the valve may be worn.

The connection from a chlorine cylinder to a chlorinator should be made by using a new, approved gasket on the connector every time. Always follow your manufacturer's instructions.

On 1-ton chlorine gas containers, the chlorine pressure reducing valve should be located downstream of the evaporator when using an evaporator. This is the liquid chlorine supply line and it is going to be made into chlorine gas.

In water treatment, chlorine is added to the effluent before the contact chamber (before the clear well) for complete mixing. One reason for not adding it directly to the chamber is that the chamber has very little mixing due to low velocities.

Here are several safety precautions when using chlorine gas. In addition to protective clothing and goggles, chlorine gas should be used only in a well-ventilated area so that any leaking gas cannot concentrate.

Emergency procedures in the case of a large uncontrolled chlorine leak are as follows: Notify local emergency response team, warn and evacuate people in adjacent areas, and be sure that no one enters the leak area without adequate self-contained breathing equipment.

Here are several symptoms of chlorine exposure. Burning of eyes, nose, and mouth, coughing, sneezing, choking, nausea and vomiting, headaches and dizziness, fatal pulmonary edema, pneumonia, skin blisters and a little Cl_2 will corrode the teeth and then progress to throat cancer.

Approved method for storing a 150 - 200-pound chlorine cylinder: Secure each cylinder in an upright position, attach the protective bonnet over the valve and firmly secure each cylinder. Never store near heat. Always store the empty in an upright, secure position with proper signage.

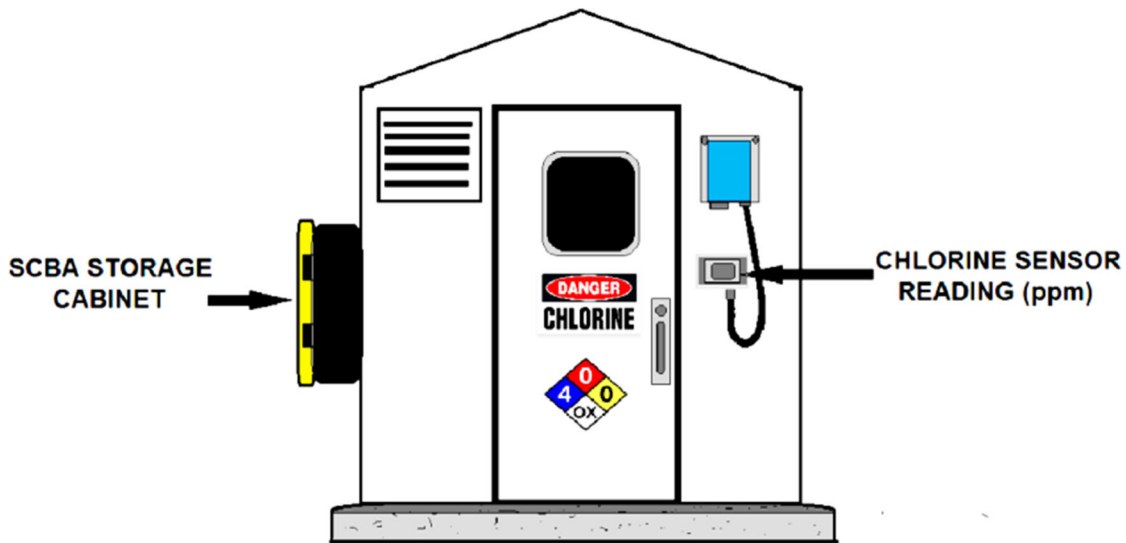

FIBERGLASS CHLORINE STORAGE SHELTER

Operator and Public Safety

The design of gas chlorine facilities should consider operator and public safety as well as maintaining long-term plant reliability and operation.

Chlorination facilities are designed such that chlorine gas can be contained in the chlorine storage room. Doors and windows should be gas-tight to minimize escape of gaseous chlorine to the exterior atmosphere or building interior.

Leak detectors should be located 1 foot above the floor of the chlorine storage room and should activate an alarm when a chlorine leak occurs. It is preferable that the detector be capable of differentiating between two or more chlorine concentrations to alert personnel of the severity of the release. This would help determine the appropriate procedure for entrance to the room, ventilation, or other solutions.

Self-contained breathing apparatus (SCBA) should not be located within the chlorine storage room. It is preferable that this equipment be located in a convenient location where personnel can easily access it in the event of an emergency.

Chlorine Health Hazard Sub-Section

- ◆ CHLORINE IS EXTREMELY IRRITATING AND CAN BURN THE EYES AND SKIN
- ◆ IF INHALED, CHLORINE CAUSES RESPIRATORY DISTRESS, AND POSSIBLY BE FATAL
- ◆ LIQUID CHLORINE RELEASE FORMS AN IMMEDIATE CLOUD (FLASH VAPOR) AND COOLS TO -29°F
- ◆ EXPOSURE TO CHLORINE LIQUID CAN CAUSE SEVERE FROSTBITE, AS WELL AS CHEMICAL BURNS.

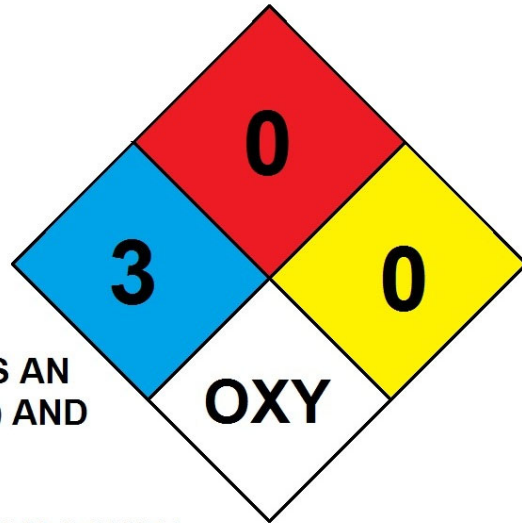

THE HEALTH EFFECTS OF CHLORINE EXPOSURE

Signs and Symptoms of Exposure

1. Acute exposure: Acute exposure to low levels of chlorine results in eye, nose, and throat irritation, sneezing, excessive salivation, general excitement, and restlessness. Higher concentrations causes difficulty in breathing, violent coughing, nausea, vomiting, cyanosis, dizziness, headache, choking, laryngeal edema, acute tracheobronchitis, chemical pneumonia. Contact with the liquid can result in frostbite burns of the skin and eyes [Genium 1992].
2. Chronic exposure: Chronic exposure to low levels of chlorine gas can result in a dermatitis known as chloracne, tooth enamel corrosion, coughing, severe chest pain, sore throat, hemoptysis and increased susceptibility to tuberculosis [Genium 1992].

Inhalation

Immediately remove the exposed person upwind from the contaminated area and contact the poison control center. Inhalation can cause coughing, sneezing, shortness of breath, sensation of tightness in the chest, as well as severe restlessness or anxiety, nausea, and vomiting. The nose and throat may become irritated; a stinging and burning sensation may be experienced. Immediate fatalities can occur as a result of suffocation. Delayed fatalities can occur as a result of pulmonary edema (fluid in the lungs). For this reason, rest and immediate attention after inhalation is important.

Persons with known cardiovascular or lung problems should not risk chlorine exposure. If breathing has stopped, give artificial respiration; if breathing is difficult, give oxygen if equipment and trained personnel are available. If exposed person is breathing, place in a comfortable position and keep person warm and at rest until medical assistance becomes available.

Eye/Skin Contact

Liquid and concentrated gas could produce severe burns and injury on contact.

Eye

Pour a gentle stream of warm water through the affected eye for at least 15 minutes. Contact the poison control center, emergency room or physician right away as further treatment will be necessary.

Skin

Run a gentle stream of water over the affected area for 15 minutes. A mild soap may be used if available. Contact the poison control center, emergency room or physician right away as further treatment will be necessary.

Chronic

Repeated exposures can result in a loss of ability to detect the odor of chlorine. Long term exposures may cause damage to teeth and inflammation or ulceration of the nasal passages.

Ingestion

Not applicable for gas. Liquid could produce severe burns and injury on contact.

Pre-hospital Management

* Rescue personnel are at low risk of secondary contamination from victims who have been exposed only to gases released from hypochlorite solutions. However, clothing or skin soaked with industrial-strength bleach or similar solutions may be corrosive to rescuers and may release harmful gases.

* Ingestion of hypochlorite solutions may cause pain in the mouth or throat, dysphagia, stridor, drooling, odynophagia, and vomiting. Hypochlorite irritates the skin and can cause burning pain, inflammation, and blisters. Acute exposure to gases released from hypochlorite solutions can cause coughing, eye and nose irritation, lacrimation, and a burning sensation in the chest. Airway constriction and noncardiogenic pulmonary edema may also occur.

* There is no specific antidote for hypochlorite poisoning. Treatment is supportive.

Hot Zone

Rescuers should be trained and appropriately attired before entering the Hot Zone. If the proper equipment is not available, or if rescuers have not been trained in its use, assistance should be obtained from a local or regional HAZMAT team or other properly equipped response organization.

Rescuer Protection

Hypochlorite is irritating to the skin and eyes and in some cases may release toxic gases.

Respiratory Protection

Positive-pressure, self-contained breathing apparatus (SCBA) is recommended in response to situations that involve exposure to potentially unsafe levels of chlorine gas.

Skin Protection: Chemical-protective clothing should be worn due to the risk of skin irritation and burns from direct contact with solid hypochlorite or concentrated solutions.

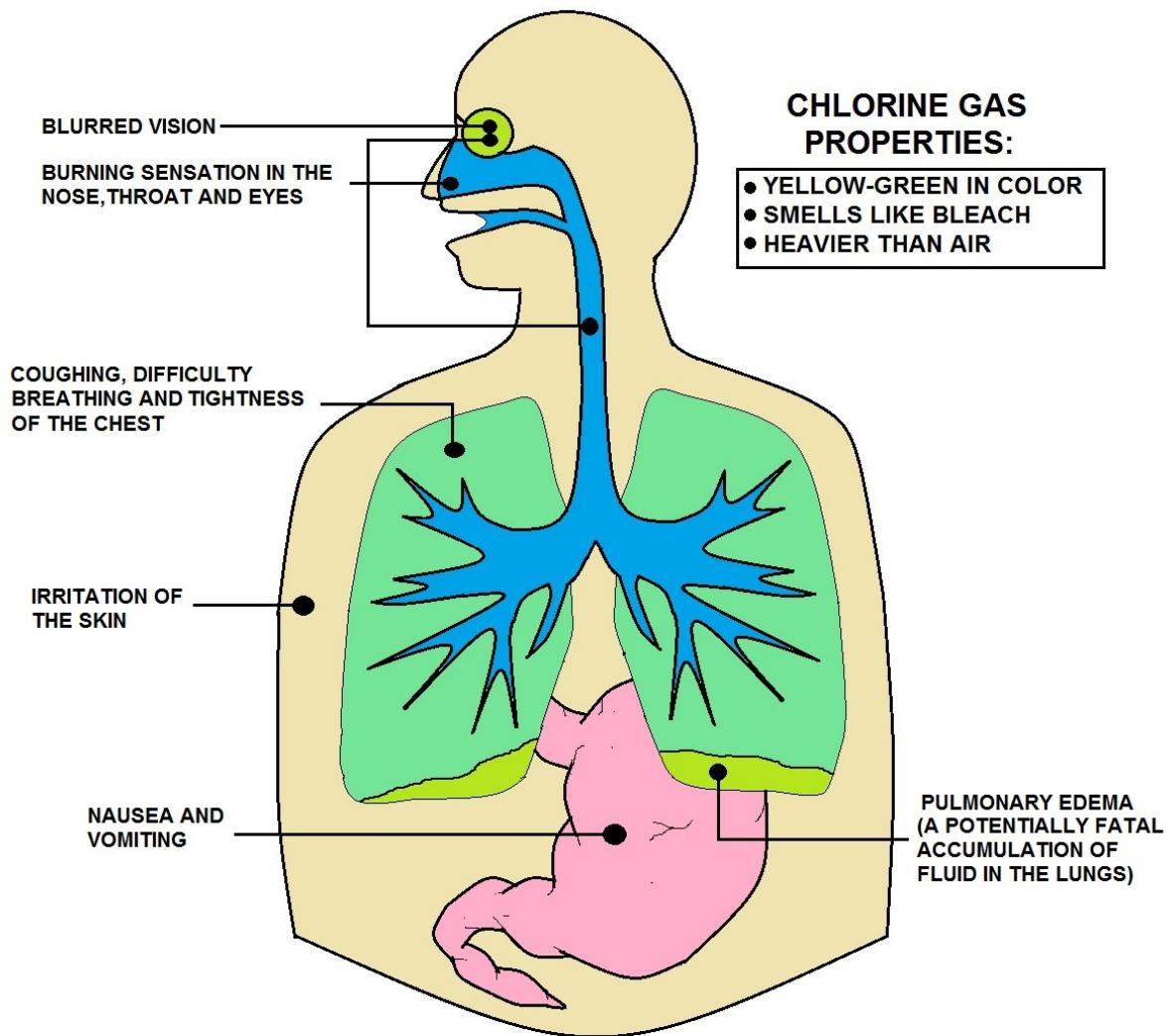

HEALTH RISKS OF CHLORINE GAS

ABC Reminders

Quickly establish a patient airway, ensure adequate respiration and pulse. If trauma is suspected, maintain cervical immobilization manually and apply a cervical collar and a backboard when feasible.

Victim Removal

If victims can walk, lead them out of the Hot Zone to the Decontamination Zone. Victims who are unable to walk may be removed on backboards or gurneys; if these are not available, carefully carry or drag victims to safety.

Consider appropriate management in victims with chemically-induced acute disorders, especially children who may suffer separation anxiety if separated from a parent or other adult.

Decontamination Zone

Victims exposed only to chlorine gas released by hypochlorite who have no skin or eye irritation do not need decontamination. They may be transferred immediately to the Support Zone. All others require decontamination as described below.

Rescuer Protection

If exposure levels are determined to be safe, decontamination may be conducted by personnel wearing a lower level of protection than that worn in the Hot Zone (described above).

ABC Reminders

Quickly establish a patient airway, ensure adequate respiration and pulse. Stabilize the cervical spine with a collar and a backboard if trauma is suspected. Administer supplemental oxygen as required. Assist ventilation with a bag-valve-mask device if necessary.

Basic Decontamination

Rapid decontamination is critical. Victims who are able may assist with their own decontamination. Remove and double-bag contaminated clothing and personal belongings. Flush exposed skin and hair with copious amounts of plain tepid water. Use caution to avoid hypothermia when decontaminating victims, particularly children or the elderly. Use blankets or warmers after decontamination as needed.

Irrigate exposed or irritated eyes with saline, Ringer's lactate, or D5W for at least 20 minutes. Eye irrigation may be carried out simultaneously with other basic care and transport. Remove contact lenses if it can be done without additional trauma to the eye. If a corrosive material is suspected or if pain or injury is evident, continue irrigation while transferring the victim to the support zone.

In Cases of Ingestion, Do Not Induce Emesis or Offer Activated Charcoal.

Victims who are conscious and able to swallow should be given 4 to 8 ounces of water or milk; if the victim is symptomatic, delay decontamination until other emergency measures have been instituted. Dilutants are contraindicated in the presence of shock, upper airway obstruction, or in the presence of perforation.

Consider appropriate management of chemically contaminated children at the exposure site. Provide reassurance to the child during decontamination, especially if separation from a parent occurs.

Transfer to Support Zone

As soon as basic decontamination is complete, move the victim to the Support Zone.

Support Zone

Be certain that victims have been decontaminated properly (see Decontamination Zone above). Victims who have undergone decontamination or have been exposed only to vapor pose no serious risks of secondary contamination to rescuers. In such cases, Support Zone personnel require no specialized protective gear.

ABC Reminders

Quickly establish a patient airway, ensure adequate respiration and pulse. If trauma is suspected, maintain cervical immobilization manually and apply a cervical collar and a backboard when feasible. Administer supplemental oxygen as required and establish intravenous access if necessary. Place on a cardiac monitor, if available.

Additional Decontamination

1. Continue irrigating exposed skin and eyes, as appropriate.
2. In cases of ingestion, do not induce emesis or offer activated charcoal.
3. Victims who are conscious and able to swallow should be given 4 to 8 ounces of water or milk; if the victim is symptomatic, delay decontamination until other emergency measures have been instituted. Dilutants are contraindicated in the presence of shock, upper airway obstruction, or in the presence of perforation.

Advanced Treatment

In cases of respiratory compromise, secure airway and respiration via endotracheal intubation. Avoid blind nasotracheal intubation or use of an esophageal obturator: only use direct visualization to intubate. When the patient's condition precludes endotracheal intubation, perform cricothyrotomy if equipped and trained to do so.

Treat patients who have bronchospasm with an aerosolized bronchodilator such as albuterol. Consider racemic epinephrine aerosol for children who develop stridor. Dose 0.25-0.75 mL of 2.25% racemic epinephrine solution in water, repeat every 20 minutes as needed cautioning for myocardial variability.

Patients who are comatose, hypotensive, or having seizures or who have cardiac arrhythmias should be treated according to advanced life support (ALS) protocols.

Transport to Medical Facility

Only decontaminated patients or those not requiring decontamination should be transported to a medical facility. "Body bags" are not recommended. Report to the base station and the receiving medical facility the condition of the patient, treatment given, and estimated time of arrival at the medical facility. If a chemical has been ingested, prepare the ambulance in case the victim vomits toxic material. Have ready several towels and open plastic bags to quickly clean up and isolate vomitus.

Multi-Casualty Triage

Consult with the base station physician or the regional poison control center for advice regarding triage of multiple victims. Patients who have ingested hypochlorite, or who show evidence of significant exposure to hypochlorite or chlorine (e.g., severe or persistent cough, dyspnea or chemical burns) should be transported to a medical facility for evaluation. Patients who have minor or transient irritation of the eyes or throat may be discharged from the scene after their names, addresses, and telephone numbers are recorded. They should be advised to seek medical care

promptly if symptoms develop or recur.

Routes of Exposure

Exposure to chlorine can occur through inhalation, ingestion, and eye or skin contact [Genium 1992].

Summary of Toxicology

1. Effects on Animals: Chlorine is a severe irritant of the eyes, mucous membranes, skin, and lungs in experimental animals. The 1 hour LC(50) is 239 ppm in rats and 137 ppm in mice ([Sax and Lewis 1989]. Animals surviving sublethal inhalation exposures for 15 to 193 days showed marked emphysema, which was associated with bronchiolitis and pneumonia [Clayton and Clayton 1982]. Chlorine injected into the anterior chamber of rabbits' eyes resulted in severe damage with inflammation, opacification of the cornea, atrophy of the iris, and injury to the lens [Grant 1986].

2. Effects on Humans: Severe acute effects of chlorine exposure in humans have been well documented since World War I when chlorine gas was used as a chemical warfare agent. Other severe exposures have resulted from the accidental rupture of chlorine tanks. These exposures have caused death, lung congestion, and pulmonary edema, pneumonia, pleurisy, and bronchitis [Hathaway et al. 1991]. The lowest lethal concentration reported is 430 ppm for 30 minutes [Clayton and Clayton 1982].

Exposure to 15 ppm causes throat irritation, exposures to 50 ppm are dangerous, and exposures to 1000 ppm can be fatal, even if exposure is brief [Sax and Lewis 1989; Clayton and Clayton 1982]. Earlier literature reported that exposure to a concentration of about 5 ppm caused respiratory complaints, corrosion of the teeth, inflammation of the mucous membranes of the nose and susceptibility to tuberculosis among chronically-exposed workers.

However, many of these effects are not confirmed in recent studies and are of very dubious significance [ACGIH 1991]. A study of workers exposed to chlorine for an average of 10.9 years was published in 1970. All but six workers had exposures below 1 ppm; 21 had TWAs above 0.52 ppm.

No evidence of permanent lung damage was found, but 9.4 percent had abnormal EKGs compared to 8.2 percent in the control group. The incidence of fatigue was greater among those exposed above 0.5 ppm [ACGIH 1991]. In 1981, a study was published involving 29 subjects exposed to chlorine concentrations up to 2.0 ppm for 4- and 8-hour periods.

Exposures of 1.0 ppm for 8 hours produced statistically significant changes in pulmonary function that were not observed at a 0.5 ppm exposure concentration.

Six of 14 subjects exposed to 1.0 ppm for 8 hours showed increased mucous secretions from the nose and in the hypopharynx.

Responses for sensations of itching or burning of the nose and eyes, and general discomfort were not severe, but were perceptible, especially at the 1.0 ppm exposure level [ACGIH 1991]. A 1983 study of pulmonary function at low concentrations of chlorine exposure also found transient decreases in pulmonary function at the 1.0 ppm exposure level, but not at the 0.5 ppm level [ACGIH 1991].

Acne (chloracne) is not unusual among persons exposed to low concentrations of chlorine for long periods of time. Tooth enamel damage may also occur [Parmeggiani 1983]. There has been one confirmed case of myasthenia gravis associated with chlorine exposure [NLM 1995].

Emergency Medical Procedures: [NIOSH to Supply]

- Rescue: Remove an incapacitated worker from further exposure and implement appropriate emergency procedures (e.g., those listed on the Safety Data Sheet (formerly MSDS) required by OSHA's Hazard Communication Standard [29 CFR 1910.1200]).
- All workers should be familiar with emergency procedures, the location and proper use of emergency equipment, and methods of protecting themselves during rescue operations.

Exposure Sources and Control Methods

The following operations may involve chlorine and lead to worker exposures to this substance:

The Manufacture and Transportation of Chlorine

- Used as a chlorinating and oxidizing agent in organic and inorganic synthesis; in the manufacture of chlorinated solvents, automotive antifreeze and antiknock compounds, polymers (synthetic rubber and plastics), resins, elastomers, pesticides, refrigerants, and in the manufacture of rocket fuel.
- Used as a fluxing, purification, and extraction agent in metallurgy.
- Used as a bacteriostat, disinfectant, odor control, and demulsifier in treatment of drinking water, swimming pools, and in sewage.
- Used in the paper and pulp, and textile industries for bleaching cellulose for artificial fibers; used in the manufacture of chlorinated lime; used in detinning and dezincing iron; used to shrink-proof wool.
- Used in the manufacture of pharmaceuticals, cosmetics, lubricants, flame proofing, adhesives, in special batteries containing lithium or zinc, and in hydraulic fluids; use in the processing of meat, fish, vegetables, and fruit.
- Used as bleaching and cleaning agents, and as a disinfectant in laundries, dishwashers, cleaning powders, cleaning dairy equipment, and bleaching cellulose.

Methods that are effective in controlling worker exposures to chlorine, depending on the feasibility of implementation, are as follows: process enclosure, local exhaust ventilation, general dilution, ventilation and personal protective equipment.

Workers responding to a release or potential release of a hazardous substance must be protected as required by paragraph (q) of OSHA's Hazardous Waste Operations and Emergency Response Standard 29 CFR.

Good Sources of Information about Control Methods are as Follows:

1. ACGIH [1992]. Industrial ventilation--a manual of recommended practice. 21st ed. Cincinnati, OH: American Conference of Governmental Industrial Hygienists.
2. Burton DJ [1986]. Industrial ventilation--a self-study companion. Cincinnati, OH: American Conference of Governmental Industrial Hygienists.
3. Alden JL, Kane JM [1982]. Design of industrial ventilation systems. New York, NY: Industrial Press, Inc.
4. Wadden RA, Scheff PA [1987]. Engineering design for control of workplace hazards. New York, NY: McGraw-Hill.
5. Plog BA [1988]. Fundamentals of industrial hygiene. Chicago, IL: National Safety Council.

Alternative Disinfectants Sub-Section

Chloramine

Chloramine is a very weak disinfectant for Giardia and virus reduction. It is recommended that it be used in conjunction with a stronger disinfectant. It is best utilized as a stable distribution system disinfectant because it limits the formation of DBPs. In the production of chloramines, the ammonia residuals in the finished water, when fed in excess of the stoichiometric amount needed, should be limited to inhibit growth of nitrifying bacteria.

Chlorine Dioxide

Chlorine dioxide may be used for either taste and odor control or as a pre-disinfectant. Total residual oxidants (including chlorine dioxide and chlorite, but excluding chlorate) shall not exceed 0.30 mg/L during normal operation or 0.50 mg/L (including chlorine dioxide, chlorite and chlorate) during periods of extreme variations in the raw water supply. Chlorine dioxide provides good Giardia and virus protection, but its use is limited by the restriction on the maximum residual of 0.5 mg/L ClO_2 /chlorite/chlorate allowed in finished water. Where chlorine dioxide is approved for use as an oxidant, the preferred method of generation is to entrain chlorine gas into a packed reaction chamber with a 25% aqueous solution of sodium chlorite (NaClO_2).

Warning: Dry sodium chlorite is explosive and can cause fires in feed equipment if leaking solutions or spills are allowed to dry out.

Ozone (O_3)

Ozone is a very effective disinfectant for both Giardia and viruses. Ozone CT values(contact time) must be determined for the ozone basin alone; an accurate T10 value must be obtained for the contact chamber, residual levels measured through the chamber and an average ozone residual calculated.

Ultraviolet Radiation

The enormous temperatures on the sun create ultraviolet (UV) rays in great amounts, and this radiation is so powerful that all life on earth would be destroyed if these rays were not scattered by the atmosphere and filtered out by the layers of ozone gas that float some 20 miles above the earth.

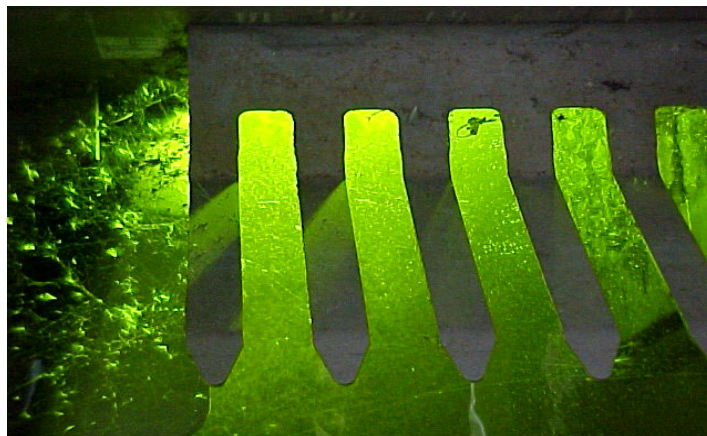

Photo of the green UV light

		MICROBIOLOGICAL SAFETY	CHEMICAL SAFETY	CUSTOMER AESTHETICS	EASE OF MONITORING	ABILITY TO TREAT DIFFICULT WATER	COST OF OPERATING	CAPITAL COSTS	STATE OF COMMERCIAL DEVELOPMENT	SCALE-UP	WASTE PRODUCTION AND ENERGY USE	RELIABILITY
GROUNDWATER	CHLORINE	-	-	-	+	+	+	+	+	+	+	-
	UF ONLY	-	+	+	-	+	●	●	-	-	●	-
	UV ONLY	+	+	+	●	+	+	●	+	+	●	●
	Alternate + Residual (1)	+	●	●	+	+	●	-	+	+	+	+
SURFACE WATER	CHLORINE ONLY	-	-	-	+	-	+	+	+	+	+	+
	Conventional pre-treat + CHLORINE	+	-	-	+	-	●	●	+	+	●	-
	UF ONLY	-	-	●	-	-	●	●	-	-	●	-
	Conventional pre-treat +UF	●	+	+	-	+	-	-	-	-	-	-
	Conventional pre-treat + OZONE + UF	-	●	-	-	+	-	-	-	-	-	-
	MF + UV	●	+	-	●	-	+	●	-	-	●	+
	Conventional pre-treat + UV	●	+	+	●	-	+	●	+	+	●	●
	Conventional pre-treat + OZONE + UV	+	●	+	+	+	-	-	+	+	●	+
	Alternative + Residual (2)	+	●	●	+	+	-	-	+	+	+	+

Conventional pre-treat = Coagulation / Sedimentation

UF - Ultrafiltration MF - Microfiltration

+ = Better than average

- = Worse than average

● = Average

(1) UF + Chlorine residual or Conv + UV + Chlorine residual

(2) Conv pre-treat + UF + Chlorine residual or MF + UV

+ Chlorine residual or Conv pre-treat + UV + Residual

EFFECTIVE DISINFECTION ASSESMENT DETERMINATION CHART

Chloramine Breakdown

Monochloramine and dichloramine are formed in the pH range of 4.5 to 8.5, however, monochloramine is most common when the pH is above 8. When the pH of the water is below 4.5, the most common form of chloramine is trichloramine, which produces a very foul odor. The equations for the formation of the different chloramines are as follows: (Reynolds & Richards, 1996)

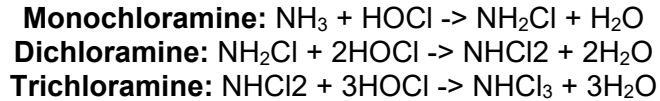

Chloramines are an effective disinfectant against bacteria but not against viruses. As a result, it is necessary to add more chlorine to the water to prevent the formation of chloramines and form other stronger forms of disinfectants.

The final step is that additional free chlorine reacts with the chloramine to produce hydrogen ion, water, and nitrogen gas that will come out of solution. In the case of the monochloramine, the following reaction occurs:



Thus, added free chlorine reduces the concentration of chloramines in the disinfection process. Instead the chlorine that is added is allowed to form the stronger disinfectant, hypochlorous acid.

Perhaps the most important stage of the water or wastewater treatment process is the disinfection stage. This stage is most critical because it has the greatest effect on public health as well as the health of the world's aquatic systems. It is important to realize that wastewater treatment is not a cut and dry process but requires in depth knowledge about the type of wastewater being treated and its characteristics to obtain optimum results.

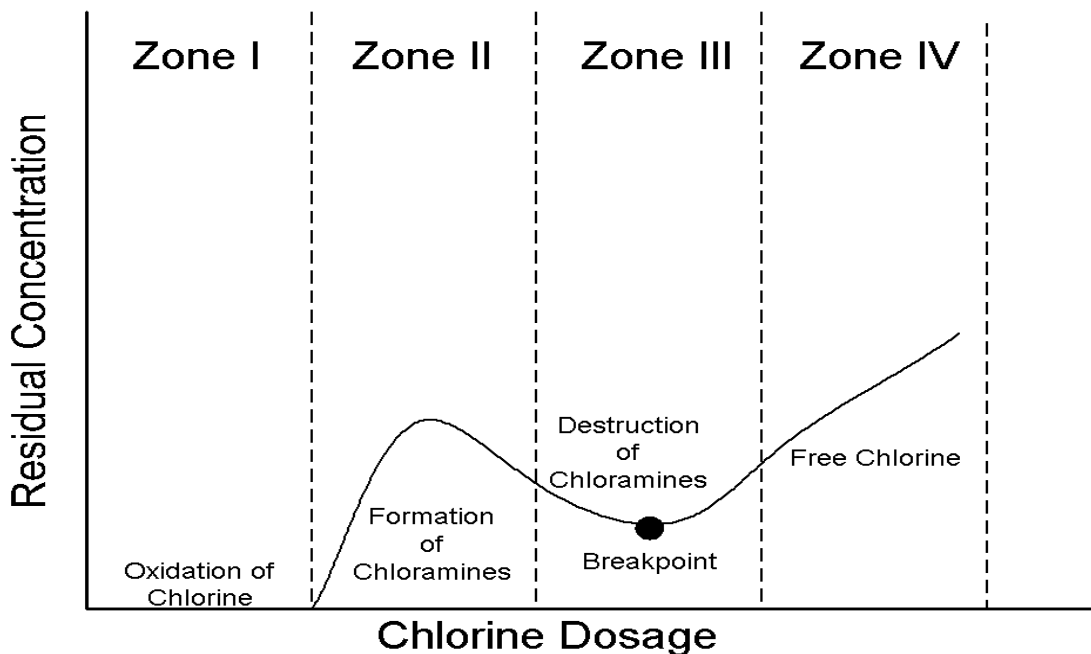

The graph shown on the last page depicts the chlorine residual as a function of increasing chlorine dosage with descriptions of each zone given below (Drawing by Erik Johnston, adapted from Reynolds and Richards, 1996).

- Zone I: Chlorine is reduced to chlorides.
- Zone II: Chloramines are formed.
- Zone III: Chloramines are broken down and converted to nitrogen gas that leaves the system (Breakpoint).
- Zone IV: Free residual.

Therefore, it is very important to understand the amount and type of chlorine that must be added to overcome the difficulties in the strength of the disinfectant that results from the water or wastewater's characteristics.

Water Treatment Chlorination Sequence

The following is a schematic of a water treatment plant.

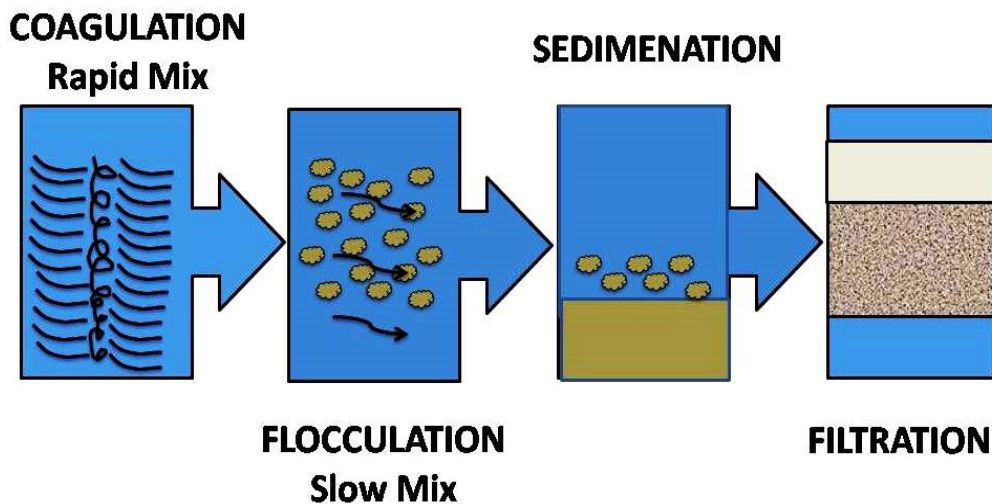

In water treatment, pre-chlorination is utilized mainly in situations where the inflow is taken from a surface water source such as a river, lake, or reservoir.

Chlorine is usually added in the rapid mixing chamber and effectively prevents the majority of algal growth. Algae is a problem in water treatment plants because it builds up on the filter media and increases the head which means that the filters need to be backwashed more frequently. In addition, the algal growth on the filter media causes taste and odor problems in the treated water.

Post Chlorination

Post chlorination is almost always done in water treatment, but can be replaced with chlorine dioxide or chloramines. In this stage chlorine is fed to the drinking water stream which is then sent to the chlorine contact basin to allow the chlorine a long enough detention time to kill all viruses, bacteria, and protozoa that were not removed and rendered inactive in the prior stages of treatment.

Drinking water requires a large addition of chlorine because there must be a residual amount of chlorine in the water that will carry through the system until it reaches the tap of the user. After post chlorination, the water is retained in a clear well prior to distribution.

Chlorine Dioxide Sub- Section

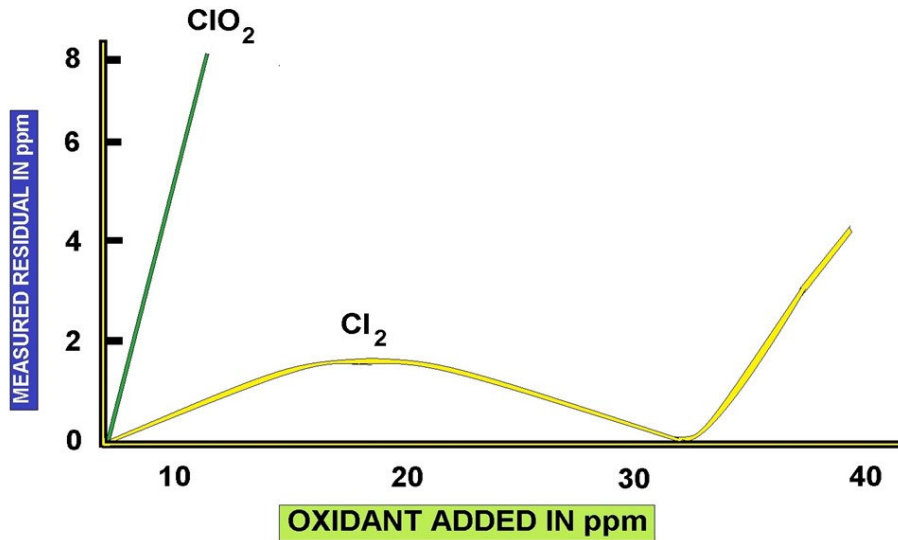

USING CHLORINE DIOXIDE vs CHLORINE

Skin contact	Solutions are highly irritant
Skin Absorption	Gas may be absorbed, causing tissue and blood cell damage.
Eye Contact	Severe Irritant. Exposure may cause visual disturbance, i.e., seeing haloes around lights.
Inhalation	A severe respiratory irritant. May cause bronchospasm and pulmonary edema, which may be delayed in onset. May also cause severe headache. All symptoms may be delayed and long-lasting. Long-term exposure may cause bronchitis. An LC ₅₀ value of 500 ppm/ 15m ³ (rat) is quoted in the literature.
Ingestion	Not applicable except for solutions, in which case the symptoms would be expected to parallel those for inhalation.
Exposure Limits	ACGIH 1992-93: TWA 0.1 ppm, STEL 0.3 ppm. Most legal limits are similar.
Irritancy	Severe
Sensitization	Information not available.
Carcinogenicity	Not listed by IARC or ACGIH.
Teratogenicity & Mutagenicity	No information is available.
Reproductive Toxicology	No information is available.
Toxicological Synergism	May have synergistic effects in conjunction with chlorine, other chlorine oxides, and chlorine fluorine compounds

The threshold limit value (TLV) established by the American Conference of Governmental Industrial Hygienists is 0.1 ppm. Two cases of poisoning (one fatal) resulted from exposure to less than 19 ppm while the victims were inside an empty bleach tank. Concentrations of 150 ppm were fatal to guinea pigs in 44 minutes. Characteristic acute effects from over exposure are coughing, eyes and nose watering and the development of a sore throat. Burns resulting from chlorine are severe since the decomposition produces Cl_2 .

More about Chlorine Dioxide

Chlorine dioxide is generated on-site at water treatment facilities. The popularity of chlorine dioxide as a water disinfectant increased in the 1970s when it was discovered that it did not promote THM formation. Chlorine dioxide (ClO_2), long used in the paper industry, has been an acceptable and effective alternative to chlorination in cooling systems.

Chlorine dioxide is a yellow-green gas with an irritating odor not unlike chlorine. It cannot be compressed and shipped in a container, so it must be generated on site.

There are three proven methods of efficiently generating chlorine dioxide. The most common is the chlorine/chlorite or "one pump" method. ClO_2 generation uses sodium chlorite ($NaClO_2$) and chlorine gas. Chlorine gas is educted into a motive water stream in a ClO_2 generator forming $HOCl$ and HCl . Sodium chlorite is pumped into the stream and allowed to react in a generating column to produce ClO_2 .

A second, common method of generation uses $NaOCl$ and HCl in place of chlorine gas. Also referred to as the "three pump" method of generation, this method is valuable to a facility that wants to eliminate gaseous chlorine.

A third, more recent method of generation uses sodium chlorate ($NaClO_3$) and sulfuric acid. This differs from the other two methods in that ClO_2 is generated in a vacuum and is then educted into the motive water stream.

Chlorine dioxide holds many advantages over chlorine in cooling water systems. ClO_2 is considerably more selective than chlorine in the presence of various compounds, which allows it to be more effective in contaminated systems. Table 2 lists a series of compounds for which chlorine would show a greater affinity than ClO_2 . Under certain conditions ClO_2 may, in fact, be two-and-one-half times more reactive than chlorine. Under efficient ClO_2 generation, THMs are not formed and THM precursors are reduced. In one application, THM formation was reduced from 34 mg/l to 1 mg/l using ClO_2 .

Chlorine dioxide does not hydrolyze in water as does chlorine and there is no dissociation of ClO_2 . It remains fully active in a pH range far broader than chlorine or sodium hypochlorite. Since ClO_2 remains a gas in water, it does not have the corrosive tendencies of chlorine gas. Its selectivity generally allows for lower dosages compared to chlorine, limiting the amount of aggressive Cl available to attack passivated metal surfaces. Finally, ClO_2 is much less aggressive to traditional corrosion inhibitors.

Hypochlorous acid, whether formed from the dissolution of chlorine gas or sodium hypochlorite in water, has satisfactorily controlled microorganisms in cooling water systems. However, dissolution does yield a mineral acid or caustic soda that may adversely affect system pH, inhibitor passivation layers or metal surfaces.

Hypochlorous acid is heavily pH-dependent, because as system pH increases, there is a correspondingly rapid decrease in the concentration of the biocidally active species. It is also a non-specific oxidant which readily reacts with various organic and inorganic compounds that may be present in a cooling water system. Some of these reactions tend to yield undesirable by-products which are regulated or may be regulated in the future.

The effects of pH on hypochlorous acid and its reactivity with a variety of compounds both combine to vastly diminish its effectiveness in contaminated, high-pH cooling water systems. Conversely, chlorine dioxide remains completely pH-independent in the range where recirculating and once-through cooling systems are typically operated. Since ClO_2 is a dissolved gas in water, there is no mineral acid or caustic soda formation as happens when using HOCl. Chlorine dioxide tends to be much less, if not totally non-reactive, with many organic and inorganic compounds.

Chlorine Dioxide Advantages

- Acts as an excellent virucide.
- Does not react with ammonia nitrogen to form chlorinated amines.
- Does not react with oxidizable material to form THMs; destroys up to 30% of THM precursors.
- Destroys phenols that cause taste and odor problems in potable water supplies.
- Forms fewer chlorinated DBPs such as THMs, HAAs and TOX.
- Disinfects and oxidizes effectively, including good disinfection of both *Giardia* and *Cryptosporidium*.
- Works at low dosage in post-disinfection step with no need of booster stations.
- Improves removal of iron and manganese by rapid oxidation and settling of oxidized compounds.
- Does not react with bromide to form bromate or brominated by-products.
- Has enhanced turbidity removal under certain conditions.

Chlorine Dioxide Disadvantages

- Reacts with natural organic matter and forms inorganic by-products. Chlorite ion, and to a lesser extent chlorate ion, are formed when chlorine dioxide is used.
- Requires on-site generation equipment and handling of chemicals.
- Occasionally poses unique odor and taste problems.

First Aid and Treatment

- a) Remove the victim from the contaminated area at once. Loosen all constrictive clothing around the neck.
- b) If breathing has stopped, apply artificial respiration.
- c) Oxygen should be administered by an (external) Emergency Response Team in case of severe exposure.
- d) Call a physician as soon as possible and keep patient warm and quiet.
- e) If conscious, discourage coughing; essence of peppermint is sometimes given.

Reactive Chemical Hazards

- During preparation of gaseous ClO_2 decomposition can occur beyond 100 mm Hg partial pressure or above 100°C.
- Chlorine dioxide is incompatible with ammonia, mercury vapors, methane, phosphine and hydrogen sulfide.
- Chlorine dioxide gas is a highly unstable substance. Long stagnation of the vapors will result in an explosive decomposition. Vapors are reactive with most organics.

Chlorine Dioxide Methods

Most tests for chlorine dioxide rely upon its oxidizing properties. Consequently, numerous test kits are readily available that can be adapted to measure chlorine dioxide. In addition, new methods that are specific for chlorine dioxide are being developed. The following are the common analytical methods for chlorine dioxide:

	DPD glycine	Chlorophenol Red	Direct Absorbance	Iodometric Titration	Amperometric Titration
Method Type:	Colorimetric	Colorimetric	Colorimetric	Titrimetric	Titrimetric
How It Works	Glycine removes Cl ₂ ; ClO ₂ forms a pink color, whose intensity is proportional to the ClO ₂ concentration.	ClO ₂ bleaches chlorophenol red indicator. The degree of bleaching is proportional to the concentration of ClO ₂ .	The direct measurement of ClO ₂ is determined between 350 and 450 nm.	Two aliquots are taken one is sparged with N ₂ to remove ClO ₂ . KI is added to the other sample at pH7 and titrated to a colorless endpoint. The pH is lower to 2, the color allowed to reform and the titration continued. These titrations are repeated on the sparged sample.	
Range	0.5 to 5.0 ppm.	0.1 to 1.0 ppm	100 to 1000 ppm	> 1 ppm	< 1ppm
Interferences	Oxidizers	None	Color, turbidity	Oxidizers	
Complexity	Simple	Moderate	Simple	Moderate	High
Equipment Required	Spectrophotometer or Colorimeter			Titration equipment	Amperometric Titrator
EPA Status	Approved	Not approved	Not approved	Not approved	Approved
Recommendation	Marginal	Yes	Marginal	Yes	Marginal

Ozone

Ozone (O₃)

Ozone is a very effective disinfectant for both Giardia and viruses. Ozone CT values(contact time) must be determined for the ozone basin alone; an accurate T10 value must be obtained for the contact chamber, residual levels measured through the chamber and an average ozone residual calculated.

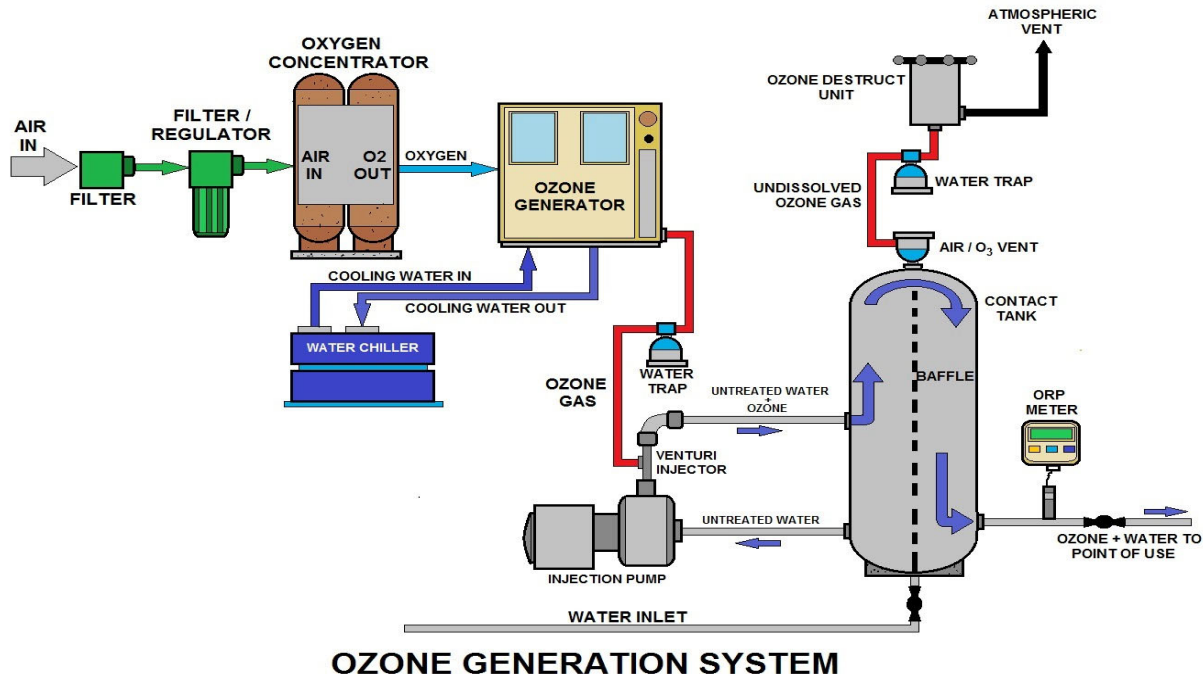

T10 Value Description

Effective contact time for disinfection, in minutes. The detention time corresponding to the time for which 90% of the water remains in the unit process. For ozone chambers, the T10 value is estimated as follows: If no ozone gas is applied, then $T_{10} = (T_{50} * 0.7)$; else $(T_{50} * 0.1)$.

Ozone does not provide a system residual and should be used as a primary disinfectant only in conjunction with free and/or combined chlorine.

Ozone does not produce chlorinated byproducts (such as trihalomethanes) but it may cause an increase in such byproduct formation if it is fed ahead of free chlorine; ozone may also produce its own oxygenated byproducts such as aldehydes, ketones, or carboxylic acids. Ozone may also be used as an oxidant for removal of taste and odor, or may be applied as a pre-disinfectant. Any installed ozonation system must include adequate ozone leak detection alarm systems, and an ozone off-gas destruction system.

Ozone is probably the strongest oxidizing agent available for water treatment. Ozone is obtained by passing a flow of air or oxygen between two electrodes that are subjected to an alternating current in the order of 10,000 to 20,000 volts.



Liquid ozone is very unstable and can readily explode. As a result, it is not shipped and must be manufactured on-site. Ozone is a light blue gas at room temperature. It has a pungent odor similar to that sometimes noticed during and after heavy electrical storms. In use, ozone breaks down into oxygen and nascent oxygen.

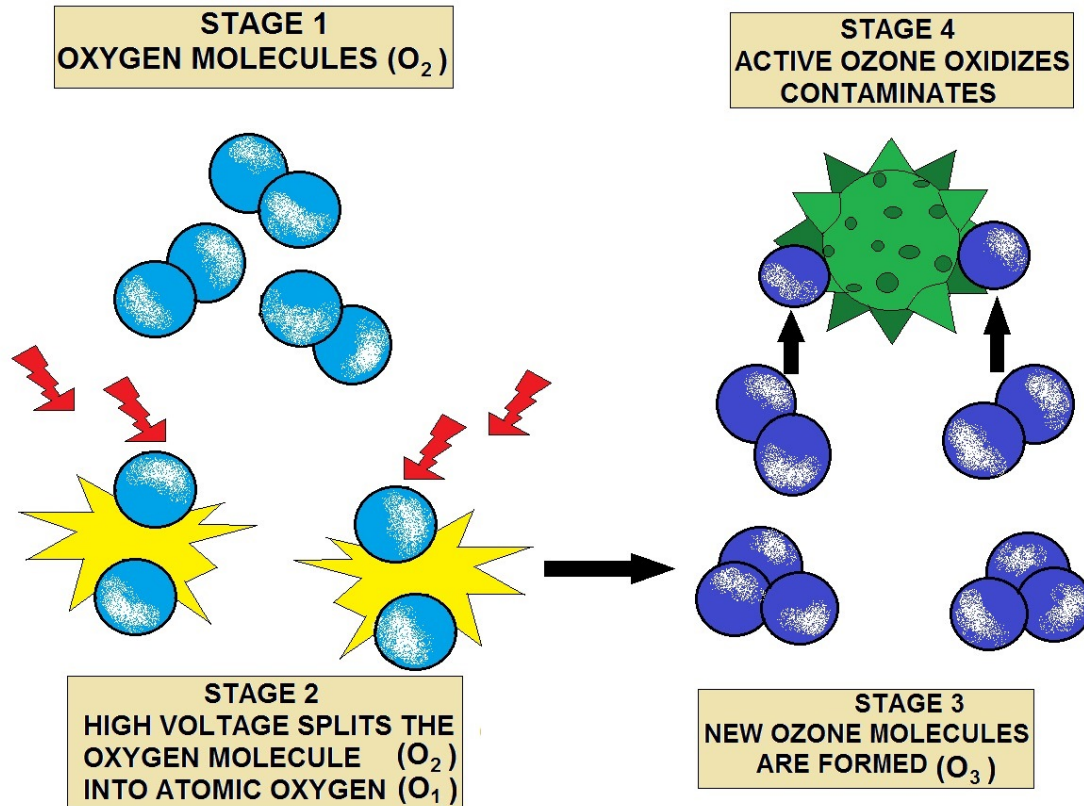

HOW OZONE IS PRODUCED

It is the nascent unpaired, loose oxygen molecule that produces the high oxidation, disinfections, and even sterilization. Each water has its own ozone demand, in the order of 0.5 ppm to 5.0 ppm. Contact time, temperature, and pH of the water are factors in determining ozone demand.

Ozone acts as a complete disinfectant. It is an excellent aid to the flocculation and coagulation process, and will remove practically all color, taste, odor, iron, and manganese. It does not form chloramines or THMs, and while it may destroy some THMs, it may produce other byproducts when followed by chlorination.

Disinfectant Byproducts

Ozone is not practical for complete replacement of chlorine or chloramines, or of THM and other inorganics. Further, because of the possibility of formation of other carcinogens (such as aldehydes or phthalates) it falls into the same category as other disinfectants, because it can produce DBPs.

Ultraviolet Radiation

The enormous temperatures on the sun create ultraviolet (**UV**) rays in great amounts, and this radiation is so powerful that all life on earth would be destroyed if these rays were not scattered by the atmosphere and filtered out by the layers of ozone gas that float some 20 miles above the earth.

This radiation can be artificially produced by sending strong electric currents through various substances. A sun lamp, for example, sends out UV rays that, when properly controlled, result in a suntan. Of course, too much UV will cause sunburn.

The UV lamp that can be used for the disinfection of water depends upon the low-pressure mercury vapor lamp to produce the ultraviolet energy. A mercury vapor lamp is one in which an electric arc is passed through an inert gas. This, in turn, will vaporize the mercury contained in the lamp resulting in the production of UV rays.



The lamp itself does not come into direct contact with the water. The lamp is placed inside a quartz tube, and the water is in contact with the outside of the quartz tube. Quartz is used in this case since practically none of the UV rays are absorbed by the quartz, allowing all of the rays to reach the water.

Ordinary glass cannot be used since it will absorb the UV rays, leaving little for disinfection. The water flows around the ultraviolet contactor (quartz tube). The UV sterilizer will consist of a various number of lamps and tubes, depending upon the amount of water to be treated.

As water enters the sterilizer, it is given a tangential flow pattern so that the water spins over and around the quartz sleeves. In this way, the microorganisms spend maximum time in contact with the outside of the quartz tube and the source of the UV rays. The basic design flow of water of certain UV units is in the order of 2.0 gpm for each inch of the lamp.

Further, the units are designed so the contact or retention time of the water in the unit is not less than 15 seconds. Most manufacturers claim UV lamps have a life of about 7,500 hours, which is about 1 years' time of continuous use.

The lamp must be replaced when it loses about 40% to 50% of its UV output; in any installation this is determined by means of a photoelectric cell and a meter that shows the output of the lamp. Each lamp is outfitted with its own photoelectric cell, and an alarm that will be activated when the penetration drops to a preset level.

Ultraviolet radiation is an excellent disinfectant that is highly effective against viruses, molds, and yeasts; and it is safe to use. It adds no chemicals to the water, it leaves no residual, and it does not form THMs. It is used to remove traces of ozone and chloramines from the finished water. Alone, UV radiation will not remove precursors, but in combination with ozone, it is said to be effective in the removal of THM precursors and THMs.

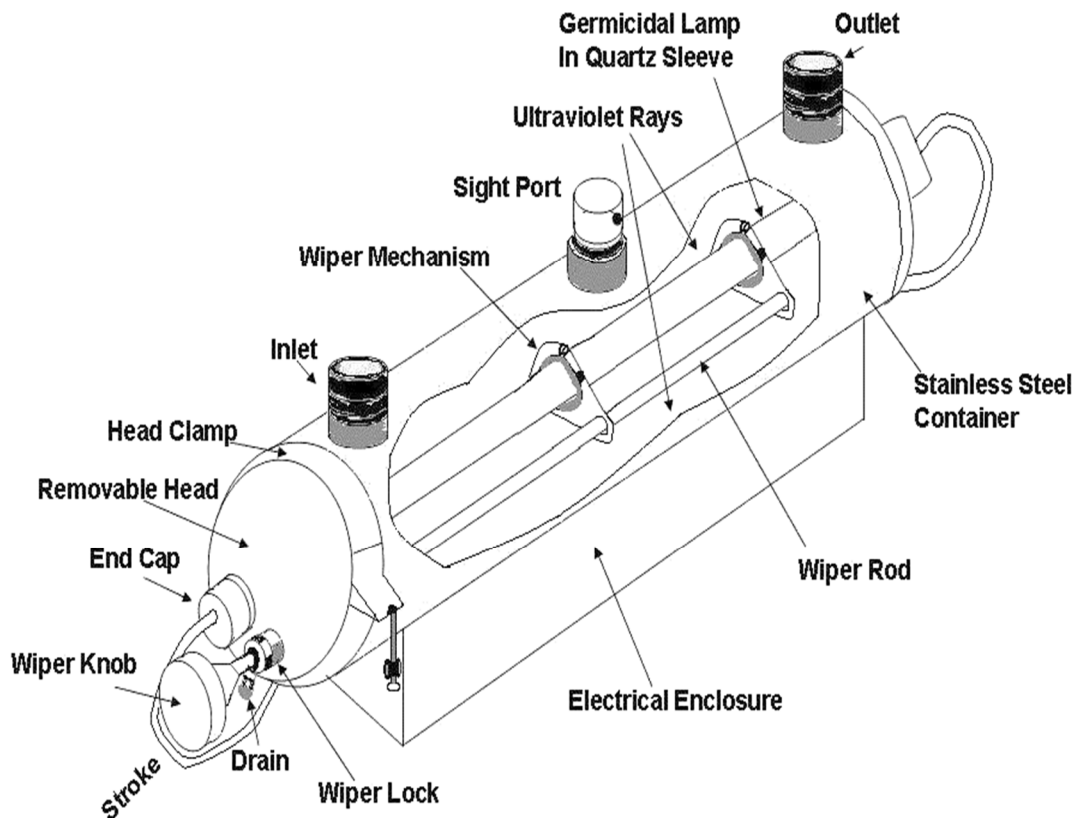

The germicidal effect of UV is thought to be associated with its absorption by various organic components essential to the cell's function. For effective use of ultraviolet, the water to be disinfected must be clean and free of any suspended solids. The water must also be colorless and free of any colloids, iron, manganese, taste, and odor. In addition, although water may appear to be clear, such substances as excesses of chlorides, bicarbonates, and sulfates affect absorption of the ultraviolet rays. The UV unit must be shielded from view for it will cause blindness. These parameters will probably require at least filtration of one type or another. The UV manufacturer will, of course, stipulate which pretreatment may be necessary.

Process Comparison Diagrams

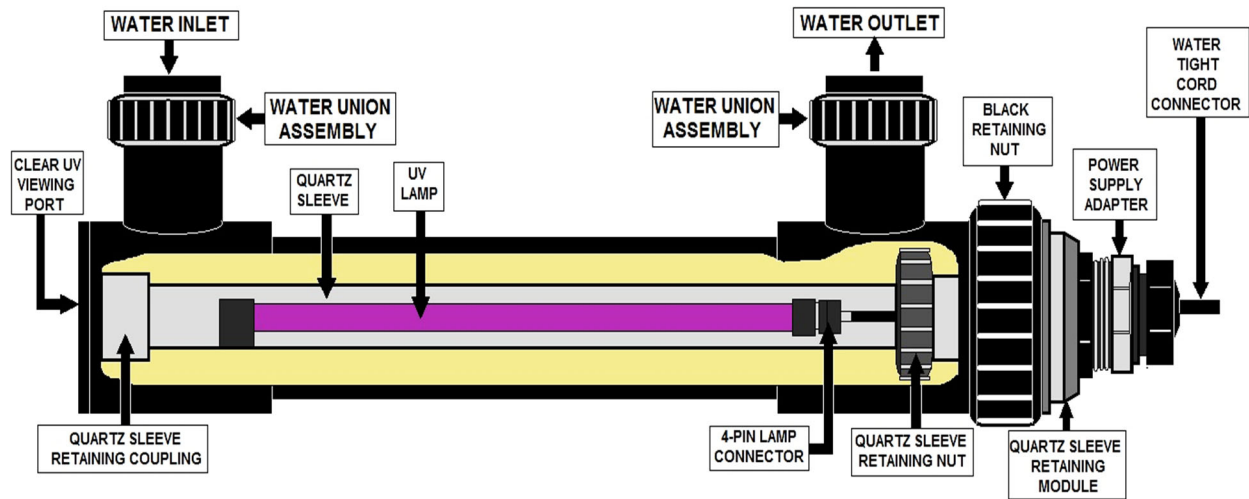

UV LIGHT USED FOR DISINFECTION

Ultraviolet light for disinfection was primarily used in the wastewater industry because of its effectiveness to deactivate microorganisms and not having to dechlorinate the effluent for discharge. In drinking water, UV has become popular because it does not produce trihalomethanes, but there is no residual disinfectant. Another consideration is the cost to operate and maintain the UV unit, which is generally higher than simple chlorination.

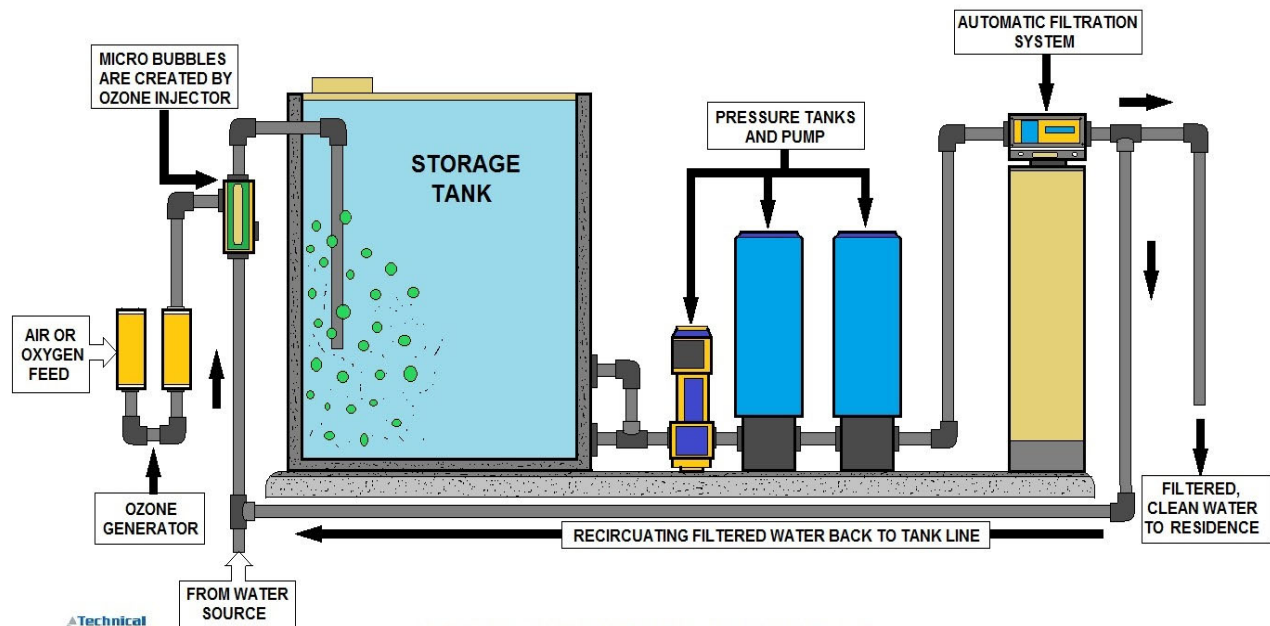

OZONE PROCESS EXAMPLE

Potential Water Treatment Disinfectants Health Hazards

Most water suppliers add a disinfectant to drinking water to kill germs such as Giardia and e coli, especially after heavy rainstorms.

Chlorine

Some people who use drinking water containing chlorine well in excess of EPA standards could experience irritating effects to their eyes and nose. Some people who drink water containing chlorine well in excess of EPA standards could experience stomach discomfort.

Chloramine

Some people who use drinking water containing chloramines well in excess of EPA standards could experience irritating effects to their eyes and nose. Some people who drink water containing chloramines well in excess of EPA standards could experience stomach discomfort or anemia.

Chlorine Dioxide

Some infants and young children who drink water containing chlorine dioxide in excess of EPA standards could experience nervous system effects. Similar effects may occur in fetuses of pregnant women who drink water containing chlorine dioxide in excess of EPA standards. Some people may experience anemia.

Disinfection Byproducts (DBPS)

Disinfection byproducts form when disinfectants added to drinking water to kill germs react with naturally-occurring organic matter in water.

Total Trihalomethanes

Some people who drink water containing trihalomethanes in excess of EPA standards over many years may experience problems with their liver, kidneys, or central nervous systems, and may have an increased risk of getting cancer.

Haloacetic Acids

Some people who drink water containing haloacetic acids in excess of EPA standards over many years may have an increased risk of getting cancer.

Bromate

Some people who drink water containing bromate in excess of EPA standards over many years may have an increased risk of getting cancer.

Chlorite

Some infants and young children who drink water containing chlorite in excess of EPA standards could experience nervous system effects. Similar effects may occur in fetuses of pregnant women who drink water containing chlorite in excess of EPA standards. Some people may experience anemia.

Removal of Disinfection By-Products		
<i>Disinfectant</i>	<i>Disinfectant By-product</i>	<i>Disinfectant By-product Removal</i>
Chlorine (HOCl)	Trihalomethane (THM) Chloramine Chlorophenol	Granular Activated Carbon (GAC), resins, controlled coagulation, aeration. GAC-UV GAC
Chloramine (NH _x Cl _y)	Probably no THM Others?	GAC UV?
Chlorine dioxide (ClO ₂)	Chlorites Chlorates	Use of Fe ₂₊ in coagulation, RO, ion-exchange
Permanganate (KMnO ₄)	No THMs	
Ozone (O ₃)	Aldehydes, Carboxylics, Phthalates	GAC
Ultraviolet (UV)	None known	

The table indicates that most of the disinfectants will leave a by-product that is or would possibly be harmful to health. This may aid a decision as to whether or not precursors should be removed before these disinfectants are added to water.

If it is decided that removal of precursors is needed, research to date indicates that this removal can be attained through the application of controlled chlorination plus coagulation and filtration, aeration, reverse osmosis, nanofiltration, GAC or combinations of other processes.

	CHLORINE AS A DISINFECTANT	ULTRAVIOLET GERMICIDAL IRRADIATION (UV) AS A DISINFECTANT
DISINFECTION BYPRODUCTS (DBPs)	X	No
CHEMICAL RESIDUAL	YES	No
CORROSIVE	X	No
COMMUNITY SAFETY RISKS	X	No
EFFECTIVE AGAINST CRYPTOSPORIDIUM AND GIARDIA	DEPENDS ON TREATMENT PROCESS	Yes
WELL-SUITED FOR CHANGING REGULATIONS	DEPENDS ON TREATMENT PROCESS	Yes

CHLORINE vs. UV FOR DISINFECTION

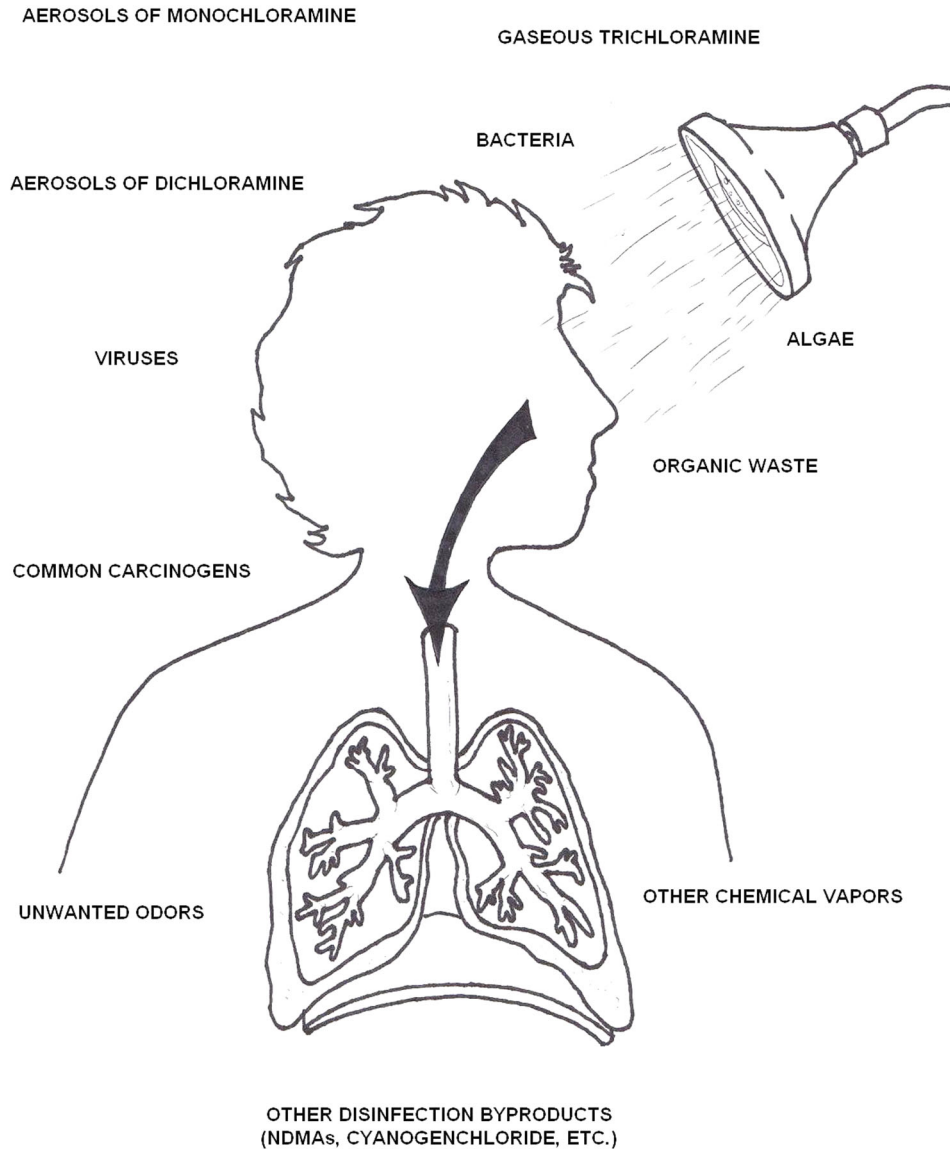

Chloroform Information

Chloroform may be absorbed into the body through ingestion, inhalation, and through the skin. The largest source of human exposure to THMs in the U.S. is from the consumption of chlorinated drinking water. Besides consuming water, other water uses in the home may contribute significantly to total chloroform exposure both from breathing in chloroform vaporized into the air and from it passing through the skin during bathing. Swimming in chlorinated pools will also contribute to the total exposure from the same exposure paths. One study observed that a greater percentage of chloroform passed through the skin when bathing water temperatures were increased. Chloroform does not concentrate in plants; therefore, the contribution from food to total chloroform exposure is small.

Summary

Disinfection

Upon adding chlorine to water, two chemical species, known together as free chlorine, are formed. These species, hypochlorous acid (HOCl, electrically neutral) and hypochlorite ion (OCl⁻, electrically negative), behave very differently. Hypochlorous acid is not only more reactive than the hypochlorite ion, but is also a stronger disinfectant and oxidant.

The ratio of hypochlorous acid to hypochlorite ion in water is determined by the pH. At low pH (higher acidity), hypochlorous acid dominates while at high pH hypochlorite ion dominates. Thus, the speed and efficacy of chlorine disinfection against pathogens may be affected by the pH of the water being treated. Fortunately, bacteria and viruses are relatively easy targets of chlorination over a wide range of pH. However, treatment operators of surface water systems treating raw water contaminated by the parasitic protozoan *Giardia* may take advantage of the pH-hypochlorous acid relationship and adjust the pH to be effective against *Giardia*, which is much more resistant to chlorination than either viruses or bacteria.

Another reason for maintaining a predominance of hypochlorous acid during treatment has to do with the fact that pathogen surfaces carry a natural negative electrical charge. These surfaces are more readily penetrated by the uncharged, electrically neutral hypochlorous acid than the negatively charged hypochlorite ion. Moving through slime coatings, cell walls and resistant shells of waterborne microorganisms, hypochlorous acid effectively destroys these pathogens. Water is made microbiologically safe as pathogens either die or are rendered incapable of reproducing. A typical bacterium has a negatively charged slime coating on its exterior cell wall, which is effectively penetrated by electrically neutral hypochlorous acid, favored by lower pH's.

Chloramines

Chloramines are chemical compounds formed by combining a specific ratio of chlorine and ammonia in water. Because chloramines are relatively weak as a disinfectant, they are almost never used as a primary disinfectant. Chloramines provide a durable residual, and are often used as a secondary disinfectant for long distribution lines and where free chlorine demand is high. Chloramines may also be used instead of chlorine in order to reduce chlorinated byproduct formation and to remove some taste and odor problems.

Advantages

- Reduced formation of THMs, HAAs
- Will not oxidize bromide to bromine forming brominated byproducts
- More stable residual than free chlorine
- Excellent secondary disinfectant, has been found to be better than free chlorine at controlling coliform bacteria and biofilm growth
- Lower taste and odor than free chlorine

Limitations

- Weak disinfectant and oxidant
- Requires shipment and handling of ammonia or ammonia compounds as well as chlorinating chemicals
- Ammonia is toxic to fish, and may pose problems for aquarium owners

- Will cause problems for kidney dialysis if not removed from water

Chlorine Dioxide

Chlorine dioxide (ClO₂) is generated on-site at water treatment facilities. In most generators sodium chlorite and elemental chlorine are mixed in solution, which almost instantaneously forms chlorine dioxide. Chlorine dioxide characteristics are quite different from chlorine.

In solution it is a dissolved gas, which makes it largely unaffected by pH but volatile and relatively easily stripped from solution. Chlorine dioxide is also a strong disinfectant and a selective oxidant. While chlorine dioxide does produce a residual it is only rarely used for this purpose.

Advantages

- ✓ Effective against Cryptosporidium
- ✓ Up to five times faster than chlorine at inactivating Giardia
- ✓ Disinfection is only moderately affected by pH
- ✓ Will not form chlorinated byproducts (THMs, HAAs)
- ✓ Does not oxidize bromide to bromine (can form bromate in sunlight)
- ✓ More effective than chlorine in treating some taste and odor problems
- ✓ Selective oxidant used for manganese oxidation and targeting some chlorine resistant organics

Limitations

- ✓ Inorganic byproduct formation (chlorite, chlorate)
- ✓ Highly volatile residuals
- ✓ Requires on-site generation equipment and handling of chemicals (chlorine and sodium chlorite)
- ✓ Requires a high level of technical competence to operate and monitoring equipment, product and residuals
- ✓ Occasionally poses unique odor and taste problems
- ✓ High operating cost (chlorite chemical cost is high)

Disinfection Section Post Quiz

1. How should the connection from a chlorine cylinder to a chlorinator be replaced?
2. How many turns should a chlorine gas cylinder be initially opened?
3. If the temperature of a full chlorine cylinder is increased by 50°F or 30°C, what is the most likely result?
4. Liquid chlorine is about 1.5 times heavier than water and gaseous chlorine is about 2.5 times heavier than air.
5. For facilities located within residential or densely populated areas, consideration shall be given to provide _____ for the chlorine room.
6. What will be discharged when opening the top valve on a one-ton chlorine cylinder?
7. What are the approved methods for storing a chlorine cylinder?
8. What are normal conditions for a gas chlorination start-up?
9. Name a safety precaution when using chlorine gas?
10. What compounds are formed in water when chlorine gas is introduced?
11. Why should roller bearings not be used to rotate a one-ton chlorine container?
12. What are the physical and chemical properties of chlorine?

13. What are the necessary emergency procedures in the case of a large uncontrolled chlorine leak?

14. Name several symptoms of chlorine exposure.

15. 5 lbs. of a 70% concentration sodium hypochlorite solution is added to a tank containing 650 gallons of water. What is the chlorine dosage?

16. As soon as Cl_2 gas enters the throat area, a victim will sense a sudden stricture in this area - nature's way of signaling to prevent passage of the gas to the lungs. At this point, the victim must attempt to do two things. Name them.

17. Positive pressure SCBAs and full face piece SARs can be used in oxygen deficient atmospheres containing less than what percentage of oxygen in the atmosphere?

18. Death is possible from asphyxia, shock, reflex spasm in the larynx, or massive pulmonary edema. Populations at special risk from chlorine exposure are individuals with pulmonary disease, breathing problems, bronchitis, or chronic lung conditions.

A. TRUE B. FALSE

19. Chlorine gas reacts with water producing a strongly oxidizing solution causing damage to the moist tissue lining the respiratory tract when the tissue is exposed to chlorine. The respiratory tract is rapidly irritated by exposure to 10-20 ppm of chlorine gas in air, causing acute discomfort that warns of the presence of the toxicant.

A. TRUE B. FALSE

20. Even brief exposure to 1,000 ppm of Cl_2 can be fatal.

A. TRUE B. FALSE

21. What are the two main chemical species formed by chlorine in water and what name are they known collectively as?

Topic 9 -Safety Section

Section Focus: You will learn the basics of a distribution safety program. At the end of this section, you will be able to describe confined space, excavation and related construction safety rules. There is a post quiz at the end of this section to review your comprehension and a final examination in the Assignment for your contact hours.

Scope/Background: All distribution operators will at some time will enter a confined space or inside a trench that is 5 feet deep or greater. Many distribution operators have chosen poorly in that they will not implement many required safety procedures in lieu of time or money, or work alone. One of the deadliest distribution operator duties will revolve around a trench failure, or a dangerous confined space entry.



Competent Person

One who is capable of identifying existing and predictable hazards in the surroundings or working conditions which are unsanitary, hazardous, or dangerous to employees.

They have authorization to take prompt corrective measures to eliminate hazards. The Competent Person also is trained and knowledgeable about soil analysis and the use of protective systems.

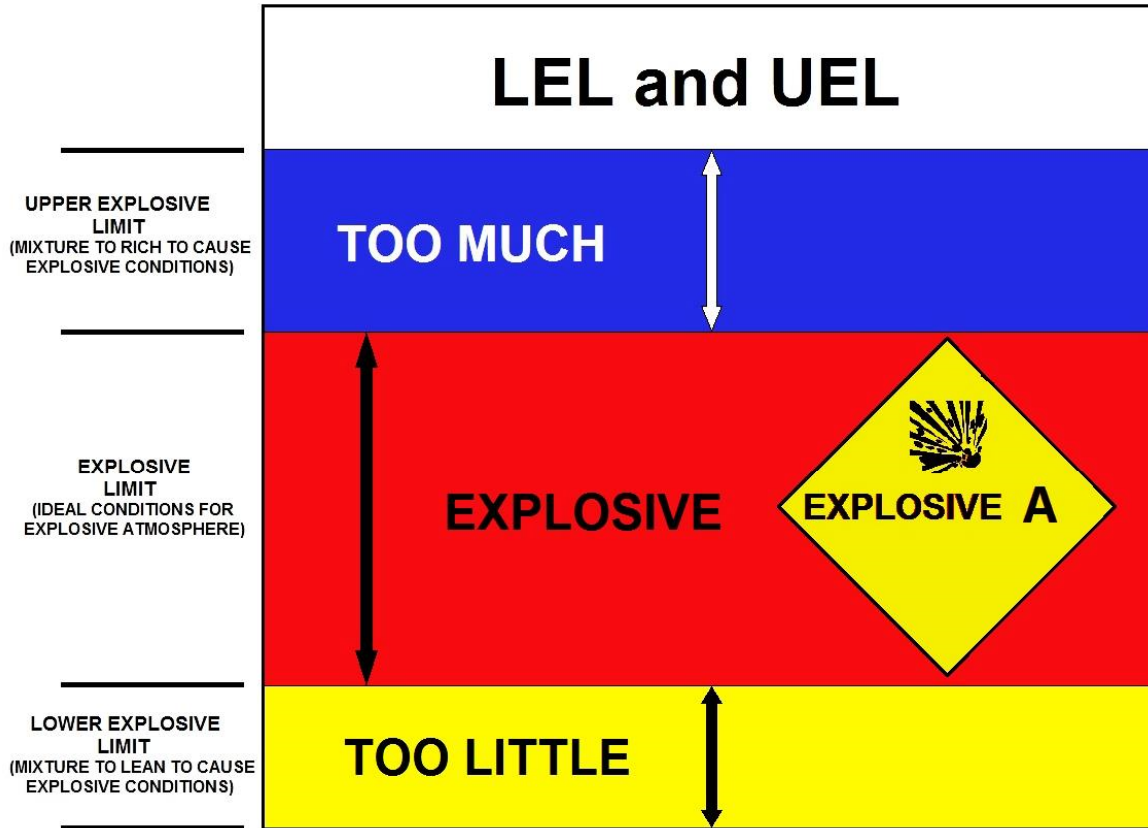

UNDERSTANDING UPPER (UEL) & LOWER (LEL) EXPLOSIVE LIMITS

Confined Space Entry Program Requirements- Introduction Should Include the Following:

- Written confined space entry procedures
- Evaluation to determine whether entry is necessary
- Issuance of a confined space entry permit
- Evaluation of the confined space by a qualified person
- Testing and monitoring the air quality in the confined space to ensure:
- Oxygen level is at least 19.5%
- Flammable range is less than 10% of the LFL (lower flammable limit)
- Training of operators and supervisors in the selection and use of:
 - *safe entry procedures*
 - *respiratory protection*
 - *lifelines and retrieval systems*
 - *protective clothing*
- Training of employees in safe work procedures in and around confined spaces
- Training of employees in confined space rescue procedures
- Conducting safety meetings to discuss confined space safety
- Availability and use of proper ventilation equipment
- Monitoring the air quality while operators are in the confined space.

Recommendation: Employers should identify the types of confined spaces within their jurisdiction and develop and implement confined space entry and rescue programs.

Discussion: Employers may be required to enter confined spaces to perform either non-emergency tasks or emergency rescue.

Therefore, employers should identify the types of confined spaces within their jurisdiction and develop and implement confined space entry and rescue programs that include written emergency rescue guidelines and procedures for entering confined spaces. A confined space program, as outlined in NIOSH Publications 80-106 and 87-113, should be implemented. At a minimum, the following should be addressed:

1. Is entry necessary? Can the task be accomplished from the outside? For example, measures that eliminate the need for employees to enter confined spaces should be carefully evaluated and implemented if at all possible before considering human entry into confined spaces to perform non-emergency tasks.

2. If entry is to be made, has the air quality in the confined space been tested for safety based on the following:

- oxygen supply at least 19.5%
- flammable range for all explosive gases less than 10% of the lower flammable limit
- absence of toxic air contaminants?

3. Is ventilation equipment available and/or used?

4. Is appropriate rescue equipment available?

5. Are supervisors being continuously trained in the selection and use of appropriate rescue equipment such as:

- **SCBA's**
- **lifelines**
- **human hoist systems offering mechanical advantage**
- **protective clothing**
- **ventilation systems**

6. Are employees being properly trained in confined space entry procedures?

7. Are confined space safe work practices discussed in safety meetings?

8. Are employees trained in confined space rescue procedures?

9. Is the air quality monitored when the ventilation equipment is operating?

The American National Standards Institute (ANSI) Standard Z117.1-1989 (Safety Requirements for Confined Spaces), 3.2 and 3.2.1 state, "*Hazards shall be identified for each confined space. The hazard identification process shall include, ... the past and current uses of the confined space which may adversely affect the atmosphere of the confined space; ... The hazard identification process should consider items such as ... the operation of gasoline engine powered equipment in or around the confined space.*"



D-Ring on the rear of the harness is necessary for the entrant to be retrieved from the confined space.

Cheat Sheet Confined Spaces are

- large enough to allow entry of any body part, and
- limited or restricted entry or exit, and
- not designed for continuous employee occupancy

Permit Required Confined Spaces are confined spaces that have any of the following

- potential hazardous atmosphere
- material inside that may engulf or trap you
- internal design that could trap or asphyxiate you
- any other serious safety or health hazard

Entry Permits are required before you enter any "Permit Required Confined Space"

Hazards include

- Fire & Explosion
- Engulfment
- Asphyxiation
- Entrapment
- Slips & Falls
- Electric Shock
- Noise & Vibration
- Chemical Exposure
- Toxic Atmospheres
- Thermal / Chemical Burns

Engineering Controls

- Ventilation
- Locked Access
- Lighting

Administrative Controls

- Controlled Access
- Hazard Assessments
- Entry Permits & Procedures
- Signs & Lockout Tag out
- Training

Smart Safety Rules

Know what you are getting into.

Know how to get out in an emergency.

Know the hazards & how they are controlled.

Only authorized & trained personnel may enter a Confined Space or act as an attendant.

No smoking in Confined Space or near entrance or exit area.

Attendant must be present at all times.

Constant visual or voice communication must be maintained between the attendant and entrants.

No bottom or side entry will be made, or work conducted below the level any hanging material or material which could cause engulfment.

Air and oxygen monitoring is required before entering a Permit-Required Confined Space.

Ventilation & oxygen monitoring is required when welding is performed.

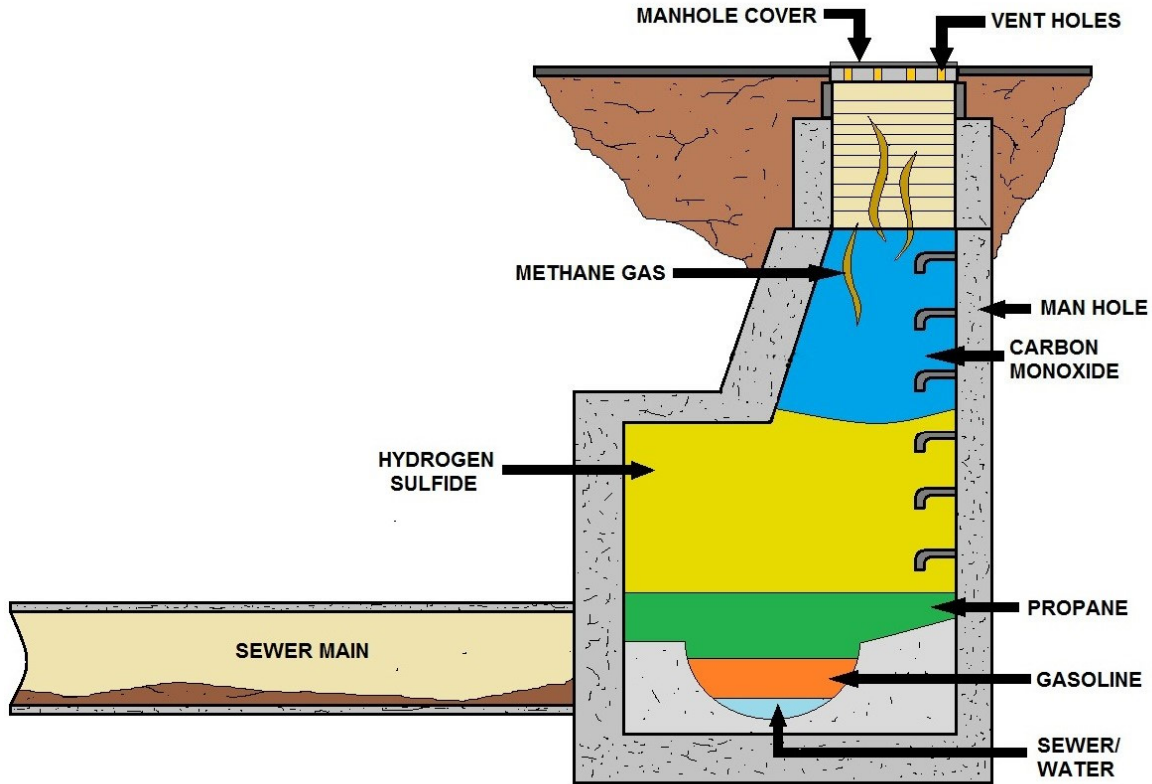

**POSSIBLE HAZARDOUS ATMOSPHERES PRESENT IN A CONFINED SPACE
(EXAMPLE IS OF A SEWER MAIN)**



EXAMPLE OF A CONFINED SPACE ENTRY DANGER SIGN

Confined Space Entry Program

Purpose

The Confined Space Entry Program is provided to protect authorized employees that will enter confined spaces and may be exposed to hazardous atmospheres, engulfment in materials, conditions which may trap or asphyxiate due to converging or sloping walls, or contains any other safety or health hazards.

Reference: OSHA-Permit-Required Confined Spaces (**29 CFR 1910.146**).

Scope

You are required to recognize the dangers and hazards associated with confined spaces, and this program is designed to assist you in the safety of and compliance with the OSHA standards associated with such.

Most distribution operators or contractors and/or communities will utilize the Fire Department for all rescues and additional assistance dealing with confined spaces, understanding that most Fire Department operations utilize additional in house SOG's/SOP's pertaining to such operations.

Definitions

Confined space:

Is large enough or so configured that an employee can bodily enter and perform work.

Has limited or restricted means for entry or exit (i.e. tanks, vessels, silos, storage bins, hoppers, vaults, and pits are spaces that may have limited means of entry).

Is not designed for continuous employee occupancy.

Permit required confined space (permit space), is a confined space that has one or more of the following characteristics:

1. Contains or has a potential to contain a hazardous atmosphere.
2. Contains a material that has the potential for engulfing an entrant.
3. Has an internal configuration such that an entrant could be trapped or asphyxiated by inwardly covering walls or by a floor which slopes downward and tapers to a smaller cross-section.
4. Contains any other recognized serious safety or health hazard.



Each Permit-Required Confined Space will be marked

"Confined Space - Entry Permit Required".

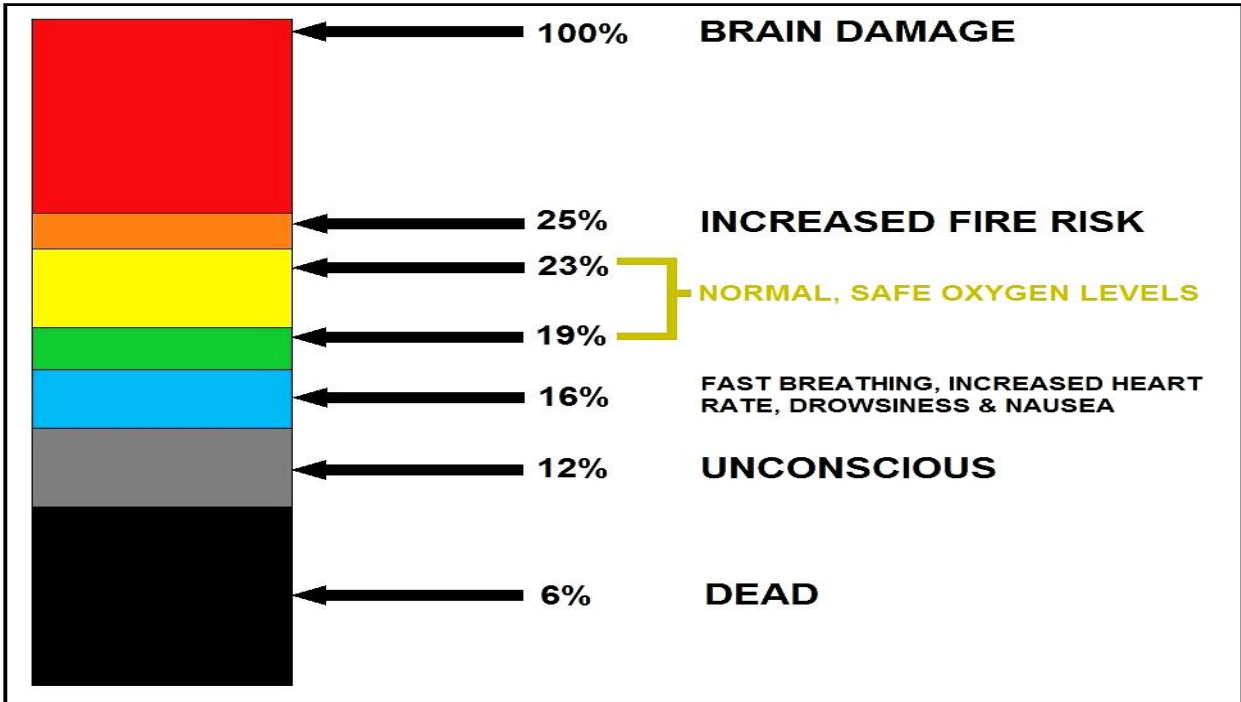

RESULTS OF OXYGEN LEVELS IN CONFINED SPACES

COMMON HAZARDOUS GASES THAT MAY BE PRESENT IN CONFINED SPACE					
SUBSTANCE *	8-HOUR TIME-WEIGHTED AVERAGE (TWA)	15-MINUTE SHORT-TERM EXPOSURE LIMIT (STEL)	CEILING LIMIT (Never To Be Exceeded)	IMMEDIATELY DANGEROUS TO LIFE AND HEALTH (IDLH)	RECOMMENDED ALARM SETTINGS (Low / High)
AMMONIA	25 ppm	35 ppm	—	300 ppm	13 ppm / 25 ppm
CARBON MONOXIDE	25 ppm	100 ppm	—	1200 ppm	13 ppm / 25 ppm
CHLORINE	0.5 ppm	1 ppm	—	10 ppm	0.25 ppm / 0.5 ppm
HYDROGEN SULFIDE	—	—	10 ppm	100 ppm	5 ppm / 10 ppm
METHANE	1000 ppm	—	—	—	500 ppm / 1000 ppm
NITROGEN DIOXIDE	—	—	1 ppm	20 ppm	0.5 ppm / 1 ppm
SULFUR DIOXIDE	2 ppm	5 ppm	—	100 ppm	1 ppm / 2 ppm
OXYGEN	—	—	—	—	20.5 % of Atmosphere
LOWER EXPLOSIVE LIMIT (LEL)	—	—	—	—	5 % LEL

EXAMPLE OF A CHART OF CONFINED SPACE GASES

Confined Space Hazards

Fatalities and injuries constantly occur among construction workers who, during the course of their jobs, are required to enter confined spaces. In some circumstances, these workers are exposed to multiple hazards, any of which may cause bodily injury, illness, or death.

Newspaper and magazine articles abound with stories of workers injured and killed from a variety of atmospheric factors and physical agents. Throughout the construction jobsite, contractors and workers encounter both inherent and induced hazards within confined workspaces.

Inherent Hazards

Inherent hazards, such as electrical, thermal, chemical, mechanical, etc., are associated with specific types of equipment and the interactions among them.

Examples include high voltage (shock or corona discharge and the resulting burns), radiation generated by equipment, defective design, omission of protective features (no provision for grounding non-current-carrying conductive parts), high or low temperatures, high noise levels, and high-pressure vessels and lines (rupturing with resultant release of fragments, fluids, gases, etc.).

Inherent hazards usually cannot be eliminated without degrading the system or equipment, or without making them inoperative.

Therefore, emphasis must be placed on hazard control methods.

Induced Hazards

Induced hazards arise, and are induced from, a multitude of incorrect decisions and actions that occur during the actual construction process. Some examples are: omission of protective features, physical arrangements that may cause unintentional operator contact with electrical energy sources, oxygen-deficient atmospheres created at the bottom of pits or shafts, lack of safety factors in structural strength, and flammable atmospheres.

Typical Examples of Confined Workspaces

Following are typical examples of confined workspaces in construction which contain both inherent and induced hazards.

Vaults

A variety of vaults are found on the construction jobsite. On various occasions, operators must enter these vaults to perform a number of functions.

The restricted nature of vaults and their frequently below-grade location can create an assortment of safety and health problems.



Oxygen-Deficient Atmosphere

One of the major problems confronting construction workers while working in vaults is the ever-present possibility of an oxygen-deficient atmosphere.

Explosive or Toxic Gases, Vapors, or Fumes

While working in an electrical vault, operators may be exposed to the build-up of explosive gases such as those used for heating (propane). Welding and soldering produce toxic fumes which are confined in the limited atmosphere.

Electrical Shock

Electrical shock is often encountered from power tools, line cords, etc. In many instances, such electrical shock results from the fact that the contractor has not provided an approved grounding system or the protection afforded by ground-fault circuit interrupters or low-voltage systems.

Purging

In some instances, purging agents such as nitrogen and argon may enter the vault from areas adjacent to it. These agents may displace the oxygen in the vault to the extent that it will asphyxiate operators almost immediately.

Materials Falling In and On

A hazard normally considered a problem associated with confined spaces is material or equipment which may fall into the vault or onto operators as they enter and leave the vault.

Vibration could cause the materials on top of the vault to roll off and strike operators. If the manhole covers were removed, or if they were not installed in the first place, materials could fall into the vault, causing injury to the operators inside.

Condenser Pits

A common confined space found in the construction of nuclear power plants is the condenser pit. Because of their large size, they are often overlooked as potentially hazardous confined spaces.

These below-grade areas create large containment areas for the accumulation of toxic fumes, gases, and so forth, or for the creation of oxygen-deficient atmospheres when purging with argon, Freon, and other inert gases.

Other hazards will be created by operators above dropping equipment, tools, and materials into the pit.

Manholes

Throughout the construction site, manholes are commonplace. As means of entry into and exit from vaults, tanks, pits, and so forth, manholes perform a necessary function. However, these confined spaces may present serious hazards which could cause injuries and fatalities.

A variety of hazards are associated with manholes. To begin with, the manhole could be a dangerous trap into which the operator could fall. Often covers are removed and not replaced, or else they are not provided in the first place.

Pipe Assemblies

One of the most frequently unrecognized types of confined spaces encountered throughout the construction site is the pipe assembly. Piping of sixteen to thirty-six inches in diameter is commonly used for a variety of purposes.

For any number of reasons, operators will enter the pipe. Once inside, they are faced with potential oxygen-deficient atmospheres, often caused by purging with argon or another inert gas. Welding fumes generated by the operator in the pipe, or by other operators operating outside the pipe at either end, subject the operator to toxic atmospheres.

The generally restricted dimensions of the pipe provide little room for the operators to move about and gain any degree of comfort while performing their tasks. Once inside the pipe, communication is extremely difficult. In situations where the pipe bends, communication and extrication become even more difficult. Electrical shock is another problem to which the operator is exposed.

Ungrounded tools and equipment or inadequate line cords are some of the causes. As well, heat within the pipe run may cause the operator to suffer heat prostration.

Ventilation Ducts

Ventilation ducts, like pipe runs, are very common at the construction site. These sheet metal enclosures create a complex network which moves heated and cooled air and exhaust fumes to desired locations in the plant.

Ventilation ducts may require that workers enter them to cut out access holes, install essential parts of the duct, etc. Depending on where these ducts are located, oxygen deficiency could exist. They usually possess many bends, which create difficult entry and exit and which also make it difficult for workers inside the duct to communicate with those outside it. Electrical shock hazards and heat stress are other problems associated with work inside ventilation ducts.

Tanks

Tanks are another type of confined workspace commonly found in construction. They are used for a variety of purposes, including the storage of water, chemicals, etc.

Tanks require entry for cleaning and repairs. Ventilation is always a problem. Oxygen-deficient atmospheres, along with toxic and explosive atmospheres created by the substances stored in the tanks, present hazards to operators. Heat, another problem in tanks, may cause heat prostration, particularly on a hot day.

Since electrical line cords are often taken into the tank, the hazard of electrical shock is always present. The nature of the tank's structure often dictates that operators must climb ladders to reach high places on the walls of the tank.

Sumps

Sumps are commonplace. They are used as collection places for water and other liquids. Operators entering sumps may encounter an oxygen-deficient atmosphere. In addition, because of the wet nature of the sump, electrical shock hazards are present when power tools are used inside. Sumps are often poorly illuminated. Inadequate lighting may create an accident situation.

Containment Cavities

These large below-grade areas are characterized by little or no air movement. Ventilation is always a problem. In addition, the possibility of oxygen deficiency exists. As well, welding and other gases may easily collect in these areas, creating toxic atmospheres. As these structures near completion, more confined spaces will exist as rooms are built off the existing structure.

Electrical Transformers

Electrical transformers are located on the jobsite. They often contain a nitrogen purge or dry air. Before they are opened, they must be well vented by having air pumped in. Operators, particularly electricians and power plant operators, will enter these transformers through hatches on top for various work-related reasons. Testing for oxygen deficiency and for toxic atmospheres is mandatory.

Heat Sinks

These larger pit areas hold cooling water in the event that there is a problem with the pumps located at the water supply to the plant--normally a river or lake--, which would prevent cooling water from reaching the reactor core.

When in the pits, operators are exposed to welding fumes and electrical hazards, particularly because water accumulates in the bottom of the sink.

Generally, it is difficult to communicate with operators in the heat sink, because the rebar in the walls of the structure deaden radio signals.



Unusual Conditions

Confined Space within a Confined Space

By the very nature of construction, situations are created which illustrate one of the most hazardous confined spaces of all--a confined space within a confined space.

This situation appears as tanks within pits, pipe assemblies or vessels within pits, etc. In this situation, not only do the potential hazards associated with the outer confined space require testing, monitoring, and control, but those of the inner space also require similar procedures.

Often, only the outer space is evaluated. When operators enter the inner space, they are faced with potentially hazardous conditions. A good example of a confined space within a confined space is a vessel with a nitrogen purge inside a filtering water access pit. Operators entering the pit and/or the vessel should do so only after both spaces have been evaluated and proper control measures established.

Hazards in One Space Entering another Space

During an examination of confined spaces in construction, one often encounters situations which are not always easy to evaluate or control. For instance, a room or area which classifies as a confined space may be relatively safe for work.

However, access passages from other areas outside or adjacent to the room could, at some point, allow the transfer of hazardous agents into the "safe" one.

One such instance would be a pipe coming through a wall into a containment room.

Welding fumes and other toxic materials generated in one room may easily travel through the pipe into another area, causing it to change from a safe to an unsafe workplace.

A serious problem with a situation such as this is that operators working in the "safe" area are not aware of the hazards leaking into their area. Thus, they are not prepared to take action to avoid or control it.



Session Conclusion

In this discussion, we have defined inherent and induced hazards in confined spaces. We have examined typical confined spaces on construction sites and we have described representative hazards within these confined spaces.

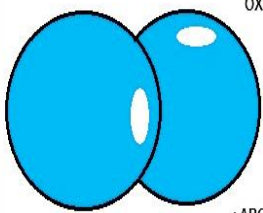
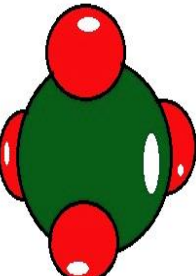
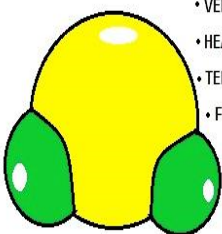
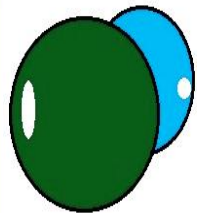
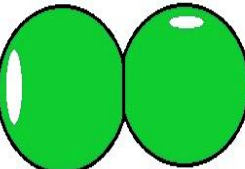
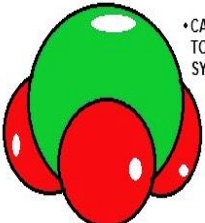
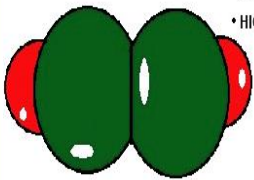
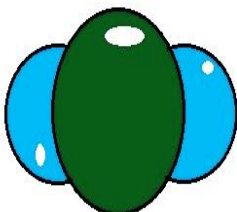
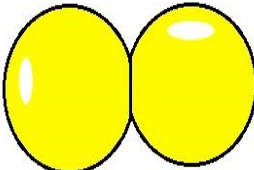
<p>OXYGEN O_2</p>  <ul style="list-style-type: none"> • BELOW 19.5% IS OXYGEN DEPLETED • ABOVE 23.5% IS OXYGEN ENRICHED 	<p>METHANE CH_4</p>  <ul style="list-style-type: none"> • AN ASPHIXIANT <p>OXYGEN LEVELS SHOULD BE KEPT ABOVE 19.5%</p>	<p>HYDROGEN SULFIDE H_2S</p>  <ul style="list-style-type: none"> • VERY HAZARDOUS • HEAVIER THAN AIR • TENDS TO POOL • FLAMMABLE <p>LEL OF 4%</p>
<p>CARBON MONOXIDE CO</p>  <ul style="list-style-type: none"> • AN ASPHIXIANT <p>PERMISSIBLE EXPOSURE LIMIT (PEL) IS 50ppm OVER AN 8-HOUR TWA</p>	<p>NITROGEN N_2</p>  <ul style="list-style-type: none"> • AN ASPHIXIANT <p>USED AS AN INERTING AGENT REPLACING OXYGEN IN THE AIR</p>	<p>AMMONIA NH_3</p>  <ul style="list-style-type: none"> • CAUSES DAMAGE TO RESPIRATORY SYSTEM, EYES, SKIN <p>50ppm PEL 8-HOUR TWA</p>
<p>ACETYLENE C_2H_2</p>  <ul style="list-style-type: none"> • LIGHTER THAN AIR • HIGHLY FLAMMABLE • USED FOR WELDING <p>LEL OF 2.5%</p>	<p>CARBON DIOXIDE CO_2</p>  <ul style="list-style-type: none"> • AN ASPHIXIANT <p>PEL IS 5000ppm OVER 8-HOUR TWA</p>	<p>CHLORINE Cl_2</p> 

COMMON GASES THAT CAN BE FOUND IN CONFINED SPACE

Permitted Confined Space Entry Program

Definition of Confined Spaces Requiring an Entry Permit

Confined space:

- ✓ Is large enough or so configured that an employee can bodily enter and perform work.
- ✓ Has limited or restricted means for entry or exit (i.e. tanks, vessels, silos, storage bins, hoppers, vaults, and pits are spaces that may have limited means of entry).
- ✓ Is not designed for continuous employee occupancy.

Purpose

The Permit Required Space (**PRCS**) Program is provided to protect authorized employees that will enter confined spaces and may be exposed to hazardous atmospheres, engulfment in materials, conditions which may trap or asphyxiate due to converging or sloping walls, or contains any other safety or health hazards.

Many workplaces contain confined spaces not designed for human occupancy which due to their configuration hinder employee activities including entry, work and exit. Asphyxiation is the leading cause of death in confined spaces.

Subpart P applies to all open excavations in the earth's surface.

- ✓ All trenches are excavations.
- ✓ All excavations are not trenches.

Permit Required Confined Space Entry General Rules

During all confined space entries, the following safety rules must be strictly enforced:

1. Only authorized and trained employees may enter a confined space or act as safety watchmen/attendants.
2. No smoking is permitted in a confined space or near entrance/exit area.
3. During confined space entries, a watchmen or attendant must be present at all times.
4. Constant visual or voice communication will be maintained between the safety watchmen and employees entering a confined space.
5. No bottom or side entry will be made or work conducted below the level any hanging material or material which could cause engulfment.
6. Air and oxygen monitoring is required before entering any permit-required confined space. Oxygen levels in a confined space must be between 19.5 and 23.5 percent. Levels above or below will require the use of an SCBA or other approved air supplied respirator. Additional ventilation and oxygen level monitoring is required when welding is performed. The monitoring will check oxygen levels, explosive gas levels and carbon monoxide levels. Entry will not be permitted if explosive gas is detected above one-half the Lower Explosive Limit (**LEL**).
7. To prevent injuries to others, all openings to confined spaces will be protected by a barricade when covers are removed.

Appendix A to §1910.146 Permit-Required Confined Space Decision Flow Chart

Note: Appendices A through F serve to provide information and non-mandatory guidelines to assist employers and employees in complying with the appropriate requirements of this section.

APPENDIX A TO §1910.146—PERMIT-REQUIRED CONFINED SPACE DECISION FLOW CHART

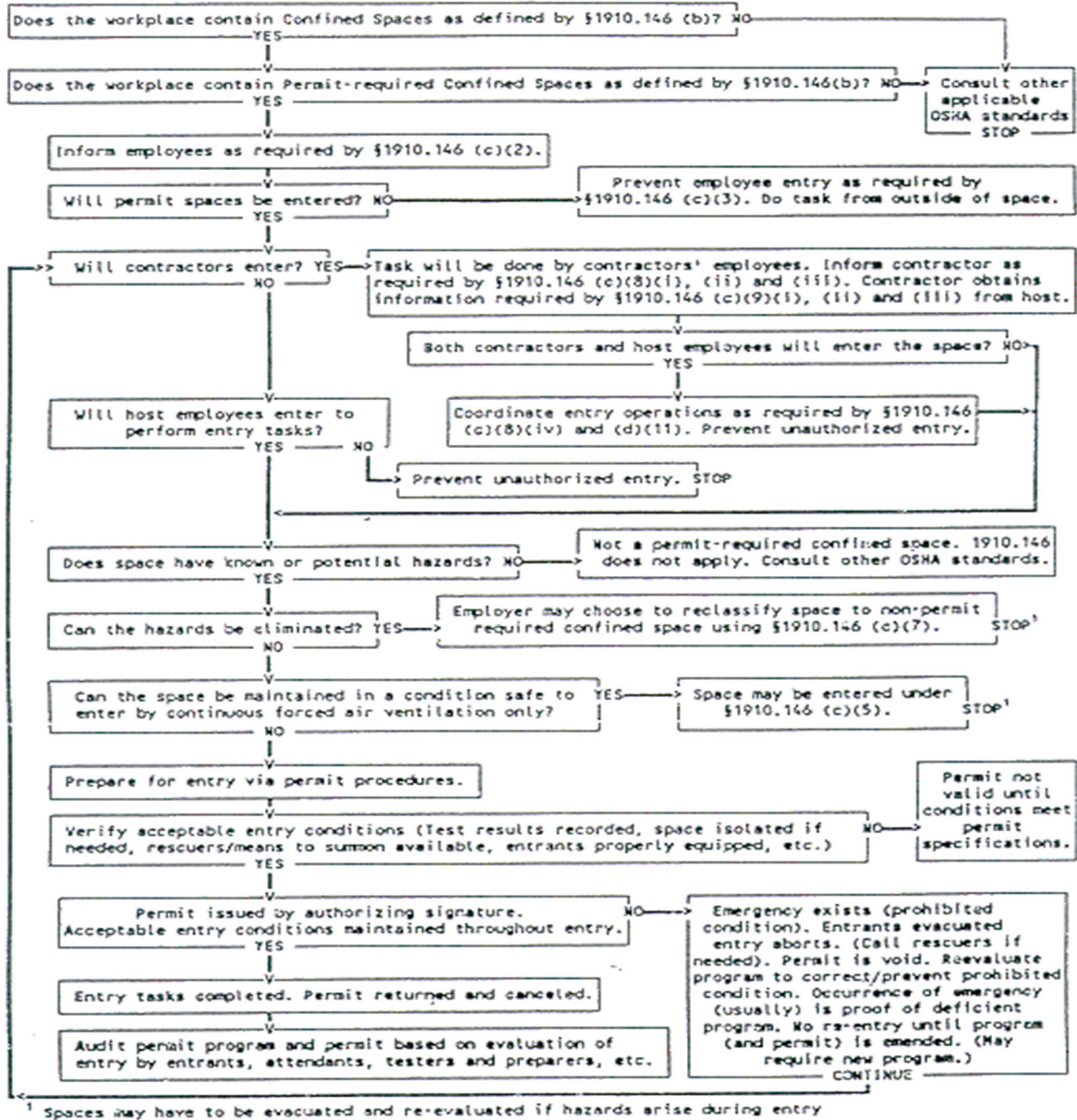

[58 FR 4549, Jan. 14, 1993; 58 FR 34846, June 29, 1993; 63 FR 66039, Dec. 1, 1998]

Confined Space Entry Permit *Example*

Date & Time Issued		Date & time Expires	
Space I.D.		Supervisor	
Equipment Affected		Task	
Standby Team			
Pre-Entry Atmospheric Checks	Time (am - pm)		
	Oxygen		
	Explosive (% LEL)		
	Toxic (PPM)		
	Testers Signature		
Pre-entry Fluid System Isolation		Yes	No
Pumps /lines blinded, blocked, disconnected			
Ventilation Source Established			
Mechanical Forced Air			
Natural Ventilation			
Post Ventilation Pre-Entry Atmospheric Checks			
Time			
Oxygen (%)			
Explosive (% LEL)			
Toxic (PPM)			
Tester Signature			
Communication Procedures Established per specific Confined Space SOP			
Rescue Procedures established per specific Confined Space SOP			

Training Verification - for the following persons & space to be entered				YES	NO		
All persons entering Confined Space							
All persons acting as Supervisor for the Entry							
All persons assigned backup positions							
All persons assigned to monitor access and interior activities							
All persons assigned to emergency rescue team							
Equipment on Scene	YES	NO	NA	YES	NO	NA	
Gas Monitor				Life Line			
Safety Harness				Hoisting Equipment			
Fall Arrest Gear				Powered Comm Eq.			

SCBAs				Air Line Respirators			
Protective Clothing				Elect Gear Properly Rated			
Periodic Atmospheric Checks							
Time (am - pm)							
Oxygen							
Explosive (% LEL)							
Toxic (PPM)							
Testers Signature							

A review of the work authorized by this permit and the information contained on this Entry Permit. Written instructions and safety procedures have been received and are understood. Entry cannot be approved if any squares are marked in the "**No**" column.

This permit is not valid unless all appropriate items are completed.

Permit Prepared By: (Supervisor) _____

Approved By: (Unit Supervisor) _____

This permit to be kept at job site.

Return job site copy to Safety Office following job completion.

Copies: Safety Office, Unit Supervisor, Job site

Irritant (Corrosive) Atmospheres

Irritant or corrosive atmospheres can be divided into primary and secondary groups. The primary irritants exert no systemic toxic effects (effects on the entire body).

Examples of primary irritants are chlorine, ozone, hydrochloric acid, hydrofluoric acid, sulfuric acid, nitrogen dioxide, ammonia, and sulfur dioxide. A secondary irritant is one that may produce systemic toxic effects in addition to surface irritation. Examples of secondary irritants include benzene, carbon tetrachloride, ethyl chloride, trichloroethane, trichloroethylene, and chloroprene.

Irritant gases vary widely among all areas of industrial activity. They can be found in plastics plants, chemical plants, the petroleum industry, tanneries, refrigeration industries, paint manufacturing, and mining operations.

Prolonged exposure at irritant or corrosive concentrations in a confined space may produce little or no evidence of irritation. This may result in a general weakening of the defense reflexes from changes in sensitivity. The danger in this situation is that the operator is usually not aware of any increase in his/her exposure to toxic substances.

Asphyxiating Atmospheres

The normal atmosphere is composed approximately of 20.9% oxygen and 78.1% nitrogen, and 1% argon with small amounts of various other gases. Reduction of oxygen in a confined space may be the result of either consumption or displacement.

The consumption of oxygen takes place during combustion of flammable substances, as in welding, heating, cutting, and brazing. A more subtle consumption of oxygen occurs during bacterial action, as in the fermentation process.

Oxygen may also be consumed during chemical reactions as in the formation of rust on the exposed surface of the confined space (iron oxide). The number of people working in a confined space and the amount of their physical activity will also influence the oxygen consumption rate.

A second factor in oxygen deficiency is displacement by another gas. Examples of gases that are used to displace air, and therefore reduce the oxygen level are helium, argon, and nitrogen.

Carbon dioxide may also be used to displace air and can occur naturally in sewers, storage bins, wells, tunnels, wine vats, and grain elevators.

Aside from the natural development of these gases, or their use in the chemical process, certain gases are also used as inerting agents to displace flammable substances and retard pyrophoric reactions.

Gases such as nitrogen, argon, helium, and carbon dioxide, are frequently referred to as non-toxic inert gases but have claimed many lives. The use of nitrogen to inert a confined space has claimed more lives than carbon dioxide.

The total displacement of oxygen by nitrogen will cause immediate collapse and death.

Carbon Dioxide

Carbon dioxide and argon, with specific gravities greater than air, may lie in a tank or manhole for hours or days after opening. Since these gases are colorless and odorless, they pose an immediate hazard to health unless appropriate oxygen measurements and ventilation are adequately carried out.

Oxygen Deprivation

Oxygen deprivation is one form of asphyxiation. While it is desirable to maintain the atmospheric oxygen level at 21% by volume, the body can tolerate deviation from this ideal. When the oxygen level falls to 17%, the first sign of hypoxia is deterioration to night vision, which is not noticeable until a normal oxygen concentration is restored. Physiologic effects are increased breathing volume and accelerated heartbeat.

Between 14-16% physiologic effects are increased breathing volume, accelerated heartbeat, very poor muscular coordination, rapid fatigue, and intermittent respiration.

Between 6-10% the effects are nausea, vomiting, inability to perform, and unconsciousness.

Less than 6%, the effects are spasmodic breathing, convulsive movements, and death in minutes.

Mechanical Hazards

If activation of electrical or mechanical equipment would cause injury, each piece of equipment should be manually isolated to prevent inadvertent activation before operators enter or while they work in a confined space.

The interplay of hazards associated with a confined space, such as the potential of flammable vapors or gases being present, and the build-up of static charge due to mechanical cleaning, such as abrasive blasting, all influence the precautions which must be taken.

To prevent vapor leaks, flashbacks, and other hazards, operators should completely isolate the space. To completely isolate a confined space, the closing of valves is not sufficient.

All pipes must be physically disconnected or isolation blanks bolted in place. Other special precautions must be taken in cases where flammable liquids or vapors may re-contaminate the confined space.

The pipes blanked or disconnected should be inspected and tested for leakage to check the effectiveness of the procedure. Other areas of concern are steam valves, pressure lines, and chemical transfer pipes. A less apparent hazard is the space referred to as a void, such as double walled vessels, which must be given special consideration in blanking off and inerting.

Excavation and Trenching Sub-Section

OSHA SUBPART P - 29 CFR 1926.650-652

Competent Person Training -Preface

Anyone who has done excavation work will tell you that once the first bucket of dirt is out of the ground, you never know what surprises await. Tales of unmarked utilities, unexpected rock and other nightmares are common. The greatest variable, however, is the type of excavation or trenching will be done and how to protect yourself for a cave-in.

The OSHA excavation standard was revised because excavating is the most dangerous of all construction operations. More workers are killed or seriously injured in and around excavations than in any other construction work. The second reason that OSHA revised the existing standard was to clarify the requirements.

The revised standard makes the standard easier to understand. The new standard uses performance criteria where ever possible. This added flexibility provides employers with options when classifying soil and when selecting methods to protect the employee from cave-ins.

Although the standard has been clarified and employers have options when meeting some of the requirements, employers must realize that the employee must be protected at all times. Some employers have a mindset of not needing this training until they are caught by OSHA, which is equivalent to buying car insurance only after a car collision.

Excavation decisions will have to be made right from the planning stages through completion of the work. Some sections of the standard require that documentation be kept in your possession. TLC will provide a sample of this type of documentation. In some situations, professional engineers will be required to plan or design the excavation and/or method of protecting the worker (such as when an excavation exceeds 20 feet in depth).

The purpose of this session is to provide you with information about the OSHA excavation standard. This program is not designed or intended to provide participants with all the information, rules, regulations, and methods that they may need to know to perform all excavation work safely. Every plan involving excavation must be studied carefully to determine the specific hazards for each job.





Supporting utilities is mandatory.



Major OSHA Violation. Do not operate equipment in unprotected trenches. This guy is trying hard to get to Heaven before his time is up.

Excavation Safety Facts

Every year in the United States:

- ✓ 100 to 500 people are killed in an excavation cave-in.
- ✓ 1000 to 5000 employees are seriously injured.

The average worker that is killed by a cave-in is a 20 to 30-year-old male who has had little or no training at all. Most deaths occur in trenches 5 feet to 15 feet in depth.

Cave-ins cause deaths and injuries by:

- ✓ Suffocation
- ✓ Crushing
- ✓ Loss of circulation
- ✓ Falling objects

One cubic foot (12" x 12" x 12") can weigh between 90 and 140 pounds. Therefore, one cubic yard (3' x 3' x 3') weights as much as a backhoe (approximately 3000 pounds).

Subpart P applies to all open excavations in the earth's surface.

- ✓ All trenches are excavations.
- ✓ All excavations are not trenches.

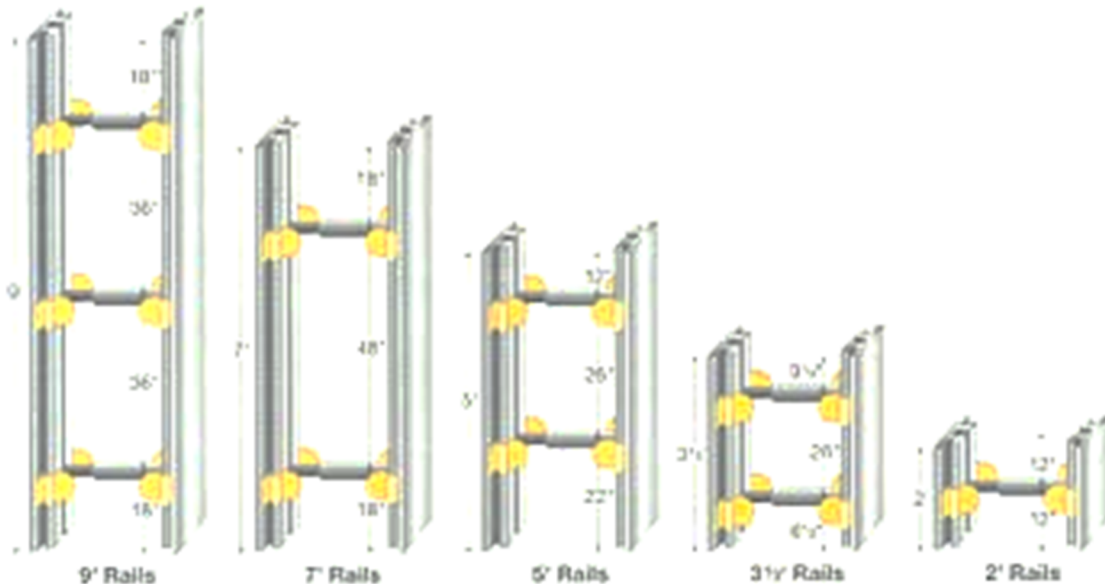



Notice that employees are wearing hard hats but no ladders are present. Spoil piles are too close to the hole. Almost looks like they over did the shores for the photograph but forgot all ladder.



Notice the ladder is partially properly tied down. Three rungs out and tied but not staked.

Competent Person Definition

Competent person means one who is capable of identifying existing hazards in the surroundings or working conditions which are unsanitary, hazardous, or dangerous to employees and has authorization to take prompt corrective measures to eliminate them.

In order to be a "**Competent Person**" for the purpose of this standard, one must have specific training in and be knowledgeable about soils analysis, the use of protective systems and the requirements of 29 CFR Part 1926.650-652 Subpart P.



Rescue training exercises are essential. Everyone is required to practice once a year. Yes, once a year.

Personnel Protective Systems

Employees in excavations shall be protected from cave-ins by an adequate protective system, which shall be inspected by a competent person.

The use of protective systems is required for all excavations, in excess of five (5') feet, except when excavation is within stable rock.

Trench excavation less than five (5') feet in depth may not require the use of protective systems, unless there is evidence of a potential cave-in. The competent person shall determine the need for the use of protective systems when such conditions exist.

When sloping, benching or protective systems are required, refer to requirements in CFR 1926.652 (OSHA Construction Standards).

Whenever support systems, shield systems, or other protective systems are being used, a copy of the manufacturer's specifications, recommendations, and limitations sheet shall be in written form and maintained at the job site.



This poor soul is probably going to be a short timer here on earth. He is sitting on the sewer main in a bell shaped hole under a steel plate which cars are driving over. No protection at all. There was a ladder in the trench but was about 50 feet away.

Competent Person Duties

- Performs daily inspections of the protective equipment, trench conditions, safety equipment and adjacent areas.
- Inspections shall be made prior to the start of work and as needed throughout the shift.
- Inspections shall be made after every rainstorm or other hazard occurrence.
- Knowledge of emergency contact methods, telephone or radio dispatch.
- Removes employees and all other personnel from hazardous conditions and makes all changes necessary to ensure their safety.
- Insures all employees have proper protective equipment, hard-hats, reflective vests, steel-toed boots, harnesses, eye protection, hearing protection and drinking water.
- Categorize soil conditions and conduct visual and manual tests.
- Determine the appropriate protection system to be used.
- Maintain onsite records of inspections and protective systems used.
- Maintain onsite Hazard Communication program, Material Safety Data Sheets and a Risk Management Plan, if necessary.
- Maintain current First Aid and CPR certifications. Maintain current Confined Space certification training.

Scope of Work

1. During excavation work a competent person shall be on the job site at all times when personnel are working within or around the excavation. This is necessary in order to monitor soil conditions, equipment and protection systems employed.
2. The estimated locations of utility installations, such as sewer, telephone, fuel, electric, water lines, or any other underground installation that reasonably may be expected to be encountered during excavation work, shall be determined prior to opening an excavation.
3. Adequate precautions shall be taken to protect employees working in excavations, against the hazards posed by water accumulation.
4. Employees shall be protected from excavated or other materials or equipment that could pose a hazard by falling or rolling into excavations. Protection shall be provided by placing and keeping such material or equipment at least two (2') feet from the edge of excavations.
5. A stairway, ladder, or ramp shall be used as a means of access or egress in trench excavations that are four (4') feet or more in depth. The ladder(s), stairway(s), or ramp shall be spaced so that no employee in the trench excavation is more than twenty-five (25') feet from a means of egress. When ladder(s) are employed, the top of the ladder shall extend a minimum of three (3') feet above the ground and shall be properly secured.
6. When excavations are exposed to vehicular traffic, each employee shall wear a warning vest made with reflective material or highly visibility material. All personnel within the construction area shall wear a hard-hat at all times.
7. Employees shall not be permitted underneath loads handled by lifting or digging equipment. Employees shall be required to stand away from any vehicle being loaded or unloaded to avoid being struck by any spillage or falling materials.
8. In excavations where oxygen deficiency or gaseous conditions exist, or could be reasonably expected to exist, air in the excavation shall be tested.
9. Where oxygen deficiency (atmospheres containing less than 19.5 percent oxygen) exists, the area must be continuously ventilated until the oxygen levels are above 19.5 percent.
10. Where a gaseous condition exists, the area shall be ventilated until the flammable gas concentration is below 20 percent of the lower flammable limit.

11. Whenever oxygen deficiency or gaseous conditions exist or could reasonably exist, the area shall be monitored continuously to assure that employees are protected.
12. Where the stability of adjoining buildings, walls or other structures are endangered by excavation operations, support systems such as shoring, bracing, or underpinning shall be provided to ensure the stability of such structures for the protection of employees.
13. Sidewalks, pavement and appurtenant structures shall not be undermined unless a support system such as shoring is provided to protect employees from the possible collapse of such structures.



Always wait for the buried utilities to be marked before excavation begins. Unbelievably, this crew dug 9 feet deep before the Locator showed up and marked fiber optics in the same trench. Notice that the employees do not have hard hats, ladders, or any protective systems. Several major OSHA violations.

Excavation Protection Systems

The three basic protective systems for excavations and trenches are sloping and benching systems, shoring, and shields. The protective systems shall have the capacity to resist without failure all loads that are intended or could reasonably be expected to be applied to or transmitted to the system. Every employee in an excavation shall be protected from cave-ins by an adequate protective system.

Exceptions to Using Protective System:

- Excavations are made entirely in stable rock.
- Excavations are less than 5 feet deep and declared safe by a competent person.

Sloping and Benching Systems

There are four options for sloping:

- Slope to the angle required by the standard for Type C, which is the most unstable soil type.
- The table provided in Appendix B of the standard may be used to determine the maximum allowable angle (after determining the soil type).
- Tabulated data prepared by a registered professional engineer can be utilized.
- A registered professional engineer can design a sloping plan for a specific job.

Sloping and benching systems for excavations five (5) to twenty (20) feet in depth must be constructed under the instruction of a designated competent person. Sloping and benching systems for excavations greater than twenty (20) feet must be designed and stamped by a registered professional engineer. Sloping and benching specifications can be found in Appendix B of the OSHA Standard (Subpart P).

Shoring Systems

Shoring is another protective system or support system. Shoring utilizes a framework of vertical members (uprights), horizontal members (whales), and cross braces to support the sides of the excavation to prevent a cave-in. Metal hydraulic, mechanical or timber shoring are common examples.



Here are two men in a 30-foot-deep trench without any protection or ladders. They are lucky to have a rope. Please do not work in this dangerous environment.

The different examples of shoring are found in the OSHA Standard under these appendices:

APPENDIX C - Timber Shoring for Trenches

APPENDIX D - Aluminum Hydraulic Shoring for Trenches

APPENDIX E - Alternatives to Timber Shoring

Shield Systems (Trench Boxes)

Shielding is the third method of providing a safe workplace. Unlike sloping and shoring, shielding does not prevent a cave-in. Shields are designed to withstand the soil forces caused by a cave-in and protect the employees inside the structure. Most shields consist of two flat, parallel metal walls that are held apart by metal cross braces.

Shielding design and construction is not covered in the OSHA Standards. Shields must be certified in design by a registered professional engineer and must have either a registration plate on the shield or registration papers from the manufacturer on file at the jobsite office. **ANY REPAIRS OR MODIFICATIONS MUST BE APPROVED BY THE MANUFACTURER.**

Safety Precautions for Shield Systems

- Shields must not have any lateral movement when installed.
- Employees will be protected from cave-ins when entering and exiting the shield (examples - ladder within the shield or a properly sloped ramp at the end).
- Employees are not allowed in the shield during installation, removal, or during any vertical movement.
- Shields can be 2 ft. above the bottom of an excavation if they are designed to resist loads at the full depth and if there are no indications of caving under or behind the shield.
- The shield must extend at least 18 inches above the point where proper sloping begins (the height of the shield must be greater than the depth of the excavation).
- The open end of the shield must be protected from the exposed excavation wall. The wall must be sloped, shored, or shielded. Engineer designed end plates can be mounted on the ends of the shield to prevent cave-ins.



Personal Protective Equipment

It is OSHA policy for you to wear a hard hat, safety glasses, and work boots on the jobsite. Because of the hazards involved with excavations, other personal protective equipment may be necessary, depending on the potential hazards present (examples-goggles, gloves, and respiratory equipment).

Excavation & Trenching Guidelines

This section outlines procedures and guidelines for the protection of employees working in and around excavations and trenches. This section requires compliance with OSHA Standards described in Subpart P (**CFR 1926.650**) for the construction industry.

Safety compliance is mandatory to ensure employee protection when working in or around excavations.

The competent person(s) must be trained in accordance with the OSHA Excavation Standard, and all other programs that may apply (examples Hazard Communication, Confined Space, and Respiratory Protection), and must demonstrate a thorough understanding and knowledge of the programs and the hazards associated.

All other employees working in and around the excavation must be trained in the recognition of hazards associated with trenching and excavating.

REFERENCES

- 29 CFR 1926.650, Subpart P - Excavations
- Excavation Equipment Manufacturer Safety Procedures



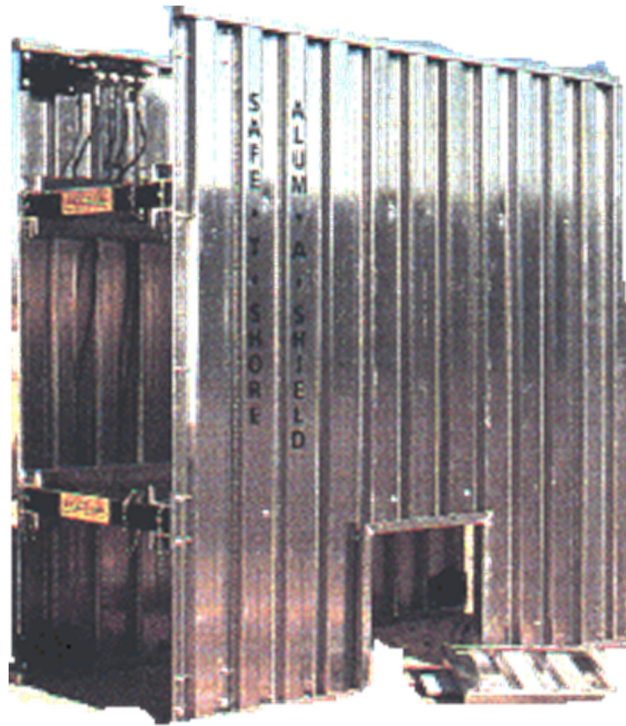

Trench Shields and Boxes



Trench Hazards

One of the reasons OSHA requires a competent person onsite during excavation & trenching are the numerous potential hazardous that may be encountered or created.

Hazards include:

- Electrocution**
- Gas Explosion**
- Entrapment**
- Struck by equipment**
- Suffocation**



Hazard Controls

Before any work is performed and before any employees enter the excavation, a number of items must be checked and insured:

- Before any excavation, underground installations must be determined. This can be accomplished by either contacting the local utility companies or the local "one-call" center for the area. All underground utility locations must be documented on the proper forms. All overhead hazards (**surface encumbrances**) that create a hazard to employees must be removed or supported to eliminate the hazard.
- If the excavation is to be over 20 feet deep, it must be designed by a registered professional engineer who is registered in the state where the work will be performed.
- Adequate protective systems will be utilized to protect employees. This can be accomplished through sloping, shoring, or shielding.
- The worksite must be analyzed in order to design adequate protection systems and prevent cave-ins. There must also be an excavation safety plan developed to protect employees.
- Operators must be supplied with, and wear, any personal protective equipment deemed necessary to assure their protection.
- All spoil piles will be stored a minimum of **two (2) feet** from the sides of the excavation. The spoil pile must not block the safe means of egress.
- If a trench or excavation is 4 feet or deeper, stairways, ramps, or ladders will be used as a safe means of access and egress. For trenches, the employee must not have to travel any more than 25 feet of lateral travel to reach the stairway, ramp, or ladder.
- No employee will work in an excavation where water is accumulating unless adequate measures are used to protect the employees.
- A competent person will inspect all excavations and trenches daily, prior to employee exposure or entry, and after any rainfall, soil change, or any other time needed during the shift. The competent person must take prompt measures to eliminate any and all hazards.
- Excavations and trenches 4 feet or deeper that have the potential for toxic substances or hazardous atmospheres will be tested at least daily. If the atmosphere is inadequate, protective systems will be utilized.
- If work is in or around traffic, employees must be supplied with and wear orange reflective vests. Signs and barricades must be utilized to ensure the safety of employees, vehicular traffic, and pedestrians.



Entry Procedures

If there are no non-atmospheric hazards present and if the pre-entry tests show there is no dangerous air contamination and/or oxygen deficiency within the space and there is no reason to believe that any is likely to develop, entry into and work within may proceed.

Continuous testing of the atmosphere in the immediate vicinity of the workers within the space shall be accomplished. The workers will immediately leave the permit space when any of the gas-monitor alarm set points are reached as defined.

Workers will not return to the area until a SUPERVISOR who has completed the gas detector training has used a direct reading gas detector to evaluate the situation and has determined that it is safe to enter.

Excavation Safety Plan

An excavation safety plan is required in written form. This plan is to be developed to the level necessary to insure complete compliance with the OSHA Excavation Safety Standard and state and local safety standards.

Excavation Safety Plan Factors:

- Utilization of the local one-call system.
- Determination of locations of all underground utilities.
- Consideration of confined space atmosphere potential.
- Proper soil protection systems and personal protective equipment and clothing.
- Determination of soil composition and classification.
- Determination of surface and subsurface water.
- Depth of excavation and length of time it will remain open.
- Proper adherence to all OSHA Standards, this excavation and trenching safety program, and any other coinciding safety programs.

1. Warning system for mobile equipment, methods to help prevent vehicles and equipment from falling in the trench can be accomplished by providing:

- A. Barricades.
- B. Hand or mechanical signals.
- C. Stop logs.
- D. Grade away from the excavation.

All equipment with an obstructed rear view is required to have a back-up alarm or an observer when backing {1926.601 (b) (4).}

2. Hazardous atmospheres, you must limit all exposures to hazardous atmospheres.

- A. Oxygen deficient is anything less than 19.5% oxygen. Symptoms will include dizziness, increased heart rate or may experience a buzzing in the ears.
- B. Normal is 21% oxygen.
- C. Oxygen enriched atmospheres increase flammability of combustible materials.
- D. Carbon monoxide causes oxygen starvation and can be fatal at a concentration of 1% for one minute. This is equal to 10,000 PPM. The Threshold Limit Value (TLV) is only 50 PPM.
- E. If there is a possibility that a hazardous atmosphere exists or could be reasonably expected to exist, test the atmosphere before the employee enters an excavation. Some areas of concern include; digging near gas lines, sewers, landfills and near areas of high traffic.
- F. Provide respirators or ventilation when needed. All personnel must be fit tested before wearing a respirator and all personnel must be training how to use ventilation.

The use of any respirator by employees will require a written respirator program form the employer {1926.103}.

- A. Ventilate trench if flammable gas exceeds 20% of the lower flammable limit.
- B. Test the atmosphere often--this will ensure that the trench remains safe.
- C. Perform regular maintenance on gas meters. Calibrate and change out filters regularly.
- D. Never enter a hazardous atmosphere to rescue an employee unless you have been trained in rescue techniques and have proper rescue equipment. More than half the deaths occur while attempting a rescue.

3. **Emergency rescue equipment must be available when a hazardous atmosphere exists or could be reasonably expected to exist.**
 - A. Respirator must be suitable for the exposure. An air supplied or self-contained breathing apparatus is preferable
 - B. Harness and lifeline is required when an employee enters bellbottom piers and other deep confined spaces. The lifeline must be attended at all times.

Employees entering confined spaces must be trained. {1926.21 (b) (6) I}

Specific requirements for welding in confined spaces {1926.352 (g) and 1926.653 (b)}.

4. **Protection from hazards associated with water accumulation is necessary to prevent cave-ins.**
 - A. Methods for controlling accumulated water vary with each situation.
 - B. Employees are not permitted to work in trenches where water accumulation exists.
 - C. Special support system or shield systems may be used to protect employees from cave-ins.
 - D. Water removal equipment may be used and must be monitored by a competent person to prevent water accumulation.
 - E. Safety harness and lifeline may be used to protect employees.
 - F. Surface water must be diverted and controlled.
 - G. Trench must be inspected after rain.
5. **Stability of adjacent structures to protect employees from cave-ins.**
 - A. Support systems such as shoring, bracing, or underpinning must be used to support structures that may be unstable due to excavation operations.
 - B. Excavation below the base or footing of a foundation or wall is not permitted unless:
 - i. **Support system is provided to ensure the stability of the structure.**
 - ii. **The excavation is in stable rock.**
 - iii. **A Registered Professional Engineer approves the operation.**
 - C. Support systems must be provided for sidewalks, pavements and other structures that may be affected by the excavation operations.
6. **Protection of employees from loose rock or soil.**
 - A. Employees must be protected from being struck by materials falling or rolling from the edge and the face of the trench.
 - B. Spoils and equipment must be set back at least 2 feet from the edge of the trench and/or a retaining device must be installed.
7. Fall protection is required for walkways and bridges over trenches. Other fall protection may also be required.
8. Remotely located excavations shall be backfilled, covered, or barricaded (for example wells, pits, shafts, etc.)

Inspections must be made:

- A. Daily prior to starting work
- B. As needed throughout the shift by a competent person.
- C. After every rainstorm.
- D. After other hazard increasing occurrence (snowstorm, windstorm, thaw, earthquake, etc.).
- E. Inspect the trench for indications of possible cave-ins (fissures, tension cracks, sloughing, undercutting, water seepage, bulging at the bottom).
- F. Inspect adjacent areas (spoil piles, structures).
- G. To protective systems and their components (uprights, wales sheeting, shields hydraulics) before and after use.
- H. Check for indications of a hazardous or potentially hazardous atmosphere.
- I. Test the atmosphere if a hazard could reasonably be expected to exist.

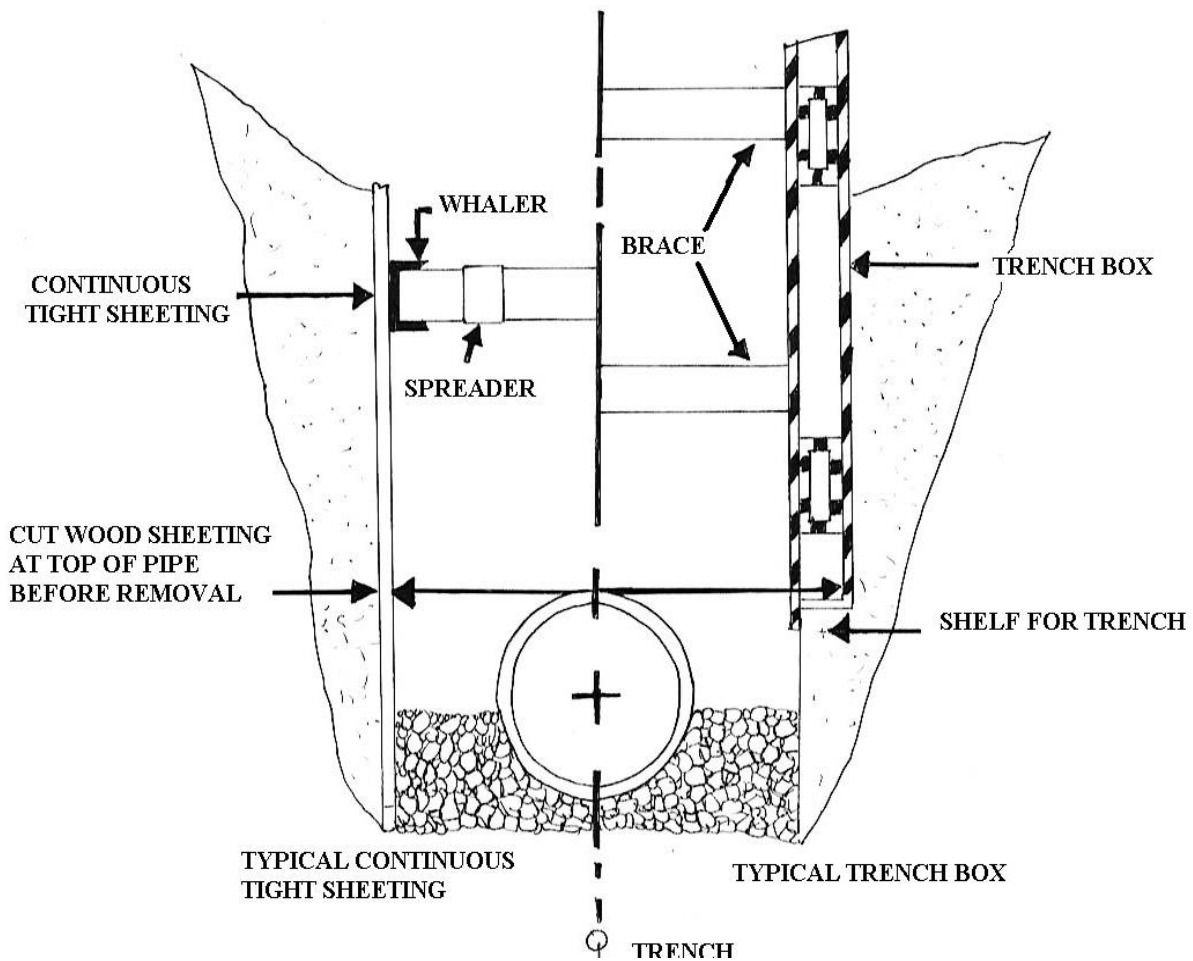

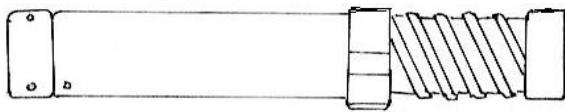

PNEUMATIC / HYDRAULIC JACKS

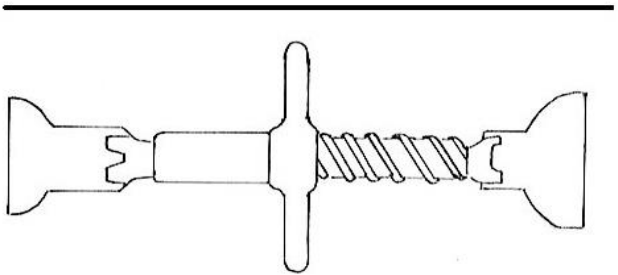
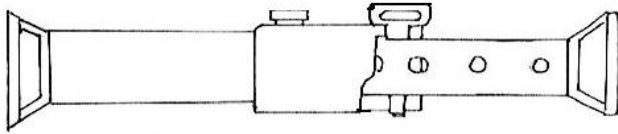

SCREW JACK

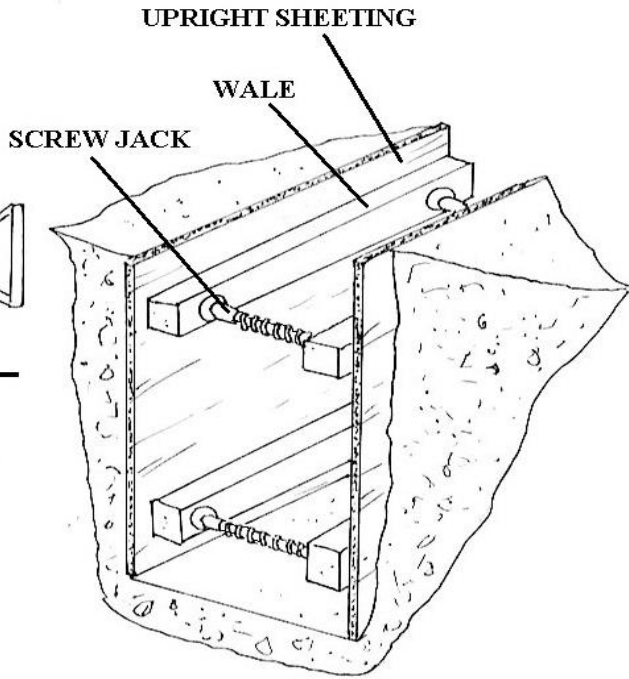

Soil Classification and Identification *(for Excavation Safety Only)*

The OSHA Standards define soil classifications within the Simplified Soil Classification Systems, which consist of four categories: Stable rock, Type A, Type B, and Type C. Stability is greatest in stable rock and decreases through Type A and B to Type C, which is the least stable. Appendix A of the standard provides soil mechanics terms and types of field tests used to determine soil classifications.

Stable rock is defined as natural solid mineral matter that can be excavated with vertical sides and remain intact while exposed.

Type A soil is defined as:

- Cohesive soils with an unconfined compressive strength of 1.5 tons per square foot (**TSF**) or greater.
- Cemented soils like caliche and hardpan are considered Type A.

Soil is NOT Type A if:

- It is fissured.
- The soil is subject to vibration from heavy traffic, pile driving or similar effects.
- The soil has been previously disturbed.
- The material is subject to other factors that would require it to be classified as a less stable material.
- The exclusions for Type A most generally eliminate it from most construction situations.

Type B soil is defined as:

- Cohesive soil with an unconfined compressive strength greater than .5 TSF, but less than 1.5 TSF.
- Granular cohesion-less soil including angular gravel, silt, silt loam, and sandy loam.
- The soil has been previously disturbed except that soil classified as Type C soil.
- Soil that meets the unconfined compressive strength requirements of Type A soil, but is fissured or subject to vibration.
- Dry rock that is unstable.

Type C soil is defined as:

- Cohesive soil with an unconfined compressive strength of .5 TSF or less.
- Granular soils including gravel, sand and loamy sand.
- Submerged soil or soil from which water is freely seeping.
- Submerged rock that is not stable.



Soil Test & Identification

The competent person will classify the soil type in accordance with the definitions in Appendix A based on at least one visual and one manual analysis. These tests should be run on freshly excavated samples from the excavation and are designed to determine stability based on a number of criteria: the cohesiveness, the presence of fissures, the presence and amount of water, the unconfined compressive strength, and the duration of exposure, undermining, and the presence of layering, prior excavation and vibration.

The cohesion tests are based on methods to determine the presence of clay. Clay, silt, and sand are size classifications, with clay being the smallest sized particles, silt intermediate and sand the largest.

Clay minerals exhibit good cohesion and plasticity (can be molded). Sand exhibits no elasticity and virtually no cohesion unless surface wetting is present. The degree of cohesiveness and plasticity depend on the amounts of all three types and water.

When examining the soil, three questions must be asked: Is the sample granular or cohesive? Is it fissured or non-fissured?

What is the unconfined compressive strength measured in TSF?

The competent person will perform several tests of the excavation to obtain consistent, supporting data along its depth and length. The soil is subject to change several times within the scope of an excavation and the moisture content will vary with weather and job conditions. The competent person must also determine the level of protection based on what conditions exist at the time of the test, and allow for changing conditions.



Ribbon Soil Test

Sloping

MAXIMUM ALLOWABLE SLOPES

<u>SOIL TYPE</u>	<u>SLOPE (H:V)</u>	<u>ANGLE(°)</u>
Stable Rock	Vertical	90°
Type A	3/4 : 1	53°
Type B	1 : 1	45°
Type C	1/2 : 1	34°

MAXIMUM ALLOWABLE SLOPE means the steepest incline of an excavation face that is acceptable for the most favorable site conditions as protection against cave-ins and is expressed as the ratio of horizontal distance to vertical rise (**H:V**).

The tables and configurations within Appendix B may be used to a maximum depth of twenty (20') feet deep. Jobs more than twenty (20') feet in depth require the design of a sloping plan by a registered professional engineer (**RPE**). If configurations are used for depths less than 20 feet other than those found in Appendix B, they must also be designed by a registered professional engineer.

Shielding

The third method of providing a safe workplace in excavations is shielding. Shielding is different from shoring and sloping in that it does not prevent cave-ins. Instead, it protects the operators in the event of a cave-in. Its function is therefore somewhat similar to that of a bomb shelter.

Shields are simply devices that, when placed in an excavation, have sufficient structural strength to support the force of a cave-in should one occur.

Shields take a number of different shapes and sizes. Most shields consist of two flat, parallel metal walls which are held apart by metal cross braces which are placed at the ends of the "Box" to allow for the installation of pipe within its interior dimensions. These boxes are used to greatest effect in what is known as "cut and cover" operations where a contractor excavates just enough trench to install the shield, then sets a joint of pipe, then excavates further, then pulls the shield forward to install another joint while the first is being backfilled. This method is extremely cost effective in that it is fast, safe, requires minimum excavation and minimum open trench. It has become the preferred method of laying pipe in most instances.

While original shields were quite large, smaller shields have gained in popularity with public works maintenance crews and contractors working in shallow excavations because of their ease of use.



Recently, round shields, made of corrugated metal have appeared. The sizes, shapes and possibilities for the applications of shields are endless. If they are to be used, however, several points must be borne in mind.

1. Shield construction is not covered by the standard. Users must rely on manufacturers' requirements. For this reason, it is critical that you know your supplier. Reputable manufacturers supply boxes designed by registered professional engineers, and the standard requires that they are certified for their applications. Do not make the mistake of having the neighborhood welder fabricate one. A user must know that their shield is appropriate for the situation.
2. Bent cross braces are not braces, they are hinges. Any bent or deformed structural member must be repaired or replaced according to the manufactures' guidelines.
3. The manufacturer must approve any modification to the shields.
4. Shields must be installed so as to prevent lateral movement in the event of a cave-in.
5. Shields may ride two feet above the bottom of an excavation, provided they are calculated to support the full depth of the excavation and there is no caving under or behind the shield.
6. Operators must enter and leave the shield in a protected manner, such as by ladder within the shield or a properly sloped ramp at the end.
7. Operators may not remain in the shield during its installation, removal or during vertical movement.
8. Do not forget about the open end of the shield if it exposes a wall of the excavation. The wall should be sloped, shored or shielded off to prevent a cave-in from the end.
9. If the excavation is deeper than the shield is tall, attached shields of the correct specifications may be used or the excavation may be sloped back to maximum allowable angle from a point 18 inches below the top of the shield.

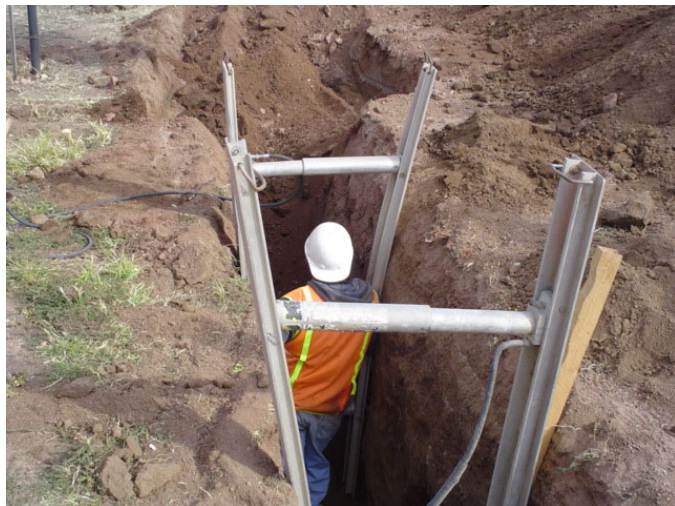

Complete Rule and further instructions are located in TLC's Competent Person Course.

Excavation Inspections

Daily inspection of excavations, the adjacent areas and protective systems shall be made by the competent person for evidence of a situation that could result in a cave-in, indications of failure of protective systems, hazardous atmospheres or other hazardous conditions.

- All inspections shall be conducted by the competent person prior to the start of work and as needed throughout the shift.
- Inspections will be made after every rainstorm or any other increasing hazard.
- All documented inspections will be kept on file in the jobsite safety files and forwarded to the Safety Director weekly.
- A copy of the **Daily Excavation Inspection** form is located at the end of this program.

The competent person(s) must be trained in accordance with the OSHA Excavation Standard, and all other programs that may apply (examples Hazard Communication, Confined Space, and Respiratory Protection), and must demonstrate a thorough understanding and knowledge of the programs and the hazards associated. All other employees working in and around the excavation must be trained in the recognition of hazards associated with trenching and excavating.





Two unsafe excavation examples: Top, notice the man in a 6-foot-deep trench with no ladder or shoring, and the placement of spoil. Bottom photograph, utilities are marked after the excavation has begun, no hard hats, no ladders, no protective system, incorrect spoil placement.



DAILY EXCAVATION CHECKLIST

Client		Date	
Project Name		Approx. Temp.	
Project Location		Approx. Wind Dir.	
Job Number		Safety Rep	
Excavation Depth & Width		Soil Classification	
Protective System Used			
Activities In Excavation			
Competent Person			

Excavation > 4 feet deep? ___ Yes ___ No

NOTE: Trenches over 4 feet in depth are considered excavations. Any items marked **NO** on this form **MUST** be remediated prior to any employees entering the excavation.

YES	NO	N/A	DESCRIPTION
GENERAL			
			Employees protected from cave-ins & loose rock/soil that could roll into the excavation
			Spoils, materials & equipment set back at least 2 feet from the edge of the excavation.
			Engineering designs for sheeting &/or manufacturer's data on trench box capabilities on site
			Adequate signs posted and barricades provided
			Training (toolbox meeting) conducted w/ employees prior to entering excavation
UTILITIES			
			Utility company contacted & given 24 hours' notice &/or utilities already located & marked
			Overhead lines located, noted and reviewed with the operator
			Utility locations reviewed with the operator, & precautions taken to ensure contact does not occur
			Utilities crossing the excavation supported, and protected from falling materials
			Underground installations protected, supported or removed when excavation is open
WET CONDITIONS			
			Precautions taken to protect employees from water accumulation (continuous dewatering)
			Surface water or runoff diverted /controlled to prevent accumulation in the excavation
			Inspection made after every rainstorm or other hazard increasing occurrence

HAZARDOUS ATMOSPHERES			
			Air in the excavation tested for oxygen deficiency, combustibles, other contaminants
			Ventilation used in atmospheres that are oxygen rich/deficient &/or contains hazardous substances
			Ventilation provided to keep LEL below 10 %
			Emergency equipment available where hazardous atmospheres could or do exist
			Safety harness and lifeline used
			Supplied air necessary (if yes, contact safety department)
ENTRY & EXIT			
			Exit (i.e. ladder, sloped wall) no further than 25 feet from ANY employee
			Ladders secured and extend 3 feet above the edge of the trench
			Wood ramps constructed of uniform material thickness, cleated together @ the bottom
			Employees protected from cave-ins when entering or exiting the excavation

Explain how you have secured the site and made it safe to work inside (if possible)

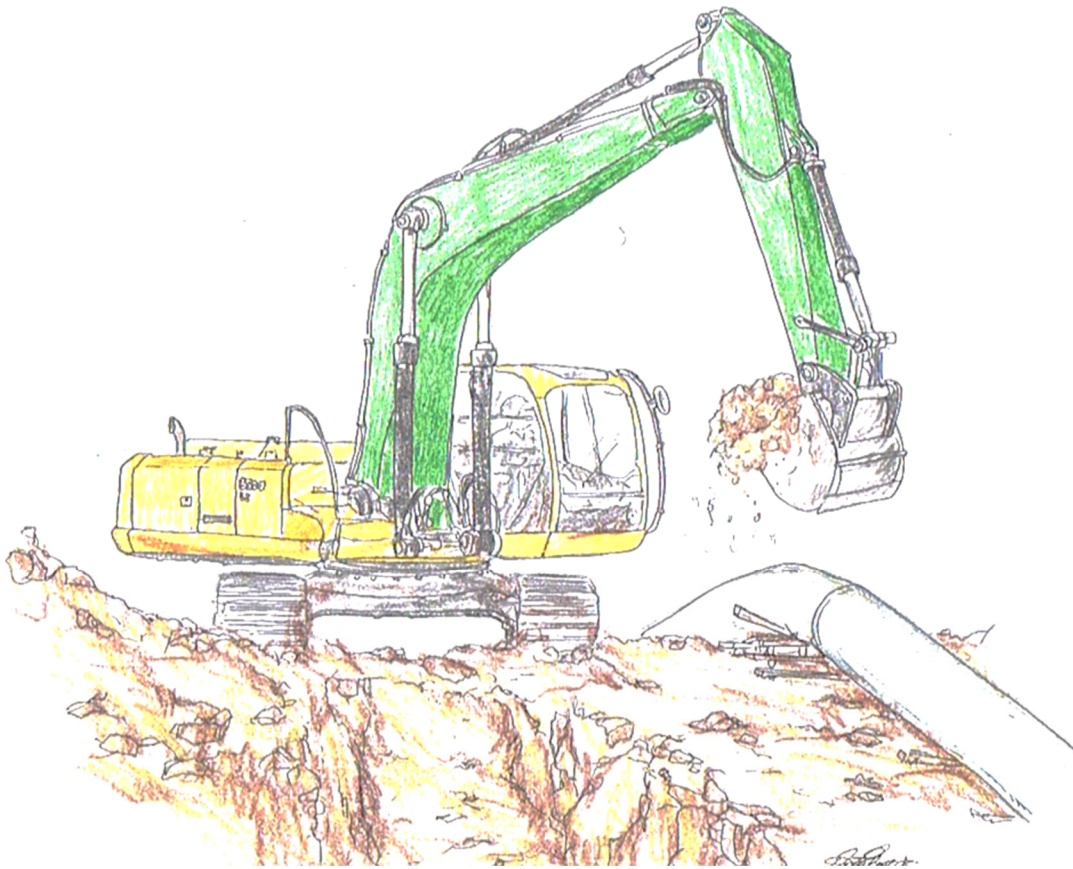

One-Call Center or Bluestakes

You are required to locate or call for proper buried utility locations before you dig or excavate. You will usually need a 48-hour notice before you excavate. Please check with your local one-call system.



Red spray marks represents - Electricity,
Yellow represents-Gas, Blue represents-Water



Orange spray marks represents - Telephone & Fiber Optics

One Call Program

According to federal safety statistics, damage from unauthorized digging is the major cause of natural gas pipeline failures. To prevent excavation damage to all utilities, including pipelines, all 50 states have instituted "One Call" Programs. The programs provide telephone numbers for excavation contractors to call before excavation begins.

The one-call operator will notify a pipeline company of any planned excavation in the vicinity of its pipeline so that the company can flag the location of the pipeline and assign personnel to be present during excavation, if necessary.

In a related effort, a joint government-industry team has developed a public education program entitled "*Dig Safely*". The team involved representatives from the U.S. Department of Transportation, gas and liquid pipeline companies, distribution companies, excavators, the insurance industry, one-call systems and the telecommunications industry. This campaign provides information to the general public concerning underground utilities and the danger of unknowingly digging into buried lines and cables.

The program has posters, brochures, and other printed materials available for use by interested organizations. For more information, contact www.digsafely.com.



Telephone Cables, nasty to dig around. It's almost as bad as electric lines.

Natural Gas Safety

That familiar blue flame that plays such an important role in our lives should, like other sources of energy, be treated with respect. Following a few simple guidelines can help ensure that you can safely enjoy all the benefits natural gas has to offer.

Natural gas is colorless and invisible. When it burns it should appear as a clear, blue flame. Because natural gas has no odor, a special chemical called mercaptan is added to make it easy to detect gas leaks from pipes or appliances. This odor is commonly described as a rotten-egg smell.

Natural gas is clean-burning. When burned completely, it produces only water vapor and carbon dioxide, just as you do when you breathe. Natural gas is such a safe and dependable fuel that it's easy to take for granted. But please, never take safety for granted. As with any source of energy, you should follow certain safety measures when using natural gas.

When it's taken from the ground, natural gas is tasteless, colorless and odorless. To make it easier to detect, a harmless but strong-smelling odorant is added, Ethyl Mercaptan. If you ever smell this "**rotten egg-like**" odor, it may mean there is a gas leak.

WHAT TO DO IF YOU SMELL GAS:

- Do not smoke. Do not use lighters or matches.
- Do not turn on/off any switches or appliances.
- Our personnel are available 24 hours a day to respond to any emergency call.

Carbon Monoxide

Carbon monoxide is produced when burning any fuel incompletely, such as charcoal, gasoline or wood. Carbon monoxide is highly poisonous and it has no odor, taste or color. If natural gas equipment is not maintained, adjusted and operated properly, it could produce carbon monoxide.

Your natural gas appliances should produce a clear, steady blue flame. If your gas appliances exhibit an unusual behavior or produce a yellowish-color flame, that may be a warning sign that your appliance is producing carbon monoxide.

A licensed professional should inspect appliances annually to insure safe operation. An inspection will accomplish the following:

- Make sure the appliance is installed properly and that it is in good working condition.
- Ensure that there is enough fresh air circulating for the fuel to burn properly.
- Check that vents are in good condition and are not blocked with debris.

Other helpful tips:

- The area surrounding your gas appliances should be clear from clutter or trash.
- Carbon monoxide detectors may be helpful in your home or business. But remember, a carbon monoxide detector should never be substituted for using equipment safely - which includes having your heating and cooking equipment inspected once a year by a trained professional.



OSHA's General Industry Regulation, §1910.146 Permit-required confined spaces, contains requirements for practices and procedures to protect employees in general industry from the hazards of entry into permit-required confined spaces. This regulation does not apply to construction.

OSHA's Construction Safety and Health Regulations Part 1926 do not contain a permit-required confined space regulation. Subpart C, §1926.21 Safety training and education specifies training for personnel who are required to enter confined spaces and defines a "*confined or enclosed space*."

Safety Section Glossary

Barricades: Visible warning barriers that keep vehicles and pedestrians from entering a construction site.

Braces: Devices that hold or fasten two or more parts together or in place. Braces are diagonal or horizontal. They may be made of wood or metal.

Bracing System: A system of braces which applies pressure against trench walls to stabilize them. A bracing system is part of a trench shoring system used to prevent trench walls from collapsing.

Benching: A method of cutting back the sides of a trench into horizontal steps to prevent cave-ins.

Bulge: An outward swelling in the soil of a trench; may be a warning sign of trench failure.

Buried Structures: Manholes, junction boxes or catch basins beneath the ground or any other installations that may be encountered during trenching.

Clay: Fine-grained natural soil that is plastic when moist and hard and brittle when dry. Clay is made up of particles smaller than .0002 millimeters.

Clumps: Heavy lumps or thick groupings of soil.

Cohesion: The relative ability to clump together, the force holding two like substances together.

Cohesive: When a soil has grains that hold together and clump well.

Competent Person: One who is capable of identifying existing, and predictable hazards in the surroundings, or working conditions which are unsanitary, hazardous or dangerous to employees. They have the authorization to take prompt corrective measures to eliminate hazards. The Competent Person is trained and knowledgeable about soil analysis and the use of protective systems.

Confined Space: Has limited or restricted means of entry or exit, is large enough for an employee to enter and perform assigned work, and is not designed for continuous occupancy by the employee. These spaces may include, but are not limited to, underground vaults, tanks, storage bins, pits, and diked areas, vessels, and silos.

Diversion Ditches: A ditch cut around the work site to keep water from entering the trench.

Drainage System: Pumps, pipe or channel used to drain off rain or groundwater from inside the trench.

Excavation: Any man-made cut, cavity trench or depression in an earth surface, formed by earth removal.

Fissure: A long narrow opening or crack in the rock or soil. Fissures are often a sign of trench wall failure.

Grain: Particles that once were large rocks, but have been broken down through time and the effects of weathering. The size of the grain of a soil determines the stability and cohesiveness of a soil. The larger the grain is, the more unstable the soil is.

Gravel: A loose mixture of pebbles and rock fragments, which is coarser than sand.

Hardpan: A layer of hard subsoil or clay that does not allow water in. Hardpan is classified as a Type A soil.

Heaving: The swelling of a soil.

Jacks: Jacks are braces or supports within a shoring system. They are placed against beams to resist the pressure of the earth.

Loamy Sand: Soil composed of a mixture of sand, clay and silt, with more sand grains than clay or silt. It is classified as a Type C soil.

Manufacturer's Tabulated Data: Tables and charts approved by a registered professional engineer and used to design and construct a protective system.

Permit Required Confined Space: Meets the definition of a confined space and has one or more of these characteristics: (1) contains or has potential to contain a hazardous atmosphere, (2) contains a material that has the potential for engulfing an entrant, (3) has an internal configuration that might cause an entrant to be trapped or asphyxiated by inwardly converging walls or by a floor that slopes downward and tapers to a smaller cross section, and/or (4) contains any other recognized serious safety or health hazards.

Personal Protective Equipment: Safety goggles and glasses, reflective clothing, work gloves, hard hat, safety shoes, rubber boots, earplugs or protectors, face shield and face mask or respirator.

Registered Professional Engineer: A person who is registered as a professional engineer in the state where the work is to be performed.

Sand: A type C soil with small, loose grains of disintegrated rock.

Sandy Loam; Granular soil with enough silt and clay to make it slightly cohesive

Saturation: The process of a soil being filled to capacity with moisture.

Shear: A phenomenon which happens when a trench wall is subjected to stress. Fissured cracks widen until a portion of the trench wall breaks off and slides into the trench.

Sheeting: Durable sheets of metal or wood, which are held firmly against a trench wall to prevent it from caving-in. Sheeting is a component of a trench shoring system.

Shielding: A device which provides adequate protection from falling or collapsing earth loads. The trench box is a common form of shielding.

Shoring: Main method of stabilizing and supporting a trench wall to prevent cave-ins. It consists of uprights, stingers and braces.

Silt: A soil which contains fine particles and is very smooth.

Silty Clay: A plastic soil that will appear rough or broken when rubbed over the thumb and finger.

Sloping: The process of cutting back the sides of a trench to avoid a cave-in.

Sloughing: When loose soil begins to run in from the lower part of the wall into the excavation. It is the first step to a wall collapse.

Soil Type: A system of classifying soils and rock deposits. Soil must be classified by a qualified person as: Stable rock, Type-A, Type-B, Type-C.

Spall: When a soil begins to crack or flake due to pressure, or from moisture from within the trench.

Spoil Pile/Spoilage: Rock waste, banks and dumps from the excavation.

Supports: Part of a shoring system which helps to bear the weight of braces and other parts of the shoring system.

Trench Box: A prefabricated moveable box usually constructed of metal plates welded to a heavy steel frame. The box is moved along as work progresses. It is able to withstand the forces imposed on it by a cave-in and thereby protects trench workers.

Type-A Soil: The most stable and cohesive type of soil while working at a trench site. Examples are clay, silty clay and hardpan.

Type-B Soil: Type-B soil is next to the most stable soil. Silt, silt loam, sandy loam, medium clay and unstable rock would be good examples of Type-B soils.

Type-C Soil: The least stable type of soil. Examples of Type-C soils are gravel, loamy sand, soft clay, submerged silt and heavy unstable rock.

Unconfined Compressive Strength: Through a variety of tests, a soil's strength is found. The unconfined compressive strength is the soil's measure of bearing capacity and shearing resistance. Measured as the amount of weight per square foot needed to collapse a soil sample.

Uprights: Vertical members of a trench shoring system placed in contact with the earth. These members usually are not placed in direct contact with one another.

Vibration: When a soil or excavation site trembles and shakes rapidly due to forces such as loud noises or heavy equipment or traffic.

Voids: Voids are empty spaces between particles of rocks.

Wales: Wales are parts of a shoring system. They are positioned horizontally and help to brace vertical beams and supports. Wales can be fastened to studs with nails, clips or brackets.

Wall Stability: The relative strength and capacity of walls of a trench.



Provide at least one attendant outside the permit space into which entry is authorized for the duration of entry operations;

NOTE: Attendants may be assigned to monitor more than one permit space provided the duties described in paragraph (i) of this section can be effectively performed for each permit space that is monitored. Likewise, attendants may be stationed at any location outside the permit space to be monitored as long as the duties described in paragraph (i) of this section can be effectively performed for each permit space that is monitored.

Safety References

National Institute for Occupational Safety and Health, Criteria for a Recommended Standard, Working in Confined Spaces. DHEW (NIOSH) Publication No. 80-106, December 1979.

National Institute for Occupational Safety and Health, Criteria for a Recommended Standard, Occupational Exposure to Carbon Monoxide, HSM Publication 73-11000, 1972.

Golden, F. Hypothermia: A Problem for North Sea Industries, J. Soc. Occup. Med. 1976; 26:85-88.

National Institute for Occupational Safety and Health, Alert - Request for Assistance in Preventing Occupational Fatalities in Confined Spaces. DHHS (NIOSH) Publication No. 86-110, January, 1986.

National Institute for Occupational Safety and Health, A Guide to Safety in Confined Spaces. DHHS (NIOSH) Publication No. 87-113, July, 1987.

National Institute for Occupational Safety and Health, Guide to Industrial Respiratory Protection. DHHS (NIOSH) Publication 87-116, September, 1987.

American National Standards Institute, Inc. (ANSI), Safety Requirements for Confined Spaces, ANSI Z117.1-1989.

National Fire Protection Association (NFPA), Fire Department Self-Contained Breathing Apparatus Program, NFPA 1404, 3-1, 1989.

National Fire Protection Association, (NFPA), Fire Department Occupational Safety and Health Program, NFPA 1500, 3-1, 1987.

Safety Section Post Quiz

Confined space:

1. A confined space is large enough or so configured that an employee can _____.
2. A confined space has limited or restricted means for _____.
3. A permit required confined space (permit space) contains a material that has _____.
4. A permit required confined space (permit space) contains any other recognized serious safety or _____.
5. A permit required confined space (permit space) has an internal configuration such that _____ could be trapped or asphyxiated by inwardly converging walls or by a floor which slopes downward and tapers to a smaller cross-section.

Confined Space Hazards

6. Fatalities and injuries constantly occur among construction workers who are required to enter _____.
7. Workers encounter both inherent and _____ within confined workspaces.

Inherent Hazards

8. Inherent hazards include high voltage, radiation generated by equipment, _____, omission of protective features, high or low temperatures, high noise levels, and high-pressure vessels and lines.

Induced Hazards

9. _____ result from a multitude of incorrect decisions and actions that occur during the actual construction process.

10. Some examples of induced hazards are: omission of protective features, physical arrangements that may cause unintentional worker contact with electrical energy sources, oxygen-deficient atmospheres created at the bottom of pits or shafts, lack of safety factors in structural strength, and _____.

Typical Examples of Confined Workspaces

11. Confined workspaces in construction contain _____.

Vaults

12. Workers must enter _____ found on the construction jobsite to perform a number of functions.

Oxygen-Deficient Atmosphere

13. The ever-present possibility of _____ is one of the major problems confronting construction workers while working in vaults.

Electrical Shock

14. _____ results because the contractor has not provided an approved grounding system or the protection afforded by ground-fault circuit interrupters or low-voltage systems.

Manholes

15. Manholes are necessary to provide a means of entry into and exit from vaults, tanks, and pits, but these confined spaces may present _____ which could cause injuries and fatalities.

Post Quiz Answers

Topic 1- Groundwater Production Post Quiz Answers

1. Aquifer, 2. Water table, 3. Unsaturated zone, 4. Groundwater, 5. True, 6. True, 7. Groundwater, 8. True, 9. Cone of depression, 10. Drawdown, 11. An unconfined aquifer, 12. Water bearer, 13. Confined aquifer, 14. False, 15. True, 16. Unavoidable loss, 17. False, 18. False

Topic 2 - Pumps and Motors Section Answers

1. Mechanical seal, 2. Kinetic energy, 3. Leak-off, 4. Hydraulics, 5. Head, 6. Delivery force, 7. Head, 8. True, 9. Displacement, 10. Cylindrical pump housing, 11. False, 12. False, 13. Impeller blade(s), 14. Impeller blade(s), 15. True, 16. False,

Topic 3- Distribution Operation and Maintenance Section Post Quiz Answers

1. True, 2. Decreases in size, 3. False, 4. Friction Loss, 5. Surge tanks, 6. Stored energy, 7. Storage facilities, 8. Fire protection, 9. Baffles, 10. Chlorine residual, 11. Water Quality, 12. False, 13. Gravity, 14. True, 15. False, 16. True

Topic 4- Cross-Connection/Backflow Prevention Section Post Quiz Answers

1. Backflow Condition, 2. Backflow or Cross-Connection Failure, 3. Backflow, 4. Reverse, 5. Service or supply side, 6. A cross-connection, 7. Least 12 inches, 8. Cross-connection, 9. Backsiphonage, 10. Cross-connection, 11. Vacuum breaker, 12. Backsiphonage, 13. Backpressure, 14. Backflow, 15. Backflow preventer, 16. Air gap

Topic 5- Water Quality Post Quiz Answers

1. Total Dissolved Solids, 2. Ethylenediaminetetraacetic acid (EDTA), 3. Radon gas, 4. Arsenic, 5. Arsenic, 6. True, 7. True, 8. The Stage 2 DBP rule, 9. The Stage 2 DBP rule, 10. Cryptosporidium, 11. The Stage 2 DBPR, 12. The Stage 2 DBPR, 13. Stage 2 DBPR

Topic 6- Bacteria Monitoring Post Quiz Answers

1. False, 2. False, 3. True, 4. False, 5. False, 6. True, 7. True, 8. True, 9. True, 10. False

Topic 7 -Advanced Treatment Section Post Quiz Answers

1. Nollet, 2. A membrane, 3. True, 4. False, 5. Microfiltration (MF), 6. False, 7. Ultrafiltration (UF), 8. Nanofiltration (NF), 9. Chloride and sodium, 10. Cold sterilization, 11. Permeate, 12. Fouling

Topic 8- Disinfection Section Post Quiz Answers

1. Use a new, approved gasket on the connector, 2. 1/4 turn to unseat the valve, then open one complete turn, 3. The cylinder may rupture, 4. 1.5 -2.5, 5. Scrubbers, 6. Gas chlorine, 7. Secure each cylinder in an upright position. Attach the protective bonnet over the valve. Firmly secure each cylinder, 8. Open chlorine metering orifice slightly. Inspect vacuum lines. Start injector water supply, 9. In addition to protective clothing and goggles, chlorine gas should be used only in a well-ventilated area so that any leaking gas cannot concentrate, 10. Chlorine gas forms a mixture of hydrochloric and hypochlorous acids, 11. Because it is too easy to roll, 12. A yellowish green, nonflammable and liquefied gas with an unpleasant and irritating smell. Can be readily compressed into a clear, amber colored liquid, a noncombustible gas, and a strong oxidizer. Chlorine is about 1.5 times heavier than water and gaseous chlorine is about 2.5 times heavier than air, 13. Notify local emergency response team. Warn and evacuate people in adjacent areas, be sure that no one enters the leak area

without adequate self-contained breathing equipment, 14. Burning of eyes, nose, and mouth; lacrimation and rhinorrhea; Coughing, sneezing, choking, nausea and vomiting; headaches and dizziness; Fatal pulmonary edema; pneumonia; conjunctivitis; keratitis; pharyngitis; burning chest pain; dyspnea; hemoptysis; hypoxemia; dermatitis; and skin blisters, 15. 646 mg/L, 16. Get out of the area of the leak, proceeding upwind, and 2) take only very short breaths through the mouth, 17. 0.195 or also written 19.5%, 18. True, 19. True, 20. True, 21. HOCl and OCl⁻; free available chlorine

Topic 9- Safety Section Post Quiz

1. Bodily enter and perform work, 2. Entry or exit, 3. The potential for engulfing an entrant, 4. Health hazard, 5. An entrant, 6. Confined spaces, 7. Induced hazards, 8. Defective design, 9. Induced hazards, 10. Flammable atmospheres, 11. Both inherent and induced hazards, 12. A variety of vaults, 13. An oxygen-deficient atmosphere, 14. Electrical shock, 15. Serious hazards

Math Conversion Factors

1 PSI = 2.31 Feet of Water
 1 Foot of Water = .433 PSI
 1.13 Feet of Water = 1 Inch of Mercury
 454 Grams = 1 Pound
 2.54 CM = Inch
 1 Gallon of Water = 8.34 Pounds
 1 mg/L = 1 PPM
 17.1 mg/L = 1 Grain/Gallon
 1% = 10,000 mg/L
 694 Gallons per Minute = MGD
 1.55 Cubic Feet per Second = 1 MGD
 60 Seconds = 1 Minute
 1440 Minutes = 1 Day
 .746 kW = 1 Horsepower

LENGTH

12 Inches = 1 Foot
 3 Feet = 1 Yard
 5280 Feet = 1 Mile

AREA

144 Square Inches = 1 Square Foot
 43,560 Square Feet = 1 Acre

VOLUME

1000 Milliliters = 1 Liter
 3.785 Liters = 1 Gallon
 231 Cubic Inches = 1 Gallon
 7.48 Gallons = 1 Cubic Foot of water
 62.38 Pounds = 1 Cubic Foot of water

Dimensions

SQUARE: Area (sq. ft.) = Length X Width
 Volume (cu.ft.) = Length (ft) X Width (ft) X Height (ft)

CIRCLE: Area (sq. ft.) = 3.14 X Radius (ft) X Radius (ft)

CYLINDER: Volume (Cu. ft) = 3.14 X Radius (ft) X Radius (ft) X Depth (ft)

PIPE VOLUME: .785 X Diameter ² X Length = ? To obtain gallons multiply by 7.48

SPHERE: $\frac{(3.14) (\text{Diameter})^3}{(6)}$ Circumference = 3.14 X Diameter

General Conversions

Flowrate

Multiply	→	to get
to get	←	Divide
cc/min	1	mL/min
cfm (ft ³ /min)	28.31	L/min
cfm (ft ³ /min)	1.699	m ³ /hr
cfh (ft ³ /hr)	472	mL/min
cfh (ft ³ /hr)	0.125	GPM
GPH	63.1	mL/min
GPH	0.134	cfh
GPM	0.227	m ³ /hr
GPM	3.785	L/min
oz./min	29.57	mL/min

POUNDS PER DAY = Concentration (mg/L) X Flow (MG) X 8.34

A.K.A. Solids Applied Formula = Flow X Dose X 8.34

$$\text{PERCENT EFFICIENCY} = \frac{\text{In} - \text{Out}}{\text{In}} \times 100$$

$$\begin{aligned} \text{TEMPERATURE: } \quad {}^{\circ}\text{F} &= ({}^{\circ}\text{C} \times 9/5) + 32 & 9/5 &= 1.8 \\ {}^{\circ}\text{C} &= ({}^{\circ}\text{F} - 32) \times 5/9 & 5/9 &= .555 \end{aligned}$$

$$\text{CONCENTRATION: } \text{Conc. (A)} \times \text{Volume (A)} = \text{Conc. (B)} \times \text{Volume (B)}$$

$$\text{FLOW RATE (Q): } Q = A \times V \text{ (Quantity = Area X Velocity)}$$

$$\text{FLOW RATE (gpm): } \text{Flow Rate (gpm)} = \frac{2.83 (\text{Diameter, in})^2 (\text{Distance, in})}{\text{Height, in}}$$

$$\% \text{ SLOPE} = \frac{\text{Rise (feet)}}{\text{Run (feet)}} \times 100$$

$$\text{ACTUAL LEAKAGE} = \frac{\text{Leak Rate (GPD)}}{\text{Length (mi.)} \times \text{Diameter (in)}}$$

$$\text{VELOCITY} = \frac{\text{Distance (ft)}}{\text{Time (Sec)}}$$

N = Manning's Coefficient of Roughness

R = Hydraulic Radius (ft.)

S = Slope of Sewer (ft/ft.)

$$\text{HYDRAULIC RADIUS (ft)} = \frac{\text{Cross Sectional Area of Flow (ft)}}{\text{Wetted pipe Perimeter (ft)}}$$

$$\text{WATER HORSEPOWER} = \frac{\text{Flow (gpm)} \times \text{Head (ft)}}{3960}$$

$$\text{BRAKE HORSEPOWER} = \frac{\text{Flow (gpm)} \times \text{Head (ft)}}{3960 \times \text{Pump Efficiency}}$$

$$\text{MOTOR HORSEPOWER} = \frac{\text{Flow (gpm)} \times \text{Head (ft)}}{3960 \times \text{Pump Eff.} \times \text{Motor Eff.}}$$

$$\text{MEAN OR AVERAGE} = \frac{\text{Sum of the Values}}{\text{Number of Values}}$$

$$\text{TOTAL HEAD (ft)} = \text{Suction Lift (ft)} \times \text{Discharge Head (ft)}$$

$$\text{SURFACE LOADING RATE} = \frac{\text{Flow Rate (gpm)}}{\text{Surface Area (sq. ft)}} \text{ (gal/min/sq. ft)}$$

$$\text{MIXTURE STRENGTH (\%)} = \frac{(\text{Volume 1, gal}) (\text{Strength 1, \%}) + (\text{Volume 2, gal}) (\text{Strength 2, \%})}{(\text{Volume 1, gal}) + (\text{Volume 2, gal})}$$

$$\text{INJURY FREQUENCY RATE} = \frac{(\text{Number of Injuries}) \times 1,000,000}{\text{Number of hours worked per year}}$$

$$\text{DETENTION TIME (hrs)} = \frac{\text{Volume of Basin (gals)} \times 24 \text{ hrs}}{\text{Flow (GPD)}}$$

$$\text{SLOPE} = \frac{\text{Rise (ft)}}{\text{Run (ft)}}$$

$$\text{SLOPE (\%)} = \frac{\text{Rise (ft)} \times 100}{\text{Run (ft)}}$$

POPULATION EQUIVALENT (PE):

- 1 PE = .17 Pounds of BOD per Day
- 1 PE = .20 Pounds of Solids per Day
- 1 PE = 100 Gallons per Day

$$\text{LEAKAGE (GPD/inch)} = \frac{\text{Leakage of Water per Day (GPD)}}{\text{Sewer Diameter (inch)}}$$

$$\text{CHLORINE DEMAND (mg/L)} = \text{Chlorine Dose (mg/L)} - \text{Chlorine Residual (mg/L)}$$

MANNING FORMULA

τQ = Allowable time for decrease in pressure from 3.5 PSI to 2.5 PSI

τq = As below

$$\tau Q = (0.022) (d_1^2 L_1) / Q \quad \tau q = \frac{[0.085] [(d_1^2 L_1)]}{q}$$

Q = 2.0 cfm air loss

θ = .0030 cfm air loss per square foot of internal pipe surface

δ = Pipe diameter (inches)

L = Pipe Length (feet)

$$V = \frac{1.486}{v} R^{2/3} S^{1/2}$$

V = Velocity (ft./sec.)

v = Pipe Roughness

R = Hydraulic Radius (ft)

S = Slope (ft/ft)

$$\text{HYDRAULIC RADIUS (ft)} = \frac{\text{Flow Area (ft. }^2\text{)}}{\text{Wetted Perimeter (ft.)}}$$

$$\text{WIDTH OF TRENCH (ft)} = \text{Base (ft)} + (2 \text{ Sides}) \times \frac{\text{Depth (ft }^2\text{)}}{\text{Slope}}$$

Conversion Factors

1 acre = 43,560 square feet

1 cubic foot = 7.48 gallons

1 foot = 0.305 meters

1 gallon = 3.785 liters

1 gallon = 8.34 pounds

1 grain per gallon = 17.1 mg/L

1 horsepower = 0.746 kilowatts

1 million gallons per day = 694.45 gallons per minute

1 pound = 0.454 kilograms

1 pound per square inch = 2.31 feet of water

1% = 10,000 mg/L

Degrees Celsius = (Degrees Fahrenheit - 32) (5/9)

Degrees Fahrenheit = (Degrees Celsius * 9/5) + 32

64.7 grains = 1 cubic foot

1,000 meters = 1 kilometer

1,000 grams = 1 kilogram

REFERENCES

- "Alchemy", entry in *The Oxford English Dictionary*, J. A. Simpson and E. S. C. Weiner, vol. 1, 2nd ed., 1989, ISBN 0-19-861213-3.
- "Ancients & Alchemists - Time line of achievement". Chemical Heritage Society.
- "Arabic alchemy", Georges C. Anawati, pp. 853–885 in *Encyclopedia of the history of Arabic science*, eds. Roshdi Rashed and Régis Morelon, London: Routledge, 1996, vol. 3, ISBN 0-415-12412-3.
- "California Occupational Guide Number 22: Chemists". Calmis.ca.gov. 1999-10-29.
- "Carlsberg Group Company History Page". Carlsberggroup.com.
- "Chemical bonding". *Britannica. Encyclopædia Britannica*.
- "Chemistry". Chemistry2011.org.
- "General Chemistry Online - Companion Notes: Matter". Antoine.frostburg.edu.
- "History - Robert Boyle (1627–1691)".
- "History of Acidity". Bbc.co.uk.
- "History of Alchemy". Alchemy Lab.
- "International Year of Chemistry - The History of Chemistry". G.I.T. Laboratory Journal Europe.
- "IUPAC Nomenclature of Organic Chemistry". Acdlabs.com.
- "Official SI Unit definitions". Bipm.org.
- "Robert Boyle, Founder of Modern Chemistry" Harry Sootin (2011).
- "The Lewis Acid-Base Concept". Apsidium.
- "What is Chemistry?". Chemweb.ucc.ie.
- ACGIH [1991]. *Documentation of the threshold limit values and biological exposure indices*. 6th ed. Cincinnati, OH: American Conference of Governmental Industrial Hygienists.
- ACGIH [1994]. *1994-1995 Threshold limit values for chemical substances and physical agents and biological exposure indices*. Cincinnati, OH: American Conference of Governmental Industrial Hygienists.
- Armstrong, James (2012). *General, Organic, and Biochemistry: An Applied Approach*. Brooks/Cole. p. 48. ISBN 978-0-534-49349-3.
- Atkins & de Paula 2009, p. 9.
- Atkins, Peter; de Paula, Julio (2009) [1992]. *Elements of Physical Chemistry (5th Ed.)*. New York: Oxford University Press. ISBN 978-0-19-922672-6.
- ATS [1987]. *Standardization of spirometry -- 1987 update*. American Thoracic Society. *Am Rev Respir* Barnes, Ruth. *Textiles in Indian Ocean Societies*. Routledge. p. 1.
- Basic Principles of Water Treatment*, Littleton, Colorado. Tall Oaks Publishing Inc.
- Bates, Roger G. *Determination of pH: theory and practice*. Wiley, 1973.
- Benenson, Abram S., editor. 1990. *Control of Communicable Diseases in Man*. 15th ed. Baltimore: Victor Graphics, Inc.
- Bick, H. 1972. *Ciliated protozoa. An illustrated guide to the species used as biological indicators in freshwater biology*. World Health Organization, Geneva. 198 pp.
- Bick, H. 1972. *Ciliated protozoa. An illustrated guide to the species used as biological indicators in freshwater biology*. World Health Organization, Geneva. 198 pp.
- Bickford, T.M., Lindsey, B.D., and Beaver, M.R., 1996, *Bacteriological quality of groundwater used for*
- Bisson, J.W. and Cabelli, V.J., 1980, *Clostridium perfringens as a water pollution indicator: Journal of the Water Pollution Control Federation*, v. 52, no. 2, p. 241-248.
- Born, Stephen M., Douglas A. Yanggen, and Alexander Zaporozec. *A Guide to Groundwater Quality Planning and Management for Local Governments*. Wisconsin Geological and Natural History Survey, Madison, WI, 1987.
- Born, Stephen M., Douglas A. Yanggen, and Alexander Zaporozec. *A Guide to Groundwater Quality Planning and Management for Local Governments*. Wisconsin Geological and Natural History Survey, Madison, WI, 1987.
- Boyle, Robert (1661). *The Sceptical Chymist*. New York: Dover Publications, Inc. (reprint). ISBN 0-486-42825-7.
- Brenner, K.P., Rankin, C.C., Roybal, Y.R., Stelma, G.R., Scarpino, P.V., and Dufour, A.P., 1993, *New medium for simultaneous detection of total coliforms and Escherichia coli in water: Applied and Environmental Microbiology*, v. 59, no. 11, p. 3534-3544.

Britton, L.J., and Greeson, P.E., ed., 1989, *Methods for collection and analysis of aquatic biological and microbiological samples: U.S. Geological Survey Techniques of Water-Resources Investigations*, book 5, chap. A4, 363 p.

Brooks, D., and Cech, I., 1979, *Nitrates and bacterial distribution in rural domestic water supplies: Water Bunge*, M. (1982). "Is chemistry a branch of physics?" *Journal for the General Philosophy of Science - Zeitschrift für allgemeine Wissenschaftstheorie* **13** (2): 209–223. doi:10.1007/BF01801556.

Burrows et al. 2008, p. 12. p. 13, p. 16, p. 110.

Burrows, Andrew; Holman, John; Parsons, Andrew; Pilling, Gwen; Price, Gareth (2009). *Chemistry³. Italy: Oxford University Press. ISBN 978-0-19-927789-6.*

Butterworth, B.E., Kedderis, G.L., and Conolly, R.B. (1998) *The chloroform risk assessment: A mirror of scientific understanding. CIIT Activities*, 18 no.4.

Cabelli, V.J., 1981, *Health effects criteria for marine recreational waters: Cincinnati, Ohio, U.S. Environmental Protection Agency, EPA-600/1-80-031.*

Cairns, J., and J.A. Ruthven. 1972. A test of the cosmopolitan distribution of fresh-water protozoans. *Hydrobiologia* 39:405-427.

Cairns, J., and W.H. Yongue. 1977. Factors affecting the number of species of freshwater protozoan communities. Pages 257-303 in J. Cairns, ed. *Aquatic microbial communities*. Garland, New York.

Cairns, J., G.R. Lanza, and B.C. Parker. 1972. Pollution related structural and functional changes in aquatic communities with emphasis on freshwater algae and protozoa. *Proceedings of the National Academy of Sciences* 124:79-127.

CFR. Code of Federal regulations. Washington, DC: U.S. Government Printing Office, Office of the Federal Register.

Chang, Raymond (1998). *Chemistry, 6th Ed.* New York: McGraw Hill. ISBN 0-07-115221-0.

Changing States of Matter - Chemforkids.com.

Chemical Reaction Equation- IUPAC Goldbook.

Chemistry is seen as occupying an intermediate position in a hierarchy of the sciences by reductive level between physics and biology. Carsten Reinhardt. *Chemical Sciences in the 20th Century: Bridging Boundaries*. Wiley-VCH, 2001. ISBN 3-527-30271-9. Pages 1–2.

Chemistry. (n.d.). Merriam-Webster's Medical Dictionary.

Christian, M.S., York, R.G., Hoberman, A.M., Diener, R.M., and Fisher, L.C. (2001b). Oral (drinking water) developmental toxicity studies of bromodichloromethane (BDCM) in rats and rabbits. *International Journal of Toxicology*, 20, 225-237.

Christian, M.S., York, R.G., Hoberman, A.M., Diener, R.M., Fisher, L.C., and Gates, G.A. (2001a). Biodisposition of dibromoacetic acid (DBA) and bromodichloromethane (BDCM) administered to rats and rabbits in drinking water during range-finding reproduction and developmental toxicity studies. *International Journal of Toxicology*, 20, 239-253.

Christian, M.S., York, R.G., Hoberman, A.M., Fisher, L.C., and Brown, W.R. (2002a). Oral (drinking water) two-generation reproductive toxicity study of bromodichloromethane (BDCM) in rats. *International Journal of Toxicology*, 21, 115-146.

Christian, M.S., York, R.G., Hoberman, A.M., Frazee, J., Fisher, L.C., Brown, W.R., and Creasy, D.M. (2002b). Oral (drinking water) two-generation reproductive toxicity study of dibromoacetic acid (DBA) in rats. *International Journal of Toxicology*, 21, 1-40.

Clayton G, Clayton F [1981-1982]. *Patty's industrial hygiene and toxicology*. 3rd rev. ed. New York, NY: John Wiley & Sons.

Concern, Inc. *Groundwater: A Community Action Guide*. Washington, D.C., 1989.

Connell, G.F. (1996). *The chlorination/chloramination handbook*. Denver: American Water Works Ass.

Coulston, F., and Kolbye, A. (Eds.) (1994). *Regulatory Toxicology and Pharmacology*, vol. 20, no. 1, pt 2.

Covington, A. K.; Bates, R. G.; Durst, R. A. (1985). "Definitions of pH scales, standard reference values, measurement of pH, and related terminology" (PDF). *Pure Appl. Chem.* **57** (3): 531–542. doi:10.1351/pac198557030531.

Craun, G.F., 1992, *Waterborne disease outbreaks in the United States of America—Causes and prevention: World Health Statistician Quarterly*, v. 45.

Craun, G.F., and Calderon, R., 1996, *Microbial risks in groundwater systems—Epidemiology of waterborne outbreaks, in Under the microscope—Examining microbes in groundwater, Proceedings of the Groundwater*

Foundation's 12th Annual Fall Symposium, Sept. 5-6, 1996, Boston, Mass.: Research Foundation of the American Water Works Association.

Craun, G.F., Hauchman, F.S. and Robinson D.E. (Eds.) (2001). *Microbial pathogens and disinfection byproducts in drinking water: Health effects and management of risks, Conference Conclusions*, (pp.533-545). Washington, D.C.: ILSI Press.

Craun, G.F., Nwachuku, N., Calderon, R.L., and Craun, M.F. (2002). *Outbreaks in drinking-water systems, 1991-1998. Journal of Environmental Health*, 65, 16-25.

Cross, Brad L and Jack Schulze. *City of Hurst (A Public Water Supply Protection Strategy)*. Texas Water Commission, Austin, TX, 1989.

Curds, C.R. 1992. *Protozoa and the water industry*. Cambridge University Press, MA. 122 pp.

Curtis, Christopher and Teri Anderson. *A Guidebook for Organizing a Community Collection Event: Household Hazardous Waste*. Pioneer Valley Planning Commission and Western Massachusetts Coalition for Safe Waste Management, West Springfield, MA, 1984.

Curtis, Christopher, Christopher Walsh, and Michael Przybyla. *The Road Salt Management Handbook: Introducing a Reliable Strategy to Safeguard People & Water Resources*. Pioneer Valley Planning Commission, West Springfield, MA, 1986.

Davis, J.V., and Witt, E.C., III, 1998, *Microbiological quality of public-water supplies in the Ozark Plateaus Aquifer System: U.S. Geological Survey Fact Sheet 028-98*, 2 p.

Davy, Humphry (1808). "On some new Phenomena of Chemical Changes produced by Electricity, particularly the Decomposition of the fixed Alkalies, and the Exhibition of the new Substances, which constitute their Bases". *Philosophical Transactions of the Royal Society (Royal Society of London.)* 98 (0): 1-45. doi:10.1098/rstl.1808.0001.

DiNovo, F., and Jaffe, M., 1984, *Local groundwater protection—Midwest Region: Chicago, Ill., American Planning Association.*, chap. 2-4, p. 5-40.

DOT [1993]. 1993 Emergency response guidebook, guide 20. Washington, DC: U.S. Department of Transportation, Office of Hazardous Materials Transportation, Research and Special Programs Administration.

Dufour, A.P., 1984, *Health effects criteria for fresh recreational waters: Cincinnati, Ohio*, U.S. Environmental Protection Agency, EPA-600/1-84-004.

Dumas, J. B. (1837). 'Affinite' (lecture notes), vii, pg 4. "Statique chimique", Paris: Academie des Sciences.

Dutka, B.J., Palmateer, G.A., Meissner, S.M., Janzen, E.M., and Sakellaris, M., 1990, *The presence of bacterial virus in groundwater and treated drinking water: Environmental Pollution*, v. 63.

Eagle, Cassandra T.; Jennifer Sloan (1998). "Marie Anne Paulze Lavoisier: The Mother of Modern Chemistry". *The Chemical Educator (PDF)* 3 (5): 1-18. doi:10.1007/s00897980249a.

Edwards, T.K., and Glysson, G.D., 1988, *Field methods for measurement of fluvial sediment: U.S. Geological Survey Techniques of Water-Resources Investigations*, book 3, chap. C2, 89 p.

Embrey, S.S., 1992, *Surface-water-quality assessment of the Yakima River Basin, Washington—Areal distribution of fecal-indicator bacteria, July 1988: U.S. Geological Survey Water-Resources Investigations Report 91- 4073*, 33 p.

Feldman, Isaac (1956). "Use and Abuse of pH measurements". *Analytical Chemistry* 28 (12): 1859. doi:10.1021/ac60120a014.

Fenchel, T. 1974. *Intrinsic rate increase: the relationship with body size*. *Oecologia* 14:317-326.

Fenchel, T., T. Perry, and A. Thane. 1977. *Anaerobiosis and symbiosis with bacteria in free-living ciliates*. *Journal of Protozoology* 24:154-163.

Fenchel, T., T. Perry, and A. Thane. 1977. *Anaerobiosis and symbiosis with bacteria in free-living ciliates*. *Journal of Protozoology* 24:154-163.

First chemists, February 13, 1999, *New Scientist*.

Flint, K.P., 1987, *The long-term survival of Escherichia coli in river water: Journal of Applied Bact*, v. 63.

Foissner, W. 1987. *Soil protozoa: fundamental problems, ecological significance, adaptations in ciliates and testaceans, bioindicators, and guide to the literature*. *Progress in Protistology* 2:69-212.

Foissner, W. 1988. *Taxonomic and nomenclatural revision of Stádecek's list of ciliates (Protozoa: Ciliophora) as indicators of water quality*. *Hydrobiologia* 166:1-64.

Ford, T.E. and Colwell R.R. (1996). *A global decline in microbiological safety of water: A call for action, a report prepared for the American Academy of Microbiology*.

Forsberg K, Mansdorf SZ [1993]. *Quick selection guide to chemical protective clothing*. New York, NY: Van Nostrand Reinhold.

Foster, Laurence, M.D. 1985. "Waterborne Disease - It's Our Job to Prevent It". PIPELINE newsletter, Oregon Health Division, Drinking Water Program, Portland, Oregon 1(4): 1-3.

Foster, Laurence, M.D. 1990. "Waterborne Disease," *Methods for the Investigation and Prevention of Waterborne Disease Outbreaks*. Ed. Gunther F. Craun. Cincinnati: U.S. Environ Protection Agency.

Francy, D.S. and Darner, R. A., 1998, *Factors affecting Escherichia coli concentrations at Lake Erie public bathing beaches: U.S. Geological Survey Water- Resources Investigations Report 98-4241*, 42 p.

Francy, D.S., Hart, T.L., and Virostek, C.M., 1996, *Effects of receiving-water quality and wastewater treatment on injury, survival, and regrowth of fecal-indicator bacteria and implications for assessment of recreational water quality: U.S. Geological Survey Water- Resources Investigations Report 96-4199*.

Francy, D.S., Helsel, D.L., and Nally, R.A., 2000, *Occurrence and distribution of microbiological indicators in groundwater and streamwater: Water Environment Research*. v. 72, no. 2., p. 152-161.

Francy, D.S., Jones, A.L., Myers, D.N., Rowe, G.L., Eberle, Michael, and Sarver, K.M., 1998, *Quality-assurance/quality-control manual for collection and analysis of water-quality data in the Ohio District, U.S. Geological Survey: U.S. Geological Survey Water-Resources Investigations Report 98-4057*, 71 p.

Francy, D.S., Myers, D.N., and Metzker, K.D., 1993, *Escherichia coli and fecal-coliform bacteria as indicators of recreational water quality: U.S. Geological Survey Water-Resources Investigations Report 93-4083*.

Fujioka, R.S. and Shizumura, L.K., 1985, *Clostridium perfringens, a reliable indicator of streamwater quality: Journal of the Water Pollution Control Federation*, v. 57, no. 10, p. 986-992.

Gannon, J.T., Manilal, V.B., and Alexander, M., 1991, *Relationship between cell surface properties and transport of bacteria through soil: Applied and Environmental Microbiology*, v. 57, n. 1, p. 190-193.

Geldreich, E.E., 1976, *Fecal coliform and fecal streptococcus density relationships in waste discharges and receiving waters: CRC Critical Reviews in Environmental Control*, October 1976, p. 349-369.

Genium [1992]. *Safety Data Sheets (SDS) No. 53*. Schenectady, NY: Genium Publishing Corporation.

Gerba, C.P., and Bitton, G., 1984, *Microbial pollutants—Their survival and transport pattern in ground*

Giese, A.C. 1973. *Blepharisma*. Stanford University Press, CA. 366 pp.

Gilliom, R.J., Alley, W.M., and Gurtz, M.E., 1995, *Design of the National Water-Quality Assessment Program— Occurrence and distribution water-quality conditions: U.S. Geological Survey Cirr 1112*, 33 p.

Glaser, Christopher (1663). *Traite de la chymie*. Paris. as found in: Kim, Mi Gyung (2003). *Affinity, That Elusive Dream - A Genealogy of the Chemical Revolution*. The MIT Press. ISBN 0-262-11273-6.

Gold Book Chemical Reaction IUPAC Goldbook.

Gordon, Wendy. *A Citizen's Handbook on Groundwater Protection*. Natural Resources Defense Council, New York, NY 1984.

Grant WM [1986]. *Toxicology of the eye*. 3rd ed. Springfield, IL: Charles C Thomas.

Guerra de Macedo, G. (1991). Pan American Health Organization. Ref. No. HPE/PER/CWS/010/28/1.1.

Guerrant, R.L. (1997). *Cryptosporidiosis: An emerging, highly infectious threat. Emerging Infectious Diseases*, 3, Synopses. [On-Line.] Available: <http://www.cdc.gov/ncidod/ied/vol3no1/guerrant.htm>

Handzel, T.R., Green, R.M., Sanchez, C., Chung, H., and Sobsey, M.D., 1993, *Improved specificity in detecting F-specific coliphages in environmental samples by suppression of somatic phages: Water Science Technology*, v. 27, no. 3-4, p. 123-131.

Harrison, Ellen Z. and Mary Ann Dickinson. *Protecting Connecticut's Groundwater: A Guide to Groundwater Protection for Local Officials*. Connecticut Department of Environmental Protection, Hartford, CT, 1984.

Hathaway GJ, Proctor NH, Hughes JP, and Fischman ML [1991]. *Proctor and Hughes' chemical hazards of the workplace*. 3rd ed. New York, NY: Van Nostrand Reinhold.

Havelaar, A.H., van Olphen, M., and Drost, Y.C., 1993, *F specific bacteriophages are adequate model organisms for enteric viruses in fresh water: Applied and Environmental Microbiology*, v. 59, n. 9, p. 2956-2962.

Helsel, D.R. and Hirsch, R.M., 1992, *Statistical methods in water resources: New York, Elsevier Science Publishing Company*.

Herbst, Eric (May 12, 2005). "Chemistry of Star-Forming Regions". *Journal of Physical Chemistry A* **109** (18): 4017–4029. doi:10.1021/jp050461c. PMID 16833724.

Hernandez-Delgado, E.A., Sierra, M.L., and Toranzos, G.A., 1991, Coliphages as alternate indicators of fecal contamination in tropical waters: *Environmental Toxicology and Water Quality*, v. 6, p. 131-143.

Herwaldt, B.L., Craun, G.F., Stokes, S.L., and Juranek, D.D., 1991, Waterborne-disease outbreaks, 1989-1990: *Morbidity and Mortality Weekly Report, Centers for Disease Control*, v. 40, no. SS-3, p. 1-13.

Hill, J.W.; Petrucci, R.H.; McCreary, T.W.; Perry, S.S. (2005). *General Chemistry (4th ed.)*. Upper Saddle River, New Jersey: Pearson Prentice Hall. p. 37.

Hirsch, R.M., Alley, W.M., and Wilber, W.G., 1988, *Concepts for a national-water quality assessment program: U.S. Geological Survey Circular 1021*.

Housecroft & Sharpe 2008, p. 2.

Housecroft, Catherine E.; Sharpe, Alan G. (2008) [2001]. *Inorganic Chemistry (3rd Ed.)*. Harlow, Essex: Pearson Education. ISBN 978-0-13-175553-6.

household supply, Lower Susquehanna River Basin, Pennsylvania and Maryland: *U.S. Geological Survey Water-Resources Investigations Report 96-4212*.

Howell, J.M., Coyne, M.S., and Cornelius, P., 1995, Fecal bacteria in agricultural waters of the Bluegrass Region of Kentucky: *Journal of Environmental Quality*, v. 24, p. 411-419.

Hrezo, Margaret and Pat Nickinson. *Protecting Virginia's Groundwater A Handbook for Local Government Officials*. Virginia Polytechnic Institute and State University, Blacksburg, VA, 1986.

Ihde, Aaron John (1984). *The Development of Modern Chemistry*. Courier Dover Publications. p. 164. ISBN 0-486-64235-6.

Ijzerman, M.M., and Hagedorn, C., 1992, Improved method for coliphage detection based on β -galactosidase induction: *Journal of Virological Methods*, v. 40, p. 31-36.

International Association of Water Pollution Research and Control Study Group on Health Related Water Microbiology, 1991, Bacteriophages as model viruses in water quality control: *Water Research*, v. 25, no. 5, p. 529-545.

International Programme on Chemical Safety (2000). *Disinfectants and disinfectant byproducts, Environmental Health Criteria 216*. IUPAC Gold Book Definition.

IUPAC Provisional Recommendations for the Nomenclature of Inorganic Chemistry (2004)

Jaffe, Martin and Frank Dinovo. *Local Groundwater Protection*. American Planning Association, Chicago, IL, 1987.

Kirmeyer, G.J. (1994). *An assessment of the condition of North American water distribution systems and associated research needs*. American Water Works Association Research Foundation Project #706.

Koterba, M.T., Wilde, F.D., and Lapham, W.W., 1995, *Groundwater data-collection protocols and procedures for the National Water-Quality Assessment Program—Collection and documentation of water-quality samples and related data: U.S. Geological Survey Open-File Report 95-399*, 113 p.

Kreier, J.P., and J.R. Baker. 1987. *Parasitic protozoa*. Allen and Unwin, Boston, MA. 241 pp.

Larson, J.L., Wolf, D.C., and Butterworth, B.E. (1994b). Induced cytotoxicity and cell proliferation in the hepatocarcinogenicity of chloroform in female B6C3F1 mice: comparison of administration by gavage in corn oil vs. ad libitum in drinking water. *Fundamentals and Applied Toxicology*, 22, 90-102.

Laybourn, J., and B.J. Finlay. 1976. Respiratory energy losses related to cell weight and temperature in ciliated protozoa. *Oecologia* 44:165-174.

LeChevallier, M.W., Norton, W.D., and Lee, R.G., 1991, Occurrence of *Giardia* and *Cryptosporidium* species in surface water supplies: *Applied and Environmental Microbiology*, v. 57, no. 9, p. 2610-2616.

Lee, C.C., and T. Fenchel. 1972. *Studies on ciliates associated with sea ice from Antarctica. II. Temperature responses and tolerances in ciliates from Antarctica, temperate and tropical habitats*. *Archive für Protistenkunde* 114:237-244.

Loomis, George and Yael Calhoun. "Natural Resource Facts: Maintaining Your Septic System." University of Rhode Island, Providence, RI, 1988.

Macozzi, Maureen. *Groundwater- Protecting Wisconsin's Buried Treasure*. Wisconsin Department of Natural Resources, Madison, WI, 1989.

Maine Ass of Conservation Comm. *Groundwater... Maine's Hidden Resource*. Hallowell, ME, 1985.

Massachusetts Audubon Society "Local Authority for Groundwater Protection." *Groundwater Information Flyer #4*. Lincoln, MA, 1984.

Massachusetts Audubon Society. "Groundwater and Contamination: From the Watershed into the Well." *Groundwater Information Flyer # 2*. Lincoln, MA, 1984.

Massachusetts Audubon Society. "Mapping Aquifers and Recharge Areas." *Groundwater Information Flyer # 3*. Lincoln, MA, 1984.

Massachusetts Audubon Society. "Road Salt and Groundwater Protection." *Groundwater Information Flyer # 9*. Lincoln, MA, 1987.

McCann, Alyson and Thomas P Husband. "Natural Resources Facts: Household Hazardous Waste." University of Rhode Island, Providence, RI; 1988.

Miller, David W. *Groundwater Cont.: A Special Report*. Geraghty & Miller, Inc., Syosset, NY 1982.

Montagnes, D.J.S., D.H. Lynn, J.C. Roff, and W.D. Taylor. 1988. The annual cycle of heterotrophic planktonic ciliates in the waters surrounding the Isles of Shoals, Gulf of Maine: an assessment of their trophic role. *Marine Biology* 99:21-30.

Mullikin, Elizabeth B. *An Ounce of Prevention: A Groundwater Protection Handbook for Local Officials*. Vermont Departments of Water Resources and Environmental Engineering, Health, and Agriculture, Montpelier, VT, 1984.

Murphy, Jim. "Groundwater and Your Town: What Your Town Can Do Right Now." Connecticut Department of Environmental Protection, Hartford, CT.

National Research Council. *Groundwater Quality Protection: State and Local Strategies*. National Academy Press, Washington, D.C., 1986.

New England Interstate Water Pollution Control Commission. "Groundwater: Out of Sight Not Out of Danger." Boston, MA, 1989.

Niederlehner, B.R., K.W. Pontasch, J.R. Pratt, and J. Cairns. 1990. Field evaluation of predictions of environmental effects from multispecies microcosm toxicity test. *Archives of Environmental Contamination and Toxicology* 19:62-71.

Noake, Kimberly D. *Guide to Contamination Sources for Wellhead Protection*. Draft. Massachusetts Department of Environmental Quality Engineering, Boston, MA, 1988.

Office of Groundwater Protection. *Guidelines for Delineation of Wellhead Protection Areas*. U.S. EPA, Washington, D.C., 1987.

Office of Groundwater Protection. *Survey of State Groundwater Quality Protection Legislation Enacted From 1985 Through 1987*. U.S. EPA, Washington, D.C., 1988.

Office of Groundwater Protection. *Wellhead Protection Programs. - Tools for Local Governments*. U.S. EPA, Washington, D.C., 1989.

Office of Groundwater Protection. *Wellhead Protection: A Decision-Makers' Guide*. U.S. EPA, Washington, D.C., 1987.

Office of Pesticides and Toxic Substances. *Citizen's Guide to Pesticides*. U.S. EPA, Wa, D.C., 1989.

Office of Underground Storage Tanks. *Musts for USGS. - A Summary of the New Regulations for Underground Storage Tank Systems*. U.S. EPA, Washington, D.C., 1988.

Ohio Environmental Protection Agency. *Groundwater*. Columbus, OH.

Redlich, Susan. *Summary of Municipal Actions for Groundwater Protection in the New England/New York Region*. New England Interstate Water Pollution Control Commission, Boston, MA, 1988.

Southern Arizona Water Resources Association. "Water Warnings: Our Drinking Water.... It Takes Everyone to Keep It Clean." Tucson, AZ.

Sponenberg, Torsten D. and Jacob H. Kahn. *A Groundwater Primer for Virginians*. Virginia Polytechnic Institute and State University, Blacksburg, VA, 1984.

Taylor, W., and R. Sanders. 1991. Protozoa. Pages 37-93 in J.H. Thorp and A.P. Covich, eds. *Ecology and classification of North American freshwater invertebrates*. Academic Press, New York.

Texas Water Commission. "On Dangerous Ground: The Problem of Abandoned Wells in Texas." Austin, TX, 1989.

Texas Water Commission. *The Underground Subject: An Introduction to Groundwater Issues in Texas*. Austin, TX, 1989.

U.S. Environmental Protection Agency. *Seminar Publication: Protection of Public Water Supplies from Groundwater Contaminants*. Center for Environmental Research Information, Cincinnati, OH, 1985.

Waller, Roger M. *Groundwater and the Rural Homeowner*. U.S. Geological Survey, Reston, VA, 1988.



We welcome you to complete the assignment in Microsoft Word. You can find the assignment at www.abctlc.com.

Once complete, just simply fax or e-mail the answer key along with the registration page to us and allow two weeks for grading.

Once we grade it, we will email a certificate of completion to you.

Call us if you need any help.

If you need your certificate back within 48 hours, you may be asked to pay a rush service fee of \$50.00.

You can download the assignment in Microsoft Word from TLC's website under the Assignment Page. www.abctlc.com

You will have 90 days to successfully complete this assignment with a score of 70% or better. If you need any assistance, please contact TLC's Student Services.