

WASTEWATER TREATMENT

PROFESSIONAL DEVELOPMENT HOUR
CONTINUING EDUCATION COURSE



Printing and Saving Instructions

The best option is to download this pdf document and assignment to your computer desktop and open it with Adobe Acrobat DC reader.

Adobe Acrobat DC reader is a free computer software program and you can find it at Adobe Acrobat's website.

You can complete the course by viewing the course on your computer or you can print it out. This course booklet does not have the assignment. Please visit our website and download the assignment (the test).

Printing Instructions: Once you have purchased the program, we will give you permission to print this document. If you are going to print this document, this document was designed to be printed double-sided or duplexed but can be printed single-sided.

Hyperlink to the assignment

<http://www.ABCTLC.com/downloads/PDF/WASTEWATERTREATMENT%20ASS.pdf>

Hyperlink to the Glossary and Appendix

<http://www.abctlc.com/downloads/PDF/WWTGlossary.pdf>

State Approval Listing Link, check to see if your State accepts or has pre-approved this course. Not all States are listed. Not all courses are listed. Do not solely trust our list for it may be outdated. It is your sole responsibility to ensure this course is accepted for credit. No refunds.

State Approval Listing URL...

<http://www.abctlc.com/PDF/CEU%20State%20Approvals.pdf>

You can obtain a printed version from TLC for an additional \$189.95 plus shipping charges.

All downloads are electronically tracked and monitored for security purposes.



Some States and many employers require the final exam to be proctored.

Do not solely depend on TLC's Approval list for it may be outdated.

All downloads are electronically tracked and monitored for security purposes.

Most of our students prefer to do the assignment in Word and e-mail or fax the assignment back to us. We also teach this course in a conventional hands-on class. Call us and schedule a class today.

Precept-Based Training Course

This training course is based upon a form of induction training, made of topical and technical precepts. The training topics are made up of "micro-content" or "precepts"— or small chunks of information that can be easily digested. These bite-size pieces of technical information are considered to be one of the most effective ways of teaching people new information because it helps the mind retain knowledge easier.

Micro-learning or precept-based training doesn't rely on the student to process a large amount of information before breaking it down. Our method includes short modules with clearly defined learning goals for each section. This method allows a student to hone in on a particular skill, then given the opportunity to exhibit their knowledge in the final assessment.

**United States Library of Congress Number TX 6-580-136
ISBN 978-0-9799928-3-4
All Rights Reserved.**

Copyright Notice

1999-2022 Technical Learning College (TLC) No part of this work may be reproduced or distributed in any form or by any means without TLC's prior written approval. Permission has been sought for all images and text where we believe copyright exists and where the copyright holder is traceable and contactable. Other materials including text and artwork are in the public domain or fair use (the state of belonging or being available to the public as a whole, and therefore not subject to copyright.)

All material that is not credited or acknowledged or referenced in the rear of this course is the copyright of Technical Learning College. Most unaccredited photographs have been taken by TLC instructors or TLC students. All written, graphic, photographic or other material is provided for educational information only. We will be pleased to hear from any copyright holder and will make good on your work if any unintentional copyright infringements were made as soon as these issues are brought to the editor's attention.

This educational training course and assignment is intended for educational purposes only. Every possible effort was made to ensure that all information provided in this course is accurate. Therefore, Technical Learning College accepts no responsibility or liability whatsoever for the application or misuse of any information included herein.

Requests for permission to make copies should be made to the following address:

TLC

P.O. Box 3060

Chino Valley, AZ 86323

Information in this document is subject to change without notice. TLC is not liable for errors or omissions appearing in this document.

Course Editor

Gary Taylor

Instructor, Stark State College of Technology, Environmental, Health and Safety Technology, Water/Wastewater Operator Training Courses. Correspondence Course Coordinator and Classroom Instructor for the Operator Training Committee of Ohio (OTCO). Kent State University, Tuscarawas Regional Campus, New Philadelphia, Ohio; Associate of Applied Science Mechanical Engineering Technology; Graduated May, 1983.

Contributing Editors

James L. Six Received a Bachelor of Science Degree in Civil Engineering from the University of Akron in June of 1976, Registered Professional Engineer in the State of Ohio, Number 45031 (Retired), Class IV Water Supply Operator issued by Ohio EPA, Number WS4-1012914-08, Class II Wastewater Collection System Operator issued by Ohio EPA, Number WC2-1012914-94

Joseph Camerata has a BS in Management with honors (magna cum laude). He retired as a Chemist in 2006 having worked in the field of chemical, environmental, and industrial hygiene sampling and analysis for 40 years.

James Bevan, Water Quality Inspector S.M.E. Twenty years of experience in the environmental field dealing with all aspects of water regulations on the federal, state, and local levels. Teacher and Proctor in Charge for Backflow Certification Testing at the ASETT Center in Tucson for the past 15 years and possess an Arizona Community College, Special Teaching Certificate in Environmental Studies.

Dr. Pete Greer S.M.E., Retired biology instructor, chemistry and biological review.

Jack White, Environmental, Health, Safety expert, City of Phoenix. Art Credits

Technical Learning College's Scope and Function

Welcome to the Program,

Technical Learning College (TLC) offers affordable continuing education for today's working professionals who need to maintain licenses or certifications. TLC holds several different governmental agency approvals for granting of continuing education credit.

TLC's delivery method of continuing education can include traditional types of classroom lectures and distance-based courses or independent study. TLC's distance based or independent study courses are offered in a print - based distance educational format. We will beat any other training competitor's price for the same CEU material or classroom training.

Our courses are designed to be flexible and for you do finish the material on your leisure. Students can also receive course materials through the mail. The CEU course or e-manual will contain all your lessons, activities and instruction to obtain the assignments. All of TLC's CEU courses allow students to submit assignments using e-mail or fax, or by postal mail. (See the course description for more information.)

Students have direct contact with their instructor—primarily by e-mail or telephone. TLC's CEU courses may use such technologies as the World Wide Web, e-mail, CD-ROMs, videotapes and hard copies. (See the course description.) Make sure you have access to the necessary equipment before enrolling, i.e., printer, Microsoft Word and/or Adobe Acrobat Reader. Some courses may require proctored closed-book exams depending upon your state or employer requirements.

Flexible Learning

At TLC, there are no scheduled online sessions or passwords you need contend with, nor are you required to participate in learning teams or groups designed for the "typical" younger campus based student. You can work at your own pace, completing assignments in time-frames that work best for you. TLC's method of flexible individualized instruction is designed to provide each student the guidance and support needed for successful course completion.

Course Structure

TLC's online courses combine the best of online delivery and traditional university textbooks. You can easily find the course syllabus, course content, assignments, and the post-exam (Assignment). This student friendly course design allows you the most flexibility in choosing when and where you will study.

Classroom of One

TLC offers you the best of both worlds. You learn on your own terms, on your own time, but you are never on your own. Once enrolled, you will be assigned a personal Student Service Representative who works with you on an individualized basis throughout your program of study. Course specific faculty members (S.M.E.) are assigned at the beginning of each course providing the academic support you need to successfully complete each course. Please call or email us for assistance.

Satisfaction Guaranteed

We have many years of experience, dealing with thousands of students. We assure you, our customer satisfaction is second to none. This is one reason we have taught more than 20,000 students.

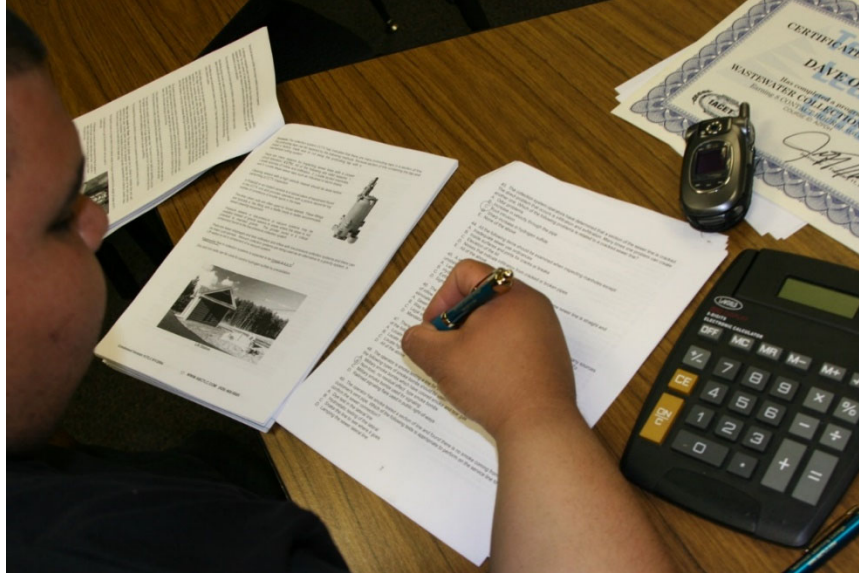

We welcome you to do the electronic version of the assignment and submit the answer key and registration to us either by fax or e-mail.

If you need this assignment graded and a certificate of completion within a 48-hour turn around, prepare to pay an additional rush charge of \$50.

Contact Numbers
Fax (928) 468-0675
Email Info@tlch2o.com
Telephone (866) 557-1746

This course contains EPA's federal rule requirements. Please be aware that each state implements wastewater/safety regulations that may be more stringent than EPA's or OSHA's regulations. Check with your state environmental agency for more information. You are solely responsible in ensuring that you abide with your jurisdiction or agency's rules and regulations. Always abide with your discharge or NPDES permit and do not follow the instructions in this course for compliance.

CEU Course Description

Wastewater Treatment CEU Training Course

This short CEU course is a review of various wastewater treatment methods and related subjects, including sampling, chemistry and biology related to conventional wastewater treatment. This course is general in nature and not state specific but will contain different wastewater treatment methods, policies and ideas. You will not need any other materials for this course.

This CEU course is intended for Wastewater Treatment, Collections and Pretreatment/Industrial Waste Inspectors. The target audience for this course is the person interested in working in a wastewater treatment or collections facility and wishing to maintain CEUs for a certification license or to learn how to do the job safely and effectively, and/or to meet education needs for promotion.

Prerequisites: None

Final Examination for Credit

Opportunity to pass the final comprehensive examination is limited to three attempts per course enrollment.

Flexible Learning

At TLC, there are no scheduled online sessions you need contend with, nor are you required to participate in learning teams or groups designed for the typical younger campus-based student. You will work at your own pace, completing assignments in time frames that work best for you. TLC's method of flexible individualized instruction is designed to provide each student the guidance and support needed for successful course completion.

We will beat any other training competitor's price for the same CEU material or classroom training. Student satisfaction is guaranteed.

Course Structure

TLC's online courses combine the best of online delivery and traditional university textbooks. You will find the course syllabus, course content, assignments, and open book exams online. This student-friendly course design allows you the most flexibility in choosing when and where you want to study.

Classroom of One

Course specific faculty members are assigned at the beginning of each course providing the academic support you need to successfully complete each course.

Written Assignment Instructions

The Wastewater Treatment CEU training course uses a multiple choice style answer key. You can write your answers in this manual or type out your own answer key. TLC would prefer that you type out and fax or e-mail the final assignment to TLC, but it is not required.

Feedback Mechanism (examination procedures)

Each student will receive a feedback form as part of study packet. You will be able to find this form in the front of the course assignment or lesson.

Security and Integrity

All students are required to do their own work. All lesson sheets and final exams are not returned to the student to discourage sharing of answers. Any fraud or deceit and the student will result in forfeiture of all fees and the appropriate agency will be notified.

Grading Criteria

TLC will offer the student either pass/fail or a standard letter grading assignment. If TLC is not notified, you will only receive a pass/fail notice.

Required Texts

The Wastewater Treatment CEU training course will not require any other materials. This course comes complete.

Environmental Terms, Abbreviations, and Acronyms

TLC provides a glossary that defines, in non-technical language, commonly used environmental terms appearing in publications and materials. It also explains abbreviations and acronyms used throughout the EPA and other agencies.

Hyperlink to the Glossary and Appendix

<http://www.abctlc.com/downloads/PDF/WWTGlossary.pdf>

Recordkeeping and Reporting Practices

TLC will keep all student records for a minimum of seven years. It is your responsibility to give the completion certificate to the appropriate agencies. TLC will mail a copy to any State that requires a copy from the Training Provider.

ADA Compliance

TLC will make reasonable accommodations for persons with documented disabilities. Students should notify TLC and their instructors of any special needs. Course content may vary from this outline to meet the needs of this particular group. Alternative assignment is available.

Note to students: Keep a copy of everything you submit. If your work is lost you can submit your copy for grading. If you do not receive your certificate of completion or quiz results within two or three weeks after submitting it, please contact your instructor.

We expect every student to produce his or her original, independent work. Any student whose work indicates a violation of the Academic Misconduct Policy (cheating, plagiarism) can expect penalties as specified in the Student Handbook, which is available through Student Services; contact them at (928) 468-0665.

You will have 90 days from receipt of this manual to complete it in order to receive your Continuing Education Units (**CEUs**) or Professional Development Hours (**PDHs**). A score of 70% or better is necessary to pass this course. If you should need any assistance, please email all concerns and the final test to info@tlch2o.com.

Educational Mission

The educational mission of TLC is:

To provide TLC students with comprehensive and ongoing training in the theory and skills needed for the environmental education field,

To provide TLC students opportunities to apply and understand the theory and skills needed for operator certification,

To provide opportunities for TLC students to learn and practice environmental educational skills with members of the community for the purpose of sharing diverse perspectives and experience,

To provide a forum in which students can exchange experiences and ideas related to environmental education,

To provide a forum for the collection and dissemination of current information related to environmental education, and to maintain an environment that nurtures academic and personal growth.

Course Objective: To provide continuing education training in effective and efficient wastewater treatment methods, sampling, disinfection, safety and laboratory practices.

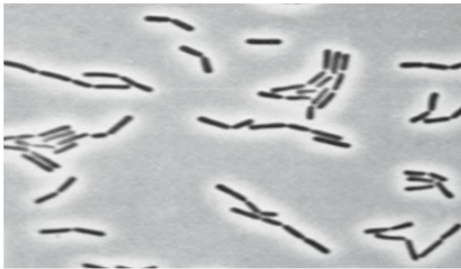

Lactobacillus sp.

One of the key bacteria used in digesters that release organic acids and enzymes that reduce organic matter.

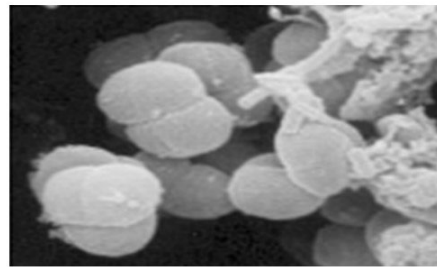

Methanosarcina sp.

This single cell organism is known for producing methane from carbon dioxide and hydrogen gas.

Table of Contents (See Topic Legend on page 17)

Acronyms..... 19

Key Terms..... 23

Topic 1- Wastewater Introduction Section..... 27

Overview..... 29

CWA Secondary Treatment Standards -CRAO&WQ 31

Permit Introduction-CRAO&WQ 32

Process Introduction –TECH & M/O..... 33

Wastewater Quality Characteristics- TECHNICAL&WQ 35

Conventional Wastewater Treatment Introduction..... 37

Effects of WWT Pollutants- CRAO&WQ..... 41

Primary Wastewater Components-CRAO&WQ 43

Oil and Grease Introduction- TECHNICAL&WQ..... 44

Inorganics-CRAO&WQ 45

Solids – CRAO & TECH..... 47

Hydrogen Sulfide and Ammonia– WQ & TECH 49

Biological Components- TECHNICAL&WQ..... 51

Oxygen Demanding Pollutants- TECHNICAL&WQ&CRAO 55

Thermal Effects- TECHNICAL&WQ 56

Post Quiz..... 59

Topic 2 -Primary Treatment Section 61

Conventional Treatment- TECHNICAL..... 63

Influent Flow -CRAO&WQ 65

Plant Overview- TECHNICAL 67

Sampling Effluent Introduction-CRAO&WQ 69

Preliminary Treatment Section - TECHNICAL..... 71

Headworks- TECHNICAL 73

Grit Chamber- TECHNICAL 75

Primary Clarifier- TECHNICAL 81

Clarifier Operation- TECHNICAL 82

Secondary Clarification - TECHNICAL..... 83

Photo Journal #2 87

Scum Removal- TECHNICAL..... 91

Struvite Problem - TECHNICAL 94

Photo Journal #3..... 95

Operational Issues-CRAO&WQ 97

Solids Handling-CRAO&WQ 101

Anaerobic Digestion –TECHNICAL..... 104

Post Quiz..... 107

Topic 3- Alternative- Secondary Treatment Section..... 109

Biological Terminology..... 111

Secondary Treatment – O&M..... 113

Ponds and Lagoons Introduction- M/O 115

Aerobic Process- M/O 116

Facultative Lagoons- M/O 117

Lagoon Microorganisms - M/O – A/S..... 121

Mixed or Suspended Lagoons- M/O – A/S	123
Algae- M/O	125
Lagoon pH and Alkalinity-A/S- M/O&WQ	127
Fixed-Film Systems- A/S & N&P	129
Rotating Biological Contactors- TECH & M/O	131
Trickling Filter - A/S & N&P.....	135
Low Rate Filters- TECH & M/O.....	137
Roughing Filter - A/S & N&P.....	138
Aeration Section- TECH & M/O	141
Large Air Diffusers- TECH & M/O	144
Photo Journal # 4.....	145
Blowers- TECH & M/O	147
Diffuser Layouts- TECH & M/O	149
Advanced Treatment Method Introduction- TECH & M/O.....	151
Fuzzy Filters- TECH & M/O	154
Oxidation Ditches - A/S & N&P	159
Reactor- TECH & M/O	161
Post Quiz	163
Topic 4 -Activated Sludge Section.....	165
Technical Process- A/S.....	166
Activated Sludge Process Overview- A/S & M/O	168
Internal Mixed Liquor Recycle- A/S.....	169
Process Control- A/S.....	175
Mixed Liquor Introduction- M/O	183
RAS Calculation- A/S.....	191
WAS Calculation- A/S.....	195
Mixing - A/S.....	197
Detention Time- A/S.....	199
Desired Effluent-CRAO&WQ&A/S.....	201
Design Chart- A/S & TECH & M/O	202
Design Parameters - CRAO&WQ&A/S.....	203
Sludge Removal- CRAO&WQ&A/S.....	209
Various A/S Designs and Operations – A/S.....	213
Complete Mix Process- TECH & M/O.....	215
Contact Stabilization- A/S & TECH & M/O.....	216
Extended Aeration- A/S & TECH & M/O.....	217
High Purity Oxygen- A/S & TECH & M/O.....	218
Ludzack-Ettinger Process-A/S.....	219
Plug Flow- A/S & TECH & M/O.....	223
Sequencing Batch Reactor–A/S & N&P.....	225
Step Feed- A/S & TECH & M/O.....	227
Wuhrmann Process –A/S & N&P.....	228
Activated Sludge Organic Load Methods - A/S & TECH & M/O.....	229
Sludge Age Sub-Section- A/S & TECH & M/O.....	235
Sludge Age Calculation – A/S.....	237
Sludge Problems- A/S & TECH & M/O.....	239
Process Variables – A/S.....	255
Secondary Clarifier – A/S.....	265
MCRT – SRT- A/S.....	267

Nitrification Time- A/S & TECH & M/O	275
RAS/WAS System Summary - A/S.....	277
Post Quiz.....	283
Topic 5 – Nutrient Removal Section	285
Important Ions.....	287
Nutrient Introduction-CRAO & WQ & N&P.....	289
Nitrogen Introduction- M/O & CRAO & N&P	295
Nitrate to Nitrogen Gas – TECHNICAL & N&P	298
Chemical Feeding- TECHNICAL.....	299
Denitrification Bacteria- N&P & M/O.....	303
Denitrification Performance – N&P.....	305
Ammonia- N&P & CRAO & WQ	307
Phosphorus Section- N&P & CRAO.....	309
Biological Phosphorus Control- N&P & M/O.....	311
Four- Stage Bardenpho Process - N&P & TECHNICAL	319
Pho-Redox (A/O) - N&P & TECH.....	321
Hybrid Chemical/Biological Processes- N&P & TECH	326
Phosphorus Removal by Chemical- M/O & CRAO.....	327
COD:P – N&P.....	335
Retention Rates – N&P.....	337
Carbon Absorption - TECHNICAL	342
Nitrification and Nutrient Removal-CRAO & WQ & N&P.....	343
Sequencing Batch Reactors - N&P & TECHNICAL	355
Recirculating Sand Filters - N&P & TECHNICAL	357
Natural Systems- N&P & TECHNICAL	358
Nutrient Constituents and Measurements- N&P & TECHNICAL	361
Post Quiz.....	363
Topic 6- Wastewater Microbiology Section.....	365
Microbiology Introduction.....	367
Bacteria Section- M/O.....	369
Facultative Bacteria- M/O	371
Bacteria Growth Terms – M/O.....	377
Protozoans - M/O.....	381
Indicator Organisms- M/O.....	387
Activated Sludge Specific Bugs – M/O.....	389
Vorticella– M/O.....	390
Euchlanis– M/O.....	395
Aerobic flocs - M/O.....	397
Filamentous Bacteria- M/O.....	399
Filamentous Identification - M/O.....	401
Microthrix- M/O.....	405
Microthrix Capabilities - M/O.....	409
Sphaerotilus natas- M/O.....	415
Thiothrix- M/O.....	417
Biological Sub-Section – M/O&CRAO.....	421
Microlife Food to Mass- M/O.....	425
Mean Cell Residence Time- M/O.....	431
ATP – MLSS – WQ & M/O.....	432

Dissolved Oxygen – M/O.....	433
Post Quiz.....	435
Topic 7 – Wastewater Sampling Section.....	437
Types of Samples LAB & WQ & CRAO.....	443
Collection of Grab Samples LAB & WQ & CRAO.....	452
Hand Composting LAB & WQ & CRAO.....	453
Equipment Maintenance LAB & WQ & CRAO.....	454
Common Sample Bottles LAB & WQ & CRAO.....	455
Chain-of-Custody LAB & WQ & CRAO	456
Sample Types, Required Sample Containers LAB & WQ & CRAO	457
Wastewater Treatment Plant Sampling LAB & WQ & CRAO.....	459
QA/QC Field Procedures LAB & WQ & CRAO.....	462
Field Equipment Blanks LAB & WQ & CRAO.....	465
SOC Sub Section - LAB & WQ & CRAO	469
VOC Sub Section - LAB & WQ & CRAO	471
Heavy Metals Sub Section - LAB & WQ & CRAO	477
Heavy Metals Sampling LAB & WQ & CRAO.....	479
Extractable Organics LAB & WQ & CRAO.....	480
Oil and Grease LAB & WQ & CRAO.....	482
Post Quiz.....	485
Topic 8- Laboratory Analysis and Process Control.....	487
pH - WQ & CRAO.....	489
pH Measurements - WQ & CRAO.....	491
pH Calculations - WQ & CRAO.....	495
Strong Acids –CRAO&WQ.....	497
Alkalinity- W/Q& M/O.....	499
Dissolved Oxygen - M/O&CRAO	503
Biochemical Oxygen Demand - M/O&CRAO	507
Specific Oxygen Uptake Rate - M/O&CRAO.....	513
TDS- WQ&M/O&CRAO.....	515
TSS- WQ&M/O&CRAO	519
Settleometer- WQ&M/O&CRAO.....	521
Suspended Matter- M/O&CRAO.....	525
Sludge Volume Indexing- M/O	527
Mixed Liquor- M/O	531
Fecal Coliform- M/O&CRAO.....	533
Photo Journal #5.....	535
Emerging Contaminants - WQ&CRAO.....	539
Post Quiz.....	545
Conversion Factors.....	547
References.....	551

Hyperlink to the Glossary and Appendix

<http://www.abctlc.com/downloads/PDF/WWTGlossary.pdf>

Topic Legend

This CEU course covers several educational topics/functions/purposes of conventional wastewater treatment and/or activated sludge processes. The topics listed below are to assist in determining which educational area is covered in a specific topic area:

A/S: Activated sludge is a suspended growth treatment process; this means the microorganisms (bugs) are not attached to a surface. The activated sludge process can be thought of as a mechanical modification to the pond treatment system. The activated sludge process adds a recycle line that returns the biological solids that settle out in the clarifier back to the front end of the process. The term “activated” was chosen because of “active” means “live”- meaning the biomass is used and recycled in the process. Return activated sludge (RAS) line returns the biomass and identifies the process as “activated sludge”.

CRAO: The regulatory and compliance component. May be a requirement of the NPDES or discharge permit, compliance, non-compliance, process control and local limits. All of the compliance and regulatory related tasks require A/S facilities to be sampled and monitored throughout the process, including sampling dried sludge. This along with the EPA information is to satisfy the regulatory portion of your operator training.

DISINFECTION: This area covers plant or effluent disinfection procedures. O&M training for many operators.

M/O: The biological component. Microorganisms that are WWT or A/S specific. This is a broad definition, but applies to any wastewater operation or specific process that grows and utilizes microorganisms (recirculated RAS) to digest or eat “food”. This can apply to lagoons, oxidation or devices that utilize some form of A/S. Also covers wastewater microorganism laboratory identification, sampling and process control. Laboratory training for many operators.

N&P: Nitrogen and phosphorus operations, understanding and removal of nutrients.

O&M: This area is for normal operation and/or maintenance of the plant. O&M training for many operators.

SAFETY: This area describes operational/process safety procedures.

TECH/TECHNICAL: The mechanical or physical treatment process or specific component. The WWT or A/S process including pretreatment processes/ applications/ engineering/ theories. Bar screens to Outfall, Fixed-film to Clarifiers. Blowers to Chemical feeders. O&M training for many operators.

WQ: Having to do with water quality or pollutants. May be a requirement of your NPDES or discharge permit. This along with the EPA information is to satisfy the regulatory portion of your operator training.

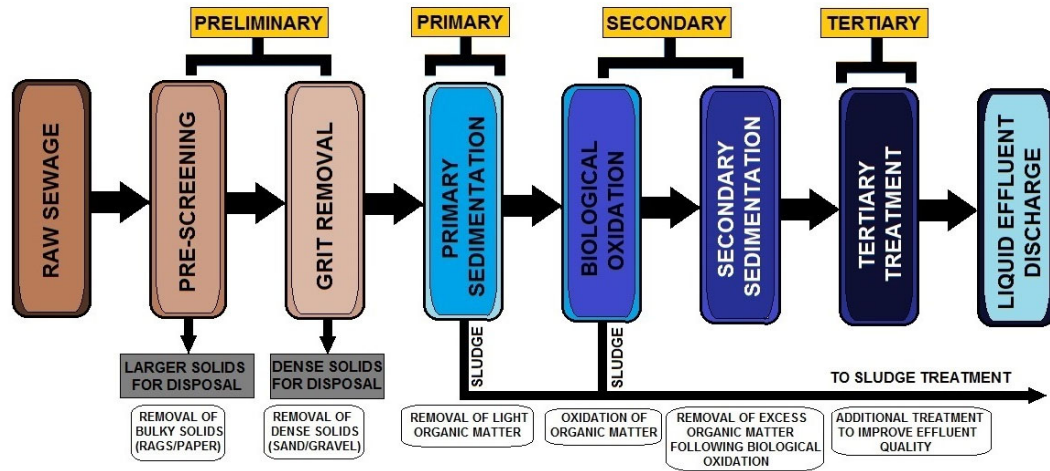

INTRODUCTION OF WASTEWATER TREATMENT METHODS AND STEPS

This course will examine both the activated sludge process and aerobic microorganisms (RAS populations that can digest organic matter in wastewater).

Wastewater sampling is also part of your compliance, noncompliance, process control, permit requirement and/or local limits sampling program. The EPA information in this course is to satisfy the regulatory portion of your training requirement.

Common Wastewater Acronyms and Terms

Acronyms and Abbreviations

A/E Contract: Architectural and Engineering Contracts
A/O: Pho-redox
AMSA: Association of Metropolitan Sewerage Agencies
AOB: Ammonia Oxidizing Bacteria
ASM: Activated Sludge Model
AT3: Aeration Tank 3
BABE: Bio-Augmentation Batch Enhanced
BAF: Biological Aerated Filter
BAR: Bio-Augmentation Regeneration/Reaeration
BCFS: Biological Chemical Phosphorus and Nitrogen Removal
bDON: Biodegradable Fraction of Dissolved Organic Nitrogen
BHRC: Ballasted High Rate Clarification Processes
BNR: Biological Nutrient Removal
BOD: Biochemical Oxygen Demand
BOD5: Biochemical Oxygen Demand (5-day)
BPR: Biological Phosphorus Removal
COD: Chemical Oxygen Demand
CSO: Combined Sewer Overflow
CWA: Clean Water Act
CWSRF: Clean Water State Revolving Fund
D&D: Drying and Dewatering Facility
DAF: Dissolved Air Flotation
DNR: Department of Natural Resources
DO: Dissolved Oxygen
DON: Dissolved Organic Nitrogen
E1: Estrone
E2: 17 β -estradiol
EBPR: Enhanced Biological Phosphorus Removal
EDC: Endocrine Disrupting Chemicals
EDTA: Ethylene Diamine Tetraacetic Acid
EE2: 17 α -ethynylestradiol
EPA: U.S. Environmental Protection Agency
EPA or USEPA: United States Environmental Protection Agency
FFS: Fixed-film Systems
FWPCA: Federal Water Pollution Control Act
FWS: Free Water Surface
GAO: Glycogen Accumulating Organism
GIS: Geographic Information System
HHWP: Household Hazardous Waste Collection Program
HRT: Hydraulic Retention Time
I&C: Instrumentation and Control System
I/I: Infiltration and Inflow
iDON: Inert Dissolved Organic Nitrogen
ISF: Intermittent Sand Filter
ISS: Inline Storage System
IWA: International Water Association

IWPP: Industrial Waste Pretreatment Program
LIMS: Laboratory Information Management Systems
MAUREEN: Mainstream Autotrophic Recycle Enhanced N-removal
MBBR: Moving-Bed Biofilm Reactor
MBDT: Minority Business Development and Training
MBE: Minority Business Enterprise
MBR: Membrane Bioreactor
MGD: Million Gallons per Day
MLE: Modified Ludzack Ettinger
N: Nitrogen
NOAA: National Oceanic and Atmospheric Administration
NOB: Nitrite Oxidizing Bacteria
NPDES: National Pollutant Discharge Elimination System
NTT: Nitrogen Trading Tool
ORD: EPA Office of Research and Development
ORP: Oxidation Reduction Potential
OWM: EPA Office of Wastewater Management
P: Phosphorus
P2: Pollution Prevention Initiative
PAH: Polycyclic Aromatic Hydrocarbons
PAO: Phosphate Accumulating Organism
PHA: Polyhydroxyalkanoates
PHB: Poly-B-hydroxy-butyrate
PHV: Poly-hydroxy valerate
POTW: Publicly Owned Treatment Works
PPCPs: Pharmaceuticals and Personal Care Products
QA/QC: Quality Assurance and Quality Control
RAS: Return Activated Sludge
RBC: Rotating Biological Contactor
rbCOD: Readily Biodegradable Chemical Oxygen Demand
rDON: Recalcitrant Dissolved Organic Nitrogen
RO: Reverse Osmosis
RSF: Recirculating Sand Filters
SAV: Submerged Aquatic Vegetation
SBR: Sequencing Batch Reactors
SHARON: Single Reactor High-activity Ammonia Removal Over Nitrite
SND: Simultaneous Nitrification-Denitrification
SRT: Solids Retention Time
SSES: Sewer System Evaluation Survey
SSO: Sanitary Sewer Overflow
SWIS: Subsurface Wastewater Infiltration System
TAT: Technical Advisory Team
TDS: Total Dissolved Solids
TKN: Total Kjeldahl Nitrogen
TMDL: Total Maximum Daily Loads
TN: Total Nitrogen
TP: Total Phosphorus
TSS: Total Suspended Solids
TUDP: Bio-P Model of the Delft University of Technology
USDA: U.S. Department of Agriculture

USGS: U.S. Geological Survey
VFA: Volatile Fatty Acids
VSS: Volatile Suspended Solids
WAS: Waste Activated Sludge
WEF: Water Environment Federation
WERF: Water Environment Research Foundation
WPAP: Water Pollution Abatement Program
WQS: Water Quality Standard
WWTP: Wastewater Treatment Plant

Hyperlink to the Glossary and Appendix

<http://www.abctlc.com/downloads/PDF/WWTGlossary.pdf>

Key Terms

Amine: A functional group consisting of "-NH₂."

Amino acid: A functional group consisting of a carbon with a carboxylic acid, "-COOH" and an amine, "-NH₂." These compounds are the building blocks for proteins.

Anabolism: Biosynthesis, the production of new cellular materials from other organic or inorganic chemicals.

Anaerobes: A group of organisms that do not require *molecular* oxygen. These organisms, as well as all known life forms, require oxygen. These organisms obtain their oxygen from inorganic ions such as nitrate or sulfate or from protein.

Anaerobic process: A process that only occurs in the absence of molecular oxygen.

Anoxic process: A process that occurs only at very low levels of molecular oxygen or in the absence of molecular oxygen.

Biochemical oxygen demand (BOD): The amount of oxygen required to oxidize any organic matter present in a water during a specified period of time, usually 5 days. It is an indirect measure of the amount of organic matter present in a water.

Carbonaceous biochemical oxygen demand (CBOD): The amount of oxygen required to oxidize any carbon containing matter present in a water.

Chemical oxygen demand (COD): The amount of oxygen required to oxidize any organic matter in the water using harsh chemical conditions.

Decomposers: Organisms that utilize energy from wastes or dead organisms. Decomposers complete the cycle by returning nutrients to the soil or water and carbon dioxide to the air or water.

Denitrification: The anoxic biological conversion of nitrate to nitrogen gas. It occurs naturally in surface waters low in oxygen, and it can be engineered in wastewater treatment systems.

Deoxygenation: The consumption of oxygen by the different aquatic organisms as they oxidize materials in the aquatic environment.

Facultative: A group of microorganisms that prefer or preferentially use molecular oxygen when available, but are capable of using other pathways for energy and synthesis if molecular oxygen is not available.

F/M Ratio: A method to control sludge wasting by maintaining a constant food-to-microorganism (F:M or F/M) ratio. With this method, the operator will increase or decrease the MLVSS to match an increase or decrease in the BOD entering the plant. Most plants will operate best at a specific F/M ratio between 0.05 - 0.1. If the optimum F/M has been determined from experience and can be maintained, a good effluent may be produced with consistent plant operation. The F/M ratio is to be calculated at least weekly and related to

the efficiency of treatment plant operation. An F/M ratio between 0.05 - 0.15 BOD/lb MLSS is usually considered acceptable for an extended aeration process.

Nitrification: The biological oxidation of ammonia and ammonium sequentially to nitrite and then nitrate. It occurs naturally in surface waters, and can be engineered in wastewater treatment systems. The purpose of nitrification in wastewater treatment systems is a reduction in the oxygen demand resulting from the ammonia.

Nitrogen fixation: The conversion of atmospheric (or dissolved) nitrogen gas into nitrate by microorganisms.

Nitrogenous oxygen demand (NOD): The amount of oxygen required to oxidize any ammonia present in a water.

NPDES: The National Pollutant Discharge Elimination System. The discharge criteria and permitting system established by the U.S. EPA as a result of the Clean Water Act and its subsequent amendments or the permit required by each discharger as a result of the Clean Water Act.

MCRT - Mean Cell Residence Time: A process control parameter where the average time a given unit of cell mass stays in the activated sludge biological reactor. It is typically calculated as the total mixed liquor suspended solids in the biological reactor divided by the combination of solids in the effluent and solids wasted.

Mixed liquor suspended solids (MLSS): The total suspended solids concentration in the activated sludge tank.

Mixed liquor volatile suspended solids (MLVSS): The volatile suspended solids concentration in the activated sludge tank.

Organic compound: Any compound containing carbon except for the carbonates (carbon dioxide, the carbonates and bicarbonates), the cyanides, and cyanates.

Organic nitrogen: Nitrogen contained as amines in organic compounds such as amino acids and proteins.

Oxidative phosphorylation: The synthesis of the energy storage compound adenosine triphosphate (ATP) from adenosine diphosphate (ADP) using a chemical substrate and molecular oxygen.

Secondary treatment: In wastewater treatment, the conversion of the suspended, colloidal and dissolved organics remaining after primary treatment into a microbial mass which is then removed in a second sedimentation process. Secondary treatment includes both the biological process and the associated sedimentation process.

Sludge: A mixture of solid waste material and water. Sludges result from the concentration of contaminants in water and wastewater treatment processes. Typical wastewater sludges contain from 0.5 to 10 percent solid matter.

Thiols: Organic compounds which contain the "-SH" functional group. Also called mercaptans.

Total dissolved solids: (TDS) Is the amount of dissolved matter in a water.

Total solids: (TS) Is the amount of organic and inorganic matter that is contained in a water.

Total suspended solids: (TSS) Is the amount of suspended (filterable) matter in a water.

Ultimate biochemical oxygen demand (BOD_u): The total amount of oxygen required to oxidize any organic matter present in a water, i.e. after an extended period, such as 20 or 30 days.

Virus: A submicroscopic genetic constituent that can alternate between two distinct phases. As a virus particle, or virion, it is DNA or RNA enveloped in an organic capsule. As an intracellular virus, it is viral DNA or RNA inserted into the host organisms DNA or RNA.

Volatile: A material that will vaporize easily.

Volatile solids (VS) is the amount of matter which volatilizes (or burns) when a water sample is heated to 550°C. This is generally considered the organic component.

Hyperlink to the Glossary and Appendix

<http://www.abctlc.com/downloads/PDF/WWTGlossary.pdf>

Topic 1 – Wastewater Introduction

Section Focus: You will learn the basics of the Clean Water Act (CWA), the need for wastewater treatment and common wastewater constituents. At the end of this section, you will be able to describe the need for wastewater treatment and the composition of wastewater. There is a post quiz at the end of this section to review your comprehension and a final examination in the Assignment for your contact hours.

Scope/Background: Under the CWA, EPA has implemented pollution control programs such as setting wastewater standards for industry. EPA has also developed national water quality criteria recommendations for pollutants in surface waters.

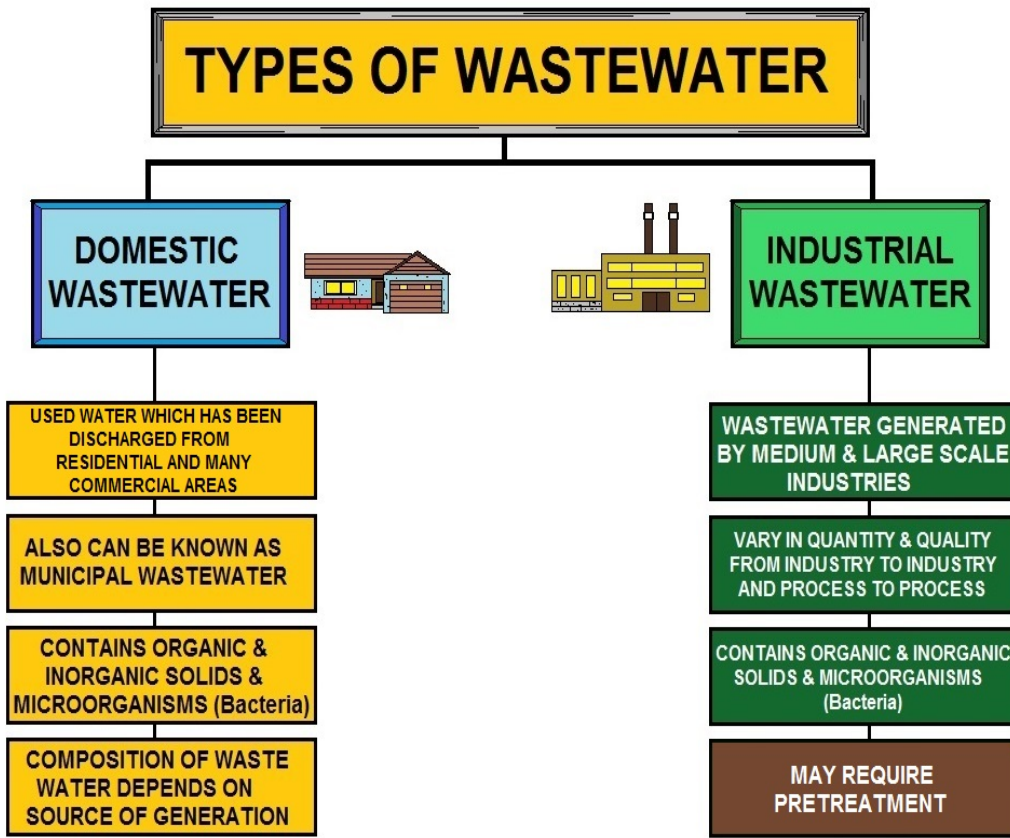

WASTEWATER TYPES

The diagram above shows the difference between domestic wastewater and industrial wastewater. Not all communities have industrial waste and if they do, the plant generally treats a high volume of flow.

Always follow your NPDES permit for proper sampling and laboratory procedures.

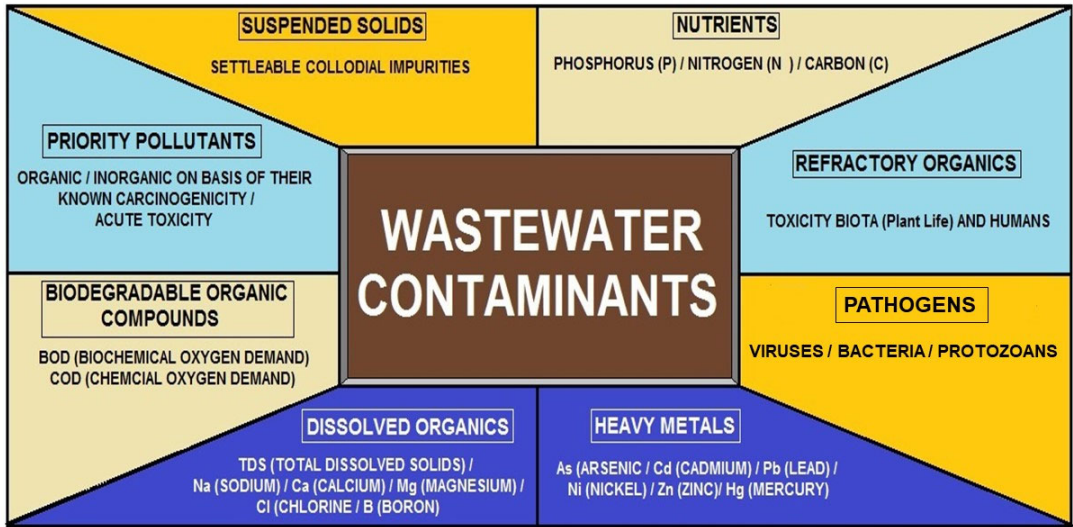

TYPES OF WASTEWATER CONTAMINANTS

Above are the common wastewater contaminants that we must deal with correctly to achieve our permit requirements.

Below, a pump from a lift station was that damaged by rocks and clogged with flushable wipes. Whatever the label says, wipes are not completely flushable.



Wastewater Treatment Overview

Wastewater treatment is the process of cleaning used water (sewage) so it can be returned safely to our environment or reused. Wastewater treatment is the last line of defense against water pollution. If you envision the water cycle as a whole, clean water produced by wastewater treatment is the same water that eventually ends up back in our lakes and rivers, where we get our drinking water.

Why Are Wastewater Treatment Plants Important?

Wastewater treatment plants are vital to our communities. They protect public health by eliminating disease-causing bacteria from water. By preserving water quality, wastewater treatment plants protect wildlife and make it possible for us to safely enjoy clean oceans, lakes, streams and rivers.

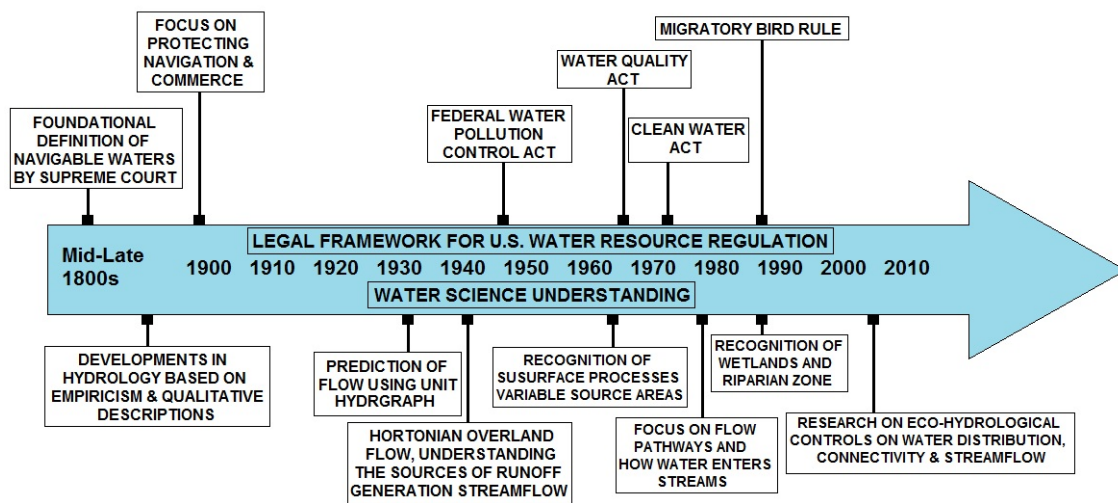

CLEAN WATER ACT TIMELINE

In 1972

Only a third of the nation's waters were safe for fishing and swimming. Wetlands losses were estimated at about 460,000 acres annually. Agricultural runoff resulted in the erosion of 2.25 billion tons of soil and the deposit of large amounts of phosphorus and nitrogen into many waters. Sewage treatment plants served only 85 million people.

Water Pollution Control Act

In 1972, Congress enacted the first comprehensive national clean water legislation in response to growing public concern for serious and widespread water pollution. The Clean Water Act is the primary federal law that protects our nation's waters, including lakes, rivers, aquifers, and coastal areas. Lake Erie was dying. The Potomac River was clogged with blue-green algae blooms that were a nuisance and a threat to public health. Many of the nation's rivers were little more than open sewers and sewage frequently washed up on shore. Fish kills were a common sight. Wetlands were disappearing at a rapid rate.

Today, the quality of our waters has improved dramatically as a result of a cooperative effort by federal, state, tribal and local governments to implement the pollution control programs established in 1972 by the Clean Water Act.

The Clean Water Act's primary objective was to restore and maintain the integrity of the nation's waters. This objective translates into two fundamental national goals:

- eliminate the discharge of pollutants into the nation's waters, and
- achieve water quality levels that are fishable and swimmable.

The Clean Water Act focuses on improving the quality of the nation's waters. It provides a comprehensive framework of standards, technical tools and financial assistance to address the many causes of pollution and poor water quality. This includes municipal and industrial wastewater discharges, polluted runoff from urban and rural areas, and habitat destruction.

For example, the Clean Water Act requires major industries to meet performance standards to ensure pollution control; charges states, and tribes with setting specific water quality criteria appropriate for their waters and developing pollution control programs to meet them; provides funding to states and communities to help them meet their clean water infrastructure needs; protects valuable wetlands and other aquatic habitats through a permitting process that ensures development and other activities are conducted in an environmentally sound manner. After 48 years, the act continues to provide a clear path for clean water and a solid foundation for an effective national protection water program.

33 U.S.C. s/s 1251 et seq. (1977)

The Clean Water Act (CWA) is a 1977 amendment to the Federal Water Pollution Control Act (PCA) of 1972, which set the basic structure for regulating discharges of pollutants to waters of the United States. The law gave the EPA the authority to set effluent standards on an industry basis (technology-based) and continued the requirements to set water quality standards for all contaminants in surface waters. The CWA makes it unlawful for any person to discharge any pollutant from a point source into navigable waters unless a permit (NPDES) is obtained under the act.

The 1977 amendments focused on toxic pollutants. In 1987, the PCA was reauthorized and again focused on toxic substances, authorized citizen suit provisions, and funded sewage treatment plants (POTW's) under the Construction Grants Program. The CWA provides for the delegation by the EPA of many permitting, administrative, and enforcement aspects of the law to state governments. In states with the authority to implement CWA programs, the EPA still retains oversight responsibilities.

Today

Two-thirds of the nation's waters are safe for fishing and swimming. The rate of annual wetlands losses is now estimated at about 70,000-90,000 acres per year according to recent studies. The amount of soil lost due to agricultural runoff has been cut by one billion tons annually, and phosphorus and nitrogen levels in water sources are down. As of 2020, modern wastewater treatment facilities serve 225 million people.

The Future

All Americans will enjoy clean water that is safe for fishing and swimming. We will achieve a net gain of wetlands by preventing additional losses and restoring hundreds of thousands of acres of wetlands. Soil erosion and runoff of phosphorus and nitrogen into watersheds will be minimized, helping to sustain the nation's farming economy and aquatic systems. The nation's waters will be free of effects of sewage discharges.

Clean Water Act Secondary Treatment Standards (40 CFR § 133.102)

The following paragraphs describe the minimum level of effluent quality attainable/acceptable by secondary treatment in terms of the parameters - BOD5, SS and pH. All requirements for each parameter shall be achieved except as provided for in §§ 133.103 and 133.105.

(a) *BOD5*.

- (1) The 30-day average shall not exceed 30 mg/l.
- (2) The 7-day average shall not exceed 45 mg/l.
- (3) The 30-day average percent removal shall not be less than 85 percent.
- (4) At the option of the NPDES permitting authority, in lieu of the parameter BOD5 and the levels of the effluent quality specified in paragraphs (a)(1), (a)(2) and (a)(3), the parameter CBOD5 may be substituted with the following levels of the CBOD5 effluent quality provided:
 - (i) The 30-day average shall not exceed 25 mg/l.
 - (ii) The 7-day average shall not exceed 40 mg/l.
 - (iii) The 30-day average percent removal shall not be less than 85 percent.

(b) *SS*. (1) The 30-day average shall not exceed 30 mg/l.

- (2) The 7-day average shall not exceed 45 mg/l.
- (3) The 30-day average percent removal shall not be less than 85 percent.

(c) *pH*. The effluent values for pH shall be maintained within the limits of 6.0 to 9.0 unless the publicly owned treatment works demonstrates that: (1) Inorganic chemicals are not added to the waste stream as part of the treatment process; and (2) contributions from industrial sources do not cause the pH of the effluent to be less than 6.0 or greater than 9.0.

Terms used in this part are defined as follows:

- (a) *7-day average*. The arithmetic mean of pollutant parameter values for samples collected in a period of 7 consecutive days.
- (b) *30-day average*. The arithmetic mean of pollutant parameter values of samples collected in a period of 30 consecutive days.
- (c) *Act*. The Clean Water Act (33 U.S.C. 1251 *et seq.*, as amended).
- (d) *BOD*. The five day measure of the pollutant parameter biochemical oxygen demand (BOD).
- (e) *CBOD5*. The five day measure of the pollutant parameter carbonaceous biochemical oxygen demand (CBOD5).
- (f) *Effluent concentrations consistently achievable through proper operation and maintenance*. (1) For a given pollutant parameter, the 95th percentile value for the 30-day average effluent quality achieved by a treatment works in a period of at least two years, excluding values attributable to upsets, bypasses, operational errors, or other unusual conditions, and (2) a 7-day average value equal to 1.5 times the value derived under paragraph (f)(1) of this section.

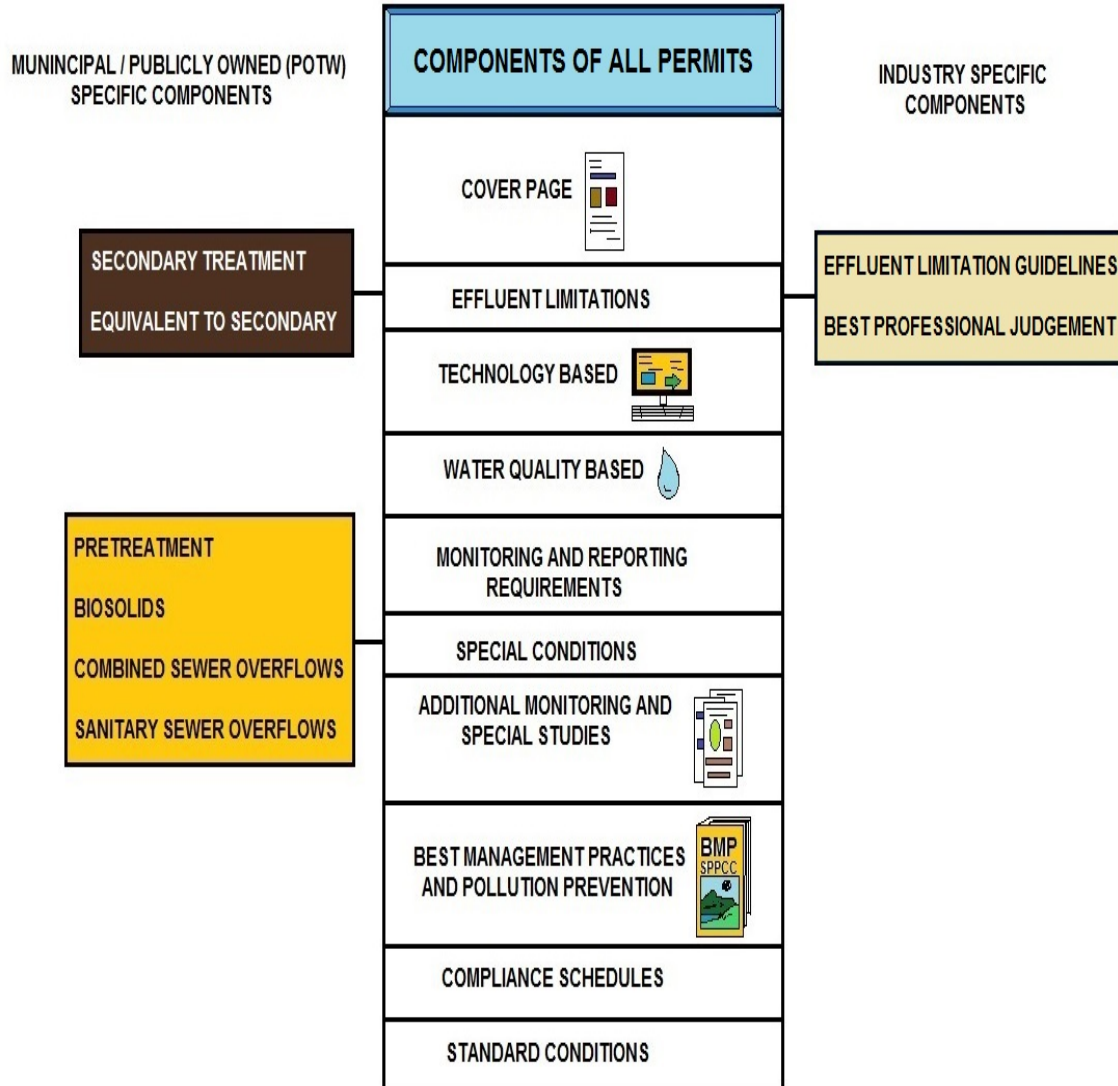

NPDES PERMIT COMPONENTS

NPDES Permit Foreword

Once a wastewater plant is designed and built, state or federal agencies will determine the type of permit required using the information illustrated above. You will need to understand that this discharge permit is your legal standard for proper sampling, treatment and discharging.

You must abide by your permit requirements and not deviate from them based on information presented in this course.

Wastewater Treatment Process Introduction

During the early days of our nation's history, people living in both the cities and the countryside used cesspools and privies to dispose of domestic wastewater. Cities began to install wastewater collection systems in the late nineteenth century because of an increasing awareness of waterborne disease and the popularity of indoor plumbing and flush toilets.

The use of sewage collection systems brought dramatic improvements to public health, further encouraging the growth of metropolitan areas. In the year 2000, approximately 208 million people in the U.S. were served by centralized collection systems.

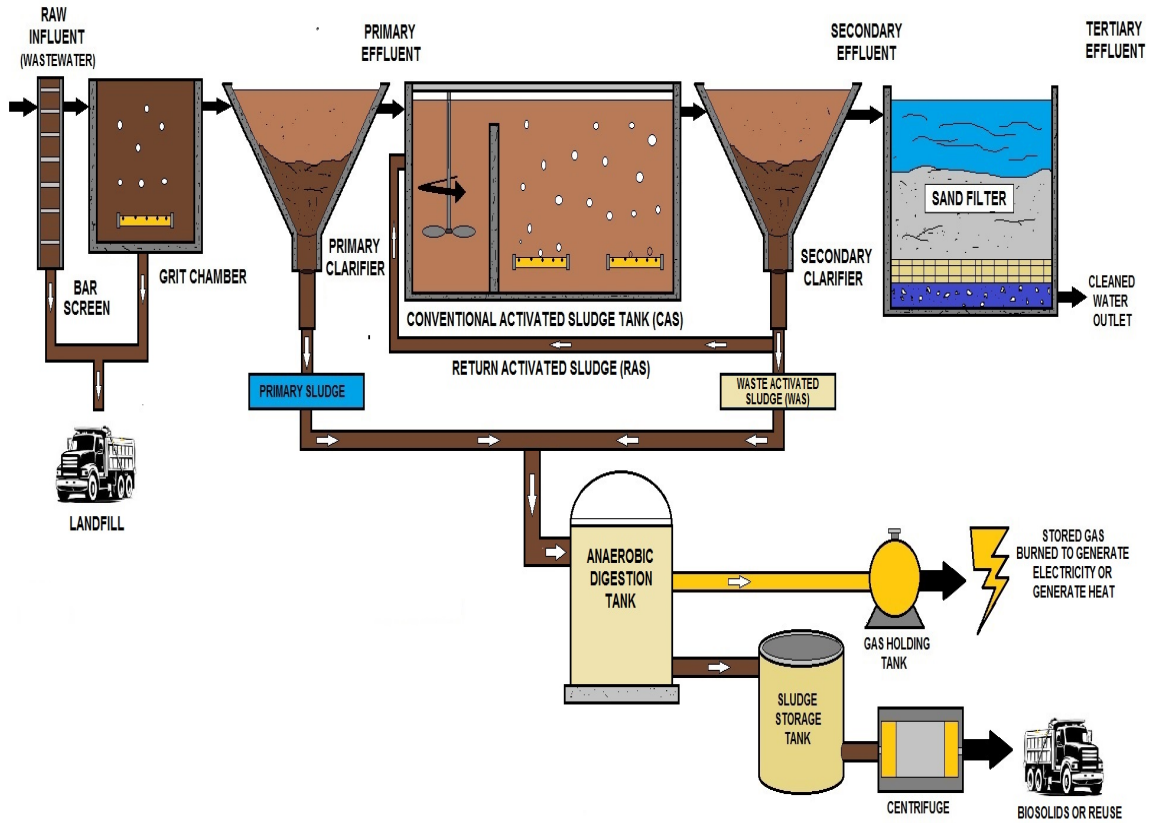

DIAGRAM OF TYPICAL WASTEWATER TREATMENT

Physical, Biological or Chemical Wastewater Treatments

There are two wastewater treatment processes include chemical and physical and biological wastewater treatment.

1. Physical waste treatment plants may use chemical reactions as well as physical processes to treat wastewater.
2. Biological treatment systems are ideal for treating wastewater from households and business premises. Biological waste treatment plants use mostly bacteria to break down waste matter.

Primary Treatment

As sewage enters a plant for treatment, it flows through a screen, which removes large floating objects such as rags and sticks that might clog pipes or damage equipment. After sewage has been screened, it passes into a grit chamber, where cinders, sand, and small stones settle to the bottom. A grit chamber is particularly important in communities with combined sewer systems where sand or gravel may wash into sewers along with storm water. After screening is completed and grit has been removed, sewage still contains organic and inorganic matter along with other suspended solids.

These solids are minute particles that can be removed from sewage in a sedimentation tank. When the speed of the flow through one of these tanks is reduced, the suspended solids will gradually sink to the bottom, where they form a mass of solids called raw primary biosolids (formerly sludge).

Biosolids are usually removed from tanks by pumping, after which it may be further treated for use as a fertilizer, or disposed of in a land fill or incinerated. Over the years, primary treatment alone has been unable to meet many communities' demands for higher water quality. To meet them, cities and industries normally treat to a secondary treatment level, and in some cases, also use advanced treatment to remove nutrients and other contaminants.

Secondary Treatment

The secondary stage of treatment removes about 85 percent of the organic matter in sewage by making use of the bacteria in it. The principal secondary treatment techniques used in secondary treatment are the trickling filter and the activated sludge process. After effluent leaves the sedimentation tank in the primary stage it flows or is pumped to a facility using one or the other of these processes. A trickling filter is simply a bed of stones from three to six feet deep through which sewage passes.

More recently, interlocking pieces of corrugated plastic or other synthetic media have also been used in trickling beds. Bacteria gather and multiply on these stones until they can consume most of the organic matter. The cleaner water trickles out through pipes for further treatment. From a trickling filter, the partially treated sewage flows to another sedimentation tank to remove excess bacteria. The trend today is towards the use of the activated sludge process instead of trickling filters.

The activated sludge process speeds up the work of the bacteria by bringing air and sludge heavily laden with bacteria into close contact with sewage. After the sewage leaves the settling tank in the primary stage, it is pumped into an aeration tank, where it is mixed with air and sludge loaded with bacteria and allowed to remain for several hours. During this time, the bacteria break down the organic matter into harmless by-products.

The sludge, now activated with additional billions of bacteria and other tiny organisms, can be used again by returning it to the aeration tank for mixing with air and new sewage. From the aeration tank, the partially treated sewage flows to another sedimentation tank for removal of excess bacteria. To complete secondary treatment, effluent from the sedimentation tank is usually disinfected with chlorine before being discharged into receiving waters. Chlorine is fed into the water to kill pathogenic bacteria, and to reduce odor.

What Exactly is in Wastewater?

Wastewater is mostly water by weight. Other materials make up only a small portion of wastewater, but can be present in large enough quantities to endanger public health and the environment. Because practically anything that can be flushed down a toilet, drain, or sewer can be found in wastewater, even household sewage contains many potential toxic pollutants. The wastewater components that should be of most concern to homeowners and communities are those that have the potential to cause disease or detrimental environmental effects. Domestic wastewater is typically composed of more than 99% water and only a small portion of the 1% may include components that endanger public health or the environment. Other materials make up only a small portion of wastewater, but can be present in large enough quantities to endanger public health and the environment.

Domestic Wastewater Quality Characteristics

Typical Composition of Untreated Domestic Wastewater -Table 1

PARAMETER	UNIT ³	CONCENTRATED	MODERATE	DILUTED	VERY DILUTED
Biochemical oxygen demand (BOD)	g O ₂ /m ³				
Infinite BOD	g O ₂ /m ³	530	380	230	150
7-day BOD	g O ₂ /m ³	400	290	170	115
5-day BOD	g O ₂ /m ³	350	250	150	100
Dissolved BOD	g O ₂ /m ³	140	100	60	40
Dissolved BOD Very Easily Degradable	g O ₂ /m ³	70	50	30	20
After 2 hours of settling	g O ₂ /m ³	250	175	110	70
Total nitrogen	g N/m ³	80	50	30	20
Ammonium nitrogen ¹	g N/m ³	50	30	18	12
Nitrite nitrogen	g N/m ³	0.1	0.1	0.1	0.1
Nitrate nitrogen	g N/m ³	0.5	0.5	0.5	0.5
Organic nitrogen	g N/m ³	30	20	12	8
Kjeldahl nitrogen ²	g N/m ³	80	50	30	20
Total phosphorus	g P/m ³	14	10	6	4
Orthophosphate	g P/m ³	10	7	4	3
Polyphosphate	g P/m ³	0	0	0	0
Organic phosphate	g P/m ³	4	3	2	1

Legend

¹ NH₃+NH₄⁺

² org-(N+NH₃ + NH₄⁺)

³ g/m³ = mg/L = ppm

Reference: Henze, Mogens, Paul Harremoes, Jes la Cour Jansen, and Eric Arvin, "Wastewater Treatment, Biological and Chemical Processes." Third Edition. Berlin. Springer-Verlag 2002. Specially, the data is from Table 1.7, Typical organic matter in domestic wastewater (p. 28) and Table 1.8 Typical content of nutrients in domestic wastewater (p. 29)

Typical Composition of Untreated Domestic Wastewater -Table 2

CONTAMINANTS	UNITS	LOW STRENGTH	MEDIUM STRENGTH	HIGH STRENGTH
Solids, total (TS)	mg/L	390	720	1220
Dissolved, total (TDS)	mg/L	270	500	860
Fixed	mg/L	160	300	520
Volatile	mg/L	110	200	340
Suspended solids, total (TSS)	mg/L	120	210	400
Fixed	mg/L	25	50	85
Volatile	mg/L	95	160	315
Settleable solids	mg/L	5	10	20
Biochemical Oxygen Demand				
5-d, 20°C (BOD ₅ 20°C)	mg/L	110	190	350
Total organic carbon	mg/L	80	140	260
Chemical oxygen demand (COD)	mg/L	250	430	800
Nitrogen (total as N)	mg/L	20	40	70
Organic	mg/L	8	15	25
Free ammonia	mg/L	12	25	45
Nitrites	mg/L	0	0	0
Nitrates	mg/L	0	0	0
Phosphorus (total as P)	mg/L	4	7	12
Organic	mg/L	1	2	4
Inorganic	mg/L	3	5	10
Chlorides	mg/L	30	50	90
Sulfate	mg/L	20	30	50
Oil and Grease	mg/L	50	90	100
Volatile organic compounds (VOCs)	mg/L	<100	100-400	>400
Total coliform	No./100 mL	10 ⁶ -10 ⁸	10 ⁷ -10 ⁹	10 ⁷ -10 ¹⁰
Fecal Coliform	No./100 mL	10 ³ -10 ⁵	10 ⁴ -10 ⁶	10 ⁵ -10 ⁸
Cryptosporidium oocysts	No./100 mL	10 ⁻¹ – 10 ⁰	10 ⁻¹ -10 ¹	10 ⁻¹ -10 ²
Giardia lamblia cysts	No./100 mL	10 ⁻¹ -10 ¹	10 ⁻¹ -10 ²	10 ⁻¹ -10 ³

Source: Metcalf & Eddy. "Wastewater Engineering Treatment and Reuse. 4th ed. Boston. McGraw-Hill, 2003 (p.186)

This course contains general EPA's federal rule requirements. Please be aware that each state implements wastewater/safety/environment regulations that may be more stringent than EPA's regulations. Check with your permit or state environmental agency for more information.

Conventional Wastewater Treatment Processes

Physical or Primary Treatment

Physical processes were some of the earliest methods to remove solids from wastewater, usually by passing wastewater through screens to remove debris and larger solids. In addition, solids that are heavier than water will settle out from wastewater by gravity. Particles with entrapped air float to the top of water and can also be removed. These physical processes are employed in many modern wastewater treatment facilities today.

Chemical

Chemicals can be used to create changes in pollutants that increase the removal of these new forms by physical processes. Simple chemicals such as alum, lime or iron salts can be added to wastewater to cause certain pollutants, such as phosphorus, to floc or bunch together into large, heavier masses which can be removed faster through physical processes.

Over the past 30 years, the chemical industry has developed synthetic inert chemicals known as polymers to further improve the physical separation step in wastewater treatment. Polymers are often used at the later stages of treatment to improve the settling of excess microbiological growth or biosolids.

Biological or Secondary Treatment

In nature, bacteria in water consume organic matter to grow and reproduce. Aerobic bacteria near the water surface, where oxygen is present, produce carbon dioxide as a by-product. Anaerobic bacteria in or near the bottom sediments, where there is little or no oxygen, produce methane and smaller amounts of other gases as a byproduct.

The bacteria normally present in water must have oxygen to do their part in breaking down the sewage.



Anaerobic Digester

In the 1920s, scientists observed that these natural processes could be contained and accelerated in systems to remove organic material from wastewater. With the addition of oxygen to wastewater, masses of microorganisms grew and rapidly metabolized organic pollutants. Any excess microbiological growth can be removed from the wastewater by physical processes. Activated Sludge is a suspended growth process for removing organic matter from sewage by supplying or saturating it with air and microorganisms that can break down the organic matter. Advanced Treatment involves treatment levels beyond secondary treatment.

The mass of bacteria in an aeration tank came to be called “mixed liquor”. Here, floating bacteria stick to organic matter forming small clumps called “floc”. Floc is slightly denser than water so once the mixed liquor flows into a tank not being agitated by the addition of oxygen, it settles to the bottom. From here, some is returned to the head of the aeration tank to maintain the bacterial population. This is called returned activated sludge (RAS). Excess is removed (or “wasted”) from the system. This is waste activated sludge (WAS).

Part of the job of a wastewater plant operator is to adjust the waste and return rates to maintain the optimum ratio of bacteria to the fluctuating amount of organic matter arriving as primary tank effluent. If there are too few bacteria, they won't remove enough organics to meet permit requirements. If there are too many, they will not have enough to eat, and their removal efficiency will decline.

Organisms

Many different types of organisms live in wastewater and some are essential contributors to treatment. A variety of bacteria, protozoa, and viruses work to break down certain carbon-based (organic) pollutants in wastewater by consuming them. Through this process, organisms turn wastes into carbon dioxide, water, and new cell growth.

Bacteria and other microorganisms are particularly plentiful in wastewater and accomplish most of the treatment. Most wastewater treatment systems are designed to rely in large part on biological processes. We will cover this area in greater detail later in the course.

Pathogens

Many disease-causing viruses, parasites, and bacteria also are present in wastewater and enter from almost anywhere in the community. These pathogens often originate from people and animals that are infected with or are carriers of a disease.

Graywater and blackwater from typical homes contain enough pathogens to pose a risk to public health. Other likely sources in communities include hospitals, schools, farms, and food processing plants.

Some illnesses from wastewater-related sources are relatively common. Gastroenteritis can result from a variety of pathogens in wastewater, and cases of this illness caused by the parasitic protozoa *Giardia lamblia* and *Cryptosporidium* are not unusual in the U.S.

Other important wastewater-related diseases include hepatitis A, typhoid, polio, cholera, and dysentery.

Outbreaks of these diseases can occur as a result of drinking water from wells polluted by wastewater, eating contaminated fish, or recreational activities in polluted waters. Some illnesses can be spread by animals and insects that come in contact with wastewater.

Even municipal drinking water sources are not completely immune to health risks from wastewater pathogens. Drinking water treatment efforts can become overwhelmed when water resources are heavily polluted by wastewater. For this reason, wastewater treatment is as important to public health as drinking water treatment. We will cover this area in greater detail later in the course.

Introduction to Activated Sludge (A/S)

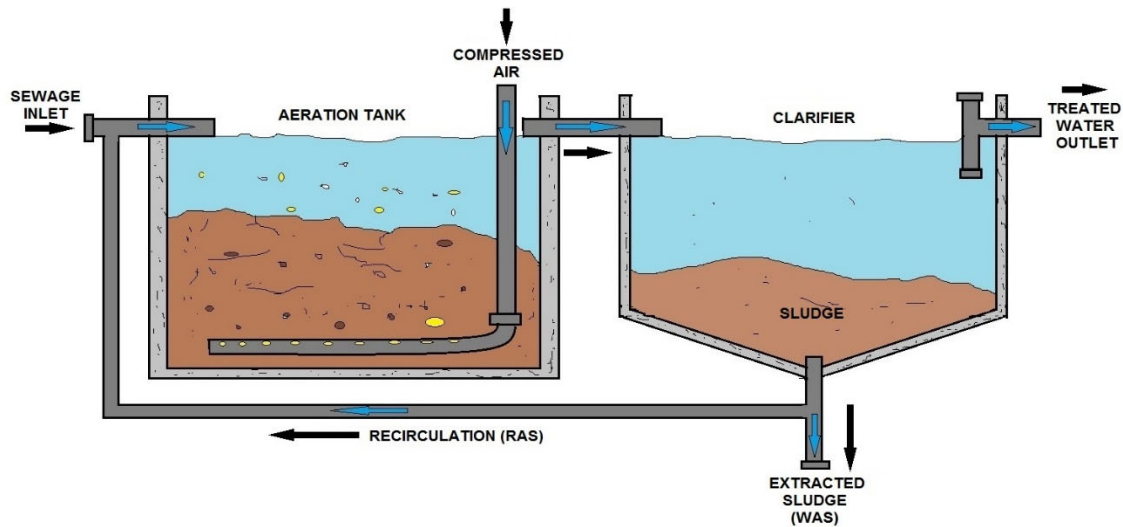

SIMPLIFIED ACTIVATED SLUDGE DIAGRAM

Quick introduction of some key biological information and we will return to this subject later in the book.

The Activated Sludge Process is an aerobic biological wastewater treatment process that uses microorganisms, including bacteria, fungi, and protozoa, to speed up decomposition of organic matter requiring oxygen for treatment. In activated sludge, microorganisms are thoroughly mixed with wastewater (organics) under conditions that stimulate their growth and waste materials are removed. As the microorganisms (bugs) grow and are mixed by the agitation of the air, the bugs will clump (or *flocculate*) together to form a mass of microbes called **activated sludge**.

When introduced into a clarifier, the microorganisms in the A/S process take advantage of aerobic microorganisms or populations that can digest organic matter in wastewater, and clump together by flocculation and settle out. This action produces a liquid that is relatively free from suspended solids and organic material, and flocculated particles that will readily settle out and can be removed. We will cover all these details later in the course manual.

Mixed Liquor

Atmospheric air or sometimes pure oxygen is bubbled through primary treated sewage (or industrial wastewater) and combined with Return Activated Sludge (RAS) organisms to develop a biological floc which reduces the organic content of the sewage. The combination of raw sewage and biological mass is commonly known as Mixed Liquor.

In all activated sludge plants, once the wastewater has received sufficient treatment, the mixed liquor is discharged or flows into settling tanks. The treated supernatant of clarified water often undergoes further treatment before discharge.

Return Activated Sludge

Most of the settled material, the sludge (RAS), is returned to the head of the aeration system to re-seed the new sewage entering the tank. Mixed Liquor is a mixture of raw or settled wastewater and activated sludge within an aeration tank.

Mixed Liquor Suspended Solids (MLSS) is the concentration of suspended solids in the mixed liquor, usually expressed in milligrams per liter (mg/l).

The arrangement of a conventional activated sludge process for removing carbonaceous pollution includes the following items:

- Aeration tank where air (or oxygen) is injected in the mixed liquor.
- Settling tank (usually referred to as "final clarifier" or "secondary settling tank") to allow the biological flocs (the sludge blanket) to settle, thus separating the biological sludge from the clear treated water.

Sometimes activated sludge is used to feed bugs to various tanks, BNR processes, fixed-film filters, lagoons and oxidation ditches. There are times that A/S bugs will be transported to another plant for maintenance or start-ups.

Nitrogenous matter or phosphate treatment involves additional steps where the mixed liquor is left with no residual dissolved oxygen. Again, we will cover this subject later in the course.

Sludge Volume Index (SVI) Introduction

Historically, the Sludge Volume Index (SVI) has been used most commonly as a measure of sludge settleability. It is defined as the volume in milliliters occupied by 1 g of the suspended solids or activated sludge following 30 minutes of unstirred settling of the aeration basin MLSS. The test may be carried out in a 1 or 2 L settling column.

Sludge settleability is central to the health of the biological system. It is important to point out that settleability is influenced by conditions in the activated sludge basin but manifests itself in the clarifier. Poor settling sludge causes lower solids concentration requiring higher RAS rates to maintain a given MLSS in the activated sludge basin. Consequently, measuring sludge settleability is fundamental to the operation and control of the biological system.

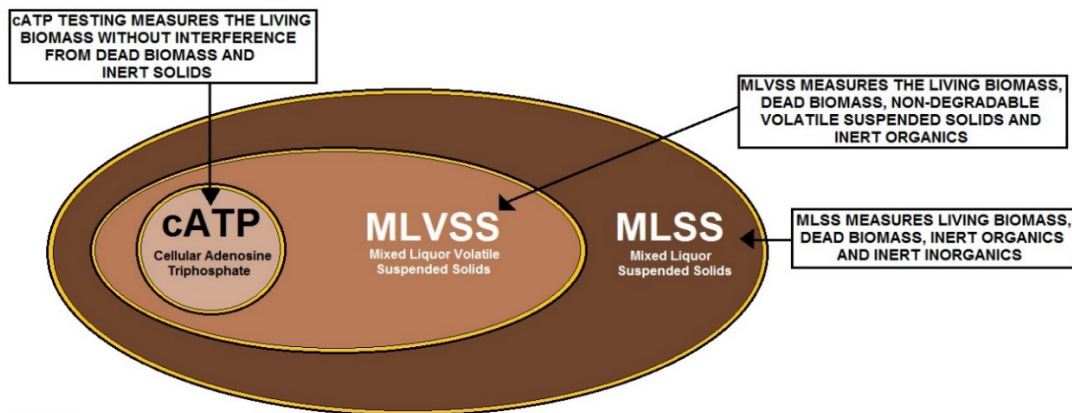

COMPARATIVE WASTEWATER TESTING

Primary Wastewater Pollutant Effects

We will cover all these effects in detail later.

Effect of BOD

- Depletes dissolved oxygen from streams, lakes and oceans.
- May cause death of aerobic organisms (fish kills, etc.).
- Increases anaerobic properties of water.

Effect of TSS

- **Increases turbidity**
 - Less light - reduced photosynthesis.
 - Causes fish's gills to get plugged up.
- **Increases silting**
 - Reduces lifetime of lakes.
 - Changes benthic (i.e., bottom) ecology.

Effects of Phosphorous and Nitrogen

- **Increases algal photosynthesis (eutrophication)**
 - Increased plant life on surface.
 - Reduces light in lower levels.
 - Decreases P and N in lower levels

Additional Effects of Nitrogen

- Organic nitrogen and ammonia are converted to nitrates in water.
- Nitrates are converted to nitrites in digestive system.
- Nitrites are assimilated into blood stream where they are converted by respired oxygen to nitrates.
- May cause suffocation (blue baby syndrome).

Effect of pH

- Organisms are very susceptible to acids and bases.
- Recommended to have near neutral conditions (6.5 - 8.5).

Effect of Pathogens

May infect:

- Humans
- Animals



Domestic waste overflow at a WWTP headworks. Sometimes headworks do overflow, usually due to rags, grease and debris, or operator error. We do not like to see this happening!

PRIMARY TREATMENT
PHYSICAL PROCESS
BAR SCREENS
GRIT CHAMBERS
SETTLING BASINS

SECONDARY TREATMENT
BIOLOGICAL PROCESS
PONDS / LAGOONS
OXIDATION DITCHES
ACTIVATED SLUDGE

TERTIARY TREATMENT
CHEMICAL / PHYSICAL PROCESS
FILTER AIDS
FILTRATION
WETLAND

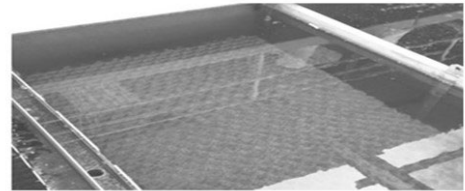

CONVENTIONAL WASTEWATER TREATMENT

- PRIORITY POLLUTANTS
- PHARMACEUTICALS
- HEAVY METALS
- BIODEGRADABLE SOLIDS
- DISSOLVED INORGANICS
- NUTRIENTS
- SOLIDS
- PATHOGENS AND PARASITES



WASTEWATER TREATMENT OVERLOAD INDICATORS

Primary Wastewater Components and Constituents

Important Wastewater Characteristics

In addition to the many substances, (liquids, inorganics-solids, trash, contaminants) found in wastewater, there are other characteristics system engineers and operators use to evaluate wastewater. For example, the color, temperature, pH, odor, DO, Total Solids and turbidity of wastewater give clues about the amount and type of pollutants present and treatment necessary. We will examine these characteristics, which can affect public health and the environment, as well as the design, cost, and effectiveness of treatment.

Essential Wastewater Treatment Terms

Aerobic (AIR-O-bick) – a condition in which free or dissolved oxygen is present in the aquatic environment.

Aerobic Bacteria (Aerobes) – bacteria which will live and reproduce only in an environment containing oxygen. Oxygen combined chemically, such as in water molecules (H_2O), cannot be used for respiration by aerobes.

Anaerobic (AN-air O-bick) - a condition in which “free” or dissolved oxygen is not present in the aquatic environment.

Anaerobic Bacteria (Anaerobes) – bacteria that thrive without the presence of oxygen.

Methane Fermenters – bacteria that break down the volatile acids to methane (CH_4) carbon dioxide (CO_2) and water (H_2O).

Saprophytic Bacteria – bacteria that break down complex solids to volatile acids.

Oxidation – the addition of oxygen to an element or compound, or removal of hydrogen or an electron from an element or compound in a chemical reaction. The opposite of reduction.

Reduction – the addition of hydrogen, removal of oxygen or addition of electrons to an element or compound. Under anaerobic conditions in wastewater, elemental sulfur and/or sulfur or compounds are reduced to H_2S or sulfide ions.

Organic Matter

Organic materials are found everywhere in our environment. These materials are composed of the carbon-based chemicals that are the building blocks of most living things. Organic materials in wastewater originate from plants, animals, or synthetic organic compounds, and enter wastewater in human wastes, paper products, detergents, cosmetics, foods, and from agricultural, commercial, and industrial sources.

Organic compounds normally are some combination of carbon, hydrogen, oxygen, nitrogen, and other elements. Many organics are proteins, carbohydrates, or fats and are biodegradable, which means they can be consumed and broken down by organisms. However, even biodegradable materials can cause pollution. In fact, too much organic matter in wastewater can be devastating to receiving waters.

Organic Waste Breakdown

Large amounts of biodegradable materials are dangerous to lakes, streams, and oceans, because organisms use dissolved oxygen in the water to break down the wastes. This can reduce or deplete the supply of oxygen in the water needed by aquatic life, resulting in fish kills, odors, and overall degradation of water quality. This is called eutrophication.

The amount of oxygen organisms need to break down wastes in wastewater is referred to as the biochemical oxygen demand (BOD) and is one of the measurements used to assess overall wastewater strength. Some organic compounds are more stable than others and cannot be quickly broken down by organisms, posing an additional challenge for treatment. This is true of many synthetic organic compounds developed for agriculture and industry.

In addition, certain synthetic organics are highly toxic. Pesticides and herbicides are toxic to humans, fish, and aquatic plants and often are disposed of improperly in drains or carried in stormwater. In receiving waters, they kill or contaminate fish, making them unfit to eat. They also can damage processes in treatment plants. Benzene and toluene are two toxic organic compounds found in some solvents, pesticides, and other products. New synthetic organic compounds are being developed all the time, which can complicate treatment efforts.

Fats, Oils and Grease (Scum)

Fatty organic materials from animals, vegetables, plastics and petroleum are not quickly broken down by bacteria and can cause pollution in receiving environments. When large amounts of oils and greases are discharged to receiving waters from WWTPS, they increase BOD and they may float to the surface and harden, causing aesthetically unpleasing conditions. They also can trap trash, plants, and other materials, causing foul odors, attracting flies and mosquitoes and other disease vectors. In some cases, too much oil and grease causes septic conditions in ponds and lakes by preventing oxygen from the atmosphere from reaching the water.

FAT AND GREASE REMOVAL

In some larger plants, fat and grease are removed by passing the sewage through a relatively small tank where skimmers collect the fat floating on the surface. Air blowers in the base of the tank may also be used to help recover the fat as a froth. Many plants, however, use primary clarifiers with mechanical surface skimmers for fat and grease removal.



Wastewater onsite (septic) systems also can be harmed by too much fats, oil and grease, which can clog onsite system drainfield pipes and soils, adding to the risk of system failure. Excessive grease also adds to the septic tank's scum layer, causing more frequent tank pumping to be required. Both conditions can result in significant costs to homeowners.

Petroleum-based waste oils used for motors and industry are considered hazardous waste and should be collected and disposed of separately from wastewater. They can be toxic to treatment bacteria and often are flammable.

Volatile Fatty Acid

Volatile fatty acid (VFA) analysis forms an important means of assessing the effectiveness of the digestion process within a wastewater treatment plant. This relatively new analytical technique provides wastewater treatment plant operators with a much improved means of being able to optimize the operation of the anaerobic digesters in the wastewater treatment plants.

Inorganics

Inorganic minerals, metals, and compounds, such as sodium, potassium, calcium, magnesium, cadmium, copper, lead, nickel, and zinc are common in wastewater from both residential and nonresidential sources. Some of these are a natural aspect of drinking water but others can originate from a variety of sources in the community including industrial and commercial sources, stormwater, and inflow and infiltration from cracked pipes and leaky manhole covers. Most inorganic substances are relatively stable, and cannot be broken down easily by organisms in wastewater.

Large amounts of many inorganic substances can contaminate soil and water. Some are toxic to animals and humans and may accumulate in the environment. For this reason, extra treatment steps are often required to remove inorganic materials from industrial wastewater sources. For example, heavy metals which are discharged with many types of industrial wastewaters are difficult to remove by conventional treatment methods.

Although acute poisonings from heavy metals in drinking water are rare in the U.S., potential long-term health effects of ingesting small amounts of some inorganic substances over an extended period of time are possible.

Nutrient Introduction (*we will return to this subject in detail later.*)

Wastewater often contains large amounts of the nutrients nitrogen and phosphorus in the form of nitrate and phosphate, which promote plant growth. Organisms only require small amounts of nutrients in biological treatment, so there normally is an excess available in treated wastewater.

Excessive nutrients in receiving waters cause algae and other plants to grow quickly depleting oxygen in the water. Water that is deprived of oxygen, fish and other aquatic life die, emitting foul odors as they anaerobically decompose.

Nutrients from wastewater have also been linked to ocean "red tides" that poison fish and cause illness in humans. Nitrogen in drinking water may contribute to miscarriages and is the cause of a serious illness in infants called methemoglobinemia or "blue baby syndrome."

NUTRIENTS

Nutrients are components that a plant or animal uses to survive and grow. Macronutrients provide the bulk energy an organism's metabolic system needs to function while micronutrients provide the necessary cofactors for metabolism to be carried out. Both types of nutrients are usually acquired from the environment, although some can be manufactured by bacteria, fungus and plants.

Carbon, nitrogen, and phosphorus are essential to living organisms and are the chief nutrients present in natural water. Large amounts of these nutrients are also present in sewage, certain industrial wastes, and drainage from fertilized land.

Conventional secondary biological treatment processes do not remove the phosphorus and nitrogen to any substantial extent. They may convert the organic forms of these substances into a more simple mineral form, making them more usable by plant life.

An excess of nutrients, primarily phosphorus but occasionally nitrogen, causes nutrient enrichment that results in excessive growth of algae. Uncontrolled algae growth blocks out sunlight and chokes aquatic plants and animals by depleting dissolved oxygen in the water at night.

Because nutrients are very essential to the process, we will cover this subject in several different sections.

Gases

Certain gases in wastewater can cause odors, affect treatment, or are potentially dangerous. Methane gas, for example, is a byproduct of anaerobic biological treatment and is highly combustible. Special precautions need to be taken near septic tanks, manholes, treatment plant headworks, and other areas where wastewater gases can be created and collect.

ODORS

Odors emitted by sewage treatment are typically an indication of an anaerobic or "septic" condition. Early stages of processing will tend to produce foul-smelling gases, with hydrogen sulfide being most common in generating complaints. Large process plants in urban areas will often treat the odors with carbon reactors, a contact media with bio-slimes, small doses of chlorine, or circulating fluids to biologically capture and metabolize the noxious gases. Other methods of odor control exist, including addition of iron salts, hydrogen peroxide, calcium nitrate to manage hydrogen sulfide levels.



Solids Introduction

Wastewater contains nutrients of every type; phosphorus, nitrogen, sodium, potassium, iron, calcium and compounds such as fats, carbohydrates (sugars) and proteins. Microorganisms use these substances as a “food” source for energy, for the synthesis of cell components to reproduce and to maintain life processes.

Many types of microorganisms can be found in the wastewater treatment system. However, the types of organisms that will dominate will be the ones that are best suited to the “environment” or conditions in the system.

Organic and/or Inorganic Materials

Solid materials in wastewater can consist of organic and/or inorganic materials and organisms. The solids must be significantly reduced by treatment or an excessive amount of BOD will be discharged to receiving waters. Solids are removed because they provide places for microorganisms to escape disinfection. They also can clog soil absorption fields in onsite systems.

Settleable Solids

Certain substances, such as sand, grit, and denser than water organic and inorganic materials settle out from the rest of the wastewater collection system or stream during the primary treatment tanks. On the bottom of settling tanks and ponds, organic material makes up a biologically active layer of sludge that aids in treatment. During normal plant operation, only small amounts of settleable solids are discharged.

Suspended Solids

Materials that resist settling may remain suspended in wastewater, especially if the wastewater is moving. Suspended solids needs to be reduced to a low level to not interfere with disinfection systems or lower the water quality of the receiving water. Suspended solids in wastewater must be treated, or they will clog soil absorption systems or reduce the effectiveness of disinfection systems.

Dissolved Solids

Small particles of certain wastewater materials can dissolve, like salt in water. Some dissolved materials are consumed by microorganisms in wastewater. Others dissolved solids, such as heavy metals, are difficult to remove by conventional treatment. Excessive amounts of dissolved solids in wastewater can have adverse effects on the environment. Total dissolved solids is a parameter used to determine water quality based on the total substances that are fully dissolved within the water, rather than undissolved suspended particles after the water sample is filtered, evaporated of water will reveal the TDS.

Total Suspended Solids (TSS)

Total suspended solids (TSS) is the dry weight of suspended particles that are not dissolved, in a sample of water that can be trapped by a filter that is analyzed using a filtration apparatus. It is a water quality parameter used to assess any type of water for example, wastewater before or after treatment in a wastewater treatment plant. It is a conventional pollutant in the U.S. Clean Water Act.

Types of Solids in Wastewater

ACRONYM	COMMON TERM	EXPLANATION
TSS	Total Suspended Solids	Solids that cannot pass through a 1.2- μm filter.
TVSS	Total Volatile Suspended Solids	Solids that cannot pass through a 1.2 - μm filter and are burned away when placed in a furnace at 550° C.
TDS	Total Dissolved Solids	Solids that are small enough to pass through a 1.2 - μm filter. The sample must be dried completely before the dissolved solids can be seen with the naked eye.
TS	Total Solids	All of the solid material in a sample. This includes both organic and inorganic solids. $TS = TSS + TDS$
TVS	Total Volatile Solids	All of the solids in a sample that are burned away when placed in a furnace at 550° C

Hydrogen Sulfide and Ammonia Sub-Section

Hydrogen sulfide and ammonia gases can be toxic and pose asphyxiation hazards. Ammonia as a dissolved gas found in wastewater and is dangerous to fish. Both gases emit odors, which can be a serious nuisance even in low concentrations.

Unless effectively contained or minimized by design and location, wastewater odors can affect the mental well-being and quality of life of residents. Sewer related odors can lower property values and affect the local economy. Note: Ammonia odors are virtually never a problem in a WWTP. Ammonia stays dissolved in the water.

Hydrogen sulfide production in collection systems can cause a number of problems such as corrosion of the pipes, manholes, and creation of hazardous atmospheres and foul odors. Hydrogen sulfide or H₂S problems are very common in the sewer collection and wastewater system. There are many chemicals used to help or treat this problem. Here are a few used in the treatment of hydrogen sulfide problems: Salts of zinc, lime, hydrogen peroxide, chlorine and magnesium hydroxide.

AMMONIA

Ammonia is a compound of nitrogen and hydrogen with the formula NH₃. The simplest nitrogen hydride, ammonia, is a colorless gas with a characteristic pungent smell. It is a common nitrogenous waste, particularly among aquatic organisms, and it contributes significantly to the nutritional needs of terrestrial organisms, nitrogen is a necessary growth material for plants. Too much ammonia is toxic for aquatic life.

HYDROGEN SULFIDE

Hydrogen sulfide is the compound with the chemical formula H₂S. It is a colorless gas with the characteristic foul odor of rotten eggs. It is very poisonous, corrosive, and flammable. Hydrogen sulfide is often produced from the microbial breakdown of organic matter in the absence of oxygen gas, such as in swamps and sewers. This process is commonly known as anaerobic digestion and is done by sulfate-reducing microorganisms.

Hydrogen sulfide conditions occur in the sewer system because of the lack of oxygen. The best method of controlling hydrogen sulfide is to eliminate its habitat or growth area by keeping sewers cleaner. This will speed the sewage flow and harbor fewer slime bacteria.

Here are some important statements regarding the reduction of hydrogen sulfide: salts of zinc and iron may precipitate sulfides. Lime treatments can also kill bacteria that produce hydrogen sulfide, but this creates a sludge disposal problem and chlorination is effective at reducing the bacteria that produce hydrogen sulfide.

Nutrient Introduction

Nutrients in quantities that exceed the affected waterbody's ability to assimilate them results in a condition called eutrophication or cultural enrichment. When an excess of these nutrients over-stimulates the growth of water plants, the result causes unsightly conditions, interferes with boating activities and drinking water treatment processes, and causes unpleasant and disagreeable tastes and odors in drinking water. It may be linked to harmful Algae Blooms (HABS) which are similar to the recently mentioned "red tides" where the algae produces toxins dangerous to humans and animals.

Uncontrolled algae growth blocks out sunlight and chokes aquatic plants and animals by depleting dissolved oxygen in the water at night. Oxygen is also depleted by the decomposition of excessive amounts of dead algae and plants. The release of nutrients in quantities that exceed the affected waterbody's ability to assimilate them results in a condition called eutrophication or cultural enrichment.

Influent wastewater contains the micronutrients nitrogen, potassium and phosphorus as well as trace nutrients like iron and manganese.

Nitrogen is present in many compounds in wastewater influent including urea or urine, organically bound nitrogen (proteins and other compounds), and ammonia.

Organically bound nitrogen can be soluble or particulate, whereas ammonia is only present as soluble. Phosphorus is found in particulate or dissolved forms. Phosphorus is present in proteins, urine and detergents. *Much more information on this subject is in the Nutrient section.*

WASTEWATER ANALYTICAL CATEGORIES	
ORGANICS	BOD (Biological Oxygen Demand) COD (Chemical Oxygen Demand) TOC (Total Organic Carbon) O&G (Oil and Grease)
SOLIDS	TS (Total Solids) TVS (Total Volatile Solids) TSS (Total Suspended Solids)
PHYSICAL PROPERTIES	pH (0 to 14 pH Scale) Temperature Turbidity Color & Odor
NUTRIENTS	NH (Nihonium) TKN (Total Kjeldahl Nitrogen) N-N (Nitrate to Nitrite) TP (Total Phosphorus)

INTERACTIONS OF WWT ANALYTICAL CATEGORIES AND LAB TESTS

Biological Components Sub-Section - Introduction

Biochemical Oxygen Demand or BOD Introduction

Wastewater is composed of a variety of inorganic and organic substances.

Organic substances refer to molecules that are based on carbon and include fecal matter as well as detergents, soaps, fats, greases and food particles (especially where garbage grinders are used). Most of these large organic molecules can be easily decomposed by bacteria in a WWTP or homeowner's septic system.

However, oxygen is required for this process of breaking large molecules into smaller molecules and eventually into carbon dioxide and water. The amount of oxygen required for this process is known as the biochemical oxygen demand or BOD.

The five-day BOD, or BOD₅ lab test, is measured by the quantity of oxygen consumed by microorganisms or bacteria under controlled conditions during a five-day period, and is the most common measure of the amount of biodegradable organic material in, or strength of, sewage.

We will cover this area in detail in several different areas of this course. We will cover this area in about ten more pages and again in the Microorganism and Laboratory Sections. Please make notes on this potentially challenging subject.

Biochemical Oxygen Demand

Biochemical Oxygen Demand (BOD or BOD₅) is an indirect measure of biodegradable organic compounds in water, and is determined by measuring the dissolved oxygen decrease in a controlled water sample over a five-day period.

During the five day incubation period, **aerobic** bacteria (oxygen-consuming) decompose organic matter in the sample and consumes dissolved oxygen in proportion to the amount of organic material that is present. A high BOD concentration of substance can be biologically degraded, thus consuming oxygen in a natural environment this could possibly result in low dissolved oxygen in the receiving water.

The BOD test was developed for samples dominated by oxygen-demanding pollutants like sewage. While its merit as a pollution parameter continues to be debated, BOD has the advantage of a long period of record and many comparative analyses on domestic sewage.

Organic Carbon

Most organic carbon in water occurs as partly degraded plant and animal materials, some of which are resistant to microbial degradation.

Organic carbon is important in the estuarine food web and is incorporated into the ecosystem by photosynthesis of green plants, which are then consumed as carbohydrates and other organic compounds by higher animals. In another process, formerly living tissue containing carbon is decomposed as detritus by bacteria and other microbes.

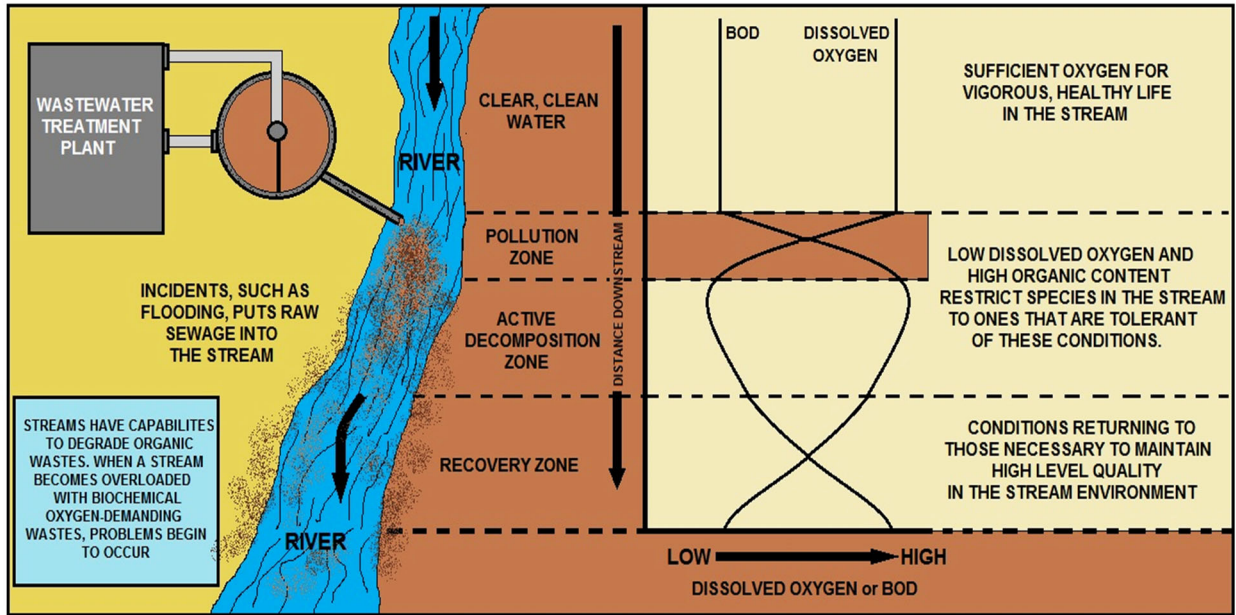

EFFECTS OF BOD ON WATER QUALITY

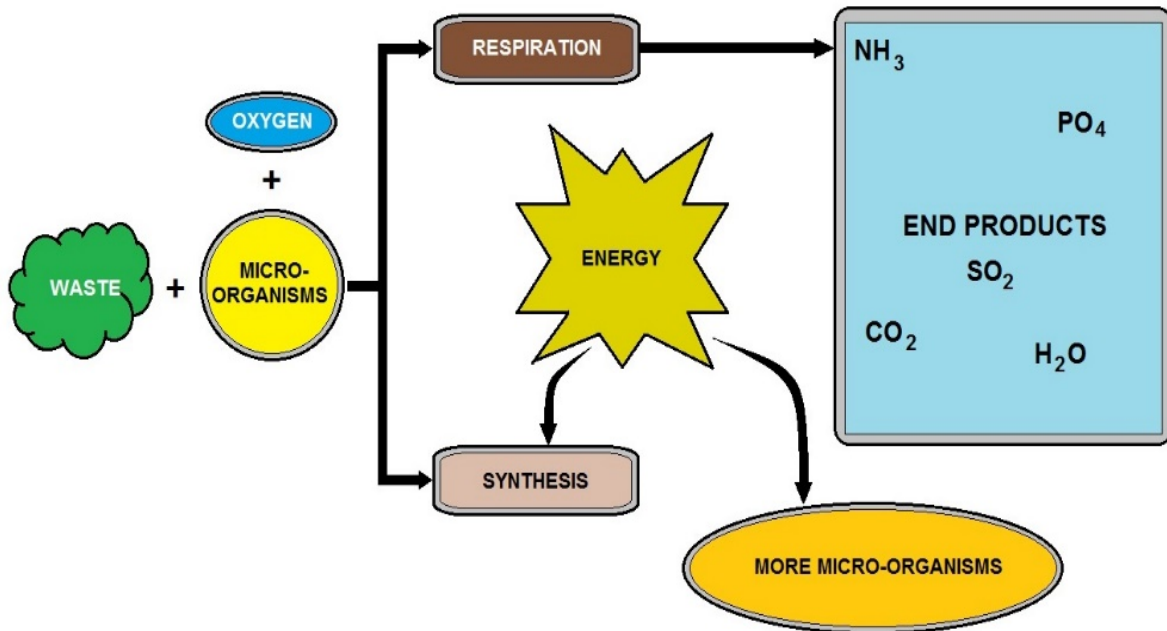

MICROORGANISM BREAKDOWN DIAGRAM

Chemical Reaction Introduction

There are thousands of chemical reactions involved in the metabolism of a bacterium. The above diagram identifies major processes that are relevant to the biological treatment of wastewater. These are Ingestion, Respiration, Growth and Reproduction.

CHEMICAL OXYGEN DEMAND (COD)

Oxidizable materials introduced into water will similarly initiate chemical reactions to create what is measured in the laboratory as the chemical oxygen demand (COD).

BIOCHEMICAL OXYGEN DEMAND (BOD)

Biochemical Oxygen Demand, also called Biological Oxygen Demand, is the amount of dissolved oxygen needed by aerobic biological organisms to break down organic material present in a given water sample at certain temperature over a specific time period. The BOD value is most commonly expressed in milligrams of oxygen consumed per liter of sample during 5 days of incubation at 20°C. It is often used as a measure of the degree of organic pollution in water.

Total Organic Carbon

(TOC) bears a direct relationship with biological and chemical oxygen demand; high levels of TOC can result from human sources, the high oxygen demand being the main concern.

Clarification

Gravity separation in a clarifier is a process to reduce the concentration of suspended matter in water. In the activated sludge treatment process, the removal of suspended solids from wastewater is usually through clarification.

Return Activated Sludge

The settled activated sludge (biomass) that is collected in a secondary clarifier and returned to the secondary treatment process to mix with incoming wastewater. This returns a concentrated population of microorganisms back into the aeration basin.

Waste Activated Sludge

The excess activated sludge (biomass or cell mass) removed from the secondary treatment process. For most treatment plants, this is a portion of the Return Activated Sludge (RAS) flow stream.

Sludge Volume Index

A numerical expression of the settling characteristics of activated sludge in the final clarifier. SVI is expressed as the ratio of the volume in milliliters of activated sludge settled from a 1,000-mL sample in 30 minutes divided by the concentration of mixed liquor in milligrams per liter multiplied by 1,000. A good settling sludge (textbook value) is 100, but can commonly be between 80-150.

BOD and COD Reduction

Wastewater treatment plants (POTWs) are designed to reduce the BOD and COD in the effluent discharged to receiving or natural waters. The goal is to meet state and federal discharge criteria and protect the environment. It has been said that wastewater treatment plants are designed to function as "microbiology farms," where bacteria and other microorganisms are fed oxygen and organic waste. Wastewater plant operators are farmers striving to create optimum conditions for their crop of bacteria. Pretreatment inspectors protect this bacteria crop.

Treatment of wastewater usually involves biological processes such as the activated sludge system in the secondary stage after preliminary screening to remove coarse particles and primary sedimentation that settles out suspended solids. These secondary treatment steps are generally considered environmental biotechnologies that harness natural self-purification processes contained in bioreactors for the biodegradation of organic matter and bioconversion of soluble nutrients in the wastewater.

Application Specific Microbiology

Each wastewater stream is unique, and so too are the community of microorganisms that process it. This "application-specific microbiology" is the preferred methodology in wastewater treatment for effective biological nutrient removal. The right bugs are more efficient in organics removal when provided the right growth environment.

Trickling filters efficiency is multiplied if microorganisms are allowed to grow as a layer of biofilm on specifically designed support media. In activated sludge, the microorganisms are suspended in air-mixed water slurry. In this way, optimized biological processing of a waste stream can occur. To reduce the start-up phase for growing a mature biofilm one can also purchase "application specific bacterial cultures" from microbiology vendors or use the active bugs from a similar WWTP to seed the process.



Aeration is often used to oxygenate the wastewater flow at the influent channel.

Pollutants - Oxygen-Demanding Substances

CONVENTIONAL POLLUTANTS

POTWs are designed to treat typical household wastes and biodegradable commercial and biodegradable industrial wastes. The Clean Water Act defines the contaminants from these sources as conventional pollutants. Conventional pollutants include biological oxygen demand (BOD), total suspended solids (TSS), fecal coliform, oil and grease, and pH.

Dissolved oxygen is a key element in water quality that is necessary to support aquatic life. A demand is placed on the natural supply of dissolved oxygen by many pollutants in wastewater. Oxygen-demanding substances are contributed by domestic sewage and agricultural and industrial wastes of both plant and animal origin, such as those from food processing, paper mills, tanning, and other manufacturing processes.

This is called biochemical oxygen demand, or BOD. The level of BOD is used to measure how well a sewage treatment plant is working. If the effluent, the treated wastewater produced by a treatment plant has a high content of organic pollutants or ammonia, it will demand more oxygen from the water and leave the water with less oxygen to support fish and other aquatic life. Organic matter and ammonia are “oxygen-demanding” substances.

These substances are usually destroyed or converted to other compounds by bacteria if there is sufficient oxygen present in the water, but the dissolved oxygen needed to sustain fish life is used up in this break-down process if the BOD is too high. *Much more information on this subject is in the Laboratory section.*

Pathogens

The infectious microorganisms, or pathogens, may be carried into surface and groundwater by sewage from cities and institutions, by certain kinds of industrial wastes, such as tanning and meat packing plants, and by the contamination of storm runoff with animal wastes from pets, livestock and wild animals, such as geese or deer. Disinfection of wastewater and chlorination of drinking water supplies has reduced the occurrence of waterborne diseases such as typhoid fever, cholera, and dysentery, which remain problems in underdeveloped countries. Humans may come in contact with these pathogens either by drinking contaminated water or through swimming, fishing, or other contact activities. Modern disinfection techniques and sanitary surveys have greatly reduced the danger of waterborne disease.

Inorganic and Synthetic Organic Chemicals

A vast array of chemicals is included in this category. Examples include detergents, household cleaning aids, heavy metals, pharmaceuticals, synthetic organic pesticides and herbicides, industrial chemicals, and the wastes from their manufacture. Many of these substances are toxic to fish and aquatic life and many are harmful to humans. Some are known to be highly poisonous at very low concentrations. Others can cause taste and odor problems, and many are not effectively removed by conventional wastewater treatment.

Heavy metals are discharged with many types of industrial wastewaters, and are difficult to remove by conventional wastewater treatment.

TEMPERATURE AND GROWTH RATES

All biological and chemical reactions are affected by temperature. Microorganisms growth and reaction rates are slow at cold temperatures and much faster at warmer temperatures. Most microorganisms do best under moderate temperatures (10-25°C). Aeration basin temperatures should be routinely measured and recorded. Although the temperature may not be easily changed, the MLSS, DO, and RAS rates may be adjusted to partially compensate and keep the bugs effective.

Thermal Effects

Heat reduces the capacity of water to retain oxygen. In some areas, water used for cooling is discharged to surface waters at elevated temperatures from power plants and industries.

Even discharges from wastewater treatment plants and storm water retention ponds affected by summer heat can be released at temperatures above that of the receiving water, and elevate the stream temperature. Unchecked discharges of waste heat can seriously alter the ecology of a lake, a stream, or estuary.

Wastewater Temperature

The maximum temperature of the wastewater entering a biological reactor should be < 95°F (35°C). It is to be understood that many wastewater treatment systems cannot maintain their wastewater at or below this temperature. Nonetheless, the literature seems to be consistent in setting 95°F as the upper limit, beyond which the operation of the biological system and solids settling in the clarifiers will begin to suffer.

Temperatures in Celsius and Fahrenheit Chart

Reference Point	Degrees in Celsius	Degrees in Fahrenheit
Water Freeing Point Sea Level	0	32
Typical Winter Wastewater Temperature	10	50
Room Temperature *	20	68
Body Temperature (Human)	37	98.6
Boiling Point of Water at Sea Level	100	212

Because of the importance of temperature, it will be discussed in other chapters of this course.

NPDES Permit Information

INTERFERENCE

Interference: a discharge from an industrial user that, alone or in conjunction with other sources a) inhibits or disrupts a POTW plant, its treatment processes or operations, or its sludge processes, use, or disposal, and b) therefore causes a violation including increasing a violation's magnitude or duration of any permit or rule that controls release of pollutants from the POTW.



PASS-THROUGH

Pass-through: a POTW has a violation of its limits caused by an industrial users discharge that **passes through** the public facility without being adequately treated. The pollutant limit violated must be a pollutant discharged by the industrial user, but it's not necessary to demonstrate impact on the POTW operation.



Secondary Treatment Standards

SAMPLE	30-Day Average, mg/L	7 -Day Average, mg/L	Minimum Percent Removal
BOD 5	30	45	85%
CBOD 5	25	40	85%
TSS	30	45	85%
pH	Instantaneous 6.0 to 9.0 S.U.		

**EXAMPLE OF FACT SHEET
DOCUMENTING THE DETERMINATION OF THE MOST
STRINGENT DAILY MAXIMUM EFFLUENT LIMITS**

Parameter	Daily PSES	Monthly PSES	Daily CWF	Monthly CWF	Local Daily Limits	Daily Final Limit	Monthly final limit**
Cadmium	0.69	0.26	0.46	0.17	0.10	0.10	0.17
Chromium (Hex)	-----	-----	-----	-----	0.10	0.10	-----
Chromium (Total)	2.77	1.71	1.85	1.14	1.0	1.0	1.14
Copper	3.38	2.07	2.26	1.38	5.0	2.26	1.38
Cyanide	6.0	0.65	*	*	2.0	2.0	0.65*
Lead	0.69	0.04	0.46	0.29	0.10	0.10	0.29
Manganese	-----	-----	-----	-----	1.00	1.00	-----
Mercury	-----	-----	-----	-----	0.005	0.005	-----
Nickel	3.98	2.38	2.66	1.59	2.0	2.0	1.59
Silver	0.04	0.24	0.28	0.16	0.1	0.1	0.16
Zinc	2.61	1.48	1.74	0.99	5.0	1.74	0.99
TTO***	2.13	-----	1.42	-----	1.0	1.0	-----

Note: All concentrations are in mg/L unless otherwise noted.

Key:

PSES = Pretreatment Standards for Existing Sources, metal finishing category (40 CFR Part 433.15 (a))

CWF = Alternative metal - finishing standards after use of the combined wastestream formula.

Local Limits = Maximum pollutant concentrations established by the Control Authority

Final Limit = Final limits based on most stringent of local, state, and federal standards

*Cyanide limits must apply to the segregated cyanide wastestream of the cyanide destruct treatment process

**The discharger required to comply with both the daily maximum and monthly average limits, if applicable.

***The pollutants regulated by the categorical TTO limit and the local TTO limit are the same.

Wastewater Treatment Introduction Post Quiz

This is not your final assignment. You can find the final assignment online. Hyperlink to the Assignment

<http://www.ABCTLc.com/downloads/PDF/WASTEWATERTREATMENT%20ASS.pdf>

Hyperlink to the Glossary and Appendix

<http://www.abctlc.com/downloads/PDF/WWTGlossary.pdf>

1. Ammonia is an important component of the nitrogen cycle and because it is oxidized in the environment by microorganisms (i.e., nitrification), it is a large source of available nitrogen in the environment.

True or False

2. Ammonia is a nutrient that contains nitrogen and sulphur.

True or False

3. Un-ionized ammonia refers to all forms of ammonia in water with the exception of the ammonium ion (NH₄⁺). Ionized ammonia refers to the ammonium ion.

True or False

4. Methane gas is a byproduct of aerobic biological treatment and is slightly combustible.

True or False

5. Carbon, ammonia, and copper are essential to living organisms and are the chief nutrients present in natural water.

True or False

6. The best temperatures for wastewater treatment probably range from 77 to 95 degrees Fahrenheit.

True or False

7. In general, biological treatment activity accelerates in cold temperatures and slows in warm temperatures, but extreme hot or cold can stop treatment processes altogether.

True or False

8. The acidity or alkalinity of wastewater affects both treatment and the environment.

True or False

9. Low pH indicates increasing acidity while a high pH indicates increasing alkalinity (a pH of 7 is low). The pH of wastewater needs to remain between 4 and 5 to protect organisms. True or False

10. Inorganic minerals, metals, and compounds, such as sodium, potassium, calcium, magnesium, cadmium, copper, lead, nickel, and zinc are not common in wastewater. True or False

11. Heavy metals which are discharged with many types of industrial wastewaters are easy to remove by conventional treatment methods. True or False

12. Although acute poisonings from heavy metals in drinking water are rare - potential long-term health effects of ingesting small amounts of some inorganic substances over an extended period of time are possible. True or False

13. The solids must be significantly reduced by treatment or they can increase BOD when discharged to receiving waters and provide places for microorganisms to escape disinfection. True or False

14. Sand, grit, and heavier organic and inorganic materials settle out from the rest of the wastewater stream during the preliminary stages of treatment. True or False

15. Excessive amounts of dissolved solids in wastewater cannot have adverse effects on the environment. True or False

Wastewater Treatment Introduction Answers

1. True, 2. False, 3. True, 4. False, 5. False, 6. True, 7. False, 8. True, 9. False, 10. False, 11. False, 12. True, 13. True, 14. True, 15. False

Topic 2 – Primary Wastewater Treatment Section

Section Focus: You will learn the basics of the primary wastewater treatment process. At the end of this section, you will be able to describe primary wastewater treatment process. There is a post quiz at the end of this section to review your comprehension and a final examination in the Assignment for your contact hours.

Scope/Background: Wastewater is passed through several tanks and filters that separate water from contaminants. Primary treatment of wastewater involves screening of solid waste within the water. This is done after filtering out larger contaminants within the water. The resulting sludge is then usually fed into a digester, in which further processing takes place. This primary batch of sludge contains nearly 50% of the suspended solids within raw wastewater.



Primary Treatment Wastewater is a sedimentation process to remove suspended organic solids from the sewage. Chemical are sometimes used to remove finely divided and colloidal solids.

Objectives of Primary Treatment

The main objectives of primary treatment of wastewater are:

1. To reduce the strength of sewage to the extent 30% to 50%.
2. To remove settleable solids by 80% to 90%.
3. To reduce BOD by 30% to 35%.
4. To make the sewage fit for further treatment process.

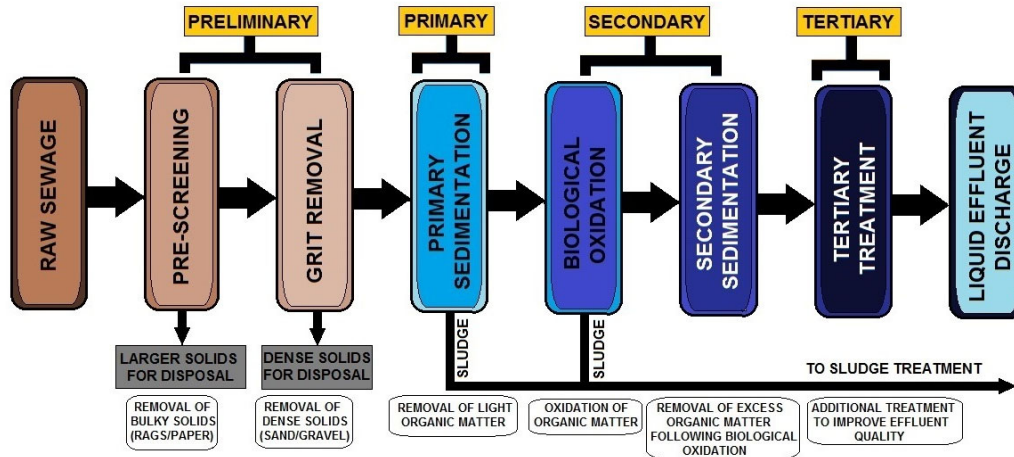

INTRODUCTION OF WASTEWATER TREATMENT METHODS AND STEPS

Wastewater treatment systems are designed to foster an environment that suits certain types of microorganisms. These microorganisms not only remove organic wastes from the water, but they also “settle out” as solid material for easy removal and clearer water.

Wastewater treatment operators are required to maintain the right conditions in the treatment system for the right type of microorganisms. While there are many different microbes (viruses, bacteria and protozoans) used in sewage treatment, there are three well-known microbes (anaerobic, aerobic, facultative) that play an instrumental role in keeping sewage clean. Each of these types of bacteria help the treatment process in a unique way to ensure there is little to no impact on the surrounding environment.

Hyperlink to the Glossary and Appendix

<http://www.abctlc.com/downloads/PDF/WWTGlossary.pdf>

Conventional Wastewater Treatment - Primary Overview

Introduction

Our country has a vast system of collection sewers, pumping stations, and treatment plants. Sewers collect the wastewater from homes, businesses, and many industries, and deliver it to plants for treatment. Most treatment plants were built to clean wastewater for discharge into streams or other receiving waters, or for reuse. For some time, sewage was dumped into waterways, a natural process of purification started. One of the most common forms of pollution control in the United States is *wastewater treatment*.

The initial stage in the treatment of domestic sewage is known as primary treatment. Heavier and coarse solids are removed from the wastewater during the primary stage of treatment. In some treatment plants, primary and secondary stages may be combined into one basic operation.

At many wastewater treatment facilities, influent passes through preliminary treatment units before primary and secondary treatment begins.

Second, the volume of clean water in the stream diluted wastes. Bacteria and other small organisms in the water consumed the sewage and other organic matter, turning it into new bacterial cells, carbon dioxide and other products.

Today's higher populations and greater volume of domestic and industrial wastewater require that communities give nature a helping hand. The basic function of wastewater treatment is to speed up the natural processes by which water is purified.

There are two basic stages in the treatment of wastes, *primary (physical)* and *secondary (biological)*. In the primary stage, solids are allowed to settle and removed from wastewater. The secondary stage uses biological processes to further purify wastewater. Sometimes, these stages are combined into one operation.



An activated sludge example of an aeration train or channel containing mixed liquor (MLSS) in secondary treatment.

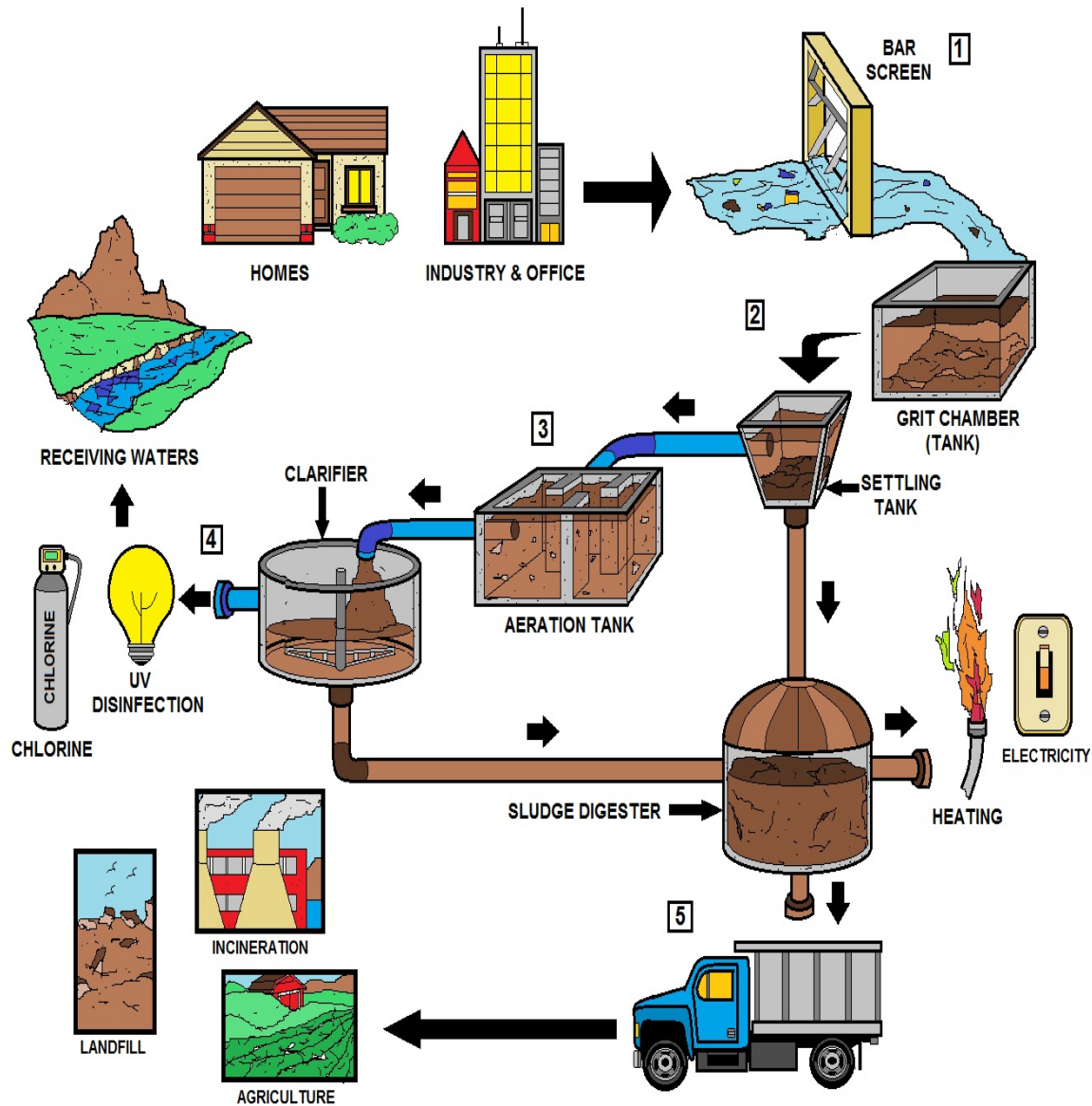

WASTEWATER TREATMENT PROCESS

There are many different ways, systems, processes, methods to treat wastewater. In this diagram, numbers 1,2, are normally considered primary treatment.

Sometime numbers 1,2 are considered pretreatment.

Box 3 is generally referred to as the activated sludge process and is secondary treatment.

Numbers 4 and 5 are considered secondary treatment methods. It is possible to modify this process and add many different processes like various filters or BNR. We will try to cover many of these related A/S processes in this course.

Influent Flow

Whether a sewage collection system serves a single home or an entire community, it must be able to handle fluctuations in the quantity and quality of wastewater it receives to ensure proper treatment is provided at all times. Systems that are inadequately designed or hydraulically overloaded may fail to provide treatment and allow the release of pollutants to the environment.

To design systems that are both as safe and as cost-effective as possible, engineers must estimate the average and maximum (peak) amount of flows generated by various sources. Because extreme fluctuations in flow can occur during different times of the day and on different days of the week, estimates are based on observations of the minimum and maximum amounts of water used on an hourly, daily, weekly, and seasonal basis. The possibility of instantaneous peak flow events that result from many water-using appliances or fixtures being used at once also is taken into account.



Sanitary Sewer Overflow

The number, type, and efficiency of all water-using fixtures and appliances at the source is factored into the sewage flow estimate from a source. The number and amount of water normally used by faucets, toilets, and washing machines, and the number of possible users or units will affect the amount of water used. The number of residents, bedrooms, customers, students, patients, seats, or meals served will determine the sewage flow.

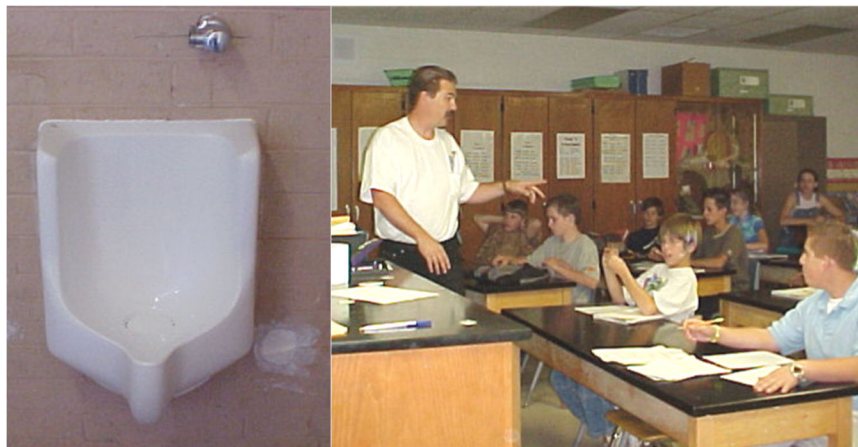

Waterless urinals are reducing water use but are concentrating the wastestream. Water conservation education is now taught at schools and this too is affecting our flow dynamics and microorganisms (MO's). Anything new always affects the bugs and no one cares but us.

According to studies, water use in many homes is lowest from about midnight to 5 a.m., averaging less than one gallon per person per hour, but then rises sharply in the morning around 6 am to a little over 3 gallons per person per hour. During the day, water use drops off moderately and rises again in the early evening hours.

Weekly peak flows may occur in some homes on weekends, especially when all adults work during the week. In U.S. homes, average indoor water use is approximately 45 gallons per person per day, but may range from 35 to 60 gallons or more.

Peak flows at stores and other businesses typically occur during business hours and during meal times at restaurants. Rental properties, resorts, and commercial establishments in tourist areas may have extreme flow variations seasonally.

Estimating flow volumes for centralized treatment systems is a complicated task, especially when designing a new treatment plant in a community where one has never existed previously.

Engineers must allow for additional flows during wet weather due to inflow and infiltration (I&I) of extra water into sewers. Sewers are never perfectly water tight, particularly as they age. Excess water can enter sewers through leaky manhole covers and cracked pipes and pipe joints, diluting wastewater, which affects its overall characteristics. This can increase flows to treatment plants sometimes by as much as three or four times the original design load or dry weather load.

Infiltration or unwanted, unknown sewage flows are dangerous to maintaining a healthy bug culture, and decreases detention times. There are many times that some interference or industrial waste including high heat will disrupt or destroy your bugs. Because of these unwanted flows, operators may need to start from scratch to build a healthy bug population. Expect this to happen for these events are common. Special treatment processes may need to come online to assist during these times.

We have seen operators transport RAS from thousands of miles away to re-start a sick A/S tank. This can take three to ten days using hundreds or even thousands of gallons of RAS.



Grout is used to seal joints and prevent infiltration (I&I) into manholes or exfiltration out of the pipe.

Conventional A/S WWTP Plant Overview Diagram

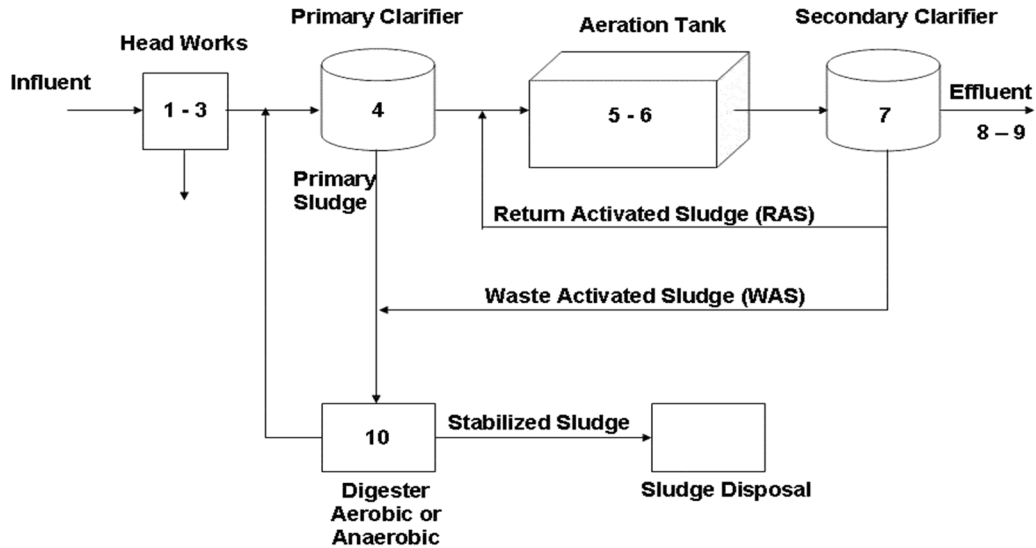

The following is a description of each numbered section in the illustration above.

Wastewater treatment plants are constantly pushed to meet higher standards of water quality. Careful consideration needs to be made when designing pretreatment for an A/S facility.

Traditional activated sludge process headworks (pretreatment) includes bar screens, grit removal and possibly a pre-sedimentation basin. Newly designed systems may include chemicals to enhance precipitation of nutrients or to decrease issues with hydrogen sulfide. We will examine these processes in detail.

Plant Influent

Raw sewage enters the treatment facility through the municipal sewer system. Raw wastewater enters the treatment facility at the beginning of the treatment plant, referred to as the "headworks" of the plant. The wastewater is being pumped to the wastewater treatment facility using pumps.

Illustration box 1 – 3

1. **Preliminary Treatment:** Removes large objects and heavy material from the wastewater to help prevent clogging of pipes and damaging the treatment equipment. The removed material during preliminary treatment is typically hauled to a landfill for disposal.
2. **Coarse Bar Screen:** Metal bars collect large debris such as rags, wood, plastics, and etc.
3. **Grit Removal:** The wastewater flows through a channel, allowing dense, inorganic material to settle on the bottom. Scrapers, hoppers and clam buckets remove the collected grits. The removed material during preliminary treatment is typically hauled to a landfill for disposal.

Illustration box 4

Primary Settling: The wastewater flows into large settling tanks that allow suspended solids and organic material to sink to the bottom of this tank.

Phosphorous Removal: Partially treated wastewater is drawn from the top of the settling tanks and in some treatment facilities, chemicals are added to remove phosphorous.

Illustration box 5-6

Aeration Basins: Large aeration basins or tanks mix the partially treated wastewater with oxygen to support bacteria that devour organic waste. The bacteria levels are managed to provide the most efficient removal process.

Return Activated Sludge (RAS) brings sludge back to the aeration process for further treatment while Waste Activated Sludge (WAS) removes the excess or older sludge.

Illustration box 7

Final Settling: The clarified wastewater is drawn from the top of the aeration tanks or secondary clarifiers through spillways. By this point, the water is getting clearer. Polymers may be added to concentrate any remaining material. Once again, suspended particles settle to the bottom to be removed by scrapers to hoppers and returned to the aeration tank.

Illustration box 8-9

Disinfection: The cleanest water is drawn from the surface and disinfected with chlorine or ultra-violet light to kill bacteria.

De-chlorination: The treated water is de-chlorinated. The treated water is tested to ensure it meets the EPA standards and is sent to the permitted receiving water source. Before the treated water is discharged to the receiving stream, it must be sampled and chlorine-free. The effluent samples are then analyzed in a laboratory (Local Limits). An automatic sampler will automatically take samples at designated times. The samples are kept refrigerated in the sampler until they can be analyzed in the lab.

Illustration box 10

Sludge Digestion: Sludge from the settling tanks is drawn from the bottom of the tanks and pumped to the primary settling tank or digester. This sludge may have a high water content, but it also contains oxygen and bacteria that improves the efficiency of the treatment process. A gravity belt thickener or centrifuge are ways to reduce the amount of water in the biosolids before further treatment. Volume reduction is occurring from the loss of water.

Digestion: Thickening of the biosolids improves digester operation and reduces the cost of sludge digestion. Aerobic sludge digestion produces a sludge that has a higher water content.

Sludge disposal: This box also needs sampling of the sludge for local limits and process control. Sludge disposal can be preceded by further thickening. Digested sludge can be used as fertilizer, disposed at a landfill or incinerated. The nation of China is using sludge with other polymers to make furniture, clothing and building materials.

Sampling Influent and Industrial Waste Introduction



A Pretreatment Inspector outside of a Commercial Industrial User.

A quick word about industrial waste....

Industrial Waste

Industrial waste can be a killer of wastewater bugs. In the photograph, the Inspector or Sampler is shaking the sample to make sure that the sample is mixed-up before pouring off a smaller sample into the smaller sample bottles on the ground. Often, these Inspectors or Samplers will work in pairs. These professionals need to get used to having wastewater and/or industrial waste/odors all over your clothes. However, there are spiders, grease, confined spaces, irate customers, interesting odors and dangerous hydrogen sulfide gas. Over all, this is a great job, a secure and well-paying job.

Temperature – Critical and Legal Parameter

These Inspectors will check the temperature of the wastewater to ensure it will not kill the bugs or treatment process. The best temperatures for wastewater treatment range from 77 to 95 degrees Fahrenheit.

In general, biological treatment activity accelerates in warm temperatures and slows in cool temperatures, but extreme hot or cold can stop treatment processes altogether. Therefore, some systems are less effective during cold weather and some have special designs to be effective in very cold climates.

Wastewater temperature also affects receiving waters. Hot water, for example, which is a byproduct of many manufacturing processes, can be a pollutant. When discharged in large quantities, it can raise the temperature of receiving streams locally and disrupt the natural balance of aquatic life.

pH– Critical and Legal Parameter

The pH is also tested by Inspectors because proper pH is critical for the treatment process and a low or high pH will damage the collection system. The acidity or alkalinity of wastewater affects both treatment and the environment. Low pH indicates increasing acidity while a high pH indicates increasing alkalinity (a pH of 7 is neutral). The pH of wastewater needs to remain between 6 and 9 to protect treatment bugs (organisms). Acids and other substances that alter pH can inactivate treatment processes when they enter wastewater from industrial or commercial sources.

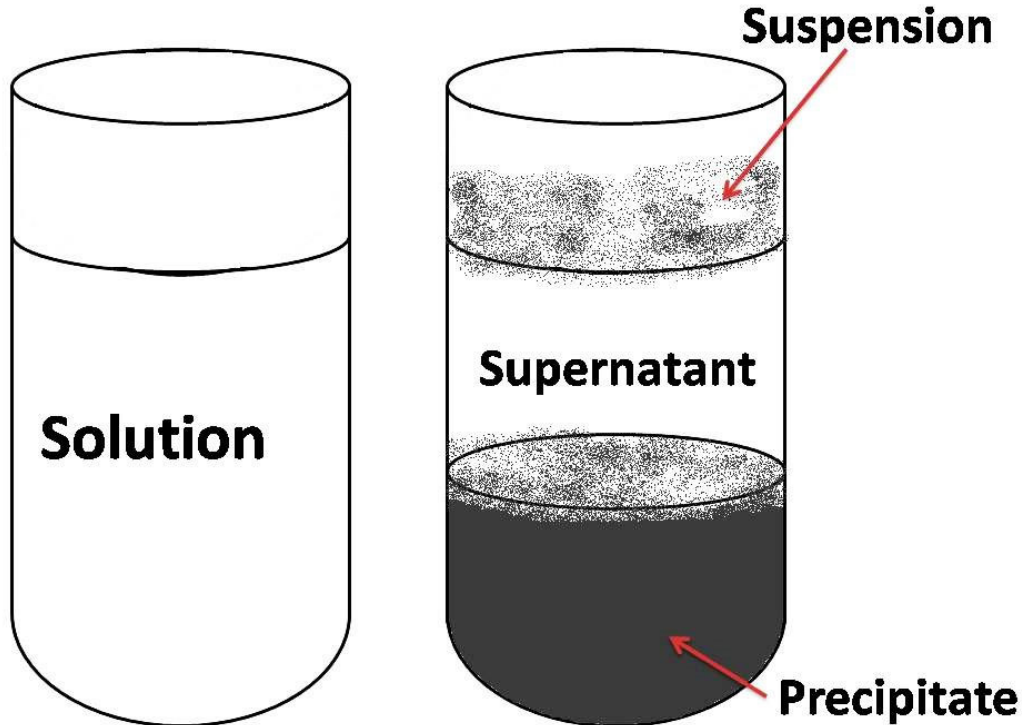

Precipitation and Solution Definitions

This information is critical for taking wastewater samples. We will cover this in detail later in the course.

A solution is a complete mixture of ingredients such that no portion differentiates. Good examples of a solution are soft drinks, beer and milk.

Precipitation is the formation of a solid in a solution or inside another solid during a chemical reaction or by diffusion in a solid. When the reaction occurs in a liquid, the solid formed is called the precipitate. Without sufficient force of gravity (settling) to bring the solid particles together, the precipitate remains in suspension.

After sedimentation, especially when using a centrifuge to press it into a compact mass, the precipitate may be referred to as a pellet. The precipitate-free liquid remaining above the solid is called the supernate or supernatant.

Preliminary Wastewater Treatment Sub-Section

Preliminary treatment is a purely physical stage consisting of Coarse Screening, Raw Influent Pumping, Screening, Grit Removal, and Selector Tanks in the A/S BNR process or for filamentous bacteria control.

The raw wastewater enters from the collection system into the *Coarse Screening process*. After the wastewater has been screened, it may flow into a grit chamber where sand, grit, cinders, and small stones settle to the bottom. Removing the grit and gravel that washes off streets or land during storms is very important, especially in cities with combined sewer systems.

Large amounts of grit and sand entering a treatment plant can cause serious operating problems, such as excessive wear of pumps and other equipment, clogging of aeration devices, or taking up capacity in tanks that is needed for treatment.



Fine Screening

Collected Grit

In some plants, another finer screen is placed after the grit chamber to remove any additional material that might damage equipment or interfere with later processes. The grit and screenings removed by these processes must be periodically collected and trucked to a landfill for disposal or be incinerated.

The Coarse Screening consists of a basket shaped bar screen that collects larger debris (several inches in diameter) prior to the Raw Influent Pumping. This debris is removed and placed into a dumpster for disposal into the landfill.

The wastewater then passes into the *Raw Influent Pumping process* that consists of submersible centrifugal pumps. These influent pumps operate under a principal termed prerotation, which allows them to vary their pump rate hydraulically without the use of complex and expensive electronics.



Manual and Mechanical Bar Screens

The flow then passes into the *Static Fine Screening process* which consists of two stationary (or static) screens which remove finer debris not captured by the coarse screens. This screened debris is then dewatered and collected in hoppers for disposal into a landfill.

The wastewater then passes into the *Grit Removal process* which consists of two vortex grit separators which produce a whirlpool action to force the finest debris to the outside perimeter for subsequent collection. This debris is then collected in hoppers, dewatered, and disposed into a landfill. The screened and de-gritted wastewater then enters into *Primary Sedimentation*. Credit to the USEPA

Most A/S processes have some type of grit and trash removal system. Even the most primitive wastewater system needs to remove all inorganics from the system. Otherwise, we would simply have a hole in the ground that we dump sewage into, but that did not work out because we threw all types of inorganics in this hole, disrupting the natural biological work. *We will cover grit later in the Aeration and Secondary Sections.*
Credit to the USEPA for this text.

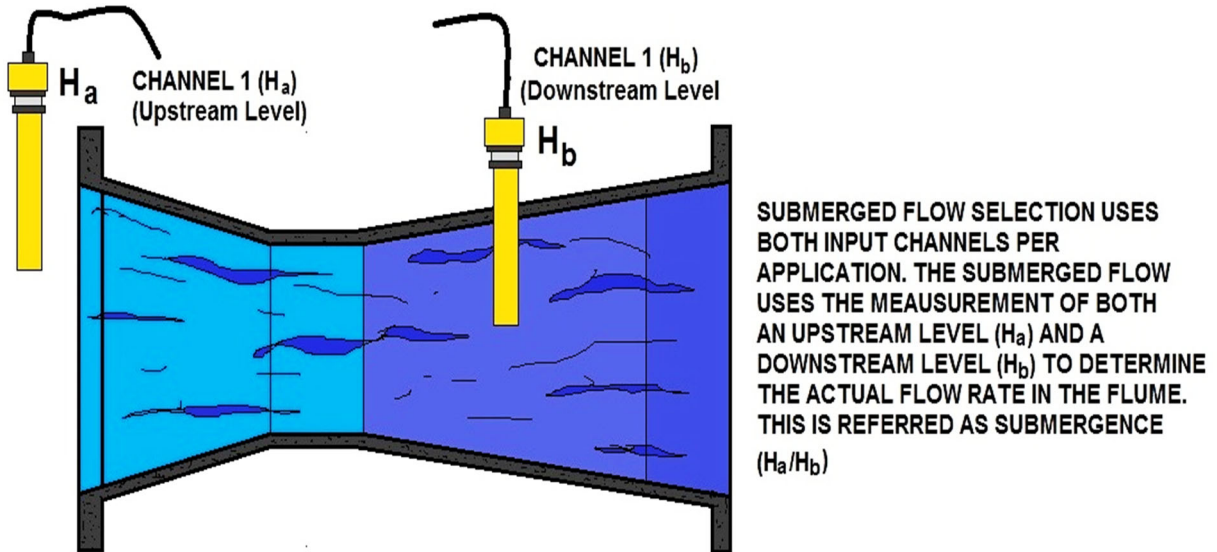

SUBMERGED FLOW IN PARSHALL FLUMES

Parshall Flumes measure the flow of the wastewater entering the plant. The diagram above and below shows how sonic heads measure the height of the flow in an open channel. In case of debris clogging the inlet of the flume, the operator needs easy to access and clean the flume.

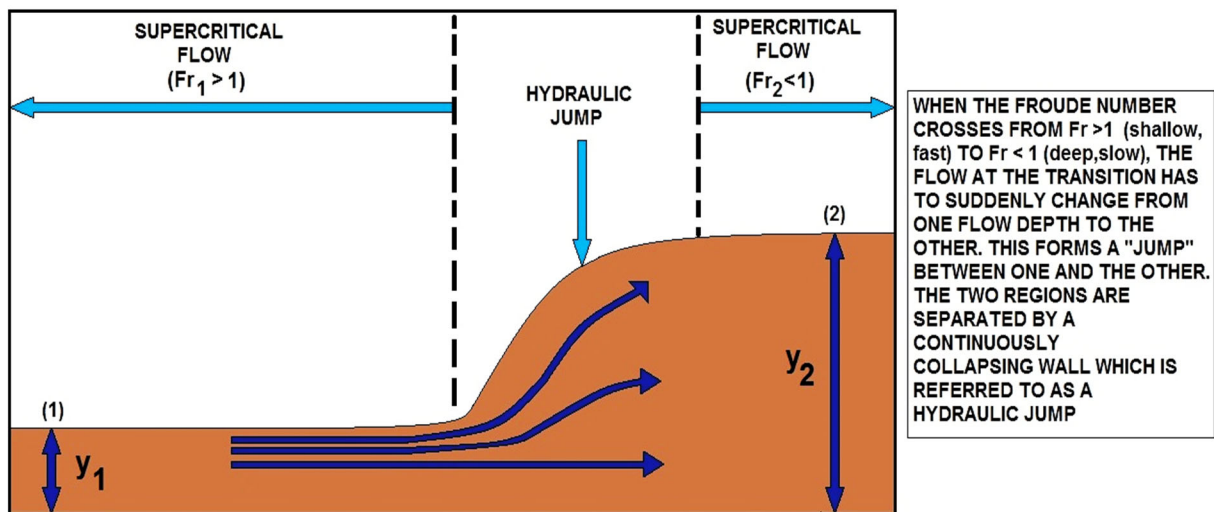

HYDRAULIC JUMP

Headworks Sub-Section

Headworks Introduction

Wastewater treatment plants are constantly pushed to meet higher standards of water quality. Careful consideration needs to be made when designing pretreatment for a facility. Traditional activated sludge process headworks (pretreatment) includes bar screens, grit removal and possibly a pre-sedimentation basin. Newly designed systems may include chemicals to enhance precipitation of nutrients or to decrease issues with hydrogen sulfide. We will examine these processes in detail.

In the facilities where sewage enters a plant for treatment is often referred to as the "Headworks". The influent flows through a screen, which removes large floating objects such as rags and sticks that might clog pipes or damage equipment.

All of these devices or similar processes are found at most A/S facilities.

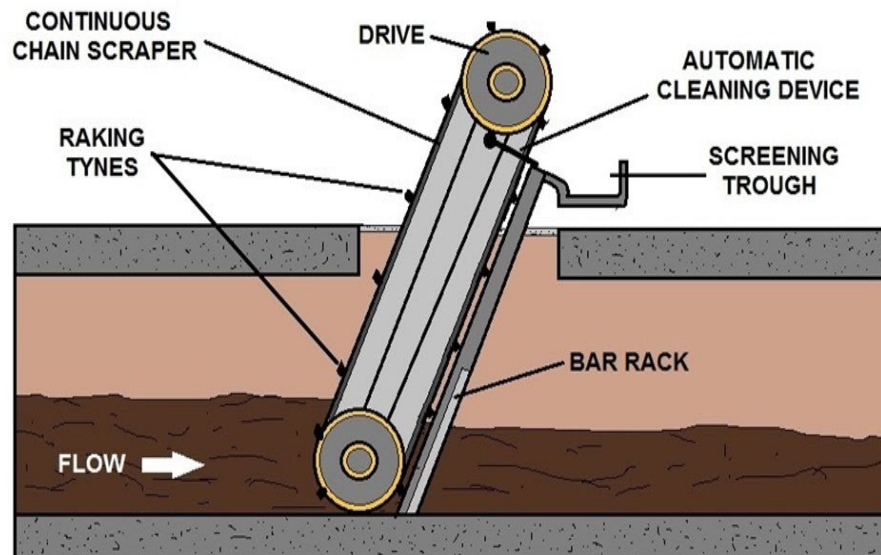

The bar rack consist of parallel bars, rods, or wires (coarse screen) or perforated pipe (fine screen).
Flow passes through screens and large solids are trapped on the bars for removal.
Screens may be coarse (0.25-6 inch openings) or fine (less than 0.25 inch size openings).
The bar screen / bar rack may be manually cleaned or mechanically cleaned (Performed frequently enough to prevent buildup of solids and reduce flow into the plant).

PRELIMINARY TREATMENT – BAR SCREEN- BAR RACK

Most wastewater facilities are designed to screen out large solids and debris using several types of screening devices.



Mechanical Bar Screens: Operators should pick up trash that has blown off the automatic rakes.



Grinder Pump: installed after the bar screens. The debris is sent to the landfill.



Debris Removal: An operator pulled wipes from the headworks that should not be flushed and clearly clogs equipment.

Grit Chamber

A *grit chamber* is particularly important in communities with combined sewer systems where sand or gravel may wash into sewers along with stormwater. After screening is completed and grit has been removed, sewage still contains organic and *inorganic matter* along with other suspended solids.

Much of these suspended solids are *minute particles* that can be removed from sewage in a sedimentation tank. When the speed of the flow through one of these tanks is reduced, much of the suspended solids will gradually sink to the bottom, where they form a *mass of solids* called raw primary biosolids formerly called raw sludge.

There are many different mechanisms to remove grit. We will return to this subject later.



Left, Strainer Screen, Right, Floating debris in an influent wetwell

GRIT

Grit consists of sand, gravel, cinders, and other heavy materials. It also includes organic matter such as eggshells, bone chips, seeds, and coffee grounds. Pretreatment may include a sand or grit channel or chamber, where the velocity of the incoming sewage is adjusted to allow the settlement of sand and grit.

GRIT REMOVAL

Grit removal is necessary to:

- reduce formation of heavy deposits in aeration tanks, aerobic digesters, pipelines, channels, and conduits;
- reduce the frequency of digester cleaning caused by excessive accumulations of grit; and
- protect moving mechanical equipment from abrasion and accompanying abnormal wear. The removal of grit is essential for equipment with closely machined metal surfaces such as commutators, fine screens, centrifuges, heat exchangers, and high pressure diaphragm pumps.

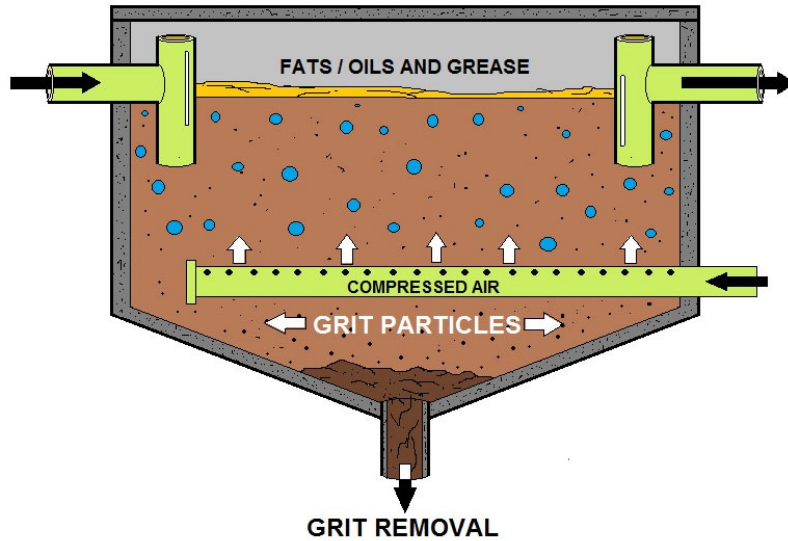

GRIT REMOVAL CHAMBERS

Grit chambers come in 3 types: **horizontal grit chambers**, **aerated grit chambers** and **vortex grit chambers**. Vortex type grit chambers include mechanically induced vortex, hydraulically induced vortex, and multi-tray vortex separators. Traditionally, grit removal systems have been designed to remove clean inorganic particles that are greater than 0.210 mm, so much grit passes through the grit removal flows under normal conditions. During periods of high flow deposited grit is re suspended and the quantity of grit reaching the treatment plant increases substantially.

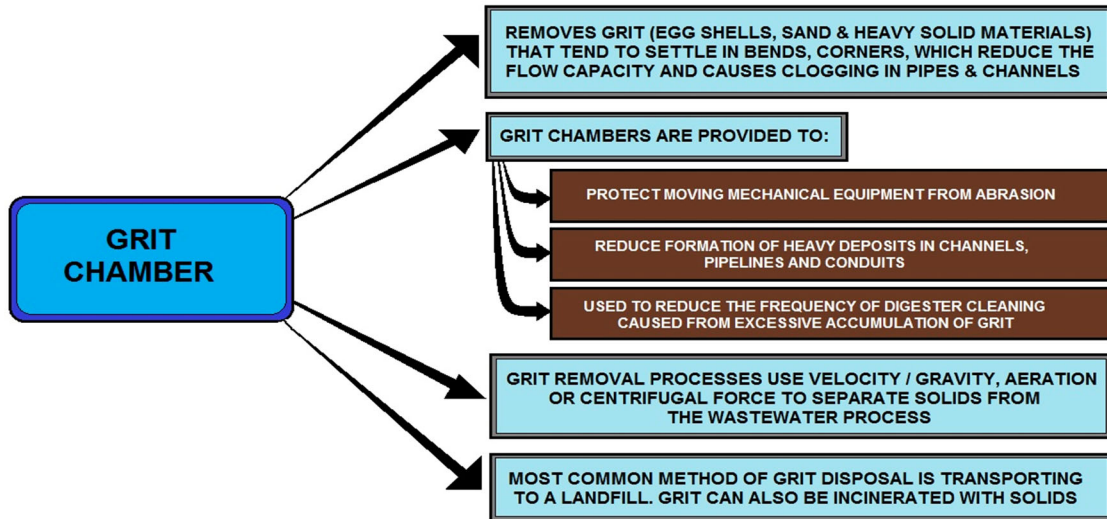

WASTEWATER PRETREATMENT PROCESS (GRIT CHAMBER)



Photo Journal #1



Caked grease (scum) stuck on a primary clarifier weir. Scum is normally scraped off and not sent to the downstream aeration tank.



Floating scum in an influent chamber. This debris should be removed and sent to a landfill.



This circular clarifier has been dewatered with a portable pump
Maintenance on a circular clarifier should be performed annually.



Scum Box located on a circular clarifier.

Flow Measurement

Flow measurement is crucial for the design and success of the treatment process. There are different devices used such as weirs and magnetic flow meters. In the headworks, the most common used is the Parshall flume as pictured below.



Sonic head (level) detection in the flume is used for flow measurement. Flow rates can be used for flow weighted composite samples. Another application using sonic head level detection are weir boxes. Often referred to as a splitter box as illustrated below.





Example of a Sludge Press.

Primary Clairifer Box 4- See Illustration Chart

PRIMARY TREATMENT

Primary treatment consists of temporarily holding the sewage in a quiescent basin where heavy solids can settle to the bottom while oil, grease and lighter solids float to the surface. The settled and floating materials are removed and the remaining liquid may be discharged or subjected to secondary treatment.



Most wastewater treatment facilities were designed with a primary and secondary clarifier. These two devices are excellent at settling the sludge through detention time. Primary clarifier sludge is usually denser than secondary sludge. The effluent from a secondary clarifier is clearer than primary effluent and the primary will generally have grease and grit build up if not removed by pretreatment.

The method in which solids are removed will depend upon the shape of the clarifier. In a rectangular clarifier, the solids settle to the bottom of a clarifier and scraped to one end or to the middle. In circular clarifiers, the floor is sloped and the raking mechanism scrapes the solids to the center. In either design, a sump pump removes the solids.

The sludge handling and sludge disposal system vary from plant to plant and can include sludge digestion, vacuum filtration, incineration, land disposal, lagoons and burial.



The photograph the left is a rectangular basin and on the right is a circular clarifier. The rectangular basin has chains and flights to scrap sludge and a circular basins use a slowly rotating raking mechanism.

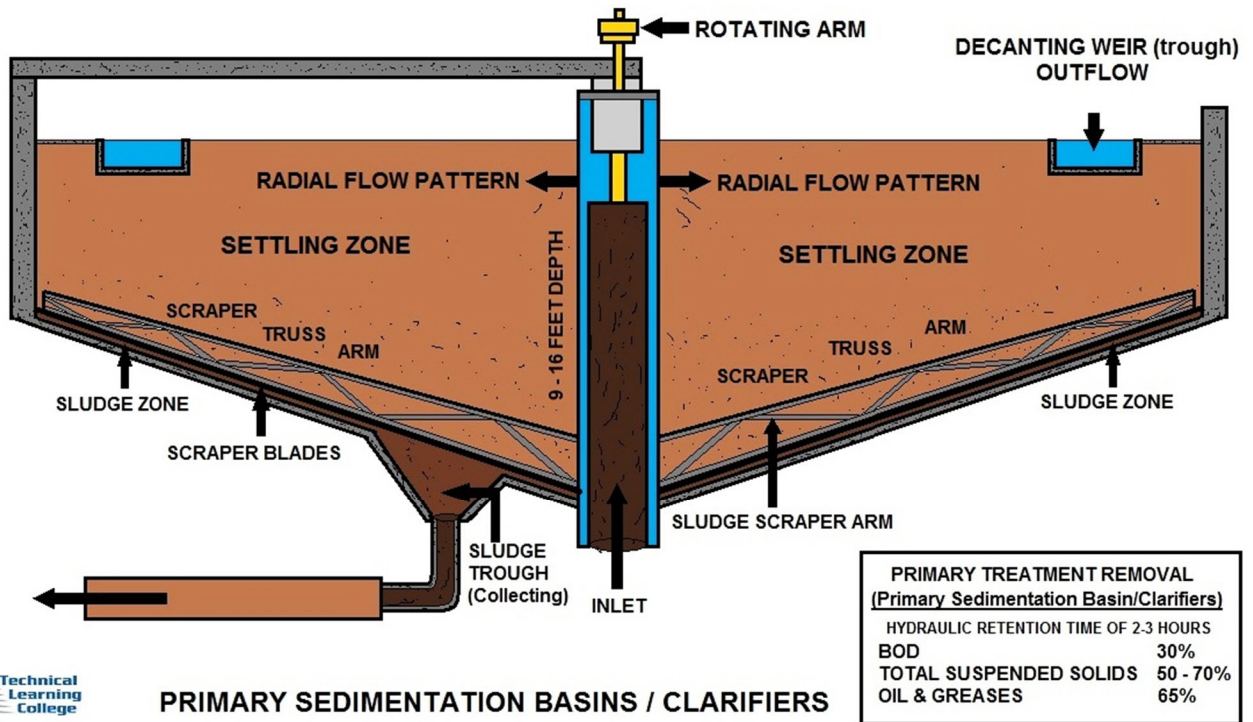

PRIMARY SEDIMENTATION BASINS / CLARIFIERS

Clarifier Operation

Primary treatment is done by delivering the wastewater into big tanks for the solid matter to settle at the bottom of the tanks. The sludge, the solid waste that settles at the bottom of the tanks, is removed by large scrappers and is slowly pushed to the center of the cylindrical tanks. The sludge is periodically pumped out of the tanks for further treatment.

The remaining clarified water is then ready for secondary treatment. After the initial lift of raw sewage from the headworks, most WWTP's are designed so that water can flow by gravity from one process to the next.

CLARIFICATION

A process to reduce the concentration of suspended matter in water. In the activated sludge treatment process, the removal of suspended solids from wastewater is usually through gravity separation in a clarifier.

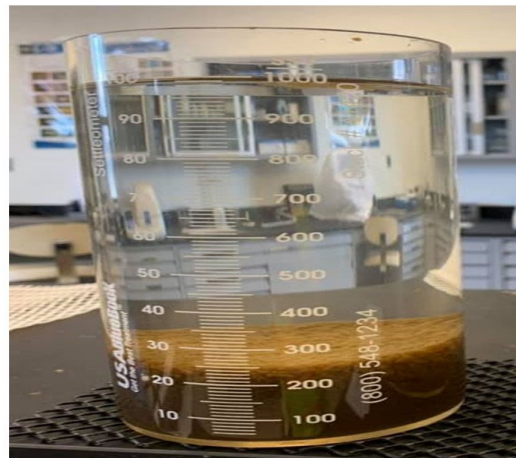

Clarification Process Sub-Section - Secondary Clarification

CLARIFICATION PROCESS

Clarification reduces the concentration of suspended matter in water. In the activated sludge treatment process, the removal of suspended solids from wastewater is usually through gravity separation in a clarifier. Primary and secondary clarifiers are very similar in design and can be circular or rectangular.



Any activated sludge (A/S) plant requires a means to separate the water from the bug population. Many plants will have a second clarification process or filtration system for emergency, maintenance or demand issue. Many of these processes are not A/S processes per say, but again, anytime you cultivate a bug population for eating of wastewater food, this action is generally considered A/S.

The **Secondary Clarification** process generally consists of four rectangular tanks that provide quiescent (or calm) conditions that allow the larger aggregates of solids and microorganisms to settle out for collection. The clear overflow (or upper layer) is collected at the end of the tank and passed onto the Tertiary process for additional treatment if available.

The majority of microorganism-rich underflow (or lower layer) is re-circulated to Aeration Tanks as Return Sludge to help sustain the microorganism population in the Oxidation Ditches process. However, if all the underflow was returned the plant would soon become overloaded with solids. To keep the food/microorganism ratio in a healthy balance, therefore, a small portion of this mixture termed Waste Activated Sludge (WAS) is removed from the system for disposal. The WAS is transported into the Solids Handling process for disposal.



Rectangular Secondary Clarifier

A settling tank used to remove suspended solids by gravity settling. Commonly referred to as sedimentation or settling basins, they are usually equipped with a motor driven chain and flight or rake mechanism to collect settled sludge and move it to a final removal point.

Because microorganisms are continually produced, a way must be provided for wasting some of the generated biological solids produced. This is generally done from the round or rectangular shaped clarifiers.

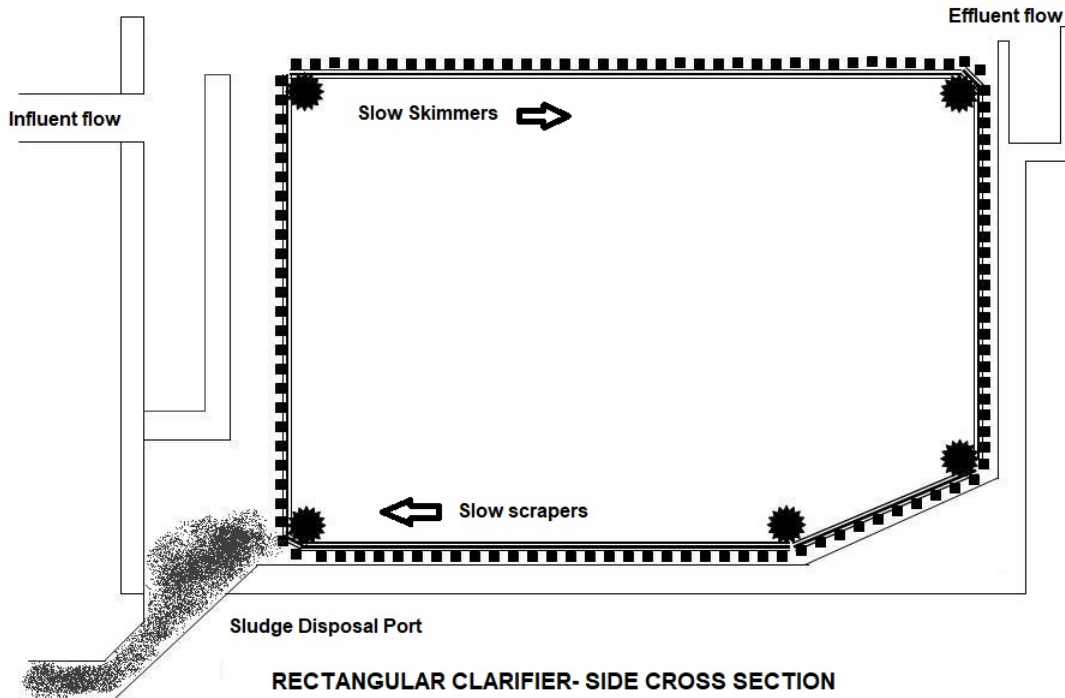

Let's look at the components of a rectangular clarifier. Most are designed with scrapers on the bottom to move the settled activated sludge to one or more hoppers at the influent end of the tank. It could have a screw conveyor or a traveling bridge used to collect and move the sludge along in the end hopper.

The most common is a chain and flight collector. Most designs will have baffles to prevent short-circuiting and scum from entering the effluent. The activated sludge is removed from the hopper(s) and returned by a sludge pump to the aeration tank or wasted.

Summary

The screening process along with grit removal enhances the operation of a primary clarifier, as seen above, by removing settleable solids and non-settable such as oil and grease. This process involves the separation of macrobiotic solid matter from the wastewater.

Clarifier - Constant Rate Versus Constant Percentage Return

There are several ways for returning sludge to the aeration tank:

1. At a rate modified to anticipate organic and hydraulic loading.
2. At a constant rate, independent of the secondary influent flow rate.
3. At a constant percentage of the varying secondary influent flow.

Variations or blends of these RAS strategies may work best at different plants. Clarifier size and hydraulics may limit the range of practical return adjustments. Regardless of calculated values, return rates should not be reduced to the level where slowly moving, thick clarifier sludge will plug the sludge withdrawal pipes.

Variable Rate Control

Low return rates during the night can be increased in the early morning to approach the higher return rates during the day before, rather than after, the increased wastewater flows actually reach the plant. This oxygenates the bacteria and gets the bugs ready to rapidly assimilate the incoming food. Increasing the return sludge flow after the flow increase may also cause a hydraulic overload condition, resulting in a carryover of solids into the clarifiers (washout).

Constant Rate Control

Returning activated sludge at a constant flow rate that is independent of the secondary influent wastewater flow rate results in a continuously varying MLSS concentration that will be at a minimum during peak secondary influent flows and a maximum during minimum secondary influent flows.

The aeration tank and the secondary clarifier must be looked at as a system where the MLSS are stored in the aeration tank during minimum wastewater flow and then transferred to the clarifier as the wastewater flow and then transferred to the clarifier as the wastewater flows initially increase.

The clarifier acts as a storage reservoir for the MLSS during periods of high flow. The clarifier has a constantly changing depth of sludge blanket as the MLSS moves from the aeration tank to the clarifier and vice versa. This can work so long as the sludge blanket does not become too deep or some of the sludge begins to rise.

Constant Percentage Control

Another approach is to pace the return flow at a fixed percentage of the influent wastewater flow rate (Q), at a constant ratio or rate (R) R/Q . This may be done automatically with instruments, or manually with frequent adjustments. This approach keeps the MLSS and sludge blanket depths more constant throughout high and low flow periods and also tends to maintain a more constant F/M and $MCRT$. It has the disadvantage of creating more variable constant and detention times.

Settleability

The settleability test can be used to estimate the desirable sludge return rate. This method uses the sludge volume in a 2-L settleometer at the end of a 30-minute settling period to represent the underflow and the supernatant volume to represent the overflow.

Primary Clarifier or Dissolved Air Floatation Thickener (DAFT)

Another type of sludge removal process is a dissolved air floatation thickener. Dissolved air floatation thickeners work by adding compressed air to the bottom of a tank and utilizing the bubble curtain to lift or float solids. The DAFT is capable of achieving similar percentage removals for BOD₅ and TSS as primary clarifiers. Dissolved air floatation thickeners are more common in industrial treatment facilities than at WWTPs.

DAFT Operation

Primary and secondary sludges are combined into a homogeneous mixture and thickened in to dissolved air flotation tanks. The DAFT tanks are severed by an equipment gallery which houses mechanical support systems. Mixed sludge is skimmed off and distributed to the DAFTs by overflow weirs.

As the sludge enters the DAFT center column it contacts air bubbles less than 100 µm in diameter released from a pressurized recycled effluent stream. The resulting air/solids aggregate floats the entrained solids to the surface of the tank. Concentrated float is skimmed from the DAFT water surface and pumped to the digestion process. The DAFT system removes about 90 percent of the water in the waste activated sludge, increasing the float concentration to approximately 5 percent solids.

The thickener's liquid effluent (subnatant) flows out of the tank via a submerged orifice collection system. This feature, coupled with a level controlled modulating valve, allows the liquid level within the thickener to be adjusted. By varying the liquid level, the float depth and concentration can be optimized before skimming into the collection troughs. A portion of the subnatant is recycled through the pressurization system.

Types of Solids in Wastewater

ACRONYM	COMMON TERM	EXPLANATION
TSS	Total Suspended Solids	Solids that cannot pass through a 1.2-µm filter.
TVSS	Total Volatile Suspended Solids	Solids that cannot pass through a 1.2 - µm filter and are burned away when placed in a furnace at 550° C.
TDS	Total Dissolved Solids	Solids that are small enough to pass through a 1.2 - µm filter. The sample must be dried completely before the dissolved solids can be seen with the naked eye.
TS	Total Solids	All of the solid material in a sample. This includes both organic and inorganic solids. TS = TSS + TDS
TVS	Total Volatile Solids	All of the solids in a sample that are burned away when placed in a furnace at 550° C

Photo Journal #2



Top photograph, a clarifier's raking mechanism.



Bottom, scum armature skimmer on a secondary clarifier.



A **rectangular clarifier** used in the secondary settling process. Operation changes should be employed if a dark brown foam develops on the aeration basin, primary option is to increase the wasting rate.



Pin floc being carried over the secondary clarifier weir due to a process upset. Ideally, the secondary effluent will be very clear. Excessive algae growth will create several different problems.

Clarifier Problems and Solutions

BULKING SLUDGE

A phenomenon that occurs in activated sludge plants whereby the sludge occupies excessive volumes and will not concentrate readily. This condition refers to a decrease in the ability of the sludge to settle and consequent loss over the settling tank weir. Bulking in activated sludge aeration tanks is caused mainly by excess suspended solids (SS) content and/or filamentous bacteria.

Sludge bulking in the final settling tank of an activated sludge plant may be caused by:

1. Fats, Oils, and Grease
2. Low Dissolved Oxygen
3. Low F/M Ratio
4. Nutrient Deficiency
5. Septicity (Organic Acids and Sulfide)

PIN FLOC

Very fine floc particles with poor settling characteristics, usually indicative of an old sludge (high MLSS levels).



SLUDGE FERMENTATION

An **anaerobic medium containing sludge supernatant fluid and glucose** was used for enumeration of bacteria from the sludge fermentation.



SLUDGE BLANKET

The sludge blanket is the layer of solids on the bottom of the clarifier.



STRAGGLER FLOC

Small, light, and fluffy floc particles with poor settling characteristics, usually indicative of a younger sludge and/or low MLSS levels. Decrease the WAS to increase the sludge age, decrease the F/M ratio.



OLD SLUDGE

Old sludge consists of sludge in which the sludge age is too high to be most effective in a particular activated sludge process. Dark brown foam and a greasy or scummy appearance on the aeration tank is an indicator of old sludge. Settling in the clarifier is rapid, but pin floc can be present in the effluent and the effluent is hazy. Old sludge is often associated with a low F/M ratio. To correct for old sludge, it is necessary to increase wasting rates and return less sludge to the aeration basin. This will reduce the amount of solids under aeration, increase the F/M ratio and decrease the sludge age.

We will cover filamentous bacteria later in the Activated Sludge Chapter.

Hyperlink to the Glossary and Appendix

<http://www.abctlc.com/downloads/PDF/WWTGlossary.pdf>

Scum Removal Sub-Section

Scum removal equipment is highly desirable on secondary clarifiers. Skimmers are usually of the type that rotates automatically. *Flights and chains* move the settled sludge to the hopper in the clarifier for return and they also remove the scum from the surface of the clarifier. The flights are usually wood or other nonmetallic flights mounted on parallel chains that pull them.

The drive motor shaft is connected through a gear reducer to a shaft that turns the drive chain. The drive chain turns the drive sprockets and the head shafts. The shafts can be located overhead or below the water level

Some clarifiers may not have scum removal equipment so the configuration of the shaft may vary. As the flights travel across the bottom of the clarifier, wearing shoes are used to protect the flights. The shoes are usually metal or nylon and travel across a metal track.

To prevent damage due to overloads, a shear pin is used. The shear pin holds the gear solidly on the shaft so that no slippage occurs. Remember, the gear moves the drive chain. If a heavy load is put on the sludge collector system, the shear pin should break. This means the gear would simply slide around the shaft and movement of the drive chain would stop.

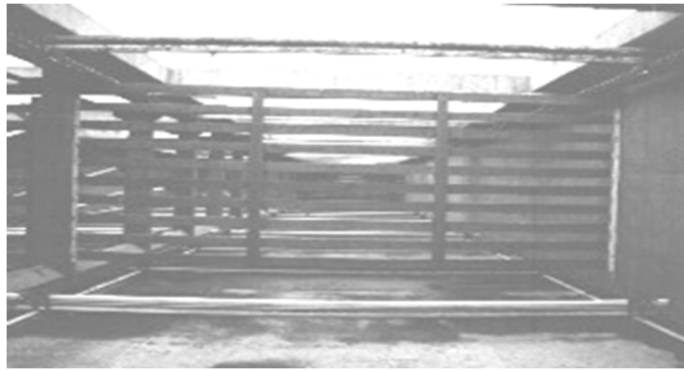

Baffles to dissipate flow in a rectangular secondary clarifier.



Clarifier Drive Motor

Scum Removal Equipment

In some circular or square tanks, rotating scrapers are used. The most common mechanism in a circular clarifier has a center pier or column. The major mechanical parts of the clarifier are the drive unit; the sludge collector mechanism; and the scum removal system. There is also some related equipment that we will consider briefly. Let's look at the drive unit first. There are three main parts to the drive unit; the motor (or gear motor); the gear reducer; and the turntable.

The motor is connected to a gear reduction unit which is commonly connected to additional gearing. The drive cage is rotated around a center column by the motor and gear reduction unit. Although the drive motor runs at about 1800 rpm, the gear reducer lowers the output speed so that the sludge collector mechanism goes through one revolution every 20 to 30 minutes. Usually, the motors used on clarifier mechanisms are totally enclosed, fan cooled motors, suitable for outside operation.

The horsepower of the motor is dependent on the size of the clarifier. The motor drives the chain and sprocket which drives the worm gear. The worm gear drives the gear that is mounted on a shaft that drives the turntable. The motor shaft speed is often reduced by a series of gear reducers or electronically regulated.

Sludge Collector and the Scum Removal System Mechanism

The main parts of the unit are: the rake arm; the scraper blades; the adjustable squeegees; the surface skimmer; the scum baffles; and the scum box.

The surface skimmer rotates at the same speed as the collector mechanism and is usually supported by the collector rake arm. The scum baffle prevents scum from flowing over the effluent weir. The surface skimmer collects the scum and deposits it in the scum box.

The stilling well or influent baffle projects above the liquid and directs the influent downwards to assist in settling suspended solids and reduce short circuiting. An effluent weir goes around the circumference of the tank and allows clarified liquid to flow evenly from the tank. The effluent launder collects the tank overflow and takes it to a low point in the launder where a pipe is used to take the effluent to the chlorine contact basin or next treatment.

Some clarifiers may have a scum trough heater. The scum removal system rotates around the clarifier at a very slow rate. In subfreezing temperatures, the scum box and pipe could freeze. This problem can be overcome by using immersion heaters, or putting infrared lamps over the scum box. Some clarifiers are covered, which can also serve to protect the scum from freezing or for odor control.



Typical scum removal equipment on the weir. Another important part of the secondary clarifier is the effluent weir, launder and pipe.

Wastewater Treatment Plant Problems



Retrofitting Older Treatment Technology

Most of our wastewater treatment plants in the United States were constructed more than two to four decades ago. Many of these treatment facilities need to be upgraded to improve capacity and treatment efficiency. This may consist of adding an A/S facility or an entire facility retrofitting.

The upgraded treatment processes that can best fit the existing technologies at Publicly Owned Treatment Works (POTWs) are selected based upon wastewater discharge (NPDES) permit requirements and their cost-effectiveness to achieve water quality objectives and protect public health. Such upgrades are often opportunities to employ emerging technologies or established technologies in newer and better ways.

Some of the areas of current and future interest are as follows:

- ✓ Innovative wastewater collection system designs that provide real-time condition assessment data for asset management decision-making.
- ✓ Determination of the long-term performance and life-cycle cost effectiveness of emerging system rehabilitation techniques, including new and existing materials.
- ✓ Advanced sewer system designs that minimize energy consumption and greenhouse gas emissions.

Credit to the USEPA

Struvite (MAP) Magnesium, Ammonia and Phosphate Problem



Struvite deposits inside a digester pipe.

Struvite is magnesium ammonium phosphate. Struvite is a corrosion problem in wastewater treatment, particularly after anaerobic digesters release ammonium and phosphate from waste material. Struvite forms a scale on lines and belts, in centrifuges and pumps, clog system pipes and other equipment including the anaerobic digester itself.

MAP is found in channels, pipes and diffusers causing restrictions and friction, slowing the flow, even restricting sampling ports. Some operators refer to MAP as encrustation and its removal is a full-time maintenance issue.

MAP forms when there is a mole-to-mole-to-mole ratio (1:1:1) of magnesium, ammonia and phosphate in the wastewater. The magnesium is found in soil, seawater and in some groundwater. Magnesium is the ingredient in least supply in an anaerobic digester.

The ammonia is from the urea in wastewater. Phosphate is found through food, soaps and detergents. With these elements in place, struvite is more likely to form in a high pH environment. Higher conductivity, lower temperatures, and higher concentrations of magnesium, ammonia and phosphate promote the creation of struvite.

Recovery of phosphorus from wastestreams as struvite and recycling those nutrients into agriculture as fertilizer appears to be a good solution, particularly in agricultural manure processing and municipal wastewater treatment plants.

Credit to the USEPA

Photo Journal #3



The results of not having grit removal. Filling part of an oxidation ditch aeration tank.



A buildup of grease balls in an oxidation ditch.



This clarifier is used to thicken sludge prior to the digester. This is not a digester but looks like one: Notice the light on the top for Operators to look inside.



These two above ground circular tanks are massive anaerobic digesters.

Plant Key Design and Operational Issues *Credit EPA*

Temperature

In general, as temperature of the wastewater increases, the rate of nitrification and denitrification increases. For the typical range of liquid temperatures between 10 and 25° C, the nitrification rate will approximately double for every 8 to 10° C increase in temperature (WEF and ASCE, 2006). Rapid decreases in temperature without acclimation time will cause even slower nitrification rates than predicted strictly by the temperature change. Denitrification rates will also increase with increasing temperature, although not at the same magnitude as nitrification rates.

TEMPERATURE AND GROWTH RATES

All biological and chemical reactions are affected by temperature. Microorganisms growth and reaction rates are slow at cold temperatures and much faster at warmer temperatures. Most microorganisms do best under moderate temperatures (10-25°C). Aeration basin temperatures should be routinely measured and recorded. Although the temperature may not be easily changed, the MLSS, DO, and RAS rates may be adjusted to partially compensate and keep the bugs effective.

Dissolved Oxygen

Nitrifying bacteria are also more sensitive to DO levels as compared to aerobic heterotrophic bacteria, with growth rates starting to decline when DO drops below 3 to 4 mg/L, and significant reduction below 2 mg/L. The nitrification rate at a DO concentration of 0.50 mg/L is only about 60 percent of that at a 2.0 mg/L DO concentration.

Studies have shown that the amount of oxygen available to nitrifying bacteria can be limited by floc size, requiring higher bulk DO concentrations under higher organic loading conditions (Stenstrom and Song, 1991).

At DO concentrations less than 0.5 mg/L, the effect is greater for *Nitrobacter* than for *Nitrosomonas*. This can result in higher NO₂-N (nitrite) in the effluent and have a negative impact on chlorine disinfection as 1 g of NO₂-N consumes 5 g chlorine for oxidation. DO must normally be less than 0.2 to 0.5 mg/L, otherwise there will be inhibition of the denitrification process.

DISSOLVED OXYGEN

Dissolved oxygen refers to the level of free, non-compound **oxygen** present in water or other liquids. It is an important parameter in assessing water quality because of its influence on the organisms living within a body of water.



Nitrification and Denitrification

pH and Alkalinity

Nitrification generally operates well within a pH range of 6.8 to 8.0 (WEF and ASCE, 2006). At lower pH values the nitrification rate is much slower and at pH values near 6.0 the nitrification rate may only be about 20 percent of that with a pH of 7.0 (Tchobanoglous et al., 2003).

Alkalinity is consumed during the nitrification process but partially replenished (up to 62.5 percent) during the denitrification process. Depending on the influent wastewater alkalinity, there may be a sufficient alkalinity reduction due to nitrification to decrease to unacceptable levels. Addition of chemicals such as lime, sodium hydroxide, or soda ash can be used to replace the alkalinity consumed by nitrification to maintain acceptable pH levels.

Carbon Sources for Denitrification

Denitrifying bacteria need a readily available carbon food source, such as soluble BOD, to ultimately convert nitrate to nitrogen gas. WWTPs that meet very low total nitrogen limits typically use a secondary anoxic zone in which supplemental carbon is added. Supplemental sources can be “internal” such as primary effluent, fermented wastewater or sludge, or “external” sources such as purchased chemicals.

Methanol is currently the most common external carbon source used in denitrification because of its low cost. It has several drawbacks, however, namely:

- It is highly flammable and implicated in some storage tank explosions and fires (Dolan, 2007); however, with proper design and operation problems can be minimized.
- It is not the most efficient source for most treatment configurations.
- Costs have begun to fluctuate widely (deBarbadillo et al., 2008).
- Availability is a problem in some areas (Neethling et al. 2008).
- Reported low growth rates under cold temperatures (Dold et al. 2008).

Other sources of carbon include ethanol, acetic acid, corn syrup, molasses, glucose, glycerol, and industrial waste products. The WEF Nutrient Challenge Research Plan (2007) identified research on alternative carbon sources as priority for operators, owners, and engineers of wastewater systems. In December of 2007, the 2nd External Carbon Workshop was held in Washington, DC to discuss the state of the technology and research needs. WERF is also currently formulating a standard protocol for evaluation of external carbon alternatives.

Nitrification Inhibition from Toxic Chemicals

Nitrifying bacteria are very sensitive to heavy metals and other inorganic compounds in wastewater. The Local Limits Development Guidance Manual (USEPA 2004) has been the main source of information on inhibitory effects for a variety of wastewater treatment processes including nitrification. Appendix G of the 2004 version provides a summary table with the reported range of nitrification inhibition threshold levels for a number of metals, non-metal inorganics, and organic compounds. Actual inhibitory effects are site-specific and depend on many factors including the nature of biodegradable organic material, microorganism speciation, acclimation effects, temperature, and water quality conditions.

Wet Weather Events

Wet weather events can increase inflow and infiltration into the collection system and subsequently increase the hydraulic load to the wastewater treatment plant. This can in turn reduce the SRT leading to reduced performance of nitrification process units.

In addition, wet weather flows have different characteristics than typical wastewater influent flow and can be less favorable for nitrification and denitrification. Conditions that are less favorable for nitrification include decreased alkalinity and sudden temperature drops. Lower biodegradable COD concentrations and increased DO make wet weather flows less amenable to denitrification.

Flow equalization basins can be used to handle wet weather events; however, this requires available space and capital investment. USEPA (2008a) identifies a number of innovative storage and treatment technologies used to manage influent flows during wet weather events.

Guidance for Selecting Process Modifications

Nitrogen removal requires first that a biological nitrification process be present or that the facility be modified to accomplish nitrification. Considerably more volume is needed for activated sludge nitrification compared to designs for BOD removal only. If there is insufficient space to accommodate the increased volume, suspended growth or hybrid process options that require less space such as the MBR process or IFAS systems with suspended media in the activated sludge process should be considered. Another option is to use a fixed film nitrification process after the suspended growth process clarification step. This could be a BAF or a plastic media trickling filter. However, if nitrogen removal is required, an exogenous carbon source is needed, which has higher operating costs than using the influent BOD for denitrification.

Nitrification systems need sufficient oxygen transfer for ammonia oxidation in addition to BOD removal. Such systems should consider the impact to diurnal loadings and ammonia addition in recycle streams. The influent TN concentration may have daily peak values that are 1.5 to 2.0 times the daily average loading.

Higher peak loadings require longer SRTs to assure that sufficient nitrifying bacteria are present to remove ammonia at a greater rate, while maintaining a low effluent ammonia concentration. Often anaerobic digester sludge dewatering operations occur during the day and produce return recycle streams high in ammonia concentration (500-1000 mg/L) at times that coincide with the high influent diurnal ammonia loads. Recycle equalization or treatment helps to provide a more stable nitrification system and lower effluent $\text{NH}_3\text{-N}$ concentrations.

In many cases, it is advantageous to incorporate a denitrification pre-anoxic step with nitrification (MLE process) due to the many benefits and improved operational stability.

The advantages include:

- 1) less aeration energy as the nitrate produced can be used for BOD removal,
- 2) the production of alkalinity to offset the alkalinity used by nitrification, which in some cases eliminates the need to purchase alkalinity, and
- 3) a more stable, better settling activated sludge process as the anoxic-aerobic processes favor good settling floc-forming bacteria over filamentous growth.

The effluent nitrogen goals greatly affect the process design choices and system operation. For an effluent goal of 10 mg/L TN, an MLE process is often sufficient for activated sludge treatment with secondary clarifiers or membrane separation. However, with water conservation leading to more concentrated wastewater, these processes alone may not be sufficient due to the fact that they are limited to 80-85% removal of the influent TN.

For TN effluent goals of 3 to 5 mg/L or lower, some form of post anoxic treatment is generally needed. One option is to convert an MLE process to a Bardenpho process by adding another anoxic aerobic set of tanks. Although the endogenous respiration rate of the bacteria can be used to consume nitrate in the post anoxic tanks, it is often necessary to add an exogenous carbon source. Other alternatives to using exogenous carbon sources include denitrification filters instead of adding more activated sludge tank volume, step feed with carbon addition in the last pass, and IFAS processes.

Denitrification processes require sufficient carbon to drive the nitrate/nitrite reduction reactions. Characterization of the influent wastewater with regard to its organic strength and soluble fraction and the TN and ammonia concentrations is needed to fully understand a system's carbon needs. In addition, design and operating methods that eliminate or minimize DO feeding to anoxic zones can reduce the amount of exogenous carbon needed and provide a more stable operation. Low DO zones prior to downstream anoxic tanks or for withdrawal of recycle to preanoxic zones should be considered.

Impacts on Sludge Production and Handling

It has been documented by both research and full scale experiments that BOD removal by activated sludge using nitrate as the electron acceptor instead of DO will result in a 20% or more reduction in waste activated sludge (WAS) production for the same operating conditions. Full-scale investigations near Melbourne, Australia achieved as high as a 40% reduction in WAS, and implementation of nitrogen removal at the York River, VA, plant resulted in a reduction of more than 50% in WAS production. The impact this will have on total sludge production by a treatment plant will depend upon how much waste sludge is produced by other treatment units such as primary clarifiers and chemical treatment with precipitating chemicals.

Additionally, implementation of nitrogen removal at conventional activated sludge plants can improve the thickening characteristics due to decreasing the amounts of filamentous bacteria in the activated sludge. If an external carbon source is added to improve the rate of denitrification, there will be an increase in WAS production compared to when no external carbon source is added.

If an external carbon source is used to supplement denitrification, it is likely that the small increase in solids production will be offset by endogenous respiration due to longer SRTs. Solids produced from nitrogen removal processes generally thicken and dewater well and show no negative impact on any solids processing system.



Processed Wastewater Solids Handling Sub-Section

Processed wastewater solids (“sewage sludge”) that meet rigorous standards allowing safe reuse for beneficial purposes. Currently, more than half of the activated sludge biosolids produced by municipal wastewater treatment systems are applied to land as a soil conditioner or fertilizer and the remaining solids are incinerated or landfilled. Even the solids need to be analyzed as part of your compliance, noncompliance or local limits requirements. We will return to this subject later in the course.

BIOSOLIDS

Biosolids are nutrient-rich organic materials resulting from the treatment of domestic sewage in a treatment facility. When treated and processed, these residuals can be recycled and applied as fertilizer. Compliance with pretreatment requirements is important to ensure that **biosolids** produced at the POTW have pollutant concentrations low enough to allow the beneficial use of this material. **Biosolids** recycling is the process of beneficially using treated residuals from wastewater treatment to promote the growth of agricultural crops, fertilize gardens and parks and reclaim mining sites.



Large solids handling facility

Anaerobic Digestion

Primary sludge is the sludge that is taken from the bottom of the settling tank. The amount and rate of the raw sludge being pumped is determined by the depth of the sludge. Operators have to be mindful not to remove water from the tank, diluting the sludge.

Of all biological waste treatment methods, aerobic digestion is the most widespread process used throughout the world (more than 95%). Nature gives - takes and does everything in-between. Nowhere is this better exemplified than the biological solution it offers to mankind's waste problems. An illustration of nature's work is its influence on the constant cycle of biological waste treatment. Microorganisms, like all living things, require food for growth.

Biological sewage treatment consists of many different microorganisms, mostly bacteria. These bugs carry out a stepwise, continuous, sequential attack on the organic compounds found in wastewater and upon which the microbes feed.

Aerobic digestion of waste is the natural biological degradation and purification process in which bacteria that thrive in oxygen-rich environments break down and digest the waste.

During this oxidation process, pollutants are broken down into carbon dioxide (CO₂), water (H₂O), nitrates, sulfates and biomass (microorganisms). By optimizing the oxygen supply with aerators, the process can be significantly accelerated.

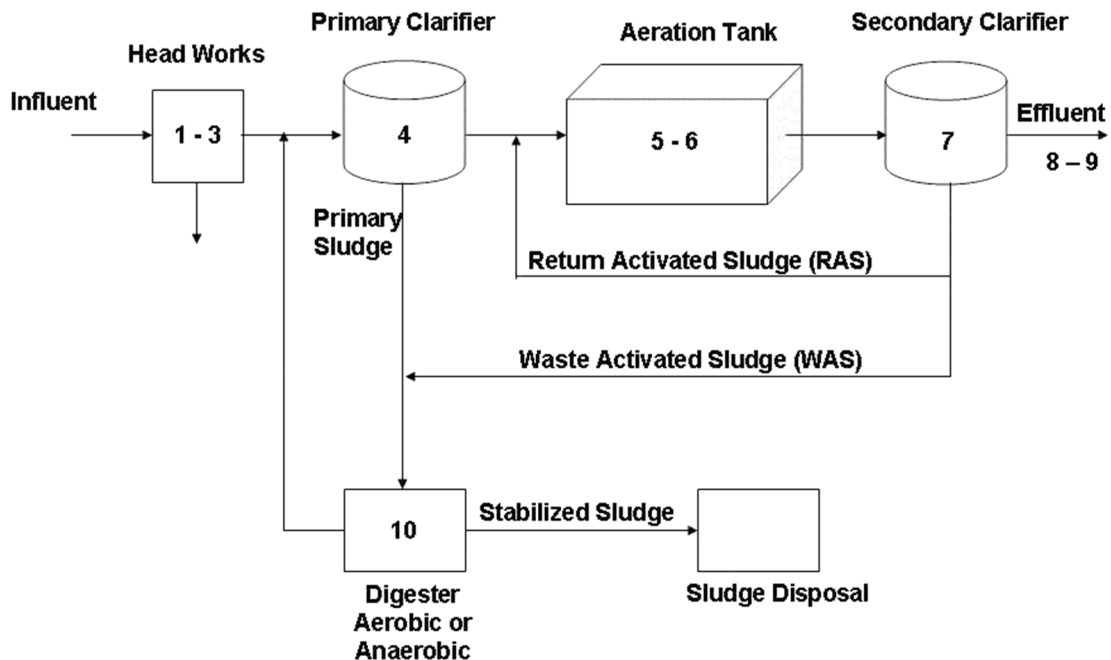

Ocean Dumping

Either raw or stabilized, ocean dumping of these solids is no longer allowed. Even cruise ships will not dump in to the ocean and they are legally permitted to do so.

Biosolids Stabilization

Prior to utilization or disposal, biosolids are stabilized to control odors and reduce the number of disease-causing organisms. Sewage solids, or sludge, when separated from the wastewater, still contain around 98 percent water. They are usually thickened and may be dewatered to reduce the volume to be transported for final processing, disposal, or beneficial use.

Dewatering Processes

Dewatering processes include drying beds, belt filter presses, plate and frame presses, and centrifuges. To improve dewatering effectiveness, the solids can be pretreated with chemicals such as lime, ferric chloride, or polymers to produce larger particles which are easier to remove.



Centrifuge



Filter Press

Anaerobic Digestion

Digestion is a form of stabilization where the volatile material in the wastewater solids can decompose naturally and the potential for odor production is reduced. Digestion without air in an enclosed tank (anaerobic solids digestion) has the added benefit of producing methane gas which can be recovered and used as a source of energy. Stabilization of solids may also be accomplished by composting, heat treatments, drying or the addition of lime or other alkaline materials. After stabilization, the biosolids can be safely spread on land.

Land Application

In many areas, biosolids are marketed to farmers as fertilizer. Federal regulation (40 CFR Part 503) defines minimum requirements for such land application practices, including contaminant limits, field management practices, treatment requirements, monitoring, recordkeeping, and reporting requirements.

Properly treated and applied biosolids are a good source of organic matter for improving soil structure and help supply nitrogen, phosphorus, and micronutrients that are required by plants.

Biosolids have also been used successfully for many years as a soil conditioner and fertilizer, and for restoring and re-vegetating areas with poor soils due to construction activities, strip mining or other practices. Under this biosolids management approach, treated solids in semi liquid or dewatered form are transported to the soil treatment areas. The slurry or dewatered biosolids, containing nutrients and stabilized organic matter, is spread over the land to give nature a hand in returning grass, trees, and flowers to barren land.

Restoration of the countryside also helps control the flow of acid drainage from mines that endangers fish and other aquatic life and contaminates the water with acid, salts, and excessive quantities of metals.

Beneficial Use Products from Biosolids

Heat dried biosolids pellets have been produced and used extensively as a fertilizer product for lawn care, turf production, citrus groves, and vegetable production for many years. Composting of biosolids is also a well-established approach to solids management that has been adopted by a number of communities. The composted peat-like product has shown particular promise for use in the production of soil additives for re-vegetation of topsoil depleted areas, and as a potting soil amendment.

Effective pretreatment of industrial wastes prevents excessive levels of unwanted constituents, such as heavy metals (i.e. cadmium, mercury, and lead) and persistent organic compounds from contaminating the residuals of wastewater treatment and limiting the potential for beneficial use.

Effective stabilization of wastewater residuals and their conversion to biosolid products can be costly. Some cities have produced fertilizers from biosolids which are sold to help pay part of the cost of treating wastewater. Some municipalities use composted, heat dried, or lime stabilized biosolid products on parks and other public areas.

Incineration

Incineration consists of burning the dried solids to reduce the organic residuals to an ash that can be disposed of or reused. Incinerators often include heat recovery features. Undigested sludge solids have significant fuel value as a result of their high organic content. However, the water content must be greatly reduced by dewatering or drying to take advantage of the fuel potential of the biosolids.

For this reason, pressure filtration dewatering equipment is used to obtain biosolids which are sufficiently dry to burn without continual reliance on auxiliary fuels. In some cities, biosolids are mixed with refuse or refuse derived fuel prior to burning. Generally, waste heat is recovered to provide the greatest amount of energy efficiency.

Credit to the USEPA for this text.

Process Control for Secondary Clarifiers

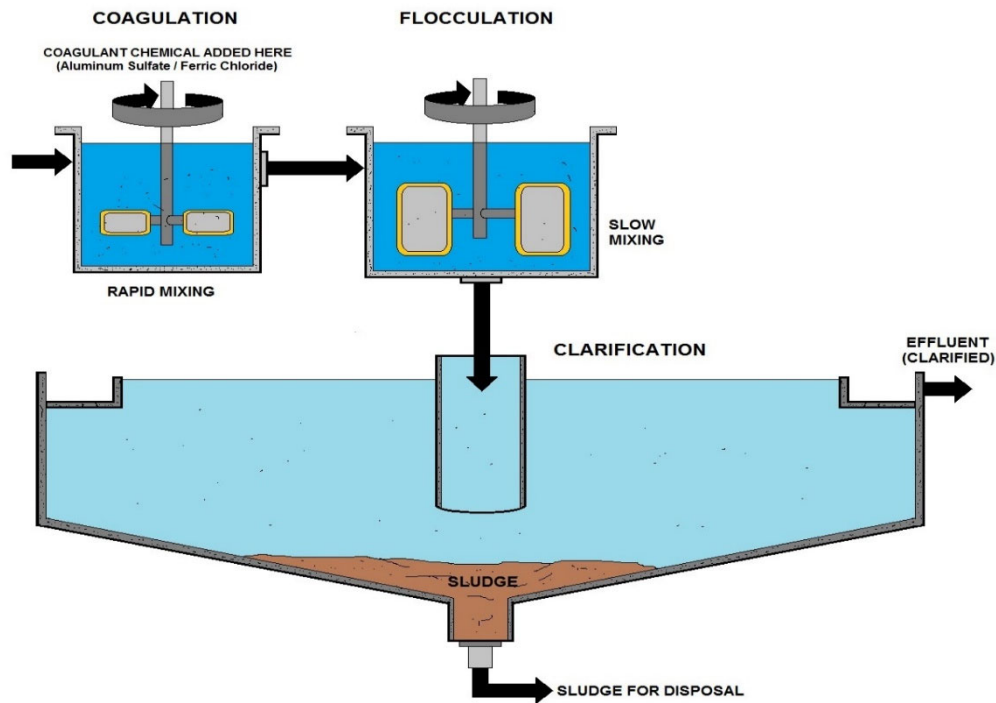

BASIC DIAGRAM OF CHEMICAL COAGULATION PROCESS IN WASTEWATER

Secondary clarifier performance has a significant effect on plant effluent water quality; aeration basin mixed liquor suspended solids (MLSS) concentration and performance; and efficiency of plant solids handling facilities. Key secondary clarifier effluent quality monitoring and control parameters for secondary clarifiers are TSS, BOD, ammonia, total nitrogen and total phosphorus concentrations. When compared to primary effluent water quality, secondary system removal efficiencies can be determined.

Four Key Process Variables

Besides effluent water quality, four key process variables need to be monitored for efficient and cost effective clarifier solids control:

- (1) the amount of solids retained in the secondary clarifiers, which is determined based on the concentration of the return activated sludge (RAS) and the waste activated sludge (WAS) removed from the clarifiers, and on the clarifier sludge blanket depth/volume
- (2) the amount of solids in the aeration basins, which is determined by measuring the MLSS concentration and the aeration tank volume.
- (3) the activated sludge settleability
- (4) the plant influent flow and waste load, significant fluctuations of which may result in the transfer of large amounts of solids to the clarifiers from the aeration basins, thus causing solids carryover with the secondary clarifier effluent.

Progress Goals for Secondary Clarifiers include

- Maintaining the sludge blanket below 2 ft (0.7 m).
- Preventing denitrification in the clarifier blanket (floating sludge).
- Preventing settled sludge from becoming septic, and
- Keeping the RAS flowrates as low as possible while still meeting the other goals.

Primary Wastewater Treatment Section Post Quiz

1. Wastewater treatment plants are designed to reduce the _____ in the effluent discharged to natural waters, the goal is to meet state and federal discharge criteria and protect the environment.
2. Treatment of wastewater usually involves biological processes such as the activated sludge system in the secondary stage after preliminary screening to remove coarse particles and primary sedimentation that settles out _____.
3. The secondary treatment steps are generally considered environmental biotechnologies that harness _____ processes contained in bioreactors for the biodegradation of organic matter and bioconversion of soluble nutrients in the wastewater.
4. The initial stage in the treatment of domestic wastewater is known as _____.
5. _____ are removed from the wastewater in the primary stage of treatment. In some treatment plants, primary and secondary stages may be combined into one basic operation.
6. There are 2 primary treatment processes in the treatment of wastes, *primary (physical)* and _____.
7. In the primary stage, solids are allowed to settle and removed from wastewater. The secondary stage uses _____ to further purify wastewater. Sometimes, these stages are combined into one operation.
8. Primary treatment is done by sending or pouring the wastewater into big tanks for the _____ to settle on the bottom of the tanks.
9. Any activated sludge (A/S) plant requires a means to separate the water from the bug population.
True False
10. The Secondary Clarification process generally consists of four rectangular tanks that provide _____ that allow the larger aggregates of solids and microorganisms to settle out for collection.

11. The best temperatures for wastewater treatment probably range from _____ degrees Fahrenheit.
12. In general, _____ accelerates in warm temperatures and slows in cool temperatures, but extreme hot or cold can stop treatment processes altogether.
13. _____ also affects receiving waters.
14. Hot water, a byproduct of many manufacturing processes, cannot be a pollutant.
True False
15. The acidity or alkalinity of wastewater affects both treatment and the environment.
True False
16. _____ indicates increasing acidity while a high pH indicates increasing alkalinity (a pH of 7 is neutral).

Primary Wastewater Treatment Section Post Quiz Answers

1. BOD and COD, 2. Suspended solids, 3. Natural self-purification, 4. Primary treatment, 5. Coarse solids, 6. Secondary (biological), 7. Biological processes, 8. Solid matter, 9. True, 10. Quiescent (or calm) conditions, 11. 77 to 95, 12. Biological treatment activity, 13. Wastewater temperature, 14. False, 15. True, 16. Low pH

Topic 3 – Alternative Secondary Treatment Section

Section Focus: You will learn the basics of the alternative secondary wastewater treatment process and related subjects. At the end of this section, you will be able to describe the process for wastewater to achieve a certain degree of effluent quality by using a sewage treatment plant with physical phase separation to remove settleable solids and a biological process to remove dissolved and suspended organic compounds. There is a post quiz at the end of this section to review your comprehension and a final examination in the Assignment for your contact hours.

Scope/Background: The United States Environmental Protection Agency (EPA) defined secondary treatment based on the performance observed at late 20th-century bioreactors treating typical United States municipal sewage. Secondary treated sewage is expected to produce effluent with a monthly average of less than 30 mg/l BOD and less than 30 mg/l suspended solids. Weekly averages may be up to 50 percent higher. A sewage treatment plant providing both primary and secondary treatment is expected to remove at least 85 percent of the BOD and suspended solids from domestic sewage. The EPA regulations describe stabilization ponds as providing treatment equivalent to secondary treatment removing 65 percent of the BOD and suspended solids from incoming sewage, thus discharging approximately 50 percent higher effluent waste concentrations than modern bioreactors.



Secondary wastewater treatment processes remove waste organic (once living, biological) material from wastewater, typically using a biological treatment process.

The water quality parameter, biochemical oxygen demand (BOD), is a measure of the amount of oxygen needed to oxidize organic matter in a water sample. It is thus an indirect measure of the pollution of water by waste organic matter.

Secondary Treatment Definition

The secondary treatment can be defined as “treatment of wastewater by a process involving biological treatment with a secondary sedimentation”. In other words, the secondary treatment is a biological process.

The settled wastewater is introduced into a specially designed bioreactor where under aerobic or anaerobic conditions the organic matter is utilized by microorganisms such as bacteria (aerobically or anaerobically), algae, and fungi (aerobically). The bioreactor affords appropriate bioenvironmental conditions for the microorganisms to reproduce and use the dissolved organic matter as energy for themselves. Almost all modern WWTPs employ aerobic processes for secondary treatment.

If oxygen and food, in the form of settled wastewater, are supplied to the microorganisms in the right conditions and ratios, the biological oxidation process of dissolved organic matter will be maintained. The biological process is mostly carried out by bacteria that form the basic trophic level (the level of an organism is the position it occupies in a food chain) of the food chain inside the bioreactor. The bioconversion of dissolved organic matter into thick bacterial biomass can fundamentally purify the wastewater. It is essential to separate the microbial biomass from the treated wastewater through sedimentation. This secondary sedimentation is similar to primary sedimentation except that the sludge contains bacterial cells rather than fecal solids.

The biological removal of organic matter from settled wastewater is conducted by microorganisms, mainly by heterotrophic bacteria but also occasionally fungi. The microorganisms are able to decompose the organic matter through two different biological processes: biological oxidation and biosynthesis. The biological oxidation forms some end-products, such as minerals, that remain in the solution and are discharged with the effluent.

Wastewater Discharge Permits

Wastewater discharge permits limit the amount of pollutants that can be discharged into the environment. Maximum discharge limits are established for total suspended solids (TSS), biochemical oxygen demand (BOD) and E. coli. The purpose of these limits is to accomplish the following objectives:

1. Limit the amount of available organic matter that is discharged to the receiving water to avoid overstimulating the growth of microorganisms in the environment.
2. Limit the amount of dissolved oxygen that the discharged organic matter will deplete in the environment as it is biodegraded by naturally occurring bacteria.
3. Disinfect the wastewater discharge to protect human health by reducing the number of pathogens in the water.

Biological Aspect and Terminology

These are the most used terms in biological treatment processes:

DO: Dissolved Oxygen (mg L^{-1})

BOD: Biochemical Oxygen Demand (mg L^{-1})

BOD₅: BOD (mg L^{-1}), incubation at 15°C for 5 days

COD: Chemical Oxygen Demand (mg L^{-1})

CBOD: Carbonaceous BOD (mg L^{-1})

NBOD: Nitrogenous (mg L^{-1})

SOD: Sediment Oxygen Demand (mg L^{-1})

TBOD: Total BOD (mg L^{-1})

More on Secondary Treatment

By the time wastewater has reached the secondary treatment process, nearly all of the larger particles that are capable of settling on their own have already been removed from the stream by screening, grit removal, and/or primary clarification. The particles that remain are very light and will not settle quickly on their own.

Some colloidal materials smaller than 1000 μm can take 2 years or long to settle. For treatment to continue, the size of the remaining particles must be increased so that they can be efficiently removed. This process can be done chemically or biologically.

Secondary Treatment Standard

The secondary treatment standard requires minimum percentage removals for BOD₅ and TSS, resulting in effluent concentrations between 10 and 30 mg/L. Occasionally, a WWTP might have difficulty meeting 85% removal because their influent BOD₅ and TSS concentrations have been diluted by inflow and infiltration.

Secondary Treatment Ammonia (NH₃), Nitrate (NO₃⁻) and Phosphorus (P) Removal

Secondary treatment processes can also remove ammonia, nitrate and phosphorus even though, technically speaking any treatment that goes beyond the secondary treatment standards is considered tertiary treatment.

Attached or Suspended Growth Systems

Most secondary treatment processes involve biological treatment (bugs) –others as attached or suspended growth systems. Biological treatment processes rely on a mixed population of microorganisms, oxygen and trace amount of nutrients to treat wastewater. The microorganisms consume organic material in the wastewater to sustain themselves and reproduce. We will cover this process in greater and more detail later in several different formats.

Secondary Treatment Results

Secondary treatment of wastewater makes use of oxidation to further purify wastewater. Secondary treatment removes 85 to 95 percent of BOD and TSS and minor portions of nitrogen, phosphorus, and heavy metals.

Tertiary Treatment Introduction

Tertiary treatment is the next wastewater treatment process after secondary treatment. Tertiary treatment is costly when compared to primary and secondary treatment methods. This treatment is sometimes called as the final or advanced treatment and consists of removing the organic load left after secondary treatment for removal of nutrients from sewage and particularly to kill the pathogenic bacteria. The effluents from secondary sewage treatment plants contain both nitrogen (N) and phosphorus (P). N and P two of the nutrients for all life and are also primary ingredients in all fertilizers.

When excess amounts of N and P are discharged, plant growth in the receiving waters may be accelerated which results in eutrophication in the water body receiving such waste. Algae growth may be over stimulated causing blooms that are toxic to fish life as well as aesthetically unpleasing.

Secondary treated effluent also contains some remaining suspended, dissolved, and colloidal materials that may be required to be removed for stipulated reuse or disposal of the treated effluent.

The purpose of tertiary treatment is to provide a final treatment stage to raise the effluent quality before it is discharged to the receiving environment such as sea, river, lake, ground, etc., or to raise the treated water quality to such a level to make it suitable for intended reuse.

This step removes different types of pollutants such as organic matter, SS, nutrients, pathogens, and heavy metals that secondary treatment is not able to remove.

Wastewater effluent becomes even cleaner in tertiary treatment process through the use of stronger and more advanced treatment systems. It includes sedimentation, coagulations, membrane processes, filtration, ion exchange, activated carbon adsorption, electro dialysis, nitrification and denitrification are all tertiary treatment methods.

TREATMENT METHODS	REMOVAL CAPABILITIES
FILTRATION AIR / STEAM STRIPPING	SUSPENDED SOLID PARTICLES DISSOLVED AMMONIA VOLATILE ORGANIC COMPOUNDS (VOC's)
ADSORPTION	DISSOLVED ORGANICS, TO INCLUDE VOC's COLOURING ODORIFEROUS COMPOUNDS
BIOLOGICAL PROCESSES	NITROGENOUS & PHOSPHOROUS COMPOUNDS
MEMBRANE SEPARATION PROCESS SUCH AS MICROFILTRATION, ULTRA FILTRATION, NANOFILTRATION & REVERSE OSMOSIS (RO)	DISSOLVED ORGANICS AND INORGANICS
ION-EXCHANGE PROCESS	DISSOLVED ANIONS AND CATIONS
PRECIPITATION	HEAVY METAL IONS AND OTHER IONIC SUBSTANCES
OXIDATION - REDUCTION	ORGANICS & SOME INORGANICS
DISINFECTION	MICRO - ORGANISMS TO INCLUDE VIRUS



TERTIARY METHODS AND THEIR EFFECTIVENESS IN TREATMENT

Secondary Treatment Boxes 5 – 6 See *Illustration chart*

Pollutants that are dissolved or are very fine and remain suspended in the wastewater are not removed effectively by gravity settling. When the wastewater enters a sedimentation tank, it slows down and the suspended solids gradually sink to the bottom. This mass of solids is called primary sludge.

Various methods have been devised to remove solids, with mechanical equipment to remove the settled solids. Some plants remove solids continuously while others do so at intervals.



Secondary Treatment

After the wastewater has been through primary treatment processes, it flows into the next stage of treatment called secondary. Secondary treatment processes can remove up to 90 percent of the organic matter in wastewater by using biological treatment processes. The two most common conventional methods used to achieve secondary treatment are attached growth processes and suspended growth processes.

This section will discuss various types of secondary treatments that are alternative to conventional activated sludge treatment. Most of these alternative treatments are employed in smaller WWTPs.

The Secondary Treatment stage consists of a biological process such as **Ponds**, **Oxidation Ditches** and the physical process, **Secondary Clarification**. The preliminary treatment stage removed as much debris and solids as possible using physical processes, however, very fine solids are still present that cannot be removed physically by screening.

Most oxidization ditches do not have primary sedimentation processes. Oxidization ditches can be used for denitrification.



Oxidation ditch baffles slowing down the flow.

The wastewater enters from preliminary treatment into the oxidation ditches process which is a biological process consisting of large oval shaped basins which are capable of removing these finer solids.

This is accomplished by maintaining a population of microorganisms within the oxidation basins which consume the very fine (organic) solids and also adhere to the solids themselves.

By consuming and adhering to these finer solids they form larger and heavier aggregates that can be physically separated. This takes place in the secondary clarifier.

Normally, the oxidation ditch process is not considered part of the A/S system. It does harbor a population of bugs and they are re-circulated to the oxidation ditch from the secondary clarifier, like in the activated sludge process.

DISSOLVED OXYGEN

Dissolved oxygen refers to the level of free, non-compound **oxygen** present in water or other liquids. It is an important parameter in assessing water quality because of its influence on the organisms living within a body of water.



More on DO in the Laboratory Procedures (Process Control) section.

Ponds and Lagoons Sub-Section

The activated sludge process can be thought of as a mechanical modification and accelerated version of the pond treatment system. The activated sludge process adds a recycle line that returns the biological solids that settle out in the clarifier back to the front end of the process.

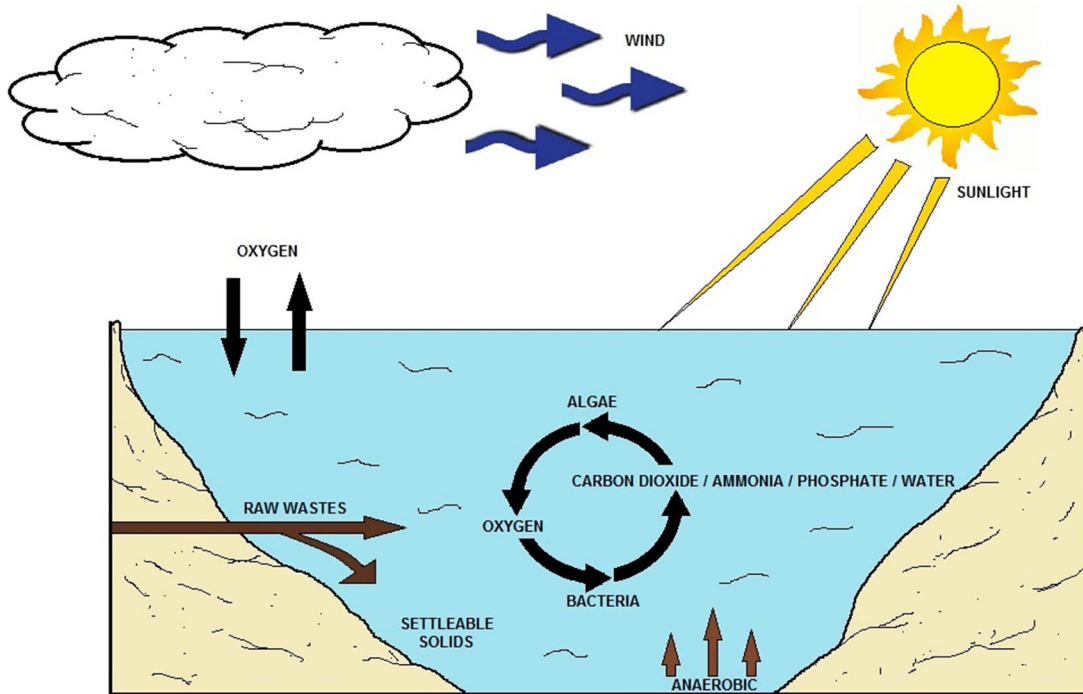

SECONDARY FACULTATIVE LAGOON #1

The primary difference between ponds and lagoons is the depth. Ponds are generally shallow, typically 3 to 5 feet, and they are often used in small communities to treat domestic waste. The primary method that ponds work is stabilizing the waste is by allowing the heavy solids settle to the bottom where they are decomposed by bacteria. The pond's clarity is dependent by the number of ponds detention time, temperature, and waste load. We refer to the pond configuration as in series (in a row) or parallel (side-by-side).

LAGOONS

Lagoons are pond-like bodies of water or basins designed to receive, hold, and treat wastewater for a predetermined periods of time. In the lagoon, wastewater is treated through a combination of physical, biological, and chemical processes.



Dissolved nutrients, such as nitrogen and phosphorus are used by green algae which are microscopic plants floating and living in the water. The algae use carbon dioxide (CO₂) and bicarbonate to build body protoplasm. These algae also need nitrogen and phosphorus in their metabolism, much as land plants do. Like land plants, they release oxygen and some carbon dioxide as waste products.

The most often used ponds in domestic wastewater treatment are the stabilization pond and facultative lagoon.

The stabilization pond is designed to be aerobic throughout its depth and the facultative lagoon will be anaerobic at the bottom and aerobic at the top. Stabilization ponds provide secondary biological treatment and are the most commonly used wastewater pond. Stabilization ponds must be preceded by some form of primary treatment to reduce the solids entering the pond.

Aerobic Process

In the aerobic process, the reactions occurring can be summarized as:



In fisheries, the need for addition of nutrients (the most common being nitrogen and phosphorus) seldom appears, but an adequate level of oxygen is essential for aquatic life.

The most common aerobic processes are: activated sludge systems, lagoons, trickling filters and rotating disk contactors. These aerobic processes are described, together with the devices used for aeration.



The rotor used above is for increase oxygen and mixing in an oxidation ditch.

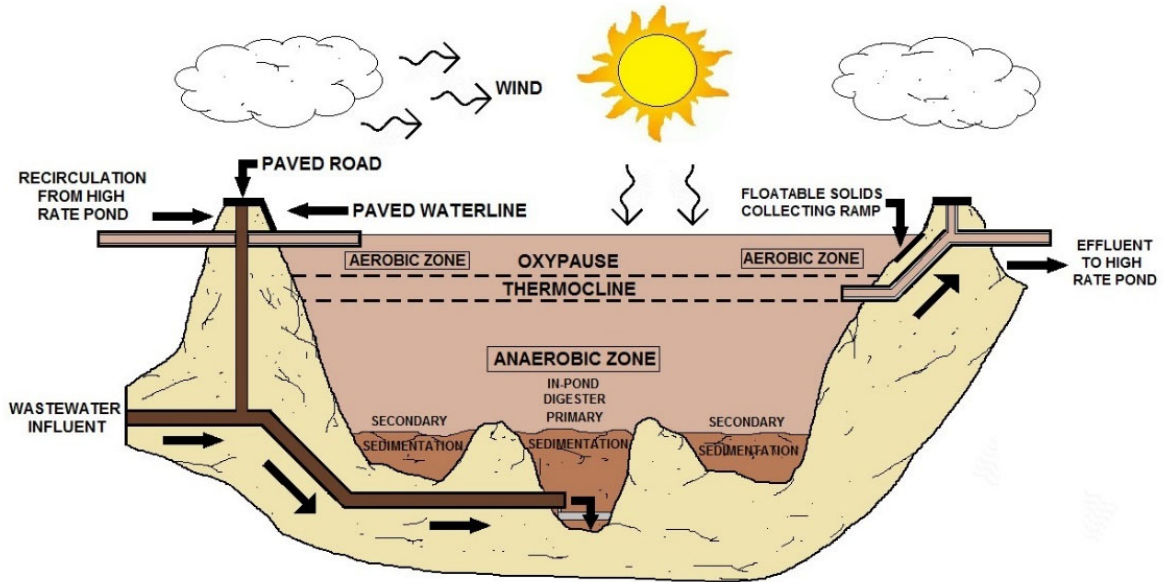

FACULTATIVE LAGOON #2

Respiration in ponds and lagoons recycles organic carbon arising from photosynthesis back to inorganic carbon. Prior to this transformation, the organic carbon is potentially available to support secondary production. Ponds rarely are part of the A/S system, but can be a back-up for overflow conditions.

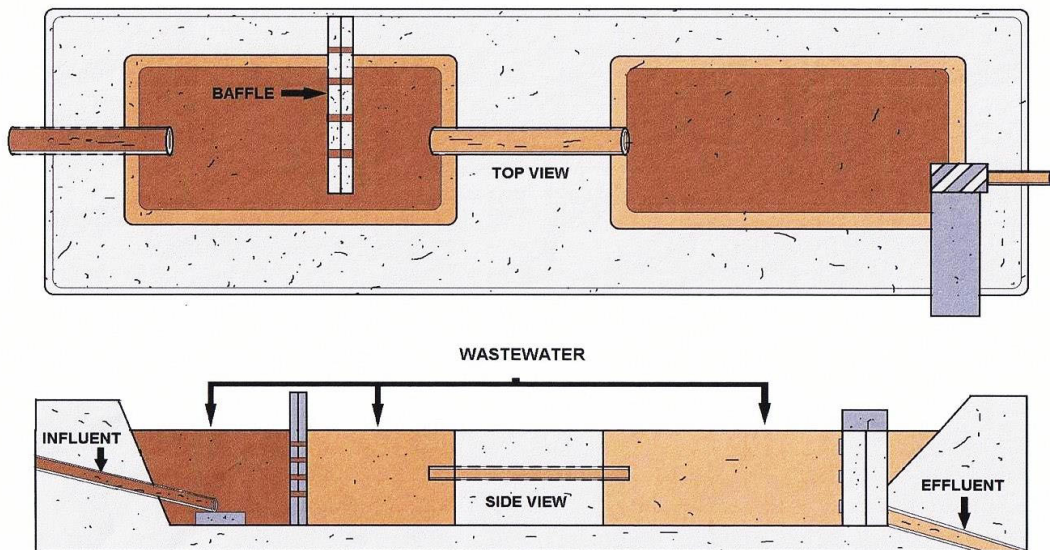

THREE CELL LAGOON WASTEWATER TREATMENT SYSTEM

Lagoon systems consist of aerated cells, followed by a non-aerated polishing cell and a final chlorine contact chamber. Often flowed by a non-aerated cell for sludge settling.

Aeration

Aeration is a long, but effective process that entails mixing wastewater with air to enhance the growth of aerobic microorganisms. Ponds may be continuously aerated for up to 30 hours at a time to ensure results.

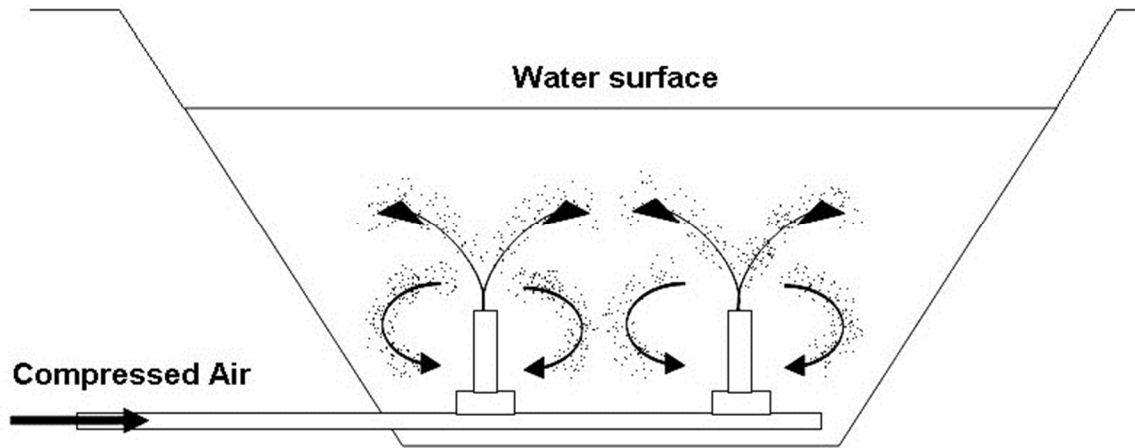

Arrows indicate flow of mixed and aerated water.

Oxidation Ponds

Oxidation ponds are typically used in warmer locations. In addition, this method utilizes natural bodies of water like lagoons. Wastewater is allowed to pass through this body for a period of time and is then retained for two to three weeks.

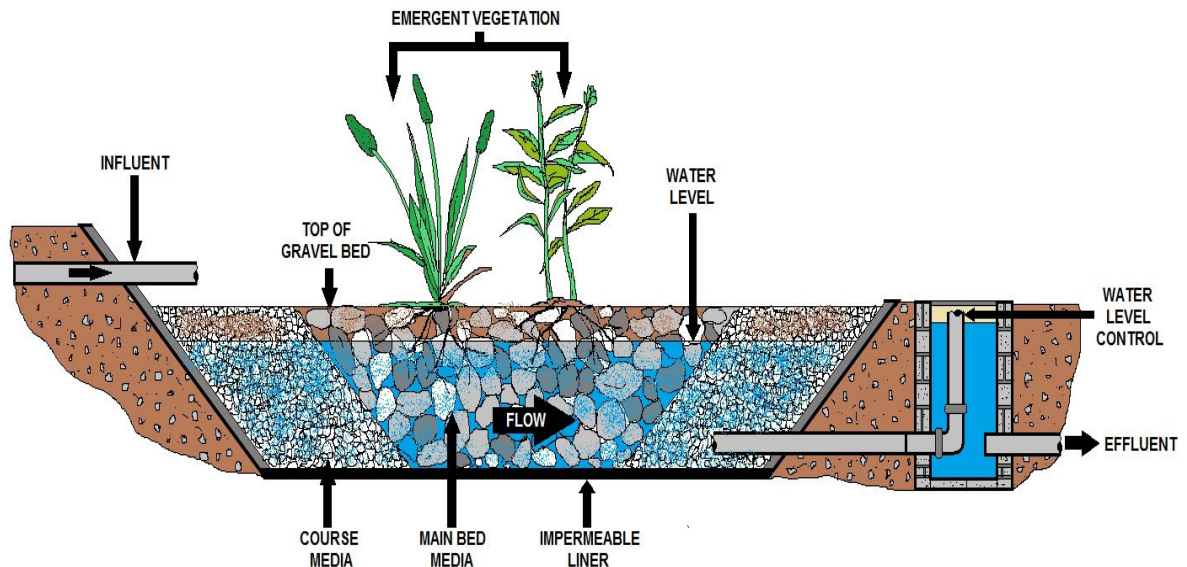

VEGETATIVE SUBMERGED BED (VSB)

Pond Components

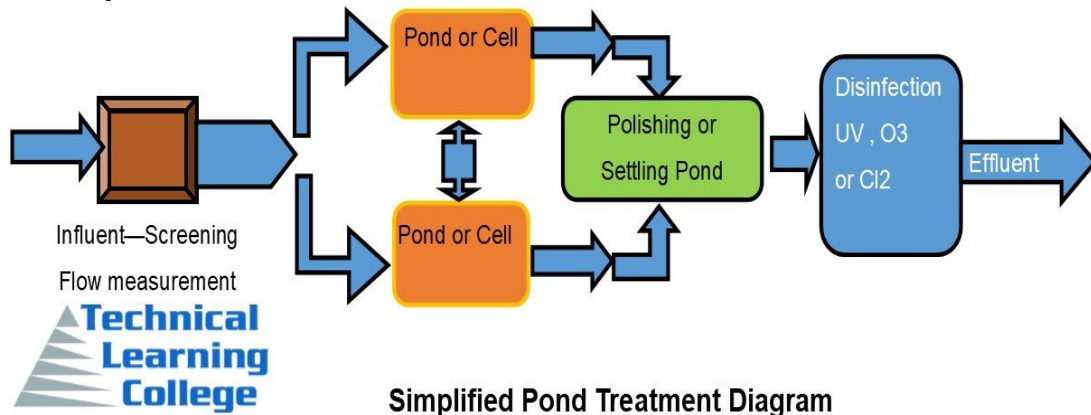

Raw Water Screening

Raw wastewater may or may not be screened and de-gritted before being directed into the pond treatment system. Ponds in many pond systems may be operated in *series* or in *parallel*.

Microorganisms in the first set of ponds treat the incoming effluent. If the previous ponds are aerated and mixed the following ponds may be for settling or polishing. This pond provides a quiet zone where the biological solids generated in the first two ponds can settle.

Ponds generally do not have a secondary clarifier; the settling or polishing pond fulfills the clarifier purpose.

Series or Parallel Pond Systems

Modern pond treatment typically consists of three or more separate ponds or cells that are interconnected with piping and valves so that any one pond can be taken out of service for cleaning and maintenance while the other remain in service. During normal operating conditions, all ponds will be in service.

Pond Lining

Ponds may be lined with a synthetic liner or simply have compacted clay bottoms and sides. Ponds may be equipped with baffle curtains to prevent short-circuiting and floating aerators and even solar power with special sensors including solar power to add oxygen. Many ponds rely only on wind and algae to supply oxygen instead of mechanical aeration.

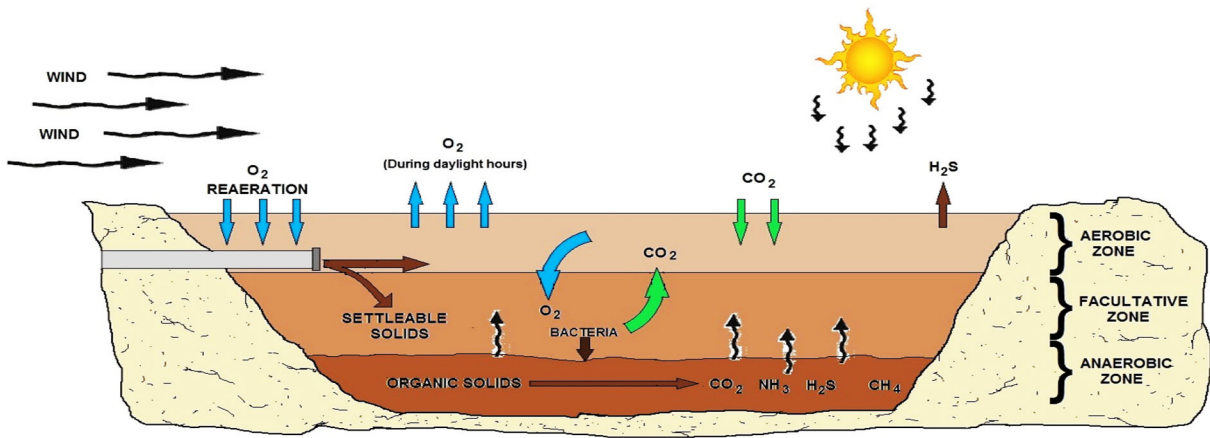

FACULTATIVE LAGOON DIAGRAM

Lagoon Systems

Lagoon systems are shallow basins that hold the wastewater for several months to allow for the natural degradation of sewage. These systems take advantage of natural aeration and microorganisms in the wastewater to renovate sewage.



Lagoons in series. Some will argue that lagoons are not part an A/S process, but according the EPA, if you maintain suspended bugs for a process, it an A/S process.

Lagoon Microorganisms

If you feed bugs or maintain bugs to degrade waste, this can be considered a type of A/S. Before we look at the bugs themselves, let us look at the bugs' eating habits. Have you ever met a person who was a picky eater?

Some people will put their noses up at some foods and others will seemingly eat anything. Predators typically eat from a narrow set of prey, while omnivores and scavengers eat from a broader food selection. Here are some of the types of helpful wastewater organisms:

- Swimming and gliding ciliates engulf bacteria or other prey.
- Stalked ciliates attach to the biomass and vortex suspended bacteria into their gullets, while crawlers break bacteria loose from the floc surface.
- Predators feed mostly on stalked and swimming ciliates. The omnivores, such as most rotifers, eat whatever is readily available, while the worms feed on the floc or prey on larger organisms.

Microorganisms are directly affected by their treatment environment. Changes in food, dissolved oxygen, temperature, pH, total dissolved solids, sludge age, presence of toxins, and other factors create a dynamic environment for the treatment organisms.

Food (organic loading) regulates microorganism numbers, diversity, and species when other factors are not limiting. The relative abundance and occurrence of organisms at different loadings can reveal why some organisms are present in large numbers while others are absent.

The aerobic bacteria in ponds are similar to those found in other treatment processes such as in activated sludge. Three functional groups occur: freely dispersed, single bacteria; floc-forming bacteria; and filamentous bacteria. All function to oxidize organic carbon (BOD) to produce CO₂ and new bacteria (new sludge).

Some bacterial species that degrade wastes grow as single bacteria dispersed in the wastewater. Although these readily oxidize BOD, they do not settle and can leave the system in the effluent as solids (TSS). These tend to grow in lagoons at high organic loading and low oxygen conditions.



More important are the floc-forming bacteria, those that grow in a large aggregate (floc) due to exocellular polymer production (the glycocalyx). This growth form is important as these flocs degrade BOD and settle at the end of the process, producing a low TSS effluent. Their floc can also help entrain the single bacteria.

A number of filamentous bacteria occur in lagoons, usually at specific growth environments. These generally do not cause any operational problems in lagoons, in contrast to activated sludge where filamentous bulking and poor sludge settling is a common problem. Most heterotrophic bacteria have a wide range of environmental tolerance and can function effectively for BOD removal over a wide range in pH and temperature.

Aerobic BOD removal generally proceeds well from pH 6.5 to 9.0 and at temperatures from 3-4°C to 35°C (37.4 -39.2° F to 95°F. In the Autothermal Thermophilic Aerobic Digestion (ATAD) process (mesophilic bacteria are replaced by thermophilic bacteria at temperatures above 35°C up to about 70°C (158°F).

BOD removal generally declines rapidly below 3-4°C and ceases at 1-2°C.

A very specialized group of bacteria occurs to some extent in lagoons (and other wastewater treatment systems) that can oxidize ammonia via nitrite to nitrate. These nitrifying bacteria are strict aerobes and require a redox potential of at least +200 m V (Holt et al., 1994).

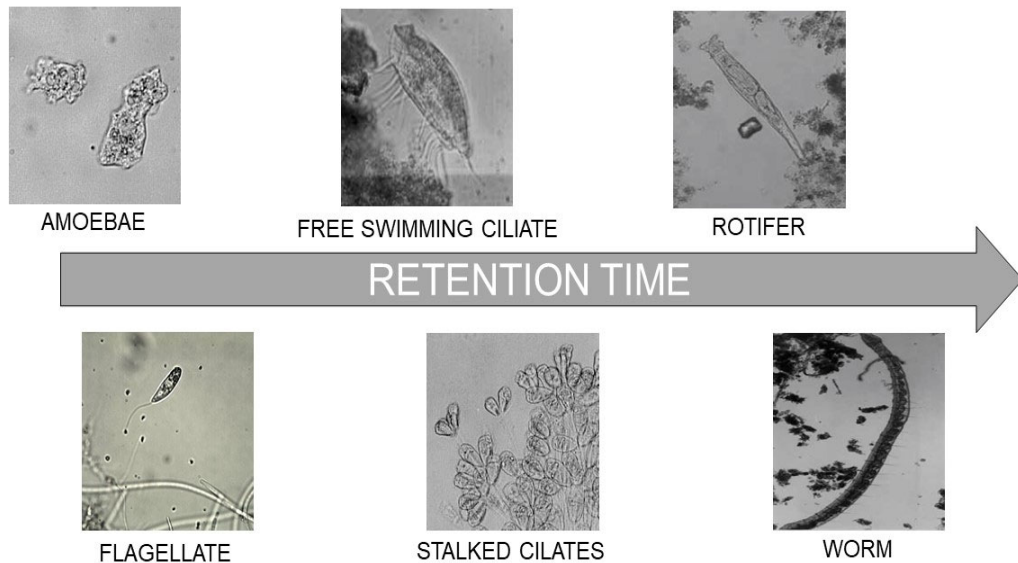

POND & A/S TREATMENT INDICATOR MICROORGANISMS

Mixed or Suspended Lagoons

Aerated lagoons are basins, normally excavated in earth and operated without solids recycling into the system. This is the major difference with respect to activated sludge systems.

Two types are the most common: the completely mixed lagoon (also called completely suspended) in which the concentration of solids and dissolved oxygen are maintained fairly uniform and neither the incoming solids nor the biomass of microorganisms settle, and the facultative (aerobic-anaerobic or partially suspended) lagoons. In the facultative lagoons. Mixing is reduced, causing accumulation of solids in the bottom that undergo anaerobic decomposition, while the upper portions are maintained aerobic. The main operational difference between these lagoons is the power input, which is in the order of 2.5-6 Watts per cubic meter (W/m^3) for aerobic lagoons while the requirements for facultative lagoons are of 0.8-1 W/m^3 .

Being open to the atmosphere, the lagoons are exposed to low temperatures which can cause reduced biological activity and eventually the formation of ice. This can be partially alleviated by increasing the depth of the basin. Mixed lagoons require a secondary sedimentation unit, which in some cases can be a pond basin excavated in earth, or conventional settling tanks can be used.

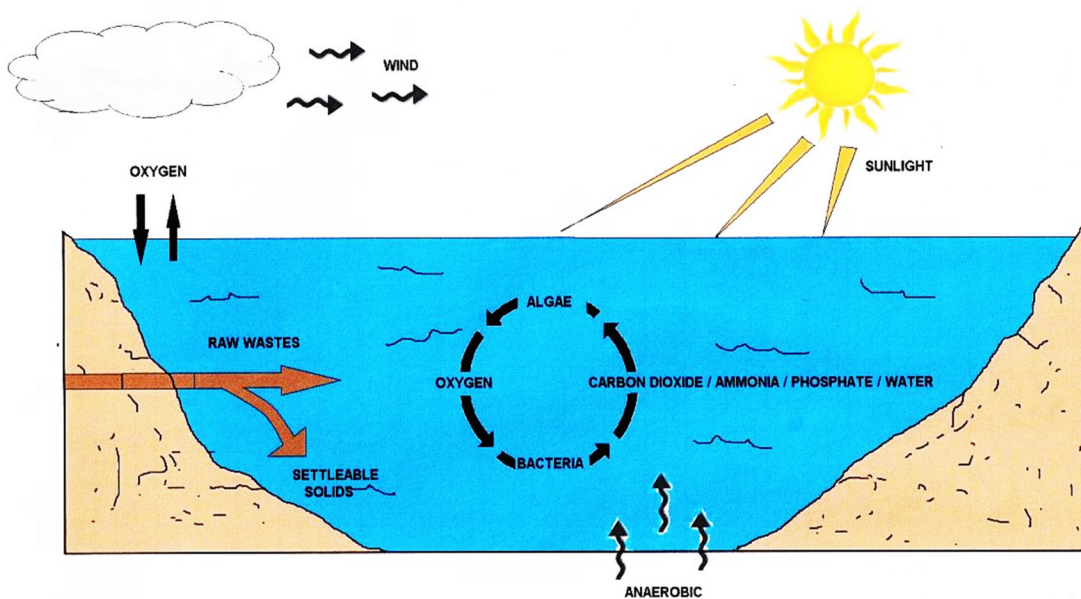

Diagram of facultative aerated lagoon.

If excavated basins are used for settling, care should be taken to provide a residence time long enough for the solids to settle, and there should be provision for periodically removing the accumulation of sludge.

Disadvantages of settling ponds include a very high possibility of offensive odor development due to the decomposition of the settled sludge, and algae might develop in the upper layers contributing to an increased content of suspended solids in the effluent.

Odors can be minimized by using minimum depths of up to 6 feet (2m), while algae production is reduced with a liquid retention time of less than two days. The solids will also accumulate, all along the aeration basins in the facultative lagoons and even in comers, or between aeration units in the completely mixed lagoon.

These accumulated solids will, on the whole, decompose in the bottom, but since there is always a non-biodegradable fraction, a permanent deposit will build up. Therefore, periodic removal of these accumulated solids becomes necessary. We will cover this in much more detail in a few more pages.

SUBMERGED DIFFUSED AERATION LAGOON

Submerged diffused air is essentially a form of a diffuser grid inside a lagoon. There are two main types of submerged diffused aeration systems for lagoon applications: floating lateral and submerged lateral. Both these systems utilize fine or medium bubble diffusers to provide aeration and mixing to the process water. The diffusers can be suspended slightly above the lagoon floor or may rest on the bottom. A flexible airline or weighted air hose supplies air to the diffuser unit from the air lateral (either floating or submerged).

SUSPENSION MIXED LAGOON

Suspension mixed lagoons are flow-through activated sludge systems where the effluent has the same composition as the mixed liquor in the lagoon. Typically, the sludge will have a residence time or sludge age of 1 to 5 days. This means that the chemical oxygen demand (COD) removed is relatively little and the effluent is therefore unacceptable for discharge into receiving waters. The primary objective of the lagoon is therefore to act as a biologically assisted flocculator which converts the soluble biodegradable organics in the influent to a biomass which is able to settle as a sludge. In any lagoon with mixing, an additional cell must follow it to allow for clarification of the water before discharge.

Algae Introduction

Algae are aerobic organisms that are photosynthetic and grow with simple inorganic compounds CO_2 , NH_3 , NO_3 , and PO_4 using light as an energy source. (**Note that algae produce oxygen during the daylight hours and consume oxygen at night.)

Algae are desirable in lagoons as they generate oxygen needed by bacteria for waste stabilization. Three major groups occur in lagoons, based on their chlorophyll type: brown algae (diatoms), green algae, and red algae.

The predominant algal species at any given time is dependent on growth conditions, particularly temperature, organic loading, oxygen status, nutrient availability, and predation pressures.

A fourth type of algae common in lagoons is the cyano-bacteria, or blue-green bacteria. These organisms grow much as the true algae, with the exception that most species can fix atmospheric nitrogen. Blue-green bacteria often bloom in lagoons and some species produce odorous and toxic by-products.

Blue-Green Bacteria

Blue-green bacteria may be favored by poor growth conditions including high temperature, low light, low nutrient availability (many fix nitrogen) and high predation pressure. Common blue-green bacteria in waste treatment systems include *Aphanothece*, *Microcystis*, *Oscillatoria* and *Anabaena*.

Algae can bloom in lagoons at any time of the year (even under the ice); however, a succession of algae types occurs over the season. There is also a shift in the algal species present in a lagoon through the season, caused by temperature and rotifer and *Daphnia* predation.

Diatoms usually predominate in the wintertime at temperatures $<60^\circ\text{F}$. In the early spring, when predation is low and lagoon temperatures increase above 60°F , green algae such as *Chlorella*, *Chlamydomonas*, and *Euglena* often predominate in waste treatment lagoons.

The predominant green algae change to species with spikes or horns such as *Scenedesmus*, *Micractinium*, and *Ankistrodesmus* later in the season when Rotifers and *Daphnia* are active (these species survive predation better).

Most algae grow best in warmer temperatures, longer detention time, and when inorganic minerals needed for growth are in excess.

Alkalinity (inorganic carbon) is the only nutrient likely to be limiting for algal growth in lagoons.

Substantial sludge accumulation in a lagoon may become soluble upon warming in the spring, releasing nutrients and causing an algal bloom. Sludge release of nutrients is a major cause of high algal growth in a lagoon, requiring sludge removal from the lagoon for correction.

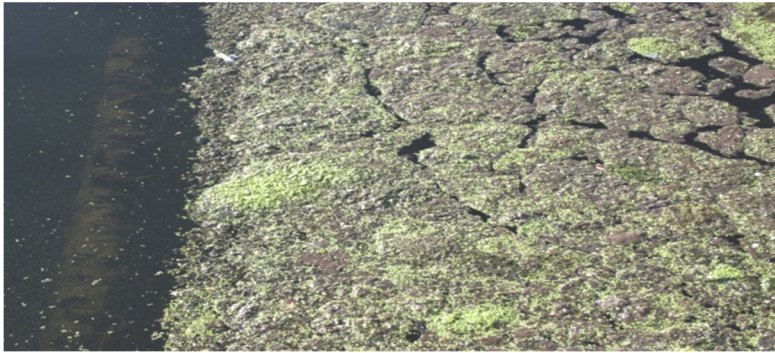

Algae on the secondary clarifier; not a healthy sign.

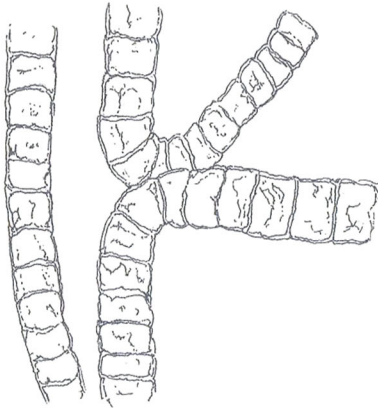

BLUE-GREEN ALGAE

ITS CELLS LACK NUCLEI AND ITS PIGMENT IS SCATTERED.
BLUE-GREEN ALGAE ARE ACTUALLY NOT ALGAE, BUT BACTERIA

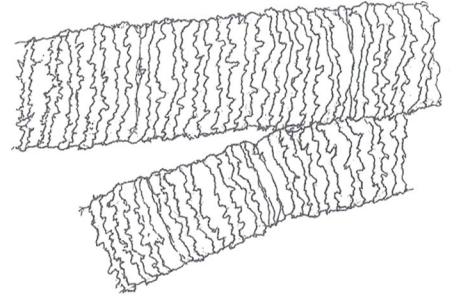

GREEN ALGAE

THEIR CELLS HAVE NUCLEI AND PIGMENT IS DISTINCT.
THEY ARE MOST COMMON ALGAE IN PONDS AND CAN BE MULTICELLULAR

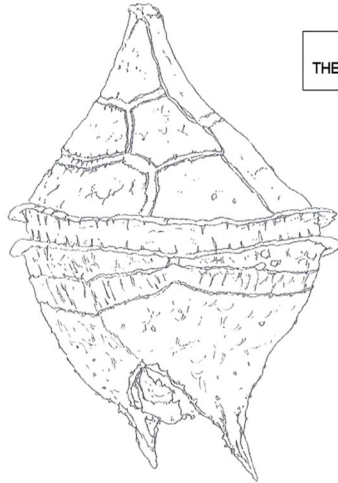

DINOFLAGELLATES

THEY HAVE FLAGELLA AND CAN SWIM IN OPEN WATERS
THEY ARE MICROSCOPIC AND SINGLE-CELLED

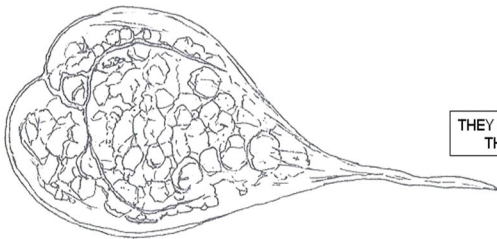

EUGLENOIDS

THEY ARE GREEN OR BROWN AND SWIM WITH THEIR FLAGELLUM.
EASY TO SPOT BECAUSE OF THEIR RED EYE. THEY ARE MICROSCOPIC AND SINGLE CELLED

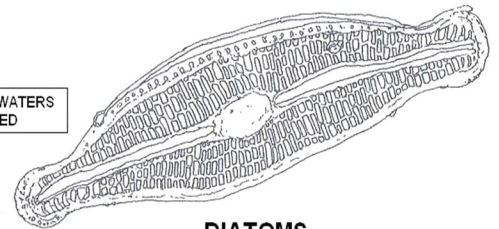

DIATOMS

THEY LOOK LIKE TWO SHELLS THAT FIT TOGETHER.
THEY ARE MICROSCOPIC AND SINGLE CELLED

Treatment Lagoon - pH and Alkalinity

The pH at a treatment lagoon is determined by the various chemical species of alkalinity that are present. The main species present are carbon dioxide (CO_2), bicarbonate ion (HCO_3^-), and carbonate ion (CO_3^{2-}). Alkalinity and pH can affect which species will be present. High amounts of CO_2 yield a low lagoon pH, while high amounts of CO_3^{2-} yield a high lagoon pH.

Bacterial respiration releases CO_2 which subsequently dissolves in water to yield carbonic acid (H_2CO_3). This rapidly dissociates to bicarbonate ion, increasing the lagoon alkalinity. Bacterial oxidation of BOD thus causes a decrease in lagoon pH due to CO_2 release. Algal growth in lagoons has the opposite effect on lagoon pH, raising the pH due to algal use for growth of inorganic carbon (CO_2 and HCO_3^-). Algal growth reduces the lagoon alkalinity which may cause the pH to increase if the lagoon alkalinity (pH buffer capacity) is low.

Algae can grow to such an extent in lagoons (a bloom) that they consume all of the CO_2 and HCO_3^- present for photosynthesis, leaving only carbonate (CO_3^{2-}) as the pH buffering species. This causes the pH of the lagoon to become alkaline. pH values of 9.5 or greater are common in lagoons during algal blooms, which can lead to lagoon effluent pH violations (in most states this is $\text{pH} \geq 9$). It should be noted that an increase in the lagoon pH caused by algal growth can be beneficial. Natural disinfection of pathogens is enhanced at higher pH.

Phosphorus removal by natural chemical precipitation is greatly enhanced at pH values greater than $\text{pH} = 8.5$. In addition, ammonia stripping to the atmosphere is enhanced at higher pH values (NH_3 is strippable, not NH_4^+).

Protozoans and Microinvertebrates Life

Many higher life forms (animals) develop in lagoons. These include protozoans and microinvertebrates such as rotifers, daphnia, annelids, chironomids (midge larvae), and mosquito larvae. These organisms are often termed zooplankton, and play a role in waste purification by feeding on bacteria and algae and promoting flocculation and settling of particulate material.

Protozoans are the most common higher life forms in lagoons, with about 250 species identified in lagoons to date (Curds, 1992). Rotifers and daphnia are particularly important in controlling algal overgrowth and these often "bloom" when algal concentrations are high. These microinvertebrates are relatively slow growing and generally only occur in systems with a detention time of >10 days.

Mosquitoes grow in wastewater lagoons where shoreline vegetation is not removed, possibly causing a nuisance and public health problem. *Culex tarsalis*, mosquito, the vector of Western Equine Encephalitis in the western U.S., grows well in wastewater lagoons (USEPA, 1983). The requirement for a minimum lagoon bank slope and removal of shoreline vegetation by most regulatory agencies is based on the public health need to reduce mosquito vectors.



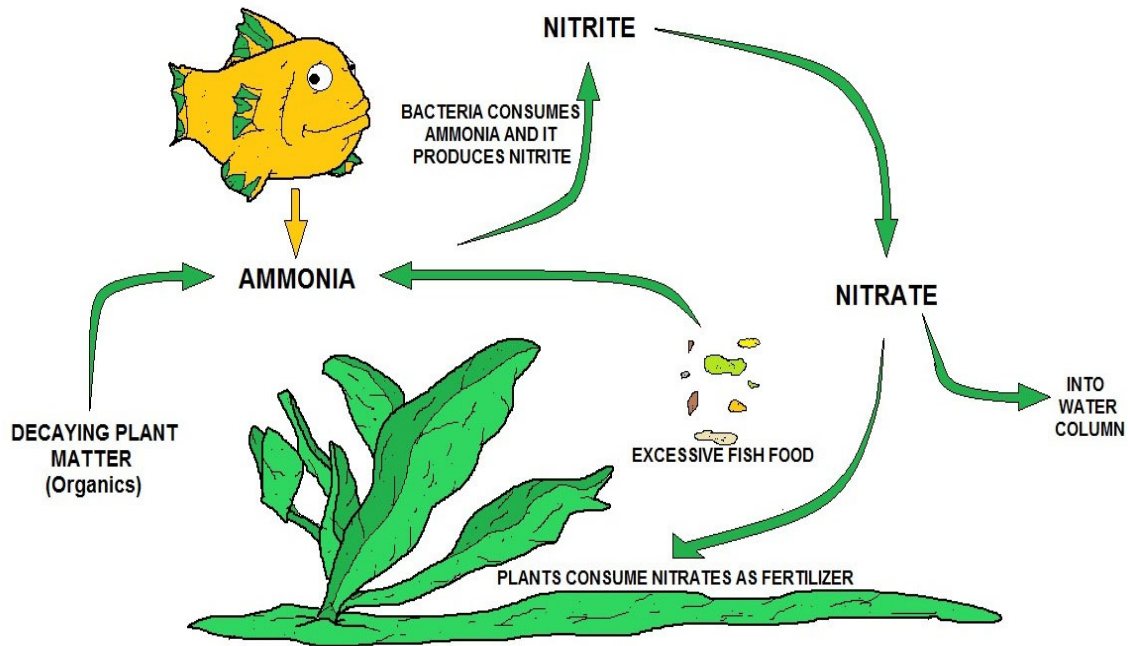

NITROGEN CYCLE IN NATURAL (NON-WWT) PONDS

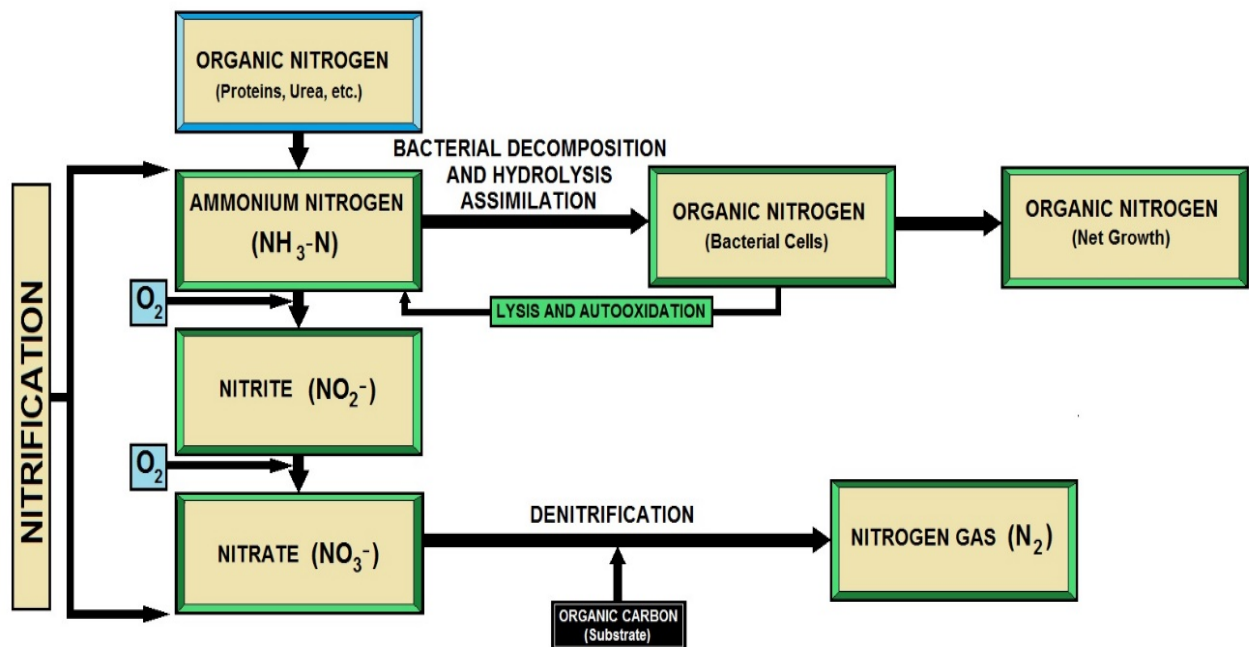

Suspended Film Systems- Sub-Section

Suspended film systems stir and suspend microorganisms in wastewater. As the microorganisms absorb organic matter and nutrients from the wastewater, they grow in size and number. Trickling filters and RBCs are fixed-film processes.

After the microorganisms have been suspended in the wastewater for several hours, they are settled out as sludge. Some of the sludge is pumped back into the incoming wastewater to provide "seed" microorganisms. The remainder is wasted and sent on to a sludge treatment process.

Activated sludge, extended aeration, oxidation ditch, and sequential batch reactor systems are all examples of suspended growth or film systems.

These processes use the same microorganisms as pond systems and activated sludge to treat wastewater, but the microorganisms grow attached to a surface. Fixed-film processes are also referred to as *attached growth processes*.

Fixed Film Systems

Fixed film systems grow microorganisms on substrates such as rocks, sand or plastic. The wastewater is spread over the substrate, allowing the wastewater to flow past the film of microorganisms fixed to the substrate.

As organic matter and nutrients are absorbed from the wastewater, the film of microorganisms grows and thickens. Trickling filters, rotating biological contactors, and sand filters are examples of fixed film systems.

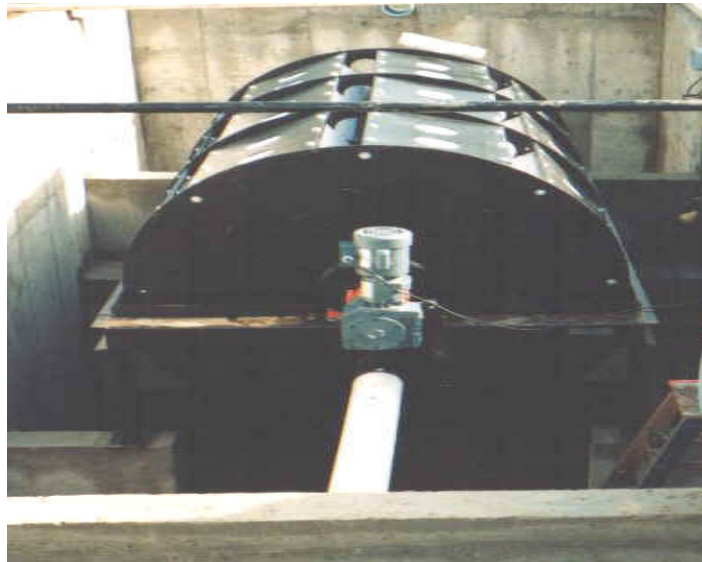

Empty RBC

Biofilm

Support media provides a surface for the microorganisms to attach and grow. These microorganisms gradually form a slime layer called a *biofilm*. A thin layer of wastewater flowing over the biofilm either intermittently or continuously wets the surface of the biofilm and brings food and nutrients to the microorganisms and carries away any waste products.

Excess or dead biomass, which *sloughs* off the media surface is carried away by the wastewater flowing over the biofilm and through the *void spaces* of the support media. Sloughed biomass is removed from the trickling filter or RBC effluent by gravity settling in a clarifier.

Soluble Organic Matter

The microorganisms that grow in biofilms convert soluble organic matter into biomass solids. Both trickling filters and RBCs can remove carbonaceous matter measured as biochemical oxygen demand (BOD) as well as ammonia, nitrite and nitrate. These biofilms typically do not remove phosphorus beyond *assimilative uptake*.

Biofiltration

This method of secondary treatment of wastewater employs sand filters, contact filters, or trickling filters to ensure that additional sediment is removed from wastewater. Of the three filters, trickling filters are typically the most effective for small-batch wastewater treatment.

Bioaccumulation

Bioaccumulation is a gradual increase of a pollutant within an organism. The pollutant is taken up faster than it can be processed and eliminated. Bioaugmentation can concentrate pollutants further through the food chain.

Rotating Biological Contactor (RBC) Sub-Section

The **rotating biological contactor** (RBC) is a fixed film biological secondary treatment device. The basic process is similar to that occurring in the trickling filter. In an RBC, the media, consisting of a series of circular disks mounted side by side on a common shaft, is rotated through the wastewater flow.

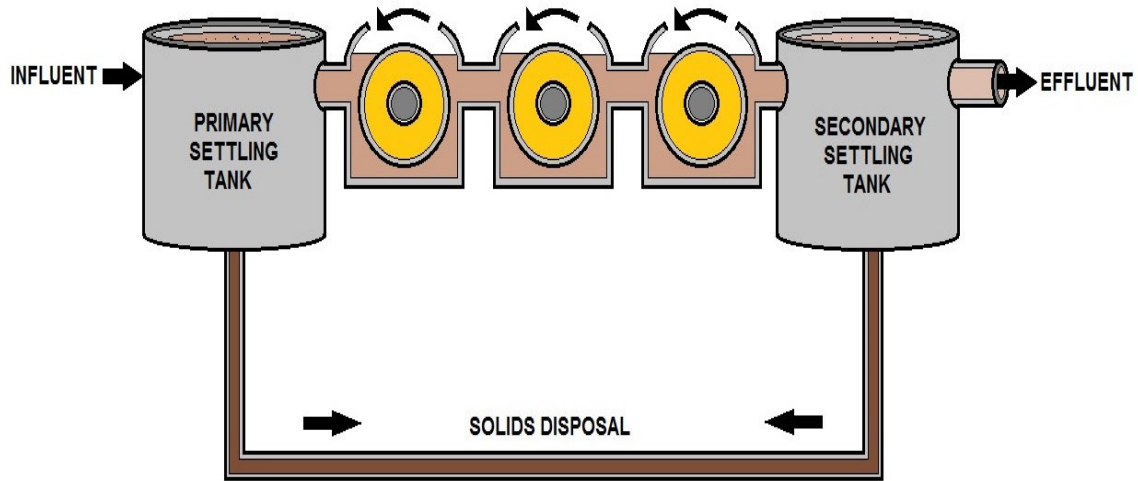

ROTATING BIOLOGICAL CONTACTORS

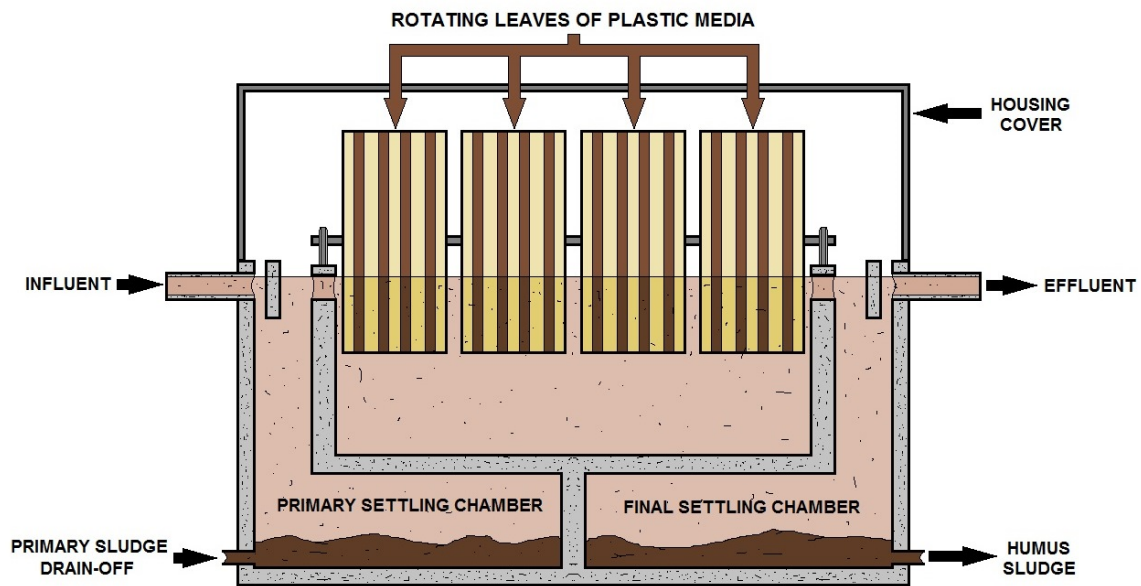

RBC- INTEGRAL TYPE

RBC's with integral units treat unsettled sewage and has the capability of providing primary and secondary settling in the unit.

Rotating biological contactors is a remediation technology used in the secondary treatment of wastewater. This technology involves allowing wastewater to come in contact with an attached biological medium in order to facilitate the removal of contaminants.

In its simplest form, a rotating biological contactor consists of a series of discs or media blocks mounted on a shaft which is driven, so the media rotates at right angles to the flow of sewage. The discs or media blocks are normally made of plastic (polythene, PVC, expanded polystyrene) and are contained in a trough or tank so that about 40% of their area is immersed.



The biological growth that becomes attached to the media assimilates the organic materials in the wastewater. Aeration is provided by the rotating action, which exposes the media to the air after contacting them with the wastewater. The degree of wastewater treatment is related to the amount of media surface area and the quality and volume of the inflowing wastewater.

Rotating biological contactors can be supplied as part of an integral package plant to treat sewage from various communities. Integral units are provided in sizes of up to a 500-population equivalent. A smaller version is also available for small private installations.

Each plant is designed to meet the specific requirements of the site and the effluent quality required.

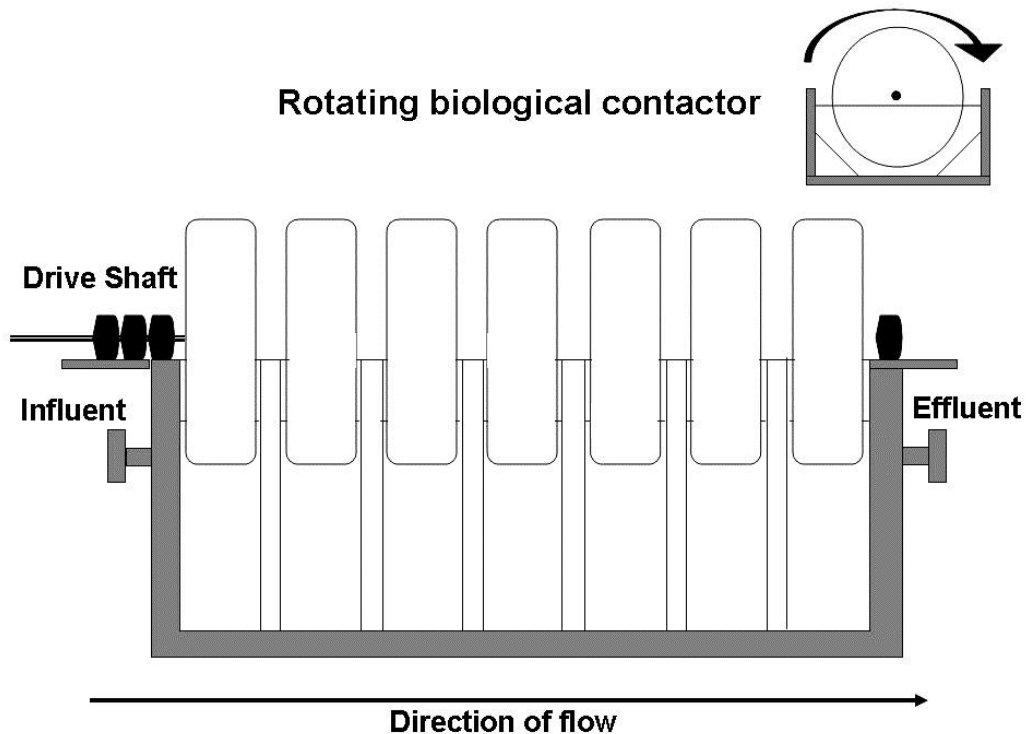

Advantages

- ✓ Short contact periods are required because of the large active surface.
- ✓ Capable of handling a wide range of flows.
- ✓ Sloughed biomass generally has good settling characteristics and can easily be separated from the waste stream.
- ✓ Operating costs are low, as little skill is required in plant operation.
- ✓ Retention times are short.
- ✓ Low power requirements.
- ✓ Low sludge production and excellent process control.

Problems

White biomass over most of a RBC disc, which can be usually resolved by increasing the age of the sludge.

RBC Principles

The principles of the rotating biological contactor originated in the early 1900's but its application to sewage treatment did not occur until the 1960's when the present system was developed. The process employed relies on the well-established principle of biological oxidation using naturally occurring organisms.

Primary Settlement Zone

Incoming flows of raw sewage enter the RBC primary settlement zone, which is designed to have a buffering capacity of balancing flows. Settled solids are retained in the tank's lower region while the partially clarified liquor passes forward to the biozone where it makes contact with the slowly rotating disks.

Installation of Rotating Biological Contactors

Rotating biological contactors are available in sizes from 45 inches (1100mm) diameter up to 150 inches (3800mm) in diameter. The media packs that form the rotors are manufactured from vacuum formed black polyethylene sheets supported on the central shaft with a galvanized steel framework. The central shaft is manufactured from mild steel tube, protected internally against corrosion and fitted with end stub shafts, which are supported on split bearings.



Gearbox and Drive mechanism

Rotation is provided by a shaft mounted gearbox and motor fitted at one end.

Biozone

The rotor assembly is suspended within the biozone with 40% of the diameter submerged in the liquor at any one time. The disks slowly rotate and the continuous alternate exposure to air and sewage results in a growth of organisms known as biomass which adheres to the disks.

These organisms occur naturally in the sewage and carry out the purification process by feeding off the impurities present in the sewage. As they have a short life cycle, these organisms are continually shearing off the rotating disks and pass from the biozone to the final zone.

The biozone is fitted with a series of baffles between each bank of media to prevent short circuiting and to ensure maximum performance.



RBCs at Culbokie, Scotland Water.

Final Settlement Zone

The biomass passes from the biozone into the final settlement zone where it settles to form humus sludge. This is then regularly pumped out using either an airlift system or submersible pumps and returned to the primary zone.

The clarified liquid decants from the top of the tank as effluent that can be discharged, further clarification, and/or disinfection.

Trickling Filter Description (From EPA Fact Sheet 832-F-00-014)

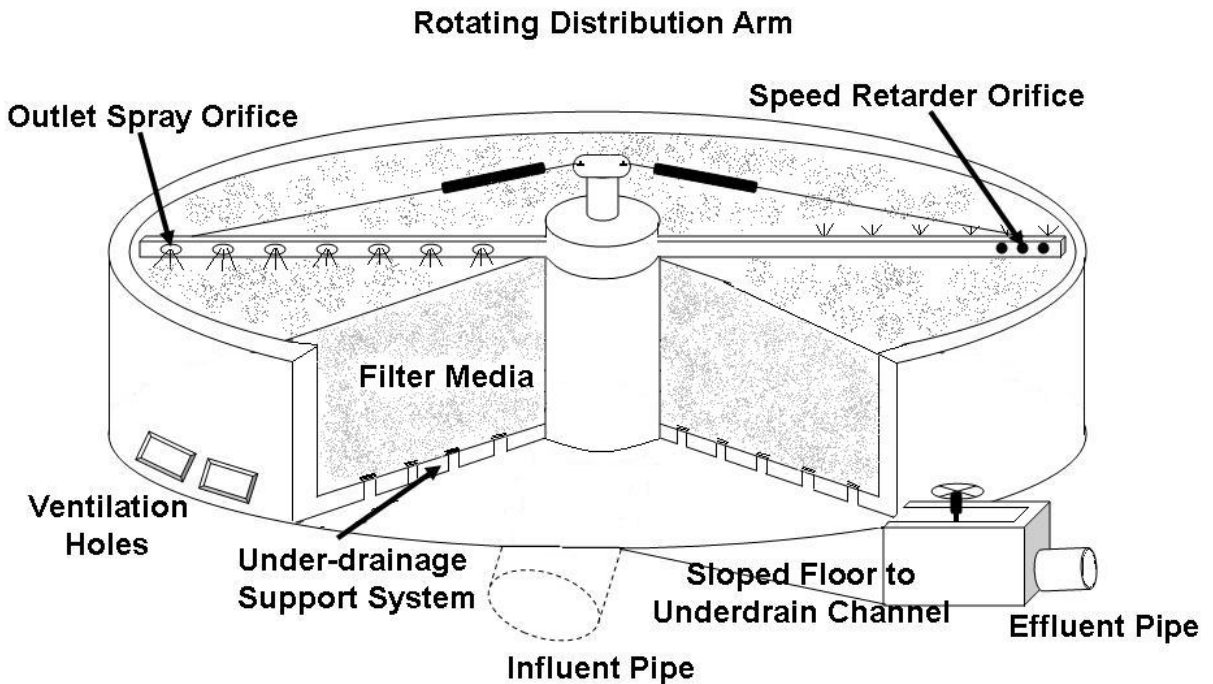

TRICKLING FILTER DIAGRAM #1

Trickling filters (TFs) are used to remove organic matter from wastewater. The TF is an aerobic treatment system that utilizes microorganisms attached to a medium to remove organic matter from wastewater. This type of system is common to a number of technologies such as rotating biological contactors and packed bed reactors (biotowers). These systems are known as attached-growth processes. In contrast, systems in which microorganisms are sustained in a liquid are known as suspended-growth processes.

TF Applicability

TFs enable organic material in the wastewater to be adsorbed by a population of microorganisms (aerobic, anaerobic, and facultative bacteria; fungi; algae; and protozoa) attached to the medium as a biological film or slime layer (approximately 0.1 to 0.2 mm thick).

As the wastewater flows over the medium, microorganisms already in the water gradually attach themselves to the rock, slag, or plastic surface and form a film. The organic material is then degraded by the aerobic microorganisms in the outer part of the slime layer.

As the layer thickens through microbial growth, oxygen cannot penetrate the medium face, and anaerobic organisms develop. As the biological film continues to grow, the microorganisms near the surface lose their ability to cling to the medium, and a portion of the slime layer falls off the filter. This process is known as sloughing. The sloughed solids are picked up by the underdrain system and transported to a clarifier for removal from the wastewater.

Design Criteria

A TF consists of permeable medium made of a bed of rock, slag, or plastic over which wastewater is distributed to trickle. Rock or slag beds can be up to 60.96 meters (200 feet) in diameter and 0.9-2.4 meters (3 to 8 feet) deep with rock size varying from 2.5-10.2 cm (1 to 4 inches). Most rock media provide approximately 149 m²/m³ (15 sq. ft/cu ft) of surface area and less than 40 percent void space.

The design of a TF system for wastewater also includes a distribution system. Rotary hydraulic distribution is usually standard for this process, but fixed nozzle distributors are also being used in square or rectangular reactors. Overall, fixed nozzle distributors are being limited to small facilities and package plants. Recently some distributors have been equipped with motorized units to control their speed. Distributors can be set up to be mechanically driven at all times or during stalled conditions.

Biotowers

Packed plastic filters (bio-towers), on the other hand, are smaller in diameter (6 to 12 meters (20 to 40 feet)) and range in depth from 4.3 to 12.2 meters (14 to 40 feet). These filters look more like towers, with the media in various configurations (e.g., vertical flow, cross flow, or various random packings). Research has shown that cross-flow media may offer better flow distribution than other media, especially at low organic loads.

Plastic Medium

When comparing vertical media with the 60-degree cross-flow media, the vertical media provide a nearly equal distribution of wastewater minimizing potential plugging at higher organic loads better than cross flow media. The plastic medium also required additional provisions, including ultraviolet protective additives on the top layer of the plastic medium filter, and increased plastic wall thickness for medium packs that are installed in the lower section of the filter where loads increase.

Underdrain System

In addition, a TF has an underdrain system that collects the filtrate and solids, and also serves as a source of air for the microorganisms on the filter. The treated wastewater and solids are piped to a settling tank where the solids are separated. Usually, part of the liquid from the settling chamber is recirculated to improve wetting and flushing of the filter medium, optimizing the process and increasing the removal rate.

It is essential that sufficient air be available for the successful operation of the TF. It has been found that to supply air to the system, natural draft and wind forces are usually sufficient if large enough ventilation ports are provided at the bottom of the filter and the medium has enough void area. The following four basic categories of filter design are based on the organic loading of the trickling filter.

Rock Medium

With a rock medium, the filters tend not to be hydraulically limited and have application limits ranging from 0.01 to 0.04 liters per square meter-second (0.02 to 0.06 gal/sq. ft/min).

The sloughed solids from a low-rate filter are generally well digested and as a result, these filters yield less solids than higher rate filters. Secondary quality effluent is readily achievable if the low-rate trickling filter design incorporates filter media with bioflocculation capabilities or good secondary clarification.

Low-Rate Filters

Low-rate filters are commonly used for loadings of less than 40 kilograms five day biochemical oxygen demand (BOD₅)/100 meters cubed per day (25 lb BOD₅/1000cu ft/day). These systems have fewer problems than other filters with regards to filter flies, odors, and medium plugging because of the lower loading rate. Low-rate filters with a rock medium range in depth from 0.9 to 2.4 meters (3-8 ft.). Most low-rate filters are circular with rotary distributors, but some filters currently in use are rectangular.

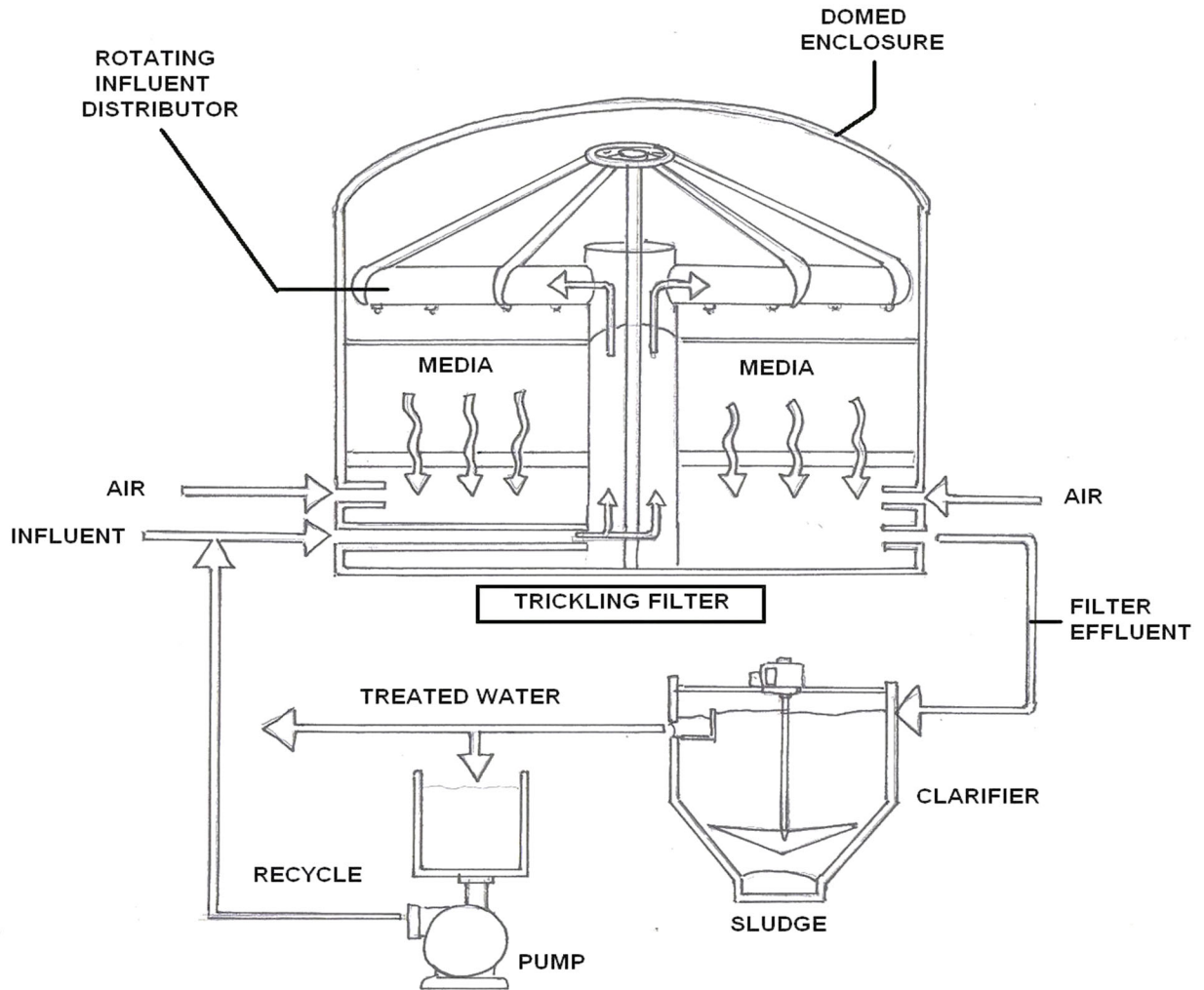

TRICKLING FILTER DIAGRAM #2

Trickling filters are equipped with dosing syphons or recirculation pumps to provide a continuous wetting rate for short intervals between rest periods. A minimum wetting rate of 0.4 liters per square meter-second (0.7 gal/sq. ft/min) is maintained to prevent the high rate plastic filter medium (biofilm) from drying out.

Intermediate-Rate Filters

Intermediate rate filters can be loaded up to 64 kg BOD₅/100 m³-d (40 lb BOD₅/1000cu ft/day). In order to ensure good distribution and thorough blending of the filter and secondary effluent, the system should recirculate the trickling filter effluent. The biological solids that slough from an intermediate trickling filter are not as well digested as those using a low-rate filter.

High-Rate Filters

High-rate filters are generally loaded at the maximum organic loading capabilities of the filter and receive total BOD₅ loading ranging from 64 to 160 kg BOD₅/100 m³-d (40 to 100 lb. BOD₅/1000cu ft/day). Achieving a secondary quality effluent is less likely for a high-rate filter without a second stage process. As a result, high-rate filters are often used with combined processes.

Roughing Filters

Roughing filters are designed to allow a significant amount of soluble BOD to bleed through the trickling filter. Filters of this type generally have a design load ranging from 160-480 kg BOD₅/100 m³-d (100 to 300 lb. BOD₅/1000cu ft/day).

Performance of TFs

Recent efforts have been made to combine fixed film reactors with suspended growth processes to efficiently remove organic materials from wastewater. For example, the combination of a trickling filter with an activated-sludge process has allowed for the elimination of shock loads to the more sensitive activated sludge while providing a highly polished effluent that could not be achieved by a trickling filter alone. Table 1 shows the BOD₅ removal rates for the four filter types discussed.

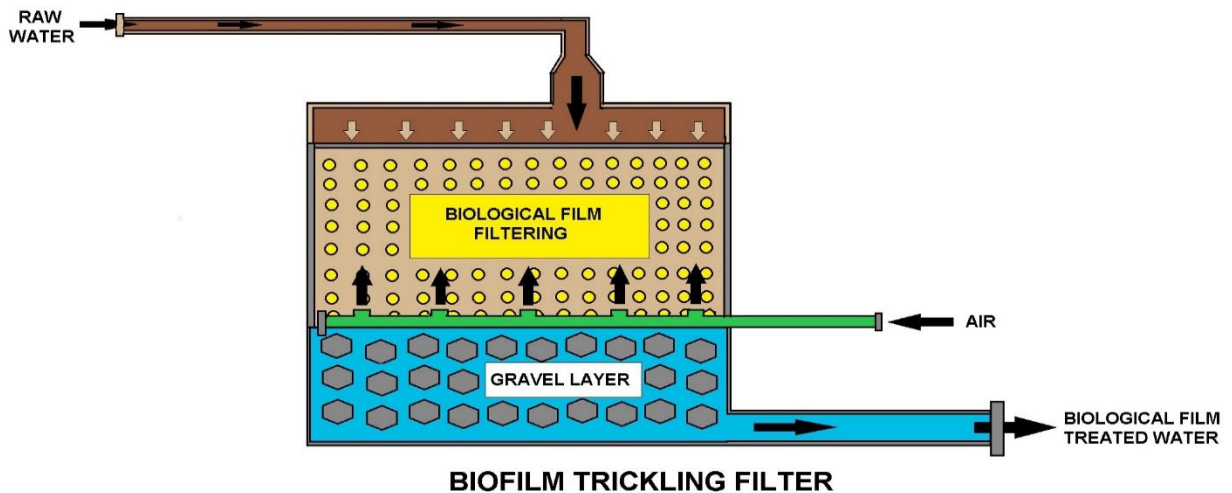

TABLE 1 BOD₅ Removal Rates for Various Filter Types

Filter Type	BOD ₅ Removal (%)
Low Rate	80 - 90
Intermediate Rate	50 - 70
High Rate	65 - 85
Roughing Filter	40 - 65

Source: *Environmental Engineers Handbook, 1997.*

Although the TF process is generally reliable, there is still potential for operational problems. Some of the common problems are attributed to increased growth of biofilm, improper design, changing wastewater characteristics, or equipment failure.

Operation and Maintenance

Disagreeable Odors from Filter

Potential Cause: Excessive organic load causing anaerobic decomposition in filter.

Remedy: Reduce loading; increase BOD removal in primary settling tanks; enhance aerobic conditions in treatment units by adding chemical oxidants, pre-aerating, recycling plant effluent, or increasing air to aerated grit chambers; scrub off gases; use plastic media instead of rock.

Potential Cause: Inadequate ventilation.

Remedy: Increase hydraulic loading to wash out excess biological growth; remove debris from filter effluent channels, underdrains, and the top of filter media; unclog vent pipes; reduce hydraulic loading if underdrains are flooded; install fans to induce draft through filter; check for filter plugging resulting from breakdown of the medium or the media support.

Ponding on Filter Media

Potential Cause: Excessive biological growth or foreign matter in or on the filter, broken media support.

Remedy: Remove debris. Reduce organic loading; increase hydraulic loading to increase sloughing; use high-pressure stream of water to flush filter surface; maintain 1 to 2 mg/L residual chlorine on the filter for several hours; flood filter for 24 hours; shut down filter to dry out media; replace media if necessary.



A TF consists of permeable medium made of a bed of rock (As seen above), slag, or plastic over which wastewater is distributed through the armature to trickle.



Fixed-film trickling filters. The left filter discoloration is due to sloughing. The photo below is the actual material off that filter.



Aeration Sub-Section

Oxygen Requirements

Oxygen requirements in suspended growth systems generally depend on BOD loading, degree of treatment, and level of suspended solids concentration to be maintained in the aeration tank mixed liquor. Aeration equipment is designed to supply sufficient oxygen to maintain a minimum dissolved oxygen concentration of 2 milligrams per liter (mg/l) at average design load and 1.0 mg/l at peak design loads throughout the mixed liquor. In the absence of experimentally determined values, the design oxygen requirements for all activated sludge processes is generally 1.1 lbs. oxygen per lb. peak BOD₅ applied to the aeration tanks. In the extended aeration process, the value is 2.35. Aeration equipment shall be of sufficient size and arrangement to maintain velocities greater than 0.5 foot per second at all points in the aeration tank.

The oxygen requirements for an activated sludge system can be estimated using the following relationship:

$$O_2 = (a) (BOD) + b (MLVSS)$$

O₂ = pounds of oxygen required per day

BOD₅ = pounds of BOD removed per day (5-day BOD)*

MLVSS = pounds of mixed liquor volatile suspended solids contained in the aeration basin

a= amount of oxygen required for BOD synthesis. "a" will range from 0.5 to 0.75 pound of oxygen per pound of BOD removed

b= amount of oxygen required for endogenous respiration or decay. "b" will range from 0.05 to 0.20 pound of oxygen per pound of MLVSS

*BOD removal shall be calculated as influent BOD₅ minus soluble effluent BOD₅.

For preliminary planning before process design is initiated, a rough estimate can be obtained by using 1.0 to 1.2 pounds of oxygen per pound of BOD removed (assuming no nitrification).

The supply of oxygen to the activated sludge basin represents the largest single energy consumer in an activated sludge facility (50 to 90%). Oxygen transfer devices are used to not only supply oxygen to the process, but also to mix the aerobic compartments of the basin. Typically, there are two types of aeration devices: diffused-aeration systems and mechanical-aeration systems.

There are several designs and applications for aerators:

- Diffused Aerators
- Mechanical Surface Aerators
- Submerged Turbine Aerators

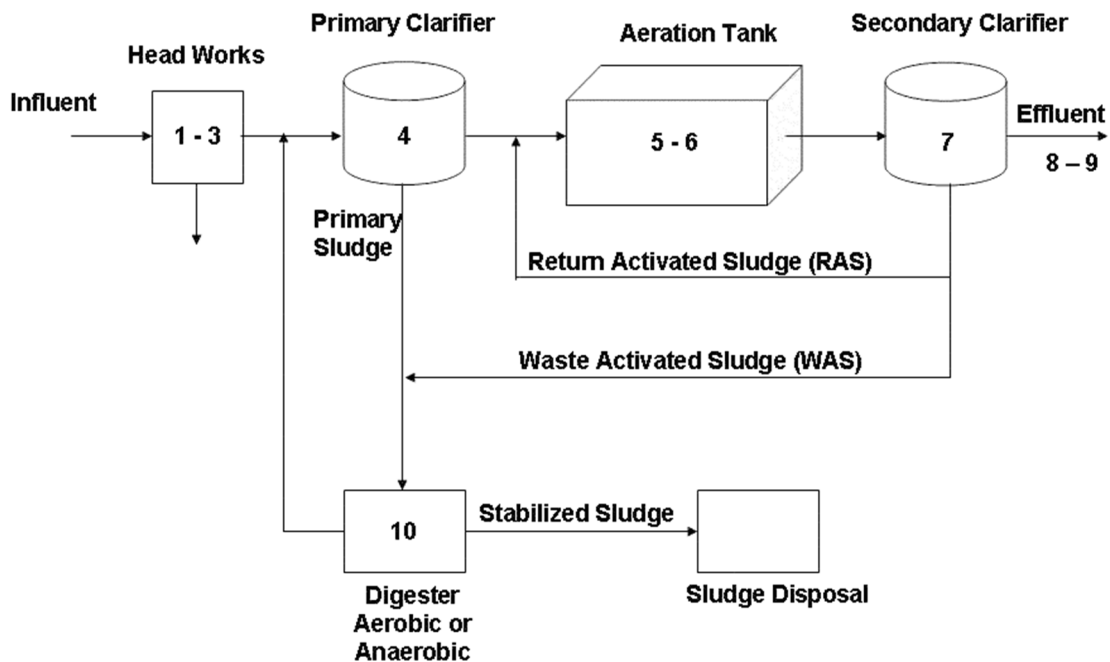

Air is necessary at process number 5-6.

FINE BUBBLE AERATION DIFFUSER

A device through which air is pumped and divided into very small bubbles that are used to introduce and dissolve oxygen into the liquid. Fine bubble diffusers are normally disks or tubes that use membranes or ceramic materials to create the bubbles and gentle mixing action. Fine bubble diffused aeration utilizes full floor coverage in order to be effective and energy efficient.

COARSE BUBBLE AERATION DIFFUSER

A device through which air is pumped and divided into large bubbles that are transferred and dissolved into the liquid. Coarse bubble diffusers normally discharge air at a high rate and are installed to induce a spiral or cross roll mixing pattern. Coarse bubble diffusers are typically installed where a non-clogging application is required.

The two most common types of aeration systems are subsurface diffusion and mechanical aeration. Both air systems have been around for many decades.

Originally, opened tubes or perforated pipes were used at the bottom of aeration tanks. But since then a more efficient process was desired. In the diffused air system, compressed air is introduced near the bottom of the tank. The definition for diffused aeration:

“the injection of a gas, air or oxygen, below a liquid surface.”

Diffused Aeration

Diffused action defined as the injection of it or air or oxygen below the water level. The air or oxygen is supplied by low-pressure blowers with pressures typically up to 210 kPa absolute (30 psia) or 105 kPa gauge (15 psig). Jet aerators, which combined gas injection with mechanical pumping or mixing, are also included in this category

Oxygen Supply

The aerated systems as described need an oxygen supply. Depending on the characteristics of the process, different designs may be used. The oxygen can be supplied to the activated sludge by either diffused aeration, by turbine agitation, by static aerators, or by surface coarse or large bubble diffusers. The last two are also used in lagoon systems.

Diffused aeration systems are also divided into fine bubble, medium and coarse or large bubble diffusers. Fine bubble diffusers are built of porous materials (grains of pure silica or aluminum oxide are bonded ceramically or by resins) which provide very small bubbles of high surface area that favor the oxygen transfer from the air to the wastewater.

Medium bubble diffusers are perforated pipes or tubes wrapped with plastic or woven fabric. The coarse or large bubble diffusers can be orifice devices of various types, some of which are designed to be non-clogging.

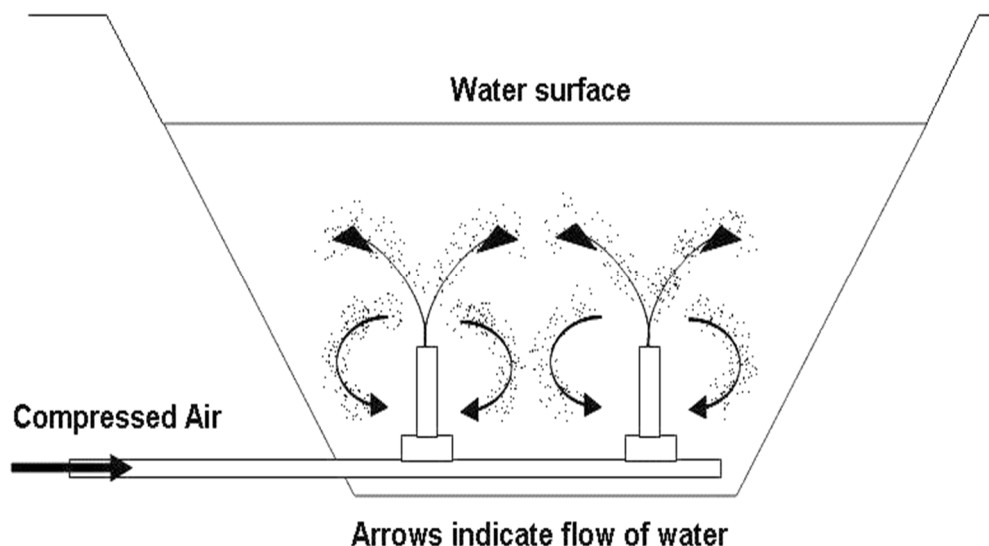

Coarse or Large Bubble Diffusers

With the small or fine bubble diffusers, it is important to use air free of particles that would otherwise clog them. Although somewhat less efficient for oxygen transfer, the coarse bubble diffusers are sometimes preferred because the presence of particles in the air is not a critical problem, and also for their lower cost and maintenance requirements. The diffusers are placed along air manifolds, close to the bottom of the aeration tanks.

Static Aerators

The static aerators are vertical tubes placed at the bottom of the aeration tank, with packing material along its length. The compressed air is supplied from the bottom of the tubes, forcing a mixture of air and water through the packing, where most of the oxygen transfer to the wastewater takes place. They have been used mainly in aerated lagoons.

Jet Aeration

Jet aeration systems combine aeration with mechanical pumping. These systems may be arranged with two headers running the full length of a basin, or have a central hub arrangement.

A blower is typically used to provide pressurized air to the upper header while MLSS is simultaneously pumped through the bottom header.

Submersible pumps are typically used, but some installations to external pumps in the case of circular system the airline enters at the top of the hub. Nozzle assemblies, also called *jets*, are spaced evenly along the liquid header.

Each jet assembly contains two nozzles nested one within the other. The air header is connected to the liquid header by air transfer ducts. As MLSS is pumped through the header and exits through the inner nozzle, it mixes with the incoming air in the outer nozzle. The intense mixing and high degree of turbulence help to produce air bubbles that are similar in size to those produced by fine-bubble aeration systems.



The above photo shows pipes and enclosed blowers as part of the aeration system. These areas are generally underground or in large buildings.

Photo Journal #4



Anoxic zone, denitrification area in activated sludge treatment.



Porous air diffusers in an aeration tank.



A up-close view of **non-porous diffuser heads**. Notice that some of the heads that are missing in the bottom photograph.



Blowers Sub-Section

In the diffused aeration system, blowers are used to aerate and circulate the tank's contents by the air-lift effect. The air filter on the blower removes dirt from the air, and helps prevent diffuser clogging. The power source to drive the blower is usually an electric motors. In remote locations, gas or diesel engines can be used as well. In some states, solar energy is available to provide the power for mixers but no so much for blowers.

As illustrated in the photograph below, the rotation of the motor shaft is transferred to the blower shaft by means of a flexible coupling or through drive belts. The blowers that we will refer to are centrifugal blowers.

The centrifugal blower works like a centrifugal pump or a fan. Rotating impellers or fans cause movement of the air through the blowers. An intake side takes in the air and the discharge side the forces the air out. The number of impellers will determine if it is a multi-stage or single-stage blower. The photographs below illustrate the major components of a centrifugal blower.

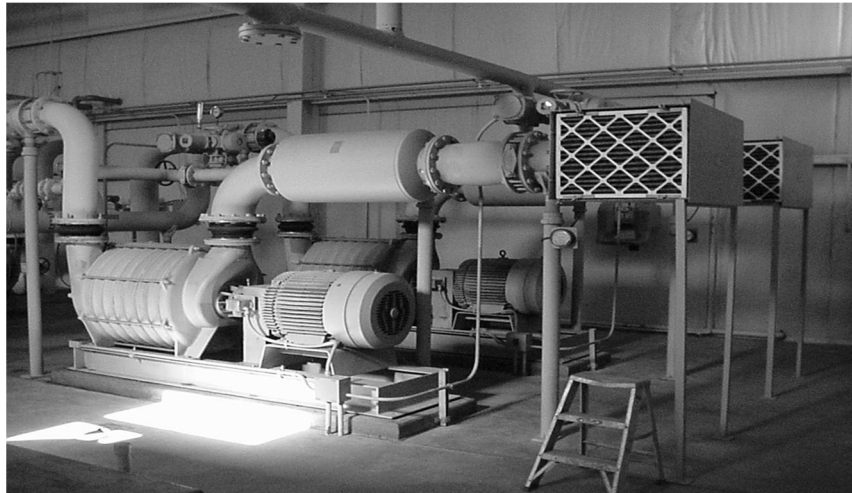

Centrifugal Blower

A lobe blower utilizes positive displacement; it also has an intake and a discharge side. The lobes turn in opposite directions in the casing. As they turn, the air is drawn in through the blower inlet and is trapped.

The lobes keep turning, opening the blower discharge, and forcing the trapped air through the outlet. Usually, an electric motor drives the blower with belt pulleys or flexible couplings. A lobe blower is a positive displacement pump and is capable of producing a relatively high-pressure air.



Lobe Blower

Before we continue let's review what you just read about the blowers and motors.

1. What are two ways that the motor and the blowers can be attached?
2. When using flexible couplings, what are some maintenance concerns to consider?

Blowers may be provided with additional equipment. For example, safeguards can be installed to protect equipment and operators. Temperature sensors for bearing housing, and vibration sensors protect the unit by shutting it down if limits are exceeded. Condensation drains should be provided on the bottom of blowers to drain off any accumulated moisture.

The compressed air from the blowers moves into a system of pipes and valves. The amount of air supplied from the blower is controlled by regulating valves mounted on the intake and/or discharge side of the blower. Usually butterfly valves are used either have manually operated or use automation.

Blowers usually discharge to a common manifold, so check valves are installed at the discharge of each blower. The intake and discharge pipes are called the air mains. They are connected by a flexible connection to allow for vibration and heat expansion in the piping. There is a pressure relief valve on the discharge manifold to protect the blower from excessive back pressure overload. When this occurs the operator will be awakened on the midnight shift. Pressure gauges are used in several areas on the discharge side of the blowers.

On the intake side, where air is supplied, is some type of filtering to remove dirt particles that could clog the diffusers. It also protects the blowers from excessive wear. Replaceable filter units are the simplest for operations. Bag house dust collectors are bulky and expensive, though maintenance may be less. In some cases, electrostatic precipitators may be an advantage, in areas of poor air quality. Most systems have utilized pressure drop measuring to indicate when it is time to replace or clean the units.



The above photograph shows air being unevenly distributed in an aeration tank.

Diffuser Layouts

There are many different design layouts and patterns of diffuser placement. Systems that allow longer and more complete contact between the air and the liquid are preferred. We will focus on fine bubble (porous) diffusers and coarse bubble (nonporous).

Coarse bubble diffusion devices, or large-hole diffusers, produce larger bubbles than porous plates, porous tubes, or synthetic socks. The larger bubbles provide less surface area for air-liquid contact and will result in less oxygen transfer efficiency than that obtained with fine bubble diffusers.

Mechanical Aeration

There are several main types of mechanical aeration devices. The floating and fixed bridge aerators are quite common. Some use a blade to agitate the tank's surface and disperse air bubbles into the aeration liquor. Others circulate the mixed liquor by an updraft or downdraft pump or turbine. This action produces surface and subsurface turbulence, while diffusing air through the mixed liquor.



Surface Aerators/Mixers Above



Floating Mixers



For the motor on this fixed bridge, aeration motor speeds are usually in the 1,800 rpm range. This speed is reduced to the 30 to 70 rpm range with gear reducers.

Most vertical motors for mixers are mounted on a gear reduction unit as seen in the photograph on the right. The impeller drive shaft can be enclosed in a housing connected directly to the gear box. There is a bearing at the bottom of the shaft that steadies and aligns this shaft. This bearing needs lubrication; always check your manufactures recommendations.

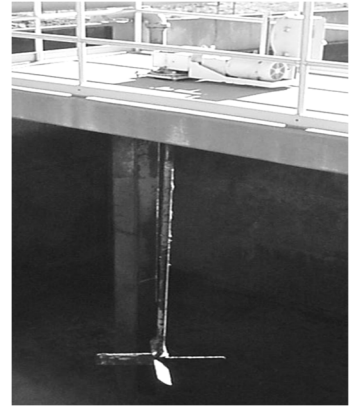

Some plants use an oxidation ditch in which rotating brushes, blades, or disks are rotated partially submerged in the mixed liquor. The turbulence produced traps the air bubbles and keeps the mixed liquor in motion.

Other systems use both compressed air and a mechanical device to trap the bubbles. In one such system, submerged turbine aeration, air is injected below a rotating turbine blade that shears and disperses the air. Submerged turbine applications have also used a draft tube operating in a downdraft-pumping mode.

Jet Aeration

Aerators provide oxygen transfer by mixing pressurized air and water within a nozzle and then discharging the mixture into the aeration tank. The velocity of the discharged liquid and the rising air plume provide the necessary mixing action.

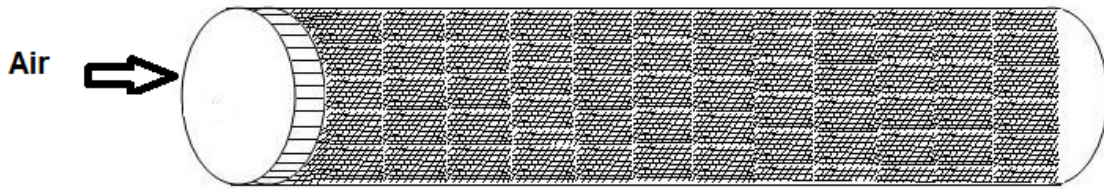

Perforated tube with plastic mesh wrapping

FINE BUBBLE AERATION

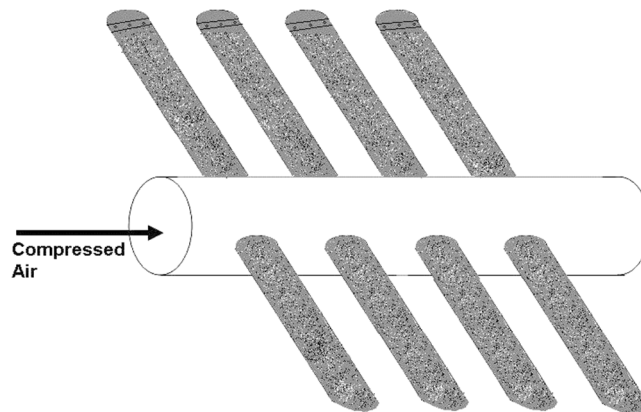

FINE BUBBLE DIFFUSERS

Advanced Treatment Methods Sub-Section

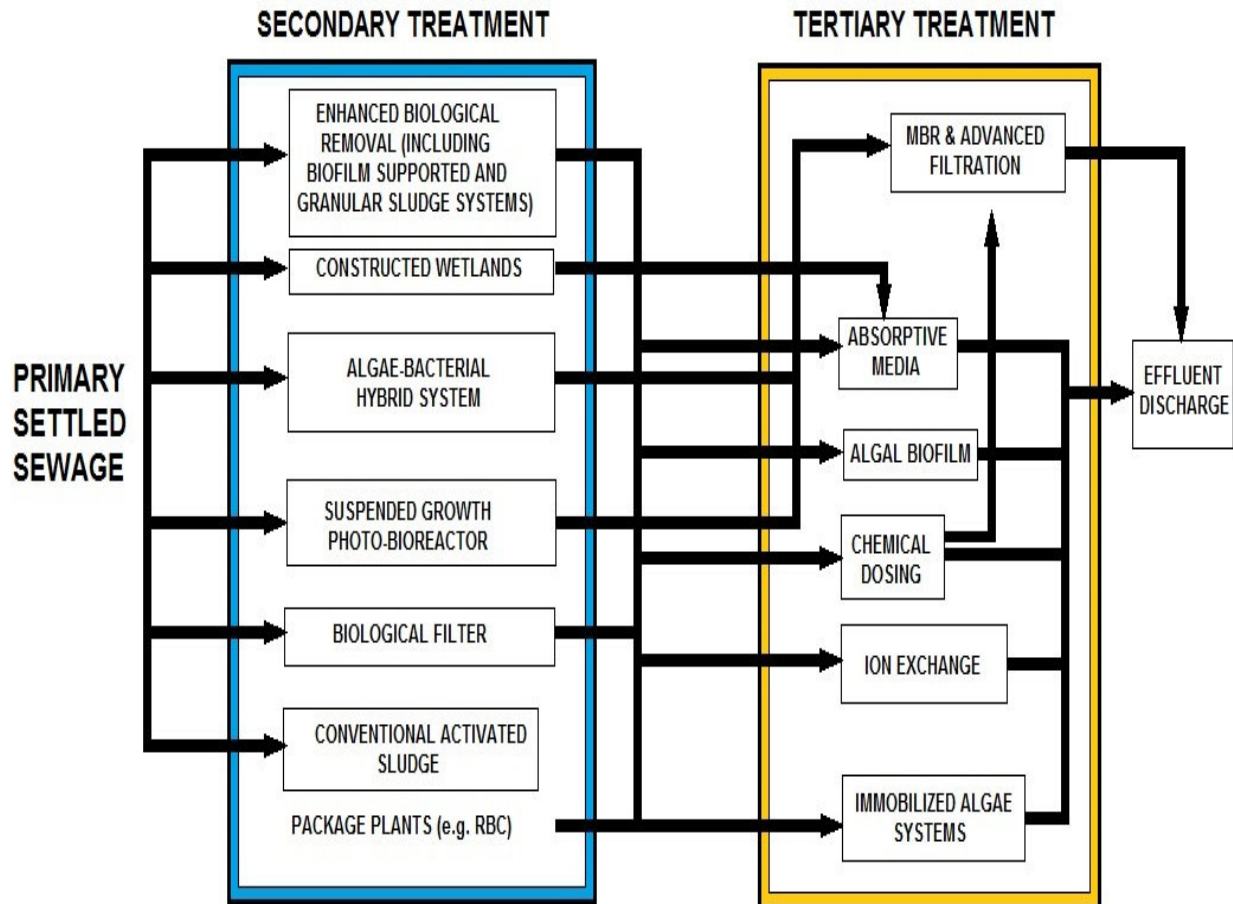

TERTIARY TREATMENT CONTAMINANT REMOVAL DIAGRAM

In advanced wastewater treatment, treatment methods are dependent upon the characteristics of effluent to be obtained after secondary treatment to satisfy further use or disposal of treated wastewater. The diagram above list different methods depending on the removal of BOD, TSS and minor portions of nitrogen, phosphorus, and heavy metals achieved during secondary treatment.

Tertiary Treatment Purpose

Tertiary treatment methods, considered as Advanced Treatment as seen above in chart, use different methods to achieve targeted removal for water quality. Another way to classify advanced wastewater treatment methods is to differentiate on the basis of desired treatment goals.

Advanced wastewater treatment is used for:

1. Additional organic and suspended solids removal
2. Removal of nitrogenous oxygen demand (NOD)
3. Nutrient removal
4. Removal of toxic materials

Different advanced methods are used to satisfy any of the several specific goals, which include the removal of:

1. Suspended Solids
2. BOD
3. Plant nutrients
4. Dissolved solids
5. Toxic substances

These methods may be introduced at any stage of the total treatment process or may be used for complete removal of pollutants after secondary treatment.

TREATMENT METHODS	REMOVAL CAPABILITIES
FILTRATION AIR / STEAM STRIPPING	SUSPENDED SOLID PARTICLES DISSOLVED AMMONIA VOLATILE ORGANIC COMPOUNDS (VOC's)
ADSORPTION	DISSOLVED ORGANICS, TO INCLUDE VOC's COLOURING ODORIFEROUS COMPOUNDS
BIOLOGICAL PROCESSES	NITROGENOUS & PHOSPHOROUS COMPOUNDS
MEMBRANE SEPARATION PROCESS SUCH AS MICROFILTRATION, ULTRA FILTRATION, NANOFILTRATION & REVERSE OSMOSIS (RO)	DISSOLVED ORGANICS AND INORGANICS
ION-EXCHANGE PROCESS	DISSOLVED ANIONS AND CATIONS
PRECIPITATION	HEAVY METAL IONS AND OTHER IONIC SUBSTANCES
OXIDATION - REDUCTION	ORGANICS & SOME INORGANICS
DISINFECTION	MICRO - ORGANISMS TO INCLUDE VIRUS



TERTIARY METHODS AND THEIR EFFECTIVENESS IN TREATMENT

Advanced Methods of Wastewater Treatment

As our country and the demand for clean water and permit regulation have grown, it has become more important to produce the best or cleanest wastewater effluents, yet some contaminants are more difficult to remove than others are.

All WWTPs must provide a minimum of secondary treatment of wastewater. WWTP treatment levels beyond secondary treatment are called advanced treatment or tertiary treatment. Advanced treatment technologies are now extensions of conventional secondary biological treatment to further stabilize oxygen-demanding substances.

Advanced treatment may include physical-chemical separation techniques such as adsorption, flocculation/precipitation, membranes for advanced filtration, ion exchange, and reverse osmosis.

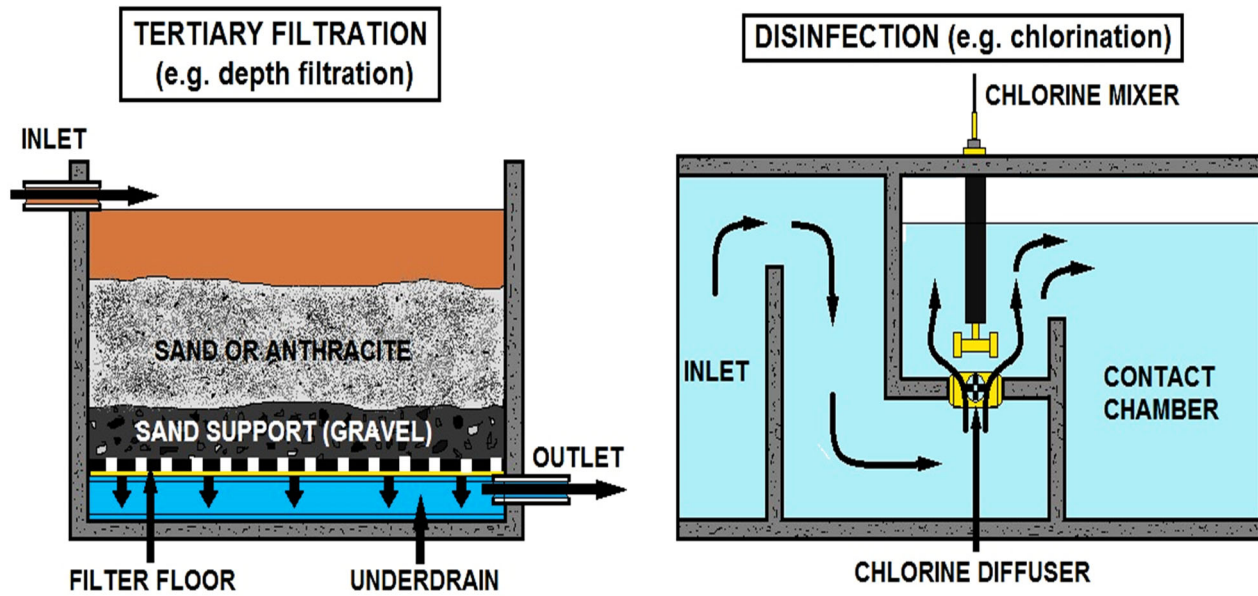

TERTIARY TREATMENT (Filtration / Disinfection)

The diagram above is a simple form of tertiary treatment that requires disinfection to kill harmful waterborne diseases. This stage is similar to the one used by drinking water treatment plants, which clean raw water for drinking purposes.

The tertiary treatment stage has the ability to complete the removal of up to 99 percent of the impurities from the raw wastewater. This produces effluent water that is close to drinking water quality. Unfortunately, this process tends to be a bit expensive, as it requires special equipment, well trained and highly skilled equipment operators, chemicals, and a greater energy supply.

Types of Conventional Wastewater Filters

New environmental wastewater treatment standards are more stringent and require lower levels of BOD, TSS and ammonia. Because of these standards, the following are a few of the tertiary filtration systems.

Conventional Down-Flow Filters

These filters consist of fixed-media beds typically up to 3 feet (1 M) in depth and are similar to filters used to treat drinking water. Media can be single media, dual media, or multi media. Single media is typically sand or anthracite.

Dual media combines anthracite and sand. Multi-media filters include a layer of garnet or limonite. Flow in these filters is by gravity from the top down. Most of the removal occurs in the top few inches of the media. The filter must be taken off-line periodically to backwash the filter to prevent clogging and too high of a pressure loss.

Deep-Bed Down-Flow Filters

These filters are similar to conventional down-flow filters but have deeper beds and a larger media size. This gives the advantage of longer run times between backwashes. The size of the media is limited in part by the ability to backwash the filter. Because these filters are more difficult to backwash, air scour is necessary to fully clean the filter bed.

Continuous Backwashing Upflow Sand Filters

During operation of the continuous backwashing upflow filter, water is introduced through risers at the bottom of a deep sand bed. Water flows upward through the sand bed and over an overflow weir. Sand and trapped solids flow downward through the filter and are drawn into the suction of an airlift pipe in the center of the filter. As the sand travels up the airlift pipe, energy from the air scours the particles and separates the sand from filtered solids. At the top of the airlift pipe, the clean sand settles back onto the top of the filter and the solids are carried away into a reject line.

These filters have the advantage of having no moving parts other than the air compressor and requiring less energy and maintenance than traditionally backwashed filters. They are sometimes referred to by the trade name Dynasand.

Pulsed Bed Filters

Pulsed bed filters are shallow filters with an unstratified fine sand media. An air pulse disturbs the media and allows penetration of solids into media bed, allowing the entire filter bed to be used for removal of solids. The pulse is designed to expand the filter operation and reduce the number of backwash cycles, although the filter must still be periodically backwashed to remove the solids.

Traveling-Bridge Filters

Traveling-bridge filters consist of long shallow beds of granular media. Wastewater is applied to the top of the media and flows downward. Each cell is individually backwashed by a traveling-bridge while the other cells continue to operate. The bridge uses filtered water to backwash the filters and includes surface wash to breakup matted solids or clumps of solids.

Fuzzy Filters

The fuzzy filter uses a proprietary synthetic filter media that is highly porous. Water flows not only around the media but also through it, allowing much higher filtration rates. The media is held in place by a metal plate and flow is from the bottom of the bed upwards. The filter is backwashed by raising the plate and introducing a horizontal air stream from alternating sides causing the media to roll back and forth. The effluent is returned to the plant.

Discfilters

Discfilters are a series of parallel mounted disks used to support a cloth filter media. Water enters a central tube and flows out between the two layers of cloth in each disk. The disks rotate and are normally 60 to 70 percent submerged. The portion above the water is backwashed using spray nozzles.

Cloth Media Disk Filters

The cloth media disk filter is similar to the discfilter listed above. In this case the water flows from the outside of the partially submerged cloth disks and into a center pipe. Disks continue to rotate during backwash and water is sucked into the disc using suction heads.

Membranes

Membrane systems use a pressure head to drive water through a permeable membrane. Membrane filters are typically classified by their pore size which in turn determines the size of the particles they exclude. Microfiltration, ultrafiltration, nanofiltration, and reverse osmosis (RO) remove increasingly smaller particles.

Microfiltration and ultrafiltration remove 3 to 6 logs of bacteria, 95 percent or more BOD, along with most particles (WEF, 2006). Nanofiltration removes nearly all particles including some viruses. RO removes all particles including viruses as well as most large dissolved constituents. The energy cost for applying the pressure head and the need to replace membranes make membrane filtration a more expensive technology. It can achieve very low concentrations of nutrients and other contaminants, however, and is common in water re-use projects.

Membranes can be configured a number of ways including hollow fiber, spiral wound, plate and frame, cartridge, or in pressure vessels. Membranes can foul from organics, biological activity, or metals in the wastewater. Typically, the water must be pre-treated before using these membranes. Pretreatment could be conventional filters, cartridge filters, or larger membrane filters. Disinfection may also be required to prevent biological fouling.

Blue PROTM Process

The Blue PROTM process uses a continuous backwashing filter that is designed to remove phosphorus. Filters can be run in series for even greater removal. The filter media (sand) is coated with a hydrous ferric oxide coating, which enhances phosphorus removal through adsorption. A ferric salt is added prior to the filter to aid in coagulation and to replace the ferric coating which is abraded from the sand. Water flows up through the filter while the sand travels down. An airlift tube at the bottom of the filter carries the sand upward. Turbulence from the compressed air knocks accumulated iron and phosphorus along with any solids off the particle as it travels upward. The iron, phosphorus, and particles are wasted, while the clean sand is deposited on the top of the bed. The filters can be run biologically active to achieve denitrification.

The Blu-CAT process combines the Blu-Pro process with addition of advanced oxidants. Early pilot tests show that this process is capable of removing other emerging contaminants along with phosphorus and microorganisms (USEPA, 2008a).

Pressure Filters

Pressure filters are similar to conventional media filters except they are contained in closed containers and are filtered under pressure. The increased pressure creates a greater head loss and allows for longer times between backwashes.

Design and Operating Principles

Filtration is mainly affected by the concentration and size distribution of particles entering the filter. Turbidity is often used as a surrogate for particle concentration. The concentration of particles will affect run-time in filters and will also affect the required

surface area to achieve the desired filtration. The size distribution of the particles and its relevance to pore size of the granular or membrane filters will affect the removal mechanisms. Filtration rate is also an important design parameter. Too fast of a filtration rate can cause floc to break up and pass through the filter.

The optimal filtration rate depends on floc strength, which in turn depends on the biological treatment processes prior to filtration (e.g., Higher SRTs lead to weaker flocs).

The filtration rate, along with the loading rate will determine the area of the filter required. The higher the loading rate, the more frequent backwashes will be required and the greater the head loss across the filters. Typical filtration rates are 15-50 feet (5 to 15 meters) of flow per hour for gravity filters and up to 65-70 feet (20 meters) per hour for pressure filters (WEF and ASCE, 1998). Equipment filtration is based on surface area loading.

Addition of polymers or other coagulant aids can greatly aid filtration. Typical doses for filter influent are 0.05 to 0.15 mg/L of organic polyelectrolyte (WEF and ASCE, 1998), although jar tests are conducted to determine the proper dose. Too low a dose can allow uncoagulated particles through the filter and too high a dose can lead to mudballs and filter clogging.

There are several ways the flow rate can be controlled in filters. Constant-rate fixed head filtration maintains a constant flow through the filter. This will lead to an increased head above the filter as the filter run progresses. In constant-rate variable head filtration the rate is kept the same and the filter is backwashed when the head reaches a certain value. In variable-rate filtration, the rate of filtration decreases throughout the filter run until it reaches a minimum value and is backwashed. Variable-rate filtration is less common than constant-rate filtration.

Proper backwashing is also important to filter operation. Without proper backwashing there can be breakthrough of particles and turbidity. Lack of a proper backwash can also lead to accumulation of materials on the surface of the filter that can form mudballs and cracks, which can allow solids to pass through the filter. A surface wash or air scour may also be helpful to prevent accumulation of mudballs or grease. Surface wash or air scour is also helpful for traveling bridge filters. Without surface wash traveling bridge filters are limited to an influent TSS concentration of 40 to 50 mg/L (WEF and ASCE, 1998).

If membrane filters are used, fouling can be an important consideration. Cellulose acetate membranes can be damaged by biological activity. Disinfection is often used to prevent biological fouling of the membranes. Some membrane materials such as polyacramides, however, can be damaged by chlorine. This can be avoided by using an alternative disinfectant, a different membrane material, or by de-chlorination.

Lowering the pH can help to prevent mineral fouling of nanofiltration or reverse osmosis membranes. Besides pre-treatment, chemical cleaning of the membranes may also be required periodically. Monitoring of effluent quality and pressure differential can be important to help identify membrane fouling or failure.

Ongoing Research and Emerging Technologies

The use of membranes as tertiary filtration is an area that has recently expanded. Research continues on various membrane configurations along with topics such as pre-treatment, membrane cleaning, and removal of emerging contaminants. Fuzzy filters are also an innovative technology that is beginning to be established in the wastewater community with several full scale projects. Other research has focused on enhancements to existing technology. For example, the Blue-Pro system combines continuous backwashing filters, a well-known technology, with a hydrous ferric oxide coating and ferric salt addition to remove phosphorus by adsorption as well as filtration.

Mathematical Modeling

The Need for Models

WWTPs are complex systems that depend on numerous biological, chemical, and physical processes to achieve effluent goals. Because of the complex behavior of the processes and the variability in wastewater characteristics, biological populations, and plant design, it is not always possible to predict how changing any one variable will affect the effluent quality.

Plant designs that work for one influent wastewater and climate may not perform well in different conditions. Pilot scale or full scale trials can help to determine the effect of various parameters, but costs and time to cover all possibilities may be prohibitive. Therefore, models fill an important need by enabling simulation of a process and estimating the impact that changing parameters will have on the treatment effectiveness.

Models can be used for a number of purposes including the design of new WWTPs, the design of retrofits or upgrades to existing plants, determining how changes in operations may affect effluent concentrations of permitted contaminants, determining how plants will respond to changes in influent quality or flow, and for training operators. Not all models can achieve all of these purposes, so models should be selected with the desired use in mind. There is some disagreement in the literature in the use of the term model.

Some references use the term to refer to sets of mathematical equations that characterize a process, other references use model to refer to the computer program used to solve these equations. This section will use the former and will use the term “simulator” to describe the computer program.

As you have previously read, depending on the design and operation of the process, activated sludge has several interrelated components:

1. Single aeration tank or multiple aeration tanks designed for completely mixed or plug flow.
2. An aeration source to provide adequate oxygen and mixing: sources can be compressed air, mechanical aeration, or pure oxygen.
3. A clarifier to separate the biological solids (activated sludge) from the treated wastewater.
4. A means of collecting the biological solids in the clarifier and recycling most of them (return activated sludge, RAS) to the aeration tank.
5. A means of removing or wasting excess biological solids (waste activated sludge, WAS) from the system.

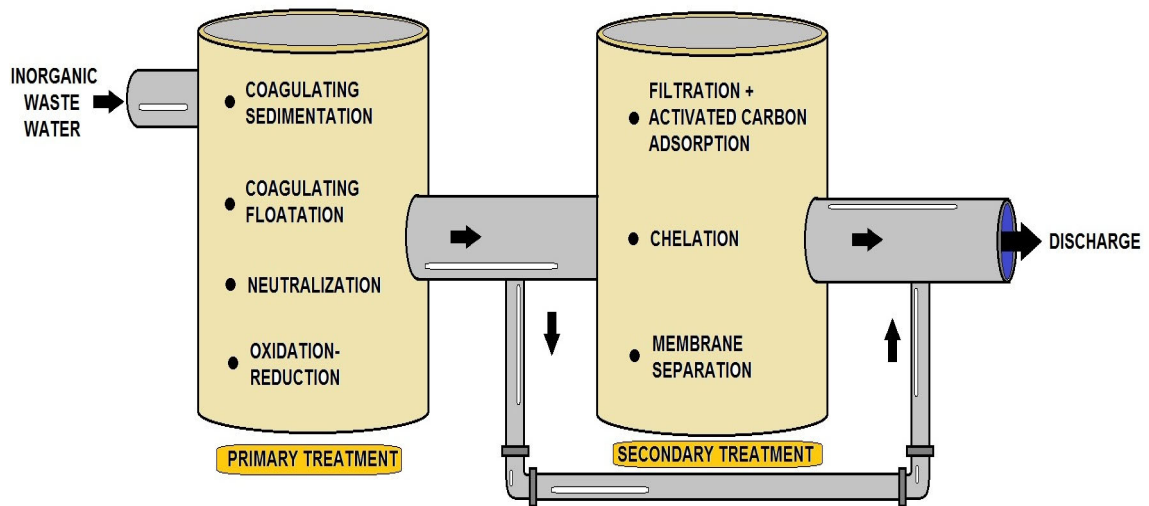

PROCESS OF REMOVING INORGANIC WASTE (Flow Diagram)

Oxidation Ditch Sub-Section *Credit EPA*

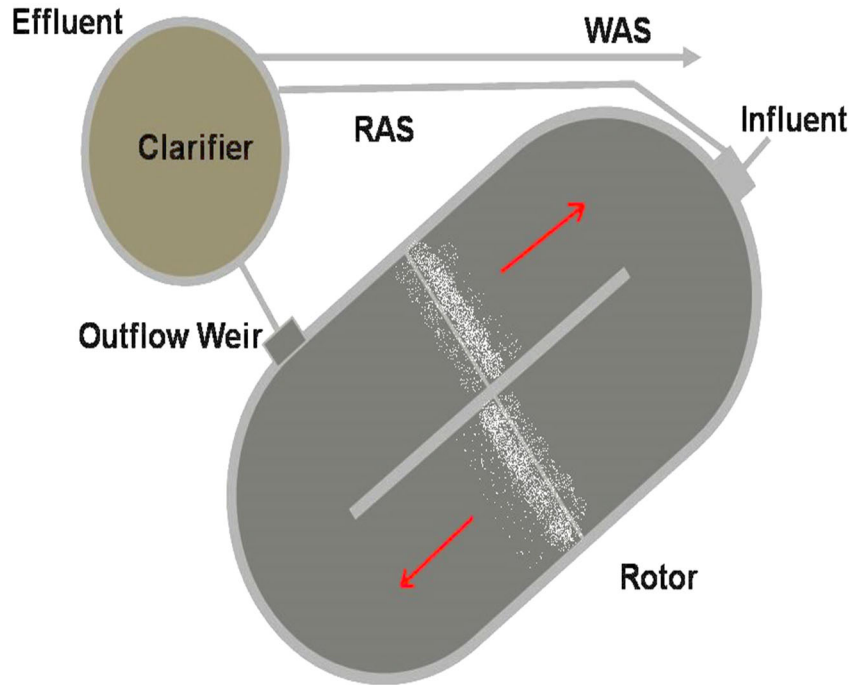

Oxidation Ditch

Many times in plants that have advanced treatment methods, we as operators will send RAS to the oxidation ditch or lagoon to eat the raw food in the system.

An oxidation ditch is a modified activated sludge biological treatment process that utilizes long solids retention times (SRTs) to remove biodegradable organics. Oxidation ditches are typically complete mix systems, but they can be modified to approach plug flow conditions.

An oxidation ditch is a modified activated sludge biological treatment process that utilizes long solids retention times (SRTs) to remove biodegradable organics. Oxidation ditches are typically complete mix systems, but they can be modified to approach plug flow conditions. (Note: as conditions approach plug flow, diffused air must be used to provide enough mixing. The system will also no longer operate as an oxidation ditch). Flow to the oxidation ditch is aerated and mixed with RAS from a secondary clarifier.

Typical oxidation ditch treatment systems consist of a single or multichannel configuration within a ring, oval, or horseshoe-shaped basin. As a result, oxidation ditches are called "racetrack type" reactors. Horizontally or vertically mounted aerators provide circulation, oxygen transfer, and aeration in the ditch.

Preliminary treatment, such as bar screens and grit removal, normally precedes the oxidation ditch. Primary settling prior to an oxidation ditch is sometimes practiced, but is not typical in this design. Tertiary filters may be required after clarification, depending on the effluent requirements. Disinfection is required and re-aeration may be necessary prior to final discharge.

Advantages

The main advantage of the oxidation ditch is the ability to achieve removal performance objectives with low operational requirements and low operation and maintenance costs.

Some specific advantages of oxidation ditches include:

- ✓ An added measure of reliability and performance over other biological processes owing to a constant water level and continuous discharge that lowers the weir overflow rate and eliminates the periodic effluent surge common to other biological processes, such as SBRs.
- ✓ Long hydraulic retention time and complete mixing minimize the impact of a shock load or hydraulic surge.
- ✓ Produces less sludge than other biological treatment processes owing to extended biological activity during the activated sludge process.
- ✓ Energy efficient operations result in reduced energy costs compared with other biological treatment processes.

Disadvantages

- ✓ Effluent suspended solids concentrations are relatively high compared to other modifications of the activated sludge process.
- ✓ Requires a larger land area than other activated sludge treatment options. This can prove costly, limiting the feasibility of oxidation ditches in urban, suburban, or other areas where land acquisition costs are relatively high.

Surface aerators, such as brush rotors, disc aerators, draft tube aerators, or fine bubble diffusers are used to circulate the mixed liquor. Solids are maintained in suspension as the mixed liquor circulates around the ditch.

The mixing process entrains oxygen into the mixed liquor to foster microbial growth and the motive velocity ensures contact of microorganisms with the incoming wastewater.

The aeration initially increases the dissolved oxygen (DO) concentration but the DO decreases due to biomass uptake as the mixed liquor travels through the ditch.

Oxidation ditch effluent is usually settled in a separate secondary clarifier. An anaerobic tank may be added prior to the ditch to enhance biological phosphorus removal. If design SRTs are selected for nitrification, a high degree of nitrification will occur.

An oxidation ditch may also be operated to achieve partial denitrification. One of the most common design modifications for enhanced nitrogen removal is known as the Modified Ludzack-Ettinger (MLE) process.

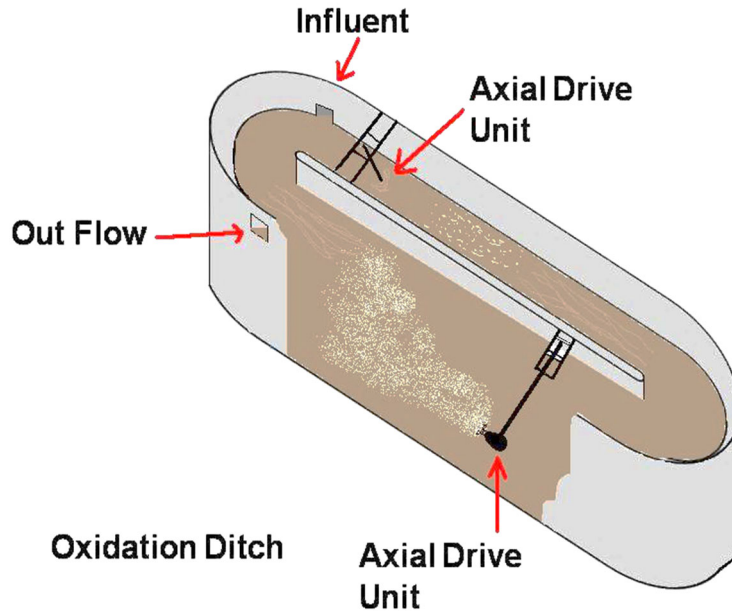

Understanding the Reactor

Some oxidation ditches add an anoxic tank upstream of the ditch along with mixed liquor recirculation from the aerobic zone to the tank to achieve higher levels of denitrification. In the aerobic basin, autotrophic bacteria (nitrifiers) convert ammonia-nitrogen to nitrite-nitrogen and then to nitrate-nitrogen. In the anoxic zone, heterotrophic bacteria convert nitrate-nitrogen to nitrogen gas that is released to the atmosphere. Some mixed liquor from the aerobic basin is recirculated to the anoxic zone to provide a mixed liquor with a high-concentration of nitrate-nitrogen to the anoxic zone.

Manufacturers have developed modifications to the oxidation ditch design to remove nutrients in conditions cycled or phased between the anoxic and aerobic zones. While the mechanics of operation differ by manufacturer, the process typically consists of two separate aeration basins, the first anoxic and the second aerobic.

Raw wastewater and return activated sludge (RAS), both with low dissolved oxygen (DO), are introduced into the first reactor that operates under anoxic conditions.

Mixed liquor (MLSS) then flows into the second reactor operating under aerobic conditions. The process is then reversed and the second reactor begins to operate under anoxic conditions.

The oxidation ditch process is a fully demonstrated secondary wastewater treatment technology, applicable in most situations where activated sludge treatment (conventional or extended aeration) is appropriate.

Oxidation ditches are applicable in plants that require nitrification because the basins can be sized using an appropriate SRT to achieve nitrification at the mixed liquor minimum temperature. This technology is very effective in small installations, small communities, and isolated institutions, because it requires less land than conventional treatment plants.

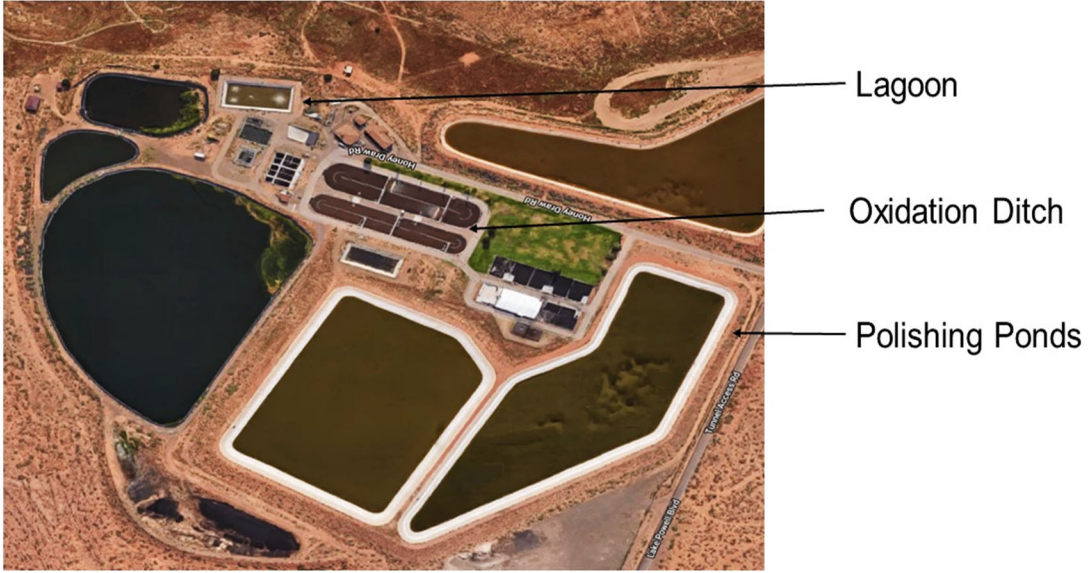

OXIDATION DITCH AND LAGOON LAYOUT

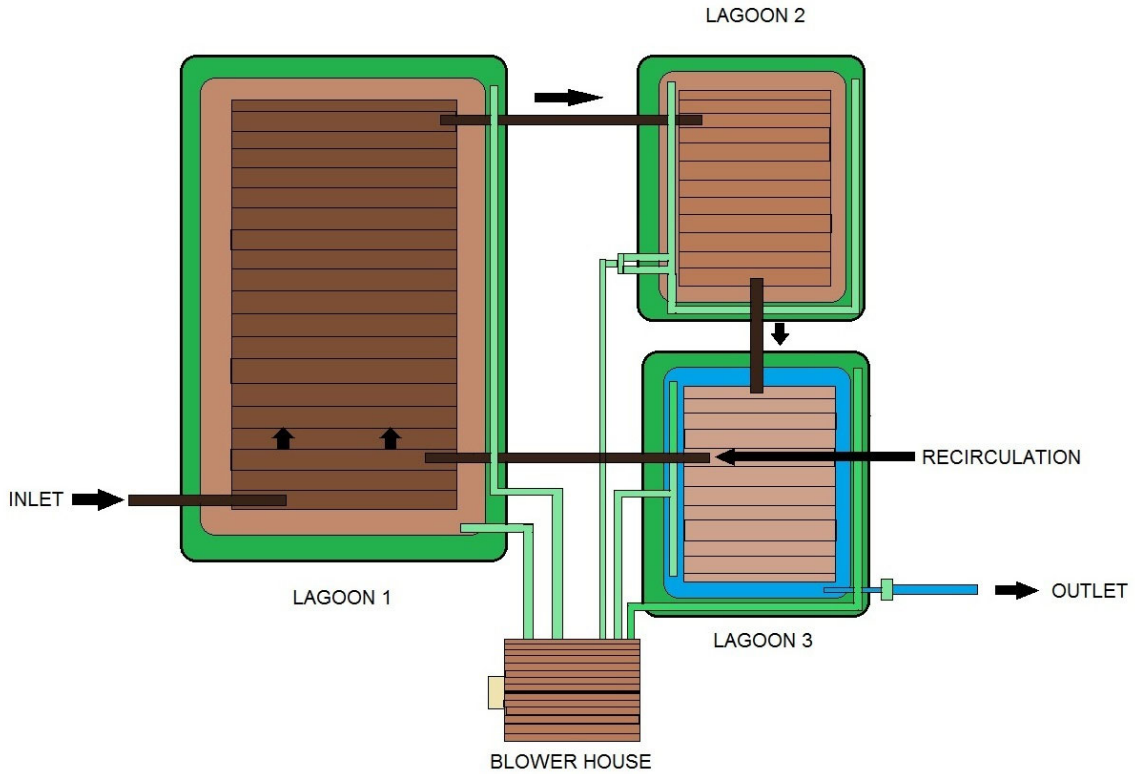

ADS LAGOON SYSTEM DIAGRAM

Alternative Secondary Treatment Section Post Quiz

1. Many bacterial species that degrade wastes grow as single bacteria dispersed in the wastewater. They do not settle and hence often leave the system in the effluent as solids (TSS).

True False

2. Most _____ bacteria have a wide range in environmental tolerance and can function effectively in BOD removal over a wide range in pH and temperature.

3. In the Autothermal Thermophilic Aerobic Digestion (ATAD) process (mesophilic bacteria are replaced by thermophilic bacteria at temperatures above 3-4°C to 60-70°C (158°F).

True False

4. There are several oxidation ditch designs that can remove _____.

5. Mixed lagoons require a secondary sedimentation unit, which in some cases can be a pond basin excavated in earth, or conventional settling tanks can be used.

True False

6. Oxidation ditches are typically _____, but they can be modified to approach plug flow conditions.

7. The rotating biological contactor (RBC) is a fixed film biological secondary treatment device. The basic process is similar to that occurring in the _____.

8. Anaerobic methane formation involves two different groups of aerobic bacteria that function together to convert organic materials to methane via a three-step process.

True False

9. Nitrifying bacteria are more sensitive to DO levels as compared to aerobic _____, with growth rates starting to decline below 3 to 4 mg/L with significant reduction below 2 mg/L.

10. Wet weather events can increase inflow and infiltration into the collection system and subsequently increase the hydraulic load to the wastewater treatment plant. This can in turn reduce the _____ to reduced performance of nitrification process units.

11. Land application of _____ can supplement and may reduce fertilizer use. Land application results in the storage of carbon in the soil, thereby minimizing greenhouse gas (GHG) emissions to the atmosphere.

12. The concentration of phosphorus in the sludge typically increases as the SRT increases, although the impact is very small over the SRT range of _____.

Intermediate-Rate Filters

13. Intermediate rate filters can be loaded up to _____ kg BOD₅/100 m³-d (40 lb BOD₅/1000cu ft/day).

High-Rate Filters

14. High-rate filters are generally loaded at the maximum organic loading capabilities of the filter and receive total BOD₅ loading ranging from _____ to _____ kg BOD₅/100 m³-d (40 to 100 lb. BOD₅/1000cu ft/day).

Roughing Filters

15. Filters of this type generally have a design load ranging from _____ - _____ kg BOD₅/100 m³-d (100 to 300 lb. BOD₅/1000cu ft/day).

Alternative Secondary Treatment Section Post Quiz Answers

1. True 2. Heterotrophic, 3. False, 4. Phosphorus, 5. True, 6. Complete mix systems, 7. Trickling filter, 8. False, 9. Heterotrophic bacteria, 10. SRT leading, 11. Municipal biosolids, 12. 4 to 30 days, 13. 64, 14. 64 to 160, 15. 160-480

Topic 4 - Activated Sludge Process Section

Section Focus: You will learn the basics of the activated sludge process. At the end of this section, you will be able to describe the activated sludge process and various treatment methods. There is a post quiz at the end of this section to review your comprehension and a final examination in the Assignment for your contact hours.

Scope/Background: Activated sludge (A/S) is a term used both to refer to a widely utilized wastewater treatment process, and to the solid compounds, which result from that process.

The activated sludge technique is one of the most commonly used methods for handling human waste in municipal settings around the world, and it can also be employed in the treatment of industrial wastewater. The goal is to remove as much solid organic material from the wastewater as possible, to facilitate further stages in the water treatment.

ACTIVATED SLUDGE

The **activated sludge** process is a process for treating sewage and industrial wastewaters using air and a biological floc composed of bacteria and protozoa.



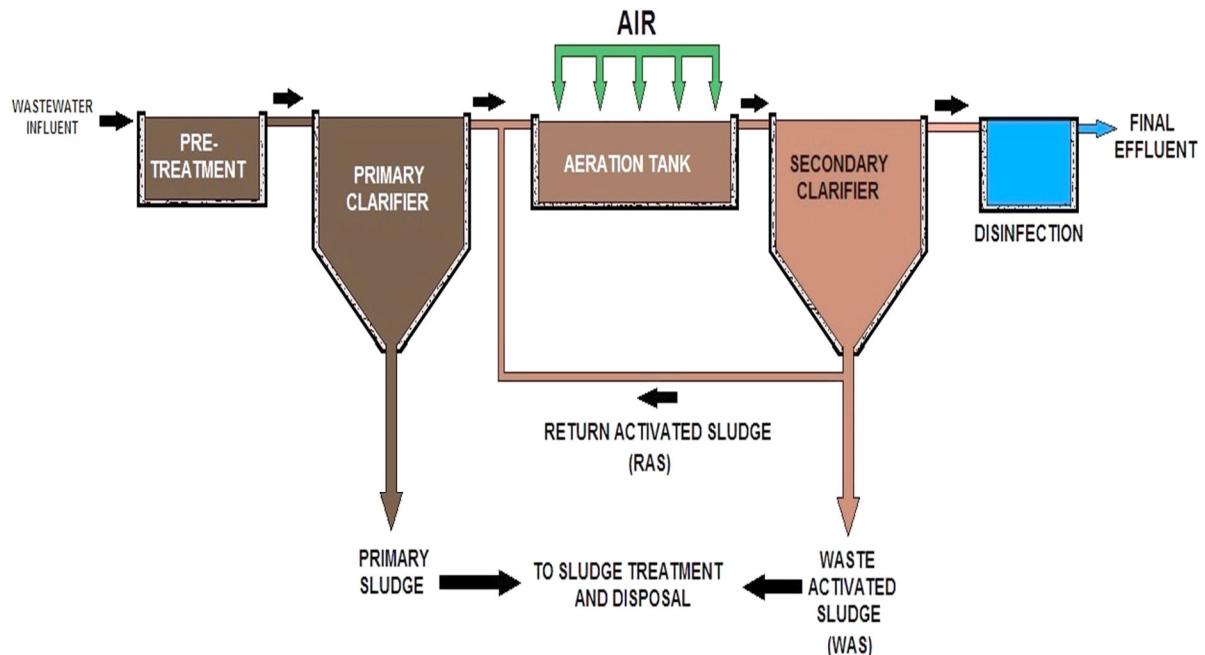

ACTIVATED SLUDGE WASTEWATER TREATMENT FLOW DIAGRAM

Activated Sludge Technical Process Description

See references for section credit #1 and #15.

Wastewater aeration is the process of adding air into wastewater to allow aerobic bio-degradation of the pollutant components. It is an integral part of most biological wastewater treatment systems. Unlike chemical treatment which uses chemicals to react and stabilize contaminants in the wastewater stream, biological treatment uses microorganisms that occur naturally in wastewater to degrade wastewater contaminants.

- a) This process is comprised of aeration tank followed by secondary clarifier. In the aeration tank organic load will be degraded by cultivated microbial cultures.
- b) Constant MLSS (Mixed Liquor Suspended Solids) will be maintained in the aeration tank by recycling the activated sludge trapped by the secondary clarifier.
- c) Recycling of the bio-sludge is usually done by non-clog, centrifugal, semi-open type continuous duty sludge recirculation pumps. Oxygen is supplied to the aeration tank by air from an air blower. Aeration tank diffusers are provided for an even distribution of air. Nutrients in the form of sewage is dosed at aeration tank for growth of bacteria

Since this is a biological process, understanding some basic biology will be needed. Some terms that will be used in this discussion and definitions follow:

Aerobic Organisms that must have D.O.

Anaerobic Organisms that need no D.O. or nitrate (NO₃) oxygen

Autotrophic Organisms, which are able to use inorganic compounds as a food source

Facultative Organisms that can exist with or without D.O.

Heterotrophic Organisms, which consume organics in the wastewater

The activated sludge (A/S) process relies on the cultivation of a population of millions of microorganisms of many different types, mostly aerobic and facultative heterotrophic bacteria suspended in the wastewater, as it passes through a reactor (aeration tank).

Bioflocculation Introduction

The activated sludge process and other biological treatment processes excel at converting smaller particles and soluble, biodegradable organic material into larger heavier particles through *bioflocculation*. In the activated sludge basin, the incoming wastewater is fed to a complex mixture of bacteria and other microorganisms known as MLSS. The organic material in the influent wastewater becomes the bugs' food. We will cover this section in a few pages.

As the bacteria consume the available food, they form large colonies called floc that under the right conditions grows large enough and dense enough that they can be separated from the treated wastewater by gravity. The flocs are kept suspended in the activated sludge process with either mixers, aeration or a combination of mechanical mixing and aeration.

Non-biodegradable solids in the raw water also become part of the floc particles through bioflocculation. Individual floc particles have a life cycle of initial formation and growth. As the floc particles age, the more difficult it becomes for the bacteria at the center to rid themselves of waste products and gain access to nutrient and oxygen. Eventually, the larger floc will break into smaller flocs and the cycle will begin anew.

Activated Sludge Section - Illustrative Boxes 5-7

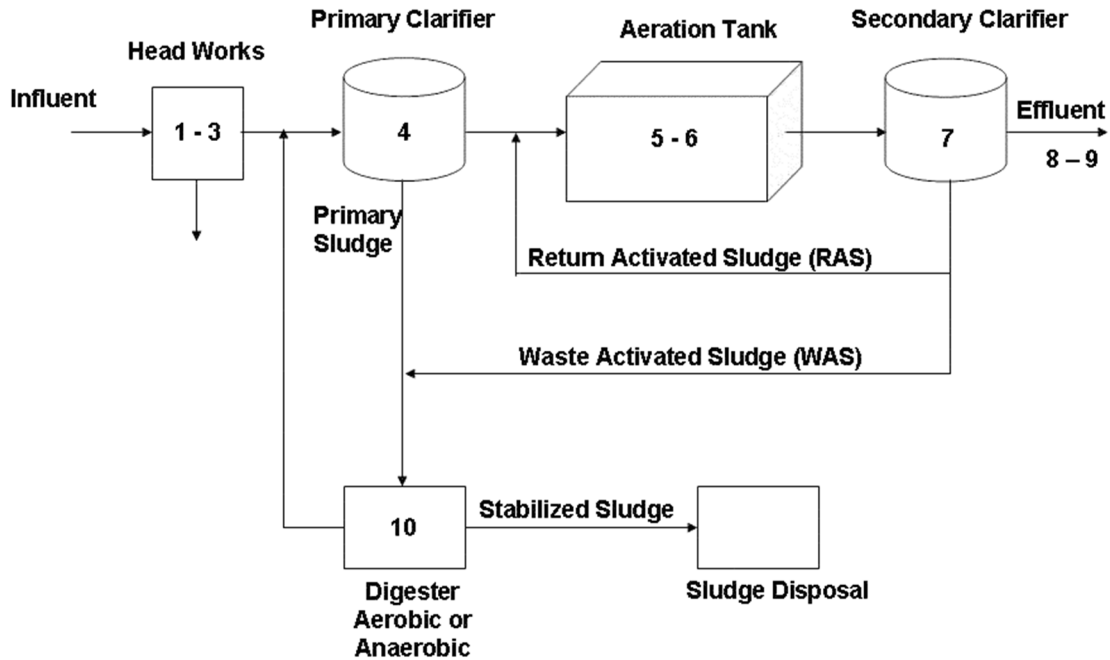

Aeration Basins - Box 5-6

Large aeration basins or tanks mix the partially treated *wastewater* with oxygen to support bacteria that devour organic waste. The bacteria levels are managed to provide the most efficient removal process. Return Activated Sludge (RAS) brings sludge back to the aeration process for further treatment while Waste Activated Sludge (WAS) removes the excess or older sludge.

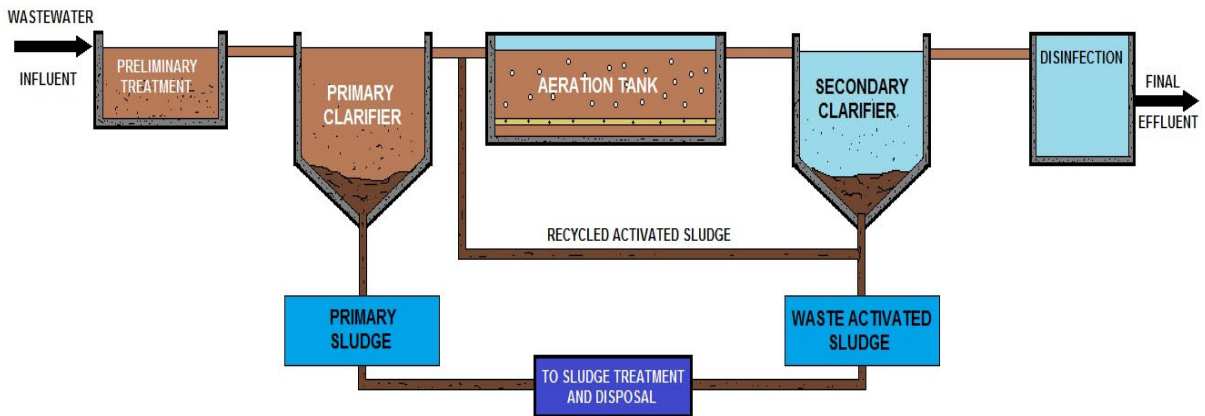

Basic A/S Process Overview

Reference- Credit to US EPA #4 & #19

Primary Clarification - Purpose and Function Box 4

Before the time the wastewater reaches the secondary treatment process, many of the larger particles have been removed from the wastewater by screening, grit removal and/or primary clarification.

Regardless of whether or not a WWTP has primary clarifiers, many of the particles that remain in the wastewater when it reaches the activated sludge process won't settle quickly on their own. For treatment to continue, the size and density of the remaining particles must be increased so that they can be efficiently removed.

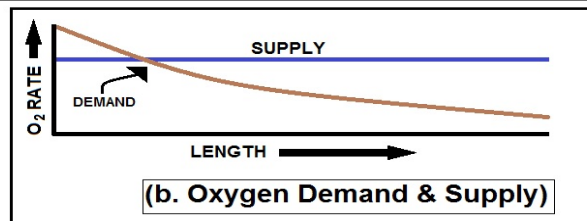
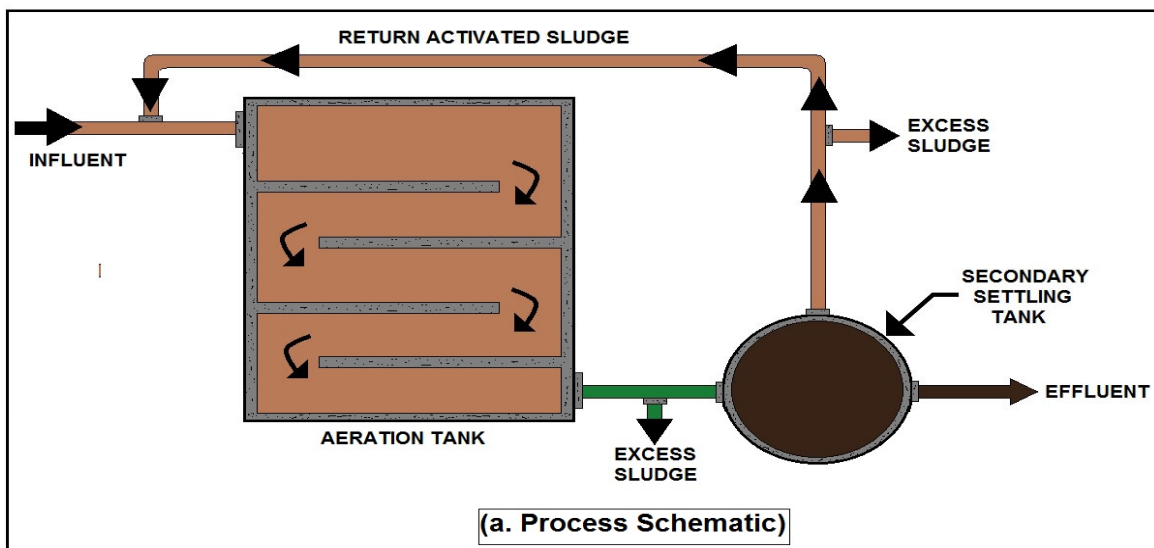

DIAGRAM OF CONVENTIONAL ACTIVATED SLUDGE PROCESS

A basic activated sludge process consists of several interrelated components:

- An aeration tank where the biological reactions occur
- An aeration source that provides oxygen and mixing
- A tank, known as the clarifier, where the solids settle and are separated from treated wastewater
- A means of collecting the solids either to return them to the aeration tank, (return activated sludge [RAS]), or to remove them from the process (waste activated sludge [WAS]).

Aerobic bacteria thrive as they travel through the aeration tank. They multiply rapidly with sufficient food and oxygen. By the time the waste reaches the end of the tank (between four to eight hours), the bacteria has used most of the organic matter to produce new cells.

RAS and WAS

Most of the settled floc is called Return Activated Sludge (RAS) and is returned to maintain the desired MLSS value. Settled activated sludge is collected in the secondary clarifier or the membrane basin and returned to the aeration basin to mix with incoming raw or primary settled wastewater.

Measuring the solids concentration of RAS helps to keep the return volume adjusted to keep the solids level in the aeration basin within the control parameters.

Excess sludge which eventually accumulates beyond what is needed is defined as Surplus or Waste Activated Sludge (SAS/WAS). This is removed from the treatment process to keep the ratio of biomass to food supplied (sewage or wastewater) in balance. Typical Range: 2,000 to 5,000 mg/l for the MLSS.

Final Clarifier Operation

The process involves oxygen or air being introduced into a mixture of screened, and primary treated wastewater combined with organisms to develop a biological floc that reduces the organic content of the sewage.

Return activated sludge (RAS) comes from the final clarifiers. The final clarifier is to separate the activated sludge, the biological floc, from the treated water. The floc settles to form sludge that will be returned to the process or wasted to sludge conditioning or processing units.

Internal Mixed Liquor Recycle (IMLR) - Introduction

Internal Mixed Liquor Recycle (IMLR) is when the MLSS is being moved around within the activated sludge basin. It does not go through the clarifiers and is completely separate from RAS.

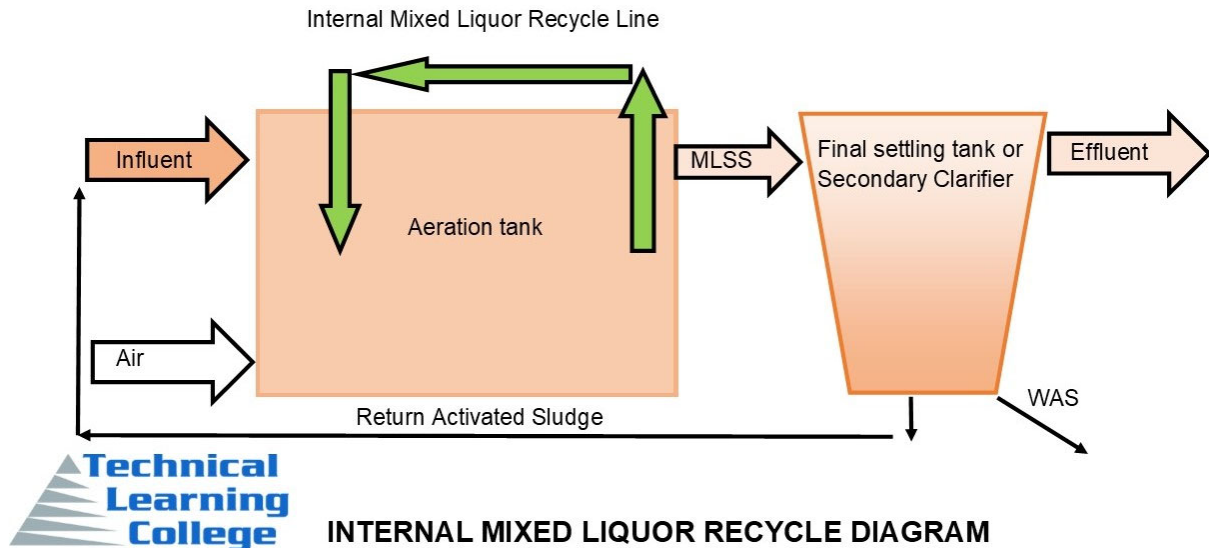

Activated Sludge Operational Process Steps

1. Combines influent wastewater with a mixture of bugs and O₂ - Oxidizing the organic solids.
2. Promotes coagulation and flocculation and convert dissolved, colloid and suspended solids into settleable solids. In practice, the following operations are carried out in an activated sludge process.
3. The wastewater is given treatment in the primary sedimentation tank. The detention time is kept as short as 1-1/2 hours.
4. The settled sewage from the primary sedimentation tank is mixed with the required quantity of activated-sludge in the aeration tank. The mixture of activated sludge and wastewater in the aeration tank is called 'mixed liquor or mixed liquor suspended solids MLSS.
5. The Mixed Liquor Suspended Solids is aerated for 6-8 hours in the aeration tank, called the hydraulic detention time according to the degree of purification. About 24 feet³ (8m³) of air is provided from each yard³ (m³) of wastewater treated. The volumes of sludge returned to the aeration basin is typically 20 to 60% of waste water flow.
6. The aerated Mixed Liquor Suspended Solids resulting in the formation of flock particles, ranging in size from 50 to 200 pm which is then removed in the secondary sedimentation tank by gravity settling, leaving a relatively clear liquid as the treated effluent. Typically greater than 99% of suspended solids can be removed in the clarification step.
7. Most of the settled sludge is returned to the aeration tank (and is called return sludge) to maintain the high population of microbes that permits rapid breakdown of the organic compounds. Because more activated sludge is produced than is desirable in the process, some of the return sludge is diverted or wasted to the sludge handling system for treatment and disposal.
8. Waste activated sludge may be removed directly from the activated sludge basin, the RAS line or through a dedicated WAS line.
9. The amount of MLSS removed each day determines the sludge age of the system. Sludge age is an important parameter for the A/S process control.
10. Portions of the A/S processes may be aerobic, anoxic and/or anaerobic. The presence or absence of oxygen, nitrite and nitrate helps determine the types of microbial activity.

Activated Sludge Control Factors and Calculations

Credit to Reference #1 State of Michigan, pages 10-12

Control Factors Overview

Proper operation of an activated sludge plant will require knowledge of biological and physical factors that influence the efficiency of the process. These factors include:

- organic and hydraulic loading on the aeration tank
- dissolved oxygen in the aeration tank
- biosolids wasting rate
- return activated sludge rate
- clarifier loading
- solids settling and compaction characteristics

Organic Loading

Organic loading refers to the number of pounds per day of BOD entering the process. In most activated sludge plants this is based on the primary effluent, but in plants without primary clarifiers it would be based on the plant influent flow. Pounds per day of BOD loading may be easily calculated using the **Pounds Formula**.

Multiplying the flow rate in million gallons per day by the weight of a gallon of water (8.34 Lbs./Gallon) and times the concentration in milligrams per liter of BOD in the flow yields the number of pounds per day of BOD in that flow.

It may be advantageous to calculate the organic loading as a five-day or seven-day **moving average**. This helps to average out day to day loading fluctuations, allowing more consistent control of the operation. A seven day moving average would be calculated by averaging the pounds of BOD for a particular day with values for the six days previous.

Quantity of Microorganisms

The concentration of mixed liquor (MLSS) is determined by suspended solids analysis of the suspension in the aeration tank. Since this suspension includes biological mass as well as inorganic material present in the wastewater, the amount of biological mass is estimated by determining the organic content of the MLSS.

Mixed Liquor Volatile Suspended Solids (MLVSS) is determined by igniting a sample of the dried MLSS in a muffle furnace at 550°C. The material that burns at that temperature is considered to be organic, and therefore estimates the biological mass. The material that remains (non-volatile, or fixed) estimates the inorganic fraction of the MLSS. So in process control calculations where all of the solids must be considered, MLSS is used in the calculation. In calculations where just the active biological population should be considered, MLVSS is used.

The quantity of microorganisms available for treatment is also calculated using the pounds formula. Since the microorganisms are in the aeration tank, pounds of microorganisms are calculated by multiplying the volume of the aeration tank(s) in millions of gallons times the weight of a gallon of water (8.34 lb/gal) times the MLVSS concentration in milligrams per liter.

Food to Microorganism Ratio

Food to Microorganism Ratio (F:M) is one of the primary controls used in activated sludge plants. This helps the operator to maintain a balance between the quantity of food available, with the quantity of microorganisms in the aeration tanks.

Since the food available to the microorganisms is represented by the BOD of the wastewater, the F:M ratio is calculated by dividing the number of pounds of BOD entering the secondary treatment system by the number of pounds of MLVSS in the aeration tanks.

While best treatment may not occur at the same F:M ratio in different plants, the range for **Conventional** activated sludge plants is often given as 0.25 to 0.45. Activated sludge plants that operate in the **Extended Aeration** mode typically operate with F:M in the 0.05 to 0.15 range.

Since the operator usually has no control over the number of pounds of BOD entering the wastewater treatment plant, F:M is adjusted by adjusting the number of pounds of MLVSS in the secondary system. If more and if less biomass is needed (lowering MLVSS) the wasting rate must be increased until the necessary pounds of biomass is achieved.

A couple of things that must be remembered regarding making operational changes:

- 1) biological systems react slowly to these types of control changes; give the system time to adapt to a change before making another adjustment, and
- 2) consistency is often the key to successful operation; use a moving average to calculate pounds of BOD, and make few adjustments; only when necessary.

F:M is most useful as an operational tool when the operator sets a target F:M, and based on the average BOD loading calculates the pounds of MLVSS needed to achieve that F:M. Divide the pounds of BOD by the target F:M to calculate the pounds of MLVSS needed. The concentration of MLVSS in the aeration tank can then be calculated by dividing the pounds of MLVSS by the aeration tank volume in million gallons and by 8.34 lbs/gallon.

Cell Residence Time

Cell Residence Time (CRT), also known as **Sludge Age (SA)** or **Solids Retention Time (SRT)**, may be defined as the average length of time in days that an organism remains in the secondary treatment system.

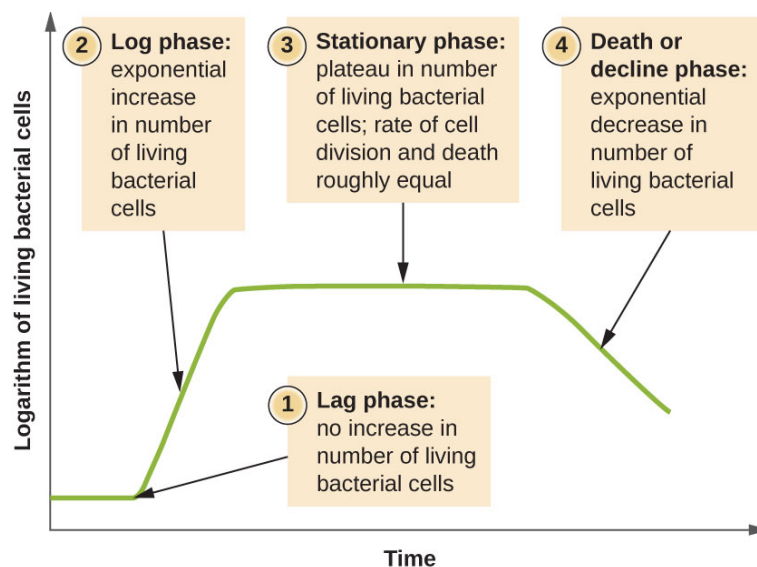

The graph above illustrates the growth phases in a biological system and how the growth rate of microorganisms' changes with increased CRT.

When a food supply is introduced into a biological treatment plant that is in start-up, there is an abundance of food but very few organisms. The organisms are said to be in **Lag Phase** as they begin to acclimate to the waste, producing the needed enzymes, and the population begins to increase. Once the organisms have acclimated, the growth rate increases rapidly in the **Log Growth Phase**. At this point the food supply is not a limiting factor as BOD is converted to biological mass, producing large amounts of sludge.

In the **Declining Growth Phase** the population has grown to the point that the available food supply begins to limit the production of new cells and organisms begin to compete for food. As the population ages (CRT 5 days or greater), larger and more complex organisms which are able to compete for the remaining food are more numerous, and predatory organisms begin to feed on smaller ones as a food chain develops.

In the **Endogenous Phase** the food supply has been depleted and as the age of the population increases (CRT is now up to >15 days), the organism growth rate continues to decline. Food which the organisms have stored is metabolized and the organisms feed on one another in **Endogenous Respiration**. Although the concentration of organisms is large, sludge production is lower.

Sludge Cultivation – RAS and WAS

Active biological material produced by activated sludge plants is called activated sludge. Excess sludge is either called "return activated sludge" or "waste activated sludge" and is removed from the treatment process to keep the ratio of biomass to food supplied in the wastewater in balance. WAS is usually mixed with primary sludge from the primary clarifiers and undergoes further sludge treatment for example by anaerobic digestion. Thickening, dewatering, composting and land application are possible following treatments.

Biomass or MLSS

In the activated sludge basin, incoming wastewater is fed to a complex mixture of bacteria and other microorganisms that forms a bug community referred to as *biomass* or *Mixed Liquor Suspended Solids (MLSS)*.

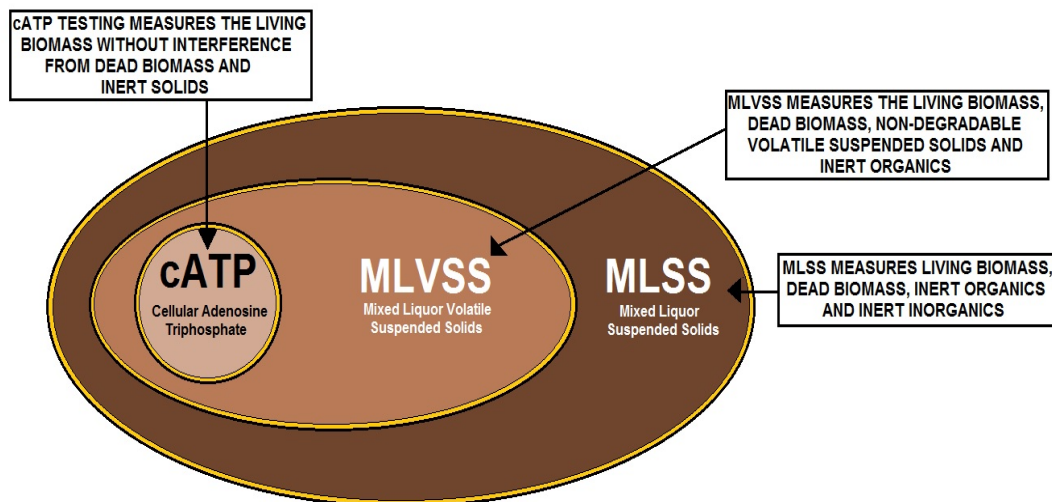

COMPARATIVE WASTEWATER TESTING OF ACTIVATED SLUDGE CONTENT DIAGRAM

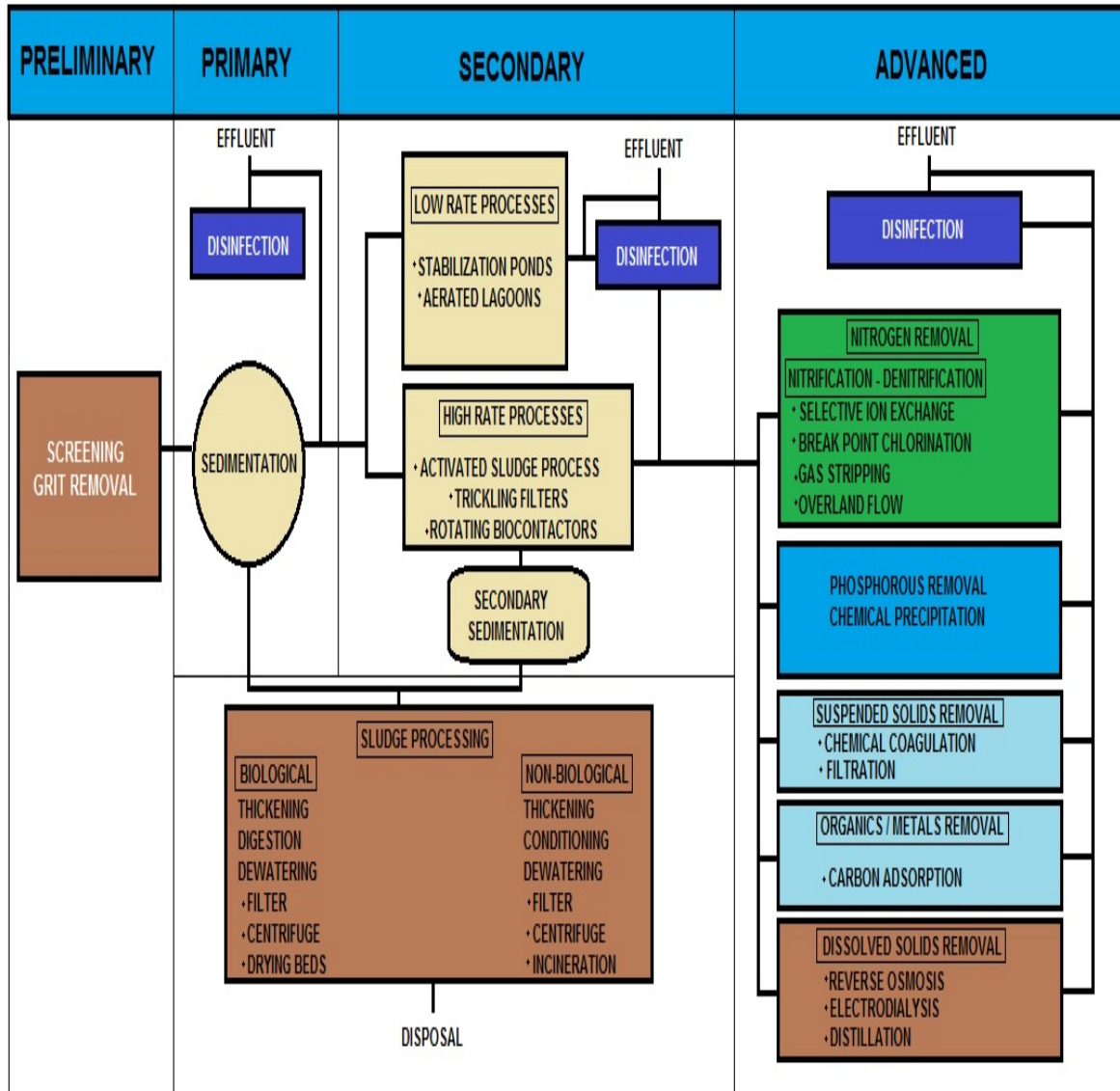

SLUDGE PROCESSING FLOW DIAGRAM

This diagram is not conclusive. There are many various methods and processes that are interchangeable. Another problem is the lingo. Some operators call processes by different names in different areas. We will try to call methods and processes by the EPA's terminology.

Process Control - Introduction

Common process control methods for wasting sludge from activated sludge process.

Credit *Introduction to Activated Sludge Study Guide - December 2010 Edition Page 11 of 28 Printed on 12/11/12*

A. Constant MLSS (Mixed Liquor Suspended Solids)

Provided the influent loadings are constant, the operator maintains a relatively constant solids inventory (MLSS level) in the aeration basins for a desired level of treatment. The range of MLSS is typically between 1000-4000 mg/L.

B. Food To Microorganism Ratio (F/M Ratio)

For microbiological health and effective treatment, the microorganisms (mixed liquor suspended solids) under aeration should be maintained at a certain level for the amount of food (influent BOD) coming into the plant. This is known as the food to microorganism ratio. For conventional activated sludge, the F/M ratio is usually between 0.2-0.5. For extended aeration systems, such as package plants and oxidation ditches, the F/M ratio should be between 0.03-0.10.

C. Sludge Age

Activated sludge is recycled back through the aeration basins by returning settled sludge in the final clarifiers and thus remains in the activated sludge system for a number of days. For effective treatment, a certain sludge age is desired for the type of activated sludge system. For conventional activated sludge, a sludge age of 3-10 days is typical. For extended aeration activated sludge, older sludge ages of 15-30 days are common. F/M ratio and sludge age are inversely related (1 divided by the sludge age approximates the F/M ratio). The older the sludge, the lower the F/M ratio; conversely, the younger the sludge, the higher the F/M ratio. All three process control methods are regulated by wasting sludge. It is the key to controlling the activated sludge process. The operator should monitor MLSS, F/M ratio and sludge age to waste accordingly and thus ensure optimal operations and process stability.

Common Practice

For most activated sludge processes, the MLSS will be conveyed to a separate secondary clarifier and allowed to settle. In a sequencing batch reactor (SBR) type activated sludge process, treatment and clarification takes place in the same basin. For the separation step to be efficient, the floc particles grown in the activated sludge basin must be large and dense. Process control is all about producing an MLSS that flocculates, settles, compacts, and produces a final effluent that meets discharge permit limits for organics, solids, ammonia and other parameters.

Treated clarified water flows out through the top of the clarifier while the MLSS settles to the bottom to form a sludge layer called the blanket. Most of the settled MLSS is returned to the aeration tanks as activated sludge (RAS). Excess sludge is removed from the process as waste activated sludge (WAS).

In the third step of treatment, **Flocculation and Separation**, the microorganisms stick together to form large particles that will settle out of the purified wastewater in the secondary clarifier.

Flocculation occurs when mixing allows the organisms to contact one another, but does not cause conditions so turbulent that the flocculated material is torn apart. Settleability and compaction of the floc particles depends on the density, size and shape of the particles as well as the efficiency of the clarifier. Settleability is affected by the abundance of **filamentous bacteria**, those that form strings as they grow rather than forming floc. An excessive growth rate of these bacteria may cause a **bulking** condition in which the mixed liquor does not compact well, taking up much more volume in the clarifier. This condition may be caused by many factors, among which are improper D.O. environment and nutrient imbalance, and may result in solids loss in the clarifier effluent.

Chemical Flocculation

Chemical, non-biological A/S-type flocculation involves the addition of chemicals that cause the solid particles to coagulate or stick together so they settle rapidly. Once the chemicals are added, the solids can be forced to settle more rapidly through gentle mixing. This type of flocculation is diagrammed below.

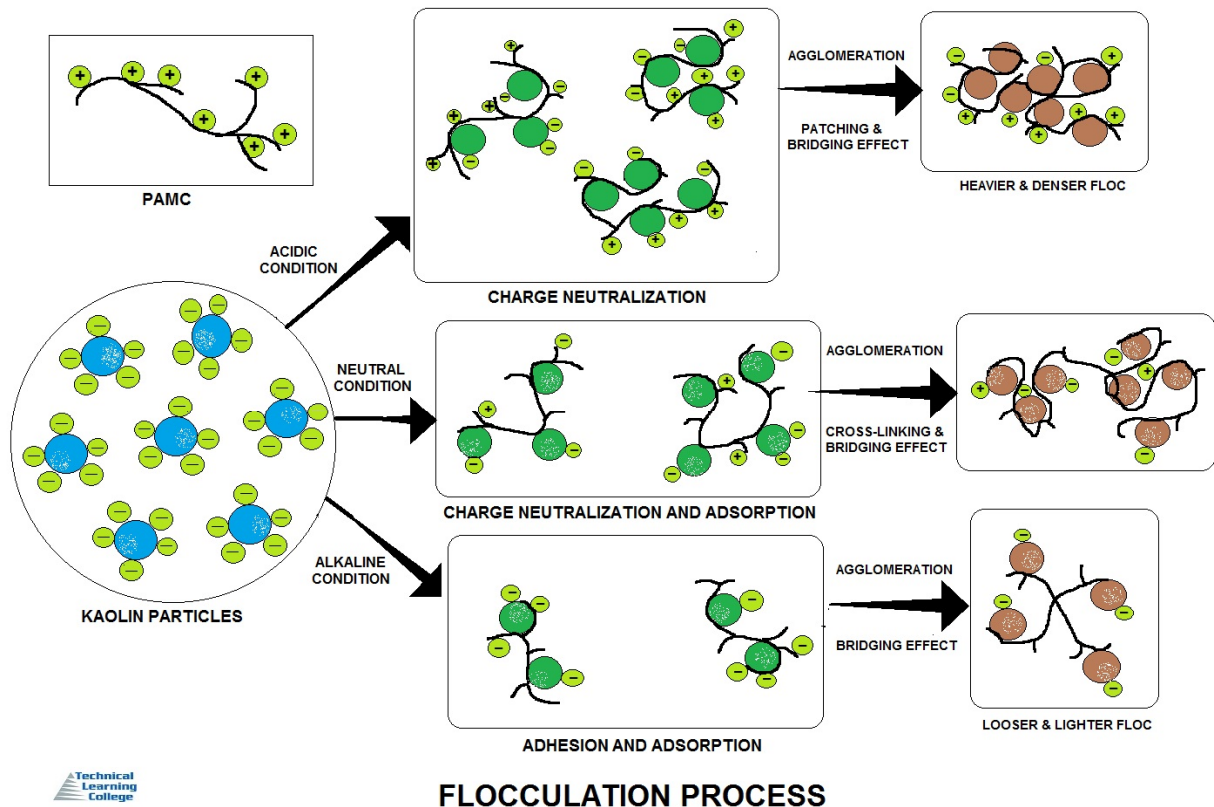

Activated sludge flocs are a flocculated mass of microorganisms, extracellular polymeric substances (EPS) and adsorbed organic and inorganic material. The structure of the floc is very heterogeneous and flocs with very different properties and morphologies may occur, depending on the conditions in the activated sludge treatment plant and wastewater composition. Present thinking suggest that cations, such as calcium, create cationic bridges with EPS excreted by the bacteria and thereby hold the various floc constituents

together. However, due to the complex and heterogeneous nature of activated sludge, the mechanisms have neither been thoroughly investigated nor successfully quantified.

A better understanding and description of the biological flocculation process is necessary in order to establish more efficient operational strategies. The main aim of this study was to get a comprehensive and unique insight into the floc properties of activated sludge and to assess the relative impact of chemical and physical parameters. A variety of sludges from full scale treatment plants with different settling properties were characterized.

The interrelationships between floc parameters such as composition of EPS, surface properties and floc structure, and their effect on the flocculation and separation properties were assessed. The results indicate that the EPS, both in terms of quantity and quality, are very important for the floc properties of the activated sludge. However, presence of filaments may alter the physical properties of the flocs considerably.

The EPS showed positive correlations to sludge volume index (SVI) if only sludges with low or moderate numbers of filaments were included. The surface properties were more affected by the composition of the EPS than by the number of filaments. The EPS showed positive correlation to negative surface charge and a negative correlation to relative hydrophobicity and flocculation ability. The negative correlation between flocculation ability and amount of EPS was surprising. The shear sensitivity, measured as degree of erosion of flocs when subjected to shear, was more affected by floc size and number of filaments than amount of EPS.

Bioflocculation

The action of some bacteria and algae causing the clumping together of fine, dispersed organic particles, resulting in faster and more complete settling of the organic solids in wastewater. Flocculation, especially bioflocculation, is an attractive low-cost separation technology. Various new bioflocculation strategies have been claimed to generate major advances in cost-efficient harvesting. Here, we review the recent advances in bioflocculation based on algal–bacterial, algal–fungal, or algal–algal interactions within the framework of microalgae biomass harvesting for biofuel production.

A/S process utilizes bioflocculation. Non-biodegradable solids in the raw wastewater also can become part of the floc particles through *bioflocculation* or are swept out in the effluent if the floc particles do not settle. The floc contains fibers, bacteria, inert material, and more complex microorganisms. Individual floc particles have a life cycle of initial formation and growth.

As the floc particles age, they accumulate dead bacteria and other inert material and increase in size. Collisions between smaller flocs yield larger flocs. The larger the floc particles gets, the more difficult it becomes for the bacteria at the center to rid themselves of waste products and gain access to nutrients and oxygen. Eventually, the floc will break down into smaller flocs and the cycle will begin again.

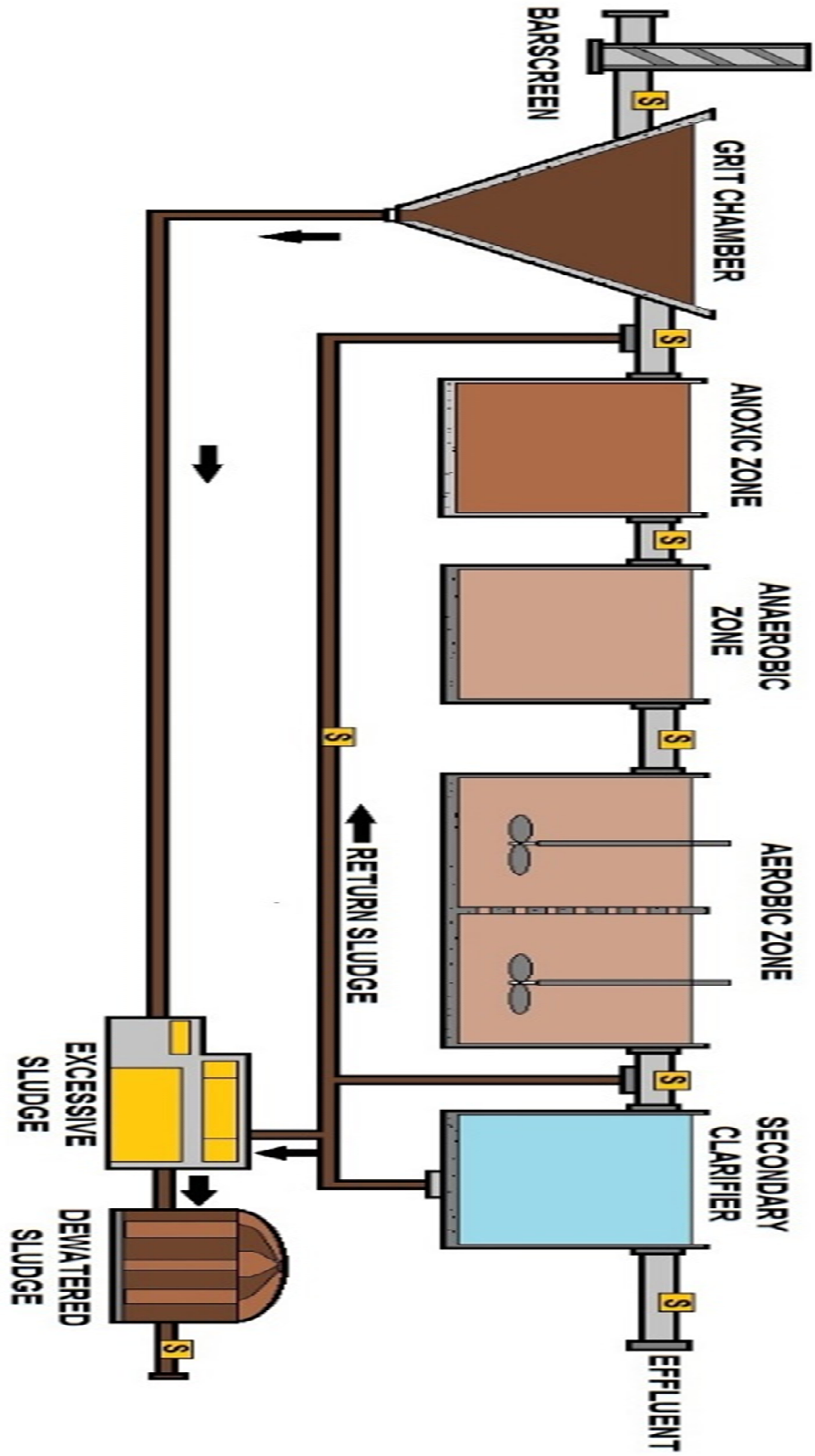

BASIC WASTEWATER TREATMENT PLANT AND SAMPLING POINTS

Factors Affecting Biological Activity

Credit #1 State of Michigan

Effect of Temperature on Activated Sludge

As is true of any biological system, the activity and efficiency of the biomass in an activated sludge facility is dependent to a fairly large extent on the temperature of the wastewater. It has been demonstrated that each 10 degree C drop in water temperature in the aeration tank reduces biomass activity by about 50%. This means that as the water temperature drops, organism growth rate slows down. BOD removal will occur more slowly, and the system will require a longer recovery after upset.

Wastewater temperature is usually more stable in cities using ground water as the drinking water supply. Influent sewage in these cities usually stays pretty consistently in the 50-55 degree F range. Facilities in cities that use lake or river water as the drinking water source may experience a wider range of wastewater temperatures. Often the biggest changes in wastewater temperature occur following a rapid snow melt and after rainfall. Biological activity increases to a maximum at a temperature of about 100 degrees F. Increased temperature beyond that point would be expected to result in a sudden die-off of the biomass.

Effect of pH on Activated Sludge

Biological activity in an activated sludge plant is best in a pH range of about 6.5 to 8.5. Growth may occur outside of that range, but at a reduced rate, and may result in the filamentous bacteria, especially at low pH values. Oxygen uptake is thought to be optimum between pH 7.0 and 7.4. Generally pH values below 7 are more detrimental than those above 7. Sudden changes and frequent fluctuations in pH are most damaging.

Although pH may be controlled at the wastewater treatment plant by acid or base addition before the aeration tanks, this is expensive, and not practical at most municipal facilities and large industrial plants. The best means of controlling influent pH is to control the source of acids and bases discharged into the collection system.

Toxicity in Activated Sludge Facilities

A wide range of organic and inorganic compounds are known to be toxic to activated sludge biomass. Many of the heavy metals such as cadmium, chrome, nickel, and lead are toxic above about 1 mg/L. Silver, and arsenic, and mercury are toxic at concentrations much less than 1 mg/L. Cyanide, herbicides, and pesticides are toxic to this biological system as they are to any other.

Toxicity often first becomes apparent as a rise in D.O. concentration in the aeration tank. As organisms become impaired or destroyed by the toxic material, the rate of oxygen uptake decreases, so the D.O. concentration in the aeration tank increases. This may be followed by **deflocculation**, where floc particles are no longer able to maintain their structure and come apart to leave a very turbid effluent.

Settleability in the secondary clarifier is often impaired, and if the facility has been nitrifying a sudden increase in effluent ammonia will usually occur as the nitrifying organisms are killed. Higher effluent BOD may occur, as heterotrophic bacteria and other organisms are impaired or killed.

Organisms may acclimate to some extent to low concentrations of a toxic material, so long as the concentration is fairly consistent. Activated sludge plants have been known to remove significant amounts of heavy metals from wastewater flows after acclimation. Sudden increases or long periods of time between dosages will produce toxic effects.

A problem which may result from the removal of toxic materials (especially metals) by the biomass is that this material often concentrates in the sludge wasted from the secondary system. This in turn causes problems for the facility that intends to dispose of this sludge on agricultural land. The best solution to this problem is to control toxic materials at their source, not allowing them into the collection system.

Oxygen Uptake Rate (OUR)

The rate at which the biomass uses oxygen in the metabolism of pollutants in wastewater is dependent on several factors. The amount and age of the biomass, water temperature, amount of food available, and the health of the biomass all affect how quickly wastes are metabolized, and therefore how quickly oxygen is used. Determination of the OUR may be used by the operator as a control tool, especially in monitoring the system for toxic materials in the wastewater.

A lower than normal OUR in a system that has plenty of food and microorganisms is usually an indication that the biomass has been impacted by toxicity; a higher than normal OUR may indicate an organic overload. A high OUR that returns to normal within a short time may indicate a shock or slug load.

While OUR must be determined on a fresh sample from the aeration tank, sample collection point will be an important consideration. Samples should be collected at the head of the tank where return sludge mixes with influent wastewater.

OUR should be at its highest at this point in the aeration tank and will give a good indication of metabolism under high food conditions; probably the best sampling point to monitor for toxicity. Samples collected near the discharge end of the aeration tank should indicate that metabolism is nearly complete before passing to the secondary clarifier. A high OUR at the discharge end of the aeration tank may be an indication of inadequate detention time in the aeration tank or of an organic overload. It would be wise for the operator to collect samples at both ends of the aeration tank and at the midpoint to have an overall indication of how metabolism progresses through the tank.

The OUR test is simple and quickly performed with equipment already on hand in the WWTP laboratory. Equipment needed includes a D.O. meter with BOD bottle probe and a timer. OUR simply measures the amount of oxygen used up in a BOD bottle over a 10 minute time period, with the results reported as milligrams per liter of oxygen used per hour.

The test can be modified to eliminate the variable due to the amount of biomass in the sample by dividing the OUR by the grams per liter of MLSS. In this case the result is reported as the Specific Oxygen Uptake Rate (SOUR), in units of milligrams oxygen used per hour per gram MLSS. SOUR may also be referred to as the Respiration Rate (RR).

Microscopic Examination of Activated Sludge – Introduction

References- Credit #1, #6, & #9

Microscopic examination of the MLSS can be a significant aid in the evaluation of the activated sludge process. Although the heterotrophic and autotrophic bacteria which are mainly responsible for purifying the wastewater are too small to be easily observed, the presence of several other microorganisms within the sludge floc may give an indication of treatment conditions and efficiency. The most important of these indicator microorganisms are the protozoa and the rotifers. These higher life forms also play an important role in clarifying the wastewater, consuming bacteria and small particulates, and improving biomass settleability.

A predominance of ciliates and rotifers in the MLSS is a sign of good sludge quality. Treatment under these conditions, with proper RAS, WAS and aeration rates, can be expected to produce a high quality effluent. Inversely, a predominance of filamentous organisms and a limited number of ciliates is characteristic of a poor quality activated sludge. This condition is commonly associated with a sludge that settles poorly. The sludge floc is usually light and fluffy because it has a low density. There are many other organisms such as nematodes (worms) and waterborne insect larvae which may be found; however, these typically do not significantly affect the quality of treatment.

The microorganisms which are important to the operator are the protozoa and rotifers. As discussed previously, the protozoa eat the bacteria and help to provide a clear effluent. Basically, the operator should be concerned with three groups of protozoa, each of which have significance in the treatment of wastewater.

These groups include the following:

- 1) Amoeboids
- 2) Flagellates
- 3) Ciliates

Amoeboids

The cell membranes of Amoeboids are extremely flexible; and the mobility of these organisms is created by the movement of protoplasm within the cell. Food matter is ingested by absorption through the cell membrane. Amoeboids may predominate in the MLSS floc during start-up periods of the activated sludge process or when the process is recovering from an upset condition.

Flagellates

These organisms are characterized by the tail (Flagella) which extends from their round or elliptical cell configuration. Their mobility is created by a whipping motion of the tail, which allows them to move with somewhat of a corkscrew motion. Flagellate predominance may be associated with a light-dispersed MLSS floc, a low population of bacteria, and a high organic load (BOD). As a more dense sludge floc develops, the flagellate predominance will decrease with an increase of bacteria. When the flagellates no longer are able to successfully compete for the available food supply, their population decreases to the point of insignificance.

Ciliates

These organisms are characterized by the rotating hair-like membrane (cilia) which cover all or part of their cell membrane. Their mobility is created by the movement of the cilia, and the cilia around the gullet are utilized for the intake of food. Ciliates may predominate during the period of fair to good settling of the activated sludge.

They are considerably larger than flagellates and for the purposes of microscopic examination may be classified into two basic groups, which are the free swimming and the stalked ciliates.

Free Swimming Ciliates

Free swimming ciliates are usually apparent when there are a large number of bacteria in the activated sludge. These organisms feed or graze on the bacteria and clarify the effluent. Therefore, their presence is generally indicative of a treatment process that is approaching an optimum degree of treatment. A relative predominance of flagellates indicates decreased treatment efficiency and the MCRT of the system should be increased to maintain a relative predominance of free swimmers, stalked ciliates and higher forms of organisms such as rotifers.

Stalked Ciliates

These organisms are frequently present when the free swimmers are unable to compete for the available food. A relative predominance of these organisms along with rotifers will indicate a stable and efficiently operating process.

Rotifers

Although large in comparison with most other activated sludge organisms, rotifers are a group of the smallest multi-cellular microorganisms. They are strictly aerobic, existing only where dissolved oxygen is plentiful.

Rotifers may attach to floc particles by use of a forked tail or may swim freely in the wastewater, grazing on bacteria, algae, protozoa, and small particulate matter in the waste. At their anterior end they possess cilia which are rotated to gather food as well as to propel the organism through the water. Rotifers are more abundant at higher cell residence times and are an indication of a high level of treatment.

MLSS Evaluation by Microscopic Examination

Observation of microorganism activity and predominance in the activated sludge can provide guidance in making process control adjustments.

The Worksheet for Microscopic Examination for Activated Sludge can assist the operator in deciding whether to increase or decrease the MCRT based on the relative predominance of the organisms found in the MLSS. The decline of ciliates and rotifers is frequently indicative of a poorly settling sludge.

These observations may make it possible to detect a change in organic loading or cell residence time before an upset occurs. These changes can be correlated with observations of the settling characteristics of the MLSS in the 30-minute settling test, and by calculation of the F/M. If the other tests confirm these observations, adjustments to the MLSS should be made to alleviate the problem.

In summary, relative predominance of ciliates and rotifers are an indication of process stability. This predominance is associated with the efficiency of treatment under various loading conditions. An increase or decrease in the predominance of these organisms may be indicative of process upset before there is a major effect on process performance.

Mixed Liquor and Microorganisms - Introduction

References- Credit #1, #6, & #9

Mixed liquor suspended solids (MLSS) in healthy sludge is a brown floc, largely composed of saprotrophic bacteria. It has an important protozoan flora component mainly composed of amoebae, Spirotrichs, Peritrichs including Vorticellids and a range of other filter-feeding species. Other important organisms include motile and sedentary Rotifers.

In poorly managed activated sludge, a range of mucilaginous filamentous bacteria can develop including *Sphaerotilus natans* that produces a sludge that is difficult to settle. This can result in the sludge blanket decanting over the weirs in the settlement tank severely deteriorate and contaminate the final effluent quality.

In all activated sludge plants, once the wastewater has received sufficient treatment, the mixed liquor is delivered to the secondary into settling tanks. The treated supernatant may then undergo further treatment before discharge. Part of the settled sludge material is returned to the head of the aeration system to re-seed the new wastewater entering the tank. This fraction of the floc is called *return activated sludge* (RAS).

MLVSS

Mixed liquor volatile suspended solids. MVLSS is generally defined as the microbiological suspension in the aeration tank of an activated-sludge biological wastewater treatment plant.

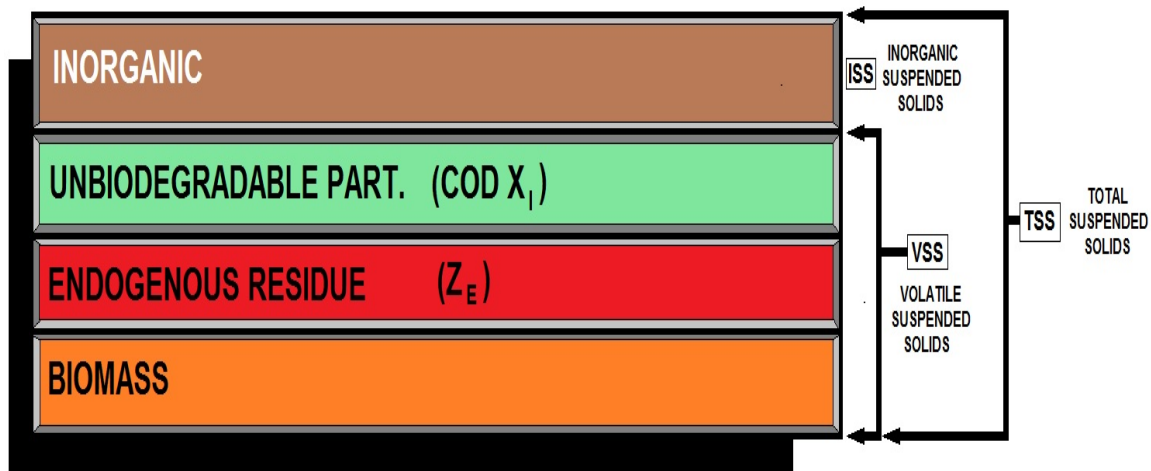

COMPONENTS OF MIXED LIQUOR SUSPENDED SOLIDS

Why Measure MLSS

If the MLSS content is too low the process is prone to bulking and the too “young” treatment becomes overloaded. This can cause the dissolved oxygen content to drop with the effect that organic matters are not fully degraded and biological 'die off'. Conversely, if the MLSS content is too high the process is not working efficiently, and is likely to be wasting energy whilst not treating the influent effectively. This old sludge may not form effective floc and settle too fast and heavy. The typical control band is 1,500 to 4,000 mg/l MLSS. **We will cover this in greater detail in the Laboratory Chapter.**

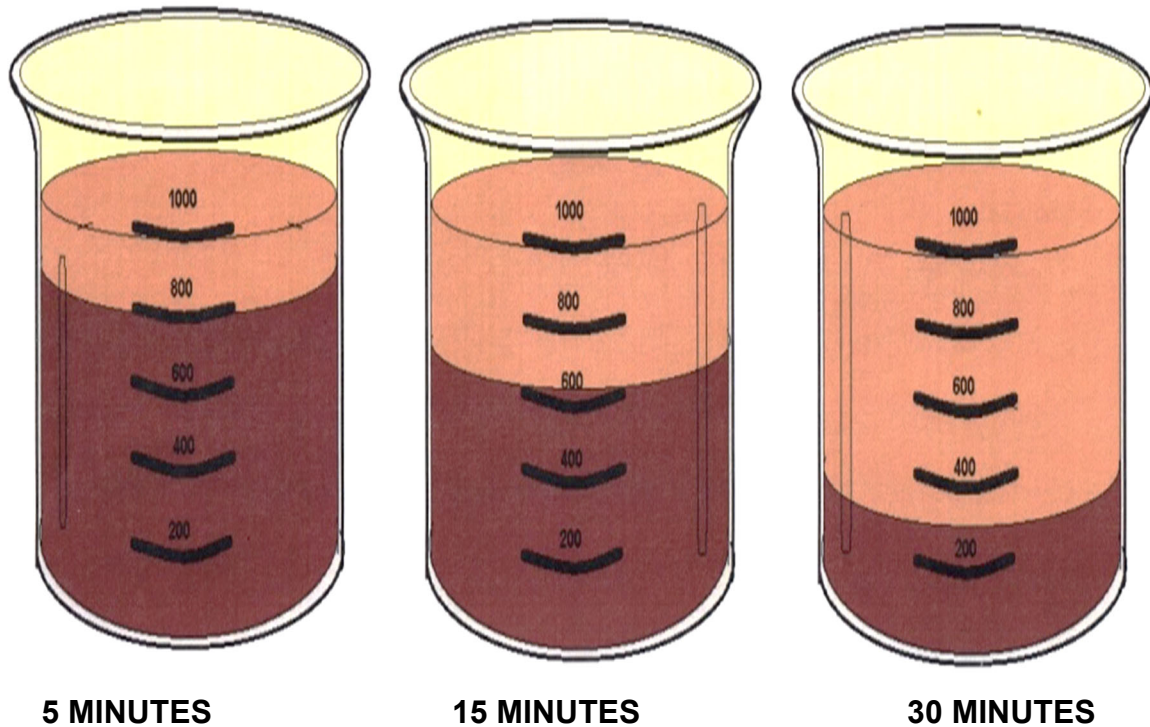

MIXED LIQUOR SAMPLES

The lighter blown color in the above diagram represents the clear supernatant, the darker brown color represents settled sludge.

SSV30 and SSV60

Activated sludge process control calculations may include determination of the thirty and sixty minute settled sludge volume (SSV30 and SSV60), sludge volume index (SVI) and pounds of waste activated sludge removed from the process. The sample jars shown are 1,000 milliliters. 2,000 milliliters jars are better.

Nitrification is a microbial process by which ammonia is sequentially oxidized to nitrite and then to nitrate. The nitrification process is accomplished primarily by two groups of autotrophic nitrifying bacteria that can build organic molecules by using energy obtained from inorganic sources—in this case, ammonia or nitrite.

Denitrification is the process by which nitrates are reduced to gaseous nitrogen by facultative anaerobes. Facultative anaerobes, such as fungi, can flourish in anoxic conditions because they break down oxygen containing compounds to obtain oxygen.

Nitrite (NO_2) and nitrate (NO_3) are oxygen-containing compounds.

Factors that Influence the Flow Rates of Return Activated Sludge

Credit to State of Wisconsin #2 and #3

30 - Minute Settling Test

A sample of mixed liquor is taken as it exits the aeration tank. It is mixed, and then allowed to settle for 30 minutes in a 1000 mL beaker or cylinder. This test shows the sludge settling characteristics and the clarity of the water on top of the sludge. It reflects the performance of the secondary clarifier and can be used to help diagnose clarifier settling problems.

Bulking

An activated sludge that does not settle well and may overflow the weirs of the final clarifiers resulting in excess suspended solids in the effluent. It is usually caused by filamentous organisms, and often associated with low DO.

Clarifier Sludge Blanket

Solids settle and concentrate in the final clarifiers forming a sludge blanket. The sludge blanket can increase or decrease depending on the detention time and RAS flow rate. The proper RAS flow rate allows for a desired sludge blanket.

Constant MLSS (Mixed Liquor Suspended Solids)

Provided the influent loadings are constant, the operator maintains a relatively constant solids inventory (MLSS level) in the aeration basins for a desired level of treatment. The range of MLSS is typically between 1,500-4000 mg/L.

Denitrification

When RAS flow rates are too low, thick sludge blankets in the final clarifier can result. The operator will often see gas bubbles from nitrogen gas and rising/floating sludge clumps on the clarifier surface.

Extended Aeration Activated Sludge Plants

For extended aeration activated sludge plants the range of sludge age is between about 15 and 30 days. Generally, during the winter months, higher sludge ages are required to maintain a sufficient biological mass. In the summer time, biological activity increases and lower sludge ages normally produce a higher quality effluent. Thus, the sludge age should be adjusted at least twice a year to accommodate seasonal variations. The operator must realize, however, that the optimum sludge age may not fall in the common ranges given here. This is due to the fact that the waste characteristics, process design, flexibility in operation, and process control equipment are different for all facilities. The operator, by trial and error and slow adjustments can find the optimum sludge age for that particular plant and specific conditions.

A low sludge age tends to produce a light, fluffy, buoyant type of sludge particle commonly referred to as straggler floc, which settles slowly in a final clarifier. This will be witnessed in a clarifier when these buoyant, fluffy sludge particles are being pulled over the weirs even though the effluent may be otherwise crystal clear.

A high sludge age or too many solids in the system tends to produce a darker, more granular type of sludge particle, commonly called pin floc, which settles too fast in a final clarifier. Pin floc is observed as many fine tiny floc particles coming over the final clarifier weirs, leaving a more turbid effluent.

Filaments

Filamentous organisms are a group of thread-like organisms that, when in excess, can impair the settling of activated sludge and create a bulking condition in the final clarifier.

Final Clarifier Solids Loading Rate (SLR)

The rate at which the activated sludge is returned from the final clarifiers to the aeration basins, along with the influent flow, effects the flow of solids into the clarifiers. Aeration basin mixed liquor suspended solids must have sufficient time to settle and be returned or wasted in the activated sludge system. Clarifiers are designed for certain solids loading rates that should not be exceeded.

The solids loading rate (SLR) is the quantity of solids that can be removed by a secondary clarifier per square foot of surface area. An increase above the design SLR will likely result in an increase in solids leaving the clarifier. For secondary clarifiers that follow an activated sludge system the solids loading rate should fall in the range of 12 to 30 pounds of solids per day per square foot of clarifier surface area. Depending on the textbook you reference, you will see a somewhat different range for the SLR.

Food –To- Microorganism Ratio (F/M Ratio)

For microbiological health and effective treatment, the microorganisms (mixed liquor suspended solids) under aeration should be maintained at a certain level for the amount of food (influent BOD) coming into the plant. This is known as the food to microorganism ratio. For conventional activated sludge, the F/M ratio is usually between 0.2-0.5. For extended aeration systems, such as package plants and oxidation ditches, the F/M ratio should be between 0.03-0.10.

Hydraulic Load

Hydraulic load is the flow entering the plant, measured in million gallons per day (MGD).

Oxidation Ditch

An oxidation ditch is a modified activated sludge biological treatment process that utilizes long solids retention times (SRTs) to remove biodegradable organics. Oxidation ditches are typically complete mix systems, but they can be modified to approach plug flow conditions. (Note: as conditions approach plug flow, diffused air must be used to provide enough mixing. The system will also no longer operate as an oxidation ditch). Typical oxidation ditch treatment systems consist of a single or multichannel configuration within a ring, oval, or horseshoe-shaped basin.

Because of their oval shape, oxidation ditches are called “racetrack type” reactors. Horizontally or vertically mounted aerators provide circulation, oxygen transfer, and aeration in the ditch.

Preliminary treatment, such as bar screens and grit removal, normally precedes the oxidation ditch. Primary settling prior to an oxidation ditch is sometimes practiced, but is not typical in this design.

Tertiary filters may be required after clarification, depending on the effluent requirements. Disinfection is required and reaeration may be necessary prior to final discharge. Flow to the oxidation ditch is aerated and mixed with return sludge from a secondary clarifier.

Pin Floc

Very fine floc particles with poor settling characteristics, usually indicative of an old sludge (high MLSS levels).



RAS Line

The A/S basin and secondary clarifier are connected by the RAS line. This connection typically runs from the bottom of the secondary clarifiers to the front of the A/S basins. The purpose of the RAS line is to take the settled, active, biological solids (MLSS) from the bottom of the clarifier and return them to the treatment process. The RAS flow may be between 25 and 125% of the influent flow to the WWTP.

Clarifiers rely on differences in density to separate particles from the surrounding wastewater. Particles that are more dense than water are pulled by gravity to the bottom of the clarifier. Particles that are less dense than water float to the top of the clarifier.

Gravity is not the only force influencing the movement of particles. Drag is created by the particles as they move through the water. They rub against the water which creates friction between the water molecules and the particles. Drag slows the particles down. Currents in the clarifier push particles in different directions. Clarifiers are designed to minimize short-circuiting currents. Another reason, these devices are so expensive.

RAS Concentration

Varying the RAS flow rate will affect the concentration and detention time of clarified solids. Adjusting the RAS pumping rate allows the return of more or less concentrated solids while also increasing or decreasing the depth of the sludge blanket. RAS flow rates can be paced off influent flow rates.

Short-Circuiting

Short-circuiting is an uneven flow distribution in a wastewater tank. Density currents occur in some parts of a tank and the wastewater travel time (detention time) is less than in other parts of the tank.

Slime Bulking

Nutrient deficiency causes stressful conditions for bacteria. Nutrient deficient bacteria are unable to produce proper cell walls and as reaction to stress will produce excess amounts of a slimy, fat (lipid) layer instead of a normal cell wall. Excess organic acids can also cause stress on bacteria and can increase slime bulking. Slime bulking affects sludge settling.

Sludge Age

Sludge age in the activated sludge process is the measure of the mean length of time a particle of suspended solids has been undergoing aeration. This time is expressed in days and is calculated using the pounds of Mixed Liquor Suspended Solids (MLSS) in the aeration basin and the pounds of Total Suspended Solids (TSS) in the influent.

Separating the Suspended Solids (SS)

As the mixed liquor, leaves the aeration tank, it goes to a clarifier to separate the suspended solids (SS) from the treated wastewater.

The concentrated biological solids are then recycled back to the aeration tank, as returned activated sludge (RAS), to maintain a concentrated population of bugs (the team players) to treat the wastewater.

Young and Old Sludge

Young sludge is indicated by excessive white, billowy foam and low MLSS concentration and high food to microorganism ratios.

OLD SLUDGE

Old sludge consists of sludge in which the sludge age is too high to be most effective in a particular activated sludge process. Dark brown foam and a greasy or scummy appearance is an indicator of old sludge. Settling in the clarifier is rapid, but pin floe can be present in the effluent and the effluent is hazy. Old sludge is often associated with a low F/M ratio. To correct for old sludge, it is necessary to increase wasting rates and return less sludge to the aeration basin. This will reduce the amount of solids under aeration, increase the F/M ratio, and decrease the sludge age. Wasting rate changes should be gradual.

An overabundance of dark brown and greasy foam is an indicator of old sludge, which also has a high MLSS concentration and low food to microorganism ratios. The common range for sludge age for a conventional activated sludge plant is between 3 and 15 days.

Straggler Flocc

Small, light, and fluffy floc particles with poor settling characteristics, usually indicative of a younger sludge and/or low MLSS levels.

Washout

Washout is the loss of biomass from the final clarifiers due to high flow or too thick of a sludge blanket

Return Activated Sludge/Waste Activated Sludge Concentrations

Obtaining accurate estimates of the RAs and WAS concentrations can be difficult because sampling location are not representative, pumps may operate intermittently, grab samples don't necessarily reflect changing conditions: composite sampling may change the solids characteristics, and the RAS flow to influent flow ration may be changing.

Fortunately, if the influent and RAS flows are both known, it impossible to calculate the RAS concentration from the MLSS concentrations. RAS compaction and concentration will be limited by the MLSS characteristics. Always verify calculation results by comparing them to the settling and compaction behavior of the MLSS in the settleability test.

Calculation Method

The maximum RAS concentration achievable by the clarifier can be estimated from the settleometer test results. A detailed procedure for conducting a settleometer test is presented later. For the test, a sample of MLSS is collected from the end of the activated sludge basin and is allowed to settle for 30 minutes.

The settleometer mimics how the MLSS settles in the clarifier. A blanket should form in the bottom of the settleometer. After 30 minutes, the volume of the settled sludge is recorded.

If the MLSS is allowed to remain in the clarifier for 30 minutes, then it should compact to the same degree as the MLSS in the settleometer.

If the MLSS concentration is known, then the settled sludge concentration (SSC) is easily using the following formula:

$$SSC_{30} = \left[\frac{\text{Initial Setteometer Volume, mL}}{SSV_{30}} \right] \times \text{MLSS mg/L}$$

Where:

SSC₃₀ = Settle sludge concentration after 30 minutes and

SSV₃₀ = Settled sludge volume after 30 minutes

RAS/WAS Sampling Locations

Ideally, samples should be collected from well-mixed locations that are representative of the system as a whole. Splitter boxes, joiner boxes, flumes, and pump discharges all make excellent sampling locations for determining solids concentrations because they are well mixed.

Waste Activated Sludge Removal

To maintain a stable treatment process, MLSS must be removed on a regular schedule. Mixed liquor suspended solids can be removed from the bottom of the clarifier, from the RAS line, or directly from the activated sludge basin. In the figure below, WAS line is pulling MLSS from the bottom from the secondary clarifiers, which is the most common configuration.

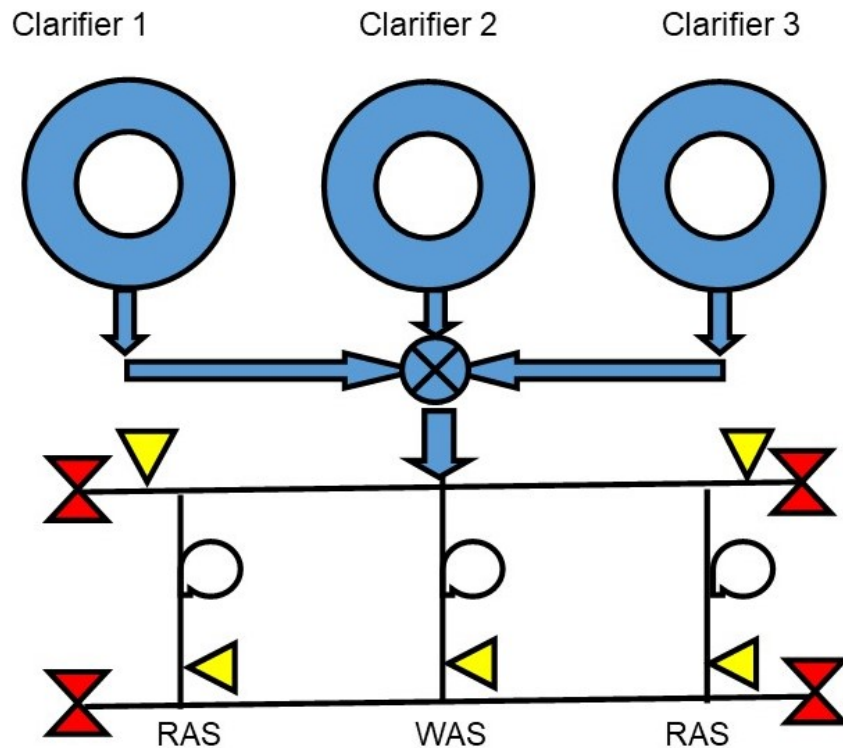

RAS/WAS PUMP GALLERY DIAGRAM

The advantage of pulling MLSS from the bottom of the clarifier or RAS line instead of the activated sludge basin is that the RAS will have a higher concentration in milligrams per liter. This reduces the total volume that must be removed and processed.

Return Activated Sludge Calculation Sub-Section *Credit to US EPA*

The RAS rate may be calculated using a mass balance approach around the secondary clarifier.

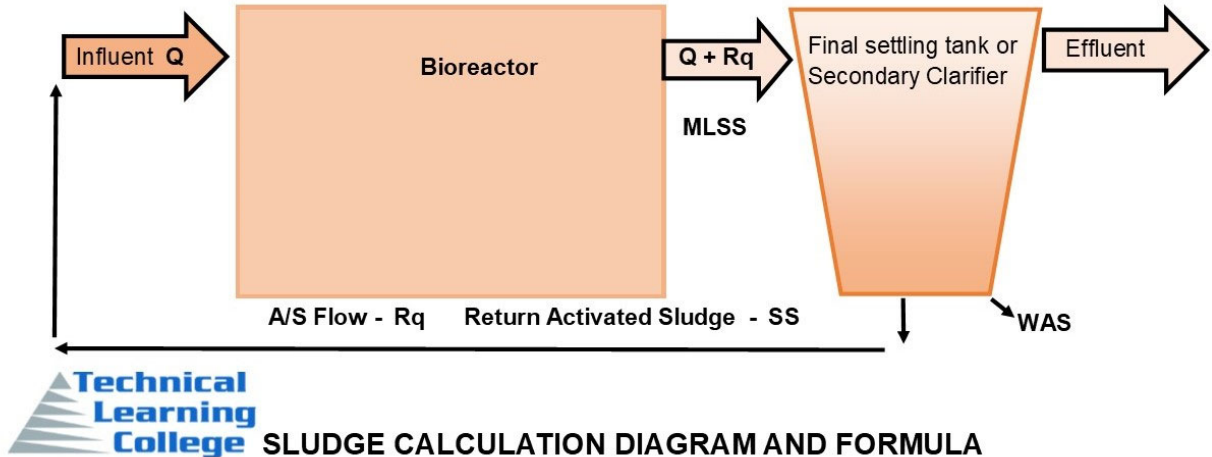

This approach is centered on the thought that in a secondary clarifier the pounds of solids drawn from the clarifier (RAS) must be equal to the pounds of material entering the clarifier (MLSS).

Without detailing all of the algebra involved, using the pounds formula to express pounds of material going into the clarifier, setting that equal to the pounds of material drawn from the clarifier, and solving for the RAS flow rate (R_q) yields the formula:

$$R_q = \frac{Q \times MLSS}{RAS\ SS - MLSS}$$

$$\text{Return Flow Rate} = (Q \times MLVSS) \div (VSS - MLVSS)$$

In the formula, R_q is the calculated Return Sludge flow rate, Q is the influent flow rate, RAS SS is the RAS suspended solids concentration in milligrams per liter, and MLSS is the Mixed Liquor suspended solids concentration in milligrams per liter.

Note that the flow units for R_q will match the units used for influent flow Q ; if Q is given in MGD, R_q will be in MGD. If the operator needs to calculate R_q in terms of percent of influent flow, just use 100 % for Q .

$$R_q, \% = \frac{(100 \% \times MLSS)}{(RAS - MLSS)}$$

Also, note that total suspended solids rather than volatile solids are used in the RAS formula for both RAS and MLSS. This makes sense, since we are concerned with the total amount of sludge in the clarifier rather than just with the biological mass. Keep in mind while using the RAS formula that while this calculation may provide a good starting point or a check for the RAS rate, the most practical means of controlling the RAS rate is by actual sludge blanket measurement.

RAS metering and control is another area in which the operator needs to be vigilant when a new facility is being designed, or an existing plant expanded.

The additional capital costs associated with meters and valves is usually money well spent when the operational difficulties existing at some facilities without these aids is considered.

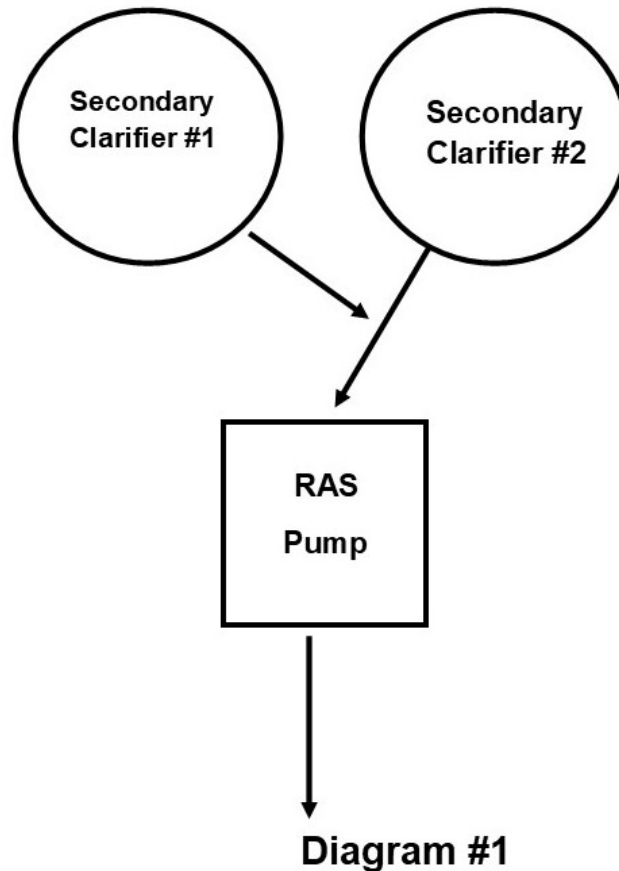

What are the chances of controlling sludge blankets?

Consider RAS control in the schematics above. In diagram #1, the RAS lines from the two clarifiers are tied into a common pipe to the RAS pump.

If there is no provision for controlling flow or metering flow from either of the clarifiers; sludge blankets would be very difficult to control. The feed from the clarifiers would easily become unbalanced.

The rule of thumb is never allow the sludge blanket to reach more than 25 percent of the clarifier sidewall. By allowing a deeper sludge blanket, the operator may encounter troubles with blanket washout due to excess flows (heavy rain event) or denitrification (sludge too long in the clarifier).

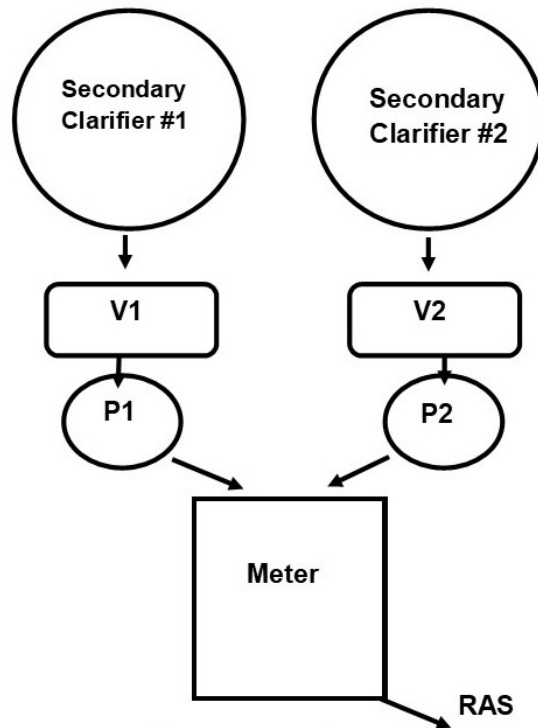

Diagram #2

If we divide the meter reading in half, will we get the flow rate for each clarifier?

In diagram #2, each clarifier has its own RAS flow control valve and pump. The two pumps discharge into a common pipe where the flow is metered. This is a better situation, allowing the operator to vary the amount of RAS from each clarifier, but since the meter only measures the total flow from the two clarifiers, it will be very difficult to balance the RAS flow.

Even with equally sized pumps and with the control valves set the same, the RAS pumped from the two clarifiers will not be the same, since the hydraulic head pumped against will be different for each pump.

Pumps can vary in pumping rates as they age or due to differences in their supply and discharge piping. Installing a meter on the pipe from each clarifier rather than on the combined flow would provide better control, but adjusting the flow from one clarifier would still affect the flow from the other.

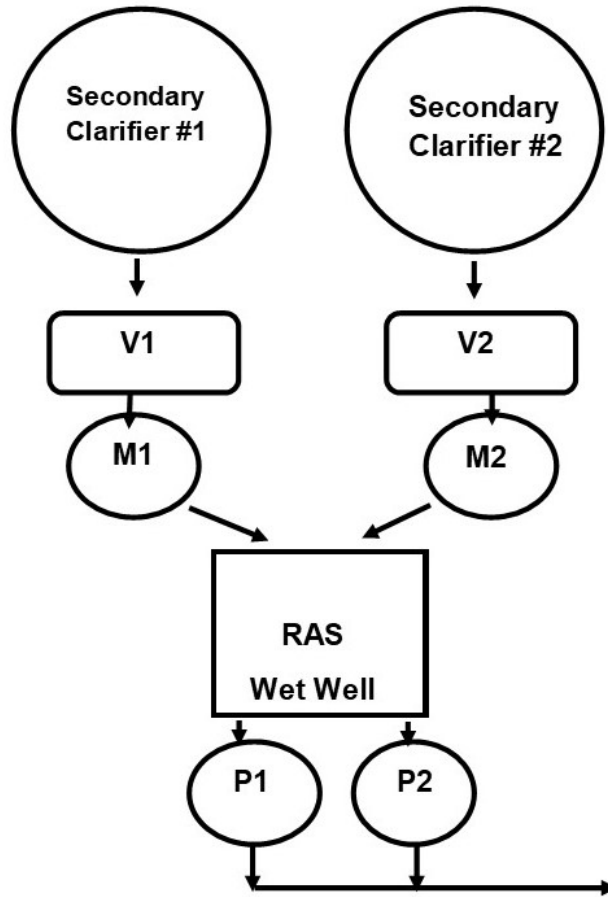

Diagram #3

Diagram # 3 represents the best approach. RAS from each clarifier flows through a control valve and flow meter to a wet well, where a set of pumps draws from the wet well. This arrangement allows the operator to make adjustments to the RAS flow from each clarifier as needed. If the common RAS flow goes to separate aeration tanks, then separate control valves and meters for each tank should also be part of the system.

Biomass Settleability

The three steps of biological wastewater treatment are: Transfer, Conversion, and Flocculation and Separation.

Even though the first two steps may take place effectively, without the ability to separate the biomass from the wastewater the process will not function. The organisms must combine into properly sized particles that have sufficient density to allow them to sink to the floor of the secondary clarifier. The biomass must compact well enough that the sludge blanket does not occupy an excessive amount of space in the clarifier or solids may be lost in the effluent.

Waste Activated Sludge (WAS) Calculations *Credit to US EPA*

Waste activated sludge is excess sludge that is intentionally removed from the process. For every 1 kg (2.2 lbs) of BOD that is added to the activated sludge basin, the bacteria feeding on it will produce about 0.6 kg of new bacteria (Metcalf and Eddy Inc./AECOM 2014). This is also equivalent to about 0.4 kg of new bacteria for every 1 kg of chemical oxygen demand (COD).

Yield

The *Yield* will vary somewhat depending upon the type of organic material available and whether oxygen, nitrite, or nitrate is being used by the bacteria. In addition, inert material is being added to the activated sludge basins every day by the influent wastewater. If these solids aren't being removed from the treatment system periodically, the MLSS concentrations will gradually increase.

Regular MLSS Removal

To maintain a stable treatment process, MLSS must be removed on a regular schedule. The MLSS is usually removed from the bottom of the clarifier or from the activated sludge basin. The MLSS removed is renamed as WAS. Some clarifiers have separate pipelines for RAS and WAS. In other cases, WAS is pumped out of the RAS pipeline.

Wasting Rates

Cell Residence Time (CRT) is defined earlier in this section as the average length of time in days that an organism remains in the secondary treatment system. The operator determines the operating CRT for the facility and maintains it through wasting the appropriate amount of excess biomass (Waste Activated Sludge, WAS) from the secondary system. In other words, the amount of biomass (MLSS) in the secondary system is controlled and maintained through solids wasting.

In nearly all activated sludge plants, wasting is accomplished by directing a portion of the return sludge to the solids handling facility. Wasting return sludge rather than mixed liquor minimizes the volume of water that must be processed by the sludge thickening/dewatering equipment.

While it may be best to waste these solids continuously to achieve maximum system stability, this is often not possible due to plumbing and time constraints. If intermittent wasting is practiced, it is usually best to waste over as long a time period as practical, and when the loading on the secondary system is at the low point of the day.

Drastic changes should not be made in wasting rates from one day to the next; allow the biological system time to acclimate to a change before another change is made. Consistency is a key element in successful activated sludge plant operation.

Many activated sludge plants were originally designed to waste secondary solids into the primary clarifiers. The reasoning was that as the less dense biological solids co-settle with the heavier primary solids the combined sludge density would be increased.

The problem which often results from this arrangement is that much of the biological solids do not settle in the primary clarifier and end up back in the aeration tank, increasing CRT and often causing operational problems. A more efficient operation will result if the WAS is wasted directly to a solids handling process and not allowed to return to the treatment system. It is crucial that adequate solids concentrating equipment and solids storage capability are part of an activated sludge plant.

Secondary sludge wasting is one of the most important controls available to the operator because it controls the most important aspect of treatment, biomass population. Unfortunately, control of wasting is limited in some facilities by poor design.

Inability to return sludge and waste at the same time, WAS piping being too large or too small, and inadequate or non-existent WAS flow metering capability add to the level of difficulty in operating some plants. Again, it is very important that system design include adequate WAS control and metering equipment.

A good WAS control situation is one that allows the operator to set a totalizer which determines the maximum number of gallons wasted in a particular day and also allows the operator to control and monitor the WAS flow rate.

In determining an appropriate WAS rate, we need to return to the CRT relationship:

$$\text{CRT (days)} = \frac{\text{Lbs of MLVSS in aerators}}{\text{Lbs/day WAS VSS}}$$

Environmental Conditions

Waste activated sludge flow, along with environmental conditions such as water temperature and accessibility to BOD, nutrients, and oxygen, influences the process biology and level of treatment achieved. Slower growing microorganisms, including the nitrification bacteria and some bacteria and some filaments, can only remain in the treatment process if the MLSS is held long enough for them to reproduce.

Sludge Settling

Waste activated sludge determines how long the MLSS stays in the system and, therefore, helps to determine which type of microorganisms will be present. The presence or absence of filaments will influence how fast the sludge settles in the clarifier. Waste activated sludge also determines the MLSS concentration. Higher wasting rates leave fewer solids in the system. Sludge age calculations and the relationships between sludge age and other operational parameters will be covered soon.

In summary, the WAS...

- Determines the sludge age.
- Controls mass of total solids in the activated sludge basins.
- Influences sludge quality/settleability.
- Influences growth rate of microorganisms.
- Influences the types of microorganisms that have the opportunity to proliferate, and...
- Influences effluent quality.

Mixing

Credit to US EPA #4, #35, & #10

In the activated sludge process, mixing is important for maintaining the MLSS in suspension. In most functions, the aerators serve as both oxygen-transfer devices and mixers. With the exception of the effluent end of plug flow basins, oxygen requirements normally control aerator design and operation. In other words, more air is needed by the bugs than is needed to keep the MLSS in suspension. However, at the effluent end of plug flow basins and in some low-loaded, completely mixed systems, mixing may be the controlling factor, especially during low flow conditions.

In most cases, the aeration system is used for mixing in these situations: however, use of low-speed, submerged propeller, horizontal mixing devices (such as banana blade mixers) to move mixed liquor horizontally along the basin is another option.

Return Activated Sludge Systems

The RAS system pumps the settled sludge, thickened in the clarifier, from the clarifier back to the activated sludge basin. Most RAS pumping stations use centrifugal pumps for this application. For intermediate-sized facilities, the pumps are often connected directly to the sludge withdrawal pipes. In larger facilities, a wet well may be provided. In this case, sludge is transferred from the clarifier to the wet well (typically by gravity) and then RAS is pumped from the wet well back to the front of the activated sludge basins. Screw pumps are also used in many WWTPS.

Waste Activated Sludge Systems

All activated sludge processes must have a WAS system to remove excess MLSS from the system. Waste sludge may be wasted from the clarifier under flow (sludge blanket) or directly from the activated sludge basins. Most WAS pumping stations use centrifugal pumps, but diaphragm pumps, plunger pumps, and progressing cavity pumps are also used. The other non-centrifugal pumps are positive displacement, and more easily flow-modulated. The RAs and WAS pumping systems may include some type of flow measuring device such as a magnetic flow meter.

Recirculation Pumping

Activated sludge systems that must remove ammonia, nitrite and nitrate often contain internal mixed liquor recycle (IMLR) pumps. These pumps cycle nitrite and nitrate-rich MLSS from the end of aerated zones back to anoxic zones. Mixed liquor recycling is typically accomplished by low-head, submersible non-clogging pumps, or non-clogging vertical turbine pumps. Constant-speed pumps are typically used because it is not essential that recycle flows match or follow influent flows. Recycle pumps are typically large enough to pump between 50 and 400% of the WWTP's rated flow capacity.

Process Variables of A/S Basins

A/S is extremely flexible and can be manipulated to meet a variety of process goals. Operators can influence MLSS microbiology, settleability, and final effluent quality by adjusting five process variables; the number of basins and clarifiers in services, the quantity of WAS removed from the system each day, the RAS, the availability of oxygen, and, in some systems, influent flows. These five process variables give the operators an immense amount of control over sludge settleability, the level of treatment achieved, and final effluent quality.

Other factors that can affect activated sludge performance include temperature, pH, alkalinity, and the characteristics of the influent wastewater.

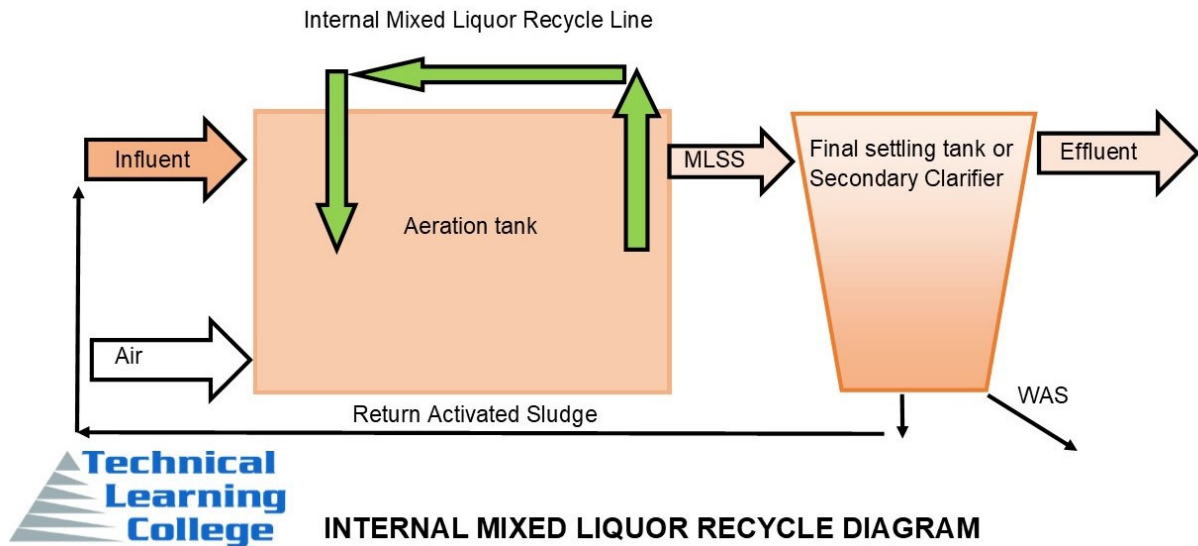

Monitoring of Sludge Settleability

While watching the sludge blanket, the activated sludge solids inventory, and the plant influent flow variations can provide a general understanding of the clarifier performance, it is also very advantageous to track changes in activated sludge settleability.

As mentioned previously, primary and secondary sludge blanket depth and settleability do not fluctuate significantly under steady state influent flow and load conditions. A sudden increase in sludge blanket depth in the secondary clarifiers at typical influent flows and loads and properly operating sludge withdrawal pumps usually indicates deterioration of sludge settleability. There are a few widely-used parameters and procedures for determining activated sludge settleability.

Sludge settleability is central to the health of the biological system. Settleability is influenced by conditions in the activated sludge basin but manifests itself in the clarifier. Poor settling sludge causes lower solids concentration, requiring higher RAS rates to maintain a given MLSS in the activated sludge basin. Consequently, measuring sludge settleability is fundamental to the operation and control of the biological system.

Historically, the Sludge Volume Index (SVI) has been used most commonly as a measure of sludge settleability. It is defined as the volume in milliliters occupied by 1 g of the suspended solids following 30 min. of unstirred settling of the aeration basin MLSS. The test may be carried out in a 1 or 2 L settling column. It is expressed as follows:

$$\text{SVI (mL/g SS)} = \frac{V_{30} \cdot (1,000 \text{ mg/g})}{(X \cdot V_t)}$$

Where, V_{30} = Sludge volume after 30 min. of settling, mL; X = Mixed liquor concentration before the test, mg/L; V_t = Volume of settling column, L.

Hydraulic Detention Time

Hydraulic detention time is also referred to as the HDT or simply detention time (DT). You may also see this as Hydraulic Retention Time (HRT).

Hydraulic detention time (HDT) also known as hydraulic retention time (HRT) is a measure of the average length of time that a compound (in this case wastewater) remains in a treatment tank or unit.

Simply stated, if you started to fill a tank with wastewater the detention time is the average amount of a time that a drop of that water will remain in the treatment tank before the tank fills and that drop of water flows out of it. This is important because as wastewater passes through a treatment tank it must stay in the tank for the necessary period of time in order to be adequately treated.

For example, in most aeration treatment systems, 4 to 8 hours of detention time is necessary in order for the microorganisms in the aeration system to absorb, adsorb and remove the contaminants (bacteria food) in the wastewater.

The HDT can be

- 1) the time required to fill a vessel,
- 2) the time required to empty a vessel, or
- 3) the average amount of time that water remains in a vessel.

Operators have limited control over the HDT, but opportunities may exist for placing additional basins and clarifiers into service or removing them from service.

The formula for DT is...

$$\text{Detention Time, hr} = \frac{\text{Volume, gal} \times 24 \frac{\text{hr}}{\text{day}}}{\text{Flow} \frac{\text{gal}}{\text{day}}}$$

Return Activated Sludge – Clarifier Control Variable

Reference - State of Michigan #1

Return activated sludge is perhaps a clarifier process control variable rather than an activated sludge basin control variable. It is included in this section to keep the descriptions of RAS and WAS together and, hopefully, minimize confusion surrounding the function of each of these important process control variables.

Return activated sludge, along with the influent flow, pushes MLSS from the activated sludge basin into the secondary clarifier.

The mass of MLSS (kilograms or pounds) entering the secondary clarifier is the Solids Loading Rate (SLR).

The SLR is expressed as pounds of solids per square foot of clarifier surface.

The SLR may be calculated according to the following formula:

$$SLR = \frac{\left(Q + Q_R \frac{MG}{day} \right) \times MLSS \frac{mg}{L} \times 8.34 \frac{lb}{gal}}{SA, ft^2}$$

Q is the influent flow rate in units of million gallons (MG) per day

QR is the return activated sludge flow rate in units of million gallons per day (MGD)

SA is the surface area of the secondary clarifiers (be sure to account for all of the clarifiers in service)

MLSS is the mixed liquor suspended solids concentration

Desired Finished Effluent

Credit to US EPA #10, #11, & #18

Activated Sludge facilities are designed based upon the characteristics and quantity of the wastewater being treated and the desired finished effluent quality.

The following chart on the next page lists the quality of the influent for seven types of A/S biological treatment and what to expect for removal of BOD based on retention time. The secondary treatment stage involves adding seed sludge to the wastewater to ensure that is broken down further.

Air is first pumped into huge aeration tanks which mix the wastewater with the seed sludge which is basically small amount of sludge, which fuels the growth of bacteria that uses oxygen and the growth of other small microorganisms that consume the remaining organic matter.

This process leads to the production of large particles that settle down at the bottom of the huge tanks. The wastewater passes through the large tanks for a period of 3-6 hours.

Wastewater comprises of a mix of solids, dissolved matter, particulates, microorganisms, nutrients, heavy metals and micro-pollutants. This complex mix undergoes treatment at wastewater treatment facilities before it is released into the environment as wastewater effluent. Per federal guidelines laid out in the Clean Water Act, state and county water divisions set the physical, chemical and biological limitations on components of this wastewater discharge.

Since the effluents can either be released into the environment or reclaimed for other purposes (potable or non-potable), certain parameters are used to test the quality of the wastewater effluent.

Total Suspended Solids (TSS)

Wastewater particles that are larger than 2 microns in size are categorized under TSS. It is the most widely used method to determine water quality. TSS is the measurement of the total quantity of solid material per volume of water (in milligrams of solids per liter of water (mg/L)) and is determined by weighing the heat dried residue of a filtered water sample.

However, TSS measurement has a few drawbacks. Particles that are water soluble or that are smaller than 2 microns easily escape detection in this method. Also, the mechanism for measuring TSS is time consuming, requires precision and is prone to human error.

Turbidity

Water turbidity is determined by measuring the scattering of visible light as it passes through a water column, where more particles result in more scattering of light. Using the Nephelometric method, scattered light is measured by a photodetector placed at a 90-degree angle from the illumination source. Turbidity is reported via the Nephelometric Turbidity Unit (NTU).

PROCESS TYPE	FLOW REGIME	MLSS (mg/l)	MLVSS / MLSS	FIM (kg BOD 5 days / kg MLVSS)	HRT 0 (hrs.)	VOLUMETRIC		MCRT 0 (days)	$r = \frac{Qr}{Q}$	BOD REMOVAL (%)	kgO ₂ per kg BOD 5 REMOVAL	AIR REQUIRED PER kg BOD 5 (m ³)
						ORGANIC LOADING (kg BOD / 5days m ³)						
1. CONVENTIONAL	PLUG	1500 - 3000	0.8	0.2 - 0.4	4 - 8	0.3 - 0.6	5 - 15	0.25 - 0.5	85 - 95	0.8 - 1.1	40 - 100	
2. TAPERED AERATION	PLUG	1500 - 3000	0.8	0.2 - 0.4	4 - 8	0.3 - 0.6	5 - 15	0.25 - 0.5	85 - 95	0.7 - 1.0	50 - 75	
3. STEP AERATION	PLUG	2000 - 3500	0.8	0.2 - 0.4	3.5	0.6 - 1.0	5 - 15	0.25 - 0.75	85 - 95	0.7 - 1.0	50 - 75	
4. CONTACT STABILIZATION	PLUG	1000 - 3000* 4000 - 10000**	0.8	0.2 - 0.6	0.5 - 10* 3 - 6**	1.0 - 1.2	5 - 15	0.25 - 1.0	80 - 90	0.7 - 1.0	50 - 75	
5. COMPLETE MIX	COMPLETE MIX	3000 - 6000	0.8	0.2 - 0.6	3 - 5	0.8 - 2.0	5 - 15	0.25 - 1.0	85 - 95	0.7 - 1.0	50 - 75	
6. MODIFIED AERATION	PLUG	200 - 500	0.8	1.5 - 5.0	1.5 - 3	1.2 - 2.4	0.2 - 0.5	0.05 - 0.15	60 - 75	0.4 - 0.6	25 - 50	
7. EXTENDED AERATION	COMPLETE MIX	3000 - 6000	0.6	0.05 - 0.15	18 - 36	0.1 - 0.4	20 - 30	0.75 - 1.5	95 - 98	1.0 - 1.2	100 - 125	

DESIGN AND CHARACTERISTIC PARAMETERS OF AN ACTIVATED SLUDGE PROCESS

Plant Design Parameters

The A/S treatment process may be designed and operated to remove CBOD, to convert ammonia to nitrite and nitrate, to remove nitrogen compounds and/or remove phosphorus. A/S operating modes are distinguished by the sludge's age, volumetric loading rate, F/M, and flow pattern. There are many different types of activated sludge system flow designs and classification types

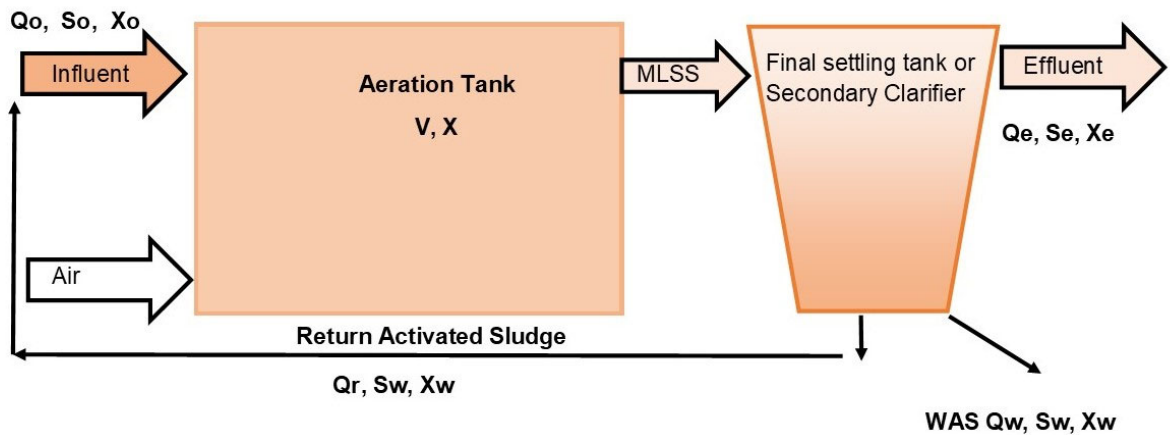

ACTIVATED SLUDGE FLOW DIAGRAM AND PARAMETERS

Legend

- primary effluent biochemical oxygen demand (BOD) concentration, **S_o** , mg/L (g/m³ for S.I.)
- primary effluent suspended solids conc., **X_o** , mg/L (g/m³ for S.I.)
- aeration tank volume, **V** , ft³ (m³ for S.I.)
- aeration tank MLSS (suspended solids conc.), **X** , mg/L (g/m³ for S.I.)
- secondary effluent flow rate, **Q_e** , MGD, (m³/day for S.I.)
- secondary effluent suspended solids conc., **X_e** , mg/L (g/m³ for S.I.)
- secondary effluent biochemical oxygen demand (BOD) concentration, **S_e** , mg/L (g/m³ for S.I.)
- waste activated sludge flow rate, **Q_w** , MGD (m³/day for S.I.)
- waste activated sludge biochemical oxygen demand (BOD) conc., **S_w** , mg/L (g/m³ for S.I.)
- waste activated sludge suspended solids conc., **X_w** mg/L (g/m³ for S.I.)
- recycle activated sludge flow rate, **Q_r** , MGD (m³/day for S.I.)
- Food to Microorganism ratio, **$F:M$** , lb BOD/day/lb MLVSS (kg BOD/day/kg MLVSS)
- Hydraulic retention time, **HRT** , hours (hours for S.I.)
- Sludge retention time (also called sludge age), **SRT** , days (days for S.I.)
- Volumetric loading, **VL** , lb BOD/day/1000 ft³ (kg BOD/day/m³ for S.I.)
- % volatile solids in the aeration tank mixed liquor suspended solids, **%Vol.**

Volumetric Loading Rate

The volumetric loading rate is the mass of BOD₅ added per volume of activated sludge basin per day. The volumetric loading rate is similar to the organic loading rate calculation for trickling filters. The F/M is the mass of BOD₅ added to the activated sludge basin each day divided by the mass of MLVSS in the basin. The flow pattern is how the water moves through the process.

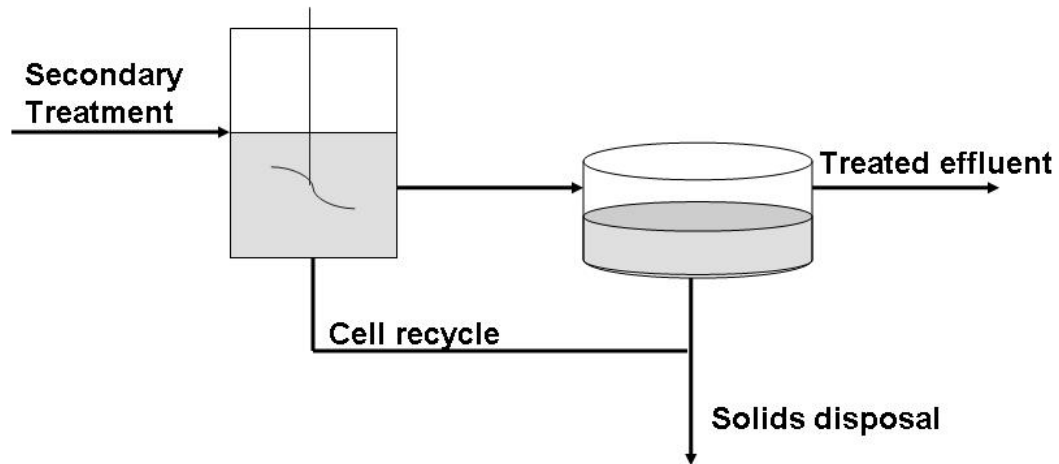

Conventional Activated Sludge Systems

Conventional A/S systems provide BOD₅ removal efficiencies of 85 to 95% and typically carry MLSS concentrations varying from 1,500 to 3000 mg/L. At conventional loading rates, some ammonia removal may occur.

Low-Rate Systems

Low-rate systems are normally used for low flows and are distinguished by high oxygen requirements and low sludge production rates. These systems are considered to be more stable than conventional systems and require less operational attention.

Typically, BOD removal efficiencies range from 75 to 95% and nitrification is complete. However, these systems usually suffer from higher effluent suspended solids concentrations because of poor flocculation (pinpoint floc) and clarifier denitrification.

High-Rate System

High rate systems are often used as pretreatment processes in staged biological treatment systems and are likewise used where only CBOD removal is required. These are characterized by low oxygen demand and somewhat higher than normal sludge production compared to conventional facilities.

The process produces BOD removal efficiencies over a wide range, from less than 50% to as high as 95% depending on loading rates and waste characteristics.

Typical Process Loading Ranges for the Activated Sludge Process Chart

Loading Range	Sludge Age, days	Volumetric loading, Kg BOD ₅ /m ³ (lb BOD/1000 cu ft.)	F/M, kg/kg-d (lb/d/lb)
High rate	1 to 3	1.60 to 16.0 (100 to 1000)	0.5 to 1.5
Conventional	5 to 15	0.32 to 0.64 (20 to 40)	0.2 to 0.5
Low Rate	20 to 30	0.16 to 0.40 (10 to 25)	0.05 to 0.15

Expected A/S Performance Criteria

With typical municipal wastewater, a well-designed and operated activated sludge system should achieve a CBOD effluent quality of 5 to 15 mg/L. Effluent suspended solids should also typically be less than 15 mg/L.

The secondary treatment standards set forth by the US EPA require all mechanical treatment facilities, like activated sludge, to meet effluent BOD and TSS limits of 30 mg/L or less as a 30-day average. Additionally, mechanical treatment facilities are required to remove a minimum of 85% of all influent BOD and TSS. To achieve consistent BOD and TSS concentrations less than 5 mg/L, some type of tertiary treatment may be required.

Design Criteria for Secondary Clarifiers Chart (GLUMRB, 2014; Metcalf and Eddy, Inc. / AECOM, 2014; WEF, 1998)

Parameter	Average Daily Flow	Peak Hourly Flow
Solids loading rate, Kg/m ² ·d (lb/d/sq. ft.)	100 to 150 (20 to 30)	240 (48)
Surface overflow rate, m ³ /m ² ·d (gpd/sq ft)	16.3 to 28.6 (400 to 700)	40.8 to 65.0 (1000 to 1600)
Weir overflow rate, m ³ /m·d (gpd/ft)	N/A	125 (10,000) ^a 375 (30,000) ^b

^a For facilities smaller than 3.79 ML/d (1 mgd).

^b For facilities larger than 3.79 ML/d (1 mgd).

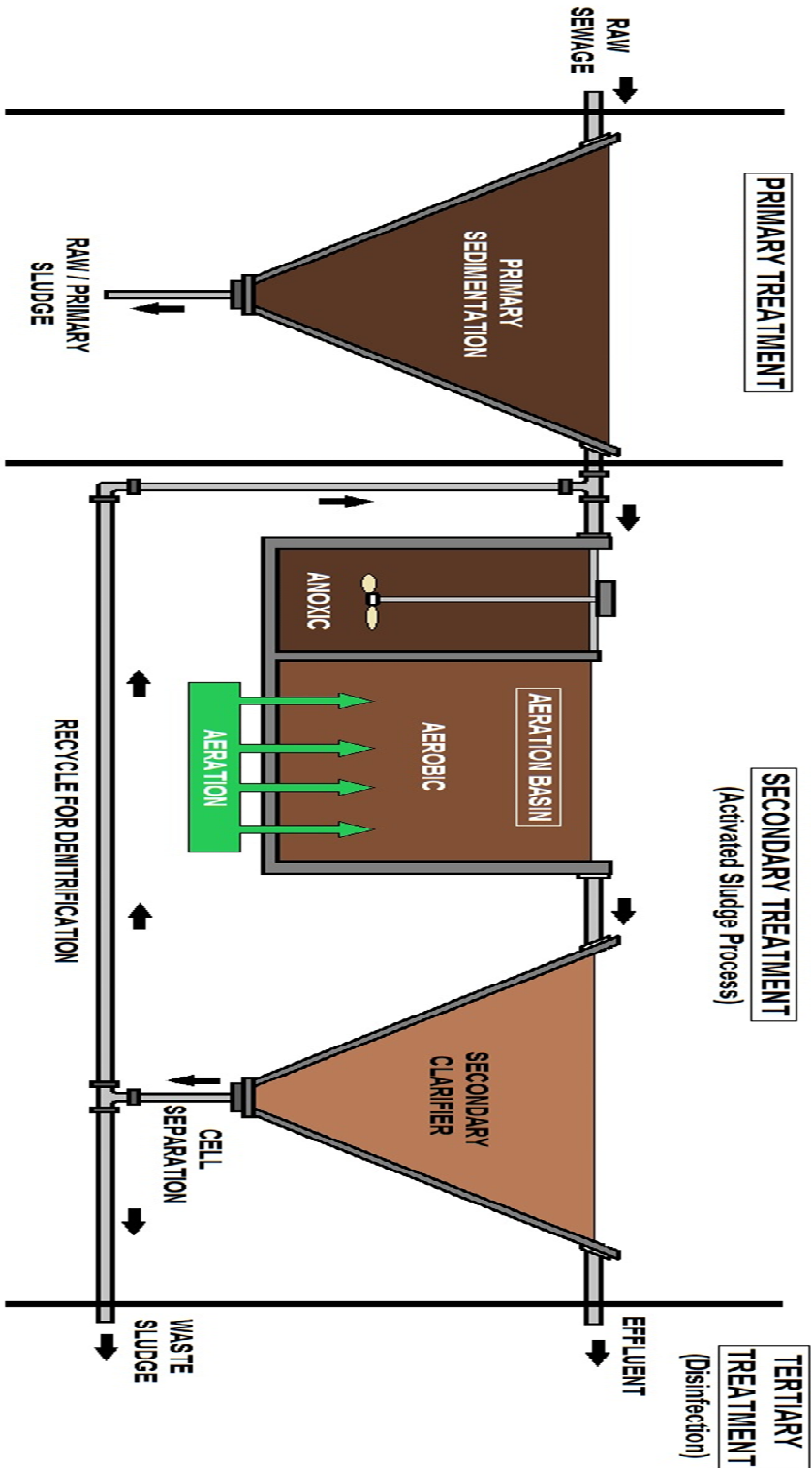

CONVENTIONAL ACTIVATED SLUDGE SYSTEM

More on A/S Performance Criteria

Credit Reference Wisconsin #3

Activated sludge processes may be engineered to remove ammonia, nitrite, nitrate, and phosphorus to extremely low concentrations. Ammonia-nitrogen is often undetectable (below 1 mg/L) in the final effluent of some types of activated sludge processes. Nitrite-Nitrogen concentrations are typically below 0.25 mg/L.

Nitrite-Nitrogen

The chemical formula for this compound is NO_2^- . It is formed in an intermediate step when ammonia is oxidized to nitrates. All of these types of nitrogen can be converted from one form to another. Fresh, cold influent is usually high in organic nitrogen, lower in ammonia, with only traces of nitrates and nitrites. Stale, warm influent will have high concentrations of ammonia and low concentrations of organic nitrogen. As mentioned above, ammonia present in the influent can be converted to nitrite and nitrate-nitrogen in the treatment process through nitrification

Nitrate-nitrogen concentrations below 10 mg/L are easily achieved without the addition of chemicals. Biological phosphorus removal can reduce effluent phosphorus concentrations below 1 mg/L.

Basin Configurations

Basin configuration deals primarily with the hydraulic characteristics of the process. Continuous flow systems are often categorized as "ideal plug flow" or "ideal complete mixed systems, although most operate in a less than perfect low regime somewhere between the two

Ideal Complete Mix

Ideal completely mixed flow implies that the composition of the mixed liquor is the same throughout the basin volume. The influent wastewater immediately and completely mixes with the basin contents so that the concentration of a given component is the same as the effluent concentration.

As a result, the DO, soluble BOD, nitrogen species, pH, temperature, and other characteristics are identical throughout the basin. Completely mixed flow is difficult to achieve, although the use of square or round basins with intense mixing can get very close.

The advantage of the complete-mix process include the dilution of shock loads (e.g., high loads or toxic chemicals, and its relative simplicity compared to other configurations. Shock loads can lead to anaerobic conditions or biomass toxicity. There are several disadvantages to completely mixed basins.

First, they are often plagued by filamentous bulking problems. This can be overcome in part by using selectors, which provide short-term conditioning of the RAS and influent wastewater ahead of the activated sludge basin.

Theoretically, complete-mix processes also suffer because the removal efficiency of the wastewater constituents is lower than in plug flow systems.

Complete mix plants require longer basin detention times and/or the use of basins in series to achieve comparable effluent quality. These systems are often used for low-rate applications or for treating industrial or industrial-municipal wastewater where large variations in load are anticipated.

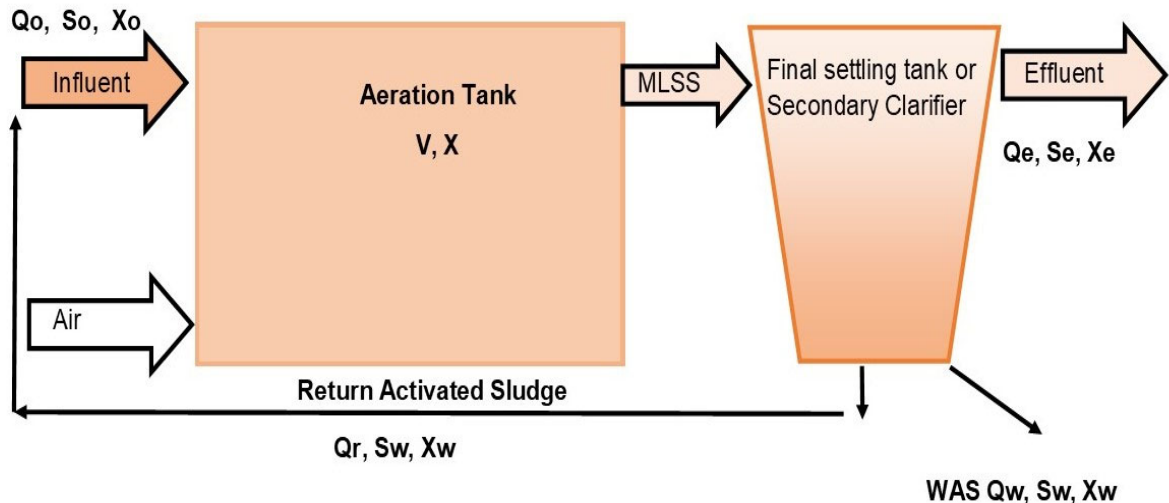

ACTIVATED SLUDGE FLOW DIAGRAM AND PARAMETERS

Legend

- primary effluent biochemical oxygen demand (BOD) concentration, **So**, mg/L (g/m³ for S.I.)
- primary effluent suspended solids conc., **Xo**, mg/L (g/m³ for S.I.)
- aeration tank volume, **V**, ft³ (m³ for S.I.)
- aeration tank MLSS (suspended solids conc.), **X**, mg/L (g/m³ for S.I.)
- secondary effluent flow rate, **Qe**, MGD, (m³/day for S.I.)
- secondary effluent suspended solids conc., **Xe**, mg/L (g/m³ for S.I.)
- secondary effluent biochemical oxygen demand (BOD) concentration, **Se**, mg/L (g/m³ for S.I.)
- waste activated sludge flow rate, **Qw**, MGD (m³/day for S.I.)
- waste activated sludge biochemical oxygen demand (BOD) conc., **Sw**, mg/L (g/m³ for S.I.)
- waste activated sludge suspended solids conc., **Xw** mg/L (g/m³ for S.I.)
- recycle activated sludge flow rate, **Qr**, MGD (m³/day for S.I.)
- Food to Microorganism ratio, **F:M**, lb BOD/day/lb MLVSS (kg BOD/day/kg MLVSS)
- Hydraulic retention time, **HRT**, hours (hours for S.I.)
- Sludge retention time (also called sludge age), **SRT**, days (days for S.I.)
- Volumetric loading, **VL**, lb BOD/day/1000 ft³ (kg BOD/day/m³ for S.I.)
- % volatile solids in the aeration tank mixed liquor suspended solids, **%Vol**.

Sludge Removal Systems *Credit to US EPA*

Operational removal of sludge is vital to process performance. There are two basic types of sludge removal systems, namely plows and hydraulic suction. Plows are used for all types of sludge encountered in wastewater treatment, whereas hydraulic suction is primarily limited to A/S secondary clarifiers.

Hydraulic Section Sludge Removal

For activated sludge systems that remove ammonia, denitrification in the clarifier blanket can cause solids to float and effluent quality to degrade. Hydraulic suction sludge removal systems can remove sludge more rapidly than plow-type systems. Hydraulic suction mechanisms lift solids from across the entire tank radius. There are two fundamentally different types of hydraulic suction removal. The first commonly called an *organ pipe* or *riser pipe* has a separate collector pipe for each suction inlet opening.

V-Shaped Plows

V-shaped plows direct the sludge to the multiple riser pipes. The other type has a single or double arm extending across the full radius of the tank. The arm is tubular and has a number of opening along its length. It is commonly referred to as a *manifold design*, but is also known as a "header", "tubular", or "Tow-Bro", in recognition of Townsend and Brower, who developed it. Both types of hydraulic suction removal work by using pumps or adjustable valves to create a difference in water level (hydraulic head) between the sludge blanket and the location where the sludge is discharged. Large hydraulic head differences result in faster sludge removal.

Depth and Floor Slope

Performance data has shown that deeper secondary clarifiers worked better in activated sludge systems than shallower clarifiers.

Deeper clarifiers had lower effluent suspended solids concentrations and were more resistant to upsets from peak hydraulic loads. In a 1984 survey (Tekippe, 1984), many of the largest engineering firms were designing and building secondary clarifiers with depths of 4 to 5 m (13 to 16 ft). Depths of up to 6 m (20 ft) have been used (Metcalf and Eddy, Inc./AECOM, 2014).

The floors of both primary and secondary clarifiers typically slope toward the sludge collection hopper. Unlike primary clarifiers where the floor slope can vary considerably from one facility to the next, most secondary clarifiers with plot or spiral sludge collection mechanisms have a constant floor slope of 1 to 12. In other words, a clarifier that is 36 ft (12 m) across from the outer wall of the clarifier to the center would have a drop of 3 ft (1m) across that distance.

For hydraulic suction clarifiers, a 1 to 12 slope may also be used. However, because it is not necessary to move the sludge across the floor, relatively flat floors are acceptable. Tow-bro clarifier use a completely flat bottom. Often, a bottom slope of 1 or 2% is provided to make it easier to drain and clean the tank.

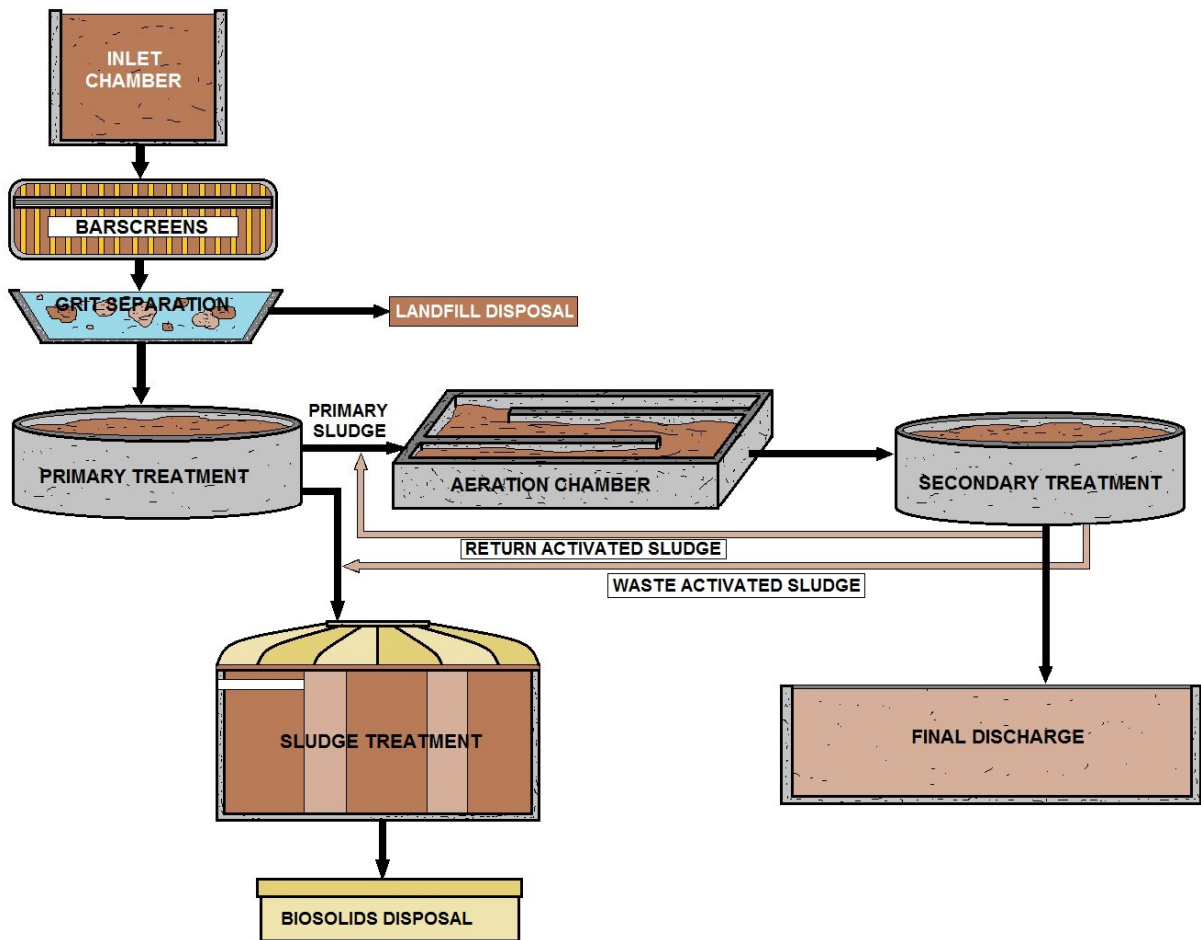

WASTEWATER TREATMENT PLANT (Sludge Removal Basics)



There are various options for treating sludge including stabilization, thickening, dewatering, drying, and incineration. The costs for treating sludge and removing sludge from wastewater are roughly the same. Typically a polymer chemical is used for the volume reduction process known as dewatering. Polymers are slippery chemicals, which means that there is always a risk of slipping or falling due to spills and leaks. Polymers can also be environmental stress crack agents.

Dewatering decreases sludge liquid volume as much as 90 percent. Digested sludge is put through large centrifuges that work in the same fashion as a washing machine spin cycle. The spinning centrifuge produces a force that separates the majority of the water from the sludge solid, creating a biosolid substance.

Review of Quality Process Goals

Credit USEPA #4

As previously noted, the activated sludge process can be used to remove carbonaceous BOD and also ammonia (nitrification). We can separate the wastewater oxygen demand separated into two categories: carbonaceous and nitrogenous.

Carbonaceous BOD Removal

The carbonaceous biochemical oxygen demand should be expressed as a function of the number of days that the demand will be measured; 3-day, 5-day (most common), 7-day, and 20-day time periods are commonly used. To obtain only carbonaceous oxygen demand, it may be necessary to inhibit nitrification by adding chemicals.

The rate and extent of BOD₅ (5-day BOD) removal in primary treated (settled) or untreated wastewater depends on the relative quantities of soluble, colloidal, and suspended BOD₅. Soluble BOD₅ content is approximately 20 to 40% of the total. These proportions may vary, particularly in warmer climates where long collection system residence times and the higher wastewater temperatures may result in a higher proportion of soluble BOD₅. This is caused by the bacterial degradation of a portion of the colloidal and settleable fractions during transport in the collection system.

With typical municipal wastewater, a well-designed activated sludge process should achieve a carbonaceous, soluble BOD₅ effluent quality of 5 mg/L or less. Similarly, with clarifiers designed to maximize solids removal at peak flows and adequate process control, the average SS in the effluent should not exceed 15 mg/L.

On a practical basis, an effluent with 20/20 mg/L BOD₅ and SS should be attained, assuming proper operation. Potential capabilities of the process are 10/15 mg/L BOD₅ and SS. To consistently achieve values lower than 10/15 mg/L, some type of tertiary treatment is required.

Nitrification

Of the total oxygen demand exerted by the wastewater, there is often a sizeable fraction associated with the oxidation of ammonia to nitrate. The autotrophic bacteria *Nitrosomonas* and *Nitrobacter* are responsible for this two-state conversion. Being autotrophic, these nitrifying organisms must reduce oxidized carbon compounds in the wastewater, such as CO₂ and its related ionic species, for cell growth. As a result, this characteristic markedly affects the ability of the nitrifying organisms to compete in a mixed culture.

The nitrifying bacteria obtain their energy by oxidizing ammonia nitrogen to nitrite nitrogen and then to nitrate nitrogen. Because very little energy is obtained from these oxidation reactions, and because energy is needed to change CO₂ to cellular carbon, the population of nitrifiers in activated sludge is relatively small. When compared to the normal bacteria in activated sludge, the nitrifying bacteria also have a slower reproduction rate.

Nitrifying organisms are present to some extent in all domestic wastewaters. However, some wastewaters are not nitrified in existing plants because they are designed for the higher growth rate of bacteria responsible for carbonaceous removal. As the Mean Cell Residence Time (MCRT) is increased, nitrification generally takes place.

The longer MCRT prevents nitrifying organisms from being lost from the system when carbonaceous wasting occurs or, more accurately, the longer MCRT permits the build-up of an adequate population of nitrifiers.

Because of the longer MCRT required for nitrification, some systems are designed to achieve nitrification in the second stage of a two-stage activated sludge system. The oxygen demand for complete nitrification is high. For most domestic wastewaters, it will increase the oxygen supply and power requirements by 30 to 40% because complete nitrification requires from 4.3 to 4.6 lb. of oxygen for each lb. of ammonia nitrogen (4.3 to 4.6 mg/mg) converted into nitrate, and wastewaters generally contain 10 to 30 mg/L of reduced nitrogen as ammonia and urea. Nitrification systems generally are not operated at intermediate (40 to 80%) removals; stable operation is achieved when essentially complete nitrification (greater than 90%) occurs.

Minimum acceptable dissolved oxygen (**DO**) concentrations of 2 to 3 mg/L for nitrification have been reported, and nitrification appears to be inhibited when the oxygen concentration is lower than 1 mg/L.

Optimum growth of nitrifying bacteria has been observed in the pH range of 8 to 9 although other ranges have been reported. A substantial reduction in nitrification activity usually occurs at pH levels below 7, although nitrification can occur at low pH.

While nitrification occurs over a wide temperature range, temperature reduction results in a slower reaction rate. The temperature effect is made less severe by increasing the MCRT. During the conversion of ammonia to nitrate, mineral acidity is produced. If insufficient alkalinity is present, the system's pH will drop and nitrification may be inhibited.

Bacteria Highlights Credit USEPA #6

A change in the numbers or predominance of microorganisms in activated sludge is usually gradual. The time required for a complete shift from one species to another is normally in: 2 to 3 MCRT's. Endogenous respiration of microorganisms in an extended aeration plant will complete the oxidation process of an organic material.

The bug *Nocardia* causes frothing. Saprophytic type bacteria produces the most acid in an anaerobic digester. The best location for microscopic examination of activated sludge in a conventional system is at the effluent end of the aeration system. The examination can reveal a predominant number of rotifers and nematodes; this condition may indicate that the F/M ratio is too low, but this would be normal in an extended aeration process.

A large amount of long filamentous bacteria will prevent good settling. The liquid above this mass is called the supernatant.

Food to microorganism ratio. A measure of food provided to bacteria in an aeration tank.

$$\frac{F}{M} = \frac{\text{Food}}{\text{Microorganism}} = \frac{\text{BOD, lbs/Day}}{\text{MLVSS, lbs}} = \frac{\text{Flow, MGD} \times \text{BOD, mg/L} \times 8.34 \text{ lbs/gal}}{\text{Volume, MG} \times \text{MLVSS, mg/L} \times 8.34 \text{ lbs/gal}}$$

$$\text{or} \quad = \frac{\text{BOD, kg/day}}{\text{MLVSS, kg}}$$

Various A/S Designs (Alphabetical Order)

The Bardenpho Process *Credit USEPA #7*

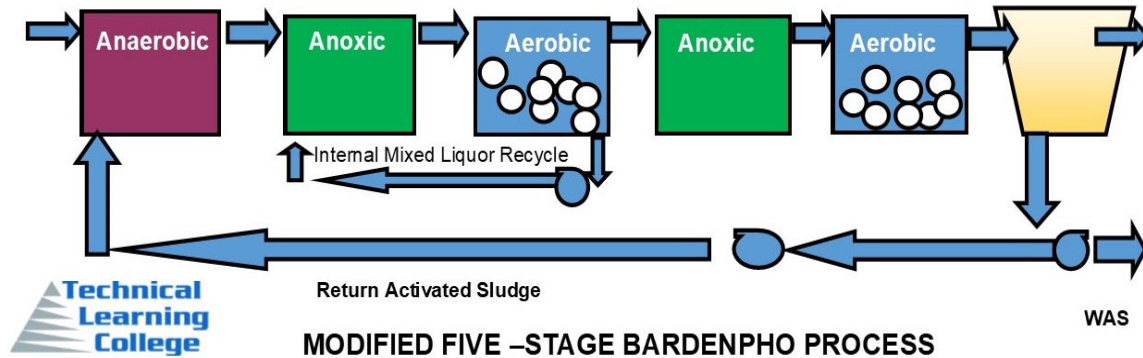

The Bardenpho process was named after its inventor, Dr. James Barnard. His process may be configured with four or five stages. The major difference process is that the Bardenpho process includes an anaerobic zone. Most of the treatment facilities that utilize this process have required supplemental chemical addition (metal salts and/or carbon) to meet the effluent phosphorus limits of less than 1.0 mg/L as P.

BNR occurs in various reactors with anaerobic, anoxic, or aerobic environments to reduce the TN and TP. These reactors can be arranged in various sequences to provide the necessary biological reactions for BNR. Many Florida AWT plants use the modified, or five-stage, Bardenpho process, which consists of the sequence of anaerobic, first anoxic, aerobic, second anoxic, and reaeration zones with an internal recycle from the aerobic to first anoxic zone.

Anaerobic zones provide an environment free of oxygen and oxidized nitrogen to encourage the growth of phosphorus accumulating organisms (PAOs) for enhanced biological phosphorus removal (EBPR). Under anaerobic conditions, the PAOs take up volatile fatty acids (VFAs) – primarily acetic and propionic acids – and release phosphorus, which is then taken up in subsequent aeration zones and removed from the system in the waste activated sludge (WAS). Performance of the anaerobic zone can be affected by insufficient VFAs, recycle of dissolved oxygen (DO) within the return activated sludge (RAS), recycle of excessive phosphorus from sludge handling, and the presence of glycogen accumulating organisms (GAOs) in the mixed liquor.

The first anoxic zone functions as the main denitrification zone. The RAS and internal recycle streams bring nitrate from the aerobic zone into contact with the influent biochemical oxygen demand (BOD). Heterotrophic bacteria convert the nitrate to nitrogen gas while using chemical oxygen to consume a portion of the influent BOD in the process. Some PAOs are also capable of denitrification. Problems with the first anoxic zone of the biological treatment process can stem from insufficient anoxic volume, poor mixing, insufficient carbon, insufficient nitrate recycle, and excessive DO within the recycle stream or surface entrainment. While not a direct cause of insufficient nitrate reduction, a single complete-mix first anoxic reactor will provide less nitrate removal than a series of complete-mix reactors. This creates a complete mix-plug flow hybrid.

Basins-in-Series

The basins-in-series configuration is described as two or more completely mixed basins operating in a series configuration. It can be approximated with baffles or by folding basins. This configuration, with three or more basins-in-series, attempts to simulate a plug flow condition that has a kinetic advantage over mixed-flow systems, as mentioned previously. This configuration also seems to mitigate filamentous bulking.

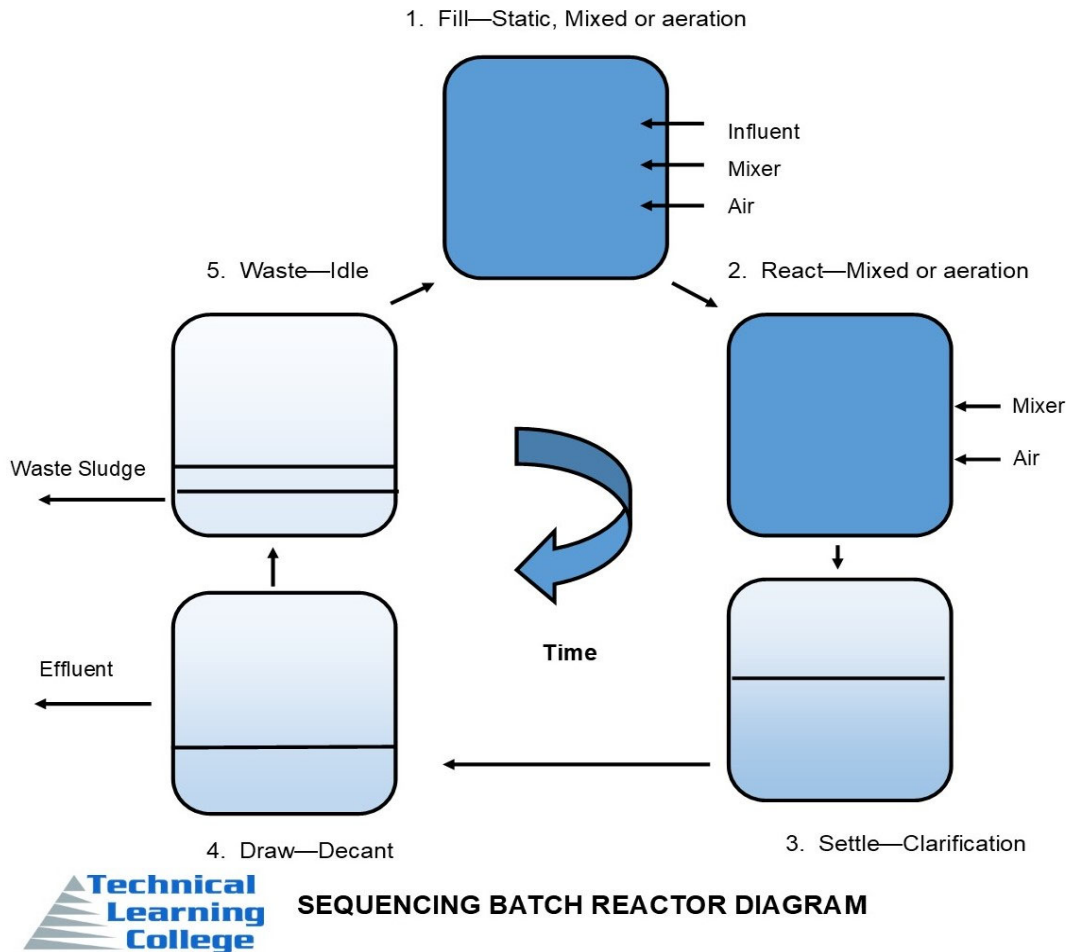

Batch Operation

Sequencing batch reactors are a type of activated sludge system that uses a fill-and-draw. They are usually used in systems to treat wastewater in small batches. Both treatment and clarification are in the same tank. At the end of the treatment cycle, the MLSS is allowed to settle and treated water is decanted off the top of the basin.

Sludge is wasted from the settled sludge blanket. Batch systems behave like ideal plug flow systems with respect to biological process performance: the reaction time for batch systems is interchangeable with the space-time for the plug flow basin.

Complete Mix Activated Sludge Process

Credit # Tennessee Activated Sludge Chapter 7

The complete mix activated sludge process employs a completely mixed flow regime. In a rectangular tank, complete mixing is achieved by distributing the sewage and the return sludge uniformly along one side of the tank and withdrawing the aerated sewage, uniformly along the opposite side. In case of circular or square tank, complete mixing is achieved by mechanical aerator with adequate mixing capacity installed at the center of the tank.

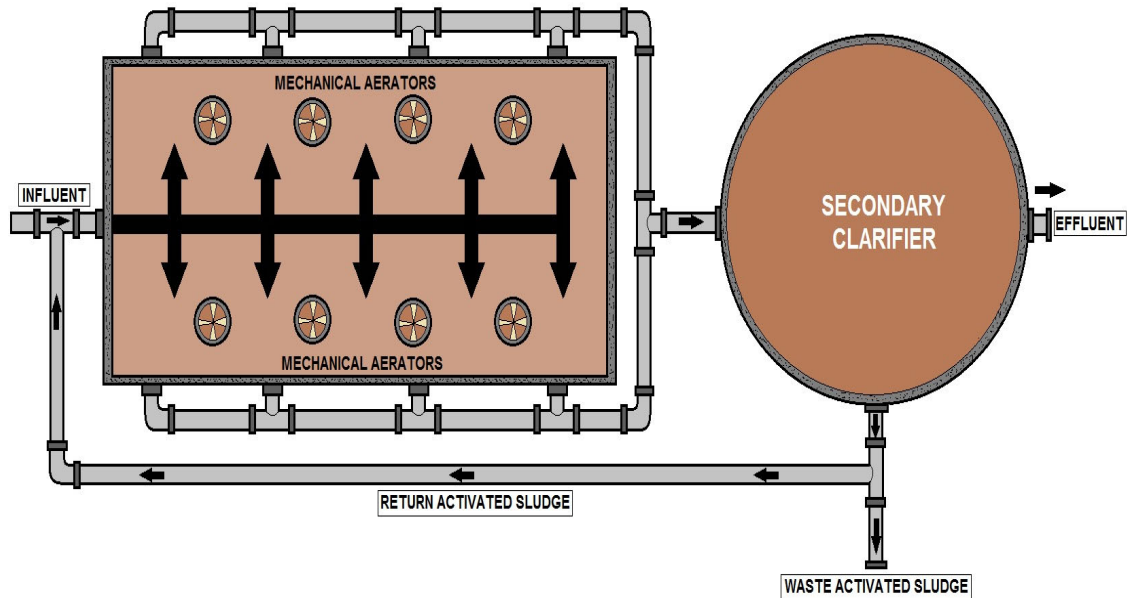

COMPLETE MIX PLANT DIAGRAM

In a complete mix activated sludge process, the mixed liquor is similar throughout the aeration tank. The operating characteristics in terms of solids, oxygen uptake rate (OUR), MLSS, and soluble BOD₅ concentration are identical throughout the tank.

Because the entire tank contents are the same quality as the tank effluent, there is a very low level of food available at any time to a large mass of microorganisms. This is the major reason why the complete mix PROCESS can handle surges in the organic loading without producing a change in effluent quality. The type of air supply used could be either diffused air or a mechanical aerator.

The complete mix process may be resistant to shock loads but is susceptible to filamentous growths.

Contact Stabilization Activated Sludge Process

Credit # Tennessee Activated Sludge Chapter 7

Contact stabilization activated sludge is both a process and a specific tank configuration. The contact stabilization encompasses a short-term contact tank, secondary clarifier, and a sludge stabilization tank with about six times the detention time used in the contact tank.

Contact stabilization is best for smaller flows in which the MCRT desired is quite long.

Therefore, aerating return sludge can reduce tank requirements by as much as 30 to 40% versus that required in an extended aeration system. The volumes for the contact and stabilization tanks are often equal in size because the RAS is more concentrated than the mixed liquor.

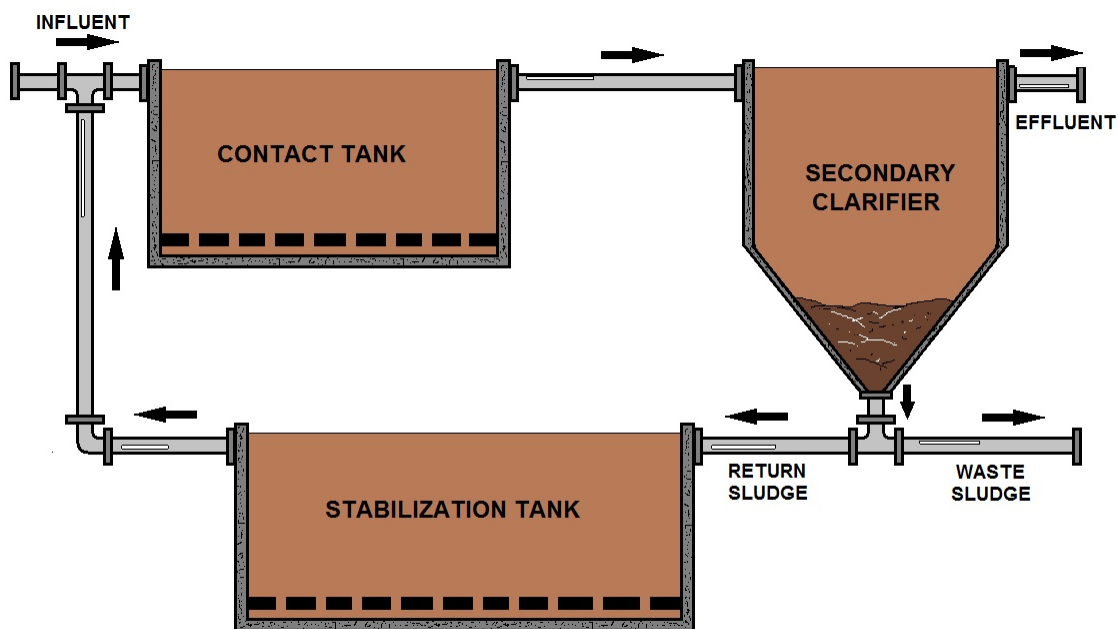

CONTACT STABILIZATION PLANT DIAGRAM

What does this all mean?

If equipped with similar flow piping options, these plants can be operated either in parallel as an extended aeration facility or as a contact stabilization unit. This flexibility makes them suitable for future expansion to conventional activated sludge, without increasing the aeration tank, by merely adding more clarification capacity.

Extended Aeration Activated Sludge Process *Credit to US EPA* *Credit # Tennessee Activated Sludge Chapter 7*

The extended aeration process uses the same flow scheme as the complete mix or plug flow processes but retains the wastewater in the aeration tank for 18 hours or more.

This process operates at a high MCRT (low F/M), resulting in a condition where there is not enough food in the system to support all of the microorganisms present. The microorganisms therefore compete very actively for the remaining food and even use their own cell structure for food.

This highly competitive situation results in a highly treated effluent with low sludge production. Many extended aeration systems do not have primary clarifiers and they are package plants used by small communities.

The main disadvantages of this system are the large oxygen requirements per unit of waste entering the plant and the large tank volume needed to hold the mixed liquor for the extended period.

Flocculating Center Feed Well

In many facility designs, the MLSS arrives at the secondary clarifier without being fully flocculated. The floc can be broken up to some degree by the higher flow velocities found in the pipelines connecting the activated sludge basin to the clarifier. This broken floc may not settle well and result in pieces of floc that are not large enough in the clarifier, causing an increase in the effluent suspended solids. To address this problem, many secondary clarifiers contain a flocculation zone. The goal is to provide an area of gentle mixing within the clarifier to help re-flocculate the MLSS and improve settleability.

The flocculation zone may be created by increasing the size of the center feed well or by adding an outer flocculator center well that surrounds the smaller influent center well. The center feed well helps to slow down the influent flow. The flocculation well keeps the MLSS together for flocculation. Some flocculation wells include mechanical flocculators.

Hybrid Flows

In practice, we rarely see a true plug flow or complete mix reactor. We often have hydraulic patterns that are somewhere in between the two ideal regimes. For example, a long rectangular basin with aeration (either surface or diffusers) often has significant dispersion and back mixing although we have a lag before an influent tracer appears at the effluent, it appears well before $\text{time} = \text{volume}/\text{flow}$.

What makes hybrid systems interesting is as you increase the number of cells or individual areas modeled by continuous stirred-tank reactor (CSTR) flows (occurs near a surface aerator), the overall tracer response appears closer to the plug flow ideal where the tracer reaches the effluent near the design residence time. The hybrid flow is used often because it is a more "natural" flow pattern and provides benefits of both ideal flow systems. To determine a working systems' flow pattern, you can look at spill response data or run a tracer study where a conservative flow-marking tracer is added and monitored at the effluent.

High Purity Oxygen Activated Sludge Process

Credit # 7 Tennessee Activated Sludge Chapter 7& USEPA #10

The most common high purity oxygen activated sludge process uses a covered and staged aeration tank configuration. The wastewater, return sludge, and oxygen feed gas enter the first stage of this system and flow concurrently through the tank.

The tanks in this system are covered to retain the oxygen gas and permit a high degree of oxygen use. A prime advantage of the staged reactor configuration of the oxygenation system is the system's ability to match the biological uptake rate with the available oxygen gas purity and quantity.

The dissolution of oxygen and the mixing of the biological solids within each stage of the system are accomplished with either surface aeration devices or with submerged turbine-aeration systems. The selection of either of these two types of dissolution systems largely depends on the aeration tank geometry selected.

The particular configuration of oxygenation tank selected for a given system, that is, size of each stage, number of stages per aeration tank, and number of parallel aeration tanks, varies. This is determined by several parameters including waste characteristics, plant size, land availability, and treatment requirements.

Aside from the aeration tank, the other key factor in an oxygen activated sludge system is the oxygen gas source. There are three sources of oxygen supply: liquid oxygen storage, cryogenic oxygen generation, and pressure-swing adsorption generation.

The first of these requires no mechanical equipment other than a storage tank that is replenished by trucked-in liquid oxygen. This method is more economically practical for small (less than 4 mgd) or temporary installations.

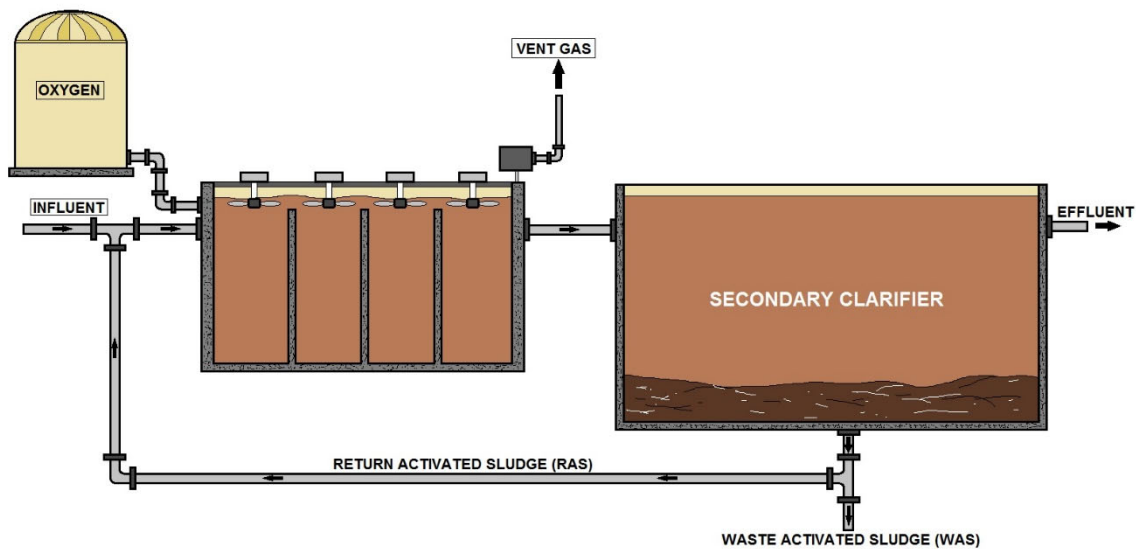

HIGH PURITY OXYGEN PLANT DIAGRAM

Ludzack-Ettinger Process

Reference #11 USEPA

In 1962, Ludzack and Ettinger proposed the addition of an anoxic zone at the head of a conventional aerobic plant to utilize the readily biodegradable substrate (RBCOD) as a denitrification source.

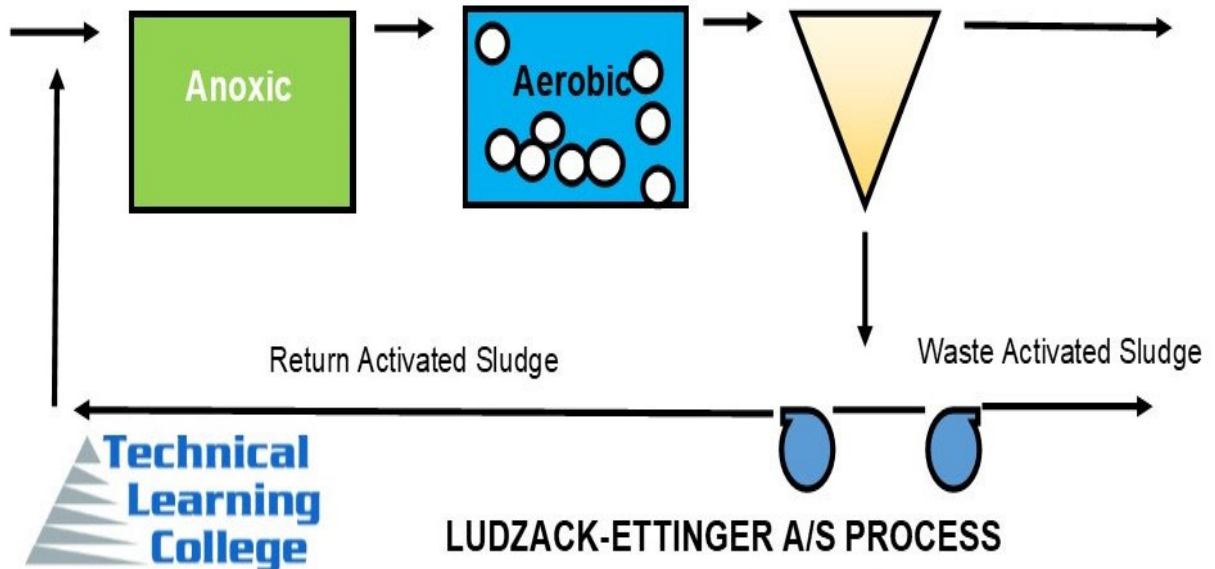

In the early 1970's, James Barnard suggested the addition of a mixed liquor recycle to return nitrate back to the anoxic zone, and named the process Modified Ludzack Ettinger. The MLE is regarded as the first successful nitrogen removal activated sludge process.

The MLE process (unlike earlier attempts such as LE and Wuhrman), achieved robust and efficient removal by satisfying all of the requirements of nitrification and denitrification.

The anoxic zone requires conditions that are free of dissolved oxygen, but needs organic carbon compounds to provide energy (electron donors), the presence of nitrate (electron acceptors) and a facultative biomass (bacteria capable of denitrification) for efficient denitrification.

Modified Ludzack-Ettinger Process

Reference #3 and #11 USEPA

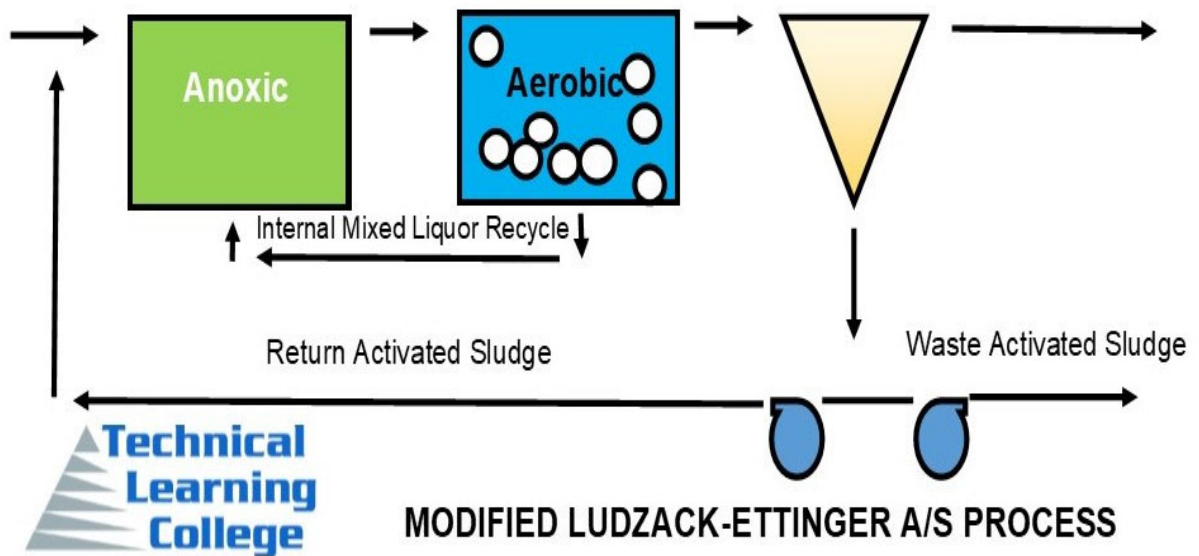

The Modified Ludzack-Ettinger (MLE) process developed for the combination removal of BOD, ammonia, and nitrate/nitrite. The process employs a combination of an anoxic and aerobic zone.

Nitrification (ammonia removal) occurs in the aerobic zone. The mixed liquor, high in nitrate from nitrification, is recycled to the anoxic zone by the internal recycle for denitrification.

Typical IRQ rates range from 200 – 400% of the process influent flow rate. The MLE process can achieve a 6 to 8 mg/l Total Nitrogen discharge, depending upon the wastewater influent characteristics.

Oxidation Ditch Activated Sludge Process

Credit USEPA #12 & #17

The oxidation ditch is a variation of the extended aeration process. The wastewater is pumped around a circular or oval pathway by a mechanical aerator/pumping device at one or more points along the flow pathway. In the aeration tank, the mixed liquor velocity is maintained between 0.8 and 1.2 fps in the channel to prevent solids from settling.

Oxidation ditches use mechanical brush disk aerators, surface aerators, and jet aerator devices to aerate and pump the liquid flow. Combination diffused aeration and pumping devices are commonly used in Europe.

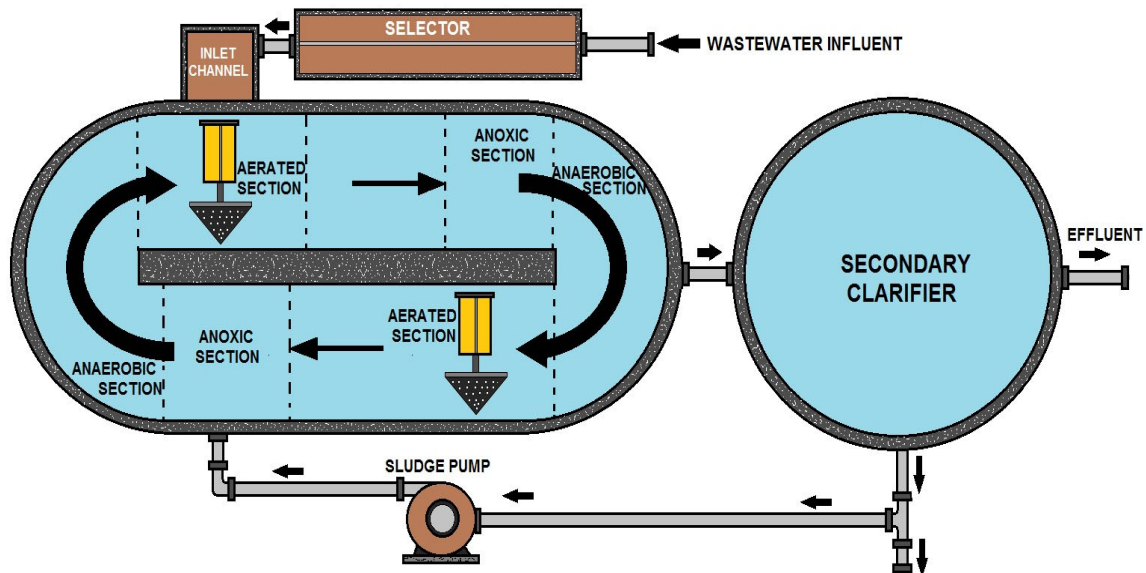

OXIDATION DITCH PLANT DIAGRAM

In the typical oxidation ditch, mixed liquor is pumped around an oval or circular pathway by brushes raptors or other mechanical aeration devices as well as pumping equipment located at one or more points along the flow path.

The mixed liquor is typically moved at a velocity of 0.8 to 1.2 ft/sec. (0.24 to 0.37 m/s) in the channel. Most oxidation ditches are designed as low-rate processes with long detention times (approximately 24 hours).

Oxidation ditches are considered to be completely mixed. Ditches may be designed with a single channel or multiple interconnected channels set inside each other. They are widely used for small-to medium-sized communities.

Peripheral Feed, Peripheral Take-Off Flow Path

Circular clarifiers can be fed by several different inlet configurations. Most clarifiers are fed from the center; however, there are two basic *peripheral* feed alternatives. In the first and second alternative, the influent enters the clarifier on one side and then passes into a wide channel that follows the outer wall of the clarifier.



Holes in the bottom of the channel allow the influent to flow into the clarifier. The channel helps distribute the influent flow over the clarifier surface. Peripheral feed clarifiers may have either center take-off or peripheral.

Plug Flow Activated Sludge Process

References Wisconsin #3 & Tennessee #9

Plug flow tanks are the oldest and most common form of aeration tank. They are designed to meet the mixing and gas transfer requirements of diffused aeration systems. One characteristic of the plug flow configuration is a very high organic loading on the MLSS in the initial part of the tank. The loading is then reduced and the organic material in the raw wastewater is oxidized.

At the end of the tank, depending on detention time, the oxygen consumption may primarily be the result of endogenous respiration or nitrification. The same characteristics are present when the aeration tank is partitioned into a series of compartments.

Each compartment must have the oxygen supply and design to meet the individual compartment needs. Plug flow configurations have the ability to avoid “bleed through,” which is the passage of untreated organics during peak flow.

These configurations are often preferred when high effluent DO's are sought because only a small section of the tank will operate at a high DO. In a complete mix configuration, the entire tank must operate at the elevated DO.

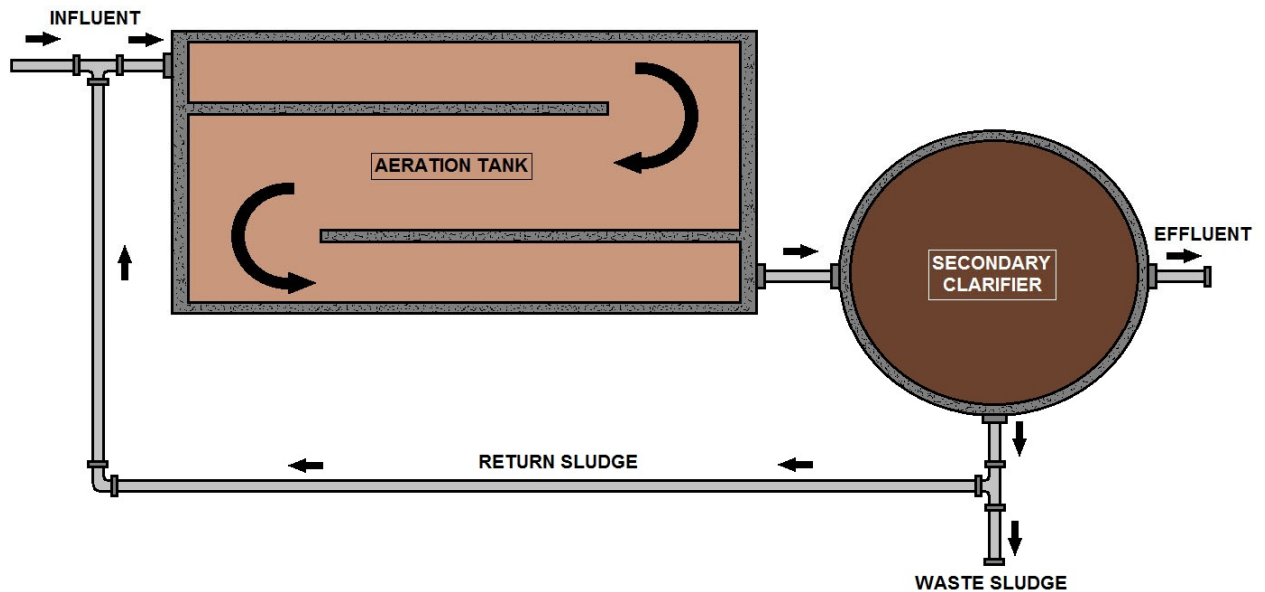

PLUG FLOW PLANT DIAGRAM

Ideal Plug Flow

References Wisconsin #3 & Tennessee #9

In an ideal plug flow system, water entering the basin will move evenly along the basin length with very little mixing. Plug flow is how water moves through a pipe. There is virtually no mixing between the water at the end of the pipe and the water in the middle of the pipe. A particular bit of water will remain in the basin for a time equal to the theoretical detention time.

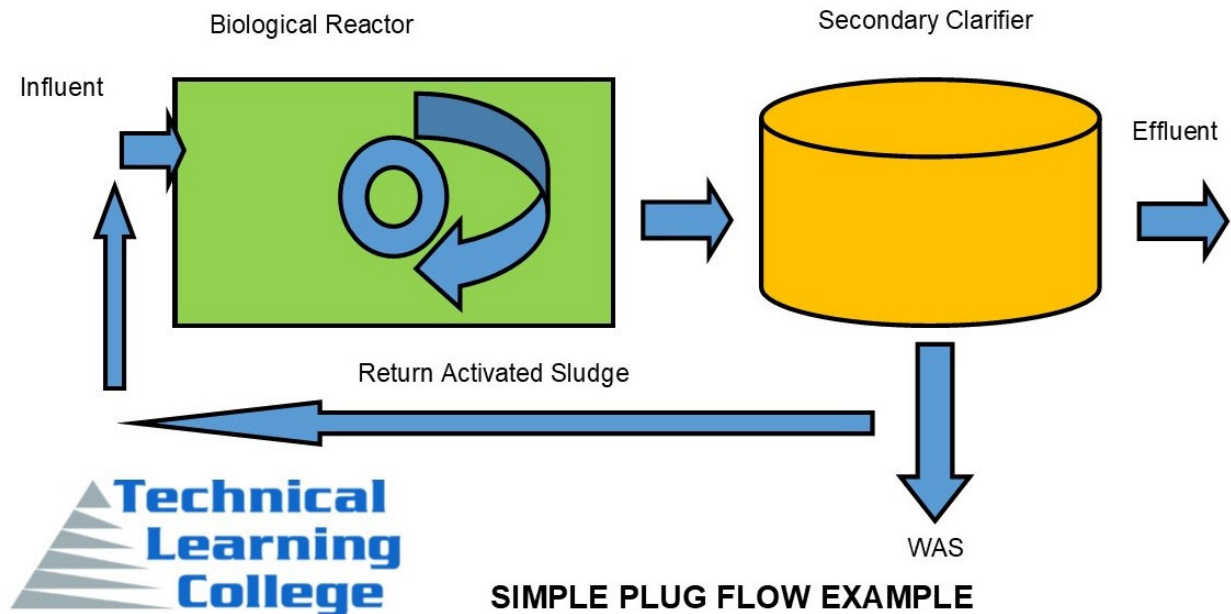

As a result, the concentration of BOD and the oxygen usage will decrease along the basin length. The BOD will decrease, MLSS and MLVSS will increase along the basin length as biomass is produced. This type of flow is approximated by long, narrow basins with length-to-width ratios greater than 10. That is, the basins are at least 10 times longer than they are wide.

Plug flow may also be simulated by placing multiple basins in series or by folding rectangular basins. Like the complete-mix configuration, it is not possible to produce a true plug flow system,

This configuration results in high organic load and oxygen usage at the inlet to the basin because the concentrated microorganisms in the RAS are blended with the influent wastewater in a small percentage of the total basin: With a complete-mix basin, the influent wastewater is evenly distributed throughout the basin, which dilutes the overall concentration of BOD.

With plug flow, there is a concentration gradient-highest at the influent end and lowest at the discharge end. Theoretically, the plug flow basin delivers the highest removal rate per unit volume. It is also less susceptible to filamentous bulking, provided that sufficient DO is present at the inlet.

Sequencing Batch Reactors (SBR)

References USEPA #7

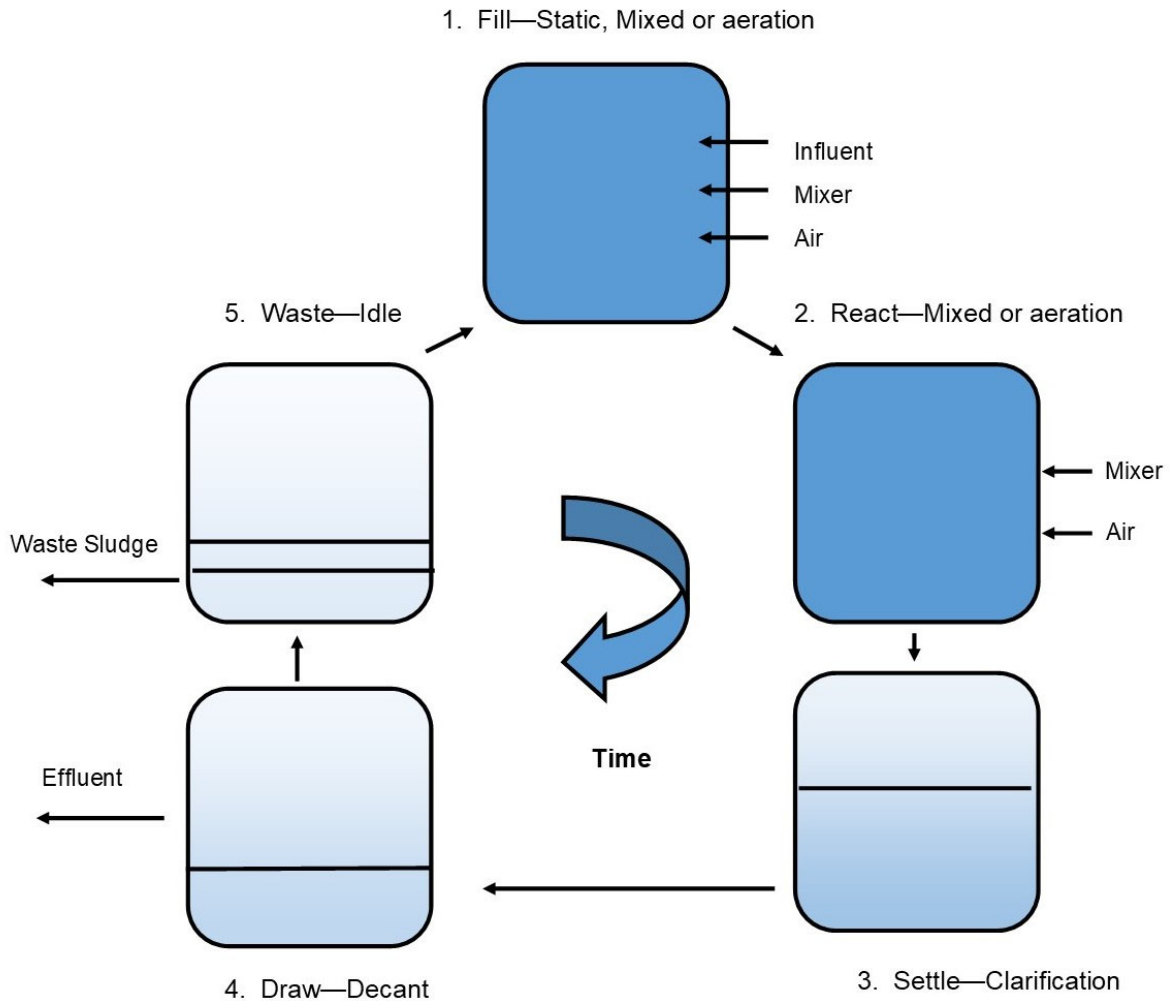

SEQUENCING BATCH REACTOR DIAGRAM

Sequencing batch reactors (SBR) or sequential batch reactors are industrial processing tanks for the treatment of wastewater. SBR reactors treat wastewater such as sewage or output from anaerobic digesters or mechanical biological treatment facilities in batches. Air or oxygen is bubbled through the wastewater to reduce biochemical oxygen demand (BOD) and chemical oxygen demand (COD) to make suitable for discharge. While there are several configurations of SBRs the basic process is similar.

The installation consists of at least two identically equipped tanks with a common inlet, which can be switched between them. The tanks have a “flow through” system, with raw wastewater (influent) coming in at one end and treated water (effluent) flowing out the other. While one tank is in settle/decant mode the other is aerating and filling. At the inlet is a section of the tank known as the bio-selector.

This bio-selector is a series of walls or baffles that direct the flow from side to side of the tank or under and over consecutive baffles. This helps to mix the incoming Influent and the returned activated sludge, beginning the biological digestion process before the mixed liquor enters the main part of the tank.

Fill-and Draw Basis

In its most basic form, the SBR system is a set of tanks that operate on a fill-and draw basis. Each tank in the SBR system is filled during a period of time and then operated as a batch reactor. After desired treatment, the mixed liquor is allowed to settle and the clarified supernatant is then drawn from the tank.

SBR Cycling

Central to SBR design is the use of a single tank for multiple aspects of wastewater treatment. The cycle for each tank in a typical SBR is divided into five separate periods: Fill, React, Settle, Draw and Idle. There are several types of Fill and React periods, which vary according to aeration and mixing procedures. Sludge wasting may take place near the end of React, or during Settle, Draw or Idle.

The influent to the tank may be either raw wastewater (screened and de-gritted) or primary effluent. It may be either pumped in or allowed to flow in by gravity. The feed volume is determined based on a number of factors including desired loading, detention time and expected settling characteristics of the organisms. The time of Fill depends upon the volume of each tank, the number of parallel tanks in operation, and the extent of diurnal variations in the wastewater flow rate.

Virtually any aeration system (e.g., diffused, floating mechanical, or jet) can be used. The ideal aeration system, however, must be able to provide both a range of mixing intensities, from zero to complete agitation, and the flexibility of mixing without aeration. Level sensing devices, timers, or in-tank probes for the measurement of either dissolved oxygen or ammonia nitrogen can be used to switch the aerators and/or mixers on and off as desired.

To accommodate continuous inflow of wastewater, the SBR system generally comprises either a storage / equalization tank and a single SBR tank or a minimum of two tanks. As with conventional activated sludge treatment systems, conventional screening and grit removal are usually provided as preliminary treatment.

SBR and Lagoons

A primary sedimentation stage is not usually required with SBR processes unless the influent suspended solids are excessive. Settled sewage may also be treated if the SBR is installed downstream of existing primary settlement tanks. Reactors are usually simple circular, square or rectangular tanks and may be constructed from concrete or steel.

Lagoon structures and existing tanks, for example, primary sedimentation tanks, can be retrofitted and converted to become SBRs. Since the tank serves as an aeration tank and a final clarifier, fewer structures are used for the treatment plant as a whole and a more compact layout for the site can be obtained. Extensions to the plant by the addition of modular basins using common wall construction can easily be designed for future loading conditions.

Step Feed Activated Sludge Process

References #9 & #13

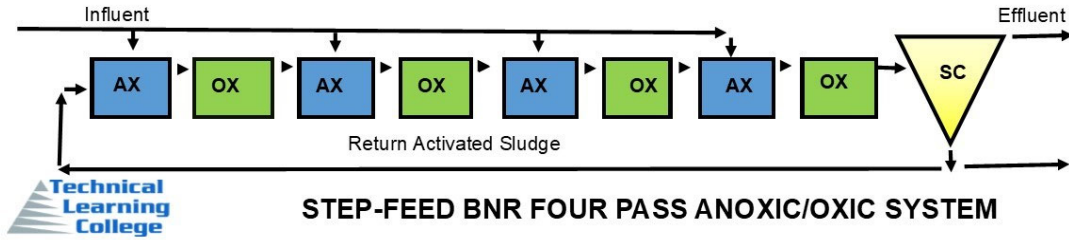

Step feed is a modification of the plug flow configuration in which the secondary influent is fed at two or more points along the length of the aeration tank.

With this arrangement, oxygen uptake requirements are relatively even and the need for tapered aeration is eliminated.

Step feed configurations generally use diffused aeration equipment. The step feed tank may be either the long rectangular or the folded design. Secondary influent flow is added at two or more points to the aeration tank, usually in the first 50 to 75% of the length.

It is also possible to use the same process approach by compartmentalizing the tank and directing flow lengthwise through the compartments. Usually, the last compartment does not receive any raw waste.

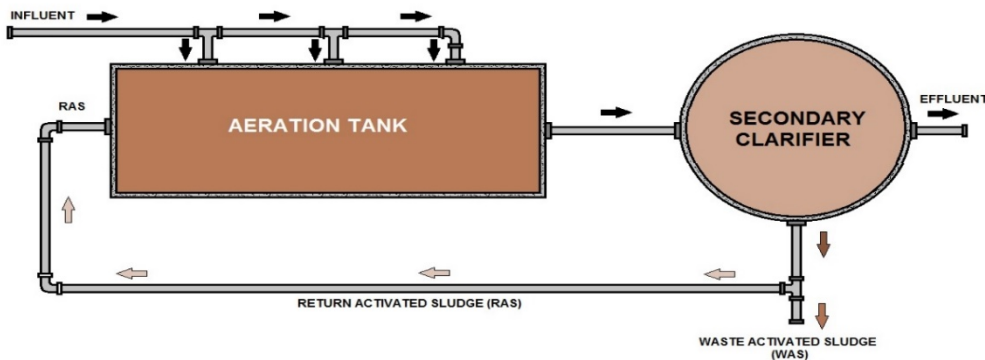
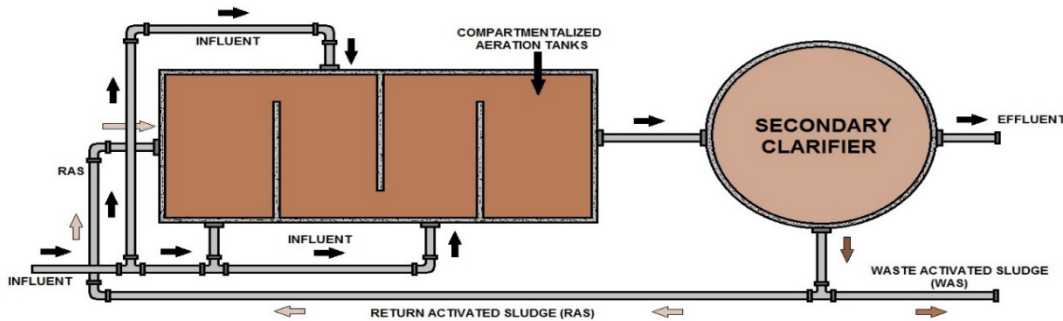

STEP FEED PLANT DIAGRAMS



Wuhrmann Process

Credit # 9 Tennessee Activated Sludge Chapter 7 and #10 USEPA

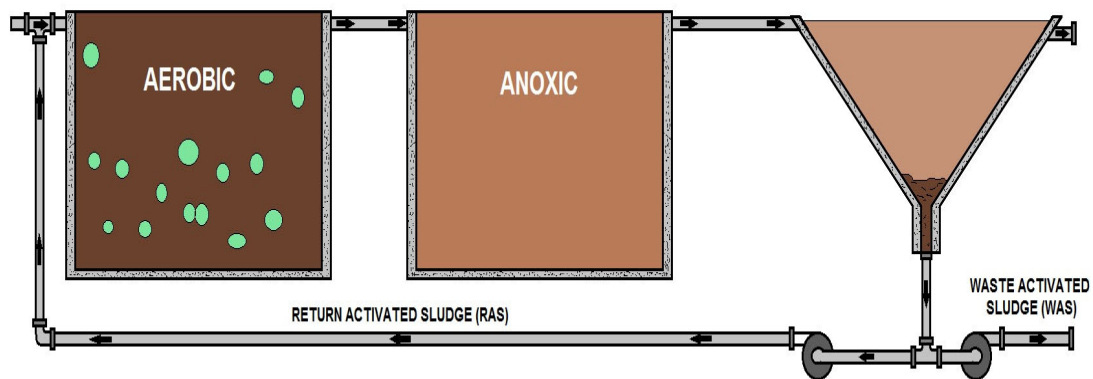

WUHRMANN A/S PROCESS

The Wuhrman process was first suggested in 1964. This process depended upon post denitrification using a secondary anoxic reactor following the aerobic zone.

Secondary anoxic reactors are inefficient and offer only a very slow rate of denitrification due to the lack of Readily Biodegradable Carbonaceous Oxygen Demand (RBCOD). The overall effect of such a zone is a relatively small decrease in effluent nitrate compared to a fully aerobic system (the difference between say 28 mg/L and 25 mg/L nitrate-N in the effluent).

The limiting factor for denitrification here is the scarcity of organic carbon in the anoxic zone. Denitrification requires organic carbon to fuel the process, and in this configuration, the only organic carbon available comes from the slow breakdown of dead and dying bacteria that limits the rate of denitrification by a factor of 6-10 compared to high rate RBCOD driven denitrification.

Numerous plants of this type increase the nitrogen removal by the addition of an external carbon source such as methanol that can rapidly and effectively lower the effluent nitrate concentration in the process effluent.

Although the Wuhrman process is classed as a nitrifying/denitrifying (N/D) process, post denitrification in the secondary anoxic reactor allows only limited removal of nitrate. More complete nitrate removal is often achieved through carbon dosing of the anoxic reactor.

This process also commonly uses a flash aeration reactor to clean up ammonia and condition (make aerobic) the mixed liquor by raising its redox potential prior to secondary clarification. Another function of flash aeration is to remove any bubbles of nitrogen associated with the floc – an issue often caused by the rapid denitrification arising with methanol dosing.

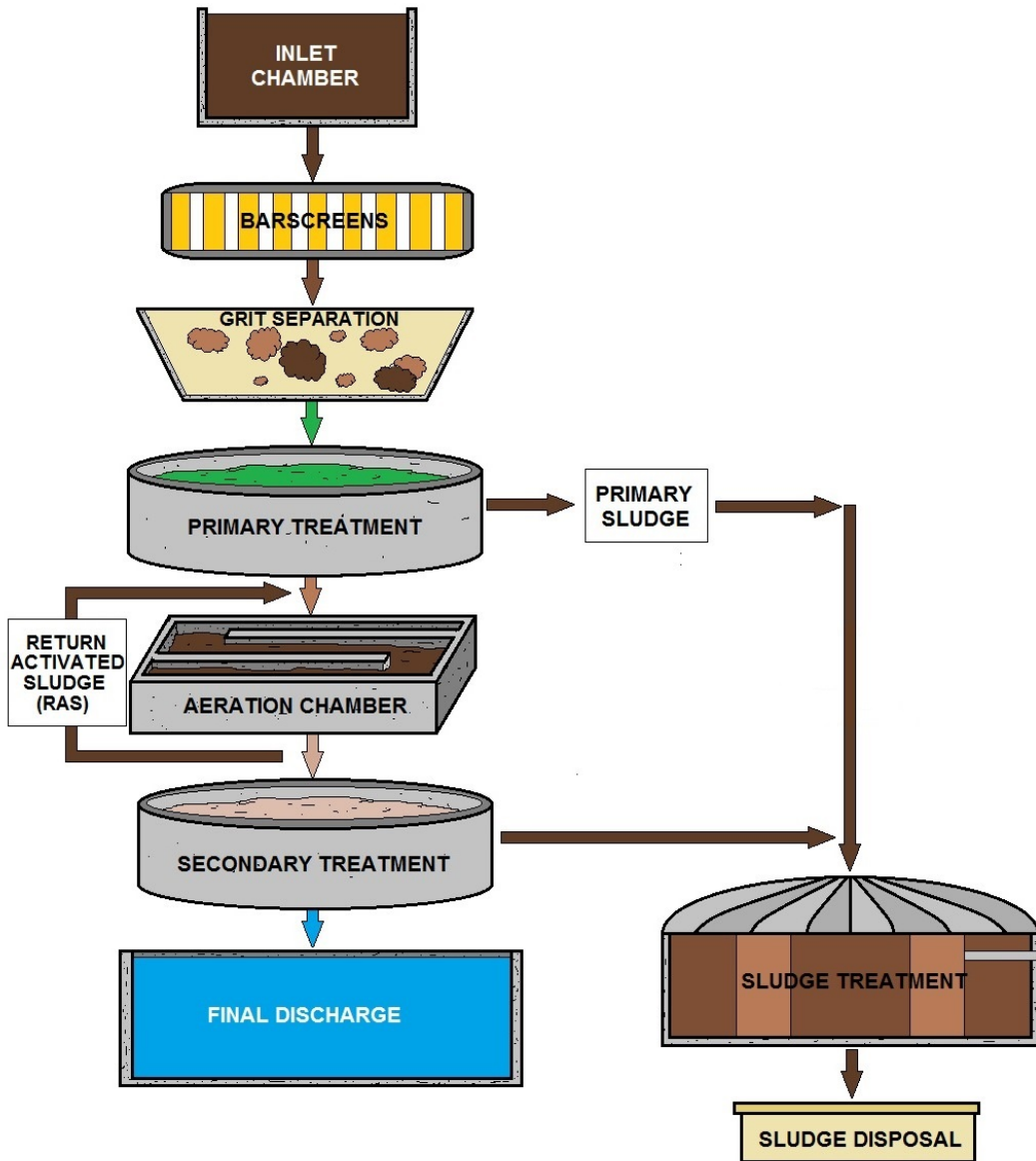

**WASTEWATER TREATMENT PLANT
(SLUDGE REMOVAL BASICS)**

POOR SETTLING SLUDGE CAUSES

Filamentous bulking and polysaccharide (slime) bulking are common causes of poor settling sludge. Other possibilities for poor settling may include hindered settling due to **denitrification** (one example: there is an upward force working against settling in which nitrogen gas wants to float the sludge), or hindered settling due to the mixed liquor concentration being too high.





Rectangular Clarifiers

Notice the weirs are covered and protected from sunlight; the sun helps the algae to grow on the weirs.



Organic Loading Methods

Reference USEPA #14

Activated sludge wastewater treatment plants grow the microorganisms (Bugs) in large tanks. To have enough oxygen in the tanks we add oxygen by blowing air into the tank full of wastewater and microorganisms.

Air is added to the water creating small bubbles and mixes “the bugs,” food and oxygen together. When we treat wastewater this way, we call it the activated sludge method. With all of this food and air, the microbes grow and multiply very rapidly.

Soon the population of bugs gets too large and some of them need to be removed to make room for new bugs to grow. We remove the excess bugs by sedimentation in the same kind of tanks used for primary treatment. In the tank, the bugs sink to the bottom and we remove them. The settled bugs are also called waste activated sludge.

The waste sludge is treated separately, and the remaining wastewater is now much cleaner. In fact, after primary and secondary treatment, about 85% or more of all pollutants in the wastewater has been removed and it goes on to Disinfection. These systems created in the early 1900's and earned their name because a “sludge” (mass of microbes) is produced which aerobically degrades and stabilizes the organic load of a wastewater. Below diagram shows the layout of a typical activated sludge system.

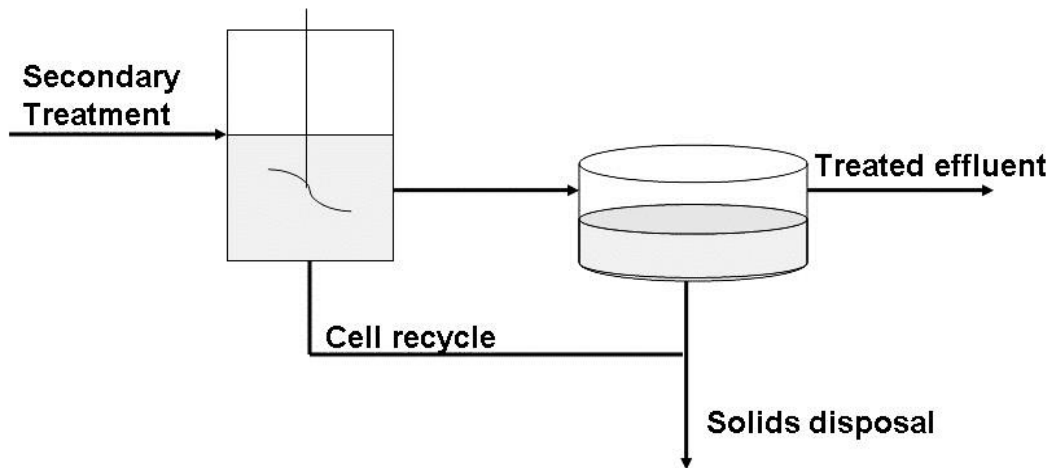

Diagram of a simple activated sludge system.

For larger systems, especially when high variability is expected, the design involves the use of multiple aeration tanks and multiple settling tanks. The number of units employed depends on the flow of wastewater being generated.

Organic Load

Organic loading (this is typically from the primary clarifiers or flotation devices) enters the reactor where the active microbial population (activated sludge) is present. The reactor must be continuously aerated. The mixture then passes to a secondary settling tank where the cells are settled.

The treated wastewater is generally discharged after disinfection while the settled biomass is recycled in part to the aeration basin. The cells must be recycled in order to maintain sufficient biomass to degrade the organic load as quickly as possible.

The amount that is recirculated depends on the need to obtain a high degradation rate and on the need for the bacteria to flocculate properly so that the secondary settling separates the cells satisfactorily. As the cells are retained longer in the system, the flocculating characteristics of the cells improve since they start to produce extra cellular slime which favors flocculating.

Common Types

The most common types of activated sludge are the conventional and the continuous flow settling tank, in which the contents are completely mixed. In the conventional process, the wastewater is circulated along the aeration tank, with the flow being arranged by baffles in plug flow mode. The oxygen demand for this arrangement is maximum at the inlet as is the organic load concentration.

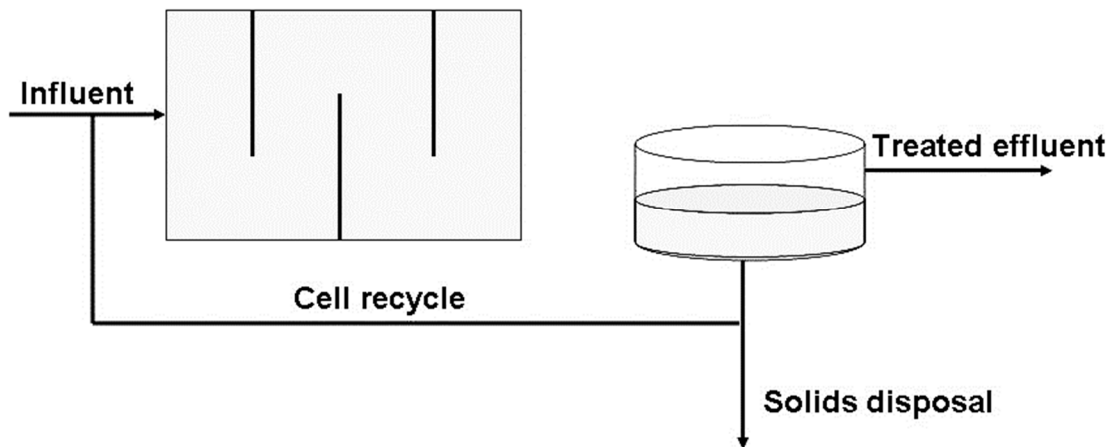

Diagram of a conventional activated sludge process.

In the completely mixed process the inflow streams are usually introduced at several points to facilitate the homogeneity of the mixing; if the mixing is complete, the properties are constant throughout the reactor. This configuration is inherently more stable to perturbations because mixing causes the dilution of the incoming stream into the tank.

In fisheries wastewaters the perturbations that may appear are peaks of concentration of organic load or flow peaks. The flow peaks can be damped in the primary treatment tanks. The conventional configurations would require less reactor volume if smooth plug flow could be assured, which usually does not occur.

Other versions of activated sludge systems (e.g., extended aeration, contact stabilization, step aeration and pure oxygen processes) are used in other kinds of wastewaters but are not known to be applied to treat fisheries wastewaters. They are discussed elsewhere (Metcalf and Eddy Inc., 1979; Eckenfelder, 1980).

In all activated sludge systems, the cells are separated from the liquid and partially returned to the system to have a relatively high concentration of cells that degrade the organic load in a relatively short time.

Consequently, two different residence times are characteristic:

the hydraulic residence time (θ_H) given by the ratio of reactor volume (V) to flow of wastewater (Q):

$$\theta_H = V/Q$$

and the cell residence time (θ_c) given by the ratio of cells present in the reactor to the mass of cells wasted per day.

Typical θ_H values are in the order of 3-6 hours, while θ_c fluctuates between 3 and 15 days. Such difference in residence times is obtained by discharging the clarified effluent but wasting only a small fraction of the sludge.

This in turn can be accomplished by discarding a portion of the sludge from the settling tank or by wasting a fraction of the outlet of the reactor before entering the settling tank. In activated sludge systems, organic load removals of 85-95% are the most common.

A key factor in the success of these systems is its proper operation, which requires trained manpower.

Although used by some large fisheries which operate on a year-round basis, activated sludge may not prove to be economical or feasible for small seafood processors who operate seasonally because of the need to have a fairly constant supply of wastewater to maintain the microorganisms.

Key Operational Points

Waste Activated Sludge	<ul style="list-style-type: none"> • Controls Sludge Age (MCRT, SRT, SRT_{aerobic}) • Controls which microorganisms have time to reproduce • Controls growth rate • Related to F/M ratio and MLSS concentration
MCRT / SRT _{total}	<ul style="list-style-type: none"> • Target between 3 and 20 days • Adjust based on <ul style="list-style-type: none"> • Sludge settleability / SVI • Treatment goals • Water temperature • Total MCRT / SRT when considering filament growth
SRT _{aerobic}	<ul style="list-style-type: none"> • Controls presence or absence of nitrifying bacteria • Adjust based on water temperature <ul style="list-style-type: none"> • Minimum SRT_{aerobic} to nitrify at 20 °C (68 °F) is 4 to 6 days • Minimum SRT_{aerobic} to nitrify at 10 °C 50 °F) is 10 to 15 days
Return Activated Sludge	<ul style="list-style-type: none"> • Controls clarifier • Influences solids loading rate • Influences blanket depth • Controls RAS / WAS concentration within limits of sludge compaction characteristics • Adjust to achieve goals: <ul style="list-style-type: none"> • Maintain blanket < 2 ft • Avoid floating sludge / deflocculation • Avoid secondary release of P
Dissolved Oxygen	<ul style="list-style-type: none"> • Concentration needed to prevent low DO filaments dependent on F/M ratio • Need 2 mg/L to support full nitrification • Need <0.2 mg/L to support denitrification
Internal Mixed Liquor Recycle	<ul style="list-style-type: none"> • Between 0 and 400% of influent flow (based on MLE process) <ul style="list-style-type: none"> • 100% = 50% total nitrogen removal • 200% = 67% total nitrogen removal • 300% = 76% total nitrogen removal • 400% = 83% total nitrogen removal • Higher recycle ratios increase denitrification when adequate BOD₅ is available
Oxidation-Reduction Potential	<ul style="list-style-type: none"> • Absolute numbers depend on meter used and fill solution • Target < 300 mV in anaerobic zone to select for Tetrasphaera PAO • Target between -50 and +50 mV in anoxic zone

Sludge Age Sub-Section

References #2, #6 & #14

Sludge age is the amount of time the solids or MLSS spend retained in the activated sludge basin(s) and secondary clarifier(s) before they are removed from the system either through the WAS line or by escaping into the final effluent. In the case of an SBR, treatment and clarification take place in the same tank.

Sludge Age Definition

Sludge age is a broad term that may refer to any of the following more specific terms: Gould sludge age (GSA), MCRT, SRT, or SRT_{aerobic} . Aerobic SRT is used by operators and design engineers to ensure the system has adequate sludge age for nitrification.

MCRT

Mean Cell Residence Time measures the mass of total suspended solids (TSS) in the treatment system, which includes the solids in the bioreactor (e.g., aeration basin) and the solids in the secondary clarifier, divided by the mass of TSS lost and removed from the treatment system. TSS is lost from the system as total suspended solids overflowing the secondary clarifier (plant effluent). TSS is removed from the system through the intentional wasting of activated sludge. The MCRT unit of measure is days.

Bacteria in the treatment system do the work of capturing suspended and dissolved solids and organic material and converting them into new cell mass that will settle in the clarifiers. They exit the treatment system by one of three methods:

By way of waste activated sludge flowing out of the secondary process to digesters or other treatment units.

By “jumping over the weirs” of the final clarifiers and exiting with the plant effluent flow.

Through endogenous respiration — the decomposition of the bacteria (death) into more simple compounds (CO_2 , H_2O , energy). Endogenous respiration is common in extended aeration activated sludge treatment modes and aerobic sludge digesters.

MCRT and SRT are mathematical calculations used to describe how long bacteria are in the system before they leave the plant via one of the first two methods listed above.

If a wastewater treatment plant is running well, experiencing very few times where a significant volume of suspended solids actually leave the plant, the operator may choose to exclude the minimal pounds of effluent TSS portion of the MCRT/SRT calculation and just use the wasted solids pounds. This makes the calculation simpler.

One disadvantage of using MCRT/SRT is the daily flow variations experienced at some treatment plants. When calculating MCRT/SRT, the daily flow rates of plant effluent and waste sludge are important values.

Calculating the MCRT or SRT will be especially problematic and variable if a facility does not waste sludge every day. Some plants waste sludge just a few times per week. To help make the calculations a little easier to use in process control decisions and operation of a

facility, you might use moving averages to smooth out the data, especially if using trend charts or computer-based trending software.

A moving average is simply the daily data averaged over a period of time, commonly 5, 7 or 14 days. This helps alleviate upward or downward swings in data that is trended over time, especially waste sludge flow rates.

Sludge Age Affect Every Aspect of A/S

Sludge age affects every aspect of the activated sludge process operation including: MLSS concentration and quality; sludge settling characteristics, types of microorganisms present in the process, F/M, treatment efficiency, sludge production and final effluent quality.

Food/Microorganism Ratio

The food/microorganism ratio, or F/M, is a measurement of the food entering the activated sludge process and the microorganisms in the aeration tank(s). Each activated sludge process has an F/M at which it operates best. This F/M may fluctuate throughout the year according to changes in operational conditions, such as industrial discharges, permit requirements, and temperature.

The food value or food supply entering the activated sludge process consists of the BOD loading measured as pounds discharged in to the aeration tank(s). The BOD loading is calculated by multiplying the concentration (mg/l) of BOD entering the aeration tank by the influent aeration tank flow in millions of gallons per day (MGD) by the weight constant of 8.34 pounds per gallon of wastewater.

$$\text{BOD mg/l} \times \text{Flow (MGD)} \times 8.34 \text{ pounds/ gal. wastewater} = \text{BOD loading}$$

The microorganism value or amount of microorganisms in the activated sludge process consists of the pounds of mixed liquor volatile suspended solids (MLVSS) in the on-line aeration tank(s). The pounds of MLVSS is calculated by multiplying the concentration (mg/l) of MLVSS by the aeration tank(s) volume in million gallons (MG) by the weight constant of 8.34 pounds per gallon of wastewater.

$$\text{MLVSS (mg/l)} \times \text{Aeration tank volume (MG)} \times 8.34 \text{ pounds/ gal wastewater} = \text{pounds MLVSS}$$

The F/M of an activated sludge process can be calculated by dividing the pounds of food as BOD applied to the microorganisms or MLVSS present in on-line aeration tank.

$$\text{F/M} = \text{Pounds BOD to aeration tank} \div \text{Pounds MLVSS in aeration tank}$$

Sludge Age Calculation

References #2, #6 & #14

Sludge age in the activated sludge process is the measure of the length of time a particle of suspended solids has been undergoing aeration. This time is expressed in days and is calculated using the pounds of Mixed Liquor Suspended Solids (MLSS) in the aeration basin and the pounds of Total Suspended Solids (TSS) in the influent to the aeration tanks

Young sludge is indicated by excessive white, billowy foam and low MLSS concentration and high food to microorganism ratios. An overabundance of dark brown and greasy foam is an indicator of old sludge, which also has a high MLSS concentration and low food to microorganism ratios.

Primary Process Control Variable

Sludge age should be the primary process control variable for any activated sludge system. It should be adjusted as needed to optimize sludge settleability, minimize energy use, and meet final effluent limits.

In locations that experience seasonal changes in influent water temperature, sludge age should be adjusted seasonally to compensate for increases or decreased microbial activity. The sludge age selected will dictate whether or not an activated sludge process will be able to meet treatment goals for effluent TSS, BOD and ammonia.

Gould Sludge Age

The Gould sludge age represents the average number of days' total suspended solids (TSS) entering the bioreactor remain under aeration. The GSA is calculated by dividing the pounds (or kg) of MLSS in the aeration tank by the pounds (or kg) of total suspended solids entering the aeration tank each day.

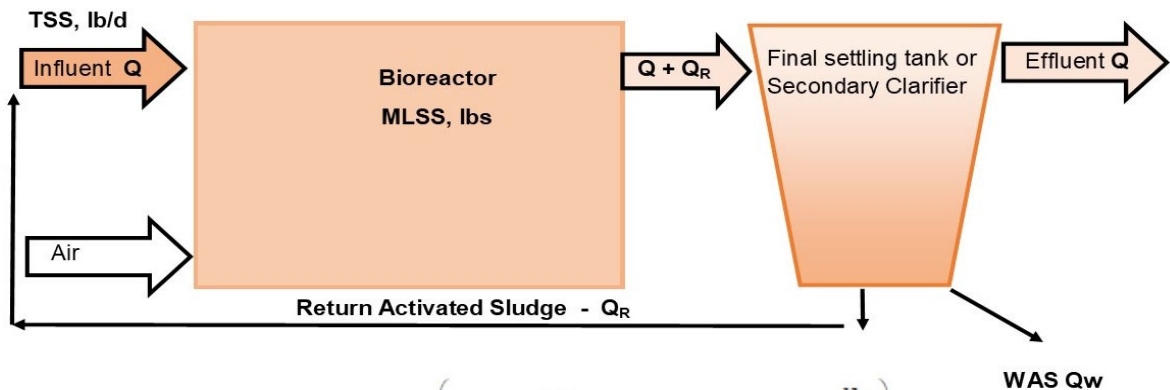

$$GSA, d = \frac{\left(MLSS \frac{mg}{L} \times V_{AB}, Mgal \times 8.34 \frac{lb}{gal} \right)}{\left(Q_{INF} \frac{Mgal}{d} \times TSS_{INF} \frac{mg}{L} \times 8.34 \frac{lb}{gal} \right)}$$



GOULD A/S SLUDGE FLOW DIAGRAM AND FORMULA

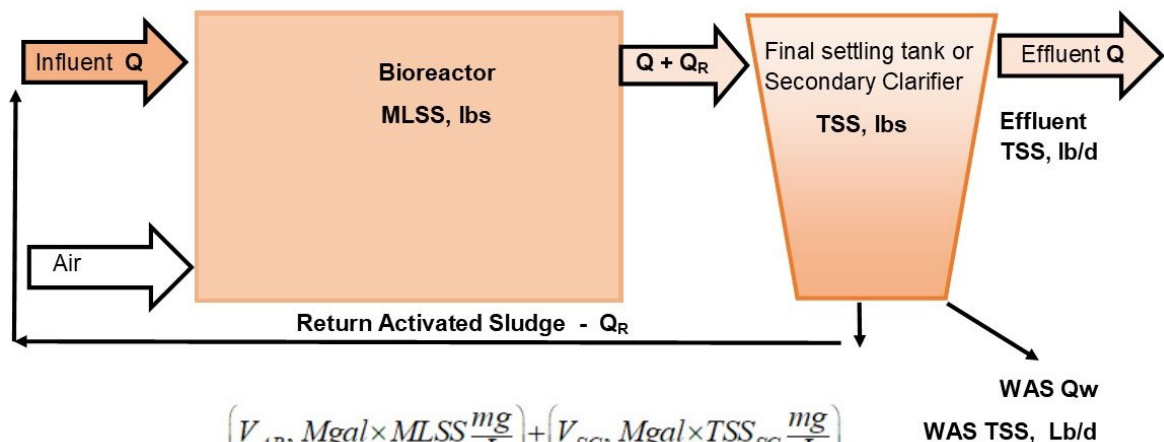

$$MCRT, d = \frac{\left(V_{AB}, Mgal \times MLSS \frac{mg}{L} \right) + \left(V_{SC}, Mgal \times TSS_{SC} \frac{mg}{L} \right)}{\left(Q_{WAS} \frac{Mgal}{d} \times TSS_{WAS} \frac{mg}{L} \right) + \left(Q_{EFF} \frac{Mgal}{d} \times TSS_{EFF} \frac{mg}{L} \right)}$$

$$MCRT, d = \frac{\left(V_{AB}, Mgal \times MLSS \frac{mg}{L} \times 8.34 \frac{lb}{gal} \right) + \left(V_{SC}, Mgal \times TSS_{SC} \frac{mg}{L} \times 8.34 \frac{lb}{gal} \right)}{\left(Q_{WAS} \frac{Mgal}{d} \times TSS_{WAS} \frac{mg}{L} \times 8.34 \frac{lb}{gal} \right) + \left(Q_{EFF} \frac{Mgal}{d} \times TSS_{EFF} \frac{mg}{L} \times 8.34 \frac{lb}{gal} \right)}$$

Terms:

V_{AB} : Aeration basin volume in units of million gallons

MLSS: Mixed liquor suspended solids

V_{SC} : Secondary clarifier volume in units of million gallons

Q_{WAS} : Waste activated sludge flow rate in units of million gallons per day

TSS_{WAS} : Total suspended solids concentration of the waste activated sludge

Q_{EFF} : Treatment plant effluent flow rate in units of million gallons per day

TSS_{EFF} : Total suspended solids concentration in the plant effluent



TSS POUNDS IN AND LEAVING DIAGRAM AND FORMULA

Sludge Problems and Solutions Sub-Section

References State of Maine # 15

Sludge Age

Activated sludge (RAS) is recycled back through the aeration basins by returning settled sludge in the final clarifiers, and thus remains in the activated sludge system for a number of days. For effective treatment, a specific sludge age is desired for each type of activated sludge system.

For conventional activated sludge, a sludge age of 3-10 days is typical. For extended aeration activated sludge, older sludge ages of 15-30 days are common. F/M ratio and sludge age is inversely related (1 divided by the sludge age approximates the F/M ratio). The older the sludge, the lower the F/M ratio; conversely, the younger the sludge, the higher the F/M ratio. Process control methods are regulated by WAS. It is the key to controlling the activated sludge process. The operator should monitor MLSS, F/M ratio and sludge age to waste accordingly and thus ensure optimal operations and process stability.

Excess Solids

Solids are generated by microorganism growth and reproduction. The influent BOD supplies the food for the growth and reproduction. As microorganisms' populations multiply, excess solids (microorganisms) must be removed (wasted). If excess solids are not removed, the mixed liquor suspended solids (MLSS) and sludge age will increase and process efficiency will be lowered. Sludge settling rates are affected. Eventually, if excess solids do not get wasted, they can overflow the clarifier weirs and into the receiving water.

Wasting Sludge

Wasting sludge is the most important operational process control of the activated sludge process. By wasting sludge on a consistent basis, preferably daily, the biomass within the aeration tank will remain healthy and at a consistent MLSS level.

Wasting Rates

The concentration of WAS has a direct bearing on how much to waste and the volume wasted. On a volume basis, a thicker waste activated sludge (high WAS concentration) will require less amount of wasting than a thinner waste activated sludge (low WAS concentration).

Clarifier Sludge Blanket

Solids settle and concentrate in the final clarifiers forming a sludge blanket. The sludge blanket can increase or decrease depending on the RAS flow rate. The proper RAS flow rate is essential for establishing a desired sludge blanket.

Young Sludge

Young sludge consists of sludge that has not yet reached a high enough sludge age to be most effective in a particular activated sludge process. Billowing whitish foam is an indicator that the sludge age is too low. Young sludge will often have poor settling characteristics in the clarifier, and can leave straggler floc in the clarifier effluent. Young sludge is often associated with a high F/M. To correct for young sludge, it is necessary to decrease wasting rates. This will increase the amount of solids under aeration, reduce the F/M ratio, and increase the sludge age.

Old Sludge

Old sludge consists of sludge in which the sludge age is too high to be most effective in a particular activated sludge process.

Dark brown foam and a somewhat greasy or scummy appearance is an indicator of old sludge. Settling in the clarifier is rapid, but pin floc can be present in the effluent and the effluent is hazy.

Old sludge is often associated with a low F/M ratio. To correct for old sludge, it is necessary to increase wasting rates and return less sludge to the aeration basin. This will reduce the amount of solids under aeration, increase the F/M ratio and decrease the sludge age.

RAS Concentration

Varying the RAS flow rate will affect the concentration and detention time of clarified solids. Adjusting the RAS pumping rate allows the return of more or less concentrated solids while also increasing or decreasing the depth of the sludge blanket. RAS flow rates can be paced off influent flow rates.

Final Clarifier Solids Loading Rate (SLR)

The rate at which the activated sludge is returned from the final clarifiers to the aeration basins, along with the influent flow, effects the flow of solids into the clarifiers. Aeration basin mixed liquor suspended solids must have sufficient time to settle and be returned or wasted in the activated sludge system. Clarifiers are designed for certain solids loading rates that should not be exceeded.

Hydraulic Overloads

Solids washouts

If the flow is too high through the final clarifier, the solids will not have enough time to settle and can wash out over the weirs. This can result in a loss of solids from the system and effluent permit violations.

Reduced treatment efficiency

High flows can reduce the detention time in the aeration basins and thus reduce treatment efficiency. If too many solids also flow out of the clarifier, there may not be enough biomass to effectively treat the incoming organic load.

Denitrification

When RAS flow rates are too low, thick sludge blankets in the final clarifier can result. The operator will see gas bubbles (from nitrogen gas) and rising/floating sludge clumps on the clarifier surface.

Controlling dissolved oxygen levels in diffused air systems

1. By controlling air valves
2. By controlling the blower output, such as using VFDs
3. By increasing or decreasing the number of blowers in operation
4. Cleaning or replacing diffusers
5. Changing the number of diffusers
6. Process control (ex. MLSS levels)
7. Changing the type of diffuser.

Controlling dissolved oxygen levels in mechanical aeration systems

1. By increasing or decreasing the aerator speed by using VFDs
2. By increasing or decreasing the aerator submergence by adjusting the tank water level
3. By increasing or decreasing the number of aerators in operation
4. Process control (ex. MLSS levels)

[Note: Throttling air valves with a positive displacement blower will not reduce airflow output but will raise operating pressure of the blower, increasing electric cost and potentially damaging the blower or piping. Throttling an inlet air valve on a centrifugal blower will reduce air discharge flow.]

Filamentous Bulking Sludge

The sludge blanket in the final clarifier will be near the surface, often with solids going over the weirs. Confirm by microscopic examination.

Nocardia Filaments Present

Thick, greasy, dark tan foam on aeration basins and possibly on final clarifiers. Confirm by microscopic examination.

Return Rates Too Low

Thin mixed liquor suspended solids and a sludge blanket build-up of solids. Rising clumps of sludge or gas bubbles may occur in the final clarifier.

Return Rates Too High

No sludge blanket in the final clarifier and a thin return activated sludge.

Denitrification in Final Clarifier

In the absence of oxygen, a sludge blanket that is too thick and remains in the clarifier too long can denitrify. Nitrates in the sludge will be converted to nitrogen gas. The release of nitrogen gas will cause small gas bubbles that will be observed at the clarifier surface. Clumps of sludge may also rise to the surface.

Low DO in an Aeration Basin

Problem: Dissolved Oxygen Meter/probes are inaccurate.

Solution: Check the calibration of DO monitoring equipment. Clean probes and monitoring equipment regularly to ensure accurate DO measurements

or

Problem: Inadequate air supply. Poor DO transfer.

Solution: Increase air supply. Clean, replace or upgrade diffusers.

or

Problem: Excessive Organic Loading

Solution: Reduce influent loading through enforcement of the sewer use ordinance; a pretreatment program; equalization basins or bringing additional aeration basins on-line if available.

Clarifier Settling Problems and Solutions

Problem: Excessive filamentous organisms

Solution: Adjust the environmental conditions to support a healthier biomass. Chlorine dosing at a low level may help.

or

Problem: Sludge age. Too young or too old a sludge can result in a poor settling sludge.

Solution: Adjust wasting to achieve the proper sludge age.

or

Problem: Clarifier washouts due to high flows

Solution: Develop and implement a collection system CMOM Program to reduce infiltration/inflow (I/I)

or

Problem: Too many solids in the system

Solution: Waste regularly to maintain proper MLSS, F/M ratio and sludge age for influent organic loads

Foaming Problems

Problem: Young sludge (white billowing foam)

Solution: Increase sludge age

or

Problem: Filamentous foaming organisms (Nocardia, Microthrix)

Solution: Adjust environmental conditions. Adjust F/M ratio, sludge age and dissolved oxygen. Reducing incoming grease is one of the most important factors to control surface filamentous forming organisms. A low dose of chlorine may help.

or

Problem: Industrial/chemical discharges (surfactants, phosphates, etc.)

Solution: Enforce sewer use ordinance

Lack of Nitrification

Problem: Improper environmental conditions

Solution: Nitrifying bacteria are very sensitive to environmental factors, such as very low dissolved oxygen, alkalinity, and temperatures. An older sludge (> 8 days) is usually needed for their growth. Adjust these environmental conditions, as you can, to support the growth of nitrifying bacteria.

Coarse Bubble Aeration Systems

1. Aeration basins shall be drained annually
2. Remove excess settled solids that have accumulated
3. Clean diffusers and piping assemblies as needed
4. Inspect all hardware and components
5. Repair, replace, and tighten components as needed
6. Refill aeration tank following startup procedures

Fine Bubble Aeration Systems

1. Aeration basins shall be drained annually
2. Drain aeration basin and leave air on. Look for air leaks.
3. Remove excess settled solids that have accumulated
4. With air on, hose off and wash each diffuser with clean water
5. With air off, if needed scrub each diffuser with either a soft bristle brush or rag.
6. Turn air back on and repeat hosing procedure for each diffuser
7. Inspect all hardware and components
8. Repair, replace, and tighten components as needed
9. Refill aeration tank following startup procedures

Old Sludge

References #4 and # 16

Old sludge filaments include *M. parvicella*, Type 0041, Type 0675, Type 1851 and Type 0803. *M. parvicella* is known for causing foaming and bulking occurrences, especially during winter operating conditions, in WWTPs that must remove ammonia year-round. Not that for many filaments like Nocardioforms and *S.natan*, the effective washout SRT is so low that it isn't possible to waste them out of the process.

Nocardia or Microthrix parvicella

Old sludge conditions usually cause a dark brown, thick, scummy foam. It is usually caused by the growth of *Nocardia* or *Microthrix parvicella*, both of which grow at the high MCRT/low F/M condition associated with old sludge. A treatment pressure is required to decrease the total sludge in the system. Thus, one must increase wasting and try to remove foam from the system.

Once *Nocardia* has started to grow profusely, it is difficult to eliminate through increased wasting. Therefore, removal of foam from the system becomes more important. Foaming due to *M. parvicella* appears to occur more during colder temperature conditions while *Nocardia* can bloom profusely under higher temperature conditions. Both also appear to like oils and grease in their diets.

Excessive Old Sludge

This is pinpointed through the diluted settleometer test, which shows a great improvement in sludge settling. The required corrective response is a decrease in the total system sludge mass. Increased wasting is needed to accomplish that objective. This problem is very common.

Foam Trapping

Systems can trap foam where *Nocardia* and *Microthrix parvicella* float to the surface. The key to removing the problem is to remove the foam from the system. Increased wasting will help some, but this will often have negligible benefit. A short-term solution includes develop some facilities using a vacuum truck to remove the foam from the surface. A long-term solution includes eliminating grease from the influent. Sending foam to anaerobic digesters can create problems there.

Bacteria and Temperature Effect

Washout SRT is affected by temperature. For every 10°C drop in water temperature, the growth rate of bacteria decreases by 50% and the washout SRT doubles. Growth rates for floc forming and filament forming bacteria are similarly affected.

Stable Nitrification

At a water temperature of 20°C, the washout SRT for Ammonia Oxidizing Bacteria (AOBs) is approximately 1.6 days and the washout for Nitrite Oxidizing Bacteria (NOBs) is approximately 2.0 days. To maintain a stable population and to avoid accidental loss of these bacteria resulting from accidental overwasting, the target SRT would need to be two to three times as long or between 4 and 6 days.

If the water temperature drops to 10°C, the washout SRT for the AOBs increases to 3 to 5 days. This means a target SRT of between 10 and 15 days is needed to maintain stable nitrification. For a WWTP with winter water temperature of 10°C and summer water temperatures of 20°C, the target SRT will need to move between and 15 days to maintain nitrification.

Slimy Foam

A grayish slimy foam that is very thick is commonly caused by nutrient deficiencies. It is often noted with a slime bulking condition. Those deficiencies may be either nitrogen or phosphorus. The solution usually involves addition of the limiting nutrient, such as ammonia to provide nitrogen, or phosphoric acid to provide phosphorus.

There is usually enough nutrient if the ammonia plus nitrate in filtered (0.45 µm) effluent is greater than 1 mg/L and the soluble orthophosphate is greater than 0.5 mg/L (Jenkins, et al., 1993). However, in certain cases where easily degradable, soluble BOD is available, higher N and P concentrations may be necessary.

Solids included in the Sludge Age Calculation Chart

Sludge Age Definition	Influent TSS	Anaerobic and Anoxic Zones	Aerated Zones	Clarifier Blanket	Waste Solids
Gould Sludge Age (GSA)	Yes	Yes	Yes	Maybe	No
Mean cell residence Time (MCRT)	No	Yes	Yes	Yes	Yes
Solids retention time (SRT)	No	Yes	Yes	No	Yes
Aerobic solids retention time (SRT aerobic)	No	No	Yes	No	Yes

Foaming Sludge Sub-Section

Reference #9 & #15

Foaming in activated sludge process is a common operational problem in many wastewater treatment plants. The foam can occur in the aeration tank, secondary clarifier, as well as in the anaerobic digester.

WASTEWATER FOAM DESCRIPTION	CAUSE(S) OF FOAM
WHITE TO GRAY COLOR / THIN FOAM	"YOUNG SLUDGE" / LOW CELL RESIDENCE TIME
WHITE, FROTHY / BILLOWING FOAM	SEEN WITH LOW ACTIVE BIOMASS AND HIGH F/M. NON-BIODEGRADABLE DETERGENTS (rare) FOAM
PUMICE-LIKE, GRAY / ASHY FOAM	EXCESSIVE RECYCLING FROM DIGESTERS AND PRESSESSES THAT LEAD UP TO BUILDUP OF "FINES"
A THICK SLUDGE BLANKET FLOATING IN FINAL CLARIFIER. STIRRING OF SLUDGE RELEASES <u>SMALL BUBBLES</u> .	SLUDGE BLANKET KEPT TOO LONG IN CLARIFIER WHERE THE SLUDGE HAS NITRATE PRESENT ; DENITRIFICATION
GRAY TO BROWN COLOR / THICK, SLIMY FOAM	EASILY DIAGNOSED WITH INDIA INK STAIN. NUTRIENT DEFICIENCY CAUSE EXCESS POLY SACCHARIDE PRODUCTION
BROWN COLOR / THICK, STABLE FOAM (with Filaments)	FOAMING INDUCED BY FILAMENT CAUSED BY NOCARDIA sp., MICROTHIS PARVACELLA, or TYPE 1863
BROWN FLOATING SCUM BUILDUP ON CLARIFIERS / FOAM HAS BROWN-BLACK STREAKS	GREASE & OIL



DESCRIPTION AND CAUSES OF FOAMING IN WASTEWATER TREATMENT

Foam in WWTP is normally sticky, viscous and brown in color. It floats and accumulates on top of the tanks, and can take up a large fraction of solids inventory and reactor volume, thus decreasing the effluent quality and control of sludge retention time (SRT).



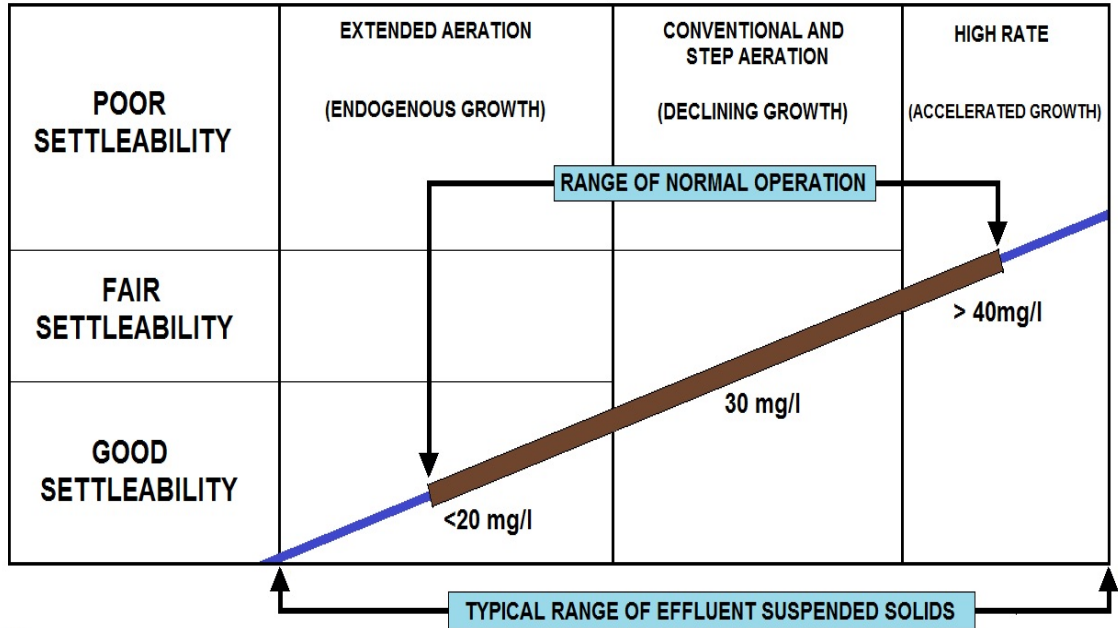

RELATIONSHIP BETWEEN ACTIVATED SLUDGE SETTLEABILITY AND TREATMENT MODE

Excess Foam Conditions

Excess Foam Conditions 1 through 5 relate to excess foam in the system (Jenkins, et al., 1993). When considering foam problems the question must be asked, "Is the amount of foam that exists a problem?" If it is not a problem, the situation may be better left unresolved. Many people observe foam and consider it a problem when it is not. For instance, a dark leathery Nocardia foam may look bad on an aeration tank but may not be affecting effluent quality. However, the situation may arise where someone's boss or the public thinks it's a problem; then it becomes the operator's problem.

Condition 1- Pumice-Like Foam

This type of foam often appears gray but if one looks closely, they observe that the foam has a large number of dark specks. This foam is usually due to solids returned from sludge processing. It may be due to poor solids capture from a belt press or a centrifuge or from digester supernatant return that contains excess solids. The key to improvement of this condition is to improve the solids capture in the sludge processing scheme.

Condition 2 - Slimy Foam

A grayish slimy foam that is very thick is commonly caused by nutrient deficiencies. It is often noted with a slime bulking condition. Those deficiencies may be either nitrogen or phosphorus. The solution usually involves addition of the limiting nutrient, such as ammonia to provide nitrogen, or phosphoric acid to provide phosphorus. There is usually enough nutrient if the ammonia plus nitrate in filtered (0.45 μm) effluent is greater than 1 mg/L and the soluble orthophosphate is greater than 0.5 mg/L (Jenkins, et al., 1993). However, in certain cases where easily degradable, soluble BOD is available, higher N and P concentrations may be necessary.

Condition 3 - Dark Brown, Thick, Scummy Foam

Old sludge conditions usually cause a dark brown, thick, scummy foam. It is usually caused by the growth of Nocardia or Microthrix parvicella, both of which grow at the high MCRT/low F/M condition associated with old sludge. A treatment pressure is required to decrease the total sludge units in the system. Thus, one must increase wasting and try to remove foam from the system. Once Nocardia has started to grow profusely, it is difficult to eliminate through increased wasting. Therefore, removal of foam from the system becomes more important. Foaming due to M. parvicella appears to occur more during colder temperature conditions while Nocardia can bloom profusely under higher temperature conditions. Both also appear to like oils and grease in their diets.

Conditions 4 and 5 - White Billowy Foam

White billowy foam is caused by high concentrations of surfactants such as detergents. It is not nearly the problem today that it was before biodegradable detergents were used. Condition 4 occurs at start-up of a system where a young sludge exists due to low mixed liquor suspended solids concentrations. In this condition there are just not enough solids present to break the surface tension of the surfactant bubbles that form. Thus, billowy white foam can accumulate on the aeration tank and can even be blown around by the wind. The condition is usually short-lived since at start-up the operator is usually applying oxidative pressure by increasing the total sludge units in the system. If the condition occurs due to previous excessive wasting, the solution is still to decrease wasting and increase the total sludge units in the system.

Condition 5 is found when there are higher concentrations of suspended solids. The cause is usually a very high surfactant load such as may be found when certain industrial processes are cleaned. Although there is a higher suspended solids concentration, it is still not high enough to break the surface tension of the surfactant bubbles. Again, an oxidative pressure is required to increase the total sludge units by decreased wasting and it is also worthwhile to increase the solids detention time in the aerator by decreasing the return flow rate.

High Effluent Suspended Solids

High effluent suspended solids are usually caused by one of two conditions: either individual particles that will not settle are discharged or the sludge blanket in the clarifier washes out. Either of these can cause conditions 6 through 24 to occur. Look first at clarifier blanket washout related to conditions 6 through 17. In this situation, the sludge blanket in the clarifier actually rises close enough to the surface so that it washes over the effluent weir. To learn the reason for the clarifier-blanket washout, the first thing to do is to look at the sludge settleability. If the problem is not a blanket wash-out, it is individual particle washout. The individual particles may be tiny pin-floc, large straggler-floc or individual, dispersed cells. Physical observation of the effluent and microscopic observation of the mixed liquor or effluent will show which type or combination of types of individual particles is involved.

Hydraulic Overload ~ Conditions 6 and 7

If the settling test or diluted settling test shows that the sludge settles well, then the blanket washout is usually due to too many solids in the clarifier. Condition 6 is caused by hydraulic overload of the clarifier. It results when too many solids are pushed into the clarifier and they are not physically returned fast enough to the aeration tank. There are just too many solids applied to the clarifier.

The required pressure to eliminate the problem is oxidative. The objective is to decrease the solids load to the clarifier by initiating step feed or even going to contact stabilization. If step feed or contact stabilization are not available, a short-term decrease in solids load to the clarifier can be accomplished by turning the air off in the aeration tank for a short time. This allows the solids to settle in the aeration tank. This reduces the solids load on the aeration tank while at the same time allows the sludge return system to return solids from the clarifier to the aeration tank. The same approach can be used to manage short-duration daily peak flows or other short-term peaks such as storm inflows or things like weekends at ski areas. However, the on-off approach will not work if the aeration basin discharge is from the bottom of the tank.

Condition 7 occurs due to an overload of the return system, not a hydraulic overload. The actual solids loading to the clarifier is not excessive, but the solids are just not returned fast enough. A treatment pressure is usually required, decreasing the clarifier sludge units. However, the problem may be caused by something much simpler and can be handled by an increase in the return rate. If there is a physical problem such as a clogged return line, clean the line. Problems with Poor Settling Before the reason for poor sludge settleability can be pinpointed, a diluted settleometer test must be run. A simple old-sludge condition, with just too much sludge in the system, will show greatly improved settling in the diluted test. However, a bulking situation, even though it shows some improved settling, will not show large improvement.

Condition 8 - Excessive Old Sludge

As mentioned above, this is pinpointed through the diluted settleometer test, which shows a great improvement in sludge settling. The required pressure is a decrease in the total system sludge mass. Increased wasting is required to accomplish that objective. This problem is very common.

Conditions 9 through 17 ~ Bulking

Bulking has been the scourge of activated sludge ever since flow-through systems began being used in the 1920s. It can be caused either by production of slime or growth of filamentous organisms.

Condition 9 - Slime Bulking

Slime bulking (Jenkins, et al., 1993) is usually caused by a nutrient deficiency. As in Condition 2, ammonia or nitrate must be added if the ammonia plus nitrite plus nitrate is less than 1 mg/L. Phosphate must be added if the phosphate is less than 0.5 mg/L in the effluent. Slime bulking is usually associated with industrial waste, but may be found in municipal systems that have high concentrations of industrial wastes discharged to them.

Even higher concentrations of N & P may be required with certain industrial wastes. This is true if the organic loading comes from easily metabolized materials, such as simple sugars, short-chain organic acids, or alcohols. These may be metabolized so rapidly that excess N and P are required in the system to ensure that the local concentrations are high enough. Complete mixing may also help in this situation.

Condition 10 - Foam Trapping

Systems can trap foam as in Condition 3 where *Nocardia* and *Microthrix parvicella* float to the surface. The key to removing the problem is to remove the foam from the system. Increased wasting will help some, but this will often have negligible benefit. A short-term solution includes some facilities using a vacuum truck to remove the foam from the surface. A long term solution includes eliminating grease from the influent.

Condition 11 - Low DO Bulking

Type 1701, *Sphaerotilus natans*, and *Haliscomenobacter hydrossis* have all been known to grow profusely under low dissolved oxygen conditions. In recent years, it came to light that *Microthrix parvicella* also grew well under low DO conditions at high MCRT. Also, it was not known until recently that as the food-to-microorganism ratio increases, aeration basin dissolved oxygen also needs to increase, otherwise low DO bulking can occur. For instance, to protect a system with an F/M of approximately 1.0, almost 5 mg/L DO is required (watch potential denitrification problems). That F/M is defined as pounds of COD removed per pound of ML VSS in the aeration tank (Jenkins, et al., 1993). Objective number one is to increase the DO, but in certain cases that is impossible.

Objective number two would be to increase the MCRT, which in turn would decrease the F/M ratio. An MCRT increase would be accomplished with a decrease in wasting. Finally, a third objective would be to develop a selector section that could operate anaerobically, anoxic ally, or aerobically. Jenkins, et al. (1993), indicate that any of the three types of selectors will work on low DO filaments.

Condition 12 - Low pH

Growth of fungi is common in the fruit processing industry where a low pH exists along with a high sugar concentration. To get rid of low pH bulking, the objective is to increase the pH by adding either a caustic solution or a buffer solution to increase the alkalinity. A possibly better alternative is to provide pretreatment to eliminate the low pH initially. A third process control change would involve decreasing any nitrification that is occurring, since nitrification tends to depress aeration tank pH. Or as a related solution, increase denitrification in the aeration tank to increase alkalinity and pH.

Condition 13 - Nutrient Deficiency

Bulking Types 021N, 0041, 0675, and Thiothrix have been known to cause bulking when deficient in either nitrogen or phosphorus (Jenkins, et al., 1993). The control objective is to increase nutrients so the ammonia plus nitrite plus nitrate is greater than 1 mg/L in the effluent, and phosphate is greater than 0.5 mg/L in the effluent.

Condition 14 - Sulfide Bulking

Thiothrix, Beggiatoa, and types 021N and 0914 oxidize sulfide into elemental sulfur, depositing sulfur granules within the cell (Jenkins, et al., 1993). The control objective is to remove the source of the sulfide. Pre-aeration oxidizes the sulfide so it is not available to the filaments. Better aeration and mixing help if the sulfide is being formed in the treatment process itself. There is also the possibility that addition of iron compounds such as ferric chloride or ferrous sulfate would chemically bind the sulfide, making it unavailable for the microorganisms.

Condition 15 - Readily Metabolized Substrate Bulking

Types 1851, 021N, Nostocoida limicola, H. hydrossis, S. natans, and Thiothrix species all can rapidly metabolize short-chain organic acids (Jenkins, et al., 1993). Industrial systems may receive organic acids directly in the influent and biological nutrient removal (BNR) systems may produce those acids, as do anaerobic selectors. The control objective is to remove the organic acid source either through pretreatment or installation of an appropriate selector (aerated, anoxic, or anaerobic).

Condition 16 - Slowly Metabolized Substrate

Types 0041, 0675, and 0092 along with M. parvicella are known to grow well on slowly metabolized food. There are no real answers to controlling this growth to date, but it appears that maintaining good mixing and proper dissolved oxygen throughout the aeration process helps. These are also associated with older sludges. Therefore, reducing MCRT often reduces their growth.

Condition 17 - Surface Seeding

Organisms such as Sphaerotilus natans, Thiothrix, Beggiatoa, fungi, and type 1701 can grow on upstream surfaces such as pipes or attached growth pretreatment systems. As these organisms slough off, they provide a large population of filaments for the aeration tank. If the environment in the aeration tank is not conducive to growth of these filaments, they will die out without proliferating.

However, if they find a suitable environment in the aeration tank, they will proliferate accordingly. Therefore, the answer to control is to make sure that the aeration system provides enough DO, removes sulfide, or does whatever else is necessary to remove good filament growth conditions in the aeration tank.

Conditions 18, 19, and 20 - Pin-floc

Pin-floc is tiny, usually dark, pinpoint-sized floc associated with very old sludge. Three different problems, specifically numbers 18, 19, and 20, are associated with pin-floc.

Condition 18. Pin-floc is often found in situations where the treatment plant is grossly underloaded and the mixed liquor suspended solids cannot be reduced any further than the present value. If it is reduced, the concentration gets so low that effective settling is impossible. Normally, one would try to reduce the MCRT, but this requires wasting and a reduced MLSS and it seldom works in this case. It may be worth trying to grow some filaments, such as low DO filaments, that would slow the settling and improve the capture of solids. Maintaining a DO between 0.1 and 0.5 in the aeration tank will usually allow low DO filaments to grow. Be careful!

Condition 19. Pin-floc is also associated with denitrification in the clarifier. Bacteria convert the nitrate to nitrogen gas and the resulting bubbles buoy floc particles to the surface. Ashing or clumping is often seen. A treatment pressure is required by reducing the total sludge units in the system.

A slight increase in wasting usually eliminates the problem, however increased returns may also be required. If an increased return rate is used, be sure the other process demands, e.g., SDT A are met. Too-high return rates are very common. The use of on/off aeration or an anoxic zone in the aeration tank may also be helpful. It allows the denitrification to occur in the aeration tank where it is not a problem rather than in the clarifier where it is a problem.

Condition 20. Pin-floc also occurs in systems where solids are unintentionally being returned from solids processing. Excessive solids in anaerobic or aerobic digester supernatant or improper solids capture from sludge dewatering systems can all cause excessive loads of tiny sludge particles that will show up as pin-floc. They may or may not be associated with denitrification, so one has to be careful to decide which is causing the problem.

Conditions 21 and 22 - Straggler Floc

Straggler floc is large, light colored, very fluffy floc that may or may not be filamentous. Microscopic observation will quickly show if it is filamentous or non-filamentous. The effects of straggler floc are made worse by poor clarifier design and by high influent or return flows. Reducing return rates often helps.

Condition 21. All of the filamentous growth conditions, Conditions 11 through 17, can cause filamentous straggler floc development and the control actions associated with those should be followed. With severe cases during peak flows, try on/off aeration or step-feed. If that does not work, clarifier modification may be required.

Condition 22.

Non-filamentous straggler floc may be observed where changes in organic loading have caused certain flocs to grow very quickly. An oxidative pressure is needed, which increases the total sludge units and decreases the food-to-microorganism ratio. Thus, a slight decrease in wasting and a slight decrease in returns often solves the problem.

Conditions 23 and 24 - Dispersed Growth

Dispersed growth is growth of individual bacterial cells or very tiny floc. The specific oxygen uptake rate (SOUR) will help identify the cause for the dispersed growth. Condition 23. Very fast growth conditions, such as those seen at start-up can exhibit dispersed growth. It is shown by extremely high SOURs. An oxidative pressure is required that increases the total sludge units and decreases the F/M ratio. Again, as in Condition 22, a decrease in wasting and a decrease in return will usually help the condition.

Condition 24. A toxic load can also cause dispersed growth. This case is shown by a very low OUR or SOUR. Once the toxic load has passed, an oxidative pressure is needed to increase the total sludge units and decrease the food-to-microorganism ratio. Thus, a decrease in wasting and decrease in return is appropriate.

High Effluent Soluble BOD or Ammonia

Conditions 25 through 29 all relate to high soluble BOD or ammonia in the effluent. It is important to determine the respiration rate because the specific cause of the problem can easily be determined with the respiration rate, or SOUR. Conditions 25 and 26, very low SOUR. Condition 25 is shown by a zero SOUR and is caused by the fact that all of the microorganisms have been killed. They cannot use the oxygen.

Once the toxic material is removed, it is imperative that the total sludge units are increased and the food-to-microorganism ratio is decreased, thus a decrease in wasting is required. If the SOUR is low, then Condition 26 is shown. The microorganisms were either inhibited, or a certain number, but not all, of the microorganisms were killed. In either case, an oxidative, pressure is needed again once the toxic material is removed.

A decrease in wasting and a decrease in return is effective until the mass of live microorganisms has been increased to the level needed for proper treatment.

Conditions 27 through 29, medium to high SOUR.

If the respiration rate or SOUR is medium to high, then a non-toxic situation exists.

Condition 27.

A medium SOUR can be due to the material in the influent being extremely hard for the microorganisms to break down. If this is the case, an oxidative pressure is needed and an increase in the solids detention time in the aerator and decrease in F/M is required. Thus, decreased wasting and decreased return will help. This supplies more microorganisms and more SDT A for the microorganisms to do the job.

Condition 28.

A medium SOUR can also be found with slight inhibition, a condition very similar to Condition 26 and decreased wasting and decreased return should help.

Condition 29.

A high SOUR or high effluent NH₃ relates to a hydraulic or organic overload. In this case, there are not enough microorganisms or enough time in the aeration tank. to adequately treat the BOD or remove the ammonia. In this case, an oxidative pressure is needed to increase the solids detention time in the aerator and to decrease the food-to-microorganism ratio.

Decreased wasting and decreased return will help. Step Feeding or contact stabilization can also be very effective with condition 29. This reduces the solids loading on the clarifier, while allowing maintenance of a larger mass of microorganisms.

Low Effluent pH

The last general condition that requires consideration is low effluent pH, conditions 30-32. It is usually caused by one of two reasons, low influent pH or low alkalinity water with nitrification. Either can cause regulatory noncompliance.

Condition 30.

If the influent pH is low (acidic), there is a good chance that the condition will go through the plant and show-up in the effluent. Chemical addition to raise the pH is the immediate solution. Lime, soda ash, or sodium bicarbonate are normally used for pH adjustment. However, the ultimate solution is to eliminate the low pH source from the collection system by enforcing pretreatment requirements. An industrial system may have to live with pH adjustment.

Condition 31.

If the influent pH is satisfactory, then the low effluent pH is usually caused by nitrification in combination with low natural alkalinity in the wastewater. If ammonia removal is required, then nitrification must continue. Use of on/off aeration or provision for an anoxic zone often returns enough alkalinity to satisfactorily raise the pH. However, if neither of these is possible, then pH adjustment similar to Condition 30 may be required.

Condition 32.

With satisfactory influent pH near 7.0 and nitrification not required, the MCRT or DO can often be reduced enough to inhibit nitrification. With no nitrification, there is no alkalinity reduction through the aeration process and the pH remains stable. However, in systems that naturally nitrify, such as extended aeration, a solution for Condition 31 may have to be applied, if MCRT and DO control cannot provide a solution.

Relationships between Process Variables

References #2 and #9.

Sludge age should be the primary control variable for all activated sludge systems.

Constant Mixed Liquor Suspended Solids

One of the easiest control procedures for activated sludge systems is the Constant Mixed Liquor Suspended Solids method.

In this method, the operator selects a certain MLSS concentration or range of mixed liquor concentrations that produce the best effluent and the highest removal efficiencies. This specific value or range must be determined experimentally. When the operator finds the optimum MLSS concentration for each plant and water temperature, the attempts to maintain this value by adjusting the sludge wasting rate.

One rule of thumb for activated sludge systems is that for every pound of BOD removed in the secondary system a half a pound of new solids is generated through reproduction of the organisms and addition of new organisms from the influent wastes. Therefore, the operator tries to waste the proper amount of solids to keep his selected optimum mixed liquor concentration constant. Be sure to sample for MLSS at the same time and location each day as the influent flow and RAS rates change and effect the MLSS concentration.

If the MLSS concentration is above the desired concentration, wasting of the excess solids will have to be started or increased. If the MLSS concentration is below the desired concentration level, wasting should be decreased or stopped.

Operators should keep in mind that in most cases it is better to waste continuously over 24 hrs/day, seven days a week than to waste intermittently.

Drastic changes in sludge wasting rates are undesirable. Increases or decreases in wasting should be made gradually, i.e., 20 - 25 percent per day.

Return Activated Sludge Control

To properly operate the activated sludge process, a good settling mixed liquor must be achieved and maintained. The MLSS are settled in a clarifier and then returned to the aeration tank as the Return Activated Sludge (RAS).

The RAS makes it possible for the microorganisms to be in the treatment system longer than the flowing wastewater. For conventional activated sludge operations, the RAS flow is generally about 20 to 40 percent of the incoming wastewater flow.

Changes in the activated sludge quality will require different RAS flow rates due to settling characteristics of the sludge.

There are two basic approaches that can be used to control the RAS flow rate. These approaches are based on the following:

- Controlling the RAS flow rate independently from the influent flow.
- Controlling the RAS flow rate as a constant percentage of the influent flow.

Constant RAS Flow Rate Control

Settling the RAS at a constant flow rate that is independent of the aeration tank influent wastewater flow rate results in a continuously varying MLSS concentration that will be at a minimum during peak influent flows and a maximum during minimum influent flows. This occurs because the higher influent flow dilutes the MLSS during peak flow, although the solids are being removed at a constant rate.

Similarly, at minimum influent flow rates, the MLSS are being returned to the aeration tank at a relatively higher rate than are flowing into the clarifier. The aeration tank and the secondary clarifier must be looked at as a system where the MLSS are stored in the aeration tank during minimum wastewater flow and then transferred to the clarifier as the wastewater flows initially increase. In essence, the clarifier acts as a storage reservoir for the MLSS, and the clarifier has a constantly changing depth of sludge blanket as the MLSS moves from the aeration tank to the clarifier and vice versa. The advantage of using this approach is simplicity, because it minimizes the amount of effort for control. It is also especially advantageous for small plants because of their usually limited flexibility.

Comparison of Both RAS Control Approaches

The advantages of the constant RAS flow approach are as follows:

- Simplicity.
- Maximum solids loading on the clarifier occurs at the initial start of peak flow periods.
- Requires less operational attention and time.

Constant Percentage RAS Flow Rate Control

The second approach to controlling RAS flow rate requires a programmed method for maintaining a constant percentage of the aeration tank influent wastewater flow rate. The program may consist of an automatic flow measurement device, a programmed system, or frequent manual adjustments. The programmed method is designed to keep the MLSS more constant through high and low flow periods.

In general, it appears that most activated sludge operations perform well and require less attention when the constant RAS flow rate approach is used. Activated sludge plants with flows of 10 mgd or less are often subject to large hydraulic surges, and performance of these plants will benefit the most from the use of this approach.

The Advantages of the Constant Percentage RAS Flow are the Following:

- Variations in the MLSS concentration are reduced and the F/M varies less.
- The MLSS will remain in the clarifier for shorter time periods, which may reduce the possibility of denitrification in the clarifier.

Disadvantages of the Constant Percentage RAS Flow are the Following:

- A disadvantage of using the constant flow approach is that the F/M is constantly changing. The range of F/M fluctuation due to the effect of short-term variation in the MLSS (because of hydraulic loading) is generally small enough so that no significant problems arise due to using this approach.
- The most significant disadvantage of the second approach is that the clarifier is subjected to maximum solids loading when the clarifier contains the maximum amount of sludge. This may result in solids washout with the effluent.

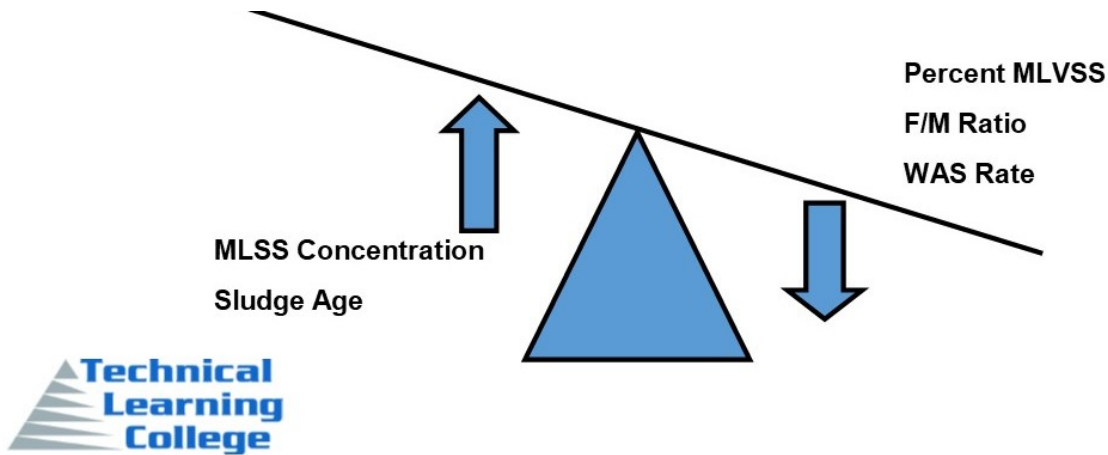

RELATIONSHIP BETWEEN A/S PROCESS CONTROL VARIABLES

Why Does the MLSS Increase with Increasing SRT?

As sludge age is increasing, fewer kilograms (pounds) of MLSS are removed from the system in the WAS each day. This is the definition of sludge age. For a 10-day sludge age, one-tenth (10%) of the solids are removed each day. For a 5-day sludge age, one-fifth (20%) of the solids are removed each day. Removing fewer kilograms (pounds) of MLSS causes the MLSS concentration (mg/L) in the activated sludge basins to increase.

Design and Operating Parameters for Activated Sludge Process (US EPA 1971, 1978B)

Process Modification	Solids Retention Time, Days	F/M kg BOD Applied/kg MLSS•d (lb/d/lb)	Volumetric Loading, Kg BOD ₅ /m ³ •d (lb BOD ₅ /d/1000cu ft)	MLSS, mg/L	Hydraulic Detention Time, hr
Conventional (plug flow)	5 to 15	0.2 to 0.4	20 to 40	1 500 to 3000	4 to 8
Extended aeration	20 to 30*	0.05 to 0.15	10 to 25	3000 to 6000	18 to 36
Step-feed	3 to 7	0.2 to 0.4	40 to 60	2000 to 3500	3 to 5
Pure oxygen	3 to 20	0.25 to 1.0	150 to 200	4000 to 7000	2 to 4

*Excessively long SRTs are no longer recommended because of the growth of filamentous bacteria and deterioration of final effluent quality that can occur at long SRTs.

Design Conditions

The activated sludge process and its several modifications may be employed to accomplish varied degrees of removal of suspended solids and reduction of BOD and ammonia.

Choice of the process most applicable will be influenced by the proposed plant size, type of waste to be treated, and degree and consistency of treatment required. All designs should provide for flexibility to incorporate as many modes of operation as is reasonably possible.

Plant Influent Flow and Load Monitoring

References # 18 USEPA

Accurate plant influent flow measurement and monitoring are essential for efficient control of the A/S process. In many plants, influent flow rate is used as a main activated sludge system control parameter, adjusting the transfer (RAS) rate of solids from the secondary clarifiers to the aeration basins proportionally to the influent flow changes. As a minimum, installation of on-line flow measurement devices is recommended for continuous monitoring of plant influent flow and RAS and WAS flowrates.

Separation of MLSS from the liquid stream is vital to the operation and performance of activated sludge systems. This is typically achieved by gravity in secondary clarifiers although membranes can also be used. Secondary clarifiers, both circular and rectangular, are nearly identical to primary clarifiers. There are a few variations in often incorporated circular secondary clarifiers that are not used in primary clarifiers, including

- Peripheral feed, peripheral take-off flow path,
- Presence of a floc well outside of a smaller center well
- Presence of interior baffles,
- Equipment to control algae growth on weirs and launders,
- Hydraulic suction method of settled sludge removal,
- Rider pipe mechanisms for settled sludge removal, and
- Differences in depth and floor slope.

Secondary clarifiers separate flocculated biomass from the liquid in the mixed liquor. Secondary clarifier performance depends on numerous factors, including activated sludge characteristics (settleability), hydraulic loading rate, solids loading rate, return activated sludge flow, and physical features of the clarifier. Key secondary clarifier effluent quality monitoring and control parameters are TSS, BOD, ammonia, total nitrogen and total phosphorus concentrations and removal efficiencies.

The solids loading rate (SLR) is the quantity of solids that are supplied to by a secondary clarifier per square foot of surface area. An increase above the design SLR will likely result in an increase in solids leaving the clarifier. **For secondary clarifiers that follow an activated sludge system the solids loading rate should fall in the range of 12 to 30 pounds of solids per day per square foot of clarifier surface area.** Depending on the textbook you reference, you will see a somewhat different range for the SLR.

The formula for calculating the solids loading rate for a secondary clarifier is:

$$\text{Solids Loading} \frac{\text{lb}}{\text{day}} \frac{1}{\text{ft}^2} = \frac{\text{Solids Applied} \frac{\text{lb}}{\text{day}}}{\text{Clarifier Surface Area, ft}^2}$$

Where the solids applied represents the pounds of mixed liquor suspended solids flowing to the clarifier, calculated as follows:

$$\text{Solids Applied } \frac{\text{lb}}{\text{day}} = \text{Flow, MGD} \times \text{MLSS } \frac{\text{mg}}{\text{L}} \times 8.34 \frac{\text{lb}}{\text{gal}}$$

Advantages and Disadvantages of Common Process Control Strategies Chart 1

Process Control Method	Advantages	Disadvantages
Sludge age- Including MCRT, SRT, and SRT_{aerobic}	<p>Widely used with reliable results.</p> <p>Based upon growth kinetics.</p> <p>Accounts for transformation of influent BOD and TSS into biological solids (MLSS).</p> <p>Automatically adjust MLSS concentrations to match BOD load, thereby simultaneously controlling MLSS concentration and F/M.</p> <p>Operator does not need to predict or match influent conditions.</p> <p>Clear mechanism for calculating wasting rates.</p> <p>Target sludge age controls presence or absence of different types of bugs in the process.</p> <p>Self-stabilizing.</p> <p>Produces excellent sludge quality when the target MCRT/SRT is within a reasonable range.</p> <p>When kept in the correct range for a given water temperature maintains stable nitrification and minimizes filament growth.</p>	<p>Requires accurate measurement of MLSS and WAS solids.</p> <p>May be difficult to obtain representative samples needed for calculations.</p> <p>Staffing limitations in small systems may make sludge age control difficult to fully implement.</p> <p>Control charts are recommended along with calculations of running averages to minimize the influence of bad data points or days when wasting is not performed.</p>

Advantages and Disadvantages of Common Process Control Strategies Chart 2

Process Control Method	Advantages	Disadvantages
MCRT	<p>Accounts for the total sludge inventory by including both the activated sludge basins and clarifier solids.</p> <p>Preferred for systems with large clarifiers and smaller activated sludge basins.</p> <p>Historic data for sludge ages that promote filament growth are based on MCRT and SRT.</p>	<p>Requires more data collection than either SRT or SRT_{aerobic}.</p>
SRT_{Total}	<p>Less data collection required than for MCRT.</p> <p>Preferred for systems with small clarifiers and larger activated sludge basins.</p> <p>Historic data for sludge ages that promote filament growth are based on MCRT and SRT.</p>	<p>Assumes solids are not stored in the secondary clarifier blanket. For systems with large clarifiers relative to the activated sludge basins, this may not be true even when blankets are below 2ft (0.6 m).</p>
SRT Aerobic	<p>Used by design engineers for basin sizing.</p> <p>Ensures there is adequate aerobic basin time or space to support stable nitrification.</p> <p>May be used to adjust anoxic versus aerated zone size within basins.</p> <p>May be used to adjust on/off cycle times for SBRs.</p>	<p>Calculating SRT aerobic only may result in excessively long sludge ages, growth of filaments, and subsequent deterioration of sludge settleability.</p> <p>Historic data for predicting the growth of filamentous bacteria are based upon MCRT or SRT total and not SRT aerobic.</p>

Advantages and Disadvantages of Common Process Control Strategies Chart 3

Process Control Method	Advantages	Disadvantages
<p>Constant MLSS (mass or Concentration)</p>	<p>Simple to understand.</p> <p>Minimum amount of laboratory data required.</p> <p>Capable of producing good settling sludge and effluent quality when influent loads are consistent.</p> <p>Can approximate SRT control for some systems.</p> <p>Best suited for WWTPs that are not required to nitrify.</p>	<p>Constant MLSS does not hold sludge age constant, which may result in variable sludge quality (poor settleability) and uncontrolled loss of nitrification.</p> <p>No clear mechanism for calculating wasting rates.</p> <p>If the influent load is not constant, the SRT and F/M can fluctuate.</p> <p>Filamentous bacteria may be easily retained when the unmonitored SRT exceeds the SRT required for filament growth.</p> <p>More prone to foaming and bulking.</p>
<p>Constant F/M</p>	<p>Some argue that constant F/M has an advantage in WWTPs, such as those that receive large quantities of industrial wastewater, where the influent characteristics can change rapidly.</p> <p>Should produce a consistently settling sludge.</p> <p>Early work in activated sludge microbiology was based upon F/M.</p>	<p>Requires accurate measurement of MLSS, MLVSS, WAS and influent BOD.</p> <p>Operator must predict and match changing influent conditions.</p> <p>Necessarily uses 5-day-old data in the case of BOD or more than 3-hour-old data in the case of COD.</p> <p>Reactively responds to past conditions. May not maintain stable nitrification.</p> <p>No clear mechanism for calculating wasting rates.</p> <p>Chasing F/M may drastically alter sludge age.</p>

Recommended Minimum Sampling and Analysis Frequencies for A/S Chart

Sampling Location	Analysis ^a	Frequency ^b	Sample Type
Activated Sludge basin influent	pH	Daily	Grab
	BOD	Weekly	Composite
	TSS	Weekly	Composite
	Total Kjeldahl Nitrogen ^c	Monthly	Grab
	Ammonia	Monthly	Grab
	Alkalinity	Monthly	Grab
Activated sludge basin	DO	Daily (Continuous)	In situ
	Temperature	Daily (Continuous)	In situ
Activated sludge basin effluent	TSS (Mixed liquor suspended solids)	Daily	Grab
	Settleability	Daily	Grab
	pH	Weekly	Grab
	Microscope	Weekly	Grab
RAS	TSS	Daily	Grab
	Flow	Daily	Totalizer
WAS	TSS	Daily	Grab
	Flow	Daily	Totalizer
Secondary clarifier	Sludge Blanket	Daily	In situ
Secondary clarifier effluent	BOD	Weekly	Composite
	TSS	Weekly	Composite
	Ammonia ^{c e}	Weekly	Composite
	Nitrite ^{c e}	Weekly	Grab & Composite
	Nitrate ^{c e}	Weekly	Grab & Composite
	Total phosphorus ^{c e}	Weekly	Composite
	pH	Daily	Grab
Facility effluent	Turbidity	Daily	Grab
	Fecal coliform ^d	Daily	Grab
	Chlorine residual ^d	Daily	Grab

a May not show all analysis required; check with permit requirements.

b Sampling frequencies may need to be increased for process control or permit requirements.

c May not be required if nutrients (ammonia, phosphorus, etc.) are not a concern.

d May not be required if disinfection is not required: check with discharge permit.

e Although it may be adequate for the NPDES report, monthly sampling is not good enough for process control; recommend weekly.

Secondary Clarifiers Sub-Section

Reference ##2 & #3

Secondary clarifiers handle a large concentration and volume of solids due to the mixed liquor suspended solids (MLSS) leaving the activated sludge process. The typical range for MLSS concentrations in the activated sludge process is between 1,800 and 4,000 mg/L. This range applies fairly well to municipal wastewater plants but often does not nearly match conditions in an industrial wastewater system.

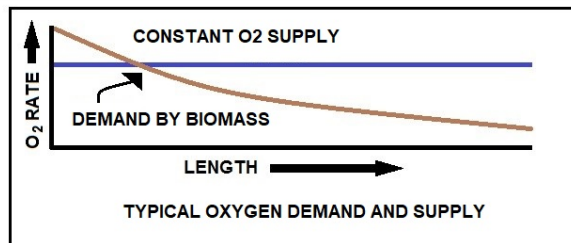
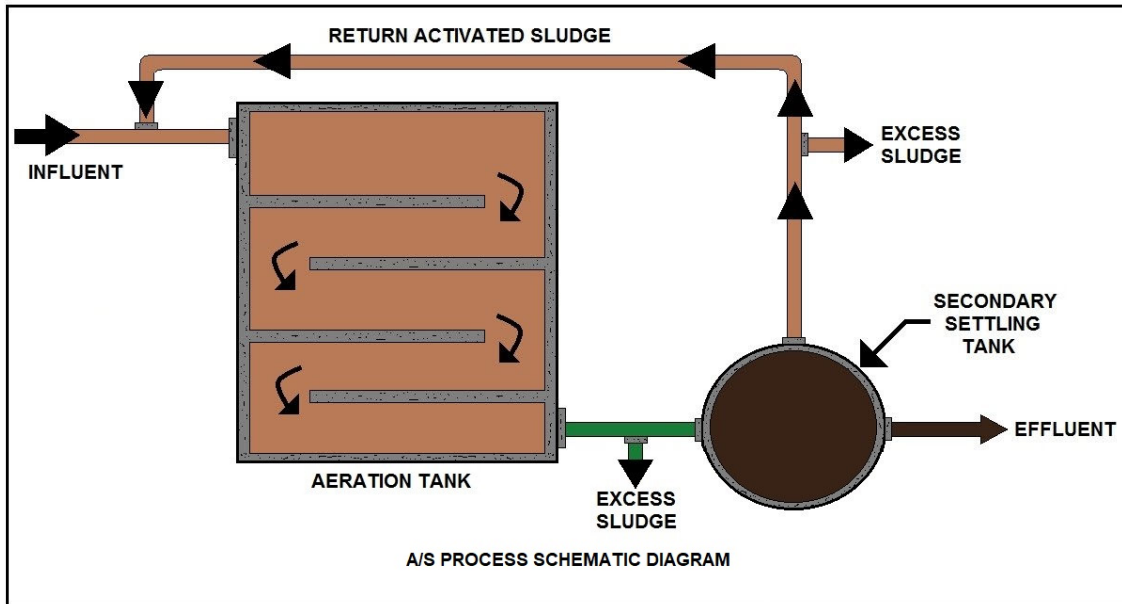

DIAGRAM OF CONVENTIONAL ACTIVATED SLUDGE PROCESS

RAS CONCENTRATION

Varying the return activated sludge (RAS) flow rate will affect the concentration and detention time of clarified solids. Adjusting the RAS pumping rate allows the return of more or less concentrated solids while also increasing or decreasing the depth of the sludge blanket. RAS flow rates can be paced off influent flow rates, time, or organic loading.

POOR SLUDGE SETTLING

Filamentous bulking and polysaccharide (slime) bulking are common causes of poor settling sludge. Other possibilities for poor settling may include hindered settling due to denitrification which creates an upward force working against settling because nitrogen gas wants to float the sludge, or hindered settling due to the MLSS concentration being too high.

OLD SLUDGE

Old sludge consists of sludge in which the sludge age is too high to be most effective in a particular activated sludge process. Dark brown foam and a greasy or scummy appearance on the aeration tank is an indicator of old sludge. Settling in the clarifier is rapid, but pin floe can be present in the effluent and the effluent is hazy. Old sludge is often associated with a low F/M ratio. To correct for old sludge, it is necessary to increase wasting rates and return less sludge to the aeration basin. This will reduce the amount of solids under aeration, increase the F/M ratio and decrease the sludge age.

MCRT & SRT

In MCRT, the M is for “mean,” which is a substitute for “average.” The remaining letters, CRT, represent cell residence time — how long a particular bacterial cell, or a pound of bacteria, remains in the activated sludge secondary treatment train. MCRT is normally expressed in days.

SRT — solids retention time — is sometimes used as a synonym for MCRT. They typically mean the same thing, but they may be calculated using different pieces of data. SRT can be viewed as the mass of the solids in the aeration tanks, whereas MCRT is the total mass of the bacteria in the system. SRT is also expressed in days

In essence, MCRT would be calculated with the volatile suspended solids (VSS) values (for example, mixed liquor VSS, effluent VSS, waste sludge VSS), whereas SRT would be calculated using the total suspended solids (TSS) values (for example, mixed liquor TSS, effluent TSS, waste sludge TSS).

Various reference manuals explain methods of calculating MCRT and SRT. One MCRT alternative for calculation is to include the solids in the secondary clarifiers. If a treatment facility has multiple clarifiers and carries a high sludge blanket (greater than 3 feet) in each, then accounting for the solids in the clarifiers can become important for accurate mass balance process control approaches.

The calculations for MCRT and SRT reveals how closely related these two are:

$$\text{MCRT/SRT (Days)} = \frac{\text{Pounds of Solids Under Aeration}}{(\text{Pounds per Day of Solids in effluent}) + (\text{Pounds per Day of Solids Wasted from System})}$$

SRT

Solids Retention Time measures only the mass of TSS (pounds of MLSS) contained in the bioreactor divided by the mass of TSS lost and removed from the treatment system. As with the MCRT calculation, TSS is lost from the system as solids overflowing the secondary clarifier (plant effluent TSS lb/d). TSS is removed intentionally from the system through the wasting of activated sludge (WAS lb/d). Like the MCRT, the SRT unit of measure is days.

$$SRT, d = \frac{\left(V_{AB}, Mgal \times MLSS \frac{mg}{L} \right)}{\left(Q_{WAS} \frac{Mgal}{d} \times TSS_{WAS} \frac{mg}{L} \right) + \left(Q_{EFF} \frac{Mgal}{d} \times TSS_{EFF} \frac{mg}{L} \right)}$$

The simple process flow diagram in TSS Pounds in and leaving diagram highlights where the pounds of material (solids) are coming from in the calculation of the MCRT and/or the SRT. Remember, the MCRT includes the solids in the secondary clarifier whereas the calculation of the SRT does not include the solids in the clarifier.

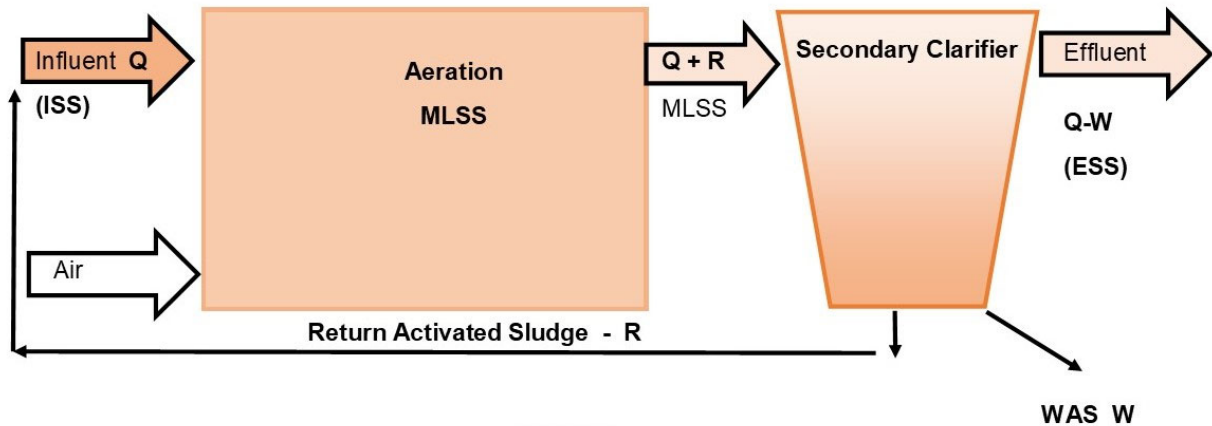

$$R = \frac{MLSS}{RAS - MLSS} \times Q$$

Where,

MLSS is the mixed liquor suspended solids concentration, mg/L

RAS is the return activated sludge solids concentration, mg/L

Q is the influent flow rate in units of million gallons per day (MGD)

WAS is the waste activated sludge concentration, which is typically the same value as the RAS concentration



AERATION TANK MASS BALANCE DIAGRAM AND FORMULA

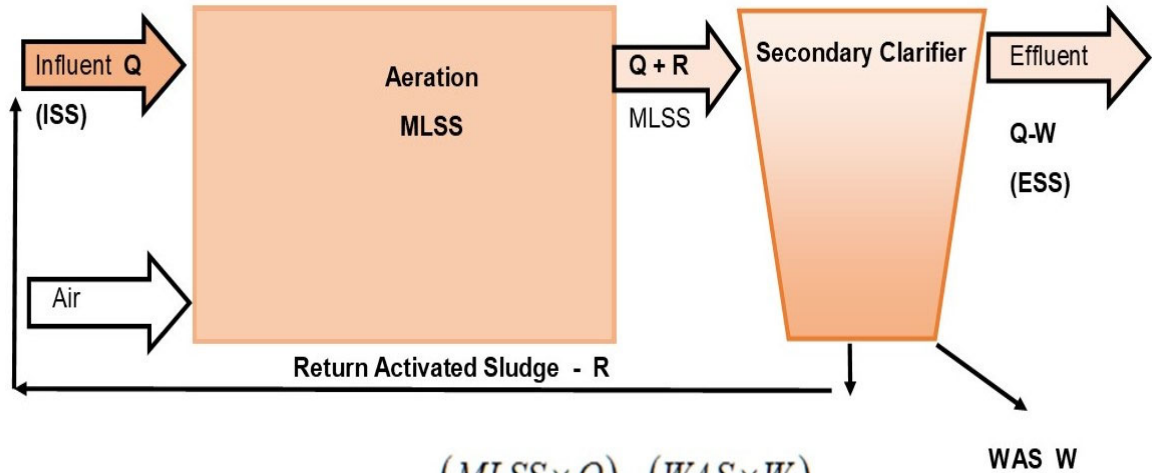

$$R = \frac{(MLSS \times Q) - (WAS \times W)}{RAS - MLSS}$$

Where,

MLSS is the mixed liquor suspended solids concentration, mg/L

RAS is the return activated sludge solids concentration, mg/L

Q is the influent flow rate in units of million gallons per day (MGD)

WAS is the waste activated sludge concentration, which is typically the same value as the RAS concentration



SECONDARY CLARIFIER MASS BALANCE DIAGRAM AND FORMULA

Effect of Effluent TSS on MCRT and SRT Calculation Chart

References #2 & #19

Effluent TSS Concentration and Mass	MCRT, Days		SRT, Days	
	Effluent TSS Included	Effluent TSS Not Included	Effluent TSS Included	Effluent TSS Not Included
15 mg/L 454.2 kg (1001 lb)	8.2	9.9	7.9	9.5
30 mg/L 908.4 kg (2001.6 lb)	7.0	9.9	6.7	9.5
60 mg/L 1816.8 kg (4003.2 lb)	5.5	9.9	5.2	9.5
100 mg/L 3028 kg (6672 lb)	4.2	9.9	4.2	9.9

Potential Effects of Foaming Events on Sludge Age

During a foaming event, it is possible for a significant portion of the sludge inventory to be entrained foam. Foam solids are not easily quantified and aren't typically included as part of the total sludge inventory.

As a result, during a foaming event, sludge age may be higher than the sludge age calculations indicate. In extreme foaming events, the foam may overflow the A/S basins and end up outside of the basins on the grounds. The loss of solids decreases sludge age calculations. In this case, the sludge age may be much lower than the sludge age calculations indicate.

Wasting Frequency

The SRT or MCRT should be calculated at least once per day and wasting rates adjusted accordingly to maintain a constant SRT/MCRT. Wasting over longer periods of time, 10 minutes out of every hour for example, is preferable because this practice maintains a more constant SRT/MCRT, which in turn, maintains sludge settleability.

Mass Wasting

Mass wasting of solids should be avoided because this does not control SRT/MCRT and can cause sudden changes in sludge settleability. As a general rule, the mass of solids wasted from the system each day should not change by more than about 15% over the previous day. This is kilograms or pounds removed, not gallons.

When to Use Aerobic SRT, MCRT, or SRT

Reference #20

Whether a facility chooses to use SRT_{aerobic} , SRT, or MCRT for process control depends, in part, on how their process is configured and whether ammonia removal is required by the discharge permit.

An SBR with an effluent ammonia limit will find SRT_{aerobic} useful for controlling the amount of air-on time in a treatment cycle as will facilities with the ability to independently control the airflow to different portions of their activated sludge basins or to operate some basins as either anoxic or aerobic.

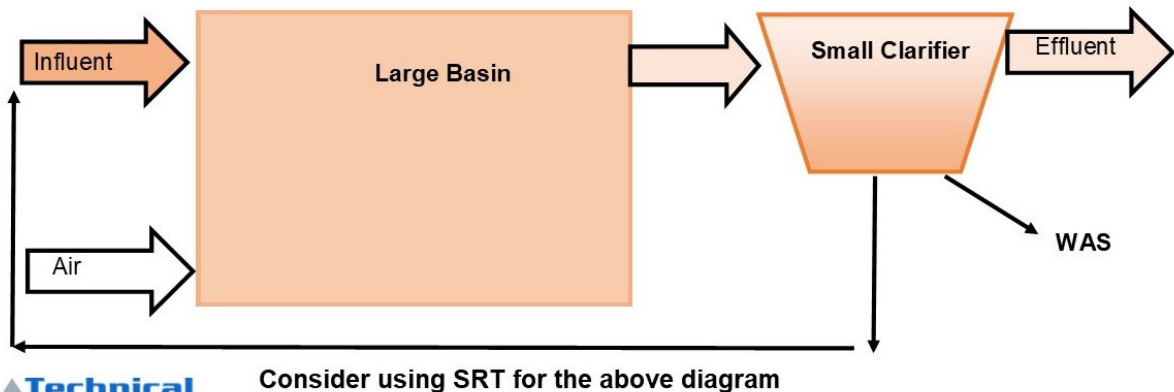
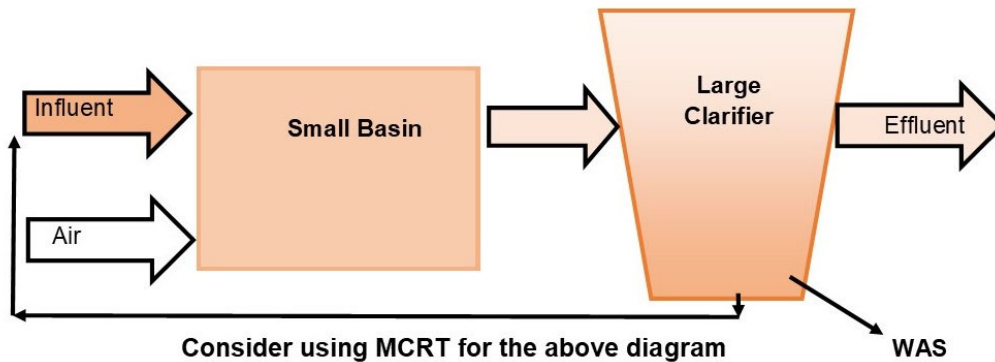

A/S BASIN SIZE VERSUS CLARIFIER SIZE

For a facility that has small activated sludge basin(s) and large clarifier(s), MCRT may be more appropriate because even when the clarifier sludge blanket is below 0.6 m (2 ft) of depth, a significant portion of the MLSS may be in the clarifier.

Facilities with large activated sludge basins, like oxidation ditches, may prefer to use SRT because it requires less sampling and analysis and, even when the clarifiers contain several feet of blanket, the majority of the MLSS will be in the activated sludge.

PHOSPHORUS LOADING

Phosphorus concentrations can be very high for limited periods but turbulent conditions, short residence times, and shading from sediment often prevent excess algae growth. At low flow, the proportion of effluent to stream flow can be much higher. Point sources like wastewater treatment facilities can dominate in-stream phosphorus loading. Low flow conditions often occur in late summer months when temperatures are higher and water is moving slower, all of which tend to encourage algae growth.



PHOSPHOROUS CONTROL

Controlling **phosphorous** discharged from municipal and industrial wastewater treatment plants is a key factor in preventing eutrophication of surface waters. **Phosphorous** is one of the major nutrients contributing in the increased eutrophication of lakes and natural waters.



FINAL CLARIFER SOLIDS LOADING RATE (SLR)

The rate at which the activated sludge is returned from the final clarifiers to the aeration basins, along with the influent flow, effects the flow of solids into the clarifiers. Aeration basin mixed liquor suspended solids must have sufficient time to settle and be returned or wasted in the activated sludge system. Clarifiers are designed for certain solids loading rates that should not be exceeded.



Inclusion of Clarifier Blanket Solids in the Sludge Age Calculation Chart

Arguments Against Inclusion	Arguments for Inclusion
<p>If the volume of the clarifier is just multiplied by the MLSS concentration, the actual amount of solids could be significantly different in the clarifier.</p>	<p>This is simplest, and could be useful approximation especially if the depth of the sludge blanket varies over each day</p>
<p>Collecting a representative sample from a clarifier blanket is not always possible. Clarifiers with covers or those in buildings with low ceilings can be difficult to access with a long core type sampler.</p>	<p>Clarifier blanket depth can be estimated with a hand-held TSS meter or by lowering a modified core sampler into the clarifier on a string.</p> <p>Once the blanket depth is known, the mass of solids in the clarifier can be calculated if the blanket concentration is assumed equal to the RAS concentration.</p>
<p>Microorganisms in the clarifier blanket do not have access to food and oxygen. They do not contribute to treatment while in the clarifier.</p>	<p>Microorganisms in the clarifier blanket are only in the blanket for a short period of time each cycle. They are exposed to both food and oxygen most of the time and do contribute to overall treatment capacity.</p>
<p>Assuming the clarifier blankets are maintained below 2 ft., the percentage of solids in the clarifier is insignificant compared to the total inventory.</p> <p>Ignoring these solids won't significantly change the results of the sludge age calculation. When blanket levels are fairly constant, the error in the sludge age calculation will also be constant.</p>	<p>For facilities that carry deeper sludge blankets in the clarifier, experience poor sludge settleability, or that have large clarifiers relative to their activated sludge basins, the portion of solids in the clarifier blanket can be significant.</p> <p>Ignoring the solids in these situations can have a dramatic effect on the results of the sludge age calculation for some facilities.</p> <p>To be clear, deep sludge blankets in clarifiers are not recommended because this practice can degrade effluent quality and affect MLSS behavior.</p>
<p>Design engineers use process kinetics to design and size the activated sludge basins. These calculations only include the solids in the basins and not the clarifier.</p>	<p>The kinetics equation used to size the activated sludge basins predict the total mass of solids produced. Although some of these solids may be in the clarifier temporarily, they are still included in the design equations even though engineers often assume 100% of the sludge inventory remains in the activated sludge basins.</p>

<p>Loading parameters (kg BOD/m³ or lb BOD/1000 cu ft.) for the activated sludge process were originally developed using only the MLSS in the activated sludge basin and not the clarifiers.</p>	<p>Again, kinetics dictate the mass of the MLSS produced per mass of BOD or COD received. Some of the MLSS may temporarily be in the clarifier, but it was produced in response to the influent load.</p>
-------------------------------------------------------------------------------------------------------------------------------------------------------------------------------------------------------------	-----------------------------------------------------------------------------------------------------------------------------------------------------------------------------------------------------------

Nitrification Time

References #10 & #11

Bacteria remove nitrogen from wastewater by a two-step biological process: nitrification followed by denitrification. (Technically, it is a three step process: ammonification precedes nitrification and denitrification). While traveling through sewer pipes, the majority of the nitrogen contained in raw sewage (urea and fecal material) is converted from organic-nitrogen to ammonia through a process called hydrolysis.

Biological nitrification is the microbe-mediated process of oxidizing ammonia to remove nitrogenous compounds from wastewaters. Domestic sewage typically contains 20 to 40 mg/L of ammonia nitrogen (NH₄-N). Organic matter containing nitrogen, e.g., protein and nucleic acid, also biodegrades to release ammonia. Releasing this ammonia into receiving streams has a direct toxic effect on fish and other animals and, in addition, causes significant oxygen depletion.

Nitrate is regarded as an undesirable substance in public water. Although it occurs naturally in water, elevated levels of nitrate in groundwater usually result from human activities, such as over use of chemical fertilizers in agriculture and improper disposal of human and animal wastes. High nitrate concentration in drinking water may cause serious problems in human and animals. In order to protect against this effort, the US EPA established the maximum contamination level of nitrate in drinking water at 10 mg NO₃.

Significant Retention Times

There are two significant retention times in an anaerobic digester. These are solids retention time (SRT) and hydraulic retention time (HRT). The SRT is the average time that bacteria (solids) are in the anaerobic digester. The HRT is the time that the wastewater or sludge is in the anaerobic digester. The SRT and the HRT are the same for a suspended-growth anaerobic digester that has no recycle. If recycle of solids is incorporated in the operation of the digester, then the SRT and HRT may vary significantly.

Solids Retention Time (SRT) is the average time a unit of cell mass stays in the activated sludge system. It is based on the suspended solids. The difference in the SRT equation and the sludge age equation is that while sludge age is based on what is in the aerator, solids retention is based on what is leaving the activated sludge process, including the solids in the clarifiers.

$$\text{SRT (days)} = \frac{\text{Lbs/day of suspended solids in aeration basin}}{\text{Lbs/day of suspended solids wasted from the system}}$$

Because the generation time, that is, the time required for a population of bacteria to double in size, of methane-forming bacteria is relatively long compared with aerobic bacteria and facultative anaerobic bacteria, typical SRTs for anaerobic digesters are >12 days.

Detention Times

Detention times <10 days are not recommended. At detention times <10 days significant washout of methane-forming bacteria occurs. This indicates that SRT, not HRT, is the more important retention time. The SRT is not greatly affected by the nature of the wastewater or sludge under treatment, unless the wastewater or sludge is toxic to the bacteria.

Anaerobic digesters that utilize fixed-film media for the growth of bacteria favor the development of a concentrated mass (biomass) of bacteria that are attached to the media. The biomass prevents the washout of large numbers of bacteria and permits high SRT values.

High SRT values are advantageous for anaerobic digesters. High SRT values maximize removal capacity, reduce required digester volume, and provide buffering capacity for protection against the effects of shock loadings and toxic compounds in wastewaters and sludges. High SRT values also help to permit biological acclimation to toxic compounds. High SRT values may be achieved through two measures. First, the volume of the digester may be increased. Second, the concentration of the bacteria (solids) may be increased.

Nitrifiers are Strict Aerobes

Design engineers use SRT_{aerobic} to determine the size of the aerated basins for facilities that must remove ammonia. The bacteria responsible for converting ammonia to nitrite and nitrate, the nitrifying bacteria, grow much slower than the bacteria responsible for removing BOD, especially at colder water temperatures. The nitrifiers are strict aerobes and cannot function without an adequate supply of DO. The reduction of biochemical oxygen demand, on the other hand, can take place under anaerobic, anoxic and aerated conditions.

Characteristics of the Nitrifying Bacteria

The characteristics of the nitrifying bacteria focus on the design and operation of nitrifying activated sludge processes on the amount of aerobic activated sludge basin volume or time. Some WWTPs use SRT_{aerobic} for process control, whereas others calculate both the SRT and the SRT_{aerobic} .

Activated Sludge Section Summary

References #1, #2, & #15

In its simplest form, the activated sludge process is a mechanical version of the pond in which an activated sludge basin is where wastewater is combined with oxygen and a mixed population of bacteria and other microorganisms to consume the organic material in the wastewater.

By analyzing the different characteristics of the activated sludge or the sludge quality, plant operators are able to monitor how effective the treatment plant's process is. Efficient operation is ensured by keeping accurate, up-to-date records; routinely evaluating operating and laboratory data; and troubleshooting, to solve separating from the clearer problems before they become serious.

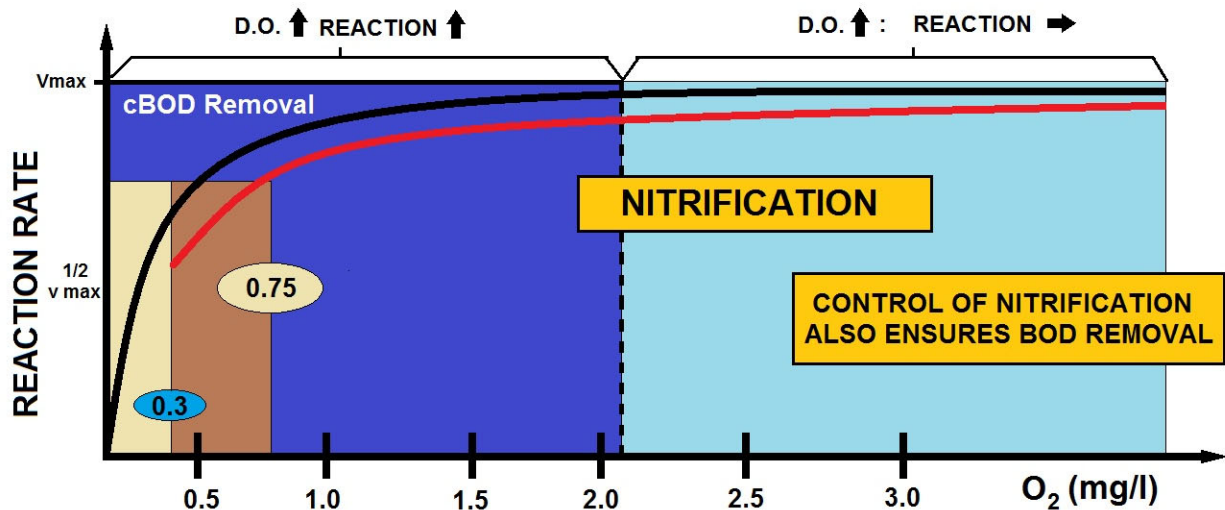

A/S PROCESS –OXYGEN CONSUMPTION IN TREATMENT

A wide range of laboratory and visual and physical test methods are recommended. Principally, these include floc and settleability performance using a jar test, microscopic identification of the predominant types of bacteria, and analysis of various chemical parameters. The treatment environment directly affects microorganisms. Changes in food, dissolved oxygen, temperature pH, and total dissolved solids, sludge age.

Activated Sludge Process

- Formation of floc particles, ranging in size from 50 to 200 μm , removed by gravity settling, leaving relatively clear liquid as treated effluent;
- In aeration tank, contact time is provided for mixing and aerating influent wastewater with microbial suspension, generally referred to mixed liquor suspended solids (MLSS) or mixed liquor volatile suspended solids (MLVSS);
- It involves production of activated mass of microorganisms capable of stabilizing waste under aerobic conditions;
- Mixed liquor then flows to clarifier where microbial suspension is settled and thickened;

- Portion of thickened solids is removed daily or periodically as process produces excess biomass;
- Settled biomass (activated sludge) is returned to aeration tank to continue biodegradation of influent;
- Typically 99% of suspended solids removed by clarification step.

Principles of A/S Operation

a) This is the actual process of bio-degradation where the coagulated organic matter is acted upon by the microorganisms and converted to harmless products and new cell tissue/cell matter.

b) Most of these settled active organisms that flow out of the aeration/reaction tank with the treated water are returned to the tank to mix with the incoming wastewater and provide continuous reseeded. This mixture of raw wastewater and the returned activated sludge is called the mixed liquor.

c) The organisms live by using oxygen and work by adsorbing and absorbing the food matter. Oxygen is used to provide energy for the cell growth and produce CO₂ and H₂O as the final by products. Cell growth provides new organisms for the self-sustenance and continuation for the process.

d) The microbes are composed of two kinds. The 'Floc forming' type which trends to settled easily in the clarifiers and the "Filament Formers" which do not easily to settle, float on the surface of the tank and may be carried out along with final effluent. Hence, the presence of these organisms is not desirable in the system.

d) The excess amount of sludge produced from the system has to be wasted regularly to maintain the normal balance of the process.

e) The activated sludge system efficiency depends on pH, temperature, air contact, suspended solids, culture growth, and concentration of microorganisms that create the optimum mixed liquor suspended solids concentration (MLSS).

RAS Control

To properly operate the activated sludge process, a good settling mixed liquor must be achieved and maintained. The MLSS are settled in a clarifier and then returned to the aeration tank as the RAS. This keeps a sufficient concentration of activated sludge in the aeration tanks so that the required degree of treatment can be obtained in the allotted time period. The return of activated sludge from the secondary clarifier to the aeration tank is a key control parameter of the process.

RAS Pumping

The RAS system pumps the settled sludge from the secondary clarifier back to the aeration tank. It is important that this system returns the RAS to the aeration tank before the microorganisms deplete their entire available DO. The RAS must also be as concentrated as possible and the flow must be accurately measured and controlled.

To accomplish this, the RAS pumping system must have a positive variable flow control device and the RAS flow must be adjustable between the minimum and maximum range for proper process control. The desired return flow to the aeration tank could also be automatically paced to secondary influent flow.

WAS Pumping

All activated sludge processes must have a WAS system to remove excess microorganisms. This is necessary to control the F/M and MCRT. If the process is to reliably meet discharge requirements, this system must provide a positive, flexible, and reliable means of removing excess microorganisms.

It is essential for the system to have flow-metering and pumping equipment that function completely independent of other activated sludge control devices. The best and most flexible system will include independent WAS pumping with flow adjustability (for example, variable speed drive) and a flow meter that provides feedback into a flow-control device.



Such a system can be set for a given wasting rate with complete assurance that variable system head or concentration conditions will not affect its ability to remove the microorganisms required. WAS systems must have sufficient capacity to deal with both the hydraulic and/or organic load changes and process changes.

Aeration and DO Control

The purpose of aeration is two-fold: oxygen must be dissolved in the liquid in sufficient quantities to maintain the organisms and the contents of the tank must be sufficiently mixed to keep the sludge in suspension.

Mixing energy and oxygen transfer are provided through mechanical or diffused aeration. The amount of oxygen that has to be transferred by the aeration system is theoretically equal to the amount of oxygen required by the organisms in the system to oxidize the organic material.

The DO concentration in the aeration tank must be sufficient to sustain at all times the desirable microorganisms in the aeration tank, clarifier, and return sludge line back to the aeration tank.

When oxygen limits the growth of microorganisms, filamentous organisms may predominate and the settleability and quality of the activated sludge will be poor.

On the other hand, over aeration can create excess turbulence and may result in the breakup of the biological floc. Also energy is wasted when the DO level is unnecessarily high. Poor settling and high effluent solids will result. For these reasons, it is very important to periodically monitor and adjust the aeration tank DO levels and, for diffused air systems, the airflow rates are adjusted to accomplish this.

In practice, the DO concentration in the aeration tank should normally be maintained at about 1.5 to 4 mg/L in all areas of the aeration tank at all times for adequate microorganism activity.

Exceptions are in zones deliberately to be anoxic or anaerobic. Poor sludge settling as a result of filamentous organisms has been associated with mixed liquor DO concentrations below 0.5 mg/L.

Above 4 mg/L, treatment usually does not significantly improve but power usage increases aeration costs considerably.

References

1. Activated Sludge Process Control Training Manual for Wastewater Treatment Plant Operators-State of Michigan, Department of Environmental Quality 4/17
2. *Introduction to Activated Sludge Study Guide*, Wisconsin Department of Natural Resources, Wastewater Operator Certification, *December 2010 Edition Printed on 12/11/12*
3. *Advanced Activated Sludge Study Guide* - Wisconsin Department of Natural Resources, Wastewater Operator Certification, December 2010 Edition
4. Operational Control Procedures for Activated Sludge Process- May 1974 US EPA
5. Aerobic Biological Wastewater Treatment Facilities Process Control Manual USEPA 1977
6. Oxygen Activated Sludge Wastewater Treatment Systems – USEPA – 625/4-73-003a
7. Sequencing Batch Reactors – Wastewater Technology Fact Sheet- US EPA 932-f-99-073 Sept 1999
8. Emerging Technology Assessment of Phostrip, A/O, and Bardenpho Process for Biological Phosphorus Removal. USEPA Feb 1985
9. Activated Sludge Chapter 7, State of Tennessee Design Criteria, Jan 2016
10. Design Guides for Biological Wastewater Treatment Processes – USEPA 11010 ESQ 08/71
11. Nutrient Control Design Manual EPA 600/R-10/100 August 2010
12. Package Plants – Wastewater Technology Fact Sheet, USEPA 832-F-00-016 September 2000
13. Alum Addition and Step-Feed Studies in Oxygen-Activated Sludge USEPA 600/2-77-166 Sept. 1977
14. How Wastewater Works – The Basics. USEPA 833-F-98-002, May 1998
15. Troubleshooting Activated Sludge, State of Maine
16. Life in Aeration Tank: Bacteria, Protozoa & Metazoan Ohio EPA, Nov 17, 2020 Webinar
17. Oxidation ditches, Wastewater Technology Fact Sheet, USEPA 832-F-00-013 Sept 2000
18. Operating Procedure USEPA LSASDPROC-109-RS, June 2020

19. Activated Sludge Microbiology Problems and Their Control USEPA June 2003

20. PowerPoint Presentation

https://www.tn.gov/content/dam/tn/environment/energy/documents/wastewater_area_2/Aerobic%20Digestion%20of%20Sludge%20-%20Dr.%20Larry%20Moore.pdf

Arden, E. and W. T. Lockett. 1914a. Experiments on the oxidation of sewage without the aid of filters. J. Soc. 01 Chemical Industry (England), 33:523-539.

Arden, E. and W. T. Lockett. 1914b. The oxidation of sewage without the aid of filters. Part II. J. Soc. of Chern Industry (England), 33: 1122-1124.

Martin, A. J. 1927. The Activated Sludge Process. MacDonald and Evans, London.

Jenkins, D., M. G. Richard and G. T. Daigger. 1993.

Manual on the Causes and Control of Activated Sludge Bulking and Foaming. Lewis Publishers, Inc., Chelsea, MI. Schuyler, R.G. 1995.

Activated Sludge Process Control Troubleshooting Chart. Rothberg, Tamburini and Winsor, Inc., 1600 Stout Street, Suite 1800, Denver, CO 80202- 3126.

Activated Sludge Process Section Post Quiz

True or False

1. Activated sludge is recycled back through the aeration basins by returning settled sludge in the final clarifiers and thus remains in the activated sludge system for a number of days. True or False
2. For conventional activated sludge, a sludge age of 30-40 days is typical. True or False
3. For extended aeration activated sludge, younger sludge ages of 1-3 days are common. True or False
4. F/M ratio and sludge age is inversely related (1 divided by the sludge age approximates the F/M ratio). The older the sludge, the lower the F/M ratio; conversely, the younger the sludge, the higher the F/M ratio. True or False
5. The operator should monitor MLSS, F/M ratio and sludge age to waste accordingly and thus ensure optimal operations and process stability. True or False
6. Solids are generated by microorganism growth and reproduction. The influent BOD supplies the food for the growth and reproduction. As microorganisms' populations multiply, excess solids (microorganisms) must be removed (wasted). True or False
7. If excess solids are not removed, the mixed liquor suspended solids (MLSS) and sludge age will increase and process efficiency will be lowered. Sludge settling rates are affected. True or False
8. If excess solids do not get wasted, they can overflow the clarifier weirs and into the receiving water. True or False
9. Wasting sludge is the least important operational process control of the activated sludge process. By wasting sludge on a consistent basis, preferably monthly, the biomass within the aeration tank will remain healthy and at a consistent MLSS level. True or False
10. The concentration of RAS has a direct bearing on how much to waste and the volume wasted. On a volume basis, a thicker waste activated sludge (high WAS concentration) will require greater amount of wasting than a thicker waste activated sludge (low RAS concentration). True or False

11. Solids will not settle and concentrate in the final clarifiers thus forming a sludge blanket. The sludge blanket cannot increase or decrease depending on the RAS flow rate. The proper RAS flow rate allows for a desired sludge blanket. True or False

12. Old sludge consists of sludge which has not yet reached a high enough sludge age to be most effective in a particular activated sludge process. Billowing whitish foam is an indicator that the sludge age is too high. True or False

13. Young sludge is often associated with a high F/M. To correct for young sludge, it is necessary to decrease wasting rates. This will increase the amount of solids under aeration, reduce the F/M ratio, and increase the sludge age. True or False

14. Old sludge consists of sludge in which the sludge age is too high to be most effective in a particular activated sludge process. True or False

15. Dark brown foam and a somewhat greasy or scummy appearance is an indicator of old sludge. Settling in the clarifier is rapid, but pin floc can be present in the effluent and the effluent is hazy. True or False

Activated Sludge Process Section Post Quiz Answers

1. True, 2. False, 3. False, 4. True, 5. True, 6. True, 7. True, 8. True, 9. False, 10. False, 11. False, 12. False, 13. True, 14. True, 15. True

Topic 5 – Nutrient Section

Section Focus: You will learn the basics of wastewater nutrients, including nitrogen, and phosphorus and their removal procedures. At the end of this section, you will be able to describe various wastewater nutrients and removal methods. There is a post quiz at the end of this section to review your comprehension and a final examination in the Assignment for your contact hours.

Scope/Background: This section provides information on a number of different technologies that can reduce nitrogen and phosphorus levels. The actual technology selected will be site-specific and dependent on many factors including influent water quality, required effluent levels, disposal options, availability of land, and cost.

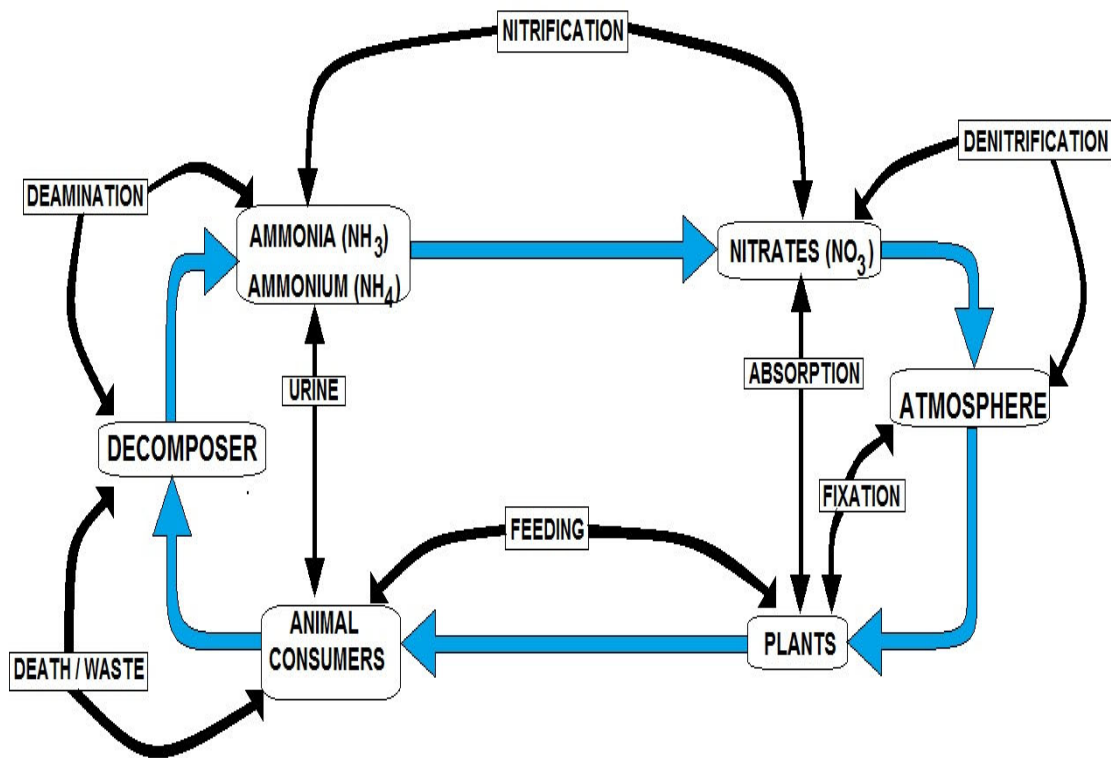

NITROGEN CYCLE

Wastewater contains nitrogen and phosphorus from human waste, food and certain soaps and detergents. Once the water is cleaned to standards set and monitored by state and federal officials, it is typically released into a local water body, where it may become a source of nitrogen and phosphorus pollution.

Some wastewater treatment plants are able to remove more nitrogen and phosphorus from their discharges than others, depending on their equipment and how they treat wastewater.

Enhanced treatment systems enable some wastewater plants to produce discharges that contain less nitrogen than plants using conventional treatment methods. Upgrading wastewater treatment systems is often expensive for municipalities and rate payers, but some upgrades can pay for themselves or end up saving a plant money. Various strategies to reduce nitrogen and phosphorus loads from wastewater treatments plants are being pursued across the country. *Credit to US EPA*

Key Information

NITROGEN

Nitrogen is an important nutrient for plant and animal growth. Atmospheric nitrogen is less biologically available than dissolved nitrogen in the form of ammonia and nitrates. Availability of dissolved nitrogen may contribute to algal blooms.

Ammonia and organic forms of nitrogen are often measured as Total Kjeldahl Nitrogen (TKN). Inorganic forms of nitrogen may also be present and contribute to the total nitrogen content.

NITROGEN CYCLE

The wastewater nitrogen cycle incorporates the significant inorganic and organic nitrogenous compounds that enter the activated sludge process, are produced in the activated sludge process and leave the activated sludge process. These compounds and their removal affect the activated sludge process.

References for this Section will come primarily from these documents.

- A. Nutrient Removal - Total Nitrogen Study Guide, Wisconsin Department of Natural Resources, Wastewater Operator Certification, October 2018 Edition
- B. Nutrient Control Design Manual State of Technology Review Report, EPA/600/R-09/012, January 2009.
- C. Nitrogen Control Manual, USEPA, 625/R-93/010, September 1993
- D. Nutrient Control Design Manual, USEPA 600/R-10/100, August 2010

Important Ions in Wastewater Treatment

Cations	Anions
Aluminum ion (Al^{+3})	Bicarbonate ion (HCO_3^-)
Ammonium ion (NH_4^+)	Chloride ion (Cl^-)
Calcium ion (Ca^{+2})	Carbonate ion (CO_3^{-2})
Hydrogen ion (H^+)	Hydroxide ion (OH^-)
Ferric ion (Fe^{+3})	Nitrite ion (NO_2^-)
Ferrous ion (Fe^{+2})	Nitrate ion (NO_3^-)
Magnesium ion (Mg^{+2})	Phosphate ion (PO_4^{-3})
Sodium ion (Na^+)	Sulfate ion (SO_4^{-2})

Terms

Nitrogen species are typically expressed as nitrogen (N).

Ammonia - nitrogen is NH_3-N .

Nitrite - nitrogen is NO_2-N .

Phosphorus compounds are typically expressed as phosphorus (P).

Ammonia and organic nitrogen are measured together with the total Kjeldahl nitrogen (TKN) test.

Nitrile (which contains cyanide and nitrogen) and nitrate are not typically present unless they are being added to collection system for odor control or being discharged by an industrial user. Small amounts of nitrite and nitrate discharged into the collection system are typically used up by facultative bacteria long before the wastewater reaches the WWTP.

TKN

Total Kjeldahl (Kjeldahl) Nitrogen (TKN) is the U.S. EPA-approved parameter used to measure organic nitrogen and ammonia. The TKN content of influent municipal wastewater is typically between 35 and 60 mg/L. Organic nitrogen compounds in wastewater undergo microbial conversion to NH_3 and ammonium ion NH_4^+ .

Recalcitrant

Recalcitrant means a certain compound is difficult to break down. This material can often be broken down given enough time, but not within the time it spends in conventional secondary treatment.

Inert

Inert means the material can't be broken down by any of the microorganisms. Generally, inert materials are inorganic.

Anaerobic, Anoxic, and Aerobic Condition Chart

Environmental Condition	Defining Characteristics	Possible Biological Reactions
Anaerobic	<p>No oxygen present</p> <p>No Nitrite or Nitrate Present</p> <p>Sulfate may be present</p>	<p>CBOD broken down into soluble CBOD and Volatile fatty acids (VFAs).</p> <p>Heterotrophs are dormant.</p> <p>Nitrifiers are dormant.</p> <p>Phosphate Accumulating Organisms (PAOs) release phosphorus.</p> <p>PAOs uptake VFAs.</p> <p>Sulfate reduced to hydrogen sulfide.</p>
Anoxic	<p>No oxygen present.</p> <p>Nitrite and/or Nitrate present.</p> <p>Sulfate may be present.</p>	<p>Heterotrophs convert CBOD to biomass.</p> <p>Heterotrophs convert NO₂- and NO₃- into Nitrogen gas.</p> <p>Nitrifiers are dormant.</p> <p>PAOs consume stored VFAs.</p> <p>PAOs uptake phosphorus.</p>
Aerobic/Oxic	<p>Oxygen present.</p> <p>Ammonia usually present.</p> <p>Nitrite and nitrate may be present.</p> <p>Sulfate may be present.</p>	<p>Heterotrophs convert CBOD to biomass.</p> <p>Nitrifiers convert NH₃ to NO₂- and NO₃-.</p> <p>PAOs consume stored VFAs.</p> <p>Hydrogen sulfide oxidized to sulfate.</p>

Nutrient Introduction *Credit US EPA*

NUTRIENTS

Nutrients are components in foods that an organism uses to survive and grow. Macronutrients provide the bulk energy an organism's metabolic system needs to function while micronutrients provide the necessary cofactors for metabolism to be carried out. Both types of nutrients can be acquired from the environment.



Nitrogen and phosphorus are macronutrients that are transported to water bodies in rain, surface runoff, including urban and agricultural ground water drainage, and municipal and industrial wastewater. Once in a water body, nitrogen or phosphorus can occur in dissolved organic, dissolved inorganic or particulate forms, with transformations occurring among these forms. Because nutrients cycle among various forms, nitrogen and phosphorus pollution in water bodies generally is measured in terms of total nitrogen and total phosphorus.

Nutrients

We will examine nutrients found in wastewater. Most are chemical elements or compounds vital for both plant and animal growth. Nutrients include ammonia, organic nitrogen, Kjeldahl nitrogen, nitrate nitrogen (water only) and total phosphorus. High amounts of nutrients have been related with eutrophication, or over-fertilization of a water body. Low levels of nutrients can reduce plant growth and starve higher-level organisms that consume phytoplankton.

The purpose of this section is to provide an overview of the major factors driving decisions to enhance nutrient removal at WWTPs. This section characterizes the wastewater treatment industry based on U.S. Environmental Protection Agency (EPA) survey information. This section describes the negative impacts of nutrient enrichment, highlighting the history of water quality changes in key regions of the country. EPA and State initiatives to reduce nutrient pollution from wastewater treatment discharges are summarized in this training course. Lastly, we will highlight several barriers to enhancing nutrient removal at wastewater plants.

Status of Wastewater Treatment in the U.S.

The 1972 Amendments to the Federal Water Pollution Control Act (FWPCA)(Public Law 92-500), also known as the Clean Water Act (CWA), established the foundation for wastewater discharge control in the U.S. The CWA's primary objective was to "restore and maintain the chemical, physical, and biological integrity of the Nation's waters."

The CWA established a program to ensure clean water by requiring permits that limit the amount of pollutants discharged by all municipal and industrial dischargers into receiving waters. Discharges are regulated under the National Pollutant Discharge Elimination System (NPDES) permit program. As of 2004, there were 16,583 municipal wastewater utilities [also known as Publicly Owned Treatment Works (POTWs)] regulated under the

CWA, serving approximately 75 percent of the Nation's population (U.S. Public Health Service and USEPA, 2008) with the remaining population served by septic or other onsite systems.

Wastewater treatment has generally been defined as containing one or more of the following four processes: (1) preliminary, (2) primary, (3) secondary, and (4) advanced - also known as tertiary treatment.

Preliminary treatment consists of grit removal, which removes dense inert particles and screening to remove rags and other large debris. Primary treatment involves gravity settling tanks to remove settleable solids, including settleable organic solids. The performance of primary settling tanks can be enhanced by adding chemicals to capture and flocculate smaller solid particles for removal and to precipitate phosphorus.

Secondary treatment follows primary treatment in most plants and employs biological processes to remove colloidal and soluble organic matter. Effluent disinfection is usually included in the definition of secondary treatment.

EPA classifies advanced treatment as "a level of treatment that is more stringent than secondary or produces a significant reduction in conventional, non-conventional, or toxic pollutants present in the wastewater" (U.S. Public Health Service and USEPA, 2008). Other technical references subdivide advanced treatment, using the terms "secondary with nutrient removal" when nitrogen, phosphorus, or both are removed and "tertiary removal" to refer to additional reduction in solids by filters or microfilters (Tchobanoglous et al, 2003).

Effluent filtration and nutrient removal are the most common advanced treatment processes. The CWA requires that all municipal wastewater treatment plant discharges meet a minimum of secondary treatment. Based on data from the *2004 Clean Watersheds Needs Survey*, 16,543 municipal WWTPs (99.8 percent of plants in the country) meet the minimum secondary wastewater treatment requirements.

Of those that provide at least secondary treatment, approximately 44 percent provide some kind of advanced treatment (U.S. Public Health Service and USEPA, 2008).

Nutrient Impairment of U.S. Waterways

The harmful effects of eutrophication due to excessive nitrogen and phosphorus concentrations in the aquatic environment have been well documented. Algae and phytoplankton growth can be accelerated by higher concentrations of nutrients as they can obtain sufficient carbon for growth from atmospheric or dissolved carbon dioxide. In addition to stimulating eutrophication, nitrogen in the form of ammonia can exert a direct demand on dissolved oxygen (DO) and can be toxic to aquatic life.

Even if a treatment plant converts ammonia to nitrate by a biological nitrification process, the resultant nitrate can stimulate algae and phytoplankton growth. Phosphorus also contributes to the growth of algae. Either nitrogen or phosphorus can be the limiting nutrient depending on the characteristics of the receiving water.

Nitrogen is typically limiting in estuarine and marine systems and phosphorus in fresh water systems.

According to the 2007, report *Effects of Nutrient Enrichment in the Nation's Estuaries: A Decade of Change*, increased nutrient loadings promote a progression of symptoms beginning with excessive growth of phytoplankton and macroalgae to the point where aquatic grazers cannot control growth (Bricker et al., 2007).

These blooms may be problematic, potentially lasting for months at a time and blocking sunlight to light-dependent submerged aquatic vegetation (SAV). In addition to increased growth, changes in naturally occurring ratios of nutrients may also affect which aquatic species dominate, potentially leading to nuisance/toxic algal blooms.

These blooms may also lead to other more serious symptoms that affect biota, such as low DO and loss of SAV. Once water column nutrients have been depleted by phytoplankton and macroalgae and these blooms die, the bacteria decomposing the algae then also consume dissolved oxygen, making it less available to surrounding aerobic aquatic life.

Consequently, fish and invertebrate kills may occur due to hypoxia and anoxia, conditions of low to no DO. Eutrophic conditions may also cause risks to human health, resulting from consumption of shellfish contaminated with algal toxins or direct exposure to waterborne toxins. Eutrophication can also create taste and odors problems if the water is used as a source of drinking water. Chemicals used to disinfect drinking water will react with organic compounds in source water to form disinfection byproducts, which are potential carcinogens and are regulated by EPA.

Advanced eutrophic conditions can lead to "dead zones" with limited aquatic life, which describes the hypoxia condition that exists in the Northern Gulf of Mexico. A recent U.S. Geological Survey (USGS) report titled *Differences in Phosphorus and Nitrogen Delivery to the Gulf of Mexico from the Mississippi River Basin* documents the contribution of nitrogen and phosphorus from agricultural and non-agricultural sources in the Mississippi River basin (Alexander et al., 2008).

On June 16, 2008 the joint federal-state Mississippi River/Gulf of Mexico Watershed Nutrient Task Force released its *2008 Action Plan for Reducing, Mitigating, and Controlling Hypoxia in the Northern Gulf of Mexico and Improving Water Quality in the Mississippi River Basin*, which builds upon its 2001 plan by incorporating emerging issues, innovative approaches, and the latest science, including findings from EPA's Science Advisory Board.

Improvements include more accountability through an Annual Operating Plan, better tracking of progress, state and federal nutrient reduction strategies, and a plan to increase awareness of the problem and implementation of solutions (USEPA, 2008b). Nutrient pollution has also caused significant problems in the Chesapeake Bay. Elevated levels of both nitrogen and phosphorus are the main cause of poor water quality and loss of aquatic habitats in the Bay. Significant algae blooms on the water surface block the sun's rays from reaching underwater bay grasses. Without sunlight, bay grasses cannot grow and provide critical food and habitat for blue crabs, waterfowl, and juvenile fish.

The first national attention to nutrient contamination occurred in the Great Lakes. In the 1960s, Lake Erie was declared "dead" when excessive nutrients in the Lake fostered excessive algae blooms that covered beaches and killed off native aquatic species due to

oxygen depletion. At that time, phosphorus was the primary nutrient of concern due to the advent of phosphate detergents and inorganic fertilizers.

With the enactment of the CWA and the Great Lakes Water Quality Agreement in 1972, a concerted effort was undertaken to reduce pollutant loadings, including phosphorus in the Lake. Although the health of the Lake improved dramatically, in recent years, there has been renewed attention to the re-emergence of a “dead” zone in Lake Erie, again due to nutrient loadings.

The Chesapeake Bay Program estimated that 22 percent of the phosphorus loading and 19 percent of the nitrogen loading in the Bay comes from municipal and industrial wastewater facilities (Chesapeake Bay Program, 2008).

Recent studies by scientists and the National Oceanic and Atmospheric Administration (NOAA) have also hypothesized a relationship between excessive nutrients in the Lake and the presence of two aquatic invasive species – the zebra mussel and the quagga mussel (Vanderploeg et al., 2008). Development and population increases in the Long Island Sound Watershed have resulted in a significant increase in nitrogen loading to the Sound.

The increased nitrogen loads have stimulated plant growth, increased the amount of organic matter settling to the benthic zone, lowered DO levels, and changed habitats. The primary concerns in the Sound include hypoxia, the loss of sea grass, and alterations in the food web. Management efforts are currently underway to reduce nitrogen pollution by more than half with a focus on upgrading WWTPs with new technologies and removing nitrogen by reducing polluted run-off through best management practices on farms and suburban areas (Long Island Sound Study, 2004).

The above represent four examples of impaired large water bodies impacted by nutrient loadings. There are more than 80 additional estuaries and bays, and thousands of rivers, streams, and lakes that are also impacted by nutrients in the U.S. In fact, all but one state and two territories have CWA section 303(d) listed water body impairments for nutrient pollution. Collectively, states have listed over 10,000 nutrients and nutrient-related impairments.

Climate change may also be a significant influence on the development of future eutrophic symptoms. According to the report *Effects of Nutrient Enrichment in the Nation's Estuaries: A Decade of Change*, the factors associated with climate change that are expected to have the greatest impacts on coastal eutrophication are:

- Increased temperatures
- Sea level rise
- Changes in precipitation and freshwater runoff

Increased temperatures will have several effects on coastal eutrophication. Most coastal species are adapted to a specific range of temperatures. Increases in water temperatures may lead to expanded ranges of undesirable species. Higher temperatures may also lead to increased algal growth and longer growing seasons, potentially increasing problems associated with excessive algal growth and nuisance/toxic blooms. Additionally, warmer waters hold less DO, therefore potentially exacerbating hypoxia.

Temperature-related stratification of the water column may also worsen, having a further negative effect on DO levels.

The increased sediment load and subsequent turbidity increase may cause SAV loss. The positive feedback between increased erosion and algal growth (as erosion increases, sediment associated nutrients also increase, stimulating growth) may also increase turbidity. The loss of wetlands, which act as nutrient sinks, will further increase nutrient delivery to estuaries.

Another report titled *Aquatic Ecosystems and Global Climate Change – Potential Impacts on Inland Freshwater and Coastal Wetland Ecosystems in the United States* notes that climate change of the magnitude projected for the U.S. over the next 100 years will cause significant changes to temperature regimes and precipitation patterns across the U.S. (Poff et al., 2002).

Such alterations in climate pose serious risks for inland freshwater ecosystems (lakes, streams, rivers, wetlands) and coastal wetlands, and may adversely affect numerous critical services provided to human populations.

These conclusions indicate climate change is a significant threat to the species composition and function of aquatic ecosystems in the U.S. However, critical uncertainties exist regarding the manner in which specific species and whole ecosystems will respond to climate change. These arise both from uncertainties about how regional climate will change and how complex ecological systems will respond.

Indeed, as climate change alters ecosystem productivity and species composition, many unforeseen ecological changes are expected that may threaten the goods and services that these systems provide to humans.

CONVENTIONAL POLLUTANTS

POTWs are designed to treat typical household wastes and biodegradable commercial and biodegradable industrial wastes. The Clean Water Act defines the contaminants from these sources as conventional pollutants. Conventional pollutants include biological oxygen demand (BOD), total suspended solids (TSS), fecal coliform, oil and grease, and pH.

Nitrogen Introduction

Nitrogen

Nitrogen is an essential nutrient for plants and animals. Approximately 80 percent of the earth's atmosphere is composed of nitrogen and it is a key element of proteins and cells. The major contributors of nitrogen to wastewater are human activities such as food preparation, showering, and waste excretion. The per capita contribution of nitrogen in domestic wastewater is about 1/5th of that for BOD.

Influent concentration varies during the day and can vary significantly during rainfall events, because of inflow and infiltration to the collection system.

NITROGEN REMOVAL

Nitrogen is removed through the biological **oxidation** of nitrogen from **ammonia** to **nitrate (nitrification)**, followed by **denitrification**, the reduction of nitrate to nitrogen gas. Nitrogen gas is released to the atmosphere and thus removed from the water.

Nitrification itself is a two-step aerobic process, each step facilitated by a different type of bacteria. The oxidation of ammonia (NH_3) to nitrite.



The most common forms of nitrogen in wastewater are:

- Ammonia (NH_3)
- Ammonium ion (NH_4^+)
- Nitrite (NO_2^-)
- Nitrate (NO_3^-)
- Organic nitrogen

Assimilative Uptake Limitations

Many WWTPs have or will have effluent limitations for ammonia, nitrite, nitrate and phosphorus that cannot be met through assimilative uptake alone. Other treatment methods must be utilized to achieve low effluent goal limits.

Nitrification

Nitrification is an aerobic process in which autotrophic bacteria oxidize ammonia or nitrite for energy production. Nitrification is normally a two-step aerobic biological process for the oxidation of ammonia to nitrite and then to nitrate.

Ammonia-nitrogen ($\text{NH}_3\text{-N}$) is first converted to nitrite (NO_2^-) by ammonia oxidizing bacteria (AOB). The nitrite produced is then converted to nitrate (NO_3^-) by nitrite oxidizing bacteria (NOB). Both reactions usually occur in the same process unit at a wastewater treatment plant (e.g., activated sludge mixed liquor or fixed film biofilm).

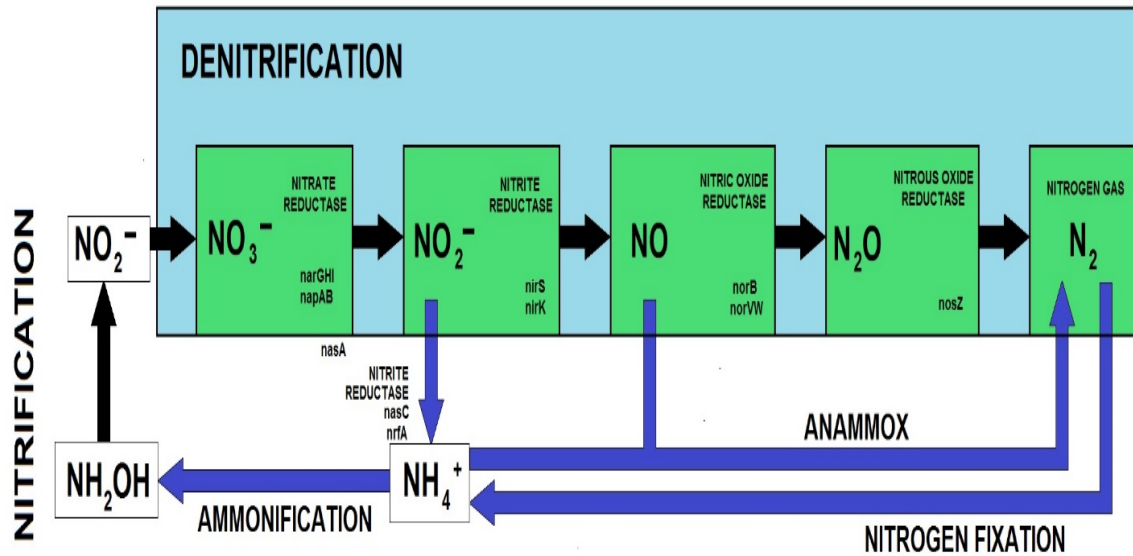

NITRIFICATION SEQUENCE EXAMPLE

Nitrifying Bacteria

Ammonia can be converted into nitrite and nitrate by nitrifying bacteria. Effluent ammonia-nitrogen ($\text{NH}_3\text{-N}$) concentrations less than 1 mg/L $\text{NH}_3\text{-N}$ are achievable.

Autotrophic Bacteria

Ammonia and nitrite oxidizing bacteria (AOB and NOB) are classified as autotrophic bacteria because they derive energy from the oxidation of reduced inorganic compounds (in this case, nitrogenous compounds) and use inorganic carbon (CO_2) as a food source. These usefully create nitrate.

The group of AOB most associated with nitrification is the *Nitrosomonas* genus, although other AOB such as *Nitrosococcus* and *Nitrospira* can contribute to the process. *Nitrobacter* are the NOB most associated with the second step, although other bacteria including *Nitrospina*, *Nitrococcus*, and *Nitrospira* have been found to also oxidize nitrite (Tchobanoglous et al., 2003; USEPA, 2007c).



Nitrifying Bacteria

Significant Amount of Oxygen

Nitrifying bacteria require a significant amount of oxygen to complete the reactions, produce a small amount of biomass, and cause destruction of alkalinity through the consumption of carbon dioxide and production of hydrogen ions. For each gram (g) of $\text{NH}_3\text{-N}$ converted to nitrate, 4.57 g of oxygen are used, 7.14 g of alkalinity are removed, and 0.08 g of inorganic carbon are utilized in formation of only 0.16 g of new cells (Tchobanoglous et al., 2003).

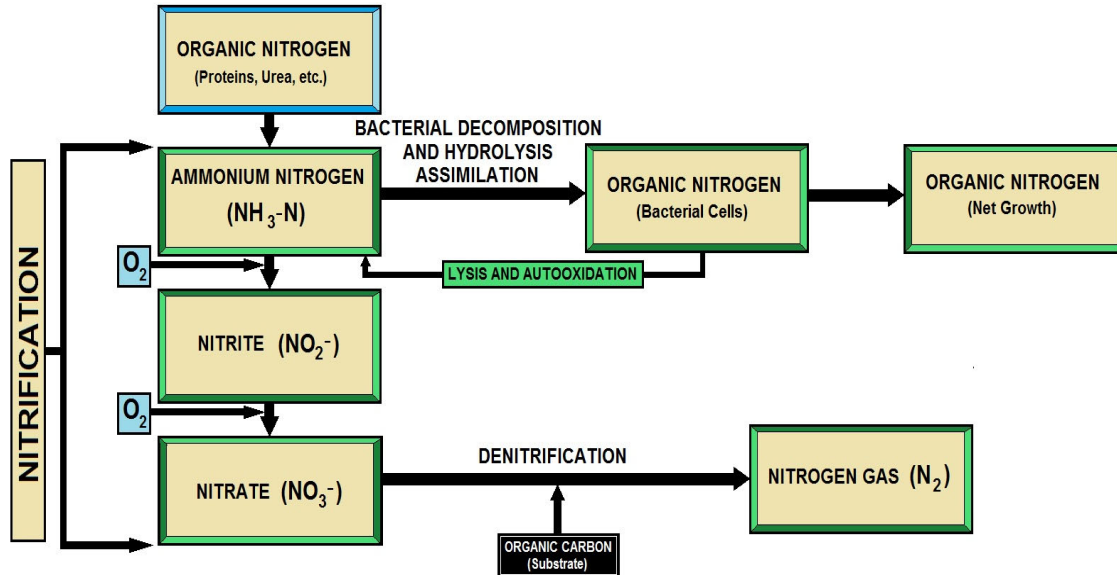

NITROGEN TRANSFORMATION / BIOLOGICAL TREATMENT

Nitrogen Gas

Nitrate can be converted to nitrogen gas by a variety of facultative, heterotrophic bacteria. The nitrogen gas is returned to the atmosphere. Nitrate removal is limited by the amount of BOD 5 available, as it is used as food when nitrate is broken down for its oxygen.

Total Inorganic Nitrogen (TIN)

Total inorganic nitrogen (TIN) as low as 5 mg/L N can be met through biological nitrification and denitrification.

Total Nitrogen

Total nitrogen in domestic wastewater typically ranges from 20 to 70 mg/L for low to high strength wastewater (Tchobanoglous et al., 2003). Factors affecting concentration include the extent of infiltration and the presence of industries. Influent concentration varies during the day and can vary significantly during rainfall events, as a result of inflow and infiltration to the collection system.

The most common forms of nitrogen in wastewater are:

- Ammonia (NH_3)
- Ammonium ion (NH_4^+)
- Nitrite (NO_2^-)
- Nitrate (NO_3^-)

- Organic nitrogen

Nitrogen in domestic wastewater consists of approximately 60 to 70 percent ammonia-nitrogen and 30 to 40 percent organic nitrogen (Tchobanoglous et al., 2003; Crites and Tchobanoglous, 1998). Most of the ammonia-nitrogen is derived from urea, which breaks down rapidly to ammonia in wastewater influent.

EPA approved methods for measuring ammonia, nitrate, and nitrite concentration use colorimetric techniques. Organic nitrogen is approximated using the standard method for Total Kjeldahl Nitrogen (TKN) (APHA, AWWA, and WEF, 1998).

Nitrogen (N_2) is present in domestic, commercial and industrial wastewater, it is usually not removed by secondary treatment. If discharged into lakes and streams or estuary waters, nitrogen in the form of ammonia (NH_3) can consume oxygen or encourage the excessive growth of algae.

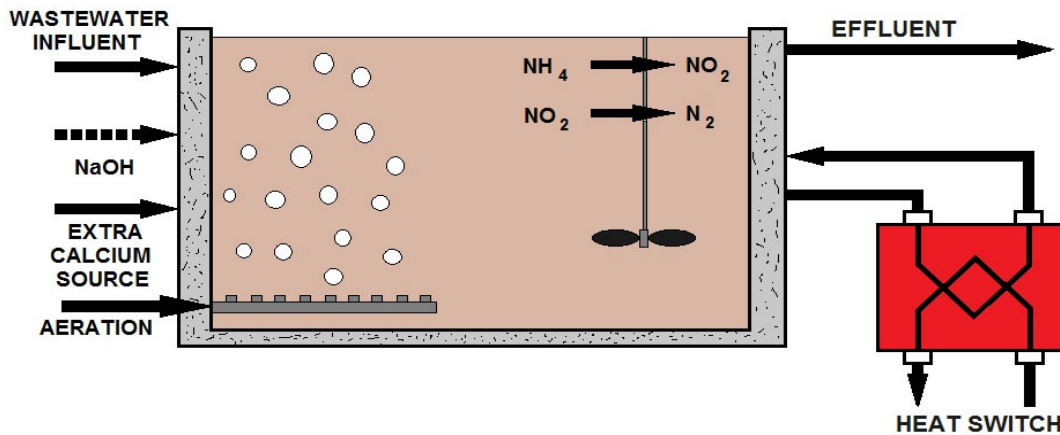

PROCESS FOR NITROGEN (N_2) REMOVAL

Conversion of Nitrate to Nitrogen Gas

The conversion of nitrate to nitrogen gas is accomplished by bacteria in a process known as denitrification. Effluent with nitrogen in the form of nitrate is retained in a tank that lacks oxygen, where carbon-containing chemicals, such as methanol, are added or a small stream of raw wastewater is mixed in with the nitrified effluent.

In this oxygen free environment, bacteria use the oxygen attached to the nitrogen that is in the nitrate form, then the nitrogen gas is released. Because nitrogen contains almost 80 percent of the earth's atmosphere, the release of nitrogen into the atmosphere does not cause any known environmental harm.

Chemical Feeding and Mixing Overview

Lime or metal salts can be added at several locations throughout the treatment plant to remove phosphorus.

“Pre-precipitation” is when chemicals are added to raw water to precipitate phosphorus in the primary sedimentation basins.

“Co-precipitation” involves adding chemicals to form precipitates that can be removed with biological sludge.

“Post-precipitation” is when chemicals are added after secondary sedimentation and precipitants are removed in a tertiary process such as sedimentation or filtration (Tchobanoglous et al., 2003).

Multipoint additions of iron or aluminum salts have been very effective and can typically remove more phosphorus than single-point applications. Because it requires a high pH to achieve a low phosphorus concentration, lime cannot be added directly to biological reactors or to the secondary clarifiers.

There are several advantages to post-precipitating phosphorous using a tertiary treatment technique (after biological processes in a separate reactor):

- Microorganisms rely on phosphorus as a food source. If too much phosphorus is removed prior to biological treatment, biological processes may suffer. For activated sludge, the minimum ratio of phosphorus to BOD₅ for a rapidly growing (low solids retention time (SRT)) system is typically about 1:100 (WEF and ASCE, 1998).
- Competing chemicals in the primary sedimentation basins can increase the required dose.
- Phosphorus enters the treatment plant as soluble orthophosphate, soluble polyphosphates, and organically bound phosphorus. Most of the polyphosphates and much of the organically bound phosphorus are converted to more simple orthophosphates during biological treatment. If the influent contains significant polyphosphates and/or organically bound phosphorus, locating chemical treatment after biological processes would be more efficient and achieve lower effluent levels.
- The removal of carbonate alkalinity and phosphorus by lime prior to biological treatment can have a negative impact on nitrification processes (WEF and ASCE, 1998). Also, removing phosphorus to very low concentrations upstream of denitrification filters can negatively affect the denitrification process. Previous studies showed that the hydroxide alkalinity can be balanced by the hydrogen ions produced during nitrification.
- Sludge recalcification can be used to achieve high removal efficiencies using lime in tertiary treatment. One potential advantage to adding chemicals during primary treatment instead of tertiary treatment is reduced capital costs and space requirements as a result of removing additional BOD and TSS and reducing the load to downstream processes, thereby reducing the size of the subsequent activated sludge basins and the amount of oxygen transfer needed.

Chemicals should be well mixed with the wastewater to ensure reaction with soluble phosphates and formation of precipitates. Chemicals may either be mixed in separate tanks or can be added at a point in the process where mixing already occurs. Bench-scale and pilot scale tests are often used to determine the correct mixing rate for a given composition of wastewater and chemicals used, including polymer (USEPA, 1999a).

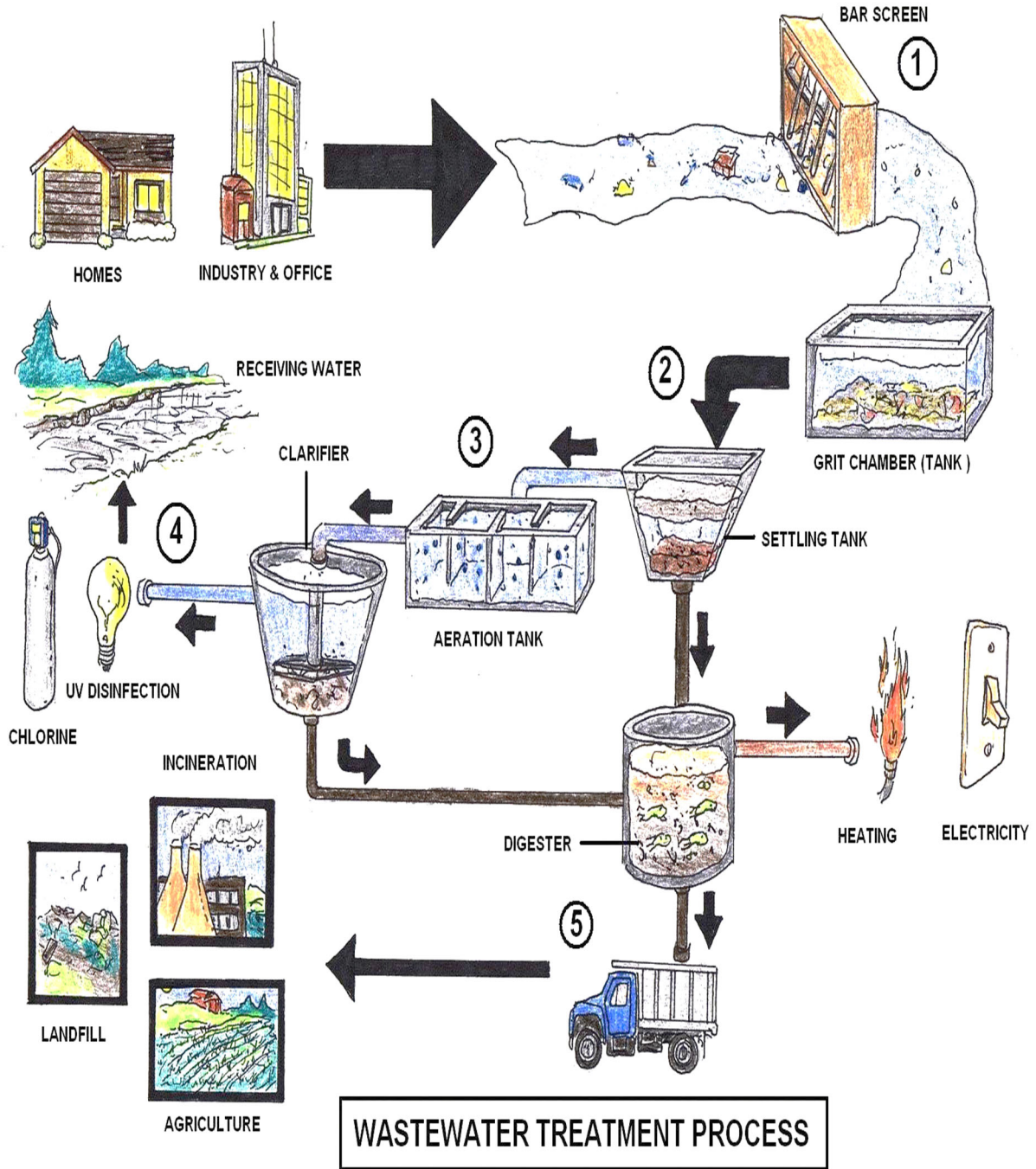

Chemicals can be added in the clarifier.

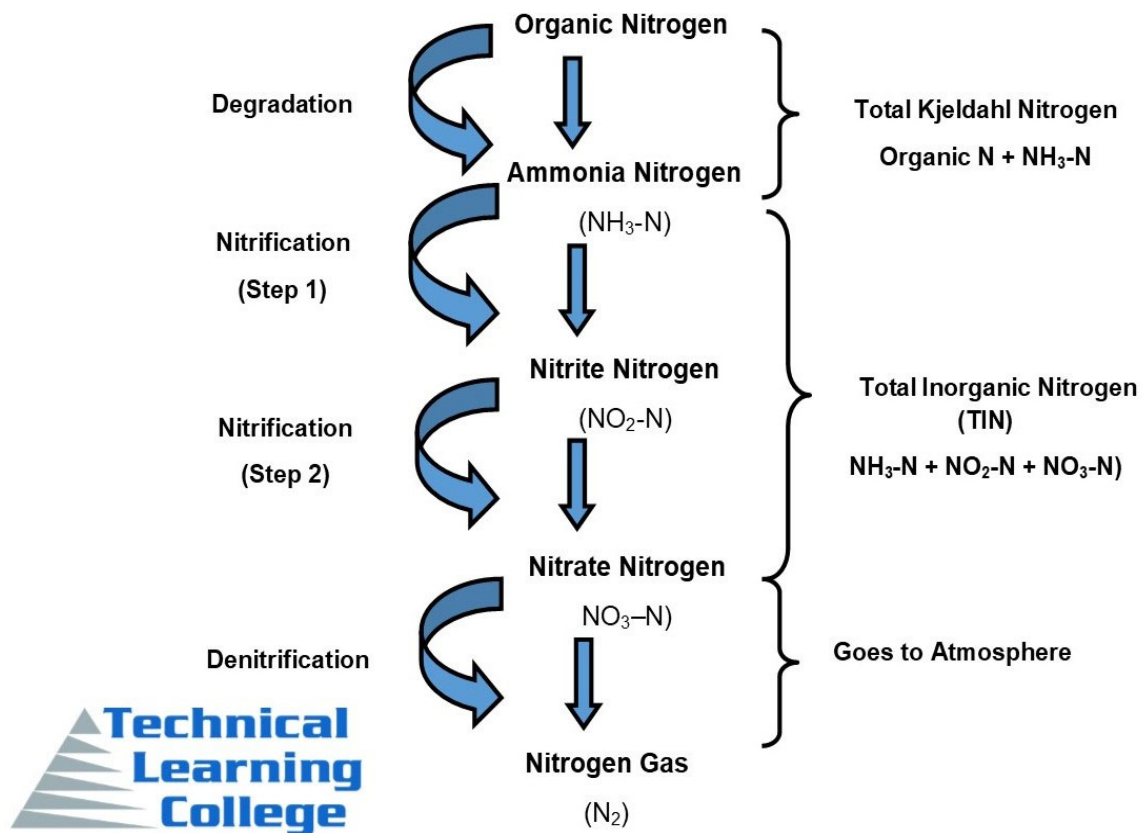

NITROGEN SPECIES IN WASTEWATER

Nitrogen species transformation in the process train is crucial to the understanding of the fate and occurrence of dissolved organic nitrogen (DON), which is a majority fraction when nitrogen is treated to very low levels (.3 mg N/L).

Effluent organic nitrogen consists of particulate organic nitrogen (PON), colloidal organic nitrogen (CON), and DON. Most of influent PON fraction is removed in a primary clarifier during the primary treatment process and the remaining is removed in the biological process. The fate of CON and DON through the wastewater treatment processes is unclear. The CON and DON become a significant fraction of the total nitrogen in the final effluent of some plants.

Theoretical Oxidized Nitrogen Removal Performance Chart – US EPA

IMLR, % of Influent Flow	RAS at 50 % of Influent Flow	RAS at 100% of Influent Flow
0	34	50
50	50	60
100	60	67
200	70	74
300	78	80
400	82	85

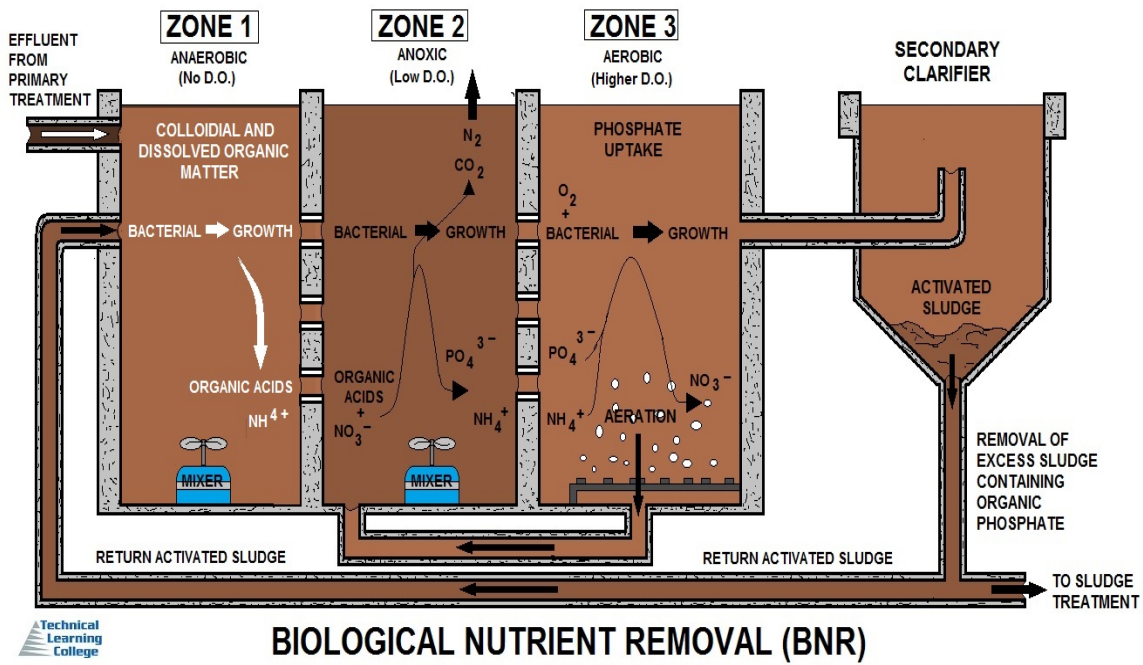

BIOLOGICAL NUTRIENT REMOVAL (BNR)

Denitrification Bacteria Sub-Section

Biological nitrogen removal can be accomplished by a variety of treatment configurations using suspended growth, attached growth, or combined systems. In the past, some WWTPs were required to only remove ammonia-nitrogen in wastewater to reduce toxicity to aquatic organisms with no limits on nitrate or total nitrogen.

However, most treatment plants are now required to remove nitrogen because both ammonia-nitrogen and nitrate-nitrogen can stimulate algae and phytoplankton growth and lead to eutrophication of U.S. waterways. For biological nitrogen removal, it is essential that nitrification occur first followed by denitrification.

In municipal and industrial wastewater treatment processes, denitrification is the biological reduction of nitrate or nitrite to nitrogen gas (N₂) as indicated by equation below.

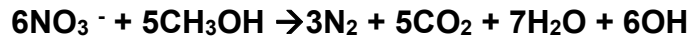

This is accomplished by a variety of common heterotrophic microorganisms that are normally present in aerobic biological processes. Most are facultative aerobic bacteria with the ability to use elemental oxygen, nitrate, or nitrite as their terminal electron acceptors for the oxidation of organic material.

Heterotrophic bacteria capable of denitrification include the following genera: *Achromobacter*, *Acinetobacter*, *Agrobacterium*, *Alcaligenes*, *Arthrobacter*, *Bacillus*, *Chromobacterium*, *Corynebacterium*, *Flavobacterium*, *Hypomicrobium*, *Moraxella*, *Nesseria*, *Paracoccus*, *Propionibacteria*, *Pseudomonas*, *Rhizobium*, *Rhodopseudomonas*, *Spirillum* and *Vibrio* (Tchobanoglous et al., 2003).

Recent research has shown that nitrite reduction is accomplished by a much more specialized group of heterotrophic bacteria than those performing the conversion of nitrate to nitrite (Katehis, 2007).

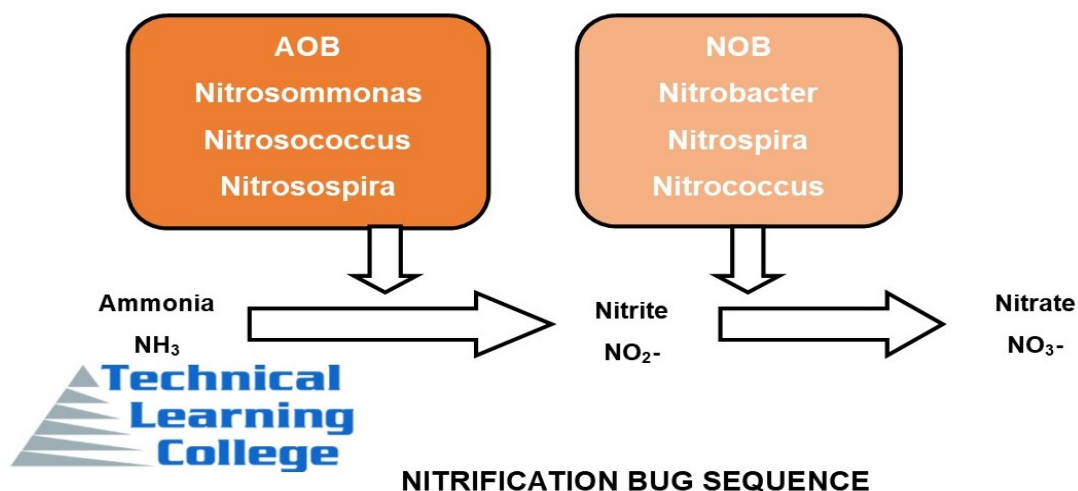

Denitrification by heterotrophic nitrifying bacteria and by autotrophic bacteria has also been observed.

An example of a heterotrophic nitrifying bacteria that can denitrify is *Parococcus pantotropha*, which obtains energy by nitrate or nitrite reduction while oxidizing ammonia under aerobic conditions.

A readily available carbon source, such as acetate $C_2H_3O_2$, is needed (Robertson and Kuenen, 1990). The conditions required for this form of denitrification are not practical in biological wastewater treatment.

An autotrophic denitrifying bacteria of practical significance in wastewater treatment is that in the Anammox process used to remove nitrogen in return streams from anaerobic digestion sludge dewatering filtrate or centrate. These bacteria have been identified as a member of bacteria in the order *Planctomycetales* (Strous et al, 1999).

Under anaerobic conditions, ammonia is oxidized with the reduction of nitrite with the final product as nitrogen gas. The reaction is best accomplished at temperatures above 25°C and they are slow growing organisms.

Facultative Denitrifying Bacteria

Facultative denitrifying bacteria will preferentially use oxygen instead of nitrate. In the absence of oxygen, however, they will carry out nitrite and/or nitrate reduction. Microbiologists generally use the term anaerobic to describe biological reactions in the absence of oxygen.

To distinguish anaerobic conditions for which the biological activity occurs mainly with nitrate or nitrite as the electron acceptor, the term “anoxic” has been applied.

Although oxygen is known to inhibit denitrification, denitrification has been observed in activated sludge and fixed film systems in which the bulk liquid DO concentration is positive. This is due to the establishment of an anoxic zone within the floc or biofilm depth. Hence, a single system can carry out simultaneous nitrification and denitrification.

The DO concentration that is possible for simultaneous nitrification and denitrification depends on a number of factors including the mixed liquor concentration, temperature, and substrate loading.

The DO concentration above which denitrification is inhibited may vary from 0.10 to 0.50 mg/L (WEF and ASCE, 2006; Tchobanoglous et al., 2003; Barker and Dold, 1997).

The organic carbon source for denitrifying bacteria can be in the form of:

- Soluble degradable organics in the influent wastewater
- Soluble organic material produced by hydrolysis of influent particulate material
- Organic matter released during biomass endogenous decay
- A supplemental (exogenous) carbon source.

A general rule of thumb is that 4 g of wastewater influent BOD is needed per g of NO_3-N to be removed through biological treatment (Tchobanoglous et al., 2003). When denitrification occurs after secondary treatment, there is little BOD remaining, so a supplemental carbon source is often needed.

Methanol

The most common exogenous carbon source in use is methanol (CH_3OH) Due to issues regarding its safety, cost, and availability, some wastewater systems are using alternative carbon sources such as acetic acid, ethanol, sugar, glycerol, and proprietary solutions depending on the needs of their particular facility (deBarbadillo et al., 2008).

Biological denitrification reactions produce alkalinity and heterotrophic biomass. Based on the stoichiometry of the reactions, denitrification will produce 3.57 mg/L of alkalinity as CaCO_3 for each mg/L of NO_3^- -N consumed.

Heterotrophic biomass produced can be estimated as 0.4 g volatile suspended solids (VSS) produced for every gram of COD consumed. Growth kinetics for denitrifiers are dependent on a number of factors including carbon substrate type and concentration, DO concentration, alkalinity, pH, and temperature, with carbon source being the most important.

Denitrification Performance – Temperature

Denitrification performance, as with other biological processes, is affected by changes in temperature; denitrification rates will increase or decrease as temperatures rise or fall. However, denitrification performance is not as temperature limited as nitrification. Therefore, with temperatures as the variable, denitrification performance will continue as long as the nitrification process produces nitrate.

Oxidizable Nitrogen

Oxidizable nitrogen is organic nitrogen and ammonia that can be broken down and converted into nitrite and nitrate. Practically speaking, the oxidizable nitrogen is the same as the Total Kjeldahl Nitrogen (TKN).

Domestic wastewater contains a small amount of organic nitrogen that cannot be broken down during treatment.

Denitrification Process Control Components

Process control for denitrification in fixed-film processes is limited to adjusting the amount of nitrified effluent that is recycled back to the front of the process.

Process control for denitrification in activated sludge consists of...

- a. Ensuring the anoxic zone(s) remain anoxic
- b. Adjusting the internal mixed liquor recycle (IMLR) flow
- c. Adjusting the RAS flow
- d. Adjusting the recycle flow in a fixed-film process
- e. Adding supplemental BOD_5 (if needed) and
- f. Monitoring the influent and effluent for the following parameters
 1. Oxidation-reduction potential (ORP)
 2. Nitrite, and
 3. Nitrate

Helpful Troubleshooting Table

Organism	Removes / Converts	Requires	Things to Avoid	Produces
Heterotrophs	BOD ₅	BOD ₅ Oxygen Nutrients		CO ₂ + H ₂ O
Heterotrophs	BOD ₅ Nitrite + Nitrate → Nitrogen Gas	4 mg/L BOD ₅ per 1 mg/L Nitrate Phosphorus Also converts nitrite	DO > 0.2 mg/L	CO ₂ + H ₂ O + N ₂ 3.57 mg/L Alkalinity
Ammonia-oxidizing bacteria (AOB) (<i>Nitrosomonas</i>)	Ammonia (NH ₃ -N) to Nitrite (NO ₂ -N)	1 mg/L NH ₃ -N 7.14 mg/L alkalinity DO concentration > 1.5 mg/L		Nitrite (NO ₂ -N)
Nitrite-oxidizing bacteria (NOB) (<i>Nitrobacter</i>)	Nitrite (NO ₂ -N) to Nitrate (NO ₃ -N)	Longer MCRT / SRT		Nitrate (NO ₃ - N)
Phosphate Accumulating Organism (PAO) <i>Accumulibacter</i>	Accumulates Phosphorus	Minimum ratios of C to P COD = 45:1 BOD ₅ = 20:1 rbCOD = 10 – 16:1 VFA = 4 – 16:1 Cycle between anaerobic and aerobic conditions ORP < -50 mV anaerobic zone Minimal clarifier blanket time.	Anaerobic time longer than 90 minutes. Aerobic time greater than 24 hours. Long SRTs	Effluent P < 1.0 mg/L
Phosphate Accumulating Organism (PAO) <i>Tetrasphaera</i>	Accumulates Phosphorus	Cycle between anaerobic and aerobic conditions ORP < -300 mV anaerobic zone Minimal clarifier blanket time.	Anaerobic time longer than 90 minutes. Aerobic time greater than 24 hours. Long SRTs	Effluent P < 1.0 mg/L
Glycogen Accumulating Organism (GAO) <i>Competibacter</i>	Consumes VFAs Competes with PAOs	Temperatures > 28 °C High strength wastewater Low pH in anaerobic zone	Lack of variety of VFAs available. (need a mixture)	N/A

Ammonia

Ammonia in wastewater effluent can be toxic to aquatic life in certain instances. By providing additional biological treatment beyond the secondary stage, nitrifying bacteria present in wastewater treatment can biologically convert ammonia to the non-toxic nitrate through a process known as nitrification.

The nitrification process is normally sufficient to remove the toxicity associated with ammonia in the effluent. Since nitrate is also a nutrient, excess amounts can contribute to increased levels of algae growth. In situations where nitrogen must be removed from effluent discharge, additional biological process can be added to the system to convert the nitrate (NO_3^-) to nitrogen gas.

Ammonia is a nutrient that contains nitrogen and hydrogen. Its chemical formula is NH_3 in the un-ionized state and NH_4^+ in the ionized form.

Total ammonia is the sum of both NH_3 and NH_4^+ . Total ammonia is what is measured analytically in water.

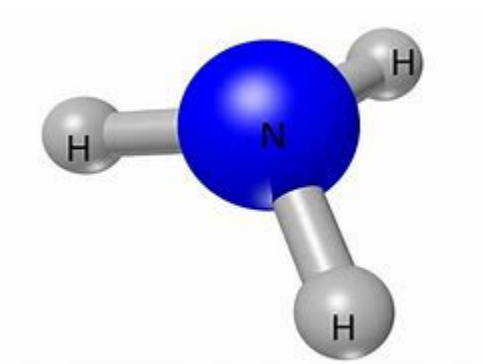

Ammonia Molecule

Ammonia (CAS # 7664-41-7, atomic mass 17.03) is a colorless alkaline gas that has a pungent suffocating odor at ambient temperature and pressure (WHO 1986; CCREM 1987). It freezes at -77.8°C and boils at -33.35°C , and is often stored or shipped in liquefied form in a concentrated form. (Geadah 1985).

Ammonia is excreted by animals and produced during decomposition of plants and animals, thus returning nitrogen to the aquatic system.

Ammonia is also one of the most important pollutants because it is relatively common but can be toxic, causing lower reproduction and growth, or death. The neutral, unionized form (NH_3) is highly toxic to fish and other aquatic life.

Ammonia can form explosive mixtures with air at concentrations between 16 and 27% by volume, but is generally regarded as non-flammable (WHO 1986; Geadah 1980). Ionized ammonium salts form when ammonia dissolves in dilute acids. Some of these salts are found in nature (water, soil, atmosphere) (WHO 1986).

Ammonia is an important component of the nitrogen cycle and it is oxidized in the environment by microorganisms (i.e., nitrification). It is a large source of available nitrogen in the environment (Raven & Johnson 1989).

The complexity of the nitrogen cycle, various rate determining environmental conditions for nitrification (e.g., pH, temperature), and the physical behavior of ammonia (e.g., volatilization, adsorption) make determining the fate of ammonia in the environment extremely complex.

Ammonia is the preferred nitrogen-containing nutrient for plant growth. Ammonia can be converted to nitrite (NO_2) and nitrate (NO_3) by bacteria, and then used by plants.

Nitrate and ammonia are the most common forms of nitrogen in aquatic systems. Nitrate predominates in unpolluted waters.

Nitrogen can be an important factor controlling algal growth when other nutrients, such as phosphate, are abundant. If phosphate is not abundant it may limit algal growth rather than nitrogen.

Ammonia is analyzed by chemical titration. The method used in most test kits is called the salicylate method.

Always measure pH and temperature when you measure ammonia. Without these other measurements it will be difficult to know the toxicity of the ammonia.

The careful reporting of ammonia test results is very important. Do not simply tabulate your results as " NH_3 " because this abbreviation is used for both total and unionized ammonia. Be sure you indicate which you are reporting.

Results can be expressed as: total ammonia (mg/l), un-ionized ammonia (mg/l), total ammonia (as N, mg/l), un-ionized ammonia (as N, mg/l).

Phosphorus Sub-Section *Credit EPA*

Total phosphorus (TP) in domestic wastewater typically ranges between 4 and 8 mg/L but can be higher depending on industrial sources, water conservation, or whether a phosphate detergent ban is in place. Sources of phosphorus are varied. Some phosphorus is present in all biological material, as it is an essential nutrient and part of a cell's energy cycle. Phosphorus is used in fertilizers, detergents, and cleaning agents and is present in human and animal waste.

TOTAL PHOSPHORUS AND PHOSPHATE

Phosphates enter the water ways through both non-point sources and point sources. Non-point source (NPS) pollution refers to water pollution from diffuse sources. In point source pollution, discharges occur to a body of water from discrete locations.

The non-point sources of phosphates include: natural decomposition of rocks and minerals, storm water runoff, agricultural runoff, erosion and sedimentation, atmospheric deposition, and direct input by animals/wildlife. Point sources include: wastewater treatment plants and permitted industrial discharges.

Phosphorus in wastewater is in one of three forms:

- Phosphate (also called Orthophosphate)
- Polyphosphate, or
- Organically bound phosphorus.

TOTAL PHOSPHORUS LEVELS

1. No more than **0.1 mg/L** for streams which do not empty into reservoirs,
2. No more than **0.05 mg/L** for streams discharging into reservoirs, and
3. No more than **0.025 mg/L** for reservoirs.



The orthophosphate fraction is soluble and can be in one of several forms (e.g., phosphoric acid, phosphate ion) depending on the solution pH. Polyphosphates are high-energy, condensed phosphates such as pyrophosphate and trimetaphosphate. They are soluble but will not be precipitated out of wastewater by metal salts or lime. They can be converted to phosphate through hydrolysis, which is very slow, or by biological activity.

Organically bound phosphorus can either be in the form of soluble colloids or particulate. It can also be divided into biodegradable and non-biodegradable fractions. Particulate organically bound phosphorus is generally precipitated out and removed with the sludge.

Soluble organically bound biodegradable phosphorus can be hydrolyzed into orthophosphate during the treatment process. Soluble organically bound non-biodegradable phosphorus will pass through a conventional wastewater treatment plant. A typical wastewater contains 3 to 4 mg/L phosphorus as phosphate, 2 to 3 mg/L as polyphosphate, and 1 mg/L as organically bound phosphorus (WEF and ASCE, 2006).

Phosphorus content in wastewater can be measured as

- Orthophosphate
- Dissolved orthophosphate
- Total phosphorus
- Total dissolved phosphorus (i.e., all forms except particulate organic phosphorus)

Colorimetric analysis are EPA approved laboratory methods. Colorimetric analysis measures orthophosphate only, so a digestion step is needed to convert polyphosphate and organic phosphorus to orthophosphate to measure Total phosphorous (TP).

PHOSPHORUS CONTROL

Controlling phosphorous discharged from municipal and industrial wastewater treatment plants is a key factor in preventing eutrophication of surface waters. Phosphorous is one of the major nutrients contributing in the increased eutrophication of lakes and natural waters.

PHOSPHORUS LOADING

Phosphorus concentrations may increase in receiving waters for limited periods but turbulent conditions, short residence times, and shading from sediment often prevent excess algae growth. At low flow in a receiving stream, the proportion of effluent to stream flow can be higher and point sources like wastewater treatment facilities can dominate in-stream phosphorus loading. Low flow conditions often occur in late summer months when temperatures are higher and water is moving slower, all of which tend to encourage algae growth.

To measure the level of phosphorus the persulfate method is reported to be the most common and easiest method (WEF and ASCE, 2006). To determine dissolved phosphorus (either total dissolved phosphorus or total dissolved orthophosphate), the sample is first filtered through a 0.45 micron filter.

USEPA approved colorimetric methods are routinely used to measure phosphorus levels as low as 0.01 mg/L. On-line analyzers that use the colorimetric method are available from vendors (e.g., the Hach Phosphax™ SC phosphate analyzer). Ion chromatography is another common technique used to measure orthophosphate in wastewater. As with colorimetric methods, digestion is required for TP measurement, with persulfate digestion recommended (WEF and ASCE, 2006).

Phosphorus Forms in Wastewater

	Phosphate	Polyphosphate	Organic Phosphate
Chemical Form	Orthophosphate Reactive phosphate	Condensed phosphates	Organically bound (Part of proteins)
Location	Soluble / may be adsorbed to particles	Soluble / may be adsorbed to particles	Soluble, colloidal or particulate

Biological Phosphorus Control

Like nitrogen, phosphorus is also a necessary nutrient for the growth of algae. Phosphorus reduction is often needed to prevent excessive algal growth before discharging effluent into lakes, reservoirs and estuaries.

Phosphorus removal can be achieved through chemical addition and a coagulation-sedimentation process discussed in the following section. A biological treatment processes called biological nutrient removal (BNR) can also achieve nutrient reduction, removing both nitrogen and phosphorus.

Most of the BNR processes involve modifications of suspended growth treatment systems so that the bacteria in these systems also convert nitrate nitrogen to inert nitrogen gas and trap phosphorus in the solids that are removed from the effluent.

Total phosphorus (TP) limits of 1 mg/L can be reliably met with EBPR. Final effluent TP concentrations down to 0.3 mg/L have been achieved at some WWTPs.

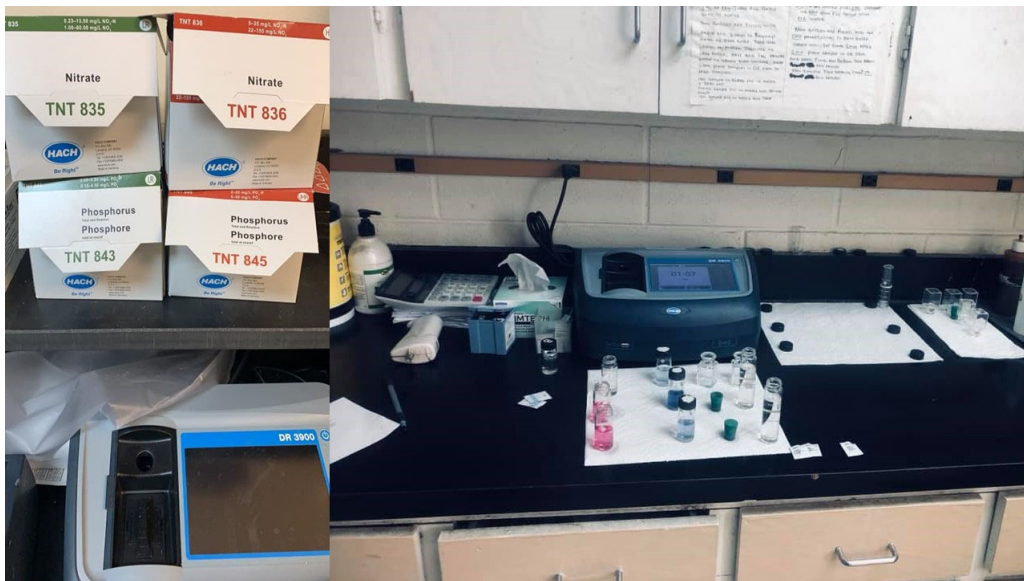

HACH DR 3900 is a widely used spectrophotometer to determine multiple analyses or parameters. The vial with the bluish coloration (center) is phosphorus.

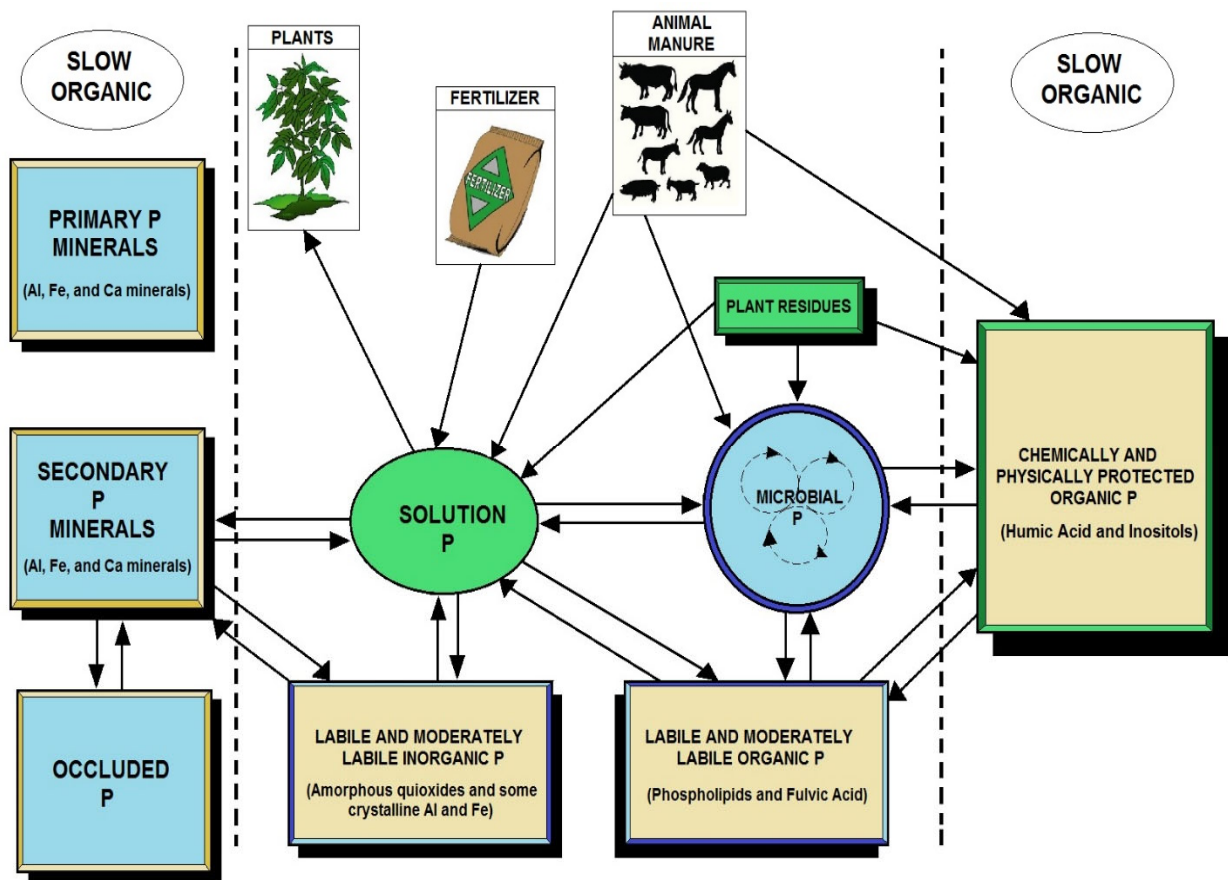

PHOSPHORUS CYCLE

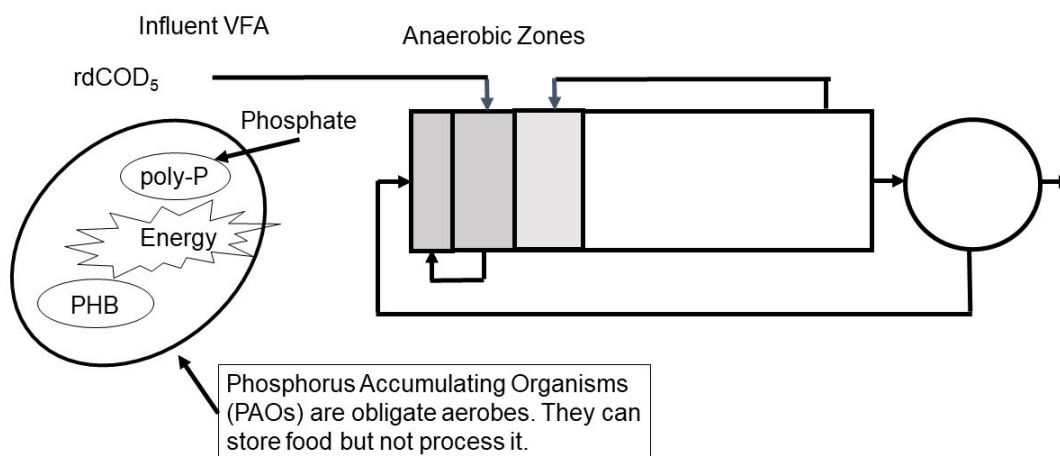

PAO PHOSPHORUS RELEASE IN ANAEROBIC ZONE

Phosphorus Removal (PAOs) Sub-Section - Introduction

Phosphate Accumulating Organisms (PAOs)

Polyphosphate-accumulating organisms (PAOs) are a group of bacteria that, under certain conditions, facilitate the removal of large amounts of phosphorus from wastewater in a process, called enhanced biological phosphorus removal (EBPR). PAOs accomplish this removal of phosphate by accumulating it within their cells as polyphosphate.

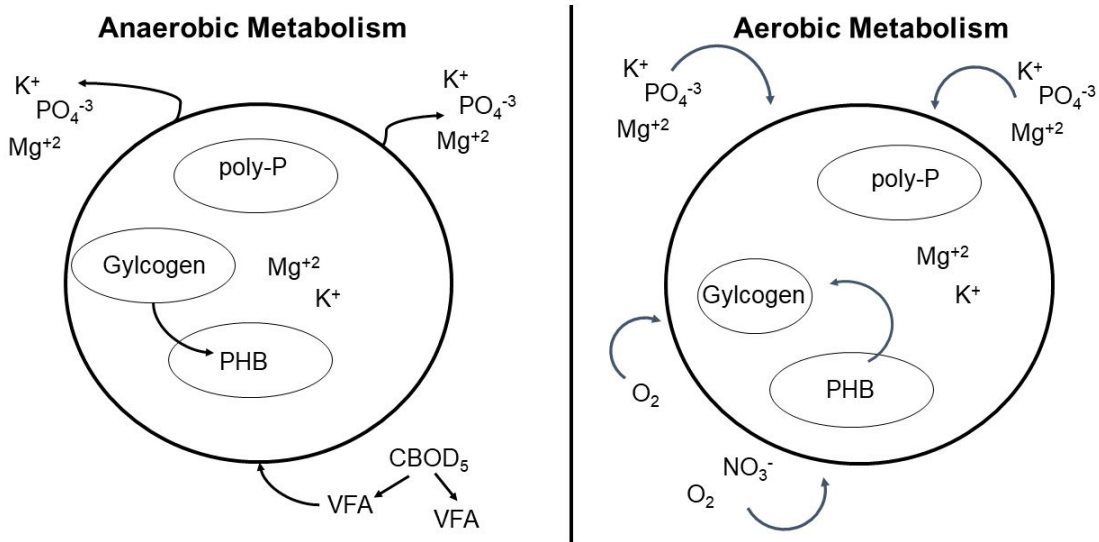

BIOLOGICAL PHOSPHORUS REMOVAL PROCESS

Production of Polyphosphate

PAOs are by no means the only bacteria that can accumulate polyphosphate within their cells and in fact, the production of polyphosphate is a widespread ability among bacteria.

However, the PAOs have characteristics that other organisms that accumulate polyphosphate do not have, that make them amenable to use in wastewater treatment. Specifically, this is the ability to consume simple carbon compounds (energy source) without the presence of an external electron acceptor (such as nitrate or oxygen) by generating energy from internally stored polyphosphate and glycogen.

PAOs Selective Advantage

Most other bacteria cannot consume under anaerobic conditions and therefore PAOs gain a selective advantage within the mixed microbial community present in the activated sludge.

Therefore, wastewater treatment plants that operate for enhanced biological phosphorus removal have an anaerobic tank (where there is no nitrate or oxygen present as external electron acceptor) prior to the other tanks to give PAOs preferential access to the simple carbon compounds in the wastewater influent.

Luxury Uptake

In an anaerobic secondary treatment process, some of the CBOD is broken down through fermentation by anaerobic bacteria into soluble CBOD and simpler organic molecules called VFAs. Volatile fatty acids are chemical compounds that contain 5 carbon atoms or less in their structures. Examples: acetic acid (2 carbons), propionic acid (3 carbons) and butyric acid (4 carbons). Acetic acid is more commonly known as vinegar.

Volatile fatty acids are a preferred source of carbon and energy by heterotrophic bacteria, including the PAOs, because these compounds are easily absorbed into the bacteria.

Logistical Problem

The PAOs have a logistical problem: When PAOs are under anaerobic conditions, they are exposed to VFAs, but without oxygen, nitrite or nitrate present. Picking up “fuel” takes energy, which is unavailable to most facultative heterotrophs in the absence of oxygen, nitrite and nitrate.

The PAOs have a creative solution to this problem. They build a chemical battery from phosphorus. Most cells, including human cells, use a compound called *adenosine triphosphate (ATP)* to store energy.

Adenosine Triphosphate (ATP) Energy

Adenosine triphosphate consists of three phosphate molecules chemically bound together. The chemical bond between phosphorus atoms stores energy until the cell needs it. The ATP is continuously formed and consumed within cells as energy is stored and recovered. The PAOs take ATP to the next level and form an energy-rich compound called polyphosphate, which strings together large numbers of phosphate molecules. Polyphosphate is a chemical battery.

When the PAO needs energy, it breaks the chemical bonds between phosphorus molecules to recover stored energy and temporarily releases phosphorus. This strategy allows the PAOs to pick up and store VFAs when they are under anaerobic conditions. Because they have a battery pack, they are able to outcompete other types of bacteria for the VFAs.

Chemical Precipitation of Phosphorus

Phosphorus can also be precipitated through chemical addition. Alum, ferric chloride, or lime can be added to wastewater where these chemicals combine with phosphorus to form an insoluble solid. The precipitate is removed by settling or filtration. Chemical phosphorus removal can meet effluent levels as low as 0.03 mg/L TP. Chemical and biological phosphorus removal methods are often used together in various combination processes.

Tertiary Filtration

WWTPs typically use biological phosphorus removal methods to reduce P concentrations below 1 mg/L, followed by chemical precipitation at or after the secondary clarifier. Achieving effluent phosphorus concentrations below 0.5 mg/L as P depends upon getting good solids removal in the secondary clarifiers. Solids that escape into the final effluent contain both nitrogen and phosphorus. Many WWTPs are equipped with advanced or tertiary filters to ensure solids capture.

Biological Phosphorus Removal and Combination Processes

This abstract provides an overview of the principles behind biological phosphorus removal (BPR). It describes existing configurations that can achieve phosphorus removal and in many cases, simultaneous nitrogen removal. Key operational issues, impacts on sludge handling, and a summary of ongoing research related to BPR removal are also provided.

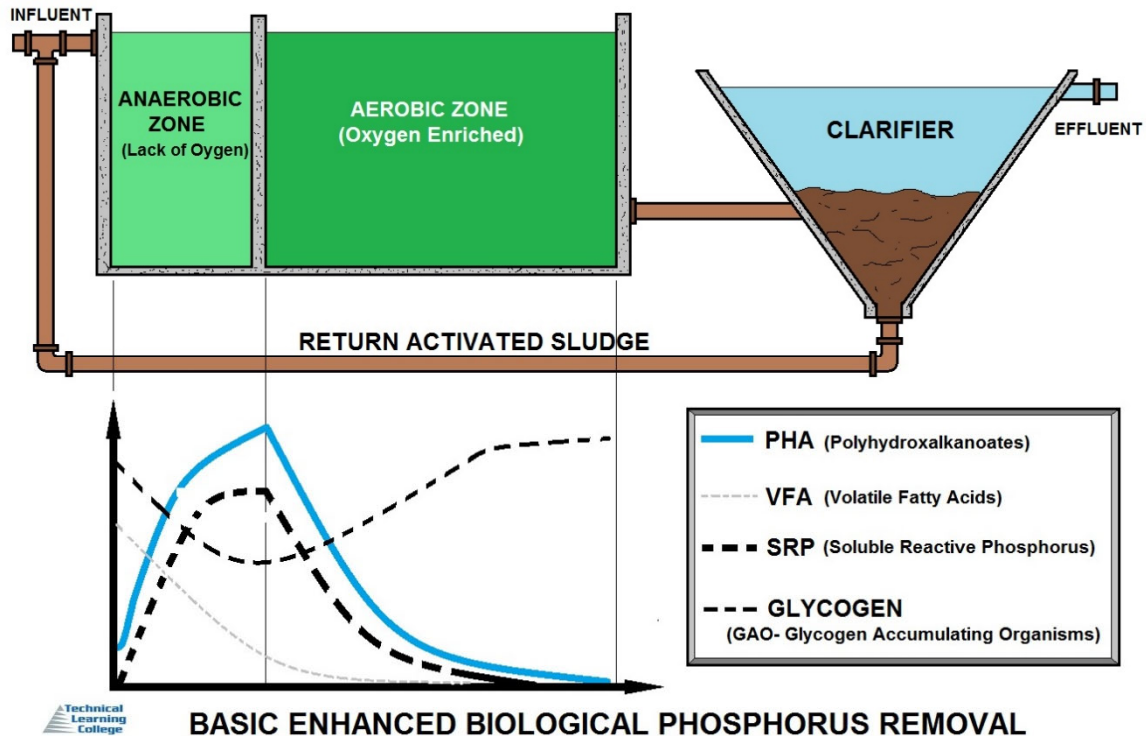

Principles

Biological phosphorus removal is achieved by contacting phosphorus accumulating organisms (PAOs) in the RAS with feed that contains volatile fatty acids (VFA), in a zone free of nitrates and DO (anaerobic zone).

Phosphorus is released in this zone providing energy for uptake of VFAs that are polymerized and stored inside the PAO cells. The anaerobic zone is followed by an aeration zone where the polymerized VFAs are metabolized and phosphorus is taken up again to store excess energy from the metabolism.

The phosphorus content of the mixed liquor suspended solids (MLSS) would be similar to that of the waste activated sludge (WAS). When nitrification occurs in the aeration basin, nitrates will be present in the RAS, resulting in some metabolism of the VFA before storage, thereby reducing subsequent phosphorus uptake.

Some form of denitrification (anoxic zones) must be used to reduce/remove the nitrates from the RAS. The process flow sheets now known as Pho-redox (A/O) and 3 Stage Pho-redox (A2/O) as well as the modified Bardenpho process were first published by Barnard

(1975) as the Pho-redox flow sheets for the removal of phosphorus. The theory for the functioning of the PAO was first suggested by Fuhs & Chen (1975).

Fuhs & Chen Theory

PAOs have the ability to store a large mass of phosphorus in their cells in the form of polyphosphates. Polyphosphates are formed by a series of high-energy bonds. The organisms can subsequently get energy from breaking these bonds. The polyphosphate globules within the cells function just like energy storage batteries.

The storage of polyphosphates (energy), takes place in the aeration zone. In the anaerobic zone, these obligate aerobic bacteria can take up short chain VFA such as acetate and propionate and store them in the form of intermediate products such as poly- β -hydroxybutyrate (PHB).

The energy for transferring the food across the cell membranes in the anaerobic zone is derived from breaking phosphorus bonds. Excess phosphates are released to the liquid in the anaerobic zone.

Some magnesium and potassium ions are co-transported across the cell walls with phosphates. PAOs can only get energy from the food they have taken up in the anaerobic zone when they pass to the aerobic zone where oxygen is available. They use oxygen to metabolize the stored products, deriving enough energy to take up all the released phosphates as well as those in the influent, and store them in the cells. The WAS will contain sufficient phosphate-enriched PAOs to remove most of the phosphorus from the waste stream once enhanced BPR is established.

The right carbon source, in this case a combination of acetates and propionates, is essential for BPR. The wastewater characteristics are thus important. In general, it can be said that you need at least 40:1 COD:TP or about 18:1 BOD₅:TP in the process influent wastewater to reduce effluent phosphorus to less than 1.0 mg/L.

In addition, some of the COD should consist of short chain VFAs. More COD may be required if nitrates must also be denitrified.

Biological phosphorus removal can work with or without nitrification. Biological removal of both nitrogen and phosphorus at the same WWTP is common. Both functions require a carbon source. When nitrification occurs, denitrification within the process is important to reduce the nitrates that may be returned with the RAS.

While denitrification organisms can feed on quite a number of easily degradable materials such as methanol, sugar, glucose, acetate and propionate, PAOs are restricted to the latter two for polymerization and storage (e.g., adding methanol to the anaerobic zone will reduce nitrates but not assist in the removal of phosphorus).

While the anaerobic zone serves mostly as a contact zone for VFAs and PAOs, some fermentation of easily biodegradable carbon compounds (rbCOD) to acetate and propionate may take place. In most plants, the readily biodegradable material is in short supply and must be reserved for the PAOs.

When nitrate or oxygen is present in the anaerobic zone, two things may happen, both undesirable:

- They will prevent fermentation of rbCOD to acetic and propionic acid.
- Nitrates or DO could serve as electron acceptors for PAOs and other organisms that will metabolize the VFA and so deprive the PAOs of the substance that they need to store for growth and phosphorus removal.

In the absence of electron acceptors such as DO and nitrates in the anaerobic zone, PAOs are favored to grow since they can take up and store the VFA under anaerobic conditions, thereby making it unavailable for other aerobic and facultative heterotrophs in the aerobic zone.

Current Configurations

The basic design of anaerobic, anoxic, and aerobic zones, in that order, has been achieved in many different configurations. The configurations vary in the number of stages, the nature and location of recycles, and the operation of the process.

Each process was modified from the standard biological activated sludge design in order to accomplish various design goals (e.g., protection of the anaerobic zone from excess nitrate recycle). The primary processes are listed below.

Of these phosphorous removal configurations, all will also biologically remove nitrogen except for the Pho-redox process.

- Pho-redox (A/O)
- 3 Stage Pho-redox (A₂/O)
- Modified Bardenpho
- 4 Stage Bardenpho
- Modified Ludzack-Ettinger (MLE)
- University of Capetown (UCT) and Modified UCT (MUCT)
- Johannesburg (JHB), Modified Johannesburg, and Westbank
- Orange Water and Sewer Authority (OWASA)
- Oxidation ditches with anaerobic zones or phases added
- SBR operated with an anaerobic phase
- Hybrid chemical/biological processes

Biological Nitrogen Removal Process Configurations

Biological nitrogen removal systems achieve nitrification and denitrification along with BOD reduction in bioreactors followed by secondary clarification. Processes can be either suspended growth or hybrid systems that use a combination of attached growth (biofilms) and suspended growth technologies.

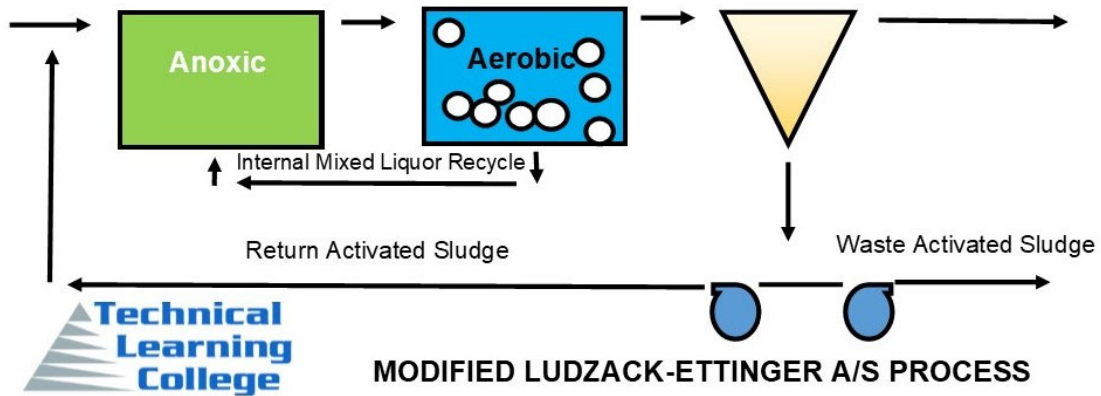

The most common nitrogen removal process used at WWTPs is the Modified Ludzack Ettinger (MLE) process, which is considered a pre-denitrification, single sludge system. The process includes an initial anoxic zone, followed by an aerobic zone.

In the anoxic zone, nitrate produced in the aerobic zone is reduced to nitrogen gas. This process uses some of the BOD in the incoming waste.

Nitrification occurs in the aerobic zone along with the removal of most of the remaining BOD. At the end of the aerobic zone, pumps recycle the nitrate-rich mixed liquor to the anoxic zone for denitrification.

Total nitrogen removal for the MLE process is typically 80 percent, and the process achieves total effluent nitrogen concentrations ranging from approximately 5 to 8 mg/L with internal nitrate recycle ratios of 2 to 4 based on the influent flowrate (2-4Q).

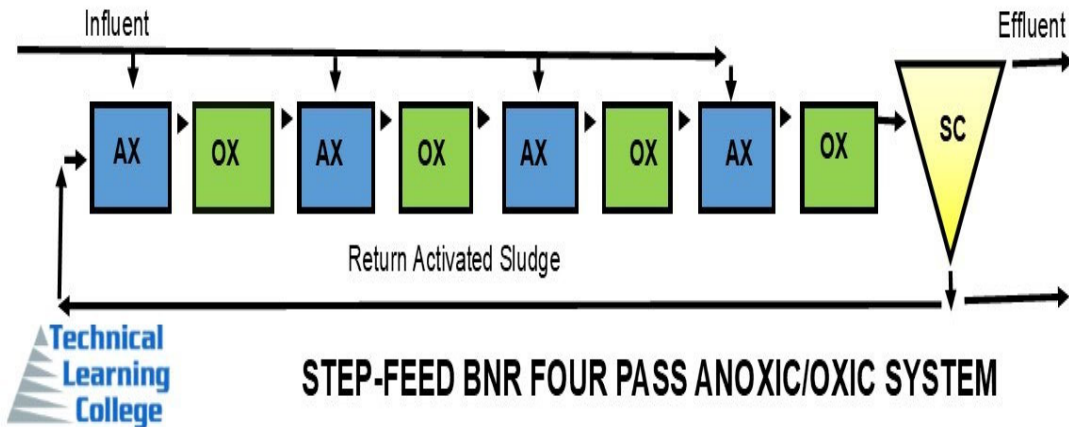

Four-Stage Bardenpho Process

The four-stage Bardenpho process builds on the MLE process, with the first two stages being identical to the MLE system (anoxic zone followed by an aeration zone with a nitrate-rich recycle from the aeration to the anoxic zone).

The third stage is a secondary anoxic zone to provide denitrification to the portion of the flow that is not recycled to the primary anoxic zone.

Methanol or another carbon source can be added to this zone to enhance denitrification.

The fourth and final zone is a re-aeration zone that serves to strip any nitrogen gas and increase the DO concentration before clarification. Some configurations have used an oxidation ditch instead of the first two stages. This process can achieve effluent TN levels of 3 to 5 mg/L.

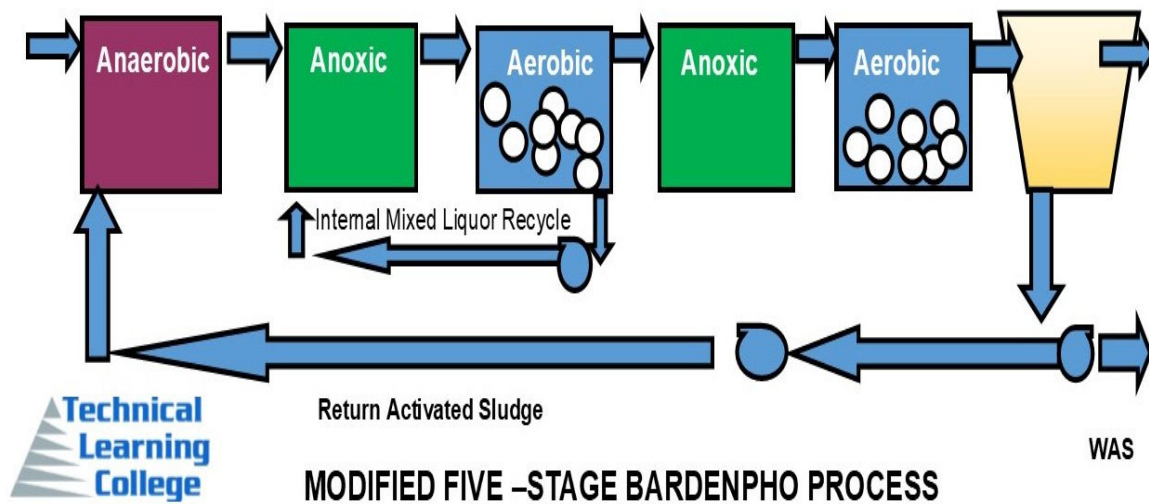

The performance of these technologies depends on many site specific factors, including but not limited to temperature, hydraulic and organic loading, recycle rates, and return streams.

The technologies described in this section are generally capable of phosphorus removal to effluent levels between 0.5 and 1.0 mg/L.

Operating strategies that can be used to enhance biological treatment and achieve these and, in some cases, even lower effluent levels.

Biological phosphorus removal can be combined with other technologies such as chemical addition to achieve very low effluent concentrations (< 0.2 mg/L).

Chemical addition combined with biological removal of phosphorus has been used to consistently achieve low levels.

WEF and ASCE (1998) recommend that WWTPs have chemical addition capabilities even for well operating BPR plants to provide backup phosphorus removal in the event of power outages, pipe breaks, or other unforeseen events.

Solids removal can also be a limiting factor in achieving phosphorus removal below 0.2 mg/L. Very low phosphorus levels generally require a TSS level of less than 5 mg/L. Tertiary filtration (see membrane bioreactors), and advanced clarification processes can achieve TSS levels less than 5 mg/L.

EBPR Significant Microorganism Chart #1

Bacteria	Tetrasphaera	Accumulibacter	Competibacter & Defluviococcus
Produces VFAs	Yes	No	No
Consumes VFAs	Possibly	Yes	Yes
Stores PHB	No	Yes-Anaerobic	No
Stores glycogen	Yes-anaerobic	Yes-Aerobic	Yes-Anaerobic
Cycles poly-P	Yes	Yes	No
Denitrifies	Yes	No	Yes
Anoxic Uptake of P	Possibly	No	No
Anaerobic zone, mV	Below -300mV	-50 to -200 mV	-50 to -200 mV

Minimum Substrate to Phosphorus Requirements Chart #2

Measurement	Organic Carbon-to-Phosphorus Ratio	Description
CBOD5	25:1	Provides a rough and initial estimate. Uses data that is typically required by discharge permit
Soluble CBOD5	15:1	Better indicator than CBOD5
COD	45:1	More accurate than CBOD.
VFA	7:1 to 10:1	More accurate than COD. Involves specialized laboratory analysis
Readily biodegradable COD	15:1	Most accurate. Measures VFA formation potential. Accounts for VFA formation in the anaerobic zone. Requires specialized laboratory testing.

Pho-Redox (A/O) and 3 Stage Pho-Redox (A2/O)

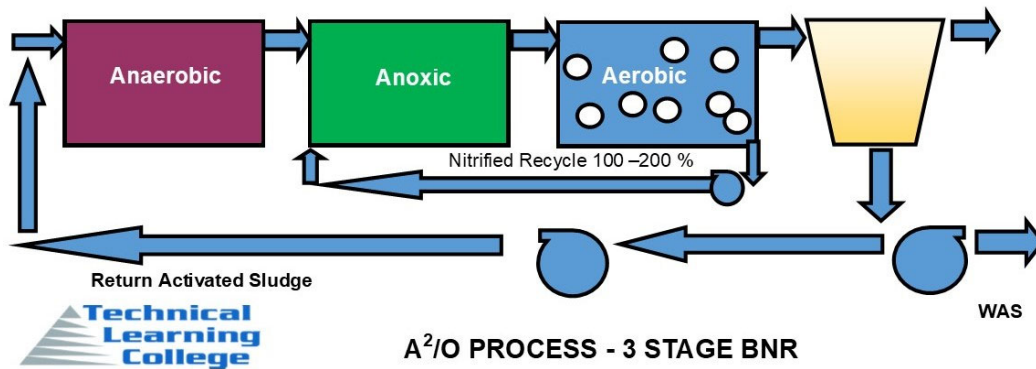

The Pho-redox (A/O) process is a conventional activated sludge system with an anaerobic zone at the head of the aeration basin. The RAS is pumped from the clarifier to the anaerobic zone. It is a low SRT process, operated to avoid nitrification. With no nitrates in the RAS, the process is reliable and easy to operate except at temperatures in excess of 25°C when nitrification is difficult to avoid.

The 3 Stage Pho-redox (A²/O) process adds an anoxic zone after the anaerobic zone to achieve de-nitrification. In addition, a nitrate rich liquor is recycled from the end of the aerobic zone to the head of the anoxic zone to enhance de-nitrification. A shortcoming of the 3 Stage Pho-redox process is that there will be nitrates present in the RAS, potentially making the process less reliable for phosphorus removal.

Modified Bardenpho

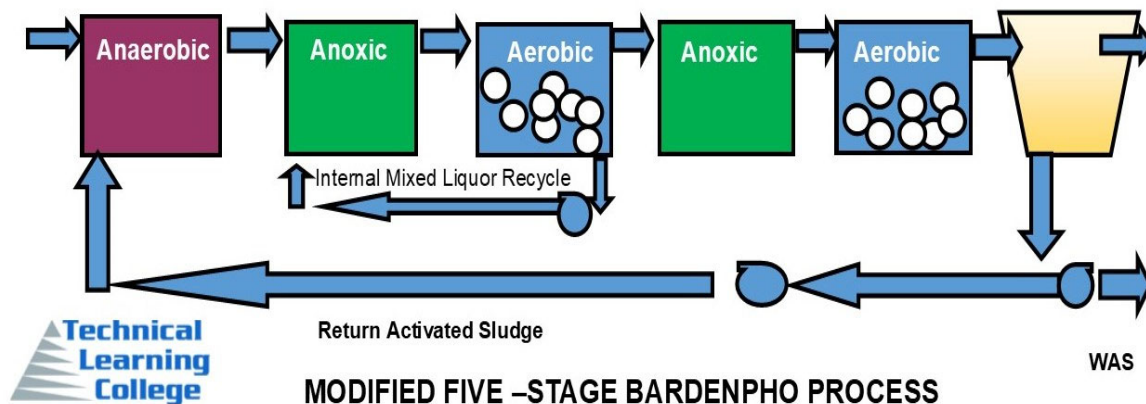

The Bardenpho process removes nitrogen to low concentrations. The addition of an anaerobic zone at the head of the process enables phosphorus removal as well. The process consists of 5 stages: an anaerobic stage followed by alternating anoxic and aerobic stages. A nitrate-rich liquor is recycled from the first aerobic stage, designed for complete nitrification, to the first anoxic stage.

The RAS is recycled from the clarifier to the beginning of the anaerobic zone. Since the nitrates in the RAS ranges from 1 to 3 mg/L, it does not seriously interfere with the mechanism for phosphorus removal as can happen in the 3 Stage Pho-redox process.

University of Cape Town (UCT) and Modified UCT (MUCT)

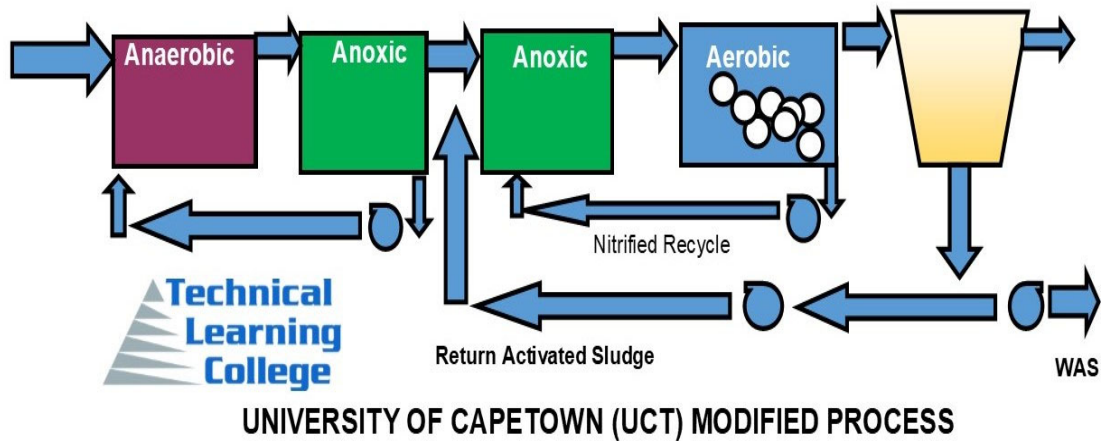

The UCT process was designed to reduce nitrates to the anaerobic zone when high removal of nitrates in the effluent is not required. It consists of three stages: an anaerobic stage, an anoxic stage, and an aerobic stage.

The RAS is returned from the clarifier to the anoxic zone instead of the anaerobic zone to allow for denitrification and to avoid interference from nitrate with the activation of the PAOs in the anaerobic stage.

A nitrate rich stream is recycled from the aerobic zone to the anoxic zone. Denitrified mixed liquor is recycled from the anoxic zone to the anaerobic zone. Several modifications of the process exist. Sometimes it can be difficult to achieve the level of denitrification in the anoxic zone required to protect the anaerobic zone from nitrates when the zone is receiving both RAS and high internal nitrate recycle flows.

This problem led to the development of the modified UCT process, which splits the anoxic zone into two stages. The nitrate rich recycle from the aerobic zone is recycled to the head of the second anoxic stage. The nitrate containing RAS is recycled to the first anoxic stage where it is denitrified.

Next, the denitrified RAS is recycled from the end of the first anoxic stage back to the head of the anaerobic stage and mixed with the incoming wastewater.

Johannesburg (JHB), Modified Johannesburg and Westbank

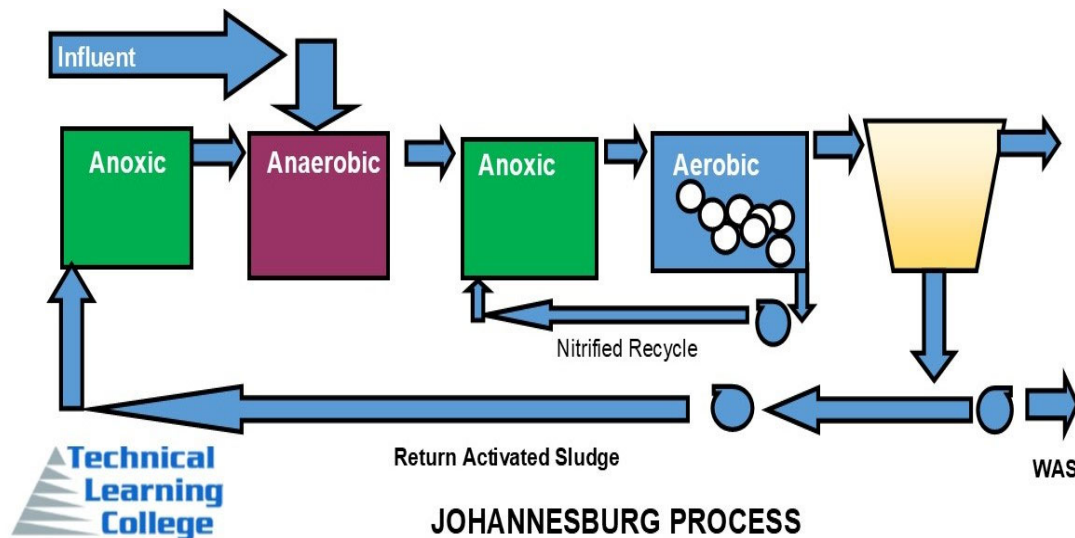

The JHB process is similar to the 3 Stage Pho-redox process, but has a pre-anoxic tank ahead of the anaerobic zone to protect the zone from nitrates when low effluent nitrates are not required. The low COD of the wastewater limited the de-nitrification capacity in the original plant (Northern Works), resulting in nitrates in the RAS.

This reduced biological phosphorous removal (BPR) so much that a pre-anoxic tank was included on the RAS line to remove the nitrates from the RAS flow using endogenous respiration, before the flow entered the anaerobic zone.

The modified JHB process adds a recycle from the end of the anaerobic zone to the head of the pre-anoxic zone to provide residual, readily biodegradable compounds for denitrification.

The Westbank process is similar to the JHB process but adds some primary effluent to the anaerobic zone to assist in denitrification with the remainder of the primary effluent being discharged to the anaerobic zone. During storm flows, excess flow is passed directly to the main anoxic zone. VFA obtained from acid fermentation of the primary sludge is passed to the anaerobic zone.

Oxidation Ditches *Credit EPA*

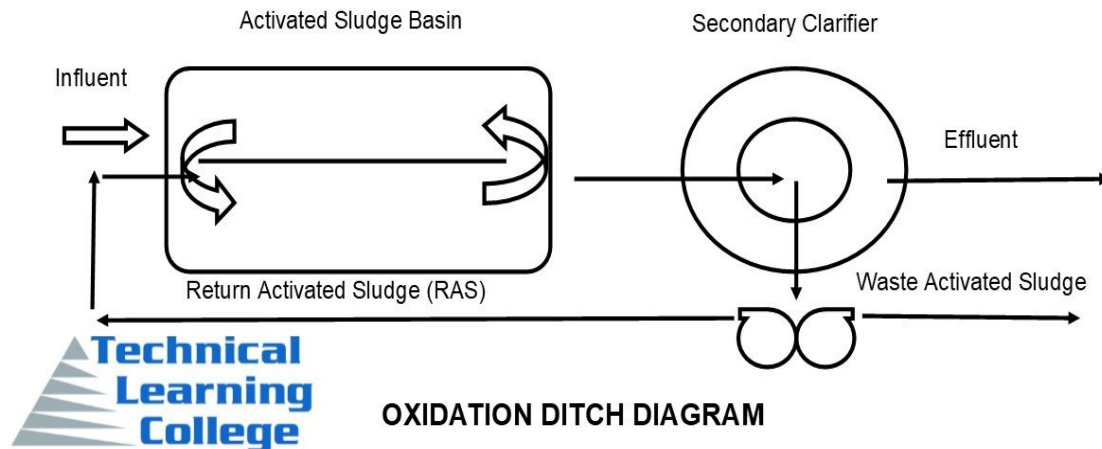

There are several oxidation ditch designs that can remove phosphorus. They normally consist of an anaerobic zone ahead of the oxidation ditch, whereas simultaneous nitrification and denitrification takes place within the ditches.

Oxidation ditches typically operate as racetrack configurations around a central barrier, with forward mixed liquor flows of approximately 1 foot per second or more. It is possible, by manipulating the DO transferred to the mixed liquor, to establish both anoxic, aerobic and near anaerobic zones within the racetrack configuration, even though the high flow velocities accomplish complete mixing of the wastewater with the RAS.

There are many forms of oxidation ditches, such as the Carousel, the Pasveer Ditch and the Orbal process. The Orbal process creates anaerobic and anoxic zones in the outer of three concentric oval shaped ditches with the RAS recycled from the clarifier to the anoxic zone. It is also possible to introduce an anaerobic tank before the ditch to accomplish BPR in the combined system.

The Pasveer Ditch and the Carousel system also can be used in conjunction with an anaerobic zone to accomplish BPR, in addition to simultaneous nitrification and denitrification within the ditches. Because of the very high internal recycle within the ditches, very low nitrate concentrations can be achieved in the mixed liquor before settling, and anaerobic conditions are easy to maintain in the anaerobic zone, thereby resulting in efficient BPR.

The layout would resemble a Pho-redox process with simultaneous nitrification-denitrification (SND) in the aeration basin. Alternatively, the Carousel or Pasveer Ditch could be used as the aeration stage in either the 3 Stage Pho-redox or the Modified Bardenpho process.

The VT2 process at Bowie, MD, operates two Pasveer ditches in series with dedicated anoxic, near anaerobic and aerobic zones. It also has a side stream anaerobic zone that receives only 30 percent of the influent flow to enhance BPR. Denitrified MLSS for the anaerobic zone are obtained from the end of the near anaerobic zone of the adjacent ditch.

Operated without primary sedimentation, the system consistently obtains very low (<0.25 mg/L) effluent TP without chemicals or effluent filtration. The ditches are operated in series because the plant has limited clarification capacity, and series operation results in lower MLSS concentrations to the clarifiers.

The bardenpho process also uses pairs of ditches. The ditches in the bardenpho process operate in alternating anoxic-aerobic modes. An anaerobic tank is placed before the ditches for BPR and the ditches are alternated between nitrification and denitrification.

Sequencing Batch Reactors (SBR)

SBRs are fill-and-draw reactors that operate sequentially through the various phases by means of adjusting the mixing and aeration. The reactor phases can be set and automated to allow the mixed liquor to go through an anaerobic/anoxic/aerobic progression as is necessary for removal of phosphorus and nitrates.

Because of the fill-and-draw nature of SBRs, it is necessary to remove the nitrates remaining from the previous cycle before anaerobic conditions can be established, thus the typical treatment progression becomes anoxic/anaerobic/aerobic.

However, SBRs are almost always operated without primary sedimentation, so they still usually have a favorable BOD₅:TP ratio for effluent TP of somewhat less than 1.0 mg/L during the settling phase.

Hybrid Chemical / Biological Processes

The PhoStrip configuration, used mainly in non-nitrifying plants, pulls a side stream off the RAS in a conventional activated sludge plant.

The side stream is concentrated and retained for a day or more in a thickening tank where the solids blanket is deep enough to produce anaerobic conditions and fermentation, resulting in the release of phosphates by the microorganisms. Lime is then added to the supernatant stream to precipitate and remove phosphate.

The thickened, fermented sludge is passed back to the main aeration basin. Existing plants include Seneca Falls, NY; Lansdale, PA; Adrian, MI; Savage, MD; Southtowns, NY; Amherst, NY; and Reno-Sparks, NV.

The Biological Chemical Phosphorus and Nitrogen Removal (BCFS) configuration is similar to the modified UCT process. In this process, a sludge stream is removed from the anaerobic zone.

Ferric chloride is added to the sludge thickener to remove phosphate. This provides an advantage over chemical addition to the secondary clarifier because it does not require the chemical sludge to be recycled. There is an existing plant at Holten in the Netherlands (WEF and ASCE, 2006), but no performance data are available.

Phosphorus Removal by Chemical Addition

The removal of phosphorus via chemical precipitation has been routine at many WWTPs. Chemical phosphorus removal is normally done by adding common *metal salts*, primarily aluminum sulfate [$\text{Al}_2(\text{SO}_4)_3$] and ferric chloride (FeCl_3). The aluminum ion (Al^{+3}) or iron (Fe^{+3}) metal ions combine with orthophosphate (PO_4^{-3}). The new compounds formed are not very soluble in water and instead come out of solution to form solid particles in a precipitate that can be removed by gravity settling or filtration.

About 50% of the phosphorus entering the WWTP is orthophosphate (PO_4^{-3}). Most of the condensed phosphate and organic phosphate will be converted into orthophosphate during biological treatment. Depending on where the chemical addition is located – headworks, primary clarifier, or secondary clarifier – the percentage of total phosphorus that can be removed will change.

Chemical Precipitation of Phosphorus

Chemical precipitation of phosphorus is often the phosphorus removal method of choice for many small and medium sized WWTPs. Much of the rationale for its popularity is because of its ease both from a process and an operational perspective, resulting in reliable and predictable performance. This is particularly the case when an existing WWTP has to meet new phosphorus compliance and the existing WWTP is not easily modified for enhanced biological phosphorus removal. **Enhanced Biological Phosphorus Removal (EBPR)** will at times have periods of inferior performance or upsets, so chemical phosphorus removal is often provided as a back-up method or as a polishing step to meet low effluent limits.

Chemical Dose

The required chemical dose is related to the liquid phosphorus concentration. For target phosphorous concentrations above 2 mg/L (appropriate for chemical addition to a primary clarifier), a dose of 1.0 mole of aluminum or iron per mole of phosphorus is sufficient.

For lower phosphorus concentrations in the range of 0.3 – 1.0 mg/L, the dose can be in the range of 1.2 to 4.0 moles aluminum or iron per mole of phosphorus. The pH value is an important factor for efficient removal of phosphorus using alum or other salts, as the solubility of their precipitates vary with pH. Phosphorus removal is most efficient in the pH range of 5 to 7 for alum and of 6.5 to 7.5 for ferric salts. In these ranges, their precipitates will not readily return to solution.

Aluminum and Iron Salts

Alum and ferric or ferrous salts are commonly used as coagulant and settling aids in both the water and wastewater industry. Alum is less corrosive than Ferric without drastic changes to pH, creates less sludge, and is more popular with operators when compared to lime, which increases the pH. Alum is available in liquid or dry form, can be stored on site in steel or mild concrete, and has a near unlimited shelf life.

Ferric chloride is similar although care is needed during handling because of corrosivity. If an industrial source is available such as waste pickle liquor, ferrous chloride or ferrous sulfate have been used for phosphorus removal. Ferrous forms should be added directly to aerobic reactors rather than to anaerobic reactors such as primary settling basins because the ferrous iron needs to oxidize to ferric iron for best results.

The molar ratio of aluminum to phosphorus required for phosphorus removal ranges from about 1.38:1 for 75 percent removal, 1.72:1 for 85 percent removal, and 2.3:1 for 95 percent removal.

For iron compounds, a ratio of about 1:1 is required, with a supplemental amount of iron (10 mg/L) added to satisfy the formation of hydroxide (WEF and ASCE, 1998). In practice, for full removal of phosphorus with aluminum and iron salts, a ratio of between 2 and 6 parts metal salt to 1-part phosphorus may be required.

To supplement stoichiometry calculations, designers should consider jar tests and, in some cases, full-scale pilot tests to gauge the effects on the required dose of competing reactions; the influence of pH and alkalinity, adsorption, and co-precipitation reactions. The interaction with polymers that are added to increase coagulation and flocculation should also be evaluated. (WEF and ASCE, 1998; Bott et al. 2007).

Aluminum or ferric iron salts can be added to the primary clarifier, secondary clarifier, tertiary clarifier, or directly into the activated sludge aeration tank. Multiple additions can increase phosphorus removal efficiency. Ferrous salts can only be added to the aeration basin since it needs to be oxidized to ferric to precipitate the phosphorus.

The solubility of aluminum and iron salts is a function of pH. The optimum solubility for alum was previously reported to occur at a pH range of 5.5 to 6.5, significantly lower than most influent wastewater. Recent studies (Szabo et al., 2008) showed that the range for both iron and alum is between 3.5 and 7.5 with the highest efficiency between pH 5.5 and 7.

Chemicals such as lime compounds, caustic soda, and soda ash can be used to raise the pH of the waste stream prior to biological treatment processes or discharge. It is important to understand that alkalinity is consumed during the precipitation reactions, and precipitation will be incomplete if insufficient alkalinity is present.

Lime

Although lime had lost favor due to issues associated with chemical handling, sludge production, and re-carbonation, it has recently been considered more often because of its ability to reduce phosphorus to very low levels when combined with effluent filtration and the microbial control properties associated with its high pH.

When lime is added to wastewater, it first reacts with the bicarbonate alkalinity to form calcium carbonate (CaCO_3). If the pH is allowed to increase to more than 10, excess calcium ions will react with phosphate to precipitate hydroxylapatite [$\text{Ca}_5(\text{OH})(\text{PO}_4)_3$].

Because it reacts first with alkalinity, the lime dose is essentially independent of the influent phosphorus concentration. Tchobanoglous et al. (2003) estimates the lime dose to typically be 1.4 to 1.6 times the total alkalinity expressed as CaCO_3 .

The molar ratio required for phosphorus precipitation with lime is approximately 5:3, but can vary from between 1.3 to 2, depending on the composition of the wastewater. As with iron and aluminum salts, jar tests can be used to determine correct doses for a specific wastewater stream (WEF, 1998).

Lime addition can raise the pH to greater than 11. Because activated sludge processes require pH levels below 9, lime cannot be added directly to biological treatment processes or it will cause process upsets. Lime can be added to primary sedimentation tanks and removed with the primary sludge or it can be added as a tertiary treatment process after biological treatment.

When added to primary tanks, it will also result in the removal of colloidal material through coagulation and settling, with a concomitant removal of TSS up to 80 percent and chemical oxygen demand (COD) up to 60 percent.

In either case, pH adjustment is needed after lime treatment and is typically accomplished by adding CO₂ or a liquid acid such as sulfuric acid, nitric acid, or hypochlorite (Tchobanoglous et al., 2003; USEPA, 1999a).

Hortskotte et al. (1974) showed that when the primary effluent is discharged directly to a nitrifying activated sludge plant, the hydrogen ions produced may neutralize the high pH. However, when denitrification is practiced and the operator wishes to make use of the soluble COD in the primary effluent, the effluent must be neutralized to a lower pH before discharging it to the anoxic zone.

Sludge Production

With chemical addition, sludge production will increase in the wastewater treatment unit process where the chemical is applied. Sludge production has been noted to increase by 40 percent in the primary treatment process and 26 percent in activated sludge plants.

Chemical Phosphorus Removal Stoichiometry

It is important to understand the basic chemical reactions that drive chemical phosphorus removal. In general, cations (positively charge molecules) of the following metals can be used for the precipitation of phosphorus (orthophosphates) from wastewater.

- Aluminum
- Iron
- Calcium
- Magnesium

Summary

- Chemical precipitation for phosphorus removal is a reliable wastewater treatment method that has not significantly changed over the years. To achieve removal, coagulant aids such as iron salts are added to wastewater where they react with soluble phosphates to form precipitates. The precipitates are removed using a solids separation process, most commonly clarification.
- Chemical precipitation is typically accomplished using either lime or a metal salt such as aluminum sulfate (alum) or as mentioned iron salts such as ferric chloride. The addition of polymers and other substances can further enhance floc formation and solids settling. Plant operators can use existing secondary clarifiers or retrofit primary clarifiers for removal of sludge

Aluminum Sulfate Formula Weight Breakdown Chart #3

Element	Atomic Weight g/mole		Number of atoms		Total weight
Aluminum	27	X	2	=	54
Sulfur	32	X	3	=	96
Oxygen (Alum)	16	X	12	=	192
Hydrogen (Water)	1	X	28	=	28
Oxygen (Water)	16	X	14	=	224
					594 g/mole

Properties of Alum-Based Chemicals Used in Phosphorus Precipitation

Chemical Name	Aluminum Sulfate, Dry	Aluminum Sulfate, 49% Solution	Sodium Aluminate, Anhydrous	Polyaluminium Chloride
Form	Dry	Liquid	Powder	Liquid
Common Name	Filter Alum	Alum	-----	PACl
Formula Weight, g/mole	$Al_2(SO_4)_3 \cdot 14H_2O$	$Al_2(SO_4)_3 \cdot 14H_2O$	$NaAlO_2$	Varies $Al_{12}Cl_{12}(OH)_{24}$
Commercial strength, by weight	17% Al_2O_3	8.3% Al_2O_3	41-46% Al_2O_3	4.9-26.7% Al_2O_3
Aluminum metals contents, % by weight	9.1	4.4	33	Varies by manufacture
Alkalinity	Consumes	Consumes	Generates	Depends upon formulation
pH Change	Potential decrease	Potential decrease	Potential increase	Typically no change Depends upon formulation
Weight ratio of dry chemical for stoichiometric precipitation of P	9.6	9.6	2.64	Depends upon formulation

Phosphorous Solids Separation Processes Sub-Section

The effectiveness of phosphorus removal by chemical addition is highly dependent on the solids separation process following chemical precipitation.

Direct addition of metal salts to activated sludge processes followed by conventional clarification can typically remove Total Phosphorous (TP) to effluent levels between 0.5 and 1.0 mg/L (Bott et al., 2007). Tertiary processes (post-secondary treatment) can be used to remove phosphorus to very low (< 0.1 mg/L) concentrations. For example, Reardon (2005) reports that four WWTP with tertiary clarifiers achieved TP levels of between 0.032 and 0.62 mg/L.

Two common tertiary processes are clarification and effluent filtration. These approaches can be used separately or in combination. Advances in tertiary clarification processes are discussed below.

The types of clarifiers used for tertiary processes include conventional, one or two-stage lime, solids-contact, high-rate, and ballasted high-rate (BHRC). Several patented BHRC using different types of ballast such as recycled sludge, microsand, and magnetic ballast (USEPA, 2008a) have been developed in recent years.

The advantages of high-rate clarification are that the clarifiers have a smaller footprint and are able to treat larger quantities of wastewater in a shorter period of time. In addition, as an add-on during wet weather, they can help prevent sanitary sewer overflows (SSOs) and combined sewer overflows (CSOs).

The following patented processes are examples of high rate clarification, including performance estimates:

- DensaDeg® uses a coagulant in a rapid mix basin to destabilize suspended solids. The water flows into a second tank where polymer (for aiding flocculation) and sludge are added. The sludge acts as the “seed” for formation of high density floc. This floc is removed in settling tubes (USEPA, 2008). The main advantages of this process are a smaller footprint and denser sludge which is easier to dewater. Pilot testing for City of Fort Worth, Texas found a phosphorus removal rate of 88-95% for DensaDeg® (USEPA, 2003).
- Actiflo® uses a coagulant in a rapid mix basin to destabilize suspended solids. The water flows to a second tank where polymer (for aiding flocculation) and microsand are added. Microsand provides a large surface onto which suspended solids attach, creating a dense floc that settles out quickly. Clarification is assisted by lamella settling. Product pilot testing in Fort Worth, Texas showed a phosphorus removal efficiency of 92-96% for Actiflo®(USEPA, 2003).
- The CoMag process uses the addition of magnetic ballast with metal salts to promote floc formation. Settling is followed by high gradient magnetic separation for effluent polishing and recovery of the magnetic ballast (USEPA, 2008a). CoMag is currently in operation at a 4.0 million gallons per day (MGD) wastewater treatment plant in Concord, Massachusetts. The vendor has guaranteed an effluent phosphorus concentration not to exceed 0.05 mg/L (EPA Region 10, 2007).

Other Design and Operational Issues

Phosphorus removal by chemical addition is limited to the soluble phosphates in the waste stream.

Organically bound phosphorus and polyphosphates will not be removed by chemical treatment unless they are coagulated with the chemicals and removed in the sludge. Chemicals can be added after biological treatment to capitalize on the conversion of polyphosphates and organically bound phosphorus to phosphates by microorganisms in activated sludge.

The success of phosphorus removal by chemical addition depends on proper instrumentation and control. Dosage control typically takes the form of manual operation (for small systems), adjustments based on automatic flow measurements, or the more advanced on-line analyzers with computer-assisted dosage control.

Chemical properties of any water used for making solutions should be considered – tap water high in suspended solids could cause sludge to form when mixed with coagulants (WEF and ASCE, 1998) and could lead to clogging of chemical feed lines. Smith et al. (2008) found that factors such as pH, complexation, mixing, and the coagulant used can limit the removal of phosphorus, especially in the range of <0.1 mg/L.

Impacts on Sludge Handling and Production

Sludge handling and production is generally considered to be one of the main downsides of chemical addition. Chemical precipitation methods always produce additional solids due to the generation of metal- or calcium- phosphate precipitates and additional suspended solids (WEF and ASCE, 1998).

Chemically treated sludge has a higher inorganic content compared to primary and activated sludge and will increase the required size of aerobic and anaerobic digesters. Additional sludge production can be estimated using reaction equations. The use of metal salts can result in increased inorganic salts (salinity) in the sludge and in the effluent.

Salinity can create problems when biosolids are land applied or when the effluent is returned to existing water supply reservoirs. Biological phosphorus removal was developed in South Africa due to the high rate of indirect recycling of wastewater effluent which led to excessive total dissolved solids (TDS) during dry periods. High total salts can reduce germination rates for crops and negatively affect the soil structure.

Lime traditionally produces a higher sludge volume compared to metal salts because of its reaction with natural alkalinity. An advantage of lime sludge is that some stabilization can occur due to the high pH levels required. One disadvantage is that lime can cause scaling in mechanical thickening and dewatering systems. There are also differences in the amount and characteristics of sludge generated by alum versus ferric salts. Although alum tends to produce less sludge than do ferric salts, alum sludge can be more difficult to concentrate and dewater compared to ferric sludge.

Biological Nitrogen Removal

This section provides an overview of the principles behind biological nitrogen removal and describes the common design configurations in use today. It identifies key operational and design issues (including impacts on sludge handling and production), provides general guidelines on process selection, and summarizes ongoing research efforts in this area. Process configurations that are designed to remove both nitrogen and phosphorus are described later.

Principles

In wastewater treatment, nitrogen removal occurs in two sequential processes: nitrification and denitrification. An overview of each process is provided below.

Nitrification

Nitrification is an aerobic process in which autotrophic bacteria oxidize ammonia or nitrite for energy production. Nitrification is normally a two-step aerobic biological process for the oxidation of ammonia to nitrate.

Ammonia-nitrogen ($\text{NH}_3\text{-N}$) is first converted to nitrite (NO_2^-) by ammonia oxidizing bacteria (AOB). The nitrite produced is then converted to nitrate (NO_3^-) by nitrite oxidizing bacteria (NOB). Both reactions usually occur in the same process unit at a wastewater treatment plant (e.g. activated sludge mixed liquor or fixed film biofilm).

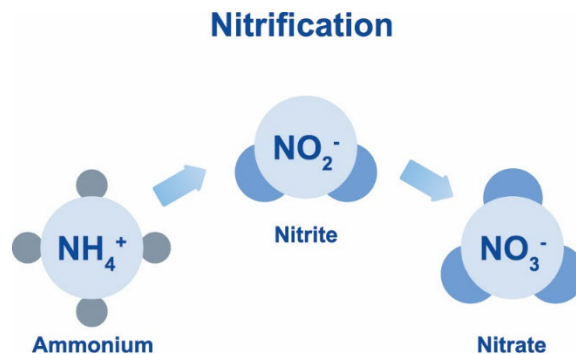

The group of AOB most associated with nitrification is the *Nitrosomonas* genus, although other AOB such as *Nitrosococcus* and *Nitrospira* can contribute to the process. *Nitrobacter* are the NOB most associated with the second step, although other bacteria including *Nitrospina*, *Nitrococcus*, and *Nitrospira* have been found to also oxidize nitrite (Tchobanoglous et al., 2003; USEPA, 2007c).

AOB and NOB are classified as autotrophic bacteria because they derive energy from the oxidation of reduced inorganic compounds (in this case, nitrogenous compound) and use inorganic carbon (CO_2) as a food source.

Nitrifying bacteria require a significant amount of oxygen to complete the reactions, produce a small amount of biomass, and cause destruction of alkalinity through the consumption of carbon dioxide and production of hydrogen ions.

For each gram (g) of $\text{NH}_3\text{-N}$ converted to nitrate, 4.57 g of oxygen are used, 0.16 g of new cells are formed, 7.14 g of alkalinity are removed, and 0.08 g of inorganic carbon are utilized in formation of new cells (Tchobanoglous et al., 2003).

Nitrifying bacteria grow slower and have much lower yields as a function of substrate consumed, compared to the heterotrophic bacteria in biological treatment processes.

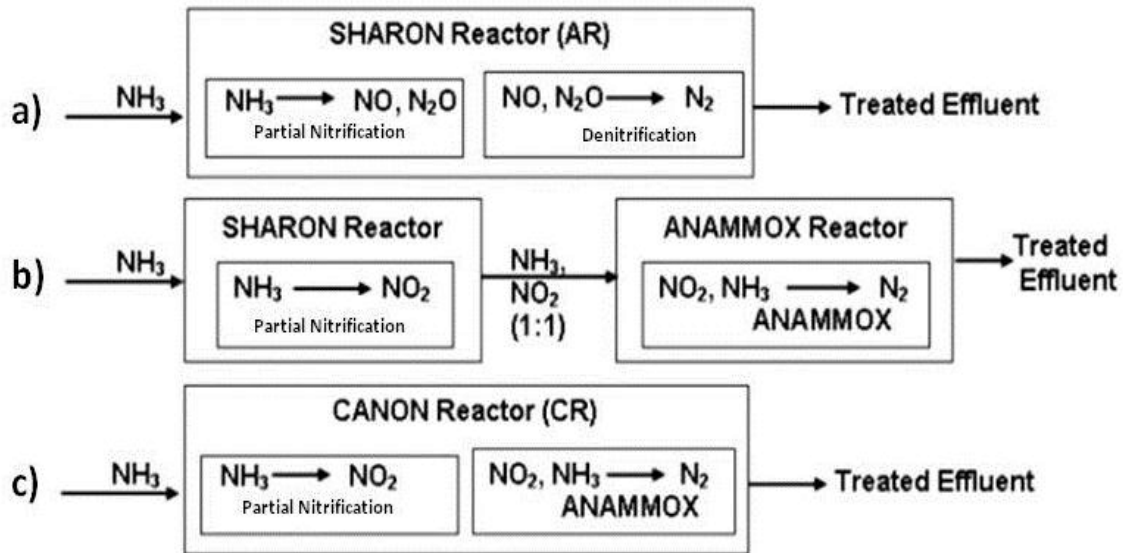

The maximum specific growth rate of the nitrifying bacteria is 10 to 20 times less than the maximum specific growth rate of heterotrophic bacteria responsible for oxidation of carbonaceous organic compounds in wastewater treatment. Thus, the nitrification process needs a significantly higher SRT to work compared to conventional activated sludge processes.

The SRT needed for nitrification in an activated sludge process is a function of the maximum specific growth rate (which is related to temperature), the reactor dissolved oxygen concentration, and pH.

Nitrification rates decline as the DO concentration decreases below 3.0 mg/L and the pH decreases below 7.0 mg/L.

With sufficient DO and adequate pH, typical nitrification design SRTs range from 10 to 20 days at 10°C and 4 to 7 days at 20°C (Randall et al., 1992).

COD:P Ratio

The PAOs need VFAs in the form of acetic and propionic acid. These acids may be in the feed or can be produced through fermentation of soluble readily biodegradable COD (rbCOD) such as sugar, ethanol, etc., in the anaerobic zone. As a rough estimate of the propensity for phosphorus removal to an effluent concentration less than 1.0 mg/L, the COD:P ratio typically should be about 40 or more. VFA is produced through fermentation of municipal wastewater or it can be added as a commercial or waste product. Some wastewater collection systems that are relatively flat and have long collection times may have sufficient fermentation in the collection system to provide the necessary VFAs, but it will vary monthly depending upon the temperature and flow conditions in the collection system. Force mains are excellent fermenters for the production of VFA.

Systems that do not have a COD/P ratio of at least 40:1 will most likely need to supplement VFAs to achieve effluent phosphorus concentrations below 1.0 mg/L. However, they will still achieve substantial BPR with lower ratios if appropriately operated. See below for a more detailed discussion of VFAs.

Recent studies suggest that the instantaneous COD:P ratio is more important than the overall average (Neethling et al., 2005). Short term drops in the BOD:P ratio in the primary effluent to below that required for sustainable phosphorus removal correlated well with rises in effluent phosphorus. Intermittent recycles of phosphorus- rich return streams may cause short term variability in the BOD:P ratio. Controlling or eliminating these recycles can improve plant performance. Weekend changes in the BOD:P ratio can also affect performance.

Another group of organisms, glycogen accumulating organisms (GAOs), also has the ability to take up acetate in the anaerobic zone, not by using energy in phosphate bonds but by using stored glycogen as the energy source. Under certain conditions, such as high temperatures or low phosphorus concentrations relative to the influent bioavailable COD, they may out-compete PAOs for the VFAs, which would result in less or no storage of phosphorus in the anaerobic zone. This in turn will result in less or no overall phosphorus removal. GAOs use the stored energy in the form of glycogen to take up VFAs and store them as a complex carbohydrate containing poly-hydroxy valerate (PHV), instead of PHB formed with poly-phosphorus as the energy source. When this begins to happen, there is a slow decline of phosphorus removal by the biological system.

There is still a debate amongst researchers about the conditions likely to favor GAOs over PAOs. Summarizing a number of publications, it would appear that the following conditions favor the growth of GAOs over that of PAOs:

- High SRT
- High temperature; over 28 °C
- Longer non-aerated zones
- Stronger wastes with low TKN content
- Periods of intermittent low BOD loads
- The VFA consists mostly of either acetate or propionate
- Polysaccharides such as glucose are fed to the anaerobic zone.
- Low pH in the aerobic zone

Further confirmation is needed for some of these factors.

Volatile Fatty Acid Addition

Only VFAs such as acetic and propionic are taken up by PAOs. Reported doses of VFA for successful phosphorus removal range from 3 to 20 mg/L VFA per gram of phosphorus removed. These numbers, however, do not take into account the rbCOD that is fermented in the anaerobic zone. It is more accurate to look at the rbCOD/P ratio for good phosphorus removal, which ranges from 10 to 16. (Barnard, 2006). Surveys show that it is rare for a WWTP treating municipal sewage to achieve more than 95 percent removal of phosphorus by biological processes without adding VFAs (Neethling et al., 2005).

An Australian study shows that while both PAOs and GAOs could use acetate, PAOs will have a competitive advantage when the VFAs consist of roughly equal parts of acetic and propionic acid as a growth medium. PAOs that are fed on acetate are able to switch to propionate much more quickly and effectively than GAOs (Oehmen et al., 2005). This finding led to a strategy to feed equal amounts of acetic acid and propionic acid as the optimal for stimulating PAO growth (Oehmen et al., 2006, Bott et al., 2007). One study shows that isovaleric acid drives BPR even better than acetic acid (Bott et al., 2007).

Isovaleric acid, however, is much more expensive than acetic acid and is more odorous. It also is not significantly generated in the primary sludge fermentation process. Addition of rbCOD such as sugars and alcohols containing two carbons or more can increase phosphorus uptake by PAOs when added to the anaerobic zone but may cause sludge bulking if dosed in excess (Jenkins and Harper, 2003).

Sludge Fermentation

Anaerobic fermentation produces VFA consisting mainly of acetic and propionic acid. Some configurations, such as the Westbank and OWASA configurations, make use of anaerobic fermentation of the primary sludge to provide VFAs to the nutrient removal process. A fermentation process, however, can be added to any configuration to provide VFAs, especially in areas where little fermentation takes place in the collection system. Fermentation of the primary sludge or the RAS will produce VFA. Primary sludge fermentation is used more frequently.

There are several primary sludge fermenter designs that can accomplish this. The simplest configuration involves allowing the formation of a thicker sludge blanket in the primary clarifier itself and returning some of the thickened sludge to either the primary clarifier or to a mixing tank ahead of the primary clarifier to allow elutriation of the VFA to the primary effluent. This is referred to as an activated primary sedimentation tank (Barnard, 1984). Another variation is to pump some sludge to a complete-mix tank ahead of the primary clarifier, to accomplish fermentation.

The sludge is then passed to the primary clarifier for elutriation of the VFA. Both of these processes lead to an increased load on the primary clarifier and some VFA may be lost due to aeration between the primary clarifier and the anaerobic zone. Sludge age should also be controlled to prevent methanogenic bacteria from growing and converting the VFA to methane. Usually, a SRT for the primary sludge of less than 4 days is sufficient for this.

Alternative methods accomplish fermentation in a gravity sludge thickener by holding the sludge under anaerobic conditions for 4 to 8 days. The supernatant can then be fed directly to the anaerobic zone and a high load on the primary clarifier can be avoided. Thickening can either be accomplished with a single thickener or in two stages.

Retention Time

The concentration of phosphorus in the sludge typically increases as the SRT of the secondary sludge increases, although the impact is very small over the SRT range of 4 to 30 days. Efficient phosphorus uptake typically requires a minimum SRT of 3 to 4 days depending on temperature. Higher SRTs will not increase phosphorus uptake; given there is sufficient VFAs available.

If SRT becomes too great, however, effluent quality can degrade. This can be due to release of phosphorus as biomass degrades (WEF and ASCE, 2006). Both anaerobic and aerobic hydraulic retention time (HRT) can affect the amount of phosphorus stored by PAOs. Sufficient time should be allowed for the formation of VFAs and storage of the Polyhydroxyalkanoates (PHAs) in the anaerobic zone, although the reactions are relatively fast. If the time is too short, phosphorus uptake in the aerobic zone will be lower than achievable because insufficient PHAs were stored in the anaerobic zone. It has been reported that the ratio of HRT in the anaerobic zone to the HRT in the aerobic zone is important. One study found that a ratio of between 3 and 4 for aerobic HRT to anaerobic HRT led to optimal plant operation (Neethling et al., 2005).

Temperature

High temperatures can have an adverse effect on phosphorus removal. At water temperatures greater than 28° C, phosphorus removal will generally be impaired, apparently by the predominance of the GAOs (Bott et al., 2007). At the low end of the temperature scale, Erdal et al. (2002) found that PAOs outcompeted GAOs at 5° C even though the PAO metabolism was slower at 5° C than at 20° C.

The GAOs virtually disappeared in the 5° C reactor. Modeling studies have shown that GAOs can predominate at higher temperatures because of their increased ability to uptake acetate at those temperatures compared to PAOs (Whang et al., 2007). Low temperatures can also lower phosphorus uptake but has been shown to not be an issue in well operated and properly acclimatized plants (WEF and ASCE, 2006).

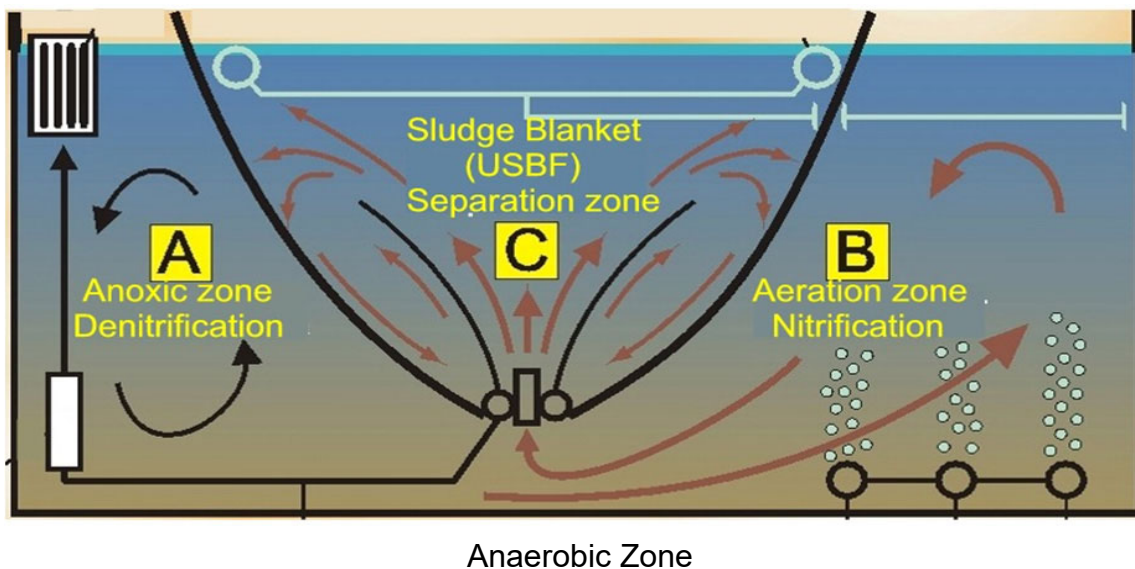

Presence of Oxygen or Nitrate in the Anaerobic Zone

If oxygen or nitrate is present in the anaerobic zone, organisms that use oxygen or nitrates as electron acceptors will preferentially grow by fully oxidizing the organics to CO₂ and H₂O, thereby reducing the VFAs available for polymerization and storage by the PAOs.

Nitrate can also inhibit fermentation of rbCOD because most of the fermenters are facultative and can use the nitrate as an electron acceptor to fully oxidize the rbCOD instead of producing VFAs as an end product of fermentation, thus depriving the PAOs of organics they can polymerize and store. Therefore, recycle of streams containing high DO and nitrate concentrations to the anaerobic zone should be avoided. Introduction of oxygen through pumps and other devices should also be avoided.

Avoiding Backmixing of Oxygen

Another potential source of oxygen and nitrates to the anaerobic zone is backmixing from downstream zones. In configurations where the anaerobic zone is followed immediately by an anoxic or aerobic zone, backmixing can cause elevated concentrations of nitrates and/or DO in the anaerobic zone leading to favoring of organisms other than PAOs. The problem can be avoided by increased baffling or changing the mixing rates. This problem is more likely to occur when the downstream zone is aerated, because aeration of mixed liquor increases the liquid depth, making the liquid level in the aerobic zone higher than in the non-aerated zone.

pH

Low pH can reduce and even prevent BPR. Below pH 6.9 the process has been shown to decline in efficiency (WEF and ASCE, 2006). This is possibly due to competition with GAOs. Filipe, et al. (2001), found that GAOs grow faster than PAOs at a pH of less than 7.25.

Because many wastewater processes such as chemical addition and nitrification can lower pH, this should be monitored and adjusted if necessary. It also has been shown that it is not possible to establish enhanced biological phosphorus removal (EBPR) when the pH is less than 5.5, even though an abundant amount of acetic acid is present in the anaerobic zone (Tracy and Flammino, 1987; Randall and Chapin, 1997).

Anaerobic Release

Secondary release of phosphorus occurs when the PAOs are under anaerobic conditions in the absence of a source of VFA. The energy stored as polyphosphate is used for cell maintenance and phosphorus is released to the liquid phase (Barnard, 1984). There will then be no stored food to supply energy for the uptake of phosphorus upon subsequent aeration.

This may occur in the following process stages:

- In the anaerobic zone if the retention time is too high and the VFA is depleted well within the required retention time.
- In the main anoxic zone when that runs out of nitrates.
- In the second anoxic zone if there are no nitrates to be removed.
- In the sludge blankets of final clarifiers when the RAS rate is too low and sludge is not removed fast enough.

Additionally, release may happen in aerobic zones that are too large, resulting in stored substrate depletion and destruction of PAO cells by endogenous metabolism.

Since there was no food storage associated with the phosphorus release, additional carbon is then required to take up the phosphorus released, but the amount in the influent may be insufficient.

Therefore, chemicals must be added to remove the excess phosphorus. Over-design of biological nutrient removal systems could thus lead to a higher demand for an external source of VFA.

Phosphorus will be released in sludge treatment processes that are anaerobic. Gravity thickening of BPR sludge can lead to phosphorus release if long retention times are used. Using mechanical dewatering instead of gravity dewatering allows less retention time and less phosphorus release (Bott et al., 2007).

It is usually recommended that dissolved air flotation (DAF) be used to thicken BPR sludge to reduce the amount of phosphorus release. DAF thickening can be quite successful for the reduction of release, but if the thickened sludge is left on the DAF beach too long before removal, excessive release will occur, just as it will when the sludge is left too long in a gravity thickener.

Anaerobic digestion will also lead to phosphorus release although some phosphorus will be precipitated as either a metal salt (e.g. calcium phosphate) or as struvite (magnesium ammonium phosphate, $MgNH_4PO_4$).

BPR sludge takes up and releases magnesium along with phosphates, and these two ions combine with ammonium, also present in abundance in anaerobic digesters, to form struvite.

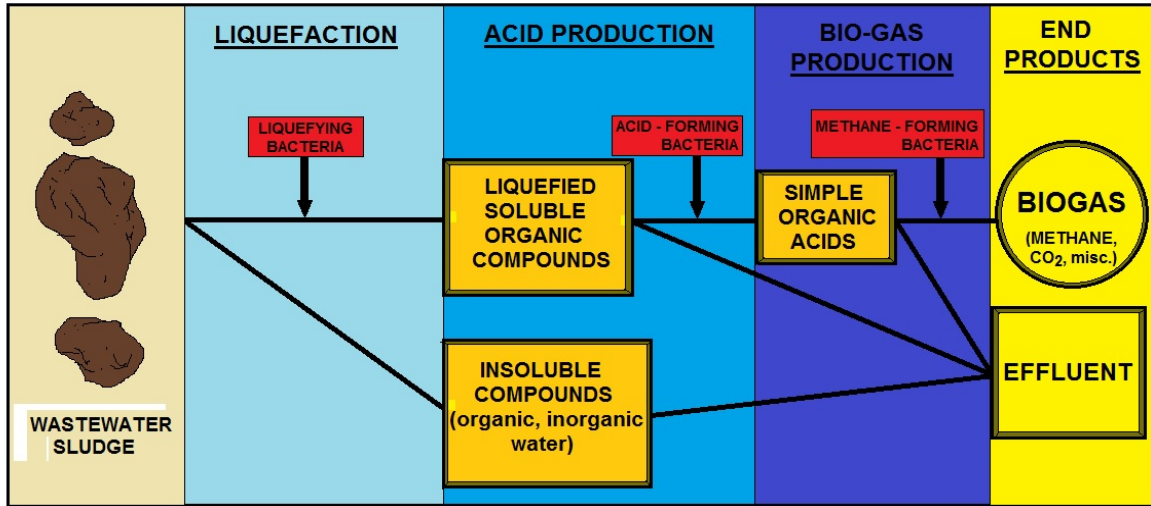

ANAEROBIC DIGESTION PROCESS DIAGRAM

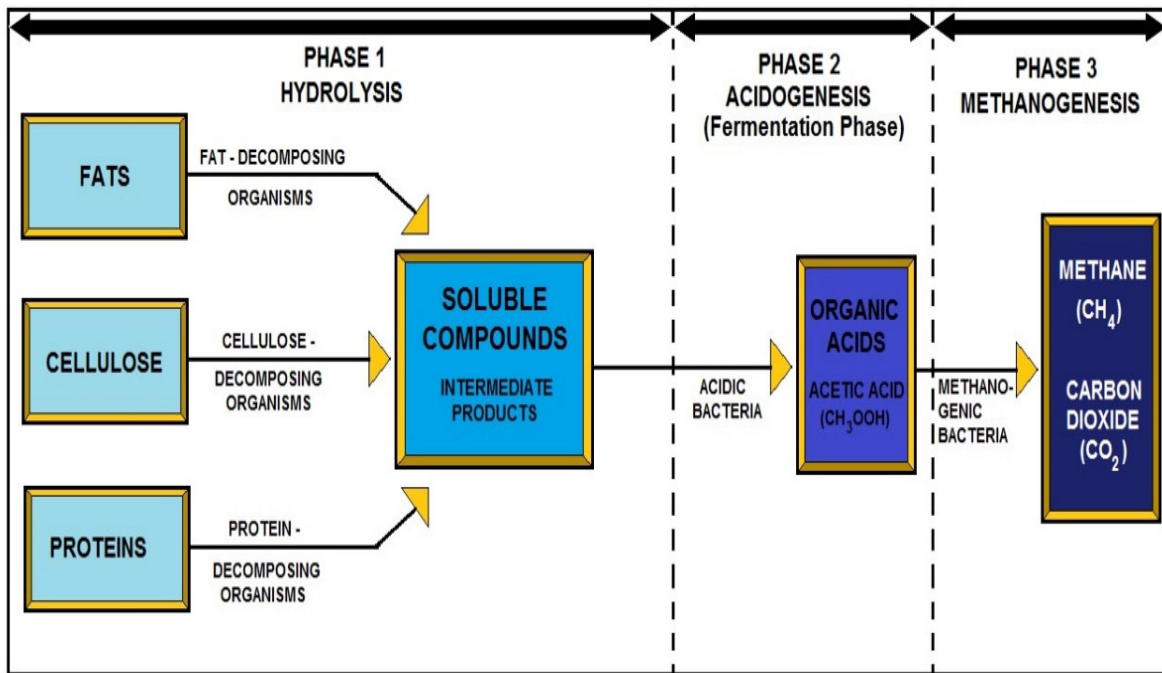

ANAEROBIC DECOMPOSITION DIAGRAM

Coagulation-Sedimentation Process

A process known as chemical coagulation-sedimentation may be used to increase the removal of solids from effluent after primary and conventional secondary treatment.

Solids heavier than water settle out of wastewater by gravity. With the addition of specific chemicals, solids can become heavier than water and will settle.

Alum, lime, or iron salts are chemicals added to the wastewater to remove phosphorus. With these chemicals, the smaller particles 'floc' or clump together into large masses.

The larger masses of particles will settle faster when the effluent reaches the sedimentation tank.



Jar Testing Apparatus

This process can reduce the concentration of phosphate by more than 95 percent.

Although used for years in the treatment of industrial wastes and in water treatment, coagulation-sedimentation is considered an advanced process because it is not routinely applied to the treatment of municipal wastewater. In some cases, the process is used as a necessary pretreatment step for other advanced techniques. This process produces a chemical sludge, and the cost of disposing of this material can be significant.

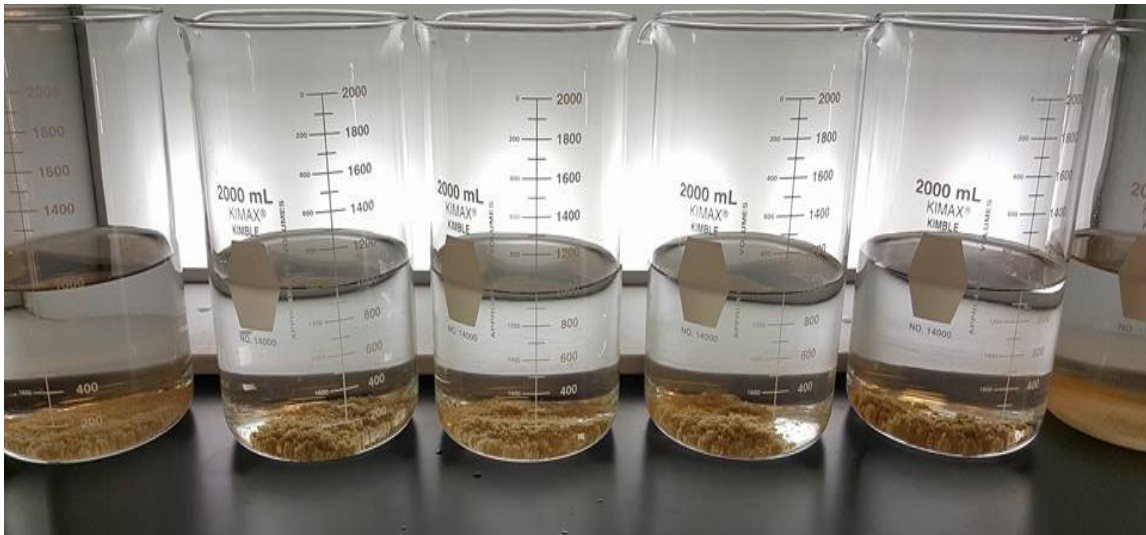

Well-formed coagulated floc results after settling.

Carbon Adsorption

Carbon adsorption technology can remove organic materials from wastewater that resist removal by biological treatment. These resistant, trace organic substances can contribute to taste and odor problems in water, taint fish flesh, and cause foaming and fish kills.

Carbon adsorption consists of passing the wastewater effluent through a bed or canister of activated carbon granules or powder which remove more than 98 percent of the trace organic substances. The substances adhere to the carbon surface and are removed from the water. To help reduce the cost of the procedure, the carbon granules can be cleaned by heating and used again.



Granular Carbon



Granular Activated Carbon (GAC) vessel

Nitrification and Nutrient Removal Sub-Section

NITRIFYING BACTERIA

Nitrifying bacteria are chemolithotrophic organisms that include species of the genera **Nitrosomonas**, **Nitrosococcus**, **Nitrobacter** and **Nitrococcus**. These bacteria get their energy by the oxidation of inorganic nitrogen compounds. Types include ammonia-oxidizing bacteria (AOB) and nitrite-oxidizing bacteria (NOB).



It was once thought that only two bacteria were involved in nitrification: *Nitrosomonas europaea*, which oxidizes ammonia to nitrite, and *Nitrobacter winogradskyi*, which oxidizes nitrite to nitrate. It is now known that at least 5 genera of bacteria oxidize ammonia and at least three genera of bacteria oxidize nitrite (Holt et al., 1994). Besides oxygen, these nitrifying bacteria require a neutral pH (7-8) and substantial alkalinity. The alkalinity is used by these autotrophs for CO_2 as a carbon source for growth.

Complete nitrification might be expected at pond pH values between pH 7.0 and 8.5. Nitrification ceases at pH values above pH 9 and declines markedly at pH values below 7. This results from the growth inhibition of the nitrifying bacteria. Nitrification, however, is not a major pathway for nitrogen removal in lagoons. Nitrifying bacteria exists in low numbers in lagoons. They prefer attached growth systems and/or high MLSS sludge systems.

Anaerobic Bacteria

Anaerobic, heterotrophic bacteria that commonly occur in lagoons are involved in methane formation (acid-forming and methane bacteria) and in sulfate reduction (sulfate reducing bacteria). Anaerobic methane formation involves three different groups of anaerobic bacteria that function together to convert organic materials to methane via a three-step process.

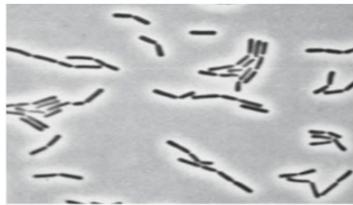

Lactobacillus sp.

One of the key bacteria used in digesters that release organic acids and enzymes that reduce organic matter.

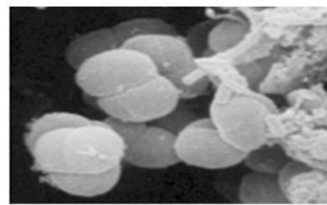

Methanosarcina sp.

This single cell organism is known for producing methane from carbon dioxide and hydrogen gas.



ANAEROBIC DIGESTER BUGS

General anaerobic degraders - many genera of anaerobic bacteria hydrolyze proteins, fats, and polysaccharides present in wastewater to amino acids, short-chain peptides, fatty acids, glycerol, and mono- and di-saccharides. These mostly have a wide environmental tolerance in pH and temperature.

Photosynthetic Organisms

Acid-Forming Bacteria

This highly diverse group of bacteria converts products under anaerobic conditions to simple alcohols and organic acids such as acetic, propionic, and butyric. These bacteria are hardy and occur over a wide pH and temperature range.

Methane Forming Bacteria

These bacteria convert formic acid, methanol, methylamine, and acetic acid under anaerobic conditions to methane. Methane is derived in part from these compounds and in part from CO₂ reduction. Methane bacteria are environmentally sensitive and have a narrow pH range of 6.5-7.5 and require temperatures > 14° C.

Note that the products of the acid formers (principally acetic acid) become the substrate for the methane producers.

A problem exists at times where the acid formers overproduce organic acids, lowering the pH below where the methane bacteria can function (a pH < 6.5). This can stop methane formation and lead to a buildup of sludge with a low pH. In an anaerobic fermenter, this is called a "stuck digester". In addition, methane fermentation ceases at cold temperature, probably not occurring in most lagoons in the wintertime in cold climates. A number of anaerobic bacteria (14 genera reported to date (Bolt et al., 1994)) called sulfate reducing bacteria can use sulfate as an electron acceptor, reducing sulfate to hydrogen sulfide. This occurs when BOD and sulfate are present and oxygen is absent. Sulfate reduction is a major cause of odors in ponds.

Photosynthetic Bacteria

Anaerobic, photosynthetic bacteria occur in all lagoons and are the predominant photosynthetic organisms. In anaerobic lagoons, the anaerobic sulfur bacteria are generally grouped into the red and green sulfur bacteria. They are represented by about 28 genera (Ehrlich, 1990), and oxidize reduced sulfur compounds (H₂S) using light energy to produce sulfur and sulfate.

In this process, H₂S is used in place of H₂O, as used by algae and green plants, producing SO₄⁻ instead of O₂. All are either strict anaerobes or microaerophilic. Most common are Chromatium, Thiocystis, and Thiopedia, which can grow in profusion and give a lagoon a pink or red color.

Finding them in an intended aerobic system is most often an indication of organic overloading and anaerobic conditions. Conversion of odorous sulfides to sulfur and sulfate by these sulfur bacteria is a significant odor control mechanism in facultative and anaerobic lagoons, and can be desirable.

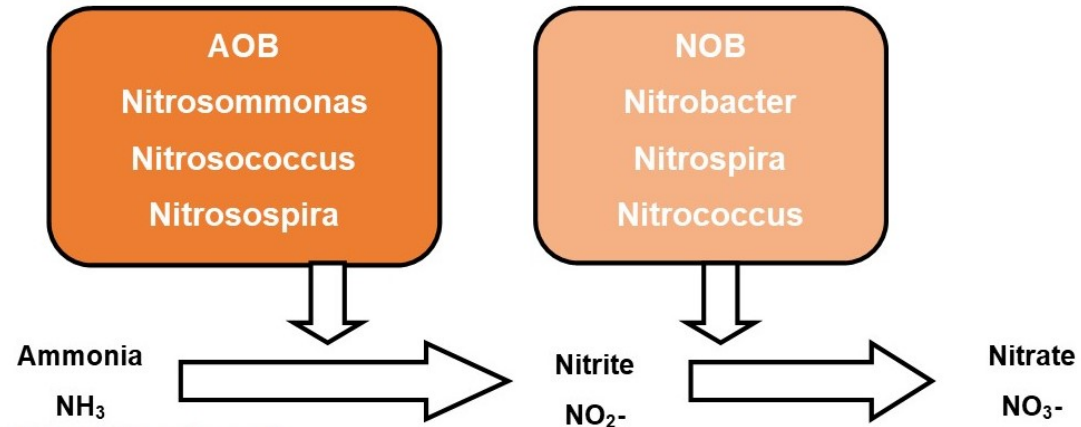

NITRIFICATION BUG SEQUENCE DIAGRAM

Nitrification is the sequential conversion of ammonia to nitrite and ultimately nitrate:

Ammonia → Nitrite → Nitrate

- $\text{NH}_4^+ + 1.5\text{O}_2 \rightarrow \text{NO}_2^- + \text{H}_2\text{O} + 2\text{H}^+$
- $\text{NO}_2^- + 0.5\text{O}_2 \rightarrow \text{NO}_3^-$

The overall reaction is as follows:

- $\text{NH}_4^+ + 2\text{O}_2 \rightarrow \text{NO}_3^- + 2\text{H}^+ + \text{H}_2\text{O}$

Ammonia in wastewater could originate from a variety of sources, including:

- Proteins (meat and blood), urea, amino acid products, casein, corrosion inhibitors, process chemicals and raw materials or cleaning chemicals containing quaternary (NH₄⁺) ammonium compounds.

In an activated sludge system or other biological treatment system, nitrification occurs under aerobic conditions.

- Nitrification is a bio-chemical reaction that occurs inside bacteria.
- Two species of bacteria are primarily involved in the process – Nitrosomonas and Nitrobacter.
- These bacteria are collectively known as nitrifiers and are autotrophic, i.e. they get their carbon source from inorganic carbon (carbonates, bicarbonates) or carbon dioxide.

In a nitrifying activated sludge process, only 3-10% of bacteria is autotrophic (nitrifiers).

- Nitrifiers possess cytomembranes, which are extensions of the cell membrane away from the cell wall and toward the cytoplasm.
- These are the active sites for oxidation of ammonium and nitrite ions.
- It is on the cytomembranes of Nitrosomonas and Nitrobacter, where ammonium ions and nitrite ions, respectively, come in contact with enzymes that add oxygen to each ion.

A healthy and stable population of nitrifiers (Nitrosomonas and Nitrobacter) will not exist without the following conditions:

- **Oxygen:** Nitrifiers are obligate aerobes, i.e. they require free molecular oxygen and are killed off by extended anaerobic conditions. Maximum nitrification occurs at a D.O. (Dissolved Oxygen) level of 3.0 mg/l. Significant nitrification occurs at a D.O. level of 2.0 to 2.9 mg/l. Nitrification ceases at D.O. levels of <0.5 mg/l. Approximately 4.6 kg of oxygen are required for every kg of ammonium ions oxidized to nitrate (This compares with a requirement of 1 kg of oxygen to oxidize 1 kg of carbonaceous B.O.D.). An absence of oxygen for <4 hours does not adversely affect nitrifiers when oxygen is restored. To ensure effective nitrification always maintain a D.O. level of ≥ 1.5 mg/l.
- **Temperature:** Nitrification is temperature sensitive. The optimum temperature for nitrification is generally considered to be 86° F (30°C).

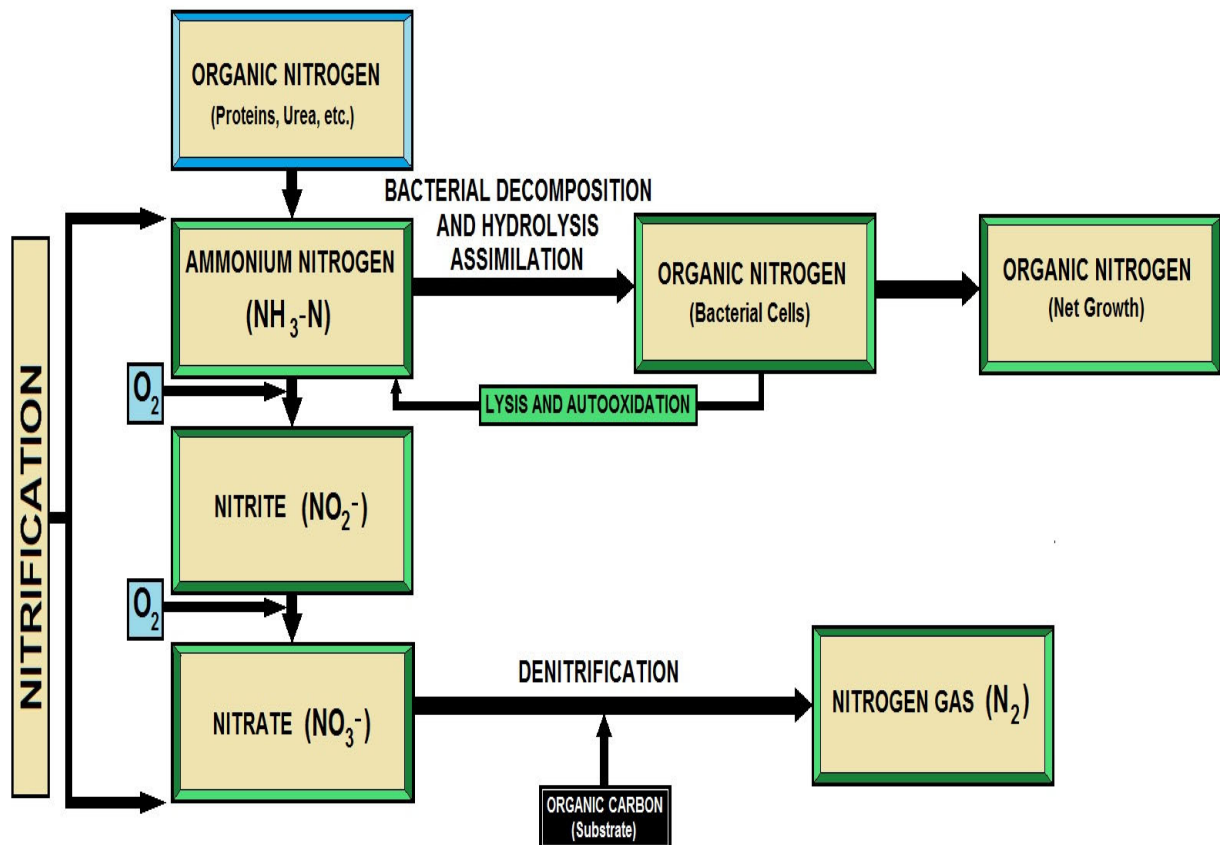

Key Nitrification Relationships

Parameter	Relationship
Oxygen Usage	4.57 mg O ₂ per mg NH ₃ -N converted to NO ₃ -N
Alkalinity Consumption	7.14 mg alkalinity as CaCO ₃ per mg NH ₃ -N converted to NO ₃ -N
Biomass Produced	0.10 mg new cells per mg NH ₃ -N converted to NO ₃ -N

Nitrification

Nitrification is the biological process by which ammonia is first converted to nitrite and then to nitrate. Nitrification can be achieved in any aerobic-biological process at low organic loadings and where suitable environmental conditions are provided.

Nitrifying bacteria are slower growing than the heterotrophic bacteria, which comprises the greater proportion of the biomass in both fixed film and suspended growth systems. The key requirement for nitrification to occur, therefore, is that the process should be so controlled that the net rate of accumulation of biomass, and hence, the net rate of withdrawal of biomass from the system, is less than the growth rate of the nitrifying bacteria (Barnes and Bliss, 1983). The processes currently used in the treatment of wastewater for nitrification are presented as follows.

Two-Step Process of Nitrification

The AOBs convert ammonia (NH₃) to nitrite (NO₂⁻) and the NOBs convert nitrite (NO₂⁻) to nitrate (NO₃⁻). The process consumes 4.57 mg O₂ and 7.14 mg alkalinity for every 1 mg NH₃-N converted to NO₃-N. The AOBs and NOBs grow slower than other microorganisms.

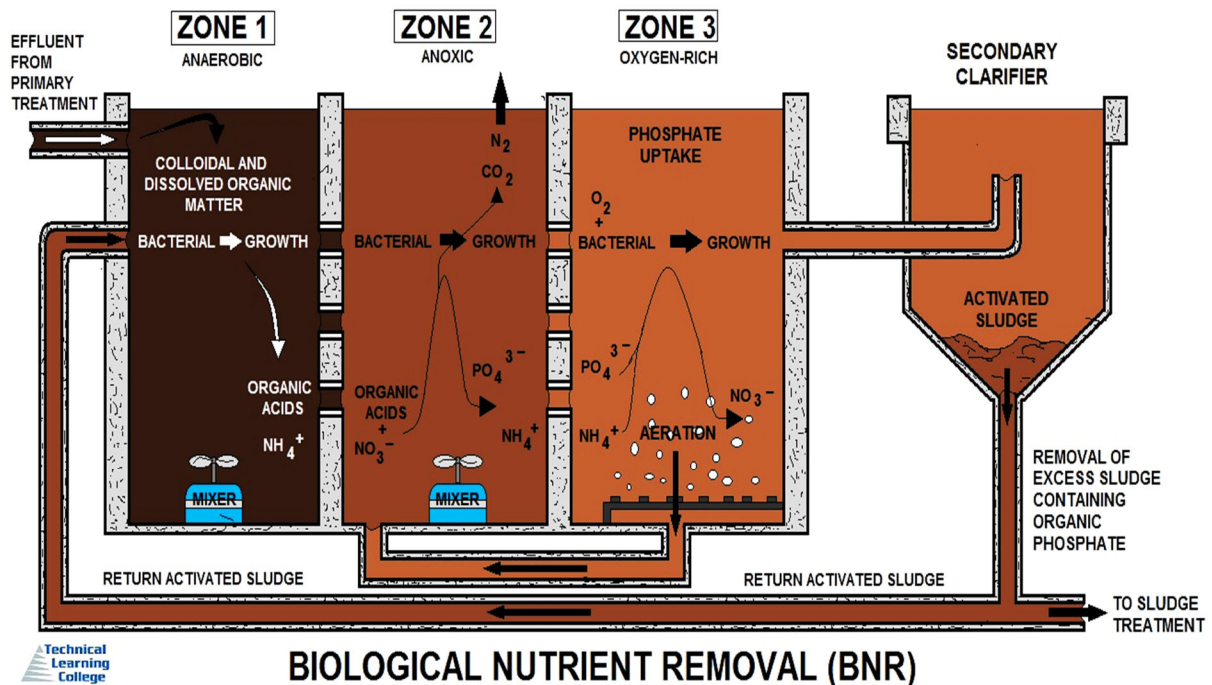

1. Trickling Filters

The extent of nitrification in trickling filters depended on a variety of factors; including temperature, dissolved oxygen, pH, presence of inhibitors, filter depth and media type, loading rate, and wastewater BOD (Parker and Richards, 1986). Low-rate trickling filters allows the development of a high-nitrifying population. For rock media filters, organic loading should not exceed 0.16 kg BOD₅/m³/day (USEPA, 1975). Higher loading rates (0.36 kg BOD₅/m³/day) were allowable in plastic media trickling filters because of the higher surface area of the plastic media (Stenquist, et al., 1974). If two filters are used in series, heterotrophic growth occurs in the first filter and nitrification in the second filter (Bitton, 1994). Boller and Gujer (1986) conducted a pilot plant study of tertiary trickling filters, recommending a media surface loading rate of 0.4 g NH₃-N/m²/day for complete nitrification (effluent NH₃-N < 2.0 mg/L) at a water temperature of 10° C.

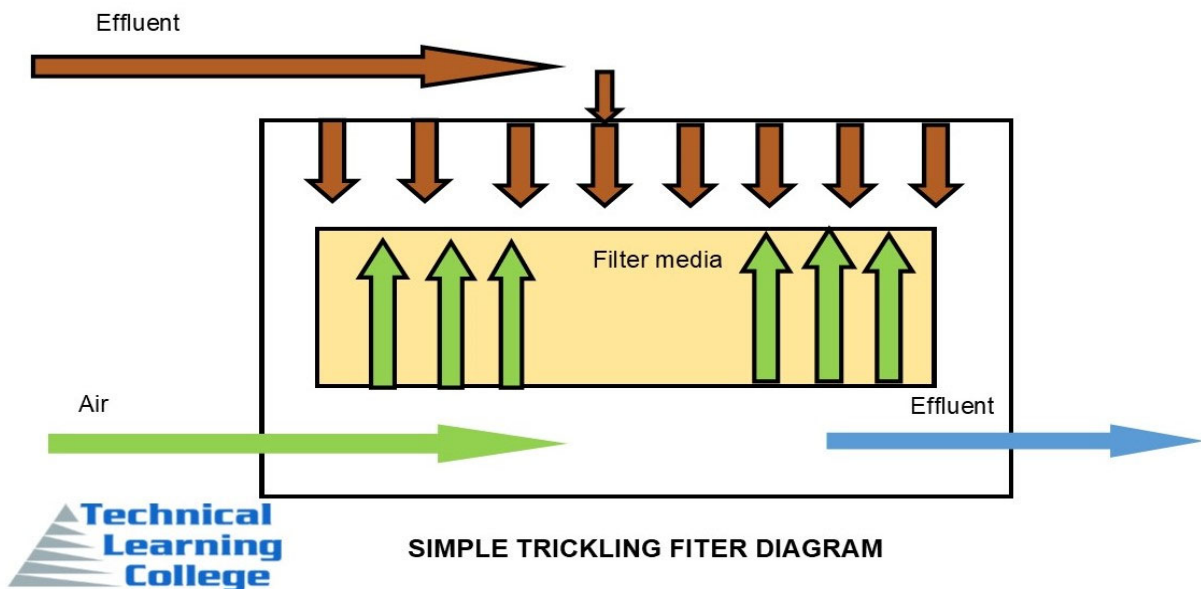

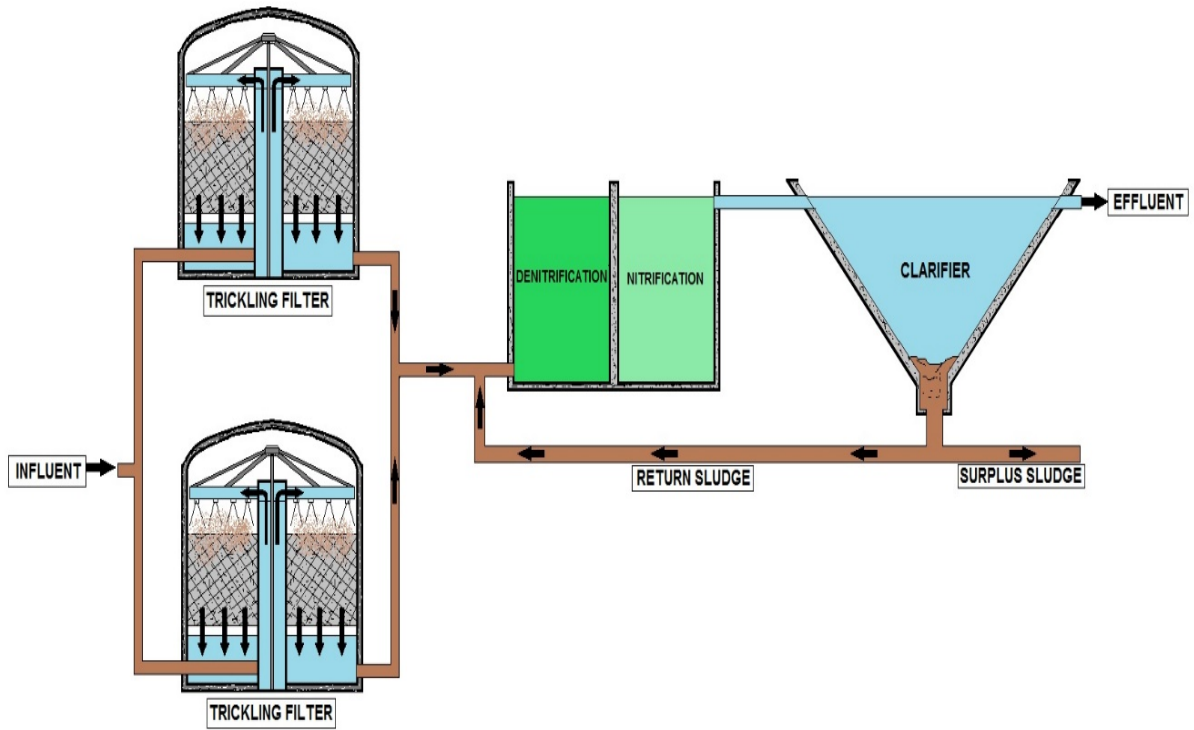

SINGLE-STAGE TRICKLING FILTERS IN PARALLEL

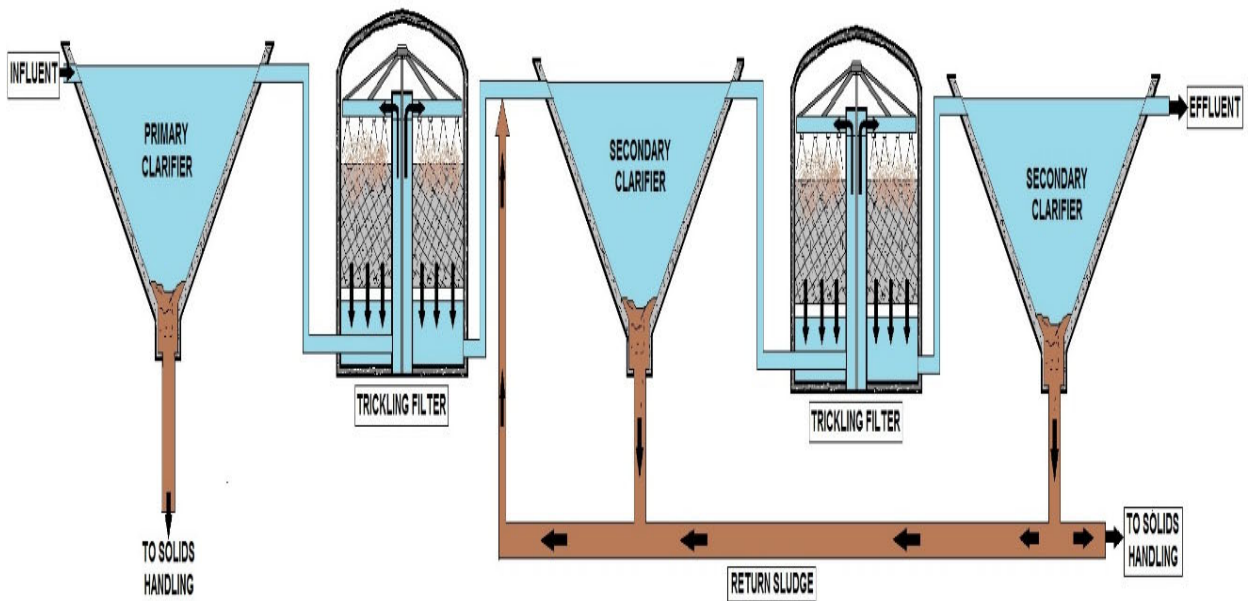

DOUBLE STAGE TRICKLING FILTER

2. Rotating Biological Contactor

RBC biofilm has an initial adsorption of microorganisms to the disk surface to form a 1-4 mm thick biofilm that is responsible for BOD removal in rotating biological contactors. The rotating disks provided a large surface area for the attached biomass. The first stages of an RBC mostly removes organic materials, whereas subsequent stages remove $\text{NH}_3\text{-N}$ as a result of nitrification, when the BOD_5 is low enough.

Ammonia oxidizers cannot effectively compete with the faster-growing heterotrophs that oxidize organic matter.

Nitrification occurs only when the BOD is reduced to approximately 14 mg/L, and increases with rotation speed (Weng and Molof, 1974). RBC performance is negatively affected by low dissolved oxygen in the first stages and by low pH in the later stages where nitrification occurred (Hittlebaugh and Miller, 1981).



An RBC with one section removed.

An innovative operational process using recirculation in RBC was developed and used to improve nitrification (Klees and Silverstein, 1992). They found that it could improve nitrification at all hydraulic loading rates; the positive effect of recirculation on nitrification was due to the dilution of influent organic carbon.

Degradable organic carbon inhibits nitrification at concentrations greater than 15-20 mg/L BOD₅; extremely low concentrations of influent BOD₅ (less than 10 mg/L) did not improve nitrification.

3. BioFilm Fluidized Reactor

Dunn, et al. (1984), investigated the nitrification process with a biofilm fluidized reactor. The bed was designed cone-shaped and filled with 0.2-0.3 mm diameter quartz sand.

With three years of operation under a loading rate of 5.2 l/hr, recycle rate of 84 l/hr and NH₄-N concentration of 45 mg/L, the maximum nitrification rate was observed as 134 mg N/g MLSS/hr for Nitrosomonas, and 120 mg N/MLSS/hr for Nitrobacter. Optimum pH value was found to be around 7.8; optimum temperature was found between 30-40° C.

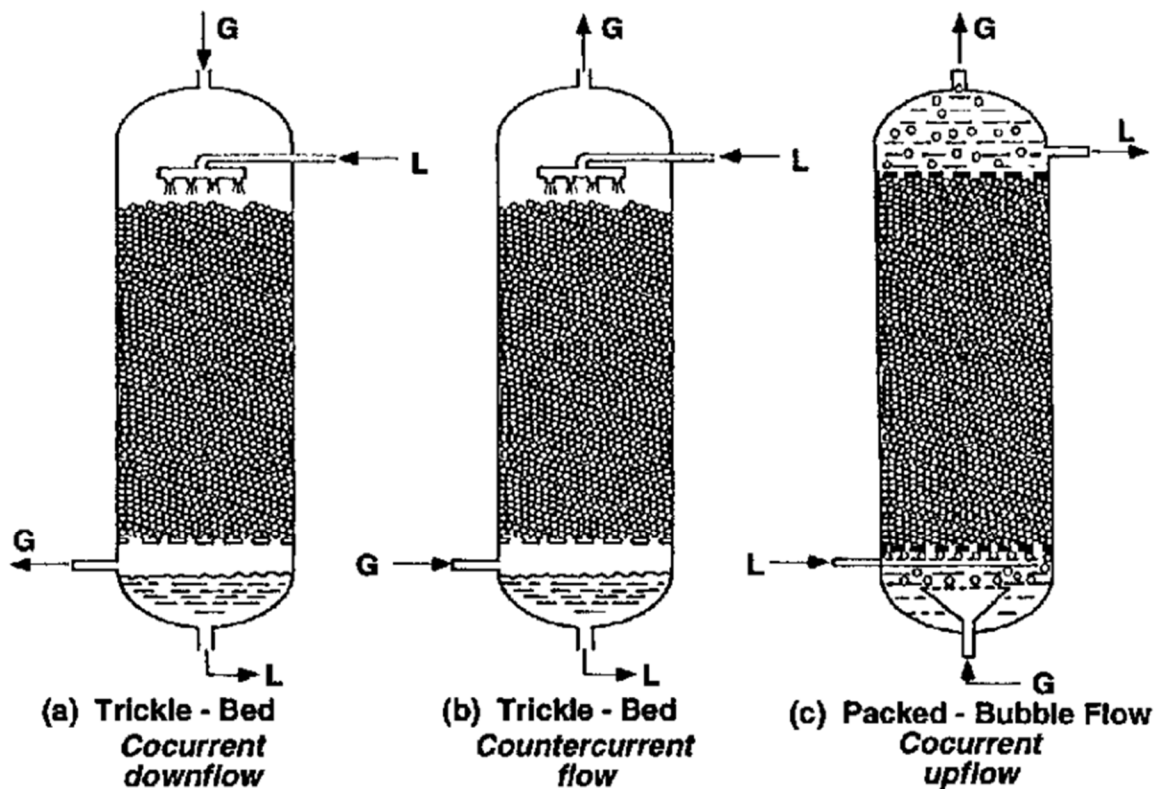

4. Fixed Bed Reactor

Jimenez, et al. (1987), conducted a pilot scale research by using a fixed bed reactor for nitrification of the effluent from an extended aeration sewage treatment plant. The non-settled sewage influent of COD of 373 mg/L, NH₄-N of 45 mg/L, SS of 297 mg/L and pH 8.1 were used in this study. With an HRT of 4 to 6 hours and recycle ratio of 3.5, removal efficiencies of 70% of COD, 67% of SS and 95% of NH₄-N were obtained.

Less than 10 mg/L effluent BOD and ammonia removal efficiency of 65-85% were achieved in a four-stage aerobic submerged biofilm reactor containing ball-rings (Gonzalez-Martinez and Duqu-Luciano, 1992). Nitrification was achieved in all 4 reactors operated at the loading rate of 6-21 g/m²/d and the HRTs of 130-290 minutes.

5. Conventional Activated Sludge Processes at Low Loadings

Weismann (1994) studied the nitrification in a conventional activated sludge system and found that it was relatively low for carbon removal and nitrification of sewage because carbon removal and nitrification occurred in the same reactor with an activated sludge system. This resulted in a population mixture of mainly heterotrophs and few autotrophs. In this kind of treatment system, it was not possible to enrich the autotrophic bacteria because the slower growing autotrophs were removed with the surplus sludge. It was necessary to separate the autotrophic from the heterotrophic biomass in order to increase the specific nitrification rate.

Suwa, et al. (1989), conducted a research on simultaneous organic carbon removal-nitrification by an activated sludge process with cross-flow filtration. Because of the recycle of sludges with cross-flow filtration, this process made the sludge retention time very long; simultaneous carbon removal-nitrification was achieved quite well under the loading rate of about 0.10 g BOD/g VSS/d. The efficiency of dissolved organic carbon removal was more than 95%, and nitrification was sufficient ($\text{NH}_3\text{-N}$ was not detected in the effluent).

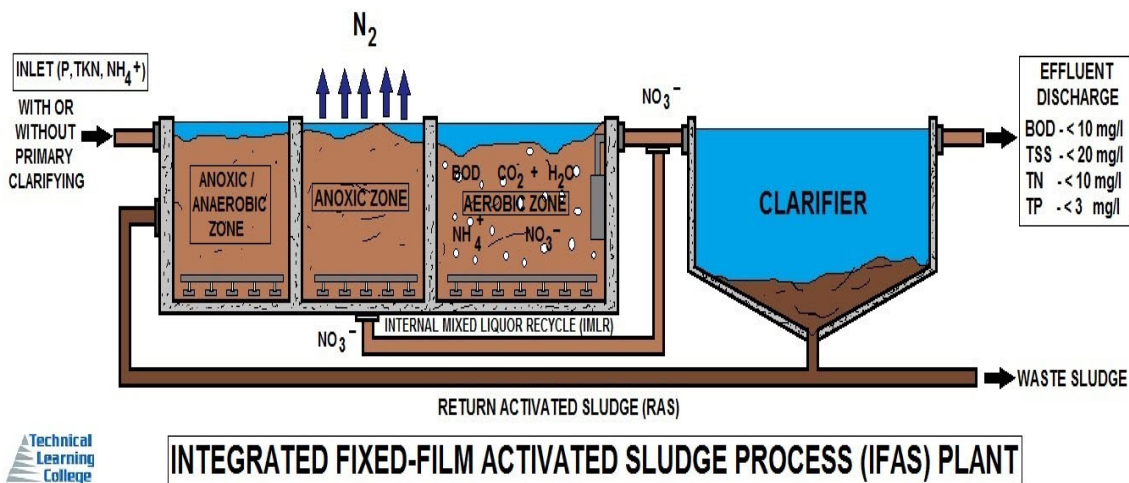
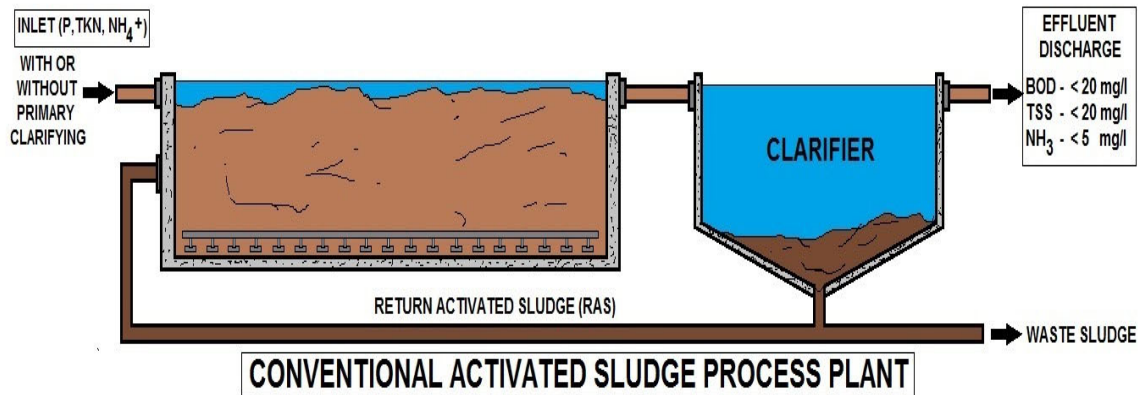

6. Two-stage activated sludge systems with separate carbonaceous oxidation and nitrification systems

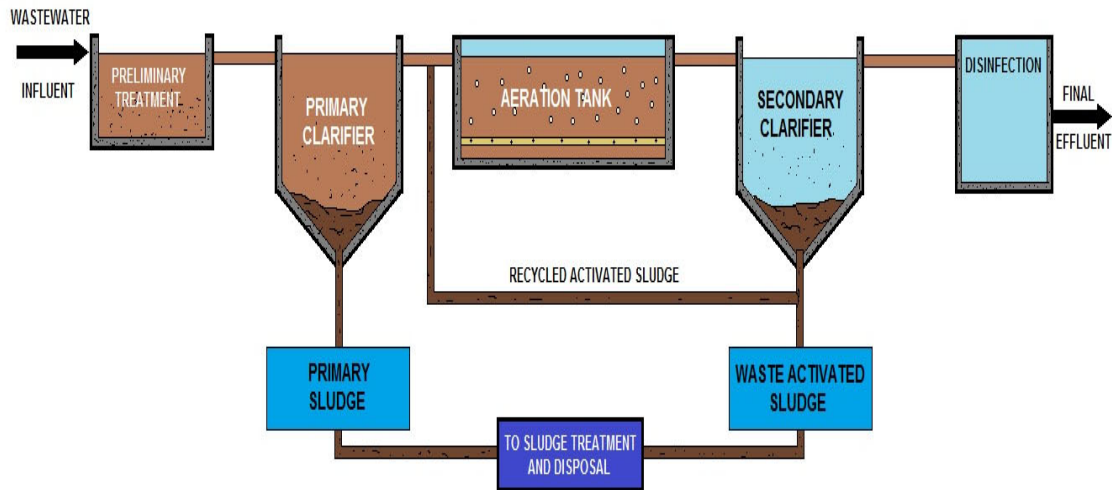

ACTIVATED SLUDGE WASTEWATER TREATMENT FLOW DIAGRAM

The nitrification process requires a slow-growing nitrifying bacteria with sludge that has been aged for a long time and high dissolved oxygen concentration. In addition, they were susceptible to inhibition by a wide range of compounds at concentrations so low as not to affect the heterotrophic bacteria. For these reasons, it would seem sensible to separate the processes of carbonaceous removal and nitrogen removal into separate reactors (Horan, 1989).

Rimer and Woodward (1972) investigated separate carbonaceous oxidation and nitrification systems and found that this process minimized sludge washout with the nitrification stage, and the process could be operated successfully at a shorter detention time, lower MLSS and solid retention time.

Sequencing Batch Reactor (SBR) Sub-Section

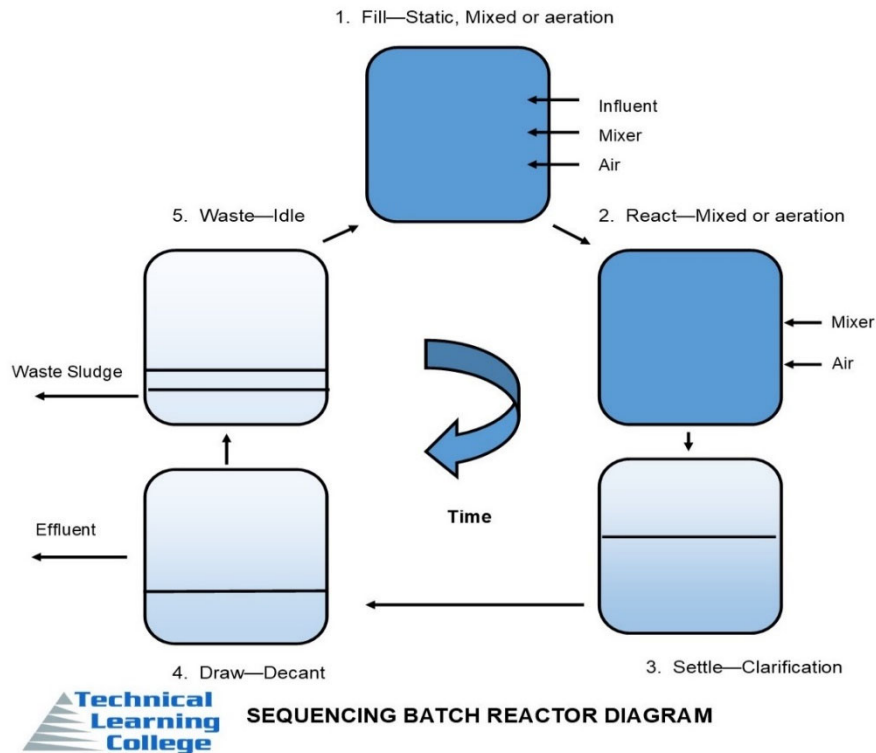

The SBR process is a sequential suspended growth (activated sludge) process in which all major steps occur in the same tank in sequential order (USEPA, 2008d). The SBR system is typically found in packaged configurations for onsite and small community or cluster applications. The major components of the package include the batch tanks, aerator, mixer, decanter device, process control system (including timers), pumps, piping, and appurtenances.

Aeration may be provided by diffused air or mechanical devices. SBRs are often sized to enable mechanical mixing and are operated by the process control timers. Mechanical aerators have the added value of potential operation as mixers or aerators.

The decanter is a critical element in the process. Several decanter configurations are available, including fixed and floating units. At least one commercial package employs a thermal processing step for the excess sludge produced and wasted during the “idle” step. The key to the SBR process is the control system, which consists of a combination of level sensors, timers, and microprocessors which can be configured to meet the needs of the system.

SBRs can be designed and operated to enhance removal of nitrogen, phosphorus, and ammonia, in addition to removing TSS and BOD. Package plant SBRs are suitable for areas with little land, stringent treatment requirements, and small wastewater flows such as RV parks or mobile homes, campgrounds, construction sites, rural schools, hotels, and other small applications. These systems are also useful for treating pharmaceutical, brewery, dairy, pulp and paper, and chemical wastes (USEPA, 2000d).

Intermittent Sand Filters (ISF)

ISF is used to describe a variety of packed-bed filters of sand or other granular materials available on the market (USEPA, 2008g). Sand filters provide advanced secondary treatment of settled wastewater or septic tank effluent. They consist of a lined (e.g., impervious PVC liner on sand bedding) excavation or structure filled with uniform washed sand that is placed over an underdrain system. The wastewater is directed onto the surface of the sand through a distribution network and allowed to percolate through the sand to the underdrain system. The underdrain system collects the filter effluent for further processing or discharge.

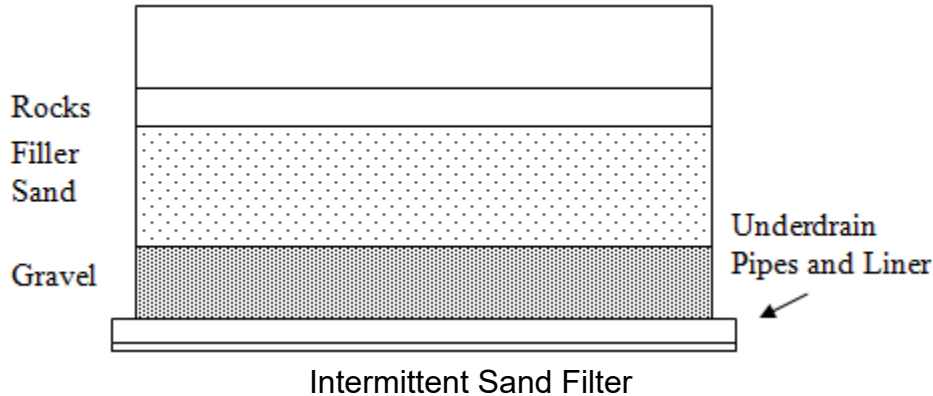

ISFs are aerobic, fixed-film bioreactors. Bioslimes from the growth of microorganisms develop as films on the sand particle surfaces. The microorganisms in the slimes capture soluble and colloidal waste materials in the wastewater as it percolates through the sand surfaces. The captured materials are metabolized into new cell mass or degraded under aerobic conditions to carbon dioxide and water.

Most biochemical treatment occurs within approximately 6 inches of the filter surface. Other treatment mechanisms that occur in sand filters include physical processes, such as straining and sedimentation, to remove suspended solids within the pores of the media. Most suspended solids are strained out at the filter surface.

Chemical adsorption can occur throughout the media bed. Adsorption sites in the media are usually limited. The capacity of the media to retain ions depends on the target constituent, the pH, and the mineralogy of the media. Phosphorous is one element of concern in wastewater that can be removed in this manner, but the number of available adsorption sites is limited by the characteristics of the media.

Sand filters can be used for a broad range of applications, including single-family residences, large commercial establishments, and small communities. Sand filters are frequently used to pretreat septic tank effluent prior to subsurface infiltration onsite where the soil has insufficient unsaturated depth above ground water or bedrock to achieve adequate treatment.

They are also used to meet water quality requirements (with the possible exception of fecal coliform removal) before direct discharge to surface water. Sand filters are used primarily to treat domestic wastewater, but they have been used successfully in treatment

trains to treat wastewaters high in organic materials such as those from restaurants and supermarkets.

Single-pass ISF filters are most frequently used for smaller applications and sites where nitrogen removal is not required. However, they can be combined with anoxic processes to significantly increase nitrogen removal.

Recirculating Sand Filters (RSF)

Recirculating filters using sand, gravel, or other media provide advanced secondary treatment of settled wastewater or septic tank effluent (USEPA, 2008h). They consist of a lined (e.g., impervious PVC liner on sand bedding) excavation or structure filled with uniform washed sand that is placed over an underdrain system.

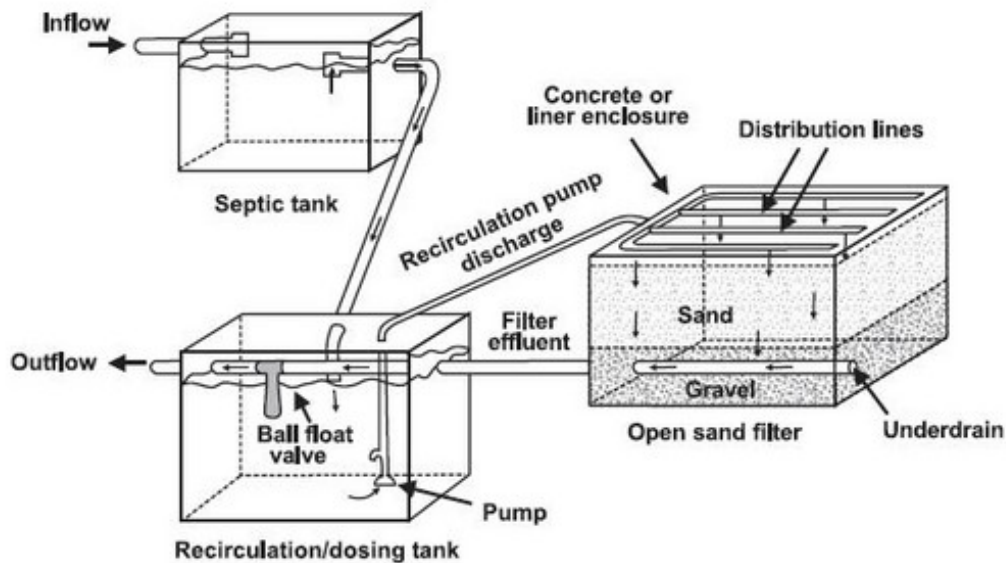

Recirculating Sand Filters

The wastewater is directed onto the surface of the sand through a distribution network and allowed to percolate through the sand to the underdrain system. The underdrain system collects and recycles the filter effluent to the recirculation tank for further processing or discharge. The basic components of recirculating filters include a recirculation/dosing tank, pump and controls, distribution network, filter bed with an underdrain system, and a return line.

The return line or the underdrain must split the flow to recycle a portion of the filtrate to the recirculation/dosing tank. A small volume of wastewater and filtrate is dosed to the filter surface on a timed cycle of 1 to 3 times per hour.

Recirculation ratios are typically between 3:1 and 5:1. In the recirculation tank, the returned aerobic filtrate mixes with the anaerobic septic tank effluent before being reapplied to the filter. RSFs can be used for a broad range of applications, including single-family residences, large commercial establishments, and small communities. They produce a high quality effluent with approximately 85 to 95 percent BOD and TSS removal. In addition, almost complete nitrification is achieved.

Natural Systems

The natural systems described here include constructed wetlands and floating aquatic plant treatment systems. Wetland systems are typically described in terms of the position of the water surface and/or the type of vegetation grown.

Most natural wetlands are free water surface (FWS) systems where the water surface is exposed to the atmosphere; these include bogs (primary vegetation mosses), swamps (primary vegetation trees), and marshes (primary vegetation grasses and emergent macrophytes) (USEPA, 2000e). Subsurface flow (SF) wetlands are specifically designed to treat or polish wastewater and are typically constructed as a bed or channel containing appropriate media.

Constructed wetlands treat wastewater by bacterial decomposition, settling, and filtering. As in tank designs, bacteria break down organic matter in the wastewater, aerobically, anoxically and anaerobically. Oxygen for aerobic decomposition is supplied by the plants growing in the wetland.

Solids are filtered and finally settle out of the wastewater within the wetland. After about two weeks of flow-through detention time in the wetland, effluent is usually discharged by gravity to an unlined wetland bed. If these systems discharge effluent to surface ditches, they require a NPDES permit.

The submerged plant roots do provide substrate for microbial processes. However, the amount of oxygen that emergent macrophytes can transmit from the leaves to their roots is negligible compared to the oxygen demand of wastewater. Therefore, subsurface flow wetlands are devoid of oxygen. The lack of oxygen in these subsurface flow systems means that ammonia oxidation via biological nitrification will not occur without the use of an additional unit process, such as a gravel trickling filter for nitrification of the wastewater ammonia.

Vertical flow wetland beds are a modification of subsurface flow wetlands which contain gravel or coarse sand and are loaded intermittently at the top surface. Unlike ammonia oxidation, nitrate removal in a subsurface flow wetland can be rapid and effective because the anoxic conditions and carbon sources necessary to support the treatment reactions occur naturally in these systems.

FWS wetlands with long detention times can remove minor amounts of phosphorus through plant uptake, adsorption, complexation, and precipitation.

Duckweeds have been used for a number of years to treat wastewater for various purposes. High levels of BOD and TSS removal have been observed from duckweed systems. To achieve secondary treatment most duckweed systems are coupled with either facultative or aerated ponds. Nitrogen is removed by plant uptake and harvesting, by denitrification. A disadvantage of duckweed systems is the large amount of biomass produced by the rapidly growing plants, which creates a solids handling requirement.

Bacteriological Nitrification

NOB of the genus *Nitrospira* are the key nitrite oxidizers in wastewater treatment plants and are widely distributed in nature, but most *Nitrospira* are still uncultured.

Nitrification is a process of nitrogen compound oxidation (effectively, loss of electrons from the nitrogen atom to the oxygen atoms):

1. $2 \text{NH}_3 + 3 \text{O}_2 \rightarrow 2 \text{NO}_2^- + 2 \text{H}_2\text{O} + 2 \text{H}^+$ (Nitrosomonas)
2. $2 \text{NO}_2^- + 1 \text{O}_2 \rightarrow 2 \text{NO}_3^-$ (Nitrobacter, Nitrospina)
3. $\text{NH}_3 + \text{O}_2 \rightarrow \text{NO}_2^- + 3\text{H}^+ + 2\text{e}^-$
4. $\text{NO}_2^- + \text{H}_2\text{O} \rightarrow \text{NO}_3^- + 2\text{H}^+ + 2\text{e}^-$

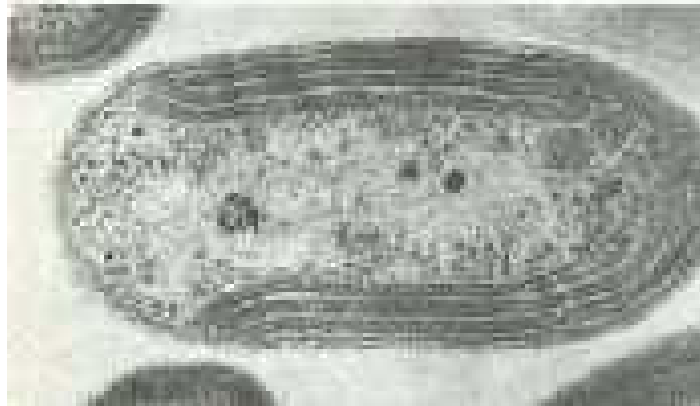

Nitrobacter winogradskyi

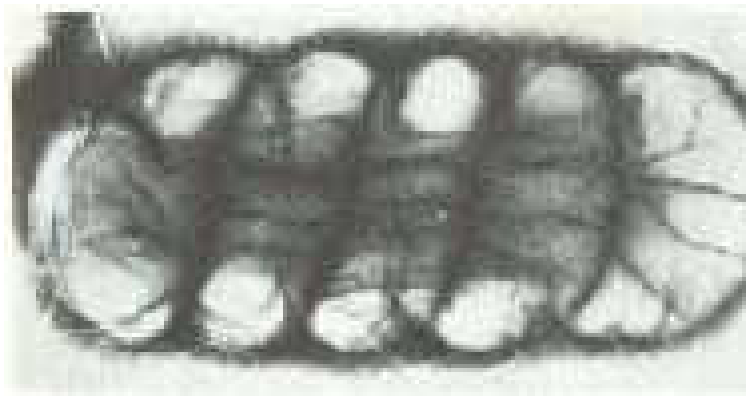

Nitrospira gracilis

DENITRIFICATION PROCESS

Denitrification is the reduction of nitrates back into nitrogen gas (N_2), completing the nitrogen cycle. This process is performed by bacterial species such as **Pseudomonas** and **Clostridium** in anaerobic conditions. They use the nitrate as an electron acceptor in the place of oxygen during respiration. These facultative anaerobic bacteria can also live in aerobic conditions.

Denitrification happens in anaerobic conditions e.g. waterlogged soils. The denitrifying bacteria use nitrates in the soil to carry out respiration and consequently produce nitrogen gas, which is inert and unavailable to plants.



When sludge denitrifies, it will rise to the top of the Settleometer.

Nitrogen Constituents and Measurement Methods

This section provides an overview of the sources, forms, and measurement methods for nitrogen in wastewater.

NITROGEN

Nitrogen is an important nutrient for plant and animal growth. Atmospheric nitrogen is less biologically available than dissolved nitrogen in the form of ammonia and nitrates. Availability of dissolved nitrogen may contribute to algal blooms.

Ammonia and organic forms of nitrogen are often measured as **Total Kjeldahl Nitrogen (TKN)**, and analysis for inorganic forms of nitrogen may be performed for more accurate estimates of total nitrogen content.



Nitrogen components in wastewater are typically reported on an “as nitrogen” basis so that the total nitrogen concentration can be accounted for as the influent nitrogen components are converted to other nitrogen compounds in wastewater treatment.

WWTPs designed for nitrification and denitrification can remove 80 to 95 percent of inorganic nitrogen, but the removal of organic nitrogen is typically much less efficient (Pehlivanoglu-Mantas and Sedlak, 2006). Domestic wastewater organic nitrogen may be present in particulate, colloidal or dissolved forms and consist of proteins, amino acids, aliphatic N compounds, refractory natural compounds in drinking water (e.g. Humic substances), or synthetic compounds (e.g. ethylene Diamine tetraacetic acid (EDTA)).

Some nitrogen may be contained in recondensation products. Hydrolysis of particulate and colloidal material by microorganisms releases some organic nitrogen as dissolved, biodegradable compounds.

Amino acids are readily degraded during secondary biological treatment, with 90 to 98 percent removal in activated sludge systems and 76 to 96 percent removal in trickling filters. However, other forms of organic nitrogen may be more persistent in wastewater treatment processes. Organic nitrogen may be released in secondary treatment by microorganisms either through metabolism or upon death and lysis.

The importance of organic nitrogen has increased as effluent limits on nitrogen have become more stringent. With more impaired waterways from nutrient loads, effluent limits for total nitrogen (TN) concentrations of 3.0 mg/L or less are becoming more common.

The dissolved organic nitrogen (DON) concentration in the effluent from biological nutrient removal treatment facilities was found to range from 0.50 to 1.50 mg/L in 80 percent of 188 plants reported by Pagilla (STAC-WERF, 2007) and values as high as 2.5 mg/L were observed.

Thus, for systems without effluent filtration or membrane bioreactors (MBRs) that are trying to meet a TN treatment goal of 3.0 mg/L, the effluent DON contribution can easily be 20 to 50 percent of the total effluent nitrogen concentration, compared to only about 10 percent for conventional treatment (Pehlivanoglu-Mantas and Sedlak, 2004).

The chemical composition of DON in wastewater effluents is not completely understood. Sedlak (2007) has suggested that only about 20 percent of the DON has been identified as free and combined amino acids, EDTA, and other trace nitrogen compounds.

About 45 percent may be unidentified low molecular weight compounds and the other 35 percent as unidentified high molecular weight compounds containing Humic acids and amides. Similar results were found by Khan (2007). Early work by Parkin and McCarty (1981) suggested that 40 to 60 percent of effluent DON is non-bioavailable. The non-bioavailable portion is also referred to as recalcitrant DON (rDON).

NUTRIENT TESTING CONCEPT (TKN)

Nutrients are substances that are required for the growth of living plants and animals. Major nutrients include **nitrogen (N)** and **phosphorous (P)**. Both are found in wastewater in various forms. Nitrogen is typically present in the influent in the forms of ammonia (NH₃) and organically bound nitrogen. Both nitrogen compounds can be measured by the **Total Kjeldahl Nitrogen (TKN)** test.



The TKN method has three major steps:

- (1) digestion to convert organic nitrogen to ammonium sulfate;
- (2) conversion of ammonium sulfate into condensed ammonia gas through addition of a strong base and boiling; and
- (3) measurement using colorimetric or titration methods. Because the measured concentration includes ammonia, the ammonia-nitrogen concentration is subtracted from the TKN to determine organic nitrogen.

Nutrient Section Post Quiz

Nitrogen and Phosphorus Removal Technologies

1. The actual technology selected will be site-specific and dependent on many factors including _____, influent water quality, required effluent levels, disposal options, availability of land, cost, etc. In some cases, a combination of technologies may be necessary to effectively remove all the contaminants of concern.

Nutrient Removal Technologies

Fixed-film systems - Aerobic/anaerobic trickling filter package plant

2. Fixed-film systems (FFSs) are _____ treatment processes that employ a medium such as rock, plastic, wood, or other natural or synthetic solid material that will support biomass on its surface and within its porous structure.

3. Commercial on-site systems use synthetic media and receive wastewater from overlying sprayheads for aerobic treatment and nitrification. _____ returns to the anoxic zone to mix with either septic tank contents or incoming septic tank effluent for denitrification.

4. Typical trickling filters systems currently available are capable of producing effluent _____ concentrations of 5 to 40 mg/L.

5. Higher removal occurs at low loading rates in warm climates. Systems can be configured for single-pass use where the _____ is applied to the trickling filter once before being disposed of, or for multi-pass use where a portion of the treated water is cycled back to the septic tank and re-treated via a closed loop.

6. Factors affecting performance include influent wastewater characteristics, hydraulic and organic loading, medium type, maintenance of optimal DO levels, and _____.

Sequencing batch reactor (SBR)

7. The major components of the package include the batch tank, aerator, mixer, decanter device, process control system (including timers), pumps, piping, and appurtenances. _____ may be provided by diffused air or mechanical devices.

8. The key to the _____ is the control system, which consists of a combination of level sensors, timers, and microprocessors which can be configured to meet the needs of the system.

9. _____ are suitable for areas with little land, stringent treatment requirements, and small wastewater flows such as RV parks or mobile homes, campgrounds, construction sites, rural schools, hotels, and other small applications. These systems are also useful for treating pharmaceutical, brewery, dairy, pulp and paper, and chemical wastes (USEPA, 2000d).

Intermittent sand filters (ISF)

10. _____ provide advanced secondary treatment of settled wastewater or septic tank effluent. They consist of a lined (e.g., impervious PVC liner on sand bedding) excavation or structure filled with uniform washed sand that is placed over an underdrain system.

11. Most biochemical treatment occurs within approximately 6 inches of the filter surface. Other treatment mechanisms that occur in sand filters include physical processes, such as straining and sedimentation, to remove suspended solids within the pores of the media. _____ are strained out at the filter surface.

12. Phosphorous is one element of concern in wastewater that can be removed in this manner, but the number of available adsorption sites is limited by the _____.

13. Sand filters are frequently used to pretreat septic tank effluent prior to _____ where the soil has insufficient unsaturated depth above ground water or bedrock to achieve adequate treatment.

Recirculating sand filters (RSF)

14. Recirculating filters using _____ provide advanced secondary treatment of settled wastewater or septic tank effluent.

Natural Systems

15. The natural systems described here include constructed wetlands and floating aquatic plant treatment systems. _____ are typically described in terms of the position of the water surface and/or the type of vegetation grown.

Nutrient Section Post Quiz Answers

1. Soil conditions, 2. Biological, 3. Nitrified effluent, 4. BOD and TSS, 5. Treated water, 6. Recirculation rates, 7. Aeration, 8. SBR process, 9. Package plant SBRs, 10. Sand filters, 11. Most suspended solids, 12. Characteristics of the media, 13. Subsurface infiltration onsite, 14. Sand, gravel, or other media, 15. Wetland systems

Topic 6- Wastewater Microbiology Section

Section Focus: You will learn the basics of the Microlife that lives in wastewater. At the end of this section, you will be able describe various wastewater microlife and bacteria. There is a post quiz at the end of this section to review your comprehension and a final examination in the Assignment for your contact hours.

Scope/Background: Wastewater Microbiology focuses on microbial contaminants found in wastewater, methods of detection for these contaminants, and methods of disinfecting water of microbial contamination. Microbiological analysis of activated sludge systems, lagoons, filters or any biological treatment process is an invaluable tool for troubleshooting and suggesting effective remedial actions for wastewater treatment issues.

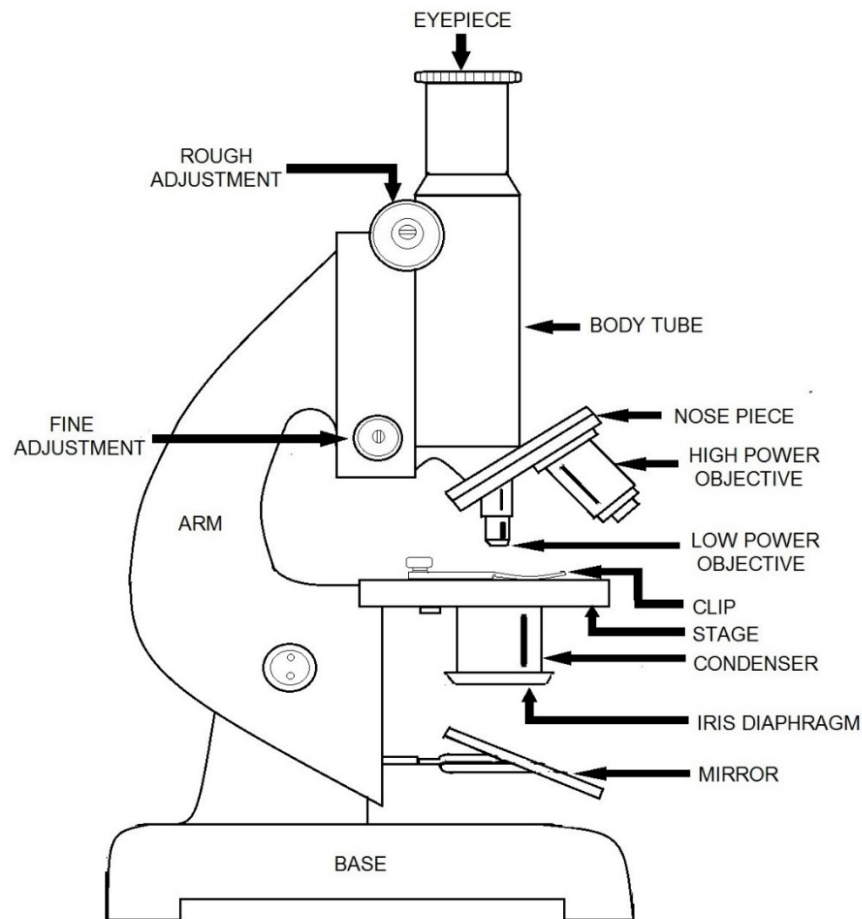

Microscopic Analysis

Operators perform microscopic analysis of wastewater bugs from activated sludge and lagoon systems to provide detailed reports identifying filament(s) and other indicator organisms that are present. This information is then used to give likely causes for the presence of filaments and suggestions for their control.

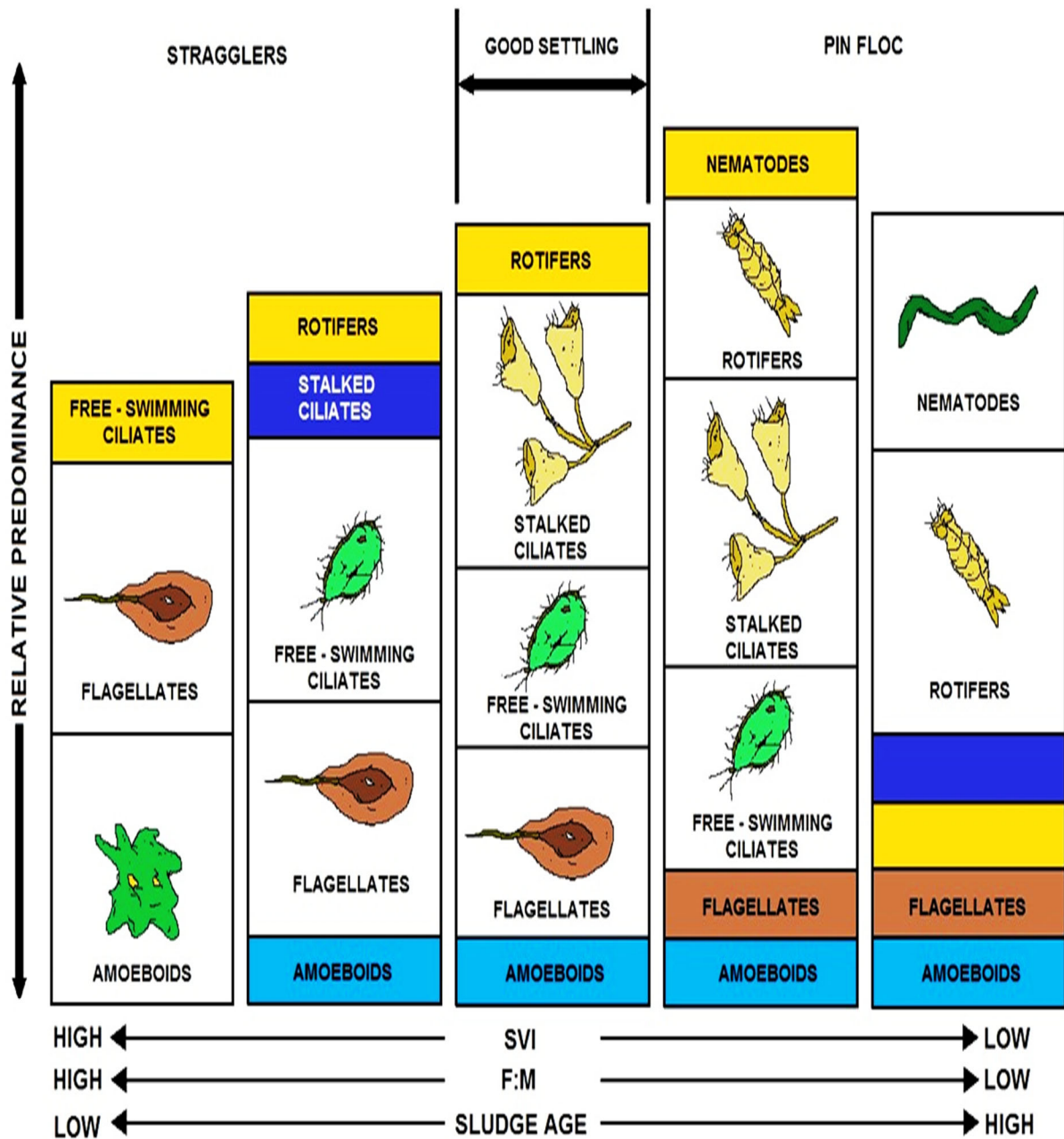

MICROORGANISMS USED IN WASTEWATER TREATMENT

Microbiology Introduction

The biomass in biological treatment processes may contain as many as 300 different types of microorganisms. Microorganisms of greatest significance to wastewater professionals can be classified into four groups:

1. Bacteria - Prokaryotes
2. Protozoans
3. Metazoans
4. Viruses

Each of these groups plays a key role in the complex world of wastewater biology.

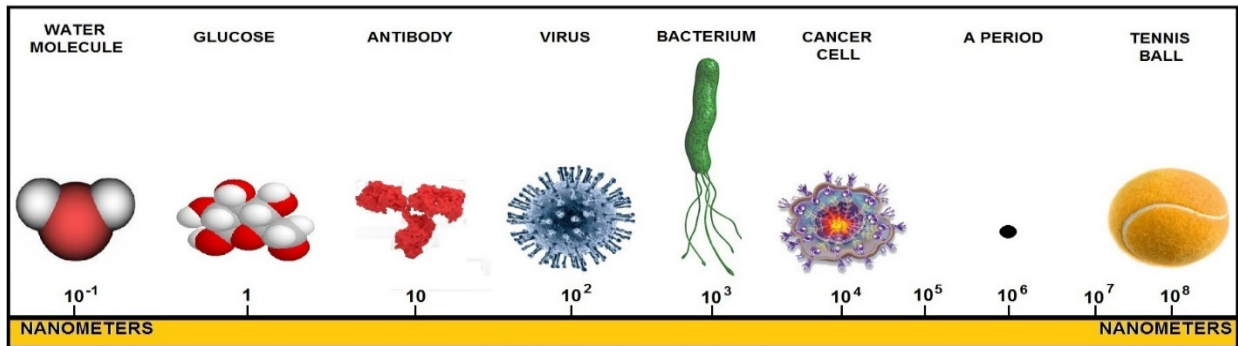

SIZE COMPARISON
HOW SMALL IS SMALL ?

Bacteria Section

Bacteria are highly designed creatures formed in a variety of shapes. The simplest shape is a round sphere or ball.

Bacteria formed like this are called cocci (singular coccus). The next simplest shape is cylindrical.

Cylindrical bacteria are called rods (singular rod). Some bacteria are basically rods but instead of being straight they are twisted, bent or curved, sometimes in a spiral. These bacteria are called spirilla (singular spirillum). Spirochaetes are tightly coiled up bacteria.

Organisms Descriptors and Meanings Chart

Description	Meaning
Aerobic	With air
Anaerobic	Without air
Auto	Self (Inorganic carbon)
Facultative	With air or without air
Hetero	Other (Organic carbon)
Troph	Feed or nourish
Photo	Light
Chemo	Chemical
Organo	Organic
Litho	Rock



Coccus



Bacillus



Spirillum

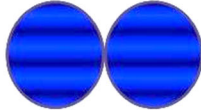

Diplo-

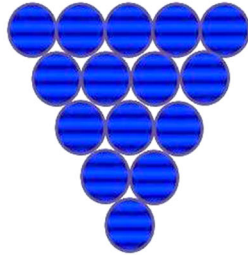

Staphylo-



Strepto-

Bacteria tend to live together in clumps, chains or planes. When they live in chains, one after the other, they are called filamentous bacteria - these often have long thin cells. When they tend to collect in a plane or a thin layer over the surface of an object, they are called a biofilm. Many bacteria exist as a biofilm and the study of biofilms is very important. Biofilm bacteria secrete sticky substances that form a sort of gel in which they live. The plaque on your teeth that causes tooth decay is a biofilm.

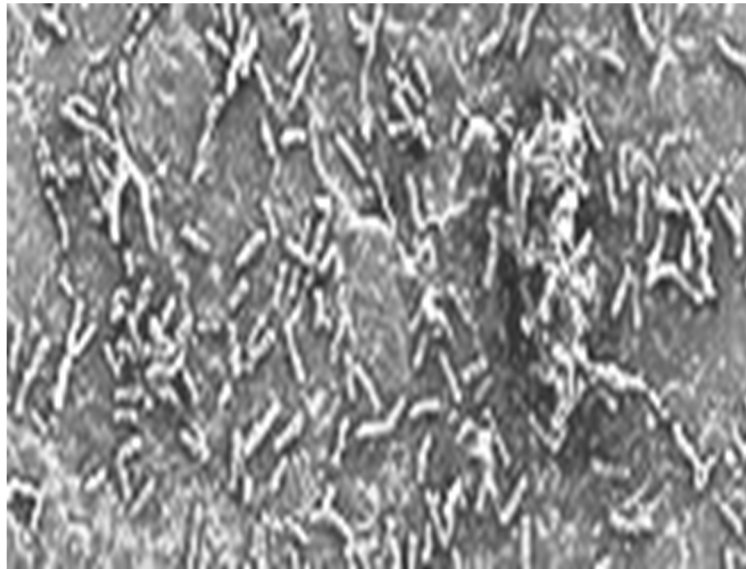

Biofilm bacteria

Bacteria Sub-Section

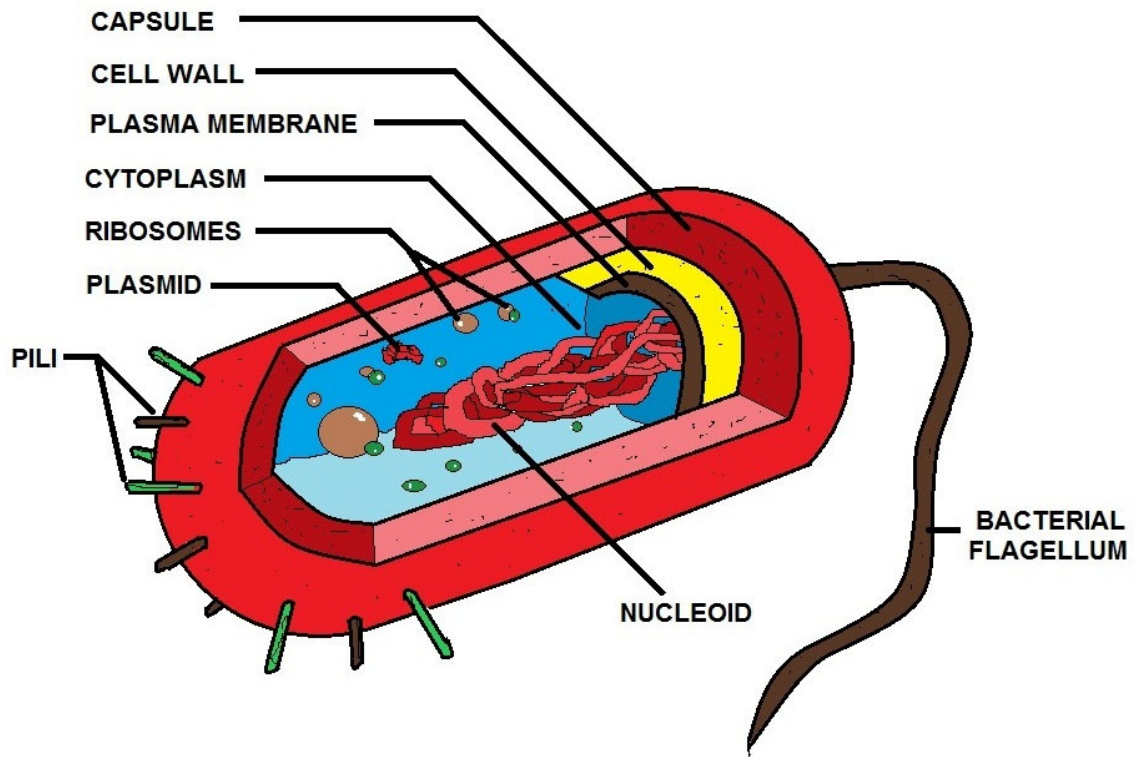

PROKARYOTIC BACTERIAL CELL

Above, a typical bacterial cell has a rigid outer coating that gives them structure and maintains their shape. This is the cell wall. Bacteria also have an inner, flexible membrane called the *periplasmic membrane* or *cell membrane*. This dual-layered covering has been compared to a balloon inside a box.

The cell membrane is very important because it controls the intake of food and other nutrients and discharge of waste products. It keeps “in” what needs to be inside (e.g., enzymes, nutrients, and food) and keeps “out” what should be outside (e.g., excess water). The box is the cell wall. The cell wall provides the structural support and maintains the shape of the cell.

Much of the cellular contents are large protein molecules, known as enzymes, which are manufactured by the cell. Other cellular contents may include granules of polyphosphate, sulfur, or stored organic material.

Bacteria are somewhat predictable and, at a basic level, can be compared to miniature combustion engines. For an engine to function, it requires both a fuel and oxygen source. The oxygen sources is used to chemically burn fuel to release energy. The technically correct term for this process is oxidation. The byproducts of combustion when burning organic fuel with oxygen are carbon dioxide (CO₂) and water (H₂O).

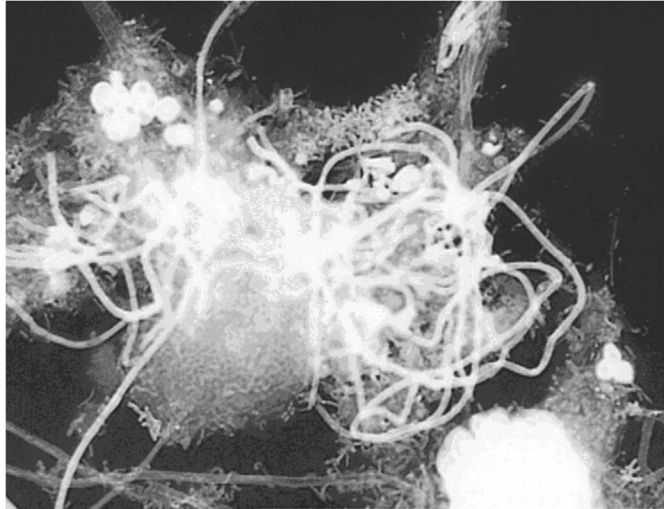

Filamentous Organisms

Bacteria may also be broken down further into groups depending upon their preferred growth patterns. In the activated sludge process, bacteria may grow in clumps or colonies called “flocs” or they can grow in long chains called “filaments. Filaments can be long and straight, bent, curved, coiled or branched like a tree branch. Flocs are held together with exopolymer. Exopolymer is a sticky substance produced by some bacteria. It is made from sugar molecules and helps microorganisms stick together. Flocs formed primarily from floc-forming bacteria and exopolymer settle quicker in the secondary clarifiers because they are compact and dense.

Filamentous Bacteria

There are a number of types of filamentous bacteria which proliferate in the activated sludge process. Filamentous bacteria perform several different roles in the process, some of which are beneficial and some of which are detrimental.

When filamentous organisms are in low concentrations in the process, they serve to strengthen the floc particles. This effect reduces the amount of shearing in the mechanical action of the aeration tank and allows the floc particles to increase in size.

Larger floc particles are more readily settled in a clarifier. Larger floc particles settling in the clarifier also tend to accumulate smaller particulates (surface adsorption) as they settle, producing an even higher quality effluent. Conversely, if the filamentous organisms reach too high a concentration, they can extend dramatically from the floc particles and tie one floc particle to another (interfloc bridging) or even form a filamentous mat of extra-large size.

Due to the increased surface area, without a corresponding increase in mass, the activated sludge will not settle well. This results in less solids separation and may cause a washout of solid material from the system.

In addition, air bubbles can become trapped in the mat and cause it to float, resulting in a floating scum mat. Due to the high surface area of the filamentous bacteria, once they reach an excess concentration, they can absorb a higher percentage of the organic material and inhibit the growth of more desirable organisms.

Site Specific Bacteria

Aeration and biofilm building are the key operational parameters that contribute to the efficient degradation of organic matter (BOD/COD removal). Over time, the application-specific bacteria become site-specific as the biofilm develops and matures and is even more efficient in treating the site-specific waste stream.

Facultative Bacteria

Most of the bacteria absorbing the organic material in a wastewater treatment system are facultative in nature. This means they are adaptable to survive and multiply in either anaerobic or aerobic conditions. The nature of individual bacteria is dependent upon the environment in which they live. Usually, facultative bacteria will be anaerobic unless there is some type of mechanical or biochemical process used to add oxygen to the wastewater. When bacteria are in the process of being transferred from one environment to another, the metamorphosis from anaerobic to aerobic state (and vice versa) takes place within a couple of hours.

Anaerobic Bacteria

Anaerobic bacteria live and reproduce in the absence of free oxygen. They utilize compounds such as sulfates and nitrates for energy and their metabolism is substantially reduced. In order to remove a given amount of organic material in an anaerobic treatment system, the organic material must be exposed to a significantly higher quantity of bacteria and/or detained for a much longer period of time.

A typical use for anaerobic bacteria would be in a septic tank. The slower metabolism of the anaerobic bacteria dictates that the wastewater be held several days in order to achieve even a nominal 50% reduction in organic material. That is why septic tanks are always followed by some type of effluent treatment and disposal process. The advantage of using the anaerobic process is that electromechanical equipment is not required.

Anaerobic bacteria release hydrogen sulfide as well as methane gas, both of which can create hazardous conditions. The anaerobic action in the collection lines of a sewer system, deadly hydrogen sulfide or explosive methane gas that can accumulate and be life threatening.

Aerobic Bacteria

Aerobic bacteria primarily live and multiply in the presence of free oxygen. Facultative bacteria always achieve an aerobic state when oxygen is present. While the name "aerobic" implies breathing air, dissolved oxygen is the primary source of energy for aerobic bacteria. The metabolism of aerobes is much higher than for anaerobes. This increase means that 90% fewer organisms are needed compared to the anaerobic process, or that treatment is accomplished in 90% less time. This provides a number of advantages including a higher percentage of organic removal. The by-products of aerobic bacteria are carbon dioxide and water.

Aerobic bacteria live in colonial structures called floc and are kept in suspension by the mechanical action used to introduce oxygen into the wastewater. This mechanical action exposes the floc to the organic material while treatment takes place. Following aerobic digestion and growth, a gravity clarifier separates and settles out the floc. Because of the mechanical nature of the aerobic digestion process, maintenance and operator oversight are required.

Anaerobic, Anoxic, and Aerobic Condition Chart

Environmental Condition	Defining Characteristics	Possible Biological Reactions
Anaerobic	<p>No oxygen present</p> <p>No Nitrite or Nitrate Present</p> <p>Sulfate may be present</p>	<p>CBOD broken down into soluble CBOD and VFAs.</p> <p>Heterotrophs are dormant.</p> <p>Nitrifiers are dormant.</p> <p>PAOs release phosphorus.</p> <p>PAOs uptake VFAs.</p> <p>Sulfate reduced to hydrogen sulfide.</p>
Anoxic	<p>No oxygen present.</p> <p>Nitrite and/or Nitrate present.</p> <p>Sulfate may be present.</p>	<p>Heterotrophs convert CBOD to biomass.</p> <p>Heterotrophs convert NO₂⁻ and NO₃⁻ into Nitrogen gas.</p> <p>Nitrifiers are dormant.</p> <p>PAOs consume stored VFAs.</p> <p>PAOs uptake phosphorus.</p>
Aerobic/Oxic	<p>Oxygen present.</p> <p>Nitrite and nitrate may also be present.</p> <p>Sulfate may be present.</p>	<p>Heterotrophs convert CBOD to biomass.</p> <p>Nitrifiers convert NH₃ to NO₂⁻ and NO₃⁻.</p> <p>PAOs consume stored VFAs.</p> <p>Hydrogen sulfide oxidized to sulfate.</p>

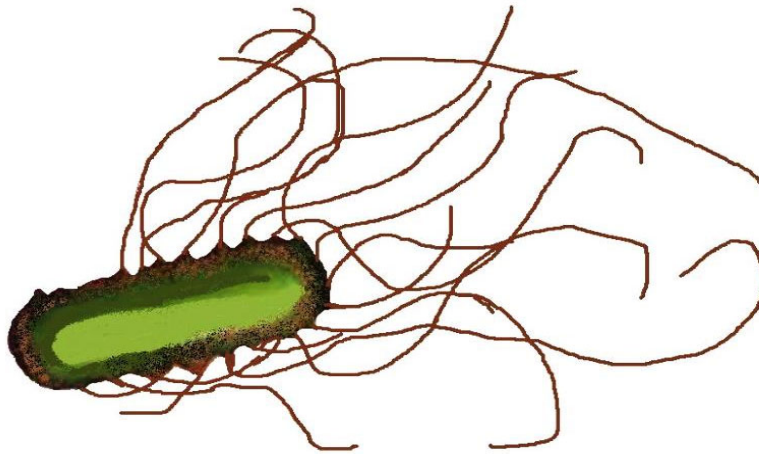

PERITRICHOUS BACTERIA

Microbiologists broadly classify bacteria according to their shape: spherical, rod-shaped, and spiral-shaped. Pleomorphic bacteria can assume a variety of shapes. Bacteria may be further classified according to whether they require oxygen (aerobic or anaerobic) and how they react to a test with Gram's stain.

Bacteria in which alcohol washes away Gram's stain are called gram-negative, while bacteria in which alcohol causes the bacteria's walls to absorb the stain are called gram-positive.

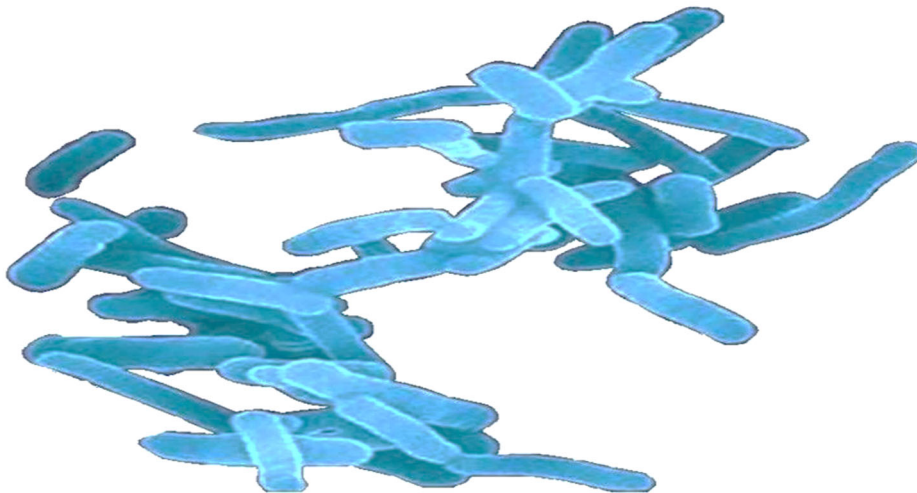

SHIGELLA DYSENTERIAE

Shigella dysenteriae is a species of the rod-shaped bacterial genus *Shigella*. *Shigella* can cause shigellosis (bacillary dysentery). *Shigellae* are Gram-negative, non-spore-forming, facultatively anaerobic, non-motile bacteria.

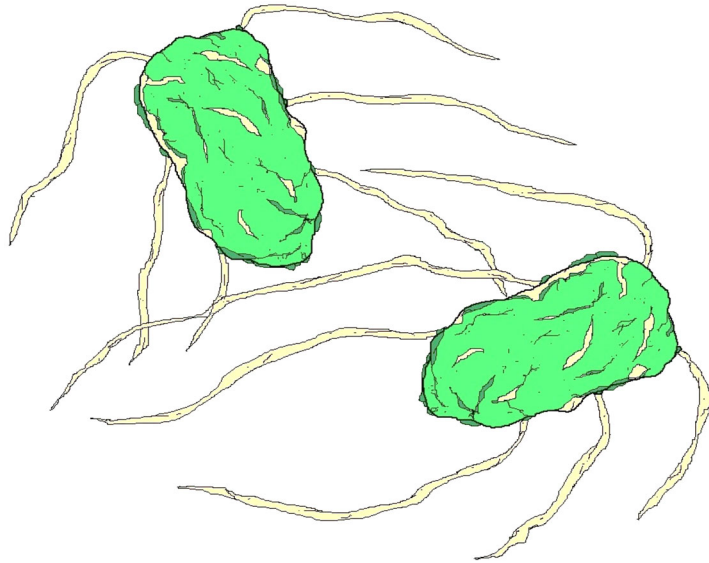

SALMONELLA

Salmonellae usually do not ferment lactose; most of them produce hydrogen sulfide that in media containing ferric ammonium citrate reacts to form a black spot in the center of the creamy colonies.

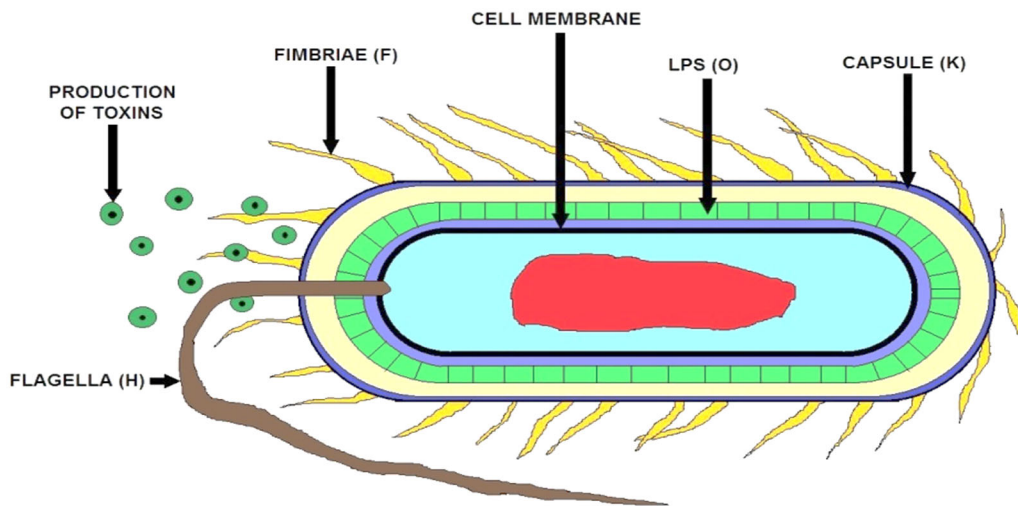

E. COLI DIAGRAM #1

Fecal Coliform Bacteria

Fecal coliform bacteria such as E.coli are microscopic organisms that live in the intestines of warm-blooded animals. They also live in the waste material, or feces, excreted from the intestinal tract. When fecal coliform bacteria are present in high numbers in a water sample, it means that the water has received fecal matter from one source or another. Although not necessarily agents of disease, fecal coliform bacteria may indicate the presence of disease-carrying organisms, which live in the same environment as the fecal coliform bacteria.

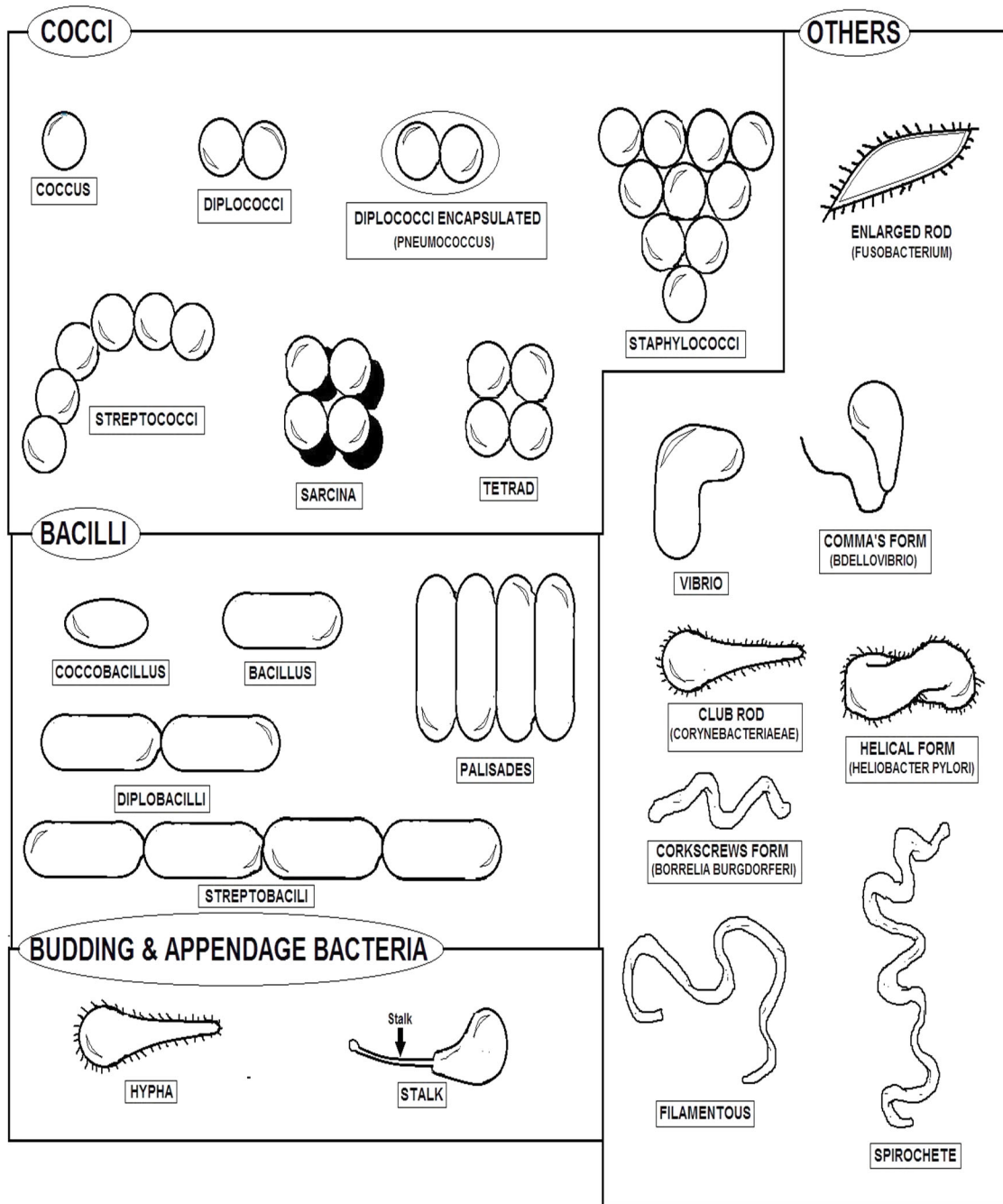

COMMON BACTERIA SHAPE DIAGRAM #1

AEROBIC BUGS IN SECONDARY TREATMENT

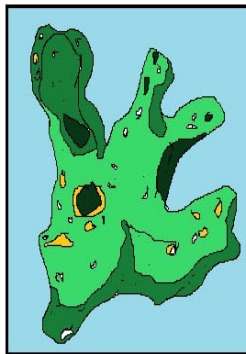

AMOEBA PROTEUS

HIGH PRESENCE DURING RECOVERY FROM TOXIC DISCHARGE OR LOW OXYGEN LEVELS. THE PRESENCE OF AMOEBAS INDICATE UNSTABLE WASTEWATER ENVIRONMENT AND UNHEALTHY SLUDGE



VORTICELLA sp.

A HIGH PRESENCE OF THESE STALKED CILIATES INDICATE STABLE AND MATURE BACTERIAL CLUSTERS AND A HEALTHY SLUDGE

ANAEROBIC BUGS IN DIGESTERS

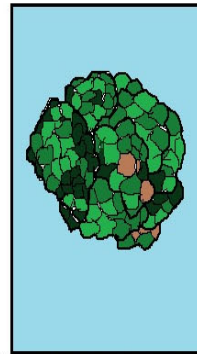

METHANOSARCINA sp.

THESE METHANE PRODUCING ORGANISMS LIVE IN DIVERSE ANAEROBIC ENVIRONMENTS

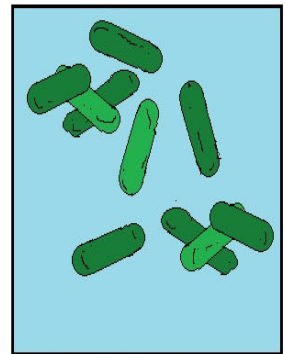

LACTOBACILLUS sp.

THESE FERMENTING BACTERIA SECRETE ORGANIC ACIDS AND ENZYMES THAT DEGRADE COMPLEX ORGANIC MATTER INTO SIMPLER METHANE AND CARBON DIOXIDE



MICROORGANISMS AT WORK IN WASTEWATER TREATMENT

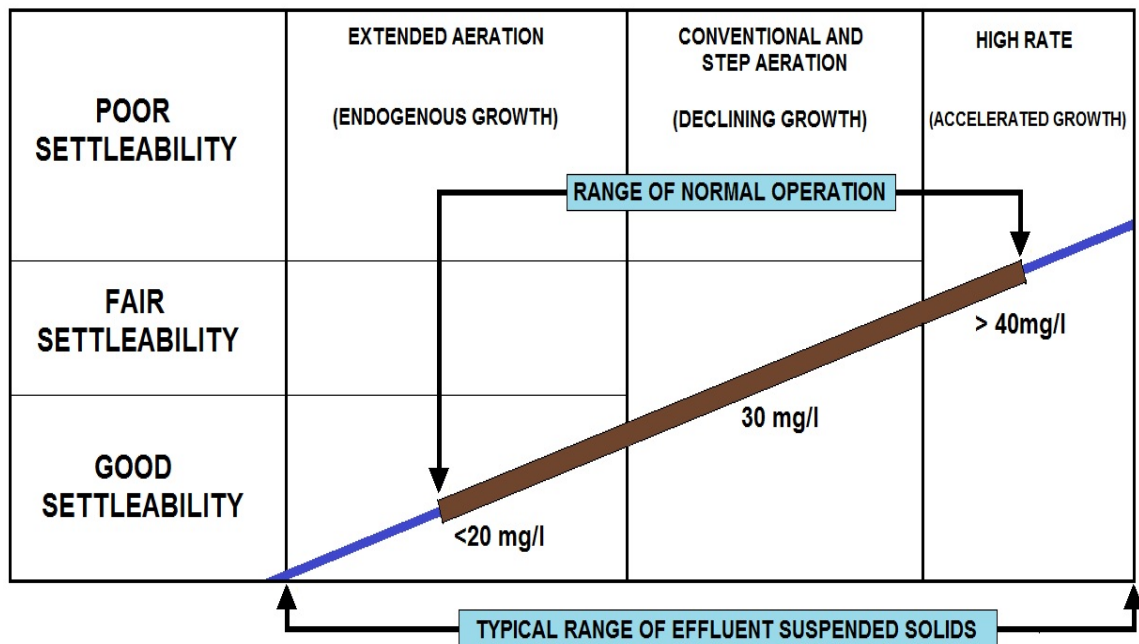

RELATIONSHIP BETWEEN A/S SETTLEABILITY AND OPERATING FOOD- TO MICROORGANISM RATIO

Bacteria Growth Terms

Lag Phase

During the lag-phase, bacteria are becoming acclimated to their new environment. They are digesting food and are developing the enzymes needed to break down the types of nutrients that the bacteria have detected. Growth does not occur during this phase.

Accelerated Growth Phase

Bacteria begin to grow at a rapid rate because of the excess amount of food that is available. The cells are mostly dispersed and active. They are not sticking together to form floc. Many bacteria have flagella.

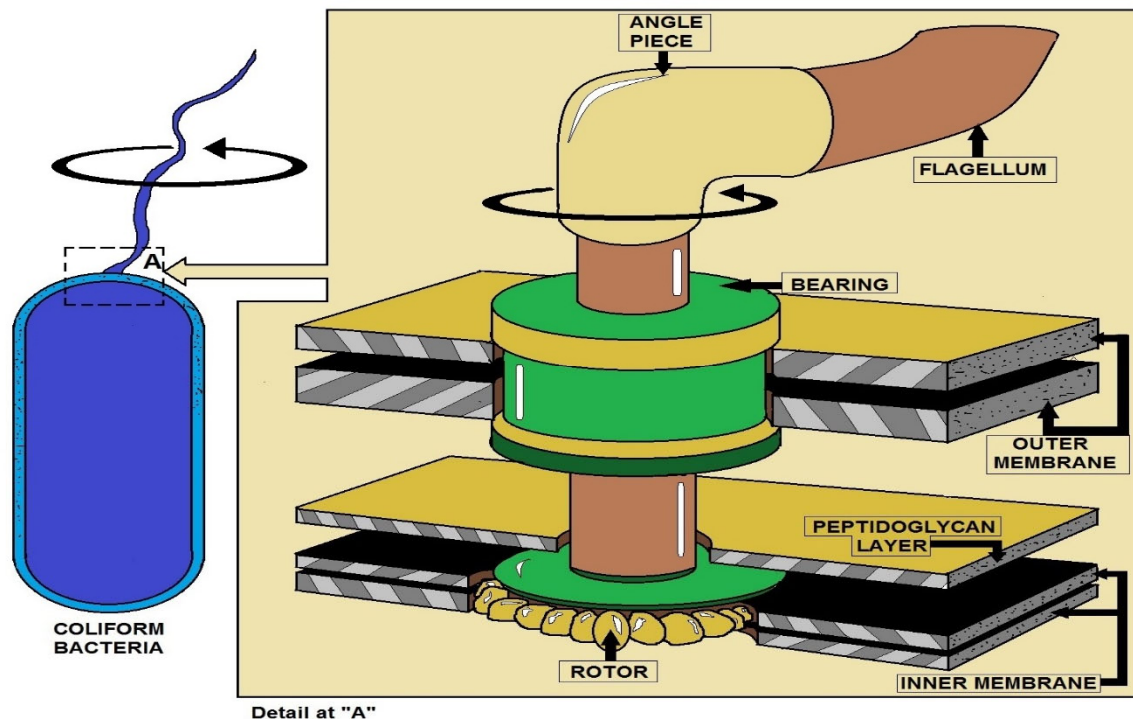

FLAGELLUM DIAGRAM

Declining Growth-phase

Reproduction slows down at this phase because there is no longer an excess amount of food. There are a large number of bacteria that have to compete for the remaining food. Fewer bacteria begin to lose their flagella.

Stationary-phase

Because of the lack of food, some bacteria are reproducing but an equal number are also dying. Therefore, the number of bacteria remains relatively constant. They have not lost their flagella and have formed a sticky substance covering the outside of the cell wall which allows them to agglomerate into floc.

Death Phase

In this phase the death rate increased with little or no growth occurring. The total number of bacteria keeps reducing.

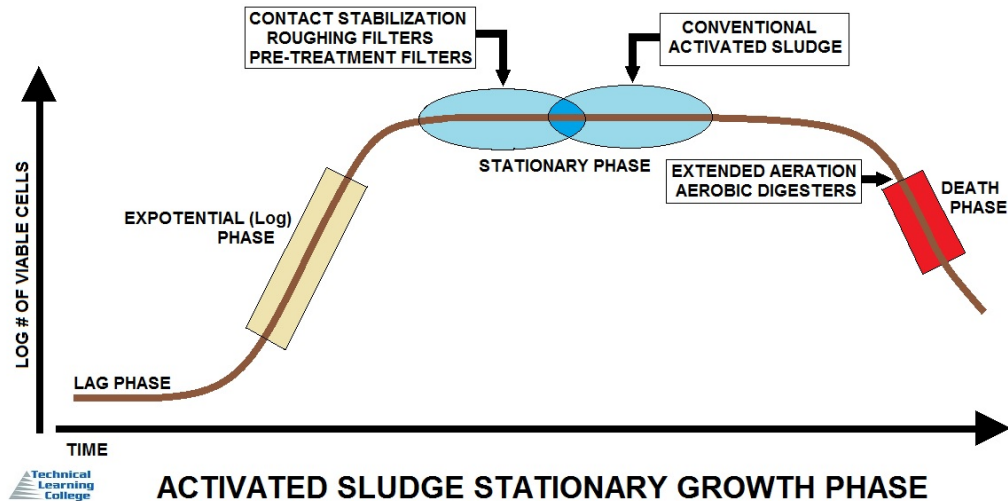

Bacteria in the activated sludge system must be allowed to hang out in the aeration basin until they reach the stationary-phase. If they flow out of the basin too early, they will be active and motile and will not settle out as floc.

Food: Microorganism Ratio

The food to microorganism (F/M) ratio measures the amount of food that is available for the amount of microorganisms present in the aeration basin. The amount of food is determined by the biochemical oxygen demand (BOD) or chemical oxygen demand (COD) test. If there is too much food and not enough microorganism (high F/M ratio), settling problems may occur because the accelerated growth phase bacteria are active and multiplying, and will not yet develop into floc.

Factors Affecting Bacteria Growth

It is the responsibility of the operator to provide the best possible environment for the floc-forming bacteria to grow. The operator can control some of the conditions they require and there are some conditions they cannot control. For instance, the operator has no control of the weather and very little control over the types and amount of nutrients entering the treatment plant. Therefore, it is important that the operator understand how the following factors affect the growth of the bacteria.

- Oxygen Utilization
- Sludge Age
- Dissolved Oxygen
- Mixing
- pH
- Temperature
- Nutrients

Oxygen Utilization

Actively growing bacteria eat food at a rapid rate, therefore using oxygen at a rapid rate. The rate of oxygen use is normally termed the Oxygen Uptake Rate and is measured in mg O₂/hr/gm of MLSS.

Generally a higher Uptake Rate is associated with a higher F:M ratio and younger sludge ages. A lower Uptake Rate is associated with a lower F:M ratio and older sludge ages.

Sludge Age

As bacteria first begin to develop in the system they grow singularly, in small clumps and chains. They are very active with flagella and do not have a well-developed slime layer. The bacteria are dispersed and do not settle well. As the sludge is allowed to age. The bacteria have fewer flagella or lose their flagella and accumulate more slime. The small clumps and chains begin to stick together and form floc large enough to settle.

Dissolved Oxygen

Aerobic bacteria require at least 0.1 - 0.3 mg/L of dissolved oxygen (DO) to survive.

At least 2 mg/L of DO must be maintained in the bulk fluid in order for the bacteria in the center of the floc to get 0.1- 0.3 mg/L of oxygen. If not, the bacteria in the center will die and the floc will begin to break up.

Mixing

Mixing is required to bring the bacteria, oxygen and nutrients in contact with each other. Remember, once food is limited the bacteria lose their flagella and can no longer swim. Without sufficient mixing, the bacteria will not bump into each other to form floc and proper treatment will not take place.

pH

It is the bacterial enzymes that are very pH dependent. Their optimal pH is between 7.0 and 7.5. Rapid pH changes should be avoided.

Temperature

Biochemical reactions are temperature dependent. Reactions are slower in colder temperatures so the system will require more organisms to do the work.

Reactions are faster in warmer temperatures, therefore fewer bacteria are required to do the same job during the summer months.

Nutrients

Bacteria require basic nutrients for growth (carbon, nitrogen, phosphorus as well as trace amounts of sodium, potassium, magnesium and iron. All these are present in normal domestic sewage. Generally, industrial wastes do not contain sufficient nutrients and must be supplemented.

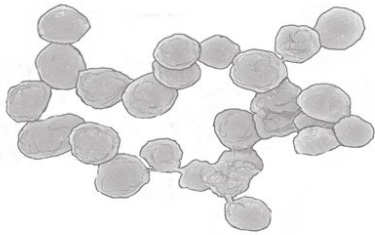

Methanosarcina sp.

These methane-producing organisms live in diverse anaerobic environments

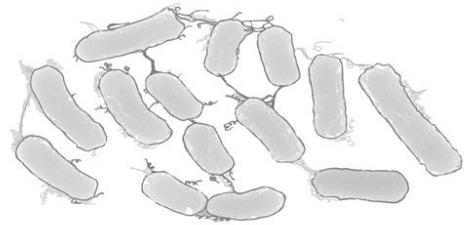

Lactobacillus sp.

These fermenting bacteria secrete organic acids and enzymes that degrade complex organic matter into simpler methane and carbon dioxide



ANAROBIC BUGS DIGESTER

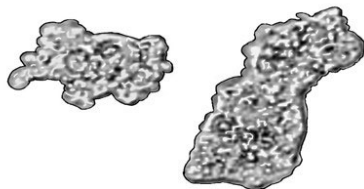

Amoeba proteus

High presence during recovery from toxic discharge or low oxygen levels, **Amoeba** indicates an unstable wastewater environment and unhealthy sludge

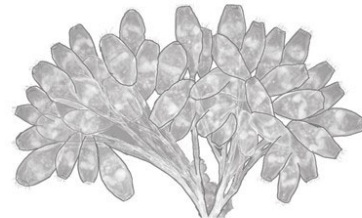

Vorticella sp.

High presence of these stalked ciliates indicates stable and mature bacterial clusters and a health sludge



AEROBIC BUGS SECONDARY TREATMENT

Protozoans and Metazoans Sub-Section

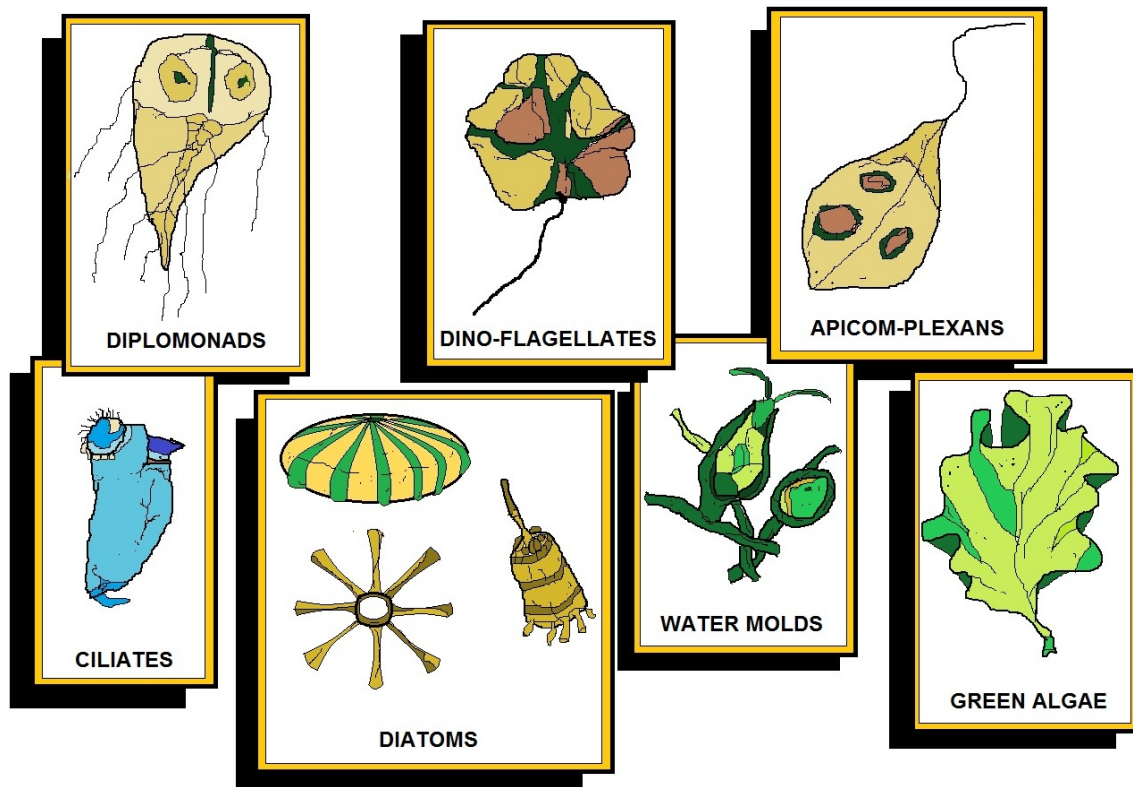

KINGDOM PROTISTA DIAGRAM

Taxonomy

Taxonomy is the science of categorizing life forms according to their characteristics. Eighteen different categories are used to define life forms from the broadest down to the most specific.

They are: Kingdom, Phylum, Subphylum, Superclass, Class, Subclass, Cohort, Superorder, Order, Suborder, Superfamily, Family, Subfamily, Tribe, Genus, Subgenus, Species and Subspecies. Identifying the genus is usually specific enough to determine the role of the organisms found in a wastewater treatment system.

In a wastewater treatment system, the next higher life form above bacteria is protozoans. These single-celled animals perform three significant roles in the activated sludge process. These include floc formation, cropping of bacteria and the removal of suspended material.

Protozoans are also indicators of biomass health and effluent quality. Because protozoans are much larger in size than individual bacteria, identification and characterization is more readily performed under a microscope.

Metazoans are very similar to protozoans except that they are usually multi-celled animals. Macroinvertebrates, such as nematodes and rotifers, are typically found only in a well-developed biomass.

The presence of protozoans and metazoans and the relative abundance of certain species can be a predictor of operational changes within a treatment plant. In this way, an operator is able to make adjustments and minimize negative operational effects simply by observing changes in the protozoan and metazoan population.

Dispersed Growth

Dispersed growth is material suspended within the activated sludge process that has not been adsorbed into the floc particles. This material consists of very small quantities of colloidal (too small to settle out) bacteria as well as organic and inorganic particulate material.

While a small amount of dispersed growth between the floc particles is normal, excessive amounts can be carried through a secondary clarifier. When discharged from the treatment plant, dispersed growth results in higher effluent solids.

Process Indicators

Following taxonomic identification, enumeration and evaluation of the characteristics of the various organisms and structures present in a wastewater sample, the information can be used to draw conclusions regarding the treatment process.

Numerous industry references, such as ***WASTEWATER BIOLOGY: THE MICROLIFE*** by the Water Environment Federation, can be used to provide a comprehensive indication of the conditions within a treatment process. As an example, within most activated sludge processes, the shape of the floc particles can indicate certain environmental or operational conditions.

A spherical floc particle indicates immature floc, as would be found during start-up or a process recovery.

A mature floc particle of irregular shape indicates the presence of a beneficial quantity of filamentous organisms and good quality effluent. An excess of dispersed growth could indicate a very young sludge, the presence of toxic material, excess mechanical aeration or an extended period of time at low dissolved oxygen levels.

Paramecia

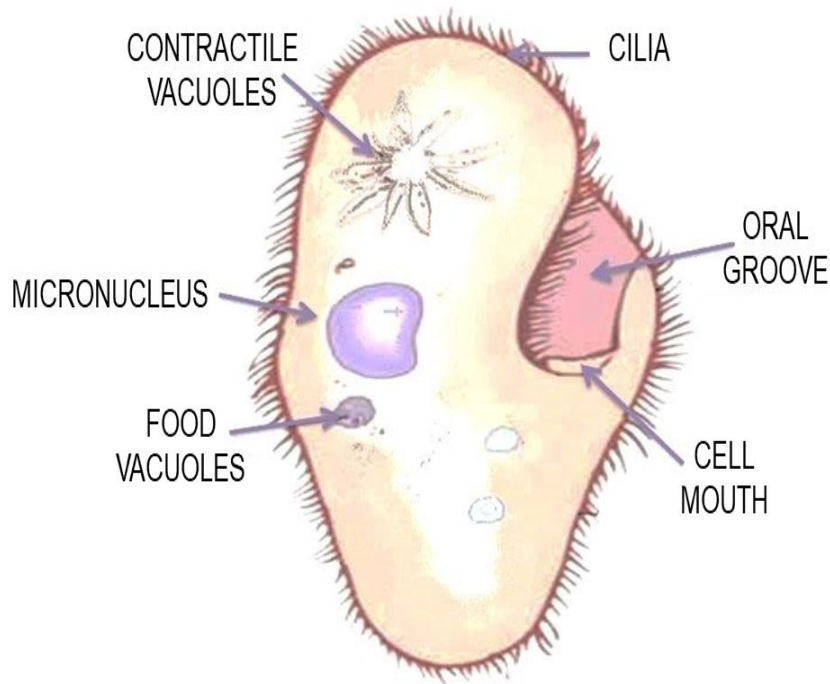





PARAMECIUM DIAGRAM

Paramecia are a group of unicellular ciliate protozoa formerly known as slipper animalcules from their slipper shape. They are commonly studied as a representative of the ciliate group. Simple cilia cover the body which allows the cell to move with a synchronous motion (like a caterpillar).

There is also a deep oral groove containing inconspicuous compound oral cilia (as found in other peniculids) that is used to draw food inside. They generally feed upon bacteria and other small cells.

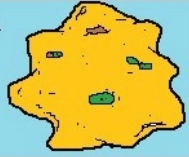
Osmoregulation is carried out by a pair of contractile vacuoles, which actively expel water absorbed by osmosis from their surroundings.

Paramecia are widespread in freshwater environments, and are especially common in scums. Paramecia are attracted by acidic conditions. Certain single-celled eukaryotes, such as Paramecium, are examples for exceptions to the universality of the genetic code (translation systems where a few codons differ from the standard ones).

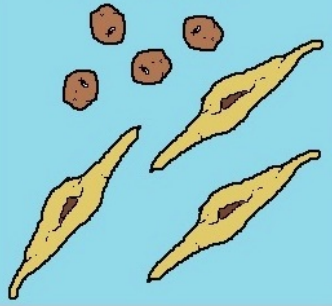
PHYLUM	COMMON NAME	LOCOMOTION	EXAMPLES
SARCODINA	SARCODINES	<u>PSEUDOPODIA</u>	<p>AMOEBA</p> 
CILIOPHORA	CILIATES	<u>CILIA</u>	<p>PARAMECIUM</p> 
SARCO- MASTIGOPHORA (ZOOMASTIGINA)	ZOOFLAGELLATES	<u>FLAGELLA</u>	<p>TRYPANOSMA</p>  <p>GIARDIA</p> 
APICOMPLEXA (SPOROZOA)	SPOROZOANS	<u>NONE IN ADULT FORM</u>	<p>PLASMODIUM</p> 

PROTOZOA CLASSIFICATION DIAGRAM

Protozoan Diseases

Protozoan pathogens are larger than bacteria and viruses, but still microscopic. They invade and inhabit the gastrointestinal tract. Some parasites enter the environment in a dormant form, with a protective cell wall called a “cyst.” The cyst can survive in the environment for long periods of time and be extremely resistant to conventional disinfectants such as chlorine. Effective filtration treatment is therefore critical to removing these organisms from water sources.

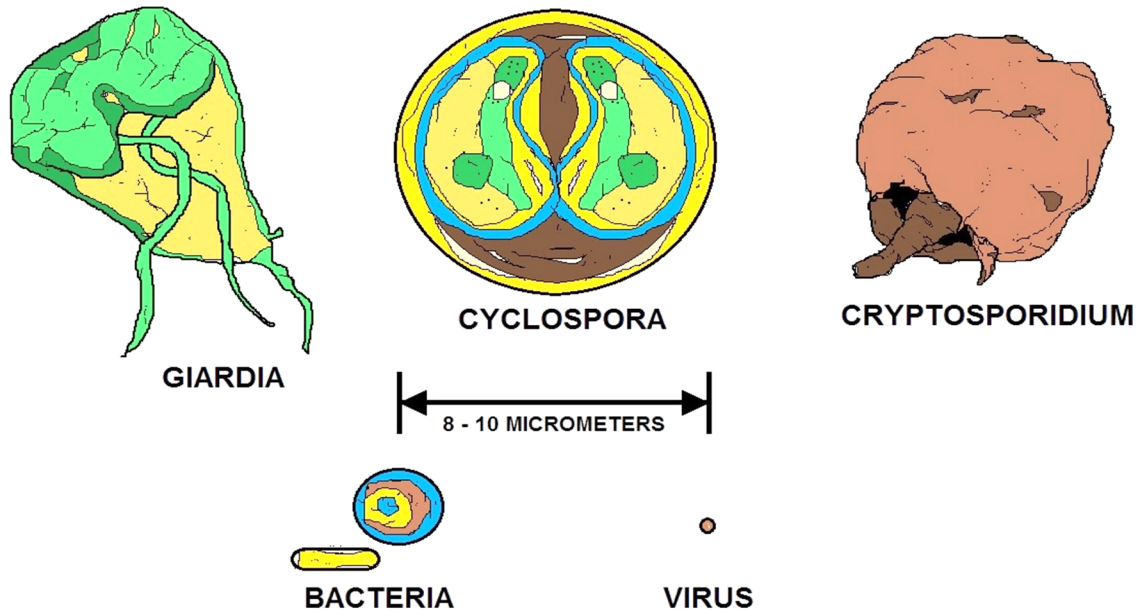

COMPARATIVE SIZES OF PROTOZOAN PARASITES

Giardiasis

Giardiasis is a commonly reported protozoan-caused disease. It has also been referred to as “*backpacker’s disease*” and “*beaver fever*” because of the many cases reported among hikers and others who consume untreated surface water.

Symptoms include chronic diarrhea, abdominal cramps, bloating, frequent loose and pale greasy stools, fatigue and weight loss. The incubation period is 5-25 days or longer, with an average of 7-10 days. Many infections are asymptomatic (no symptoms).

Giardiasis occurs worldwide. Waterborne outbreaks in the United States occur most often in communities receiving their drinking water from streams or rivers without adequate disinfection or a filtration system. The organism, *Giardia lamblia*, has been responsible for more community-wide outbreaks of disease in the U.S. than any other pathogen. Drugs are available for treatment but are not 100% effective.

Cryptosporidiosis

Cryptosporidiosis is an example of a protozoan disease that is common worldwide, but was only recently recognized as causing human disease. The major symptom in humans is diarrhea, which may be profuse and watery. The diarrhea is associated with cramping abdominal pain. General malaise, fever, anorexia, nausea, and vomiting occur less often.

Symptoms usually come and go, and end in fewer than 30 days in most cases. The incubation period is 1-12 days, with an average of about seven days. *Cryptosporidium* organisms have been identified in human fecal specimens from more than 50 countries on six continents. The mode of transmission is fecal-oral, either by person-to-person or animal-to-person. There is no specific treatment for *Cryptosporidium* infections.

All of these diseases, with the exception of hepatitis A, have one symptom in common: diarrhea. They also have the same mode of transmission, fecal-oral, whether through person-to-person or animal-to-person contact, and the same routes of transmission, being either foodborne or waterborne. Although most pathogens cause mild, self-limiting disease, on occasion, they can cause serious, even life threatening illness. Particularly vulnerable are persons with weak immune systems such as those with HIV infections or cancer. By understanding the nature of waterborne diseases, the importance of properly constructed, operated and maintained public water systems becomes obvious.

While water treatment cannot achieve sterile water (no microorganisms), the goal of treatment must clearly be to produce drinking water that is as pathogen-free as possible at all times. For those who operate water systems with inadequate source protection or treatment facilities, the potential risk of a waterborne disease outbreak is real. For those operating systems that currently provide adequate source protection and treatment, operating and maintaining the system at a high level on a continuing basis is critical to prevent disease.

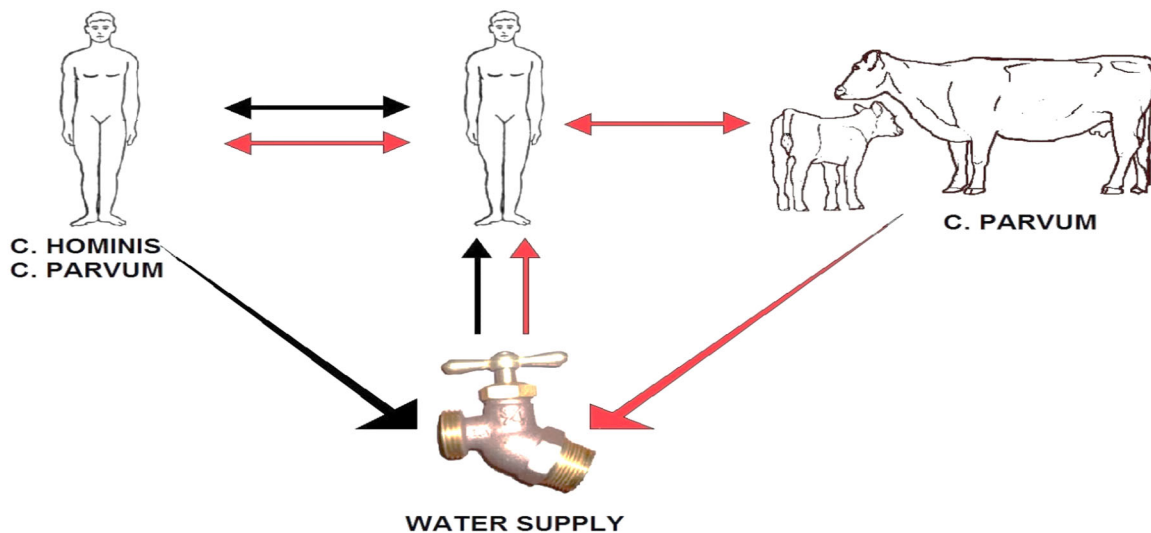

CRYPTOSPORIDIUM TRANSMISSION

Indicator Organisms - More information in the Appendix
<http://www.abctlc.com/downloads/PDF/WWTGlossary.pdf>

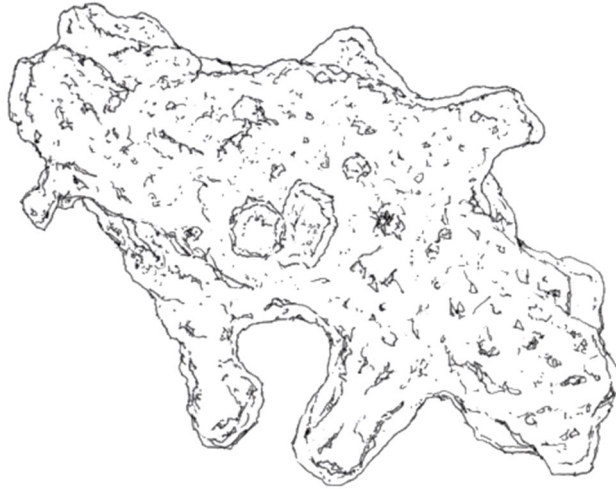

AMOEBOID

"Amoeboid" and "amoeba" are used interchangeably. Amoeboids move using pseudopodia, which are bulges of cytoplasm. Amoebas breathe using their entire cell membrane that is constantly immersed in water. Excess water can cross into the cytosol. Amoebas have a contractile vacuole to expel excess water.

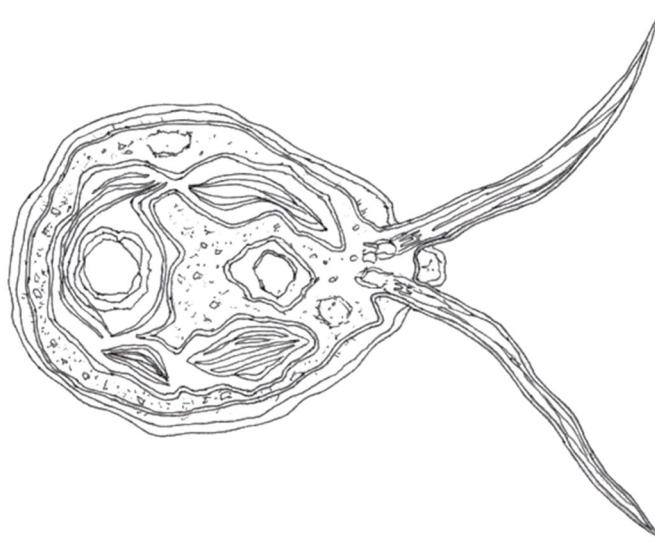

CHLAMYDOMONAS

Chlamydomonas reinhardtii is known to remove nitrogen and phosphorus from wastewater.

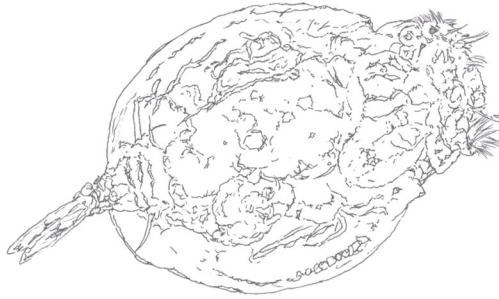

ROTIFER EUCHLANIS

Euchlanis is commonly found in activated sludge when effluent quality is good. It requires a continual supply of dissolved oxygen, evidence that aerobic conditions have been sustained.

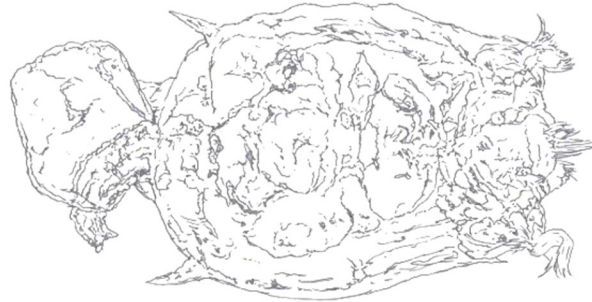

ROTIFER CALYCIFLORUS

This particular Rotifer is a great indicator bug for fresh and brackish water. With the increasing use of antibiotics, wastewater facilities are noticing passage through the treatment process. The toxicity of antibiotics effects the reproduction of these organisms.



STYLONYCHIA MYTILUS

This ciliate is heavy metal resistant. Stylonychia mytilus, isolated from industrial wastewater, has been shown to be potential bioremediator of contaminated wastewater. The ability of Stylonychia to take up variety of heavy metals from the medium could be exploited for metal detoxification and environmental clean-up operations.

Activated Sludge Bugs

We will look at four groups of microorganisms “bugs” that do the greatest amount of “chewing down” in the activated sludge process. The first group is the bacteria which eat the dissolved organic compounds. The second and third groups of bugs are microorganisms known as the free-swimming and stalked ciliates. These larger bugs eat the bacteria and are heavy enough to settle by gravity. The fourth group is a microorganism, known as Suctorina, which feeds on the larger bugs and assists with settling.

The interesting thing about the bacteria that eat the dissolved organics is they have no mouths. The bacteria have an interesting property, their “fat reserves” are stored on the outside of their bodies. This fat layer is sticky and is what the organics adhere to.

Once the bacteria have “contacted” their food, they start the digestion process. A chemical enzyme is sent out through the cell wall to break up the organic compounds.

This enzyme, known as hydrolytic enzyme, breaks the organic molecules into small units which are able to pass through the cell wall of the bacteria.



In wastewater treatment, this process of using bacteria-eating bugs in the presence of oxygen to reduce the organics in water is called activated sludge. The first step in the process, the contact of the bacteria with the organic compounds, takes about 20 minutes. The second step is the breaking up, ingestion and digestion processes, which takes four to 24 hours.

The fat storage property of the bacteria is also an asset in settling. As the bugs “bump” into each other, the fat on each of them sticks together and causes flocculation of the non-organic solids and biomass.

From the aeration tank, the wastewater, now called mixed liquor, flows to a secondary clarification basin to allow the flocculated biomass of solids to settle out of the water.

The solids biomass, which is the activated sludge, contains millions of bacteria and other microorganisms, is used again by returning it to the influent of the aeration tank for mixing with the primary effluent and ample amounts of air.



Sampling A/S

Paramecium sp.

Paramecium is a medium to large size (100-300 µm) swimming ciliate, commonly observed in activated sludge, sometimes in abundant numbers. The body is either foot-shaped or cigar-shaped, and somewhat flexible. Paramecium is uniformly ciliated over the entire body surface with longer cilia tufts at the rear of the cell.



Paramecium swims with a smooth gliding motion. It may also be seen paired up with another Paramecium which makes a good diagnostic key. The cell has either one or two large water cavities which are also identification tools. This swimmer moves freely in the water column as it engulfs suspended bacteria. It has a large feeding groove used to trap bacteria and form the food cavities that move throughout the body as digestion occurs. Paramecium is described as a filter-feeding ciliate because its cilia move and filter bacteria from the water.

Vorticella sp.

Vorticella is a stalked ciliate. There are at least a dozen species found in activated sludge ranging in length from about 30 to 150 µm. These organisms are oval to round shaped, have a contractile stalk, a domed feeding zone, and a water vacuole located near the terminal end of the feeding cavity.



One organism is found on each stalk except during cell division. After reproducing, the offspring develops a band of swimming cilia and goes off to form its own stalk.

The expelled organism is called a "swarmer."

Vorticella

Vorticella feeds by producing a vortex with its feeding cilia. The vortex draws bacteria into its gullet. Vorticella's principal food source is suspended bacteria. The contracting stalk provides some mobility to help the organism capture bacteria and avoid predators. The stalk resembles a coiled spring after its rapid contraction.

Indicator: If treatment conditions are bad, for example low DO or toxicity, Vorticella will leave their stalks. Therefore, a bunch of empty stalks indicates poor conditions in an activated sludge system. Vorticella sp. are present when the plant effluent quality is high.

Euglypha sp.

Euglypha (70-100 µm) is a shelled (testate) amoeba. Amoebas have jelly-like bodies. Motion occurs by extending a portion of the body (pseudopodia) outward. Shelled amoebas have a rigid covering which is either secreted or built from sand grains or other extraneous materials. The secreted shell of this Euglypha sp. consists of about 150 oval plates. Its spines project backward from the lower half of the shell. Euglypha spines may be single or in groups of two or three. The shell has an opening surrounded by 8-11 plates that resemble shark teeth under very high magnification.

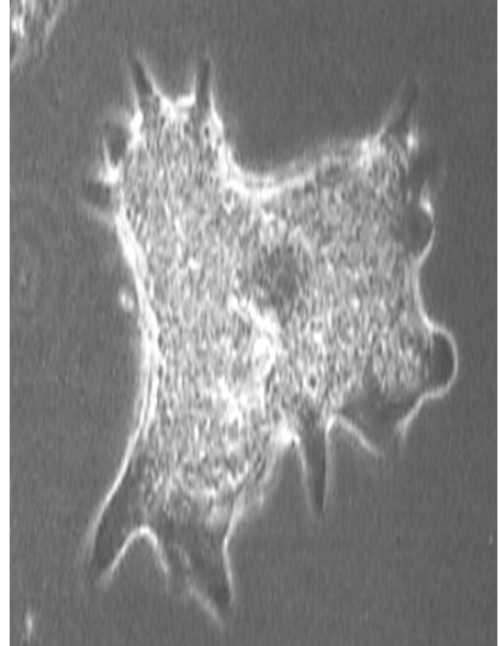

The shell of Euglypha is often transparent, allowing the hyaline (watery) body to be seen inside the shell. The pseudopodia extend outward in long, thin, rays when feeding or moving. Euglypha primarily eats bacteria.

Indicator: Shelled amoebas are common in soil, treatment plants, and stream bottoms where decaying organic matter is present. They adapt to a wide range of conditions and therefore are not good indicator organisms.

Euchlanis sp.

This microscopic animal is a typical rotifer. Euchlanis is a swimmer, using its foot and cilia for locomotion. In common with other rotifers, it has a head rimmed with cilia, a transparent body, and a foot with two strong swimming toes.

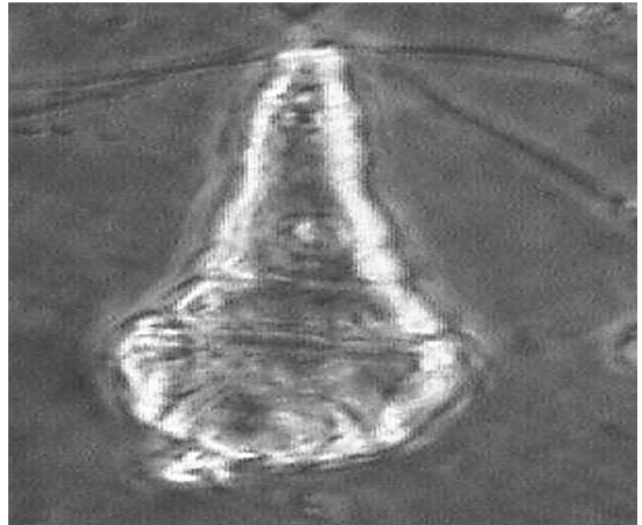

Euchlanis

The head area, called the "corona," has cilia that beat rhythmically, producing a strong current for feeding or swimming. Euchlanis is an omnivore, meaning that its varied diet includes detritus, bacteria, and small protozoa.

Euchlanis has a glassy shell secreted by its outer skin. The transparent body reveals the brain, stomach, intestines, bladder, and reproductive organs.

A characteristic of rotifers is their mastax, which is a jaw-like device that grinds food as it enters the stomach. At times the action of the mastax resembles the pulsing action of a heart. Rotifers, however, have no circulatory system.

Indicator: Euchlanis is commonly found in activated sludge when effluent quality is good. It requires a continual supply of dissolved oxygen, evidence that aerobic conditions have been sustained.

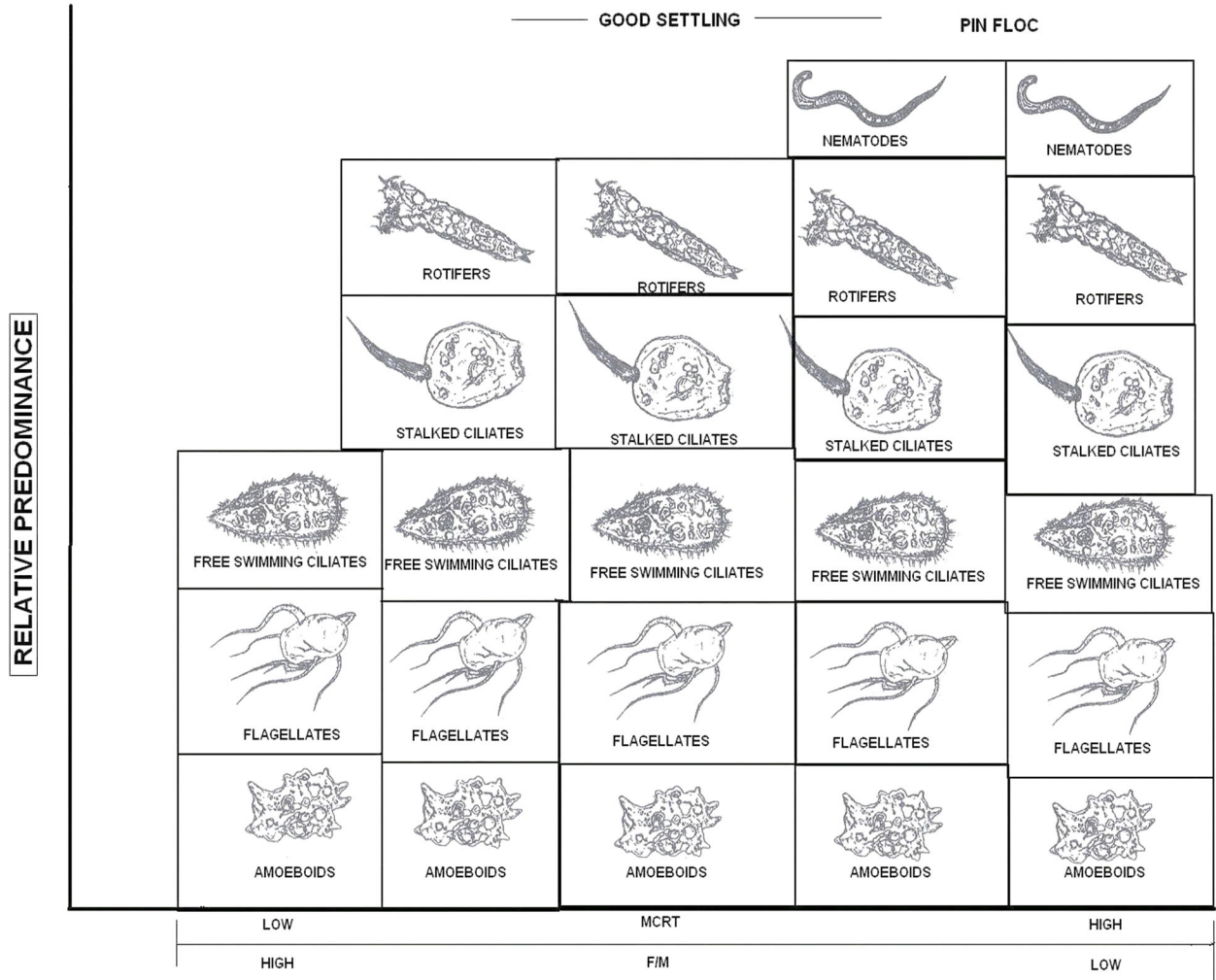

WWT STRAGGLER DIAGRAM

Rotifer - Expanded Explanation

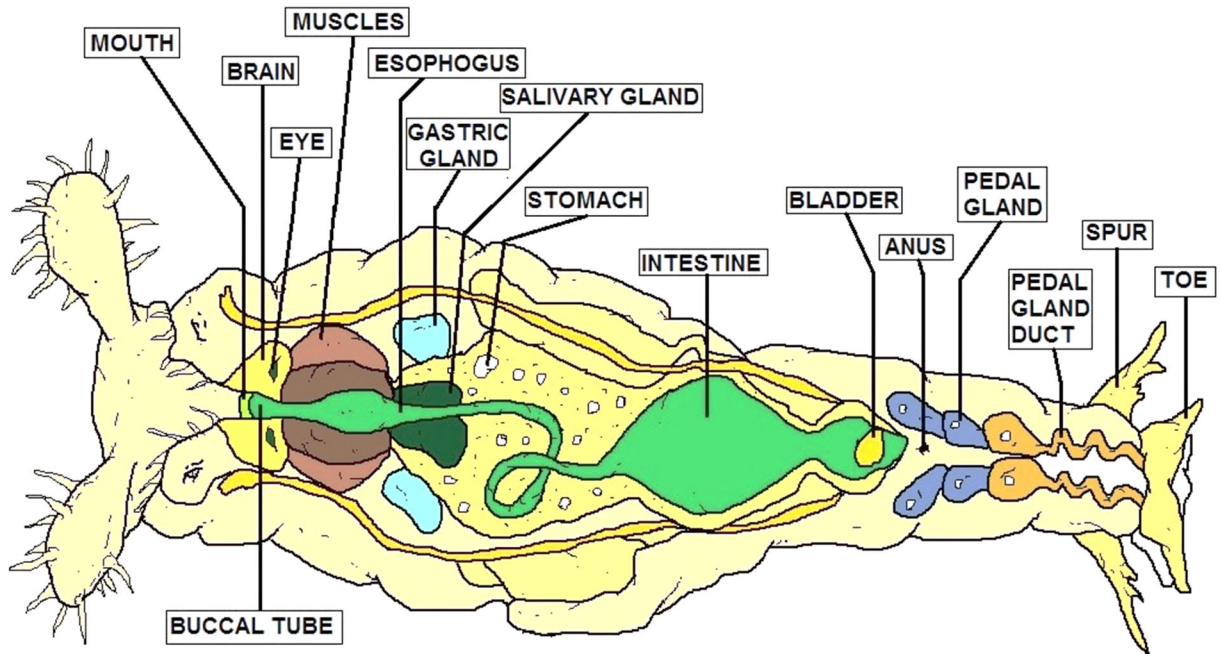

ROTIFER

The rotifers make up a phylum of microscopic and near-microscopic pseudocoelomate animals. They were first described by John Harris in 1696 (Hudson and Gosse, 1886). Leeuwenhoek is mistakenly given credit for being the first to describe rotifers but Harris had produced sketches in 1703.

Most rotifers are around 0.1-0.5 mm long, and are common in freshwater throughout the world, with a few saltwater species. Rotifers may be free swimming and truly planktonic, others move by inch worming along the substrate, whilst some are sessile, living inside tubes or gelatinous holdfasts. About 25 species are colonial (e.g. *Sinantherina semibullata*), either sessile or planktonic.

Rotifers get their name (derived from Greek and meaning "wheel-bearer"; they have also been called wheel animalcules) from the corona, which is composed of several ciliated tufts around the mouth that in motion resemble a wheel. These create a current that sweeps food into the mouth, where it is chewed up by a characteristic pharynx (called the mastax) containing a tiny, calcified, jaw-like structure called the trophi. The cilia also pull the animal, when unattached, through the water.

Most free-living forms have pairs of posterior toes to anchor themselves while feeding. Rotifers have bilateral symmetry and a variety of different shapes.

There is a well-developed cuticle that may be thick and rigid, giving the animal a box-like shape, or flexible, giving the animal a worm-like shape; such rotifers are respectively called loricate and illoricate. Like many other microscopic animals, adult rotifers frequently exhibit eutely - they have a fixed number of cells within a species, usually on the order of one thousand.

Males in the class Monogononta may be either present or absent depending on the species and environmental conditions. In the absence of males, reproduction is by parthenogenesis and results in clonal offspring that are genetically identical to the parent.

Individuals of some species form two distinct types of parthenogenetic eggs; one type develops into a normal parthenogenetic female, while the other occurs in response to a changed environment and develops into a degenerate male that lacks a digestive system, but does have a complete male reproductive system that is used to inseminate females thereby producing fertilized 'resting eggs'.

Resting eggs develop into zygotes that are able to survive extreme environmental conditions such as may occur during winter or when the pond dries up. These eggs resume development and produce a new female generation when conditions improve again. The life span of monogonont females varies from a couple of days to about three weeks.

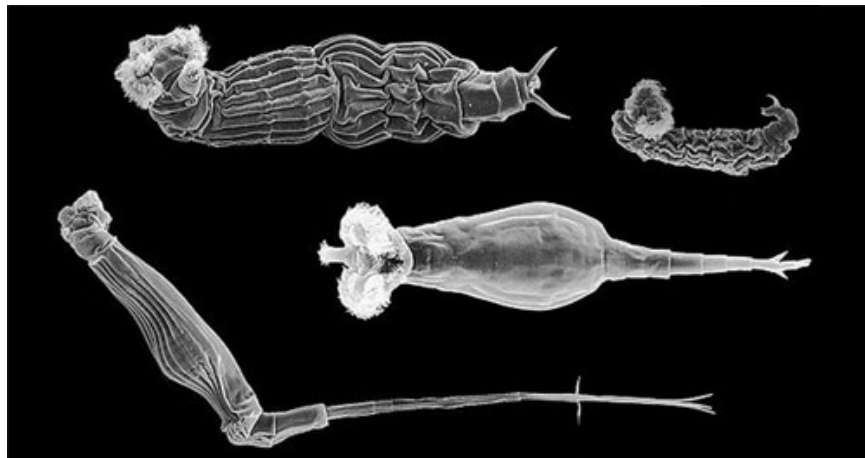

Bdelloid rotifers are unable to produce resting eggs, but many can survive prolonged periods of adverse conditions after desiccation. This facility is termed anhydrobiosis, and organisms with these capabilities are termed anhydrobionts.

Under drought conditions, bdelloid rotifers contract into an inert form and lose almost all body water; when rehydrated, however, they resume activity within a few hours. Bdelloids can survive the dry state for prolonged periods, with the longest well-documented dormancy being nine years.

While in other anhydrobionts, such as the brine shrimp, this desiccation tolerance is thought to be linked to the production of trehalose, a non-reducing disaccharide (sugar), bdelloids apparently lack the ability to synthesize trehalose.

Vorticella - Expanded Explanation

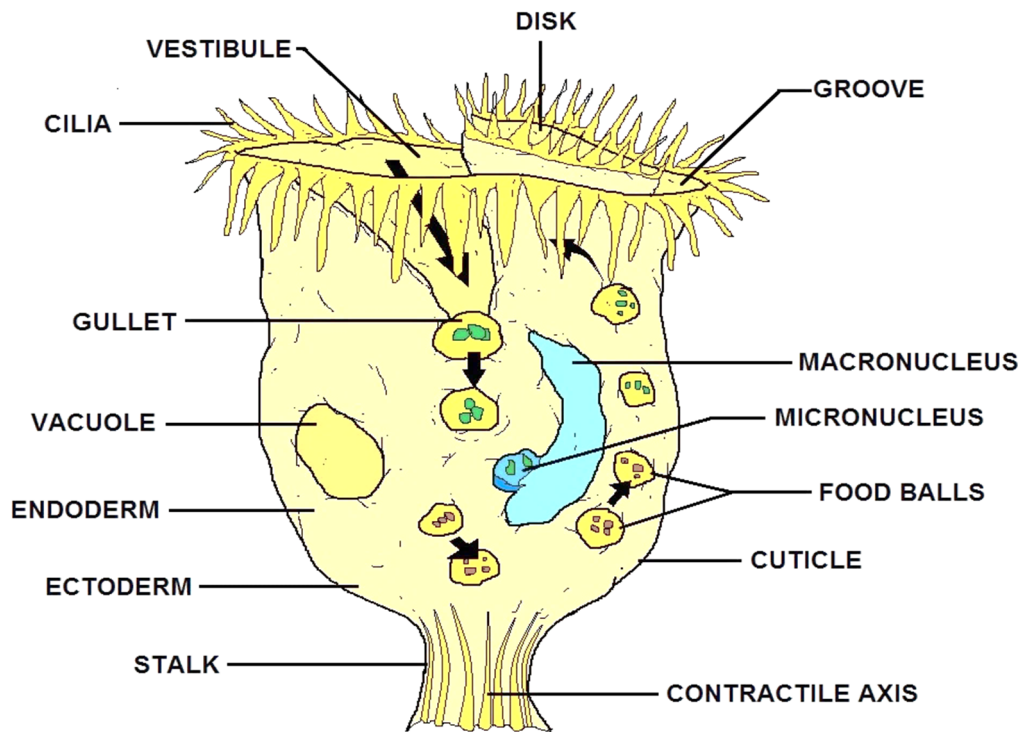

VORTICELLA (TYPE OF PROTOZOAN FOUND IN STAGNANT WATER)

Vorticella is a genus of protozoa, with over 100 known species. They are stalked inverted bell-shaped ciliates, placed among the peritrichs. Each cell has a separate stalk anchored onto the substrate, which contains a contractile fibril called a myoneme. When stimulated this shortens, causing the stalk to coil like a spring.

Reproduction is by budding, where the cell undergoes longitudinal fission and only one daughter keeps the stalk.

Vorticella mainly lives in freshwater ponds and streams - generally, anywhere protists are plentiful. Other genera such as Carchesium resemble Vorticella but are branched or colonial.

Domain: Eukaryota
Phylum: Ciliophora
Class: Oligohymenophorea
Subclass: Peritrichia
Order: Sessilida
Family: Vorticellidae
Genus: Vorticella

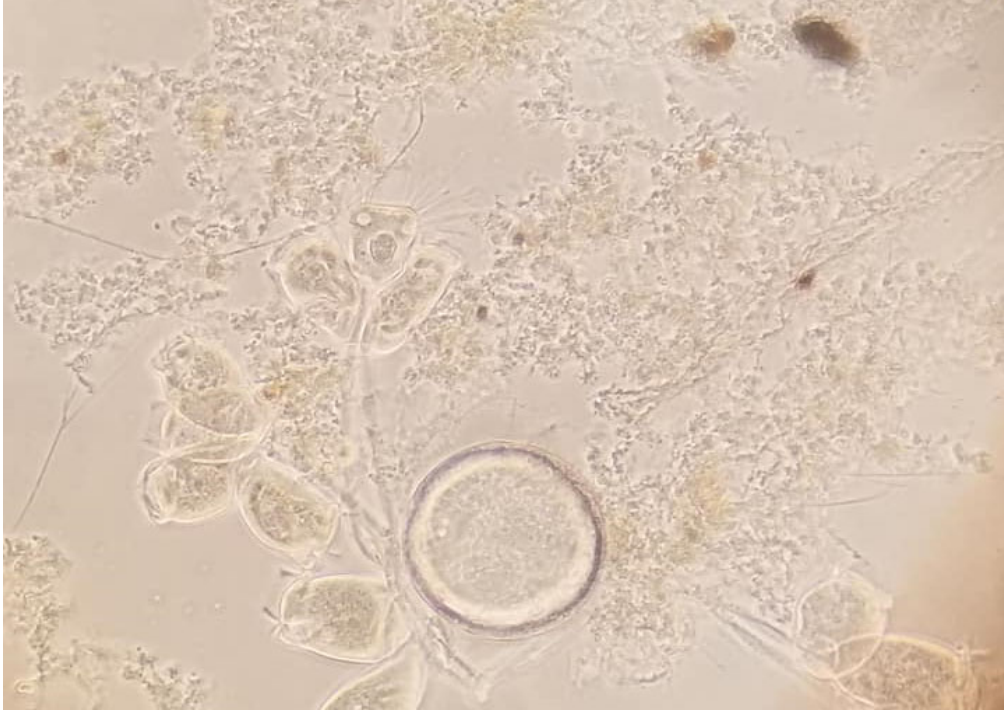

Suctoria between Vorticella



Vorticella

Activated Sludge Aerobic Flocs

Aerobic flocs in a healthy state are referred to as activated sludge. While aerobic floc has a metabolic rate approximately 10 times higher than anaerobic sludge, it can be increased even further by exposing the bacteria to an abundance of oxygen.

Compared to a septic tank, which takes several days to reduce the organic material, an activated sludge tank can reduce the same amount of organic material in approximately 4-6 hours. This allows a much higher degree of overall process efficiency. In most cases, treatment efficiencies and removal levels are so much improved that additional downstream treatment components are dramatically reduced or totally eliminated.

Problems may appear during the operation of activated sludge systems, including:

- High solids content in clarified effluent, which may be due to too high or too low solids retention time and to growth of filamentous microorganisms.
- Rising sludge, occurring when sludge that normally settles rises back to the surface after having settled. In most cases, this is caused by the denitrification process, where nitrate present in the effluent is reduced to nitrogen gas, which then becomes trapped in the sludge causing this to float. This problem can be reduced by decreasing the flow from the aeration basin to the settling tank or reducing the sludge resident time in the settler, either by increasing the rate of recycle to the aeration basin, increasing the rate of sludge collection from the bottom, or increasing the sludge wasting rate from the system.
- Bulking sludge, that which settles too slowly and is not compactable, caused by the predominance of filamentous organisms. This problem can be due to several factors of which the most common are nutrient balance, wide fluctuations in organic load, oxygen limitation (too low levels), and an improper sludge recycle rate.
- Insufficient reduction of organic load, probably caused by a low solids retention time, insufficient amount of nutrients such as P or N (rare in fisheries wastewaters), short-circuiting in the settling tank, poor mixing in the reactor and insufficient aeration or presence of toxic substances.
- Odors, caused by anaerobic conditions in the settling tanks or insufficient aeration in the reactor.

Filamentous Organisms

The majority of filamentous organisms are bacteria, although some of them are classified as algae, fungi or other life forms. There are a number of types of filamentous bacteria which proliferate in the activated sludge process. Filamentous organisms perform several different roles in the process, some of which are beneficial and some of which are detrimental. When filamentous organisms are in low concentrations in the process, they serve to strengthen the floc particles. This effect reduces the amount of shearing in the mechanical action of the aeration tank and allows the floc particles to increase in size.

Larger floc particles are more readily settled in a clarifier. Larger floc particles settling in the clarifier also tend to accumulate smaller particulates (surface adsorption) as they settle producing an even higher quality effluent. Conversely, if the filamentous organisms reach too high a concentration, they can extend dramatically from the floc particles and tie one floc particle to another (interfloc bridging) or even form a filamentous mat of extra-large size.

Due to the increased surface area without a corresponding increase in mass, the activated sludge will not settle well. This results in less solids separation and may cause a washout of solid material from the system. In addition, air bubbles can become trapped in the mat and cause it to float, resulting in a floating scum mat.

Due to the high surface area of the filamentous bacteria, once they reach an excess concentration, they can absorb a higher percentage of the organic material and inhibit the growth of more desirable organisms.

Certain protozoans, such as amoebae and flagellates dominate during a system start-up. Free swimming ciliates are indicative of a sludge of intermediate health and an effluent of acceptable or satisfactory quality.

A predominance of crawling ciliates, stalked ciliates and metazoans is an indicator of sludge with excellent health and an effluent of high quality.



Filamentous Bacteria

Filamentous Bacteria have Positive aspects:

- ✓ They are very good BOD removers.
- ✓ They add a backbone or rigid support network to the floc structure.
- ✓ Helps the floc structure filter out fine particulate matter that will improve clarifier efficiency.
- ✓ They help the floc settle if in small amounts.
- ✓ They reduce the amount of "pin" floc.

Filamentous Bacteria have Negative aspects:

When predominant, they can interfere with separation and compaction of activated sludge and cause bulking.

Filamentous Bacteria:

- ✓ Can affect the sludge volume index (SVI).
- ✓ Can cause poor settling if dominant.
- ✓ Can fill up a clarifier and make it hard to settle, causing TSS carryover.
- ✓ Can increase polymer consumption.
- ✓ Can increase solids production and cause solids handling costs to increase significantly.

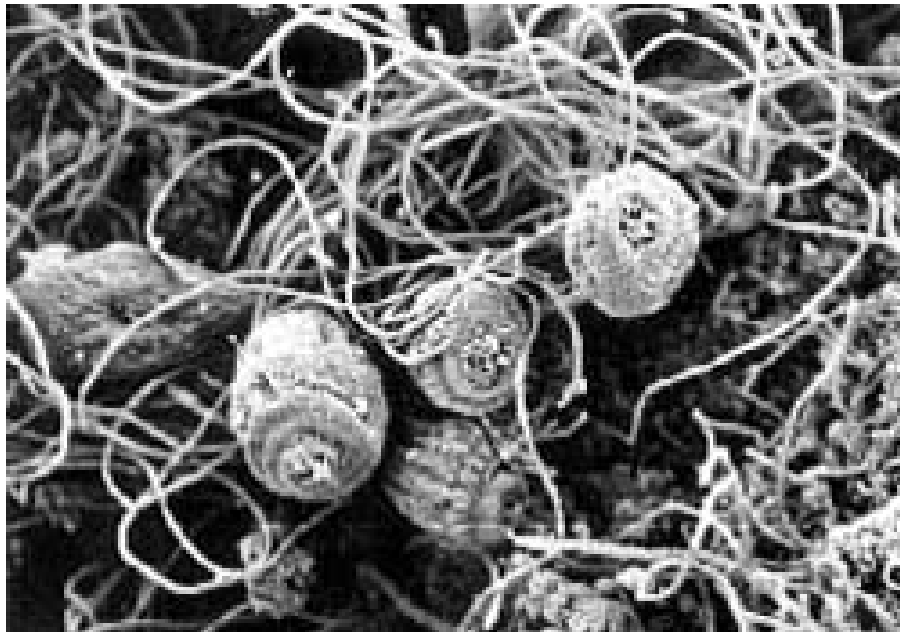

Filamentous bacteria floc (SEM) or Pin Floc.

FILAMENTOUS BULKING PROBLEM

Filamentous bulking can occur within the floc, where weak and diffuse flocs are created, or as filamentous bacteria bridge the flocs. A phase contrast microscope is necessary in situations where inter-floc bulking is occurring to properly view these filaments.

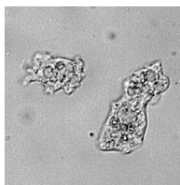

AMOEBAE

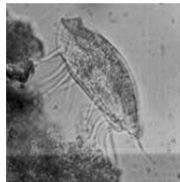

FREE SWIMMING CILIATE



ROTIFER

RETENTION TIME



FLAGELLATE



STALKED CILATES

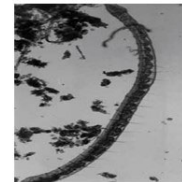

WORM



WASTEWATER INDICATOR ORGANISMS

BULKING

An activated sludge that does not settle well and may overflow the weirs of the final clarifiers resulting in excess suspended solids in the effluent. It is usually caused by filamentous.



Filamentous Bacteria Identification Sub-Section

The activated sludge process was invented around 1914 and is today still the most commonly used biological wastewater treatment process. This widespread use is due to the fact that activated sludge can be a rather easy process to implement and one that can attain high treatment efficiency.

Activated sludge is susceptible to process disturbances making it a very problematic technology for many of its users. Problems arise most when the wastewater to be treated varies significantly in composition and/or flow.

Filamentous Bacteria

A problem that often frustrates the performance of activated sludge is bulking sludge due to the growth of filamentous bacteria. Sludge bulking can often be solved by careful process modifications. However, different filamentous bacteria such as Microthrix, Sphaerotilus, Nostocoida, Thiothrix or "Type 021N" and others cause bulking for very different reasons.

Many filamentous species have not even been given a scientific name yet. Consequently, in order to make the right kind of process modification, knowledge to identify them and experience with the process ecology are required. The potential for instability with activated sludge is an acute problem when strict demands on treatment performance are in place.

Filamentous Identification is a helpful tool to monitor how healthy the biomass is when a filament problem may be suspected. Filamentous Identification also helps to determine the type of filaments present so that we can find the cause and corrections can be made to the process to improve future problems.

All filamentous bacteria usually have a process control variation related with the type of filament present that can be changed depending on the environment condition. Killing the filaments with chlorine or peroxide will temporarily remove the filaments, but that's just a quick fix.

A process change must be made or the filaments will return over time. Find out what filaments are present, find out the cause associated with them and make a process change for a lasting fix to the problems.

Some filaments have more than one version of the filament species, with slightly different characteristics for identification.

- N. Limicola I
- N. Limicola II
- N. Limicola III
- Thiothrix I
- Thiothrix II

Filaments, their causes and suggested controls

Low DO	Control
Type 1701 S. natans	Adjust the aeration rates or F/M (based on aeration solids)
H. hydrossis	Long RAS lines or sludge held too long in the clarifier can sometimes cause the growth of low DO filaments even if the aeration basin DO is adequate.
Waste with limited Nutrients	Control
Thiothrix I & II 021N and N. Limicola III	Nutrient addition BOD ratio of 100:5:1
Low F/M ratios	Control
0041, Nocardia	Use of selector, increase RAS
Type 1851, 0961, 0803, 0675	Increase WAS

Filamentous Identification

Filaments can be internal or external, and they can be free of the floc structures or found intertwined in the floc. Most labs think that filaments need to be extending from the floc in order to be a problem. This is not true.

Internal filaments can cause more problems than external filaments. Think of internal filaments causing a structure like a sponge. It will retain water easily and be harder to dewater, will be hard to compress and will take up more space, thereby increasing solids handling costs.

Filaments present in the system do not always mean there is a problem. Some filaments are good if they form a strong backbone and add a rigid network to the floc. They help give the floc more structure and settle faster.

Filaments are good BOD degraders also. They are only a problem when they become dominant. If filament abundance is in the abundant or excessive range, having a Filamentous Identification performed is recommended.

Let's do a quick review of the Bugs.... We will go much more into detail later...

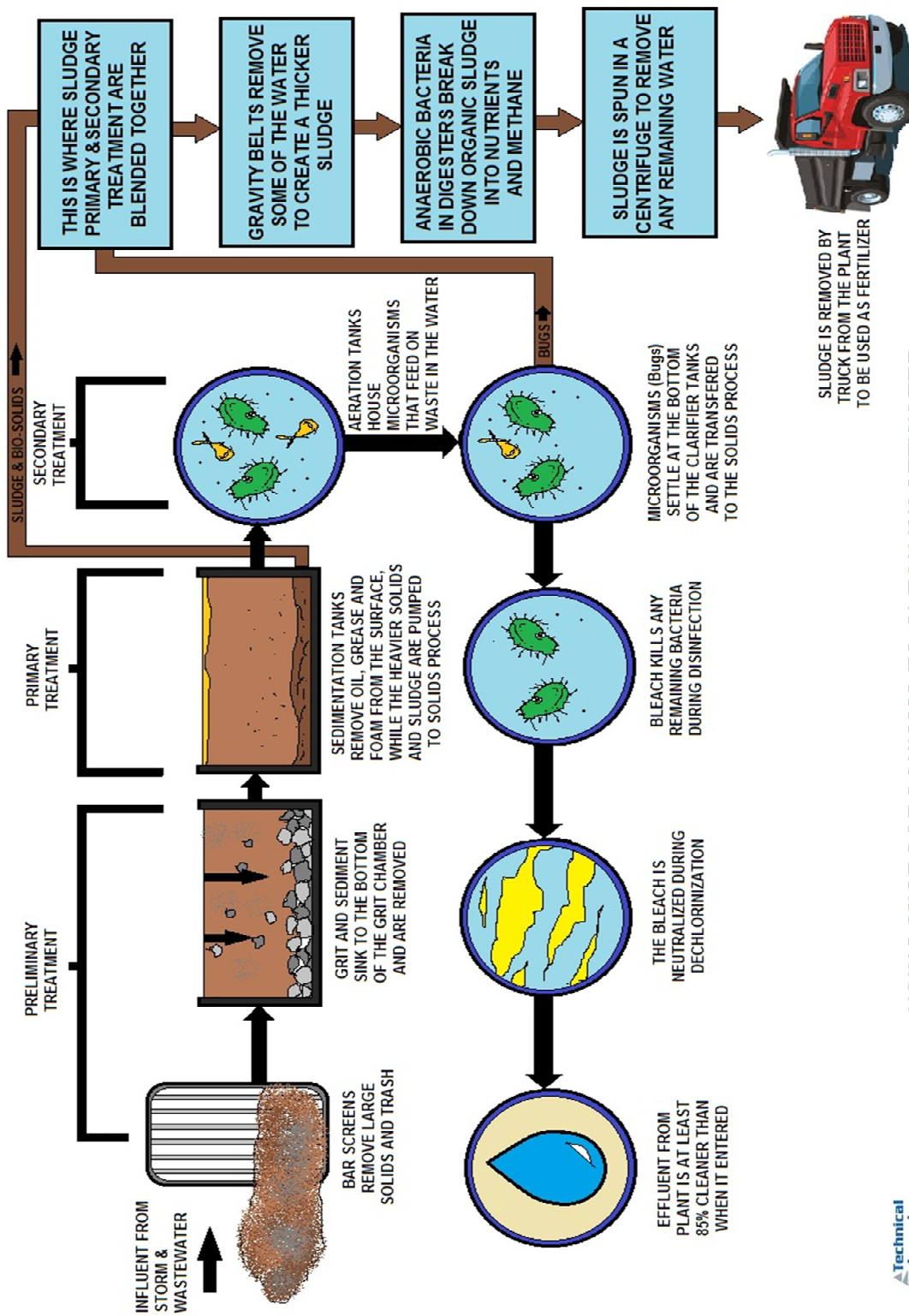

USING MICROORGANISMS TO CLEAN WASTEWATER



Nocardia amarae

Nocardia amarae, a common cause of disruptive foaming in waste treatment plants, is a slow growing, usually gram-positive, chemoautotrophic, filamentous, strict aerobe that produces the biosurfactant trehalose.

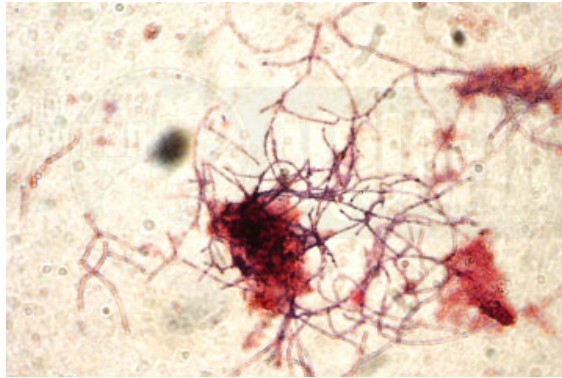

Colonies can be brown, pink, orange, red, purple, gray or white, so color alone is not a key to identifying this species. *N. amarae*, member of the Actinomycetes family, is not motile, so it relies on movement of the water to carry it through the system. It produces catalase, urease and nitrate reductase enzymes, but not casease.

The foam from *Nocardia amarae* is usually a viscous brown color unless algae are entrapped in it, in which case it appears green and brown.

Nostocoida limicola

Nostocoida limicola is yet another common cause of disruptive foaming in waste treatment plants, motile in its Hormogonia and sometimes Trichome phases. This oxygenic phototrophic species often forms a confluent gel encasing flattened discs or large sheets of cells, forming symbiotic relationships with other species. Staining gram-positive, *Nostocoida* produces round cells within tight coil formations.

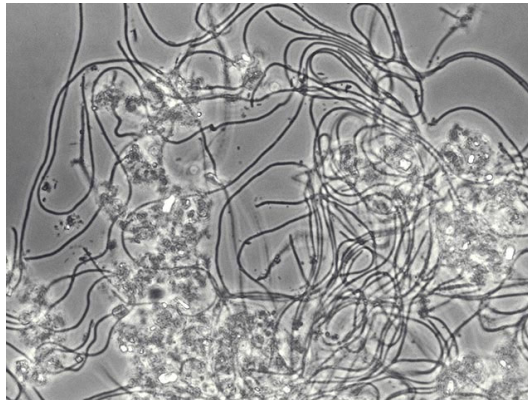

Nostocoida can also be identified by their starburst effect formations using phase contrast microscopy at 400 to 1000x magnification. After chlorination, a few dead cells sticking out identify stress to this species.

Thiothrix

Thiothrix spp. is the second most common cause of disruptive foaming in wastewater treatment plants. It appears as straight to slightly curved cells with rectangular shape form filaments up to 500 microns in length, in multicellular rigid filaments, staining gram-negative, with obligately aerobic respiration.

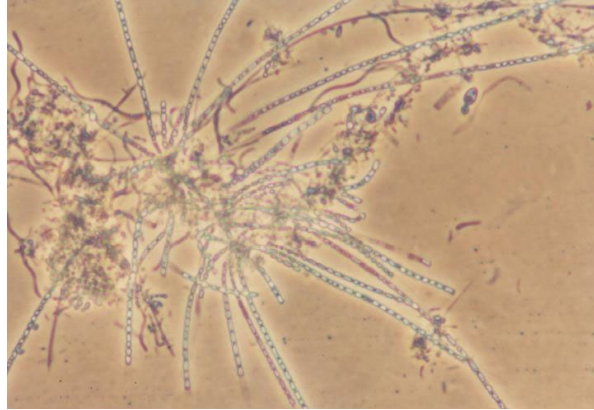

Thiothrix are mixotrophic, using several small organic carbons and reduced inorganic sulfur sources for growth and energy. Thiothrix I is one of the largest filament found using phase contrast microscopy at 400 to 1000x magnification. Thiothrix II produces rectangular filaments up to 200 microns in length and is easily identified by their starburst effect formations using phase contrast microscopy at 400 to 1000x magnification.

Microthrix parvicella

Microthrix parvicella is another common cause of disruptive foaming in waste treatment plants. It producing filaments up to 400 microns in length, easily visualized by phase contrast microscopy at 400x magnification.

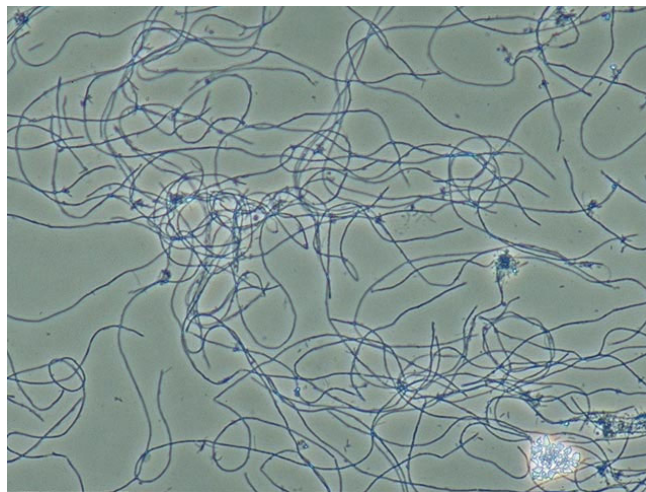

This species is usually found outside floc, tangling with structures in the system, but can also be found hanging out of the floc.

Sphaeroliticus natans

Sphaeroliticus natans is another filamentous species. It is reputed to increase settleability by branching between flocs, increasing surface area. Cells are straight to slightly curved, up to 1000 microns in length and stain gram-negative.

These large cells can be easily visualized by phase contrast microscopy at 100x magnification. Certain conditions favor the proliferation of filamentous species.

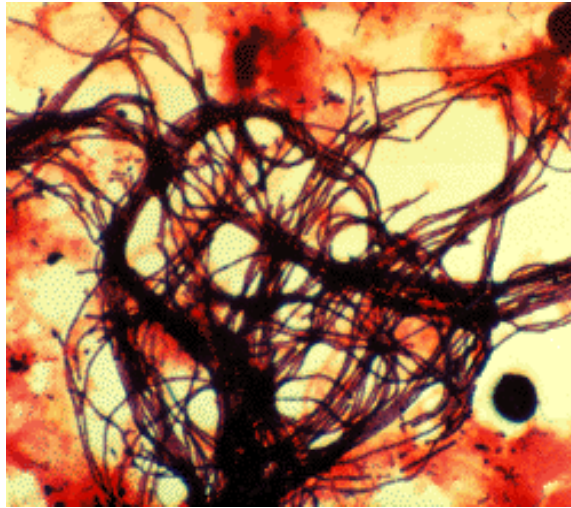

Figure 1. A micrograph of *Microthrix parvicella*, gram stain x 1000

Operating Conditions

A low F/M (food to mass) ratio favors many filamentous organisms, because their higher ratio of surface area to volume provides them with a selective advantage for securing nutrients in nutrient limited environments.

When a plant runs an extremely long sludge age, the slower growing filaments have a better chance to establish a strong colony. As a strict aerobe, high levels of oxygen are necessary to sustain this species. Mesophilic, *Nocardia amarae* thrives in temperatures from 17 to 37 deg. C.

Microthrix is your Enemy - *Get to know it!*

The presence of high levels of fats, oils and greases or hydrocarbons and phenols, can encourage some species, particularly when insufficient levels of nitrogen and phosphorus are present to balance these carbon sources.

If you ever experienced an overgrowth of *Microthrix parvicella* in your activated sludge plant, you will be aware that it can be very difficult to either eradicate or control.

Microthrix is the most common cause of bulking and foaming in activated sludge plants (Rosetti et al. 2002), and it appears either essentially alone or in the company of other filaments.

Microthrix foams appear in many of the photographs of aeration basins and clarifiers I have collected all over the world, and many of the plant tours on the Internet show the same brown stable scums associated with this organism.

Microthrix fits into the filamentous bacterial classification of low F/M, which means that it tends to appear in plants with long sludge ages. Lackay *et al.* (1999) suggested that *M. parvicella* and its low F/M compatriots *Haliscomenobacter hydrossis*, and types 0092, 0041, 1851, 0803 were also encouraged to the point of maximum proliferation by alternating anoxic-aerobic conditions (particularly 30-40% aerobic and 60-70% anoxic) but any alternation of anoxic-aerobic conditions may cause a problem in single reactor, two reactor, or multireactor systems in which nitrate and/or nitrite are present throughout the anoxic period, or in the anoxic reactor just prior to the aerobic reactor. Modern plants incorporating denitrification and/or phosphorus removal are obvious candidates for bulking and foaming due to *Microthrix*.

Figures 1 and 2 show typical views of *Microthrix* by using light microscopy and scanning electron microscopy, respectively. It is not difficult to recognize using standard staining and microscopy, giving a positive response to Gram stain and being of fairly easily recognized morphology (Seviour *et al.* 1999). Of all the filaments creating difficulties in activated sludge plants, it is one of the most easily recognized, but there is a commercial test kit available which uses fluorescent situ hybridization (or "FISH") to permit visual identification should one feel the need.

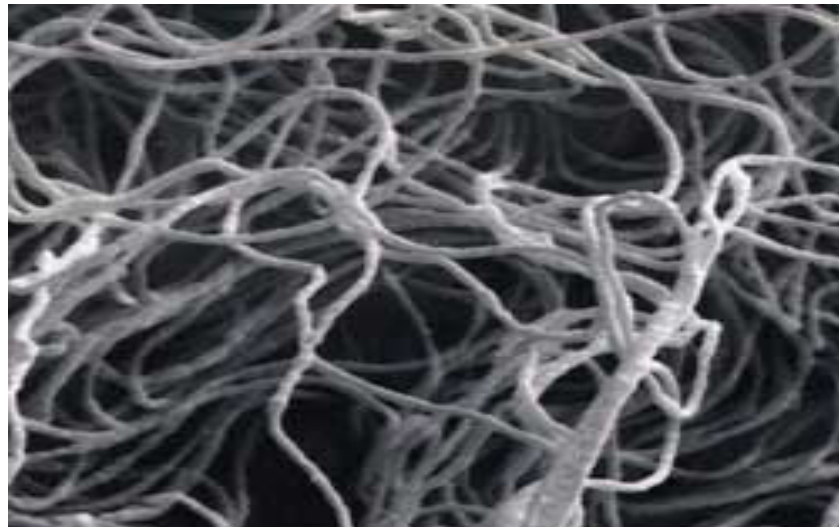

Figure 2. A scanning electron micrograph of *Microthrix parvicella*

The design of plants can play a significant part in the proliferation of scums and foams. There are many common mistakes in plant design which assist organisms like *Microthrix* by retaining floating masses in dead areas of the plant which have very high MCRT values and continuously reseed the biomass, (Pitman 1996). These should obviously be avoided (Figs 3, 5 and 6) or corrected.

Poor mixing, poorly designed and inadequate aeration systems, cyclic overloading and low process D.O. levels can also contribute to the creation of anoxic and anaerobic zones in what are supposed to be aeration basins.

Current Remedial Techniques

Jenkins *et al.* (1993) presented sludge chlorination as a method of choice in the United States to combat filamentous bulking due to any organism. The success of treatment of *Microthrix* in mixed liquor or foams is poor, due it is believed to resistant filamentous bacteria with hydrophobic cell walls such as *M. parvicella* and *Nostocoida limicola*.

Lakay *et al.* (1988) obtained only a partial elimination of *Microthrix parvicella* bacteria at a high chlorine dose. Hwang and Tanaka found in batch tests that *M. parvicella* remained intact at very high chlorine doses, while the microbial flocs were completely destroyed. Saayman *et al.* (1996) examined the use of non-specific chemical treatment in a BNR plant and assessed the effects of biomass settling characteristics and other operational parameters.

While chlorine use was the most effective, it was reported to damage the biomass and cause difficulties in the P removal process when dosed at high levels. Ozone and peroxide were less effective in treating settling problems but less of a problem to the biomass.



Figure 3. Dry *Microthrix parvicella* foam trapped in an anoxic zone of a BNR plant aeration basin.

In recent times, the introduction of selectors has been hailed as a major initiative in the control and elimination of filamentous bacteria (bulking and foaming) and the maintenance of moderate biomass SVIs.

The performance of selectors in controlling low F/M filaments has been described as both controversial and ambiguous. In the Netherlands, despite incorporating over 80 selectors in full-scale plants; the percentage of plants with bulking associated with *Microthrix parvicella* was unchanged. Other experiences with the aerobic selector showed only little success in controlling the growth of *M. parvicella* in the presence of long chain fatty acids (LCFA), (Lebek and Rosenwinkel, 2002) and a comparison of anoxic selectors at five plants in the US has demonstrated that performance and effectiveness varied significantly (Marten and Daigger, 1997).

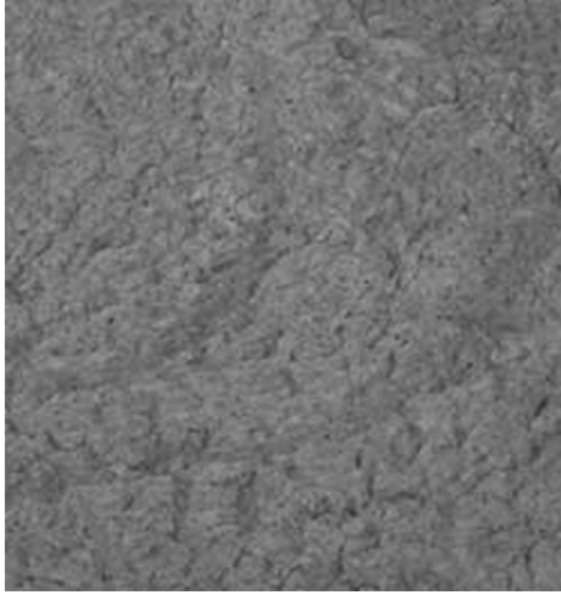

Figure 4. Typical dark brown *Microthrix parvicella* foam

Microthrix Capabilities

Mamais *et al.* 1998 examined the effect of factors such as temperature, substrate type (easily biodegradable in the form of acetate and slowly biodegradable in the form of oleic acid) on *Microthrix parvicella* growth using complete mix with and without selectors (anoxic and anaerobic) and plug flow reactors. The results indicate that low temperatures and substrates in the form of long chain fatty acids favor the growth of *M. parvicella*.

The plug flow configuration was shown to be quite effective in controlling the growth of *M. parvicella* and producing a sludge with good settling characteristics, while the presence of a selector, either anoxic or anaerobic, had no significant effect on the growth of *M. parvicella*. Maintenance of low sludge ages (5) days has also been reported to eliminate *M. parvicella* because it is a slow growing organism, but this is not always operationally possible.

While it is often convenient to group filaments together, it does appear the *Microthrix* has received special attention because of its ability to proliferate. More selective investigation of *Microthrix* has indicated that it has quite well defined requirements. The nature of *Microthrix* is such that it has the capability of using long chain fatty acids (LCFA) (oleic acid) and their esters (triglycerides of palmitic and stearic acid) (fats and oils) as sources of carbon and energy.

Lipids and LCFA are present in all domestic wastewater streams and often constitute a significant part of it. Values of 25-35% of the incoming COD have been reported, and it can support a substantial biomass production in a treatment plant. LCFA are generally easily consumed in activated sludge, and the consumption rate of LCFA under aerobic or anoxic conditions has been found to be rapid.

Studies indicate that *M. parvicella* consumes exclusively long chain fatty acids (LCFA), and that it is able to take up LCFA not only under aerobic, but also under anaerobic and anoxic conditions (Andreasen, K. and Nielsen, P.H. (2000)).

It has been reported that *M. parvicella* is able to out-compete other bacteria particularly well in alternating anaerobic-aerobic and anoxic activated sludge systems. This ability is based on a high uptake and storage capacity for LCFA under anaerobic conditions and a subsequent use of the stored substrate for growth with oxygen (or nitrate) as electron acceptor.

Rosetti *et al.* (2002) carried out an extensive examination of *M. parvicella* and found that it was a very versatile organism that could store organic carbon under anaerobic conditions using stored polyphosphate for energy (like the organisms responsible for phosphorus removal). Once exposed to aerobic conditions it would recover rapidly and resume growing. *Microthrix* has a high storage capacity under all operating conditions (anaerobic, anoxic and anaerobic). It has a high "substrate affinity" or low K_s , which means it competes well at low substrate concentration.

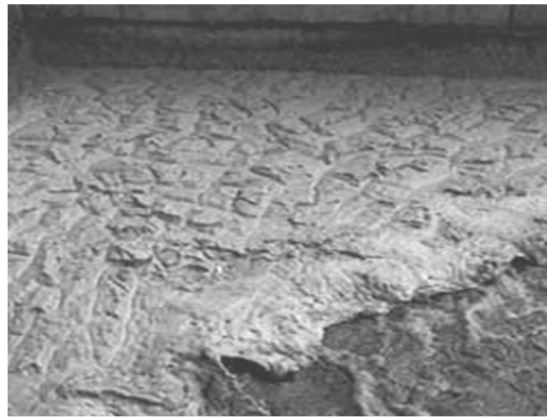

Figure 5. *Microthrix parvicella* foam trapped near a mechanical aerator.

Most interestingly, *M. parvicella* has a maximum growth rate near 22° C, zero growth rate at 30° C and is capable of quite reasonably large growth rates at as low as 7° C which gives it a significant advantage in the competition with floc formers during winter in cold climates.

PAX vs. *Microthrix parvicella*

Microthrix parvicella is well-equipped to survive, compete and dominate in all kinds of activated sludge systems. With all of the above in mind, it is pleasing to find that *Microthrix* does have a weakness. That weakness is its apparent sensitivity to poly aluminum chloride (PAX) dosing, which seems to attack the ability of *Microthrix parvicella* to use lipids by reducing the activity of extracellular enzymes (lipases) on the surface of the organism rendering the organism relatively uncompetitive (Nielsen *et al.* 2003).

Roels *et al.* (2002) reported a loss of surface scum following PAX-14 dosing which was probably due to a loss of hydrophobicity. Full-scale dosages of PAX-14 range from 1.5 to 4.5 g Al^{3+} /kg MLSS/day depending on the sludge retention time (SRT); the lower the SRT, the higher the dosage, although certainly lower than 7 g Al^{3+} /kg MLSS. Roels *et al.* (2002) offered the following empirical formula to establish the dose:

$$60/SRT = \text{\#g of } Al^{3+}/\text{kg MLSS}$$

They also recommended the removal of the scum layer before dosing to allow the concentration and time of dosage to be kept at a minimum. Removal of the floating sludge layer from the surface before starting PAX application was necessary to ensure specific and rapid impact of Al-salts on *M. parvicella*.

In fact, the stable floating sludge represents an independent microbial system, into which aluminum can penetrate only at a limited extent. Dosage should be combined with high oxygen concentration in the aeration (i.e. above 2.5 mg/L) and the MLSS concentration low (i.e. under 2.5 g/L) since *M. parvicella* competes well at low oxygen levels.



Figure 6. A heavy build-up of trapped *Microthrix parvicella* foam during winter.

Of note was that the morphological properties of only *Microthrix parvicella* changed, apparently leaving the other filaments remaining unaffected.

Paris *et al.* (2003) came to a similar conclusion; by dosing AlCl_3 ($3.5 \text{ mg mgAl}^{3+} \text{ gMLSS/d}$), a general improvement of the settling properties of the activated sludge was achieved. As the filamentous population of activated sludge and the occurrence frequency of *M. parvicella* dropped, a decrease of hydrophobicity and floating tendency of activated sludge was observed. With low hydrophobicity the sludge does not tend to float. This has significant relevance for any measure to prevent floating foams.

It was observed that by adding PAX a morphological modification of the filamentous bacterium *M. parvicella* occurs. The morphological modification is probably the reason why the hydrophobic property of the filaments decreases. Paris *et al.* (2003) included

micrographs which indicated that the *Microthrix parvicella* appeared to shorten in length after dosing (Figure 7) and no longer inhabit the zones between flocs.



Figure 7. An typical view of *Microthrix parvicella* (gram stain x 1000) after extended PAX treatment.

Summary

The overall lesson is that scum layer removal is necessary to effectively treat and remove *Microthrix*. Plant designs that eliminate the accumulation of scum will have a better chance of avoiding a *Microthrix* proliferation.

PAX Treatment

PAX (or PAX-14 or polyaluminium chloride) used for *Microthrix* control is a flocculant or coagulant commonly used in water and wastewater treatment. The 14 or other number associated with the name refers to the particular grade of the chemical.

Nielsen *et al.* (2003) report that PAX-14 is $\text{Al}_{13}\text{O}_4(\text{OH})_{24}(\text{H}_2\text{O})_{12}^{7+}$ and it is produced from $\text{Al}(\text{OH})_3$ at high temperature and high pressure. PAX-14 and 18 are being used in several countries with good success for controlling *M. parvicella* - in particular Denmark where PAX-14 has been applied successfully in treatment plants with biological N and/or P removal for 91 out of 500 plants in 2002.

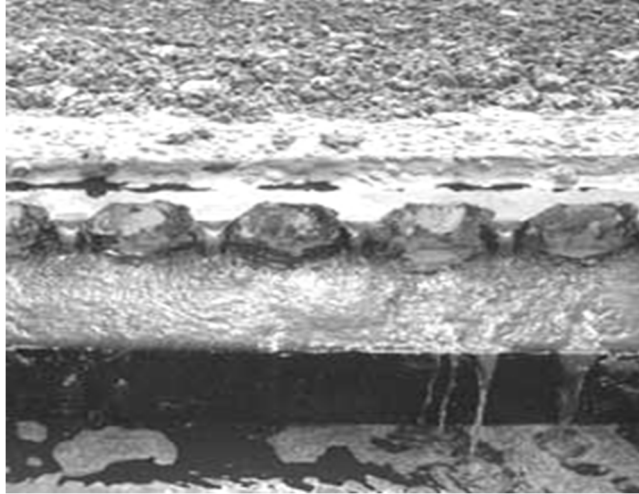

Figure 8.

Foam build-up in a secondary clarifier resulting in solids loss and turbid effluent.

Dosage: 0.5-1.5g Al/kgSS/day usually added to return sludge. PAX should be dosed continuously over the treatment period at the chosen level.

Proposed Treatment Regime

In the fall, dosing may prevent the normal appearance of *M. parvicella* during the coming winter and to control problems with *M. parvicella* (winter, spring).

Removal of floating sludge before and during dosing is recommended. Microscopic examination of the biomass and regular testing of biomass settling is also a very good idea and the dosing at the chosen remedial rate until a target SVI or preferably DSVI is reached should be the rule.

It is not yet fully clear why PAX has the effect that it does, but the research continues. It is known that other Al salts have little effect on surface associated enzymes after 15 min, and no effect on surface hydrophobicity and surface associated enzymes.



Old mixed liquor. The dark color is an indicator of old bugs or upset.

Sphaerotilus natans

Description and Significance

Sphaerotilus natans is a filamentous bacterium that is covered in a tubular sheath and can be found in flowing water and in sewage and wastewater treatment plants. While this bacterium sometimes clogs pipes and causes other similar problems, it does not cause major threat to wastewater treatment plants nor is it known to be pathogenic.

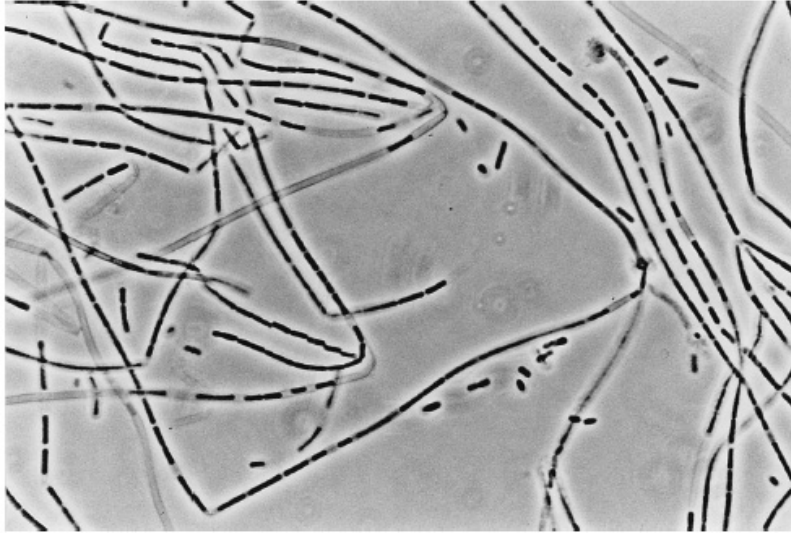

Long unbranched and ensheathed filaments produced by *Sphaerotilus natans* IF4.

Sphaerotilus natans has relatively long, non-motile filaments (100-1000 μm). They can be straight or smoothly curved with tree-like false branching. The cells are round-ended and rod shaped (1.0-1.8 x 1.5-3.0) and are contained in a clear, tightly fitting sheath. They can be rectangular when the cells are tightly packed within the sheath. The cell septa are clear and easily observable with indentations.

Filaments radiate outward from the floc surface into the bulk solution and can cause sludge settling interference by inter-floc bridging. The filament is usually Gram negative and Neisser negative. There are no sulfur granules. Poly- β -hydroxybutric acid (PHB) is frequently observed as dark intracellular granules. In wastewater that is nutrient deficient, an exocellular slime coat may be present. Attached growth is usually uncommon, but may occur when at low growth rate.

This filament is usually found in environments where there is low DO or low nutrients (N or P).

Control

RAS chlorination can be used to get rid of the filaments but process changes should also be made. Cell lysis occurs readily on this type of filament, although the empty sheaths still remain. Sludge wasting is necessary to remove them entirely from the system.



Manipulation of F/M and DO concentration can be used to control the filaments. Nutrient deficient wastes can be checked by effluent values of residual NH_3 and o-PO_4 and should be supplemented if necessary.

Nostocoida limicola I and II

Nostocoida limicola I is a bent and highly coiled filament. *N. limicola* has cells that are oval (0.6-0.8 μm wide) but are found to be closer to each other and the cell septa are almost indiscernible. The length of the filament can range from 100 to 200 μm and the majority of the time the trichome is found within the floc. *N. limicola* has no sheath and attached growth is rare. It stains Gram positive and Neisser positive.

***Nostocoida limicola* II Identification**

Medium length, non-motile filaments (100-200 μm). Bent and irregularly coiled filaments with incidental true branching. Knots sometimes seen. Cell septa are clear with indentations. Cells are oval or disc shaped (1.2-1.4 μm). Filaments are found within the floc structure but may occur in the bulk solution. The filament staining is variable, it is usually Gram negative but sometimes positive and Neisser positive.



Usually easy to identify due to its Neisser staining properties. Stains entirely purple and looks like stacked discs (or hockey pucks). In industrial wastes, an organism that is Gram negative and Neisser negative occurs. There is no sheath and there are no sulfur granules. Poly- β -hydroxybutric acid (PHB) granules are frequently observed as dark intracellular granules. Attached growth is usually uncommon. Three subtypes are known. Resembles *M. parvicella* except in its Neisser staining properties.

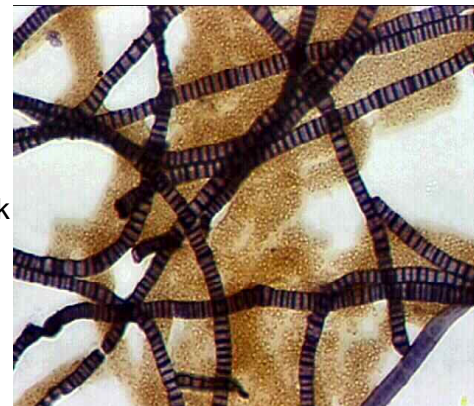

Environment

This filament is usually found in environments where there is low DO or low F/M and the presence of organic wastes. Wastes containing starch seem more selective to this filament. Bulking is more common in industrial wastes. The filament appears to be facultative fermentative, which is unique for most filaments.

Control

Manipulation of F/M (usually an increase) and increased DO concentration can be used to control the filaments. A selector may be used and chlorination. System changes include changing from a complete mix to plug flow aeration basin configuration.

N. limicola ranks 12th in number of predominance in industry. Typically not found in kraft mills. Common in municipalities.

Thiothrix I & II

Thiothrix species consist of two types of Thiothrix and they are Thiothrix I and Thiothrix II. Thiothrix filaments are straight or slightly curved with Thiothrix I having an overall length of 100-500 μm and individual cells having a rectangular shape (1.4-2.5 x 3-5 μm). Thiothrix II has total length varying from 50-200 μm and its cells are rectangular (0.8-1.4 x 1-2 μm).

Both types of Thiothrix are found stretching from the floc surface, there is a noticeable septa between cells. Both species are Gram negative and Neisser negative with cells that on occasions have sulfur granules. There are additional structures on Thiothrix trichomes and they include apical gonidia as well as rosettes and a sheath is present, incidental attached growth may be observed. A holdfast may add to the characteristic of radiating out from a common center, the "starburst effect".



Relatively large, non-motile filaments (100-500 μm). Straight or smoothly curved filaments with no branching. Cells are rectangular (1.4 x 2.5 μm) and a clear cell septa is present without indentations at the septa. Filaments are found radiating outwards from the floc structure causing inter-floc bridging.

The filament staining is Gram negative or Gram variable when sulfur granules are present and Neisser negative with Neisser positive granules observed frequently.

Exhibits bright sulfur granules in the presence of sulfides under phase contrast (use the S-test). Poly- β -hydroxybutric acid (PHB) is frequently observed as dark intracellular granules. No attached growth when extending into the bulk solution. Can form rosettes and the filaments can have gonidia on the tips. Rosettes are when many filaments radiate outward from a common origin. Prominent heavy sheath. Easy to identify due to its large size.

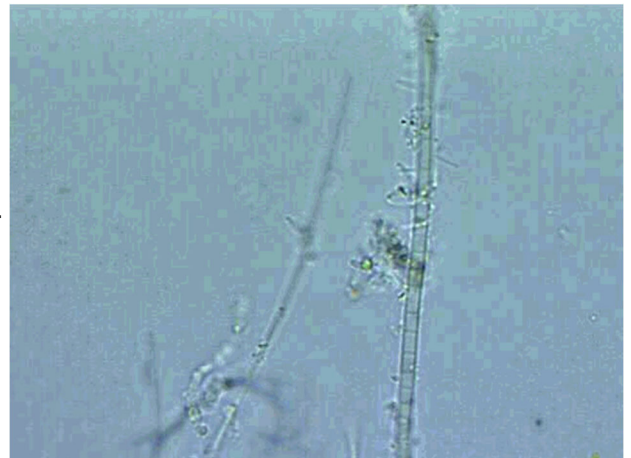

Similar Organisms

Type 021N is similar when in the bulk solution and with no attached growth, although Type 021N has no sheath.

Environment

This filament is usually found in environments where there are limited nutrients (N or P). It can also be found in wastes containing specific compounds with sulfides and/or organic acids or environments with low DO. It is sometimes found in plants with high pH in the aeration system.



Thiothrix II



Filaments are found radiating outwards from the floc structure causing inter-floc bridging. The filament staining is Gram negative or Gram variable when sulfur granules are present and Neisser negative with Neisser positive granules observed frequently. Exhibits bright sulfur granules in the presence of sulfides under phase contrast (use the S-test). Can form rosettes and the filaments can have gonidia on the tips. Rosettes are when many filaments radiate outward from a common origin. Prominent heavy sheath. Easy to identify due to its large size. Sheath can be Gram or Neisser positive when heavy slime is present due to nutrient deficiency or septicity.

Conditions Associated with Filament Growth in Activated Sludge (Jenkins et al., 2004; Richard, 2003)

Filament Type	Causes Foaming	Causes Slow Bulking	Low DO	High Sludge Age	Low F/M	High Organic Acids	Fat, Oil and Grease (FOG)	Septicity (H2S)	Nutrient Deficiency		Low pH (less than 6.5)
									N	P	
<i>Beggiatoa spp.</i>		X						X			
Fungi		X									X
<i>Haliscomenobacter hydrossis</i>			X						X		
<i>Microthrix parvicella</i>	X	X		X			X				
<i>Nostocoida limicola I</i>						X		X			
<i>Nostocoida limicola II</i>						X		X			
<i>Nostocoida limicola III</i>						X		X	X		
<i>Nocardioforms</i>	X						X				
<i>Sphaerotilus natans</i>		X	X						X		
<i>Thiothrix I</i>		X				X		X	X		
<i>Thiothrix II</i>		X				X		X	X		
Type 0041		X		X	X						
Type 0092		X		X		X		X			
Type 021N		X				X		X	X		
Type 0411		X				X		X			
Type 0581		X		X		X		X			
Type 0675		X		X	X						
Type 0803		X		X	X						
Type 0914		X		X		X		X			

Type 0961		x				x		x	
Type 1701		x	x						
Type 1851		x		x	x				
Type 1863	x	x					x		
Actinomycetes		x							

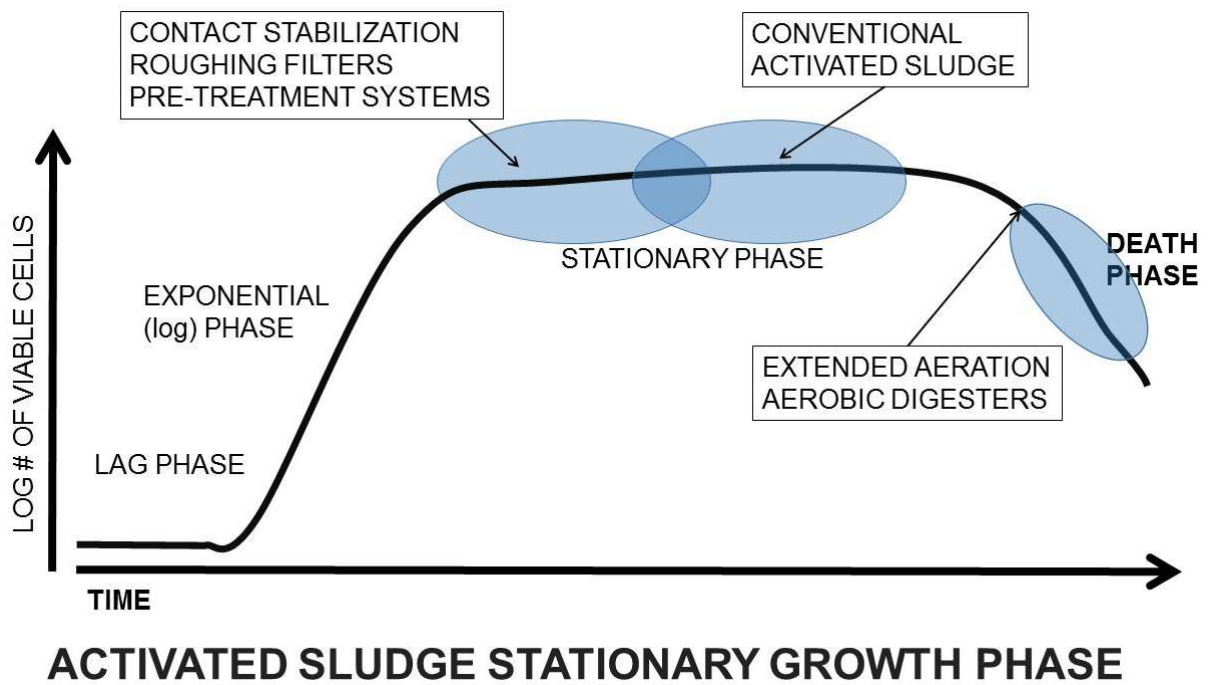

Biological Criteria Sub-Section

Introduction

Many types of microscopic plants and animals, such as plankton, water beetles, and insects that live in or on the water, serve as food for small fish. Small fish are eaten by larger fish which, in turn, are consumed by even larger fish. These large fish may ultimately be consumed by humans. All life along the food chain is dependent on the water environment and it is for this reason that the quality of the nation's surface waters must be protected.

The Clean Water Act directs the EPA to develop criteria for water quality that accurately reflect the latest scientific knowledge about the effects of pollutants on aquatic life and human health.

In developing these criteria, the EPA examines the effects of specific pollutants on plankton, fish, shellfish, wildlife, plant life, aesthetics, and recreation in any body of water. This includes specific information on the concentration and dispersal of pollutants through biological, physical, and chemical processes as well as the effects of pollutants on biological communities as a whole.

States may use the criteria that are developed by the EPA to help set water quality standards that protect the uses of their waters or they may develop their own stricter water quality criteria. The EPA publishes human health and aquatic life criteria and is currently developing sediment and biological criteria. These criteria are complementary; each is designed to protect specific types of living organisms or ecological systems from the adverse effects of pollution.

Human Health Criteria

People can potentially be exposed to water pollutants when they drink untreated surface water or eat fish, shellfish, or wildlife that have been contaminated by pollutants in surface waters. To reduce the risk to humans from these sources, the EPA scientists research information to determine the levels at which specific chemicals are not likely to adversely affect human health.

The EPA publishes these levels as human health criteria that the states use, along with other information, to set allowable concentrations of pollutants in their water quality standards. In this way, the EPA and the states work together to protect people from exposure to harmful pollutants in surface waters.

Aquatic Life Criteria

Aquatic life criteria provide protection for plants and animals that are found in surface waters. The EPA develops these criteria as numeric limits on the amounts of chemicals that can be present in river, lake, or stream water without harm to aquatic life.

Aquatic life criteria are designed to provide protection for both freshwater and saltwater aquatic organisms from the effects of acute (short term) and chronic (long term) exposure to potentially harmful chemicals.

Aquatic life criteria are based on toxicity information and are developed to protect aquatic organisms from death, slower growth, reduced reproduction, and the accumulation of harmful levels of toxic chemicals in their tissues that may adversely affect consumers of such organisms.

Sediment Quality Criteria Guidance

In a healthy aquatic community, sediments provide a habitat for many living organisms. Worms, plants, and tiny microorganisms living in or on the sediment sustain the fish and shellfish that, in turn, nourish larger fish, wildlife, and humans.

Pollutants in the Sediment

Controlling the concentration of pollutants in the sediment helps to protect bottom dwelling species and prevents harmful toxins from moving up the food chain and accumulating in the tissue of animals at progressively higher levels. This is particularly important to control at the lower levels of the food chain because the concentration of many pollutants may increase at each link in the food chain. A pollutant level in the sediment that does not harm snails or small fish may bioaccumulate in the food chain and become very harmful to larger fish, birds, mammals, wildlife, and people.

The EPA develops sediment quality criteria guidance on the concentrations or amounts of individual chemicals that can be present in river, lake, or stream sediments and still protect sediment-dwelling organisms and ultimately animals higher in the food chain from the harmful effects of toxic pollutants.

Biological Criteria

A water body in its natural condition is normally free from the harmful effects of pollution, habitat loss, and other negative stressors. It is characterized by a particular biological diversity and abundance of organisms. This biological integrity--or natural structure and function of aquatic life--can be dramatically different in various types of water bodies in different parts of the country. Because of this, the EPA has developed methodologies that states can use to assess the biological integrity of their waters and, in so doing, set protective water quality standards. These methodologies will describe scientific methods for determining a particular aquatic community's health and for maintaining optimal conditions in various bodies of water.

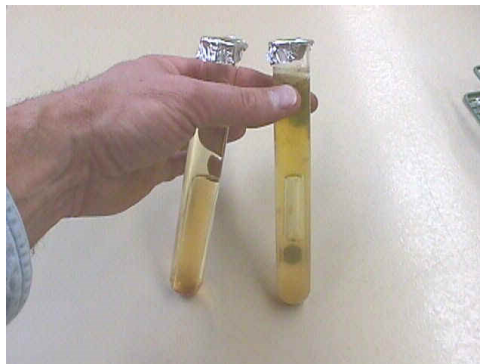

Standard Total Coliform Fermentation Technique

(We will cover the fecal test in the Laboratory procedures).

Treatment Goal Summary

The goal of all biological wastewater treatment systems is to remove the non-settling solids and the dissolved organic load from the effluents by using microbial populations. Biological treatments are generally part of secondary treatment systems. The microorganisms used are responsible for the degradation of the organic matter and the stabilization of organic wastes. With regard to the way in which they utilize oxygen, they can be classified into aerobic (require oxygen for their metabolism), anaerobic (grow in absence of oxygen) and facultative (can proliferate either in absence or presence of oxygen by using different metabolic processes).

Most of the microorganisms present in wastewater treatment systems use the organic content of the wastewater as an energy source to grow, and are thus classified as heterotrophes from a nutritional point of view. The population active in a biological wastewater treatment is mixed, complex and interrelated.

Biologic Diversity

In a single aerobic system, members of the genera *Pseudomonas*, *Nocardia*, *Flavobacterium*, *Achromobacter* and *Zooglea* may be present, together with filamentous organisms (*Beggiatoa* and *Sphaerotilus* among others).

In a well-functioning system, protozoas and rotifers are usually present and are useful in consuming dispersed bacteria or non-settling particles. More extensive description and treatment of the microbiology of wastewater treatment systems are given elsewhere (Stanier, 1976).

The organic load present is incorporated in part as biomass by the microbial populations, and almost all the rest is liberated as gas (carbon dioxide (CO₂) if the treatment is aerobic, or carbon dioxide plus methane (CH₄) if the process is anaerobic) and water. In fisheries wastewaters the non- biodegradable portion is very low.

Unless the cell mass formed during the biological treatment is removed from the wastewater (e.g., by sedimentation or other treatment described in the previous section), the treatment is largely incomplete, because the biomass itself will appear as organic load in the effluent and the only pollution reduction accomplished is that fraction liberated as gases.

The biological treatment processes used for wastewater treatment are broadly classified as aerobic in which aerobic and facultative microorganisms predominate or anaerobic which use anaerobic microorganism.

If the microorganisms or bugs are suspended in the wastewater during biological operation, the operations are called "suspended growth processes", while the microorganisms that are attached to a surface over which they grow are called "attached growth processes".

Credit to the USEPA for text.

WASTEWATER FOOD

Incoming wastewater to a treatment plant provides the food that microorganisms need for their growth and reproduction. This food is mostly organic material. The more soluble the organic material is, the more easily microorganisms can use it. Since the amount and type of organic loading in the treatment plant affects the growth of the microorganisms, influent total BOD and soluble BOD are measurements an operator can make to determine the amount and type of incoming food for the microorganisms.



ACTIVATED SLUDGE MICROORGANISMS

The principle role microorganisms have in the activated sludge process is to convert dissolved and particulate organic matter, measured as biochemical oxygen demand (BOD), into cell mass. In a conventional activated sludge process, microorganisms use oxygen to break down organic matter (food) for their growth and survival. Over time and as wastewater moves through the aeration basin, food (BOD) decreases with a resultant increase in cell mass (MLSS concentration).



Microlife Food to Mass (F/M and MCRT)

We talked about the basic components and designs of wastewater treatment now let's look at the main "Team Players". Your process will respond to whatever direction you give it. You can run your plant (the team) to always try for the better or be content with the way it is. To get the best, it takes work!

Most activated sludge processes are used to degrade carbonaceous BOD. It is also possible to design and/or operate the basic system to oxidize ammonia (nitrification).

Many plants are now designed to achieve nitrification. Other system modifications include phosphorus removal and biological denitrification. Activated sludge plants are usually designed from pilot plant and laboratory studies.

From this approach, it is possible to design a process based on the amount of time the sludge spends in the system, generally termed mean cell residence time (MCRT), or on the amount of food provided to the bacteria in the aeration tank (the food-to-microorganism ratio, F/M). What does this mean?

Suppose a person ate 10 pounds of hot dogs (BOD) and weighed 200 pounds (MLSS).

What is the ratio of food to weight?

It would be 10 lbs. to 200 lbs. If we divide 200 into 10, the ratio is .05 or 5%.



Activated Sludge Aeration Basin, identified by the bubbles.

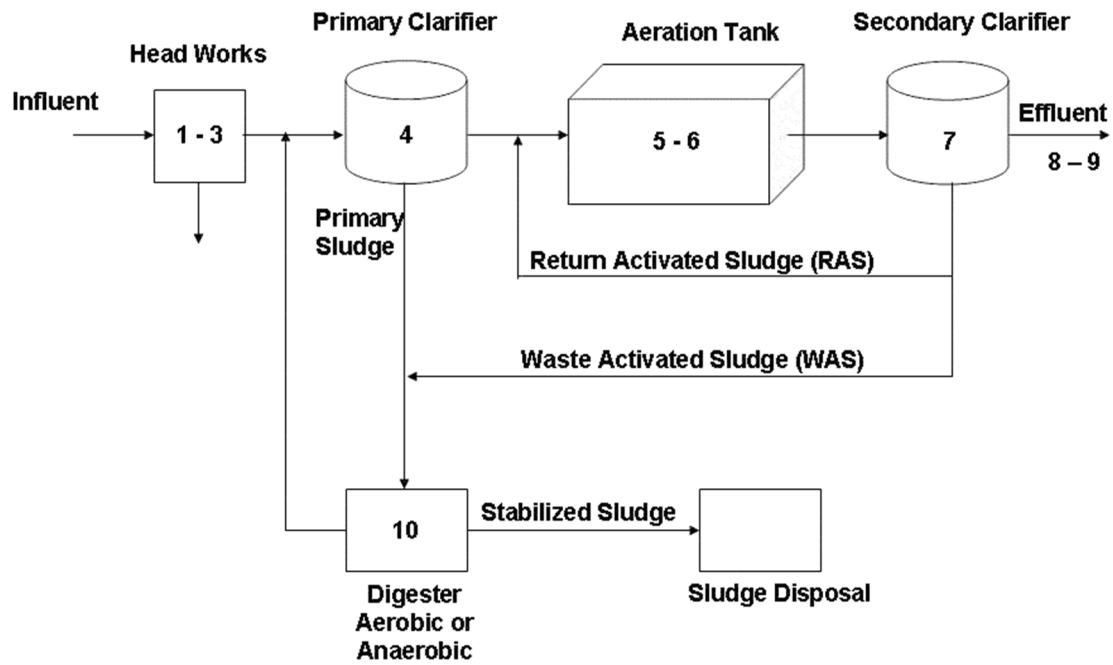

Microlife's health is essential for the proper operation of box 5, 6, 7 and 10. Box 4 is for settling of the solids.

F/M RATIO

The food to mass or microorganism (F/M ratio) is a process control number that helps to determine the proper number of microorganisms for your system. To do this calculation, you will need the following information: Influent Flow into the activated sludge system (Flow MGD) Influent CBOD (mg/l), and concentration in the aeration tank MLSS and it's volume.

F/M and MCRT Statements

The following are some general statements about F/M and MCRT assuming that the environmental conditions are properly controlled.

- a. The optimum operating point of either helps obtain the desired effluent concentration from a particular WWTP.
- b. Both provide a means for maintaining the best effluent and sludge quality.
- c. Both techniques attempt to regulate rate of growth, metabolism, and stabilization of food matter.
- d. Both techniques indicate the solids level needed to stabilize the food and attain sludge quality.
- e. The desired solids level is controlled by wasting.
 1. To maintain – waste amount is stable.
 2. To increase – decrease waste rate
 3. To decrease – increase waste rate
- f. They are interrelated so changing one control generally changes the other.
- g. Once the control point is set, it should remain constant until change in effluent, weather, influent, or sludge quality requires a change.

The operating control point is that point when the best effluent and sludge quality is obtained for the existing conditions.

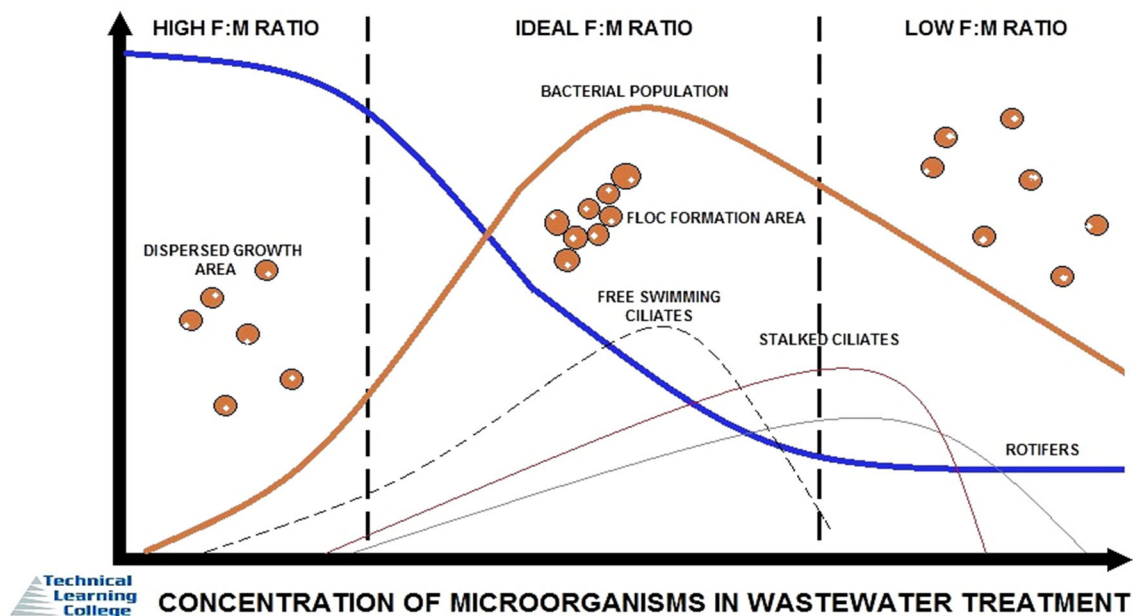

The principle role microorganisms have in the a/s process is to convert dissolved and particulate organic matter, measured as biochemical oxygen demand (BOD) into cell mass. In a conventional activated sludge process, microorganisms use oxygen to break down organic matter (food) for their growth and survival. Over time and as wastewater moves through the aeration basin, food (BOD) decreases with a resultant increase in cell mass (MLSS concentration).

Food to Microorganism Ratio Calculations

The F/M ratio is a process control number that helps you to determine the proper number of microorganisms for your system.

To do this calculation, you will need the following information:

- Influent Flow into your activated sludge system (Flow MGD)
- Influent CBOD (mg/l) concentration into your aeration tank.
- Mixed Liquor Volatile Suspended Solids Concentration (mg/l)
- Volume (in gallons) of your aeration system

The term Food to Microorganism Ratio (F/M) is actually a measurement of the amount of incoming food (lbs. of Influent CBOD) divided by the lbs. of microorganisms in your system. Some calculations also include the volume of activated sludge in your clarifiers; the one demonstrated here does not. If you have an activated sludge system, you should determine your F/M ratio regularly.

To determine the amount of incoming food (**F**), you need to know the CBOD of the influent into your activated sludge (aeration) system. You also need to know the flow (MGD). To calculate the amount of food we do the following calculation:

$$\mathbf{F \text{ (lbs/day)} = \text{Influent Flow (MGD)} \times \text{Influent CBOD Concentration (mg/l)} \\ \times 8.34 \text{ lbs/gal.}}$$

To determine the volume of microorganisms (**M**), you need to know the volume of your aeration system and you need to know the concentration of Volatile Solids in your aeration system (MLVSS) or Mixed Liquor Volatile Suspended Solids.

To calculate the microorganisms, we do the following calculation:

$$\mathbf{M \text{ (lbs)} = \text{Aeration System Volume (in Millions of Gallons)} \times \text{MLVSS} \times 8.34 \text{ lbs./gal.}}$$

To Calculate the Ratio: F/M

Example:

$$\text{Facility Flow} = 1.2 \text{ MGD} \quad \text{Influent CBOD} = 230 \text{ mg/l} \\ 1.2 \times 230 \times 8.34 = 2300 \text{ lbs. coming In/day}$$

$$\mathbf{F = 2300}$$

$$\text{Aeration System Volume } 250,000 \text{ gal} / 1,000,000 = 0.25 \text{ MG} \\ \text{MLVSS} = 2500 \text{ mg/l} \\ 0.25 \times 2500 \times 8.34 = 5200 \text{ lbs. of microorganisms under aeration}$$

$$\mathbf{M = 5200}$$

$$\mathbf{2300 \div 5200 = 0.44 \text{ F/M Ratio}}$$

Note that we have done some reasonable rounding because an implied accuracy down to the hundredth or thousandth is not realistic or even helpful to us.

F/M Guidelines

Food to microorganism ratio (F/M) is a common used parameter in the activated sludge process which is defined as the kg of BOD₅ applied per kg MLSS per day.

- F/M ratio $< 0.5 \text{ day}^{-1}$ has a good settleability of sludge. (in some cases it can go to 1)
- F/M ratio < 0.2 Food has very limited food so the bacteria could die.
- F/M ratio $> 0.5 \text{ day}^{-1}$ Food is more than needed so the bacteria will move the effluent (failure of the system)
- High F/M ratio some filamentous bacteria will also grow. They not settle easily because of long tails getting entangled with each other.

Derivation of F/M Ratio:

Q = Flow of Sewage (m^3/day)

BOD = organic matter (mg/l)

FOOD = $Q (\text{m}^3/\text{day}) \times \text{BOD} (\text{mg}/\text{l})$

FOOD = $Q \times \text{BOD} / 1000$ (Kg of BOD/ day)

V = Volume of Aeration (m^3)

MLSS = Mixed liquor suspended solids (mg/l)

Microorganisms = $V (\text{m}^3) \times \text{MLSS} (\text{mg}/\text{l}) / 1000 = V \times \text{MLSS} / 1000$ (kg of MLSS in aeration tank)

MIXED LIQUOR DEFINITION

Mixed liquor suspended solids (MLSS) is the concentration of suspended solids in an aeration tank during the activated sludge process, in the treatment of wastewater. Mixed liquor is a combination of raw or unsettled wastewater and activated sludge within an aeration tank. The solids are comprised of biomass, nonbiodegradable volatile suspended solids (nbVSS), and inert inorganic total suspended solids (iTSS).

MLSS

Mixed Liquor Suspended Solids (MLSS) is the total suspended solids in a sample of mixed liquor. The units MLSS is primarily measured in are milligrams per liter (mg/L). This test is essentially the same as the test performed for TSS in the last lab, except for the use of mixed liquor as the water sample. In addition, the concentration of suspended solids found in the mixed liquor is much greater than that found in the raw or treated water. MLSS concentrations are usually greater than 1,000 mg/L, but should not exceed 4,000 mg/L.

MLVSS

Mixed Liquor Volatile Suspended Solids is generally defined as the microbiological suspension in the aeration tank of an activated-sludge biological wastewater treatment plant. The biomass solids in a biological waste water reactor are usually indicated as total suspended solids (TSS) and volatile suspended solids (VSS). The mixture of solids resulting from combining recycled sludge with influent wastewater in the bioreactor is termed mixed liquor suspended solids (MLSS) and mixed liquor volatile suspended solids (MLVSS).

MIXED LIQUOR ADJUSTMENT

If content is too high

1. The process is prone to bulking of solids and the treatment system can become overloaded.
2. This can cause the dissolved oxygen content to drop; this may reduce the efficiency of nitrification and the settleability of the sludge.
3. Excessive aeration will be required, which wastes electricity.
4. It can create a thick foam on the upper layer of the aeration tank.

If content is too low

1. The process may not remove sufficient organic matter from the wastewater.
2. The sludge age may be too low to enable nitrification.
3. The mixed liquor sludge may not settle and concentrate well.

The typical control band for the concentration of MLSS is 2 to 4 g/L for conventional activated sludge, or up to 15 g/l for membrane bioreactors.

(Note: 1g/L = 1000 mg/L)

Mean Cell Residence Time (MCRT)

MCRT is an expression of the average time (days) that a microorganism will spend in the activated sludge process.

Operators can calculate the total suspended solids (TSS) in the Activated Sludge Process, lbs. (kg), by three different methods:

1. TSS in the Aeration Basin or Reactor Zone, lbs. (kg)
2. TSS in the Aeration Basin and Secondary Clarifier, lbs. (kg)
3. TSS in the Aeration Basin and Secondary Clarifier Sludge Blanket, lbs. (kg)

These variations make it difficult to compare MCRTs in days among different plants unless everyone uses the same method. Stick with one method that is most effective and sensible for your plant.

Solids Retention Time (SRT)

SRT is sometimes used as a synonym for MCRT. These generally mean the same thing, but they may be calculated using different pieces of data. SRT can be viewed as the total mass of the solids in the treatment system, whereas MCRT is the mass of the bacteria in the system.

SRT can also be expressed in days. In essence, MCRT would be calculated with the volatile suspended solids (VSS) values (for example, mixed liquor VSS, effluent VSS, and waste sludge VSS).

SRT would be calculated using the total suspended solids (TSS) values (for example, mixed liquor TSS, effluent TSS, and waste sludge TSS).

Solids Retention Time (SRT) is a critical activated sludge design and operating parameter. The selection of an SRT has many consequences related to process performance, sludge production, and oxygen requirements.

DSRT is the acronym for dynamic solids retention time.

MLVSS

Mixed Liquor Volatile Suspended Solids is generally defined as the microbiological suspension in the aeration tank of an activated-sludge biological wastewater treatment plant.

The biomass solids in a biological waste water reactor are usually indicated as **total suspended solids (TSS)** and **volatile suspended solids (VSS)**. The mixture of solids resulting from combining recycled sludge with influent wastewater in the bioreactor is termed **mixed liquor suspended solids (MLSS)** and **mixed liquor volatile suspended solids (MLVSS)**. The solids are comprised of biomass, **nonbiodegradable volatile suspended solids (nbVSS)**, and inert **inorganic total suspended solids (iTSS)**.



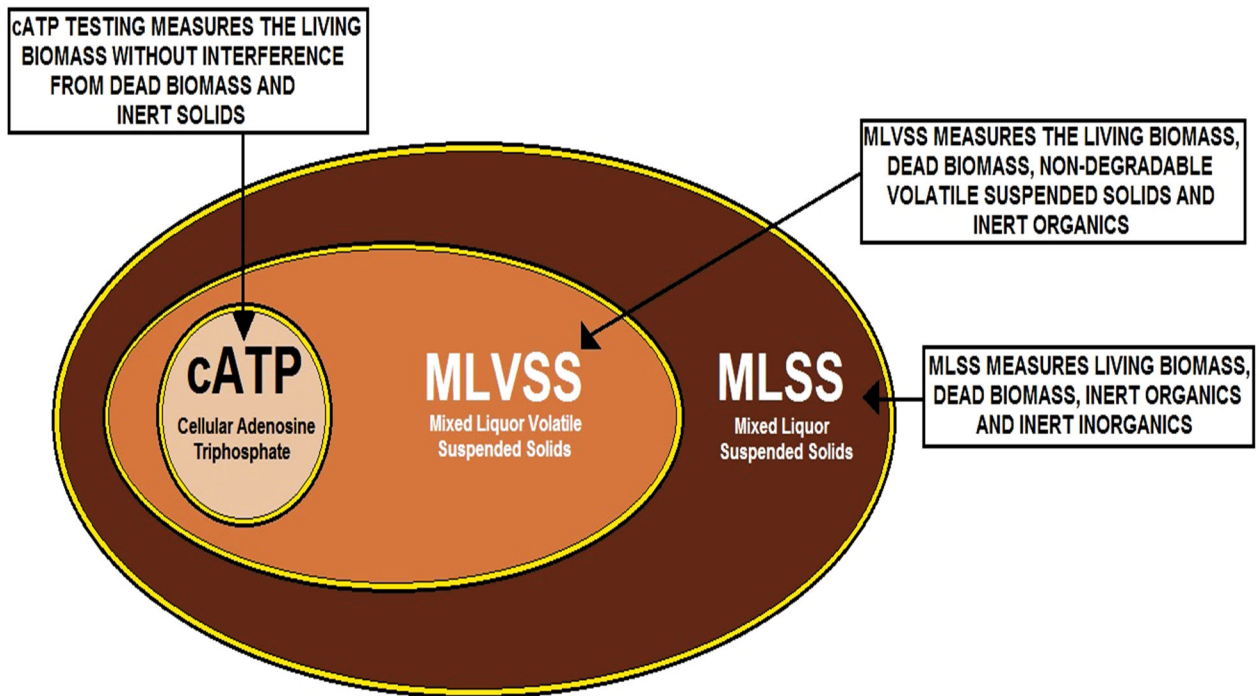

COMPARATIVE WASTEWATER TESTING

ATP and MLSS

Conventional wastewater measurements such as mixed-liquor suspended solids (MLSS) or mixed liquor volatile suspended solids (MLVSS) can provide misleading information about the amount of viable biomass in the reactors.

The reason is that these measurements do not distinguish between living and dead cells. Because ATP is produced only by living cells, its measurement can overcome these difficulties and provide an opportunity for superior control of such fundamental operating issues such as food to microorganism ratio, sludge age, and nutrient feed.

Although ATP is vital to all wastewater treatment microorganisms and the measurement process described is simple, ATP has not been routinely adopted as a process parameter in operating wastewater treatment plants. Possible reasons for lack of routine use include the following:

- Instability of reagents;
- Ineffective or cumbersome ATP extraction techniques for wastewater treatment samples;
- Lack of test protocols optimized for wastewater treatment applications;
- Insufficient monitoring guidelines.

Dissolved Oxygen Concentrations Introduction

We will cover DO and MCRT in greater detail in the Laboratory Section

Dissolved oxygen concentrations may be measured directly in wastewater, but the amount of oxygen potentially required by other chemicals in the wastewater is termed as oxygen demand.

Dissolved or suspended oxidizable organic material in wastewater is used as a food source by mixed liquor bugs.

Oxygen is needed by living organisms as they oxidize their food to obtain energy for growth. Therefore, controlling oxygen is required for secondary or biological treatment of wastewater.

Indicators of low dissolved oxygen conditions include substantial presence of low dissolved oxygen filamentous bacteria in the activated sludge, turbid effluent, or dark gray or black-colored mixed liquor (often with a putrid odor).

The first indicator of low dissolved oxygen conditions will be the growth of low dissolved oxygen filamentous microorganisms.

As the dissolved oxygen drops, the quantity of these filamentous microorganisms increases, adversely affecting the settle-ability of the activated sludge.

As an operator, it is important to recognize these early warning signs and make corrections to dissolved oxygen levels before the quality of the effluent deteriorates.

If dissolved oxygen continues to drop, even low dissolved oxygen filamentous microorganisms will not be present in the mixed liquor, and treatment efficiencies will be seriously affected. At this point, effluent turbidity will increase and treatment will deteriorate rapidly.

Under severe conditions, mixed liquor may turn a dark gray or even black color and putrid odors may also be present.

Visual observations are good as indicators, but actual measurements of both activated sludge dissolved oxygen and effluent water quality should be taken before a determination of cause is made. For example, the black color may be the result of a dye from an industrial discharger.

The key to avoiding low dissolved oxygen conditions is to properly monitor your aeration system.

A properly monitored aeration system includes a dissolved oxygen profile of the entire aeration system. A profile merely means measuring the dissolved oxygen in different locations and at different depths throughout the aeration system.

Oxygen Requirements

There are three different environments that can be present in wastewater treatment process: aerobic (oxic), anoxic, and anaerobic.

Aerobic environments contain DO and may or may not contain nitrite or nitrate.

Anoxic environments contain nitrite and/or nitrate, but do not contain DO.

Anaerobic environments do not contain DO, nitrite or nitrate. The presence or absence of oxygen, nitrite and nitrate influences which bacteria are active and how they process their fuel.

CHEMICAL OXYGEN DEMAND (COD)

Oxidizable materials introduced into water will similarly initiate chemical reactions to create what is measured in the laboratory as the chemical oxygen demand (COD).

BIOCHEMICAL OXYGEN DEMAND (BOD)

Biochemical Oxygen Demand, also called Biological Oxygen Demand, is the amount of dissolved oxygen needed by aerobic biological organisms to break down organic material present in a given water sample at certain temperature over a specific time period. The BOD value is most commonly expressed in milligrams of oxygen consumed per liter of sample during 5 days of incubation at 20°C. It is often used as a measure of the degree of organic pollution in water.

Wastewater Microbiology Section Post Quiz

True or False

1. Actively growing bacteria eat food at a rapid rate therefore using oxygen at a rapid rate. The rate of oxygen use is normally termed the Oxygen Uptake Rate and is measured in mg O₂/hr/gm of MLSS. True or False
2. As bacteria first begin to develop in the system, they grow in large clumps and chains. They are not very active with flagella and have a well-developed slime layer. True or False
3. Aerobic bacteria require at least 0.1 - 0.3 mg/L of oxygen to survive. At least 2 mg/L of oxygen must be maintained in the bulk fluid in order for the bacteria in the center of the floc to get 0.1- 0.3 mg/L of oxygen. True or False
4. Mixing is never required to bring the bacteria, oxygen and nutrients in contact with each other. True or False
5. Bacteria require basic nutrients for growth (carbon, nitrogen, phosphorus as well as trace amounts of sodium, potassium, magnesium and iron. All these are present in normal domestic sewage. True or False
6. The bacteria have an interesting property; their "fat reserves" are stored on the outside of their bodies. This fat layer is sticky and is what the organics adhere to. True or False
7. Once the bacteria have "contacted" their food, they start the digestion process. True or False
8. In wastewater treatment, this process of using bacteria-eating bugs in the presence of oxygen to reduce the organics in water is called "Oxidation". True or False
9. As the bugs "bump" into each other, the fat on each of them slides off and causes flocculation of the organic solids and biomass. True or False
10. Paramecium is a medium to large size (100-300 μm) swimming ciliate, commonly observed in activated sludge, sometimes in abundant numbers. The body is either foot-shaped or cigar-shaped, and somewhat flexible. True or False
11. Euglypha swims with a smooth gliding motion. It may also be seen paired up with another Paramecium makes a good diagnostic key. True or False

12. Vorticella is a stalked ciliate. There are at least a dozen species found in activated sludge ranging in length from about 30 to 150 μm . True or False
13. Vorticella are oval to round shaped, have a contractile stalk, a domed feeding zone, and a water vacuole located near the terminal end of the feeding cavity. True or False
14. Euglypha primarily eats viruses. True or False
15. Shelled amoebas are common in soil, treatment plants, and stream bottoms where decaying organic matter is present. They adapt to a wide range of conditions and therefore are not good indicator organisms. True or False
16. Euchlanis is a swimmer, using its foot and cilia for locomotion. In common with other rotifers, it has a head rimmed with cilia, a transparent body, and a foot with two strong swimming toes. True or False
17. Euchlanis is an omnivore, meaning that its varied diet includes detritus, bacteria, and small protozoa. Euchlanis has a glassy shell secreted by its outer skin. The transparent body reveals the brain, stomach, intestines, bladder, and reproductive organs. True or False
18. A characteristic of rotifers is their mastax, which is a jaw-like device that grinds food as it enters the stomach. True or False
19. Rotifers have a circulatory system. True or False
20. Euchlanis is never found in activated sludge when effluent quality is good. It requires a continual supply of dissolved oxygen, evidence that aerobic conditions have been sustained. True or False

Wastewater Microbiology Section Post Quiz Answers

1. True, 2. False, 3. True, 4. False, 5. True, 6. True, 7. True, 8. False, 9. False, 10. False, 11. False, 12. True, 13. True, 14. False, 15. False, 16. True, 17. True, 18. True, 19. False, 20. False

Topic 7 -Wastewater Sampling Section

Section Focus: You will learn the basics of the wastewater sampling program, rules, and sampling procedures. At the end of this section, you will be able to describe various sampling regulations and sampling procedures. There is a post quiz at the end of this section to review your comprehension and a final examination in the Assignment for your contact hours.

Scope/Background: The sampler should be thoroughly familiarized with existing safety guidelines and follow your permit and proper sampling procedures, guidelines and practices for any analyte of particular interest. The sampler must always be alert to the possibility of danger, especially in dealing with unknown sites, situations, or possible contaminants.

Legal samples are necessary for process control and for when there is evidence an individual or company has not complied with wastewater regulatory requirements and there is a potential for laying charges.

Legal sampling is conducted under the following circumstances: Any known or suspected violation, Spills or environmental accidents. If previous knowledge about compliance history does not exist or it is unknown. From the standing point of objectivity, continuity of evidence and quality of the results, the collection, handling, transport, analysis, storage and disposal of the legal samples must be defensible.

WASTEWATER CHARACTERISTICS & SPECIFIC SOURCES	
PHYSICAL	
SOLIDS	Domestic - Industrial Wastes / Soil Erosion / Inflow, etc.
COLOR	Industrial - Domestic Wastes / Natural Decaying of Organic Matter
ODOR	Industrial Wastes / Decomposition of Wastewater
CHEMICAL	
PHENOLS	Industrial Wastes
pH	Industrial Wastes
TOXIC COMPOUNDS	Industrial Wastes
HEAVY METALS	Industrial Wastes
PESTICIDES	Run-Off From Agriculture
BIOLOGICAL	/ Open Water Courses / Treatment Units, etc

CHART IDENTIFYING BASIC SOURCES AND CHARACTERISTICS OF WASTEWATER

Collecting Wastewater Samples

The purpose of this section is to understand both general and specific sampling procedures, methods and considerations to be used and observed when collecting wastewater samples for field screening or laboratory analysis.

For more detailed information on sampling frequencies, consult the EPA's 2017 *Industrial User Inspection and Sampling Manual for POTWs*.

Parameter	Sample type	Container	Preservative	Holding time
pH	Grab	Polyethylene or Glass	N/A	analyze immediately 15 minutes
BOD	Composite	Polyethylene or Glass	chilled to 4°C	48 hours
TSS	Composite	Polyethylene or Glass	chilled to 4°C	7 days
NH ₃ as N	Composite	Polyethylene or Glass	chilled to 4°C, H ₂ SO ₄ to pH<2	28 days
Oil and Grease	Grab	Glass	chilled to 4°C, HCl or H ₂ SO ₄ to pH<2	28 days
Cyanide, total	Grab	Polyethylene or Glass	chilled to 4°C, NaOH to a pH >12, and 0.6g of ascorbic acid if residual chlorine is present	14 days
Metals (total) excl. Cr ⁺⁶ , B, and Hg	Composite	Polyethylene or Glass	HNO ₃ to pH<2	6 months
624 (volatiles organics)	Grab	Amber glass, w/ Teflon septum lid and zero headspace	chilled to 4°C (additional laboratory preservation required)	7 or 14 days, depending on specific organic
625 (semi-volatile organics)	Composite	Amber glass w/ Teflon lined lid	chilled to 4°C (additional laboratory preservation required)	7 days for sample prep; 40 days for extract

Safety First

Proper safety precautions must be observed when collecting wastewater samples. Wastewater can contain microbiological disease agents (pathogens), chemical poisons (toxins), and other biological, chemical, and physical components that may cause human health problems or disturb natural aquatic ecosystems. Waterborne pathogens in the sewer collection system are different, and potentially more antibiotic resistant, than decades ago.

Wastewater operators can be exposed to wastewater pathogens and toxins through several pathways:

- respiratory exposure -face shield and masks protect from droplets and aerosols
- dermal exposure -gloves and hand hygiene protect from direct contact
- surface (fomite) exposure - barriers between skin and surfaces protect from wastewater and plant equipment contact



Always check the atmosphere of manholes before sampling or entering. Note: Resting the atmospheric monitor on an inverted manhole cover balanced over the manhole is not recommended.

Refer to Centers for Disease Control and Prevention (CDC) Guidance for Controlling Potential Risks to Workers exposed to Class B Biosolids. DHHS (NIOSH) Publication Number 2002-149. Refer to the SESD* Safety, Health and Environmental Management Program Procedures and Policy Manual and any pertinent site-specific Health and Safety Plans (HASP) for guidelines on safety precautions. These guidelines, however, should only be used to complement the judgment of an experienced professional. Address chemicals that pose specific toxicity or safety concerns and follow any other relevant requirements, as appropriate.

Credit U.S. EPA, Science and Ecosystem Support Division (SESD)

Procedural Precautions

The following precautions should be considered when collecting wastewater samples.

- Special care must be taken not to contaminate samples. This includes storing samples in a secure location to preclude conditions which could alter the properties of the sample. Samples shall be custody sealed during long-term storage or shipment.
- Collected samples are in the custody of the sampler or sample custodian until the samples are relinquished to another party.
- If samples are transported by the sampler, they will remain under his/her custody or be secured until they are relinquished.
- Shipped samples shall conform to all U.S. Department of Transportation (DOT) and/or International Air Transportation Association (IATA) hazardous materials shipping requirements.
- Documentation of field sampling is done in a bound logbook.
- Chain-of-custody documents shall be filled out and remain with the samples until custody is relinquished.
- All shipping documents, such as air bills, bills of lading, etc., shall be retained by the project leader and stored in a secure place.

Special Precautions for Wastewater Sampling

- A clean pair of new, non-powdered, disposable gloves will be worn each time a different location is sampled and the gloves should be donned immediately prior to sampling. The gloves should not come in contact with the media being sampled and should be changed any time during sample collection when their cleanliness is compromised.
- Sample containers for samples suspected of containing high concentrations of contaminants shall be stored separately.
- Sample collection activities shall proceed progressively from the least suspected contaminated area to the most suspected contaminated area. Samples of waste or highly contaminated media must not be placed in the same ice chest as environmental (i.e., containing low contaminant levels) or background/control samples.
- If possible, one member of the field sampling team should take all the notes and photographs, fill out tags, etc., while the other members collect the samples.
- Field investigators must use new, verified certified-clean disposable or non-disposable equipment cleaned according to procedures contained in SESD Operating Procedure for Field Equipment Cleaning and Decontamination (SESDPROC-205) for collection of samples for trace metals or organic compound analyses.

Compliance Sampling

Sampling is the most appropriate method for verifying compliance with pretreatment standards. Monitoring location(s) are designated by the Control Authority and must be such that compliance with permitted discharge limits can be determined. Where possible, the Control Authority should not designate monitoring locations that are confined spaces or difficult to access or difficult to place automated sampling equipment.

Monitoring locations should:

- be appropriate for waste stream conditions;
- be representative of the discharge;
- have no bypass capabilities; and
- allow for unrestricted access at all times.

Control Authorities should measure flow to allow for collection of flow-proportioned composite samples, which are required, unless flow-proportional sampling is not feasible. Flow-proportional composite samples are preferred over time composite samples particularly where the monitored discharge is intermittent or variable.

Desired analyses dictate the preparation protocols, equipment, and collection bottles to be used to avoid contamination of samples or loss of pollutants through improper collection. Sampling for such pollutants as pH, cyanide, oil and grease, flashpoint, and volatile organic compounds require manual collection of grab samples.

Similar to composite samples, grab samples must be representative of the monitored discharge and are to be collected from actively mixed holding tanks or flowing wastestreams. Fluctuations in flow or the nature of the discharge may require collection of and hand-compositing of more than one grab sample to accurately assess compliance.

To ensure defensibility of data, Control Authorities should develop and implement standard operating procedures and policies detailing sample collection and handling protocols in accordance with 40 CFR Part 136.

Adherence to proper sample collection and handling protocols, 40 CFR Part 136 approved analytical methodologies, and record-keeping requirements [40 CFR §403.12(o)(1)] can be verified through review of field measurement records, chain of custodies, and lab reports. Field measurement records may require information regarding sample location, condition of and programmed settings for sampling equipment, wastewater meter readings, and information for such parameters as pH and temperature which require analysis in the field.

Chain of custody forms serve as a link between field personnel and the laboratory and contain information regarding sample matrix, type, and handling. Lab reports should contain the minimum information specified in 40 CFR §403.12(o)(1)(ii-iv) as well as any additional information necessary to demonstrate compliance with 40 CFR Part 136 requirements (e.g., analytical methodology, sample preparation date and time, and time of analysis).

Use of standardized forms which prompt recording of information necessary for demonstrating compliance with applicable requirements will aid in ensuring it can be used as admissible evidence in enforcement proceedings or in judicial actions.

Compliance Sampling Evaluation

Wastewater sampling/analysis is an integral part of the National Pollutant Discharge Elimination System (NPDES) Compliance Monitoring Program. NPDES permits contain specific and legally enforceable effluent limitations and monitoring requirements.

Objectives and Requirements

When evaluating the permittee sampling program, the inspector should:

- Verify that the permittee's sampling program complies with the permit.
- Verify that the permittee's sampling program complies with:
 - Title 40 of the *Code of Federal Regulations* (CFR), sections 136.1 to 136.6 and Appendices A, B, and C (Guidelines for Establishing Test Procedures for the Analysis of Pollutants) for wastewater samples; and 40 CFR Part 503.
- Document potential violations to support enforcement action.

In addition, specific objectives of the sampling conducted by inspectors include the following:

- Verify compliance with effluent limitations.
- Verify accuracy of reports and program self-monitoring.
- Support enforcement action.
- Support permit development reissuance and/or revision.
- Determine the quantity and quality of effluent.

Sampling, analysis, preservation technique, sample holding time, and sample container requirements are provided under 40 CFR Part 136 as authorized by section 304(h) of the Clean Water Act (CWA). For all NPDES permittees the inspector should perform a review of sampling procedures and quality control measures the facility uses to ensure the integrity of sample data.

To evaluate sampling procedures, assess the following eight areas:

- Sample site locations
- Sample collection techniques
- Field measurements
- Sample labeling (including locations) and documentation
- Sample preservation and holding time
- Transfer of custody and shipment of samples
- Quality control
- Data handling and reporting

Types of Samples (*Credit USEPA*)

General

There are four types of routine samples that are collected by the POTW's Sampling Section: grab, time proportional composites, flow proportional composites, and hand composites. The sampling method used depends largely on the types of analyses to be run, and the nature of the wastestream being sampled. Each sampling method is described in this section.

Most POTW's will define the sampling methods which must be used by industrial users (IUs) to obtain representative samples to show compliance with their permits:

Example

- (1) A grab sample is an individual sample collected in less than 15 minutes without regard for flow or time of day. pH, cyanide, oil and grease, sulfide, and volatile organics must be collected as grab samples.
- (2) 24-hour flow proportional composite samples where feasible. The POTW may waive this requirement if the IU demonstrates that this method is not feasible. Samples would then be taken by means of time proportional composite sampling methods, or by hand composite where the IU can demonstrate that this will provide a representative sample of the effluent being discharged.

The volume of sample to be collected by any of these methods is dependent on the number and types of analyses that must be performed.

Grab Samples

Grab samples are individual samples collected in less than 15 minutes without regard to flow or time of day. Grab samples are normally taken manually, but can be pumped. Oil and grease samples and purgeable organics are exceptions and must be taken manually.

The collection of a grab sample is appropriate when a sample is needed to:

- Represent an effluent that does not discharge on a continuous basis.
- Provide information about instantaneous concentrations of pollutants at a specific time.
- Allow collection of a variable sample volume.
- Corroborate composite samples.
- Monitor parameters not amenable to compositing (e.g., pH, temperature, dissolved oxygen, chlorine, purgeable organics, oil and grease, coliform bacteria, and others specified by the NPDES permit, which may include phenols, sulfites, and hexavalent chromium).





Grab Sample

A sample which is taken from a water or wastestream on a one-time basis with no regard to the flow of the water or wastestream and without consideration of time. A single grab sample should be taken over a period of time not to exceed 15 minutes.

EPA Sample Identification Methods

Identify each sample accurately and completely. Use labels or tags to identify the samples that are moisture-resistant and able to withstand field conditions. If moisture-resistant labels are not available, place a piece of tape over each label to prevent water damage. Use a waterproof pen to complete the labels or tags. A numbered label or tag associated with a field sample data sheet containing detailed information on the sample is preferable to using only a label or tag for information.

The information for each sample should include the following:

- Facility name/location
- Sample site location
- Sample number
- Name of sample collector
- Date and time of collection
- Indication of grab or composite sample with appropriate time and volume information
- Identification of parameter to be analyzed
- If the sample is preserved and, if so, the preservative used

Various Composite Sampling Techniques (Credit EPA)

The four primary methods of composite sample collection are time compositing, flow proportion compositing, sequential compositing, and continuous compositing. Table 5-1 lists the advantages and disadvantages of these methods. The permit may specify which type of composite sample to use. Composite samples are collected either manually by combining multiple grab samples or by using automatic sampling equipment. Inspectors should consider variability in wastestream flow rate, parameter concentrations and the approved EPA methods when choosing compositing methods, sampling equipment (tubing and containers), and quality assurance procedures. The compositing methods are as follows:

- **Time Composite Sample:** This method requires discrete sample aliquots collected in one container at constant time intervals. This method is appropriate when the flow of the sampled stream is constant (flow rate does not vary more than ± 10 percent of the average flow rate) or when flow monitoring equipment is not available.
- **Flow-Proportional Composite Sample**—in one method, a constant sample volume is collected at varying time intervals proportional to stream flow (e.g., 200 milliliters sample collected for every 5,000 gallons of flow). In the other method (which has two variations, see Table 5-1), the sample is collected by increasing the volume of each aliquot as the flow increases, while maintaining a constant time interval between the aliquots.
- **Sequential Composite Sample**—this method requires discrete samples collected in individual containers at constant time intervals or discharge increments; for example, samples collected every 15 minutes, composited into separate containers each hour. The discrete samples can then be manually flow-proportioned to form the composite sample. Alternatively, a constant sample volume is collected at constant discharge volume increments measured with a flow totalizer.
- **Continuous Composite Sample**—collect this sample continuously from the wastestream. The sample may be constant volume, or the volume may vary in proportion to the flow rate of the wastestream.

Influent Sample Collection

Document and take influent samples at points of high turbulence flow to ensure good mixing. In some instances, the most desirable location may not be accessible. Ensure sampling points are located prior to any internal facility return lines, and sampling equipment should be placed so that it does not interfere with flow measuring devices. The preferred sampling points for raw wastewater are at the most downstream location from the collection lines, but prior to preliminary treatment:

- Waste flowing from the last process in a manufacturing operation, for an industrial user.
- Pump wet well (if turbulent).
- Upstream collection lines, tank, or distribution box following pumping from the wet well or sump.
- Flume throat.
- Aerated grit chamber.
- Upstream siphon following the comminutor (in absence of grit chamber). If it is not possible to sample at a preferred point, choose an alternative location and document the basis for choosing that location.

Effluent Sample Collection

Collect effluent samples at the location specified in the NPDES permit. Occasionally, municipal plant permits may specify sampling prior to chlorination. For these plants, monitor all parameters at the upstream location except fecal coliforms, pH, and total residual chlorine. Collect wastewater for use in bioassays at the location specified in the facility's NPDES permit. Collect samples either manually (grab or composite) or with automatic samplers (continuous or composite).

The following general guidelines apply when taking samples:

- Take samples at a location specified in the NPDES permit and/or at a location selected to yield a representative sample.
- Use the sampling method (grab, composite, continuous) specified in the permit. Some parameters that must be collected as an individual grab sample are dissolved oxygen, total residual chlorine, oil and grease, coliform bacteria, purgeable organics, sulfides, cyanide, and total phenols.
- Avoid collecting large nonhomogeneous particles and objects.
- Collect the sample facing upstream to avoid contamination.
- Do not rinse sample container with sample when collecting oil and grease and microbiological samples, but fill the container directly to within 2.5 to 5 cm from the top.
- Fill the container completely if the sample is to be analyzed for purgeable organics, oxygen, ammonia, hydrogen sulfide, free chlorine, pH, hardness, sulfite, ammonium, ferrous iron, acidity, or alkalinity.
- Collect sufficient volume to allow for quality assurance testing. (see EPA's website <https://www.epa.gov/cwa-methods> for a listing of all approved sampling methods. Each sampling method will indicate the required sampling equipment, sampling containers and sampling volume, but additional volumes may be necessary for quality assurance testing.

The following general guidelines apply when using automatic samplers:

- Collect samples where the wastewater is well mixed. Collect the sample near the center of the flow channel at 0.4 to 0.6 depth (mid-depth).
- Obtain a sufficient volume of sample to perform all required analyses plus any additional amount for quality control. Individual portions of a composite sample should be at least 100 milliliters to minimize sampler solids bias.
- For automatic samplers that use a peristaltic pump, obtain adequate flow rates in the sampler tubing to effectively transport the suspended solids. To avoid solids bias, the velocity of the wastewater in sample tubing should be at least 2 feet per second (fps) and the tubing diameter should be at least 0.25 inch.
- Time of sample collection begins when the last aliquot is dispensed into the composite sample container.

Sample Volume

The volume of sample collected depends on the type and number of analyses needed, as reflected in the parameters to be measured. Obtain the volume of the sample sufficient for all the required analyses plus an additional amount to provide for any split samples or repeat analyses.

EPA approved sampling methods provide a guide to sample volumes required for determining the constituents in wastewater (available at <https://www.epa.gov/cwa-methods>).

Consult the laboratory receiving the sample for any specific volume required. EPA's Methods for Chemical Analysis of Water and Wastes (EPA, 1979a) and Handbook for Sampling and Sample Preservation of Water and Wastewater (EPA, 1982), and the current EPA-approved edition of Standard Methods for the Examination of Water and Wastewater (American Public Health

Association (APHA), American Water Works Association (AWWA), and Water Environment Federation (WEF), 2013) contain specific recommended minimum sample volumes for different pollutant parameters.

Table 5-1. Compositing Methods			
Method	Advantages	Disadvantages	Comments
Time Composite			
Constant sample volume, constant time interval between samples.	Minimal manual effort; requires no flow measurement.	May lack representativeness for highly variable flows.	Widely used in both automatic and manual sampling.
Flow-Proportional Composite			
Constant sample volume, time interval between samples proportional to stream flow.	Minimal manual effort.	Requires accurate flow measurement reading equipment; manual compositing from flowchart.	Widely used in automatic as well as manual sampling.
Constant time interval between samples, sample volume proportional to total stream flow at time of sampling.	Minimal instrumentation.	Manual compositing from flowchart in absence of prior information on the ratio of minimum to maximum flow; chance of collecting too small or too large individual discrete samples for a given composite volume.	Used in automatic samplers and widely used as manual method.
Constant time interval between samples, sample volume proportional to total stream flow since last sample.	Minimal instrumentation.	Manual compositing from flow chart in absence of prior information on the ratio of minimum to maximum flow; chance of collecting too small or too large individual discrete samples for a given composite volume.	Not widely used in automatic samplers but may be done manually.
Sequential Composite			
Series of short period composites, constant time intervals between samples.	Useful if fluctuations occur and the time history is desired.	Requires manual compositing of aliquots based on flow.	Commonly used; however, manual compositing is labor intensive.
Series of short period composites, aliquots taken at constant discharge increments.	Useful if fluctuations occur and the time history is desired.	Requires flow totalizer; requires manual compositing of aliquots based on flow.	Manual compositing is labor intensive.

Continuous Composite			
Constant sample volume.	Minimal manual effort, requires no flow measurement highly variable flows.	Requires large sample capacity; may lack representativeness for highly variable flows.	Practical but not widely used.
Sample volume proportional to stream flow.	Minimal manual effort, most representative especially for highly variable sample volume, variable pumping capacity and power.	Requires accurate flow measurement equipment, large sample volume, variable pumping capacity, and power.	Not widely used.

Sample Containers

The regulations at 40 CFR Part 136 describe required sample containers, sample preservation, and sample holding time. EPA approved sampling methods indicate appropriate sample containers for each analysis. It is essential that the sample containers be made of chemically resistant material unaffected by the concentrations of the pollutants measured. In addition, sample containers must have a closure that will protect the sample from contamination. Collect wastewater samples for chemical analysis in plastic (polyethylene) containers. Exceptions to this general rule are oil and grease samples, pesticides, phenols, polychlorinated biphenyls (PCBs), and other organic pollutant samples.

Collect these in properly cleaned glass jars or bottles and seal. Collect bacteriological samples in properly sterilized plastic or glass containers. Collect samples that contain constituents that will oxidize when exposed to sunlight (such as iron cyanide complexes) in dark containers. Ensure sample containers are clean and uncontaminated. Check analytical procedures to determine if they specify container cleaning procedures. Use precleaned and sterilized disposable containers (e.g., polyethylene cubitainers).

If these are not used or if the analytical method does not specify procedures, use the following procedures for cleaning sample containers:

- Wash with hot water and detergent.
- Rinse with acid (e.g., nitric for metals).
- Rinse with tap water, then rinse three or more times with organic-free water.
- Rinse glass containers with an interference-free, redistilled solvent (such as acetone or methylene chloride for extractable organics).
- Dry in contaminant-free area.

EPA Sample Identification Procedures

Identify each sample accurately and completely. Use labels or tags to identify the samples that are moisture-resistant and able to withstand field conditions. If moisture-resistant labels are not available, place a piece of tape over each label to prevent water damage.

Use a waterproof pen to complete the labels or tags. A numbered label or tag associated with a field sample data sheet containing detailed information on the sample is preferable to using only a label or tag for information.

Wastewater Sample Preservation and Holding Time Introduction

In most cases, wastewater samples contain one or more unstable pollutants that require immediate (e.g., within 15 minutes) preservation and/or analysis. Provide appropriate chemical preservation before transferring samples to the laboratory. EPA approved sampling methods indicate appropriate sample preservation for each analysis (sampling methods are available at <https://www.epa.gov/cwa-methods>).

Procedures used to preserve samples include cooling, pH adjustment, and chemical treatment. For some parameters, such as cyanide and phenols, add preservatives to sample bottles prior to or immediately following sample collection.

For many samples, if preservatives are not appropriately used, bacteria can quickly degrade certain constituents (such as phenols and phosphorus). Other constituents may volatilize (such as volatile organics and sulfides) or may react to form different chemical species (hexavalent chromium, for example).

Proper preservation and holding times are essential to ensure sample integrity (see 40 CFR Part 136). Analysis of samples within one day ensures against error from sample deterioration. However, such prompt analysis is not feasible for composite samples in which portions may be stored for as long as 24 hours.

Where possible, provide sample preservation during compositing, usually by refrigeration to 6°C (or icing). If using an automatic sampler with ice, replace the ice as necessary to maintain low temperatures. This is a limitation of automatic samplers used during the summer when ice must be frequently replaced. Table II of 40 CFR 136.3(e) indicates maximum sample holding times. Times listed are the maximum holding times between sample collection and analysis that are allowed for the sample to be considered valid. Unless otherwise specified in the method, holding time limitations begin upon combination of the last aliquot in a sample. When use of an automatic sampler makes it impossible to preserve each aliquot, the chemical samples may be preserved by maintaining at 6°C until compositing and sample splitting is completed (40 CFR 136.3(e)).

Transfer and Custody of Samples

To ensure the validity of the permit compliance sampling data in court, written records must accurately trace the custody of each sample through all phases of the monitoring program (EPA Order 5360.1). The primary objective of this chain-of-custody is to create an accurate written record (see an example chain-of-custody form in Appendix M) that can be used to trace the possession and handling of the sample from the moment of its collection through its analysis and introduction as evidence.

The following procedures are appropriate for the transfer of custody and shipment of samples:

- Use sample seals to protect the sample's integrity from the time of collection to the time it is opened in the laboratory, including the time the sample is within an automatic sampling apparatus, thus the automatic sampler should be sealed on the outside. The seal should indicate the collector's name, the date and time of sample collection, and sample identification number. For automatic samplers, seals should indicate the sample time at which the apparatus began sampling, as the sample container is subsequently sealed in the apparatus.
- Pack samples properly to prevent breakage. Seal or lock the shipping container to readily detect any evidence of tampering. Use of tamper-proof evidence tape is recommended.
- Place samples on ice or synthetic ice substitute that will maintain sample temperature at 6°C throughout shipment.

- The responsibility for proper packaging, labeling, and transferring of possession of the sample lies with the inspector. Accompany every sample with a sample tag and a chain-of-custody record that has been completed, signed, and dated. The chain-of-custody record should include the names of sample collectors, sample identification numbers, date and time of sample collection, location of sample collection, and names and signatures of all persons handling the sample in the field and in the laboratory.
- The originator retains a copy of the chain of custody forms. Also, the originator must retain all receipts associated with the shipment.
- EPA Inspectors with the responsibility of working with hazardous materials that are placed in commerce (transporting/shipping) must have hazardous materials training as required by the Department of Transportation (see Appendix N).
- When transferring possession of samples, the transferee must sign and record the date and time on the chain-of-custody record (use the currently approved record). In general, custody transfers are made for each sample, although samples may be transferred as a group, if desired. For each sample being transferred, the transferee should list the sample and their name on the custody record. Each person who takes custody must fill in the appropriate section of the chain-of-custody record. Both the transferee and person who takes custody of the sample(s) must sign the custody record.
- Pack and ship samples in accordance with applicable International Air Transportation Association (IATA) and/or DOT regulations.

Quality Control

Conduct control checks during the actual sample collection to determine the performance of sample collection techniques. In general, the most common monitoring errors usually are improper sampling methodology, improper preservation, inadequate mixing during compositing and splitting, and excessive sample holding time. In addition, collect and analyze the following samples to check sample collection techniques:

Blanks

Trip blank

Trip blanks are vial(s) filled at the laboratory with deionized water. The blank(s) follows the same handling and transport procedures as the samples collected during the event. The blank(s) functions as a check on sample contamination originating from sample transport, shipping and from site conditions. Note: Expose the trip blank vial(s), to the same environmental conditions (light, temperature, etc.) of the sample vial(s) but do not open until it is time for analysis.

Field blank/field reagent blank

Field blanks are similar to trip blanks except they are prepared in the field with deionized water exactly as the sample(s) that are collected. Field blanks are used to check for analytical artifacts and/or background introduced by sampling and analytical procedures.

Temperature blank.

A temperature blank is a small sample bottle filled with distilled water that is placed in each cooler prior to shipment. Upon arrival at the laboratory the temperature of the sample bottle is measured to evaluate if samples were adequately cooled during sample shipment.

Equipment/rinsate blank

Collect an equipment/rinsate blank when using an automatic sampler or other non-dedicated equipment during the sampling process. The blank is a check of the equipment cleanliness. For automatic samplers, prepare blanks prior to collecting samples, by pumping deionized organic free water (rinsate) through the sampler and collecting the discharge purge water in a sample container for analysis for the constituents of concern.

Field Duplicate

Collect a field duplicate sample simultaneously from the same source at selected stations on a random timeframe by grab samples or from two sets of field equipment installed at the site. Duplicate samples check analytical precision as well as evaluate the “representativeness” of the sample aliquot.

Split Samples

Split samples are samples that have been divided into two containers for analysis by separate laboratories. These samples provide an excellent means of identifying discrepancies in the permittee’s analytical techniques and procedures. When filling split samples from a single composite jug, shake the composited sample well and half fill the EPA sample container, then shake the composite again and fill half of the permittee’s container. Repeat the procedure for each parameter collected. The laboratories performing the sample analyses should also use the following control measures:

Prep/Reagent Blank

A prep/reagent blank is a sample consisting of reagent(s), without the target analyte or sample matrix, introduced into the analytical procedure at the appropriate point and carried through all subsequent steps to determine the contribution of the reagents and to aid in identifying errors in the observed value that may result from the analytical steps.

Quality Control Sample

A quality control sample is an uncontaminated sample matrix spiked with known amounts of analytes from a source independent from the calibration standards. Use this sample to establish intra-laboratory or analyst specific precision and bias or to assess the performance of all or a portion of the measurements’ system.

Matrix Spike/Matrix Spike Duplicate (MS/MSD)

A matrix spike/matrix spike duplicate sample is three times the normal volume required for a specific chemical analysis to which a known quantity of analyte has been added prior to all sample preparation. The laboratory utilizes the MS/MSD samples as part of their Quality Assurance/Quality Control Program.

- Use a matrix spike to verify accuracy of the analytical procedures.
- A matrix spike duplicate is a duplicate of a matrix spike sample. It measures the precision of the analysis in terms of relative percent difference.

The information for each sample should include the following:

- Facility name/location
- Sample site location
- Sample number
- Name of sample collector
- Date and time of collection
- Indication of grab or composite sample with appropriate time and volume information
- Identification of parameter to be analyzed • If the sample is preserved and, if so, the preservative used

Collecting Procedure for Water/Wastewater Grab Samples

1. Lower dipper or mouth of the bottle into water just below surface. Note sampling time and any other relevant information to the previously applied sampling label.
2. Retrieve or move the collected sample to a clean processing area.
3. If a bottle was used to collect the sample, rinse the bottle 3 times to remove any contaminants.
4. Pour the sample into the required laboratory bottle.
5. You may need to filter the sample; this is true with some water and wastewater samples. Filtering (for ortho-P and NO_x samples).
6. Bottles supplied by an independent laboratory often come pre-loaded with preservative. Otherwise, preservative can be added in the POTW's lab. Bringing bulk preservatives, often strong acids and bases, into the field is not practical.
7. Secure sample container caps tightly.
8. Place the sample containers in an iced cooler before storage.

Timed Composites

Timed samples are usually taken in instances where the intention is to characterize the wastes over a period of time without regard to flow, or where the flow is fairly constant.

Timed composite samples consist of a series of equal volume grab samples taken at regular intervals. A typical interval is 15 minutes, with a maximum sampling duration of 24 hours.

The sample volume and sampling interval need to be calculated, and calibrated, so as to not overfill the collection bottle.

Samplers are available which can hold 24 separate bottles, each of which can receive multiple samples. Samplers can also be fitted with a single composite bottle, typically having a 2.5-gallon capacity. They provide space around the bottle for ice to cool the sample.

Flow Proportional Composites

Flow proportional composite samples consist of: a series of grab samples whose volumes are equal in size, taken each time a specified amount of flow has been measured. For example, a flow measuring device sends readings to a controller which then sends a signal to the sampler every time 1,000 gallons of flow are recorded. A flow measuring device must be used in conjunction with the automatic sampler.

This sampling method is used for all sampling activities except for instances where grab samples are required or time proportional sampling is more expedient and can provide the same accuracy as flow proportional sampling (i.e., constant flow levels or level of contaminants).

Hand Compositing

When sampling a batch discharge tank, hand compositing can be done. If the tank contents are homogenous, and remain so by active mixing, a grab sample provides the same results as a flow proportional composite sample.

If one is not certain that the contents of a batch tank are homogenous, taking four or more discharge grab samples of equal volume at evenly spaced time intervals over the course of the discharge will produce a more representative sample.

For multiple batch discharges in a day, the results of the hand composites can be averaged, considering differences in the volume of the batches.

The results of one, or the proportional average of multiple batch discharges, are the equivalent of a 24-hour flow proportional sampling at a facility with a continuous discharge. The sampling data would be compared with the average daily categorical standards or local limits where applicable.

Pre-Sampling Procedures

To ensure acceptable analytical results, numerous steps must be followed before a sampling program can be initiated:

To ensure that sampling goes smoothly, a considerable amount of preparation is required.

- (1) All sampling equipment shall be clean and be in good working order.
- (2) Fully charge needed batteries and backups.
- (3) Select approved sampling location or equivalent.
- (4) Determine what analyses are needed. Be sure the method selected is sensitive enough to provide results in the range of the permit limit.
- (5) Order sample bottles if not enough are in stock.
- (6) Label sample containers with available information.
- (7) Pack extra sample containers and labels to replace any that break while sampling.
- (8) Gather enough ice chests to hold all the samples with room for ice/ice packs.
- (9) Prepare PPE and, if needed, traffic control and/or confined space entry equipment.
- (10) Arrange for the additional staff required for traffic control or confined space entry.
- (11) Prepare Chain of Custody forms.

Sampling Equipment Example

Most pretreatment programs have one or more dedicated vehicles. These are loaded with equipment that is routinely needed for sampling. This typically includes equipment for confined space entry (support frame, winch, harnesses, gas detector, blowers, etc.) traffic diversion (cones, reflective vests, flags, etc.), manhole cover removal, flow measurement, PPE, and, of course, sampling.

There are many types and brands of automatic composite samplers. Most use a battery for remote placement and power from an outlet when available. If more than a few grabs for pH and temperature are needed, probes linked to a local or remote data logger are used for "sampling".

The equipment that is kept in the sampling vehicle is dependent on the types of sampling activities planned each week, while the equipment stored in the storeroom is for back-up needs and future sampling demands.

Each sampling vehicle should be equipped with at least one sampler and one flow meter more than is needed for the particular sampling period.

For example, three scheduled flow proportionate sampling sites would require a vehicle to be equipped with four samplers and four flow meters.

At least one spare battery for each type of equipment taken into the field should also be placed in the sampling vehicle.

Auxiliary equipment, such as supports, harnesses, blowers, etc., to be carried in each vehicle will depend on the nature of the sampling location.

In order to keep the equipment in good working order, the equipment should be maintained, cleaned and inspected on a regular basis. Routine maintenance and cleaning procedures should be written into your standard operating procedures.

Sampling Equipment Maintenance - Example

Basic maintenance for samplers includes: periodic calibration and general equipment checking, and replacement of the internal desiccant and fuses. Routine cleaning or replacement of tubing and other parts should be done following the manufactures guidelines or according to your SOP.

Basic maintenance of the flow meters includes: periodic replacement of the internal desiccant, plotter paper, ribbon, fuses, and any broken re-roll spool assemblies. Note: Some flow meters have two tabs on the sides which are extremely thin and easily broken.

The NiCad and Gel Cell batteries need to be recharged on a regular basis. Any battery that reads less than 12.50 when checked should not be installed or left on any of the sampling equipment. At the battery charging station, areas are set aside for batteries that need to be charged and batteries already charged.

To prolong battery life, NiCad batteries should be fully discharged before recharging for a maximum of 24 hours, in accordance with the procedures described in the manufacturer's operations and maintenance manuals. Always bring a second set or back-up set of batteries with you.

It is important to note that charged NiCad batteries, if left unused for a long time, are nevertheless slowly discharging. Gel cell batteries are generally more stable. Voltage readings should be taken before the charged batteries are taken into the field to be sure that they still have a full charge.

When a sampler, flow meter, or ancillary equipment needs more specific repairs, the manufacturer representative should be contacted and arrangements made for repair or replacement of the equipment.

Common Wastewater Sample Bottles



625/608, 1657, TTO/Organics, TPH/Oil/Grease,
Thin vials-TOCs, VOCs, 601/602 and 502.2
Be careful not to get air in the VOC/SVOC bottles.



NO₂/NO₃, Fluoride, Sulfide, Metals, BOD-TDS-TSS
Wide-mouth Sludge/Metals bottle

Laboratory
 123 W. Main St
 Sun City, Arizona 85541

LAB I.D. NUMBER

Company: _____ DATE: _____
 Department: _____ PAGE 1 OF 1
 Address: _____
 Contact: _____
 Telephone: _____

Sample Identification	Date	Time	Matrix	Lab ID	Metals* See Attached	TSS	Lead/Copper	BOD/COD	Nitrate	Nitrate + Nitrite	TKN / Amonia	VOC / THM's	Semi Volital Organics (625)	Chloride	Cyanide	Floride	Surfactants (MBAS)	Tot. Coliform MPN	Fecal Coliform MPN-HPC	Organo-Phosphorus Pest. (8141)	Sulfate	EC Conductivity	Number/Containers	
Project Name	Sample Receipt				RELINQUISHED BY:																			
Project Number	No. Containers:	Custody Seals:		Received Intact:	Yes	No	SIGNED BY:																	
Field Measurements:	Received Cold:	Yes	No	SIGNED BY:																				
pH:	Temperature:	PRIORITY:		SIGNED BY:																				
Temp:	SIGNED BY:																							

Wastewater Sampling Information

Required Containers, Preservation Techniques, and Holding Times

40 CFR 136.3

Analytical Parameter	Maximum Holding Time	Required Container Type	Required Preservative	Minimum Amount
Alkalinity (Bicarb, Carb, Hyd, and Tot); SM 2320 B	14 days	Plastic / Glass	0-6°C	100 mL
Ammonia (NH ₃ as N); SM 4500NH ₃ B/C or B/G	28 days	Plastic / Glass	H ₂ SO ₄ pH <2 +0-6°C	200 mL
Asbestos (TEM)	48 hours	Plastic / Glass	0-6°C	1000 mL
Bioassay (Acute Tox) % survival	36 hours	Plastic cubitainer	0-6°C	1-5 gal
Biochemical Oxygen Demand (BOD); SM 5210 B	48 hours	Plastic / Glass	0-6°C	250 mL
Chromium, Hexavalent (CrVI); SM 3500Cr B	24 hours	Plastic / Glass	0-6°C	200 mL
Chloride (Cl ⁻); EPA 300.0	28 days	Plastic / Glass	0-6°C	100 mL
Chlorine, residual; SM 4500Cl B or G	15 minutes	Field Measurement	-	-
Chemical Oxygen Demand (COD); SM 5220 D or EPA 410.4	28 days	Plastic / Glass	H ₂ SO ₄ pH <2 +0-6°C	50 mL
Chlorophyll A (Algal Biomass) / Pheophytin; SM 10200 H	48 Hours to filter 28 days once filtered	Amber Plastic	0-6°C, unfiltered -20°C, filtered	1 L
Coliform, Total / Fecal; SM 9221 B/E	8 hrs - wastewater 24 hrs - drinking water	Plastic (sterile)	Na ₂ S ₂ O ₃ + <10°C	100 mL
Coliform, Total / E.Coli; SM 9223 B (Present/Absent or Quantitray)	24 hours	Plastic (sterile)	Na ₂ S ₂ O ₃ + <10°C	100 mL
Color; SM 2120 B	48 hours	Plastic / Glass	0-6°C	100 mL
Conductivity (EC/SC); SM 2510 B	28 days	Plastic / Glass	0-6°C	100 mL
Cyanide Total or WAD; SM 4500CN B/C/E or B/C/I	14 days	Amber Plastic	NaOH pH >10+0-6°C	100 mL
Dissolved Organic Carbon (DOC); SM 5310 B	Filter within 48 hours 28 days	250 mL Amber glass	Filter then add HCL to pH< 2 + 0-6°C	50 mL
Dissolved Oxygen (DO); SM 4500O G	15 minutes	Field Measurement	-	-
Enterococcus by Enterolert	8 hours	Plastic (sterile)	Na ₂ S ₂ O ₃ + <10°C	100 mL
Fluoride (F ⁻); EPA 300.0	28 days	Plastic / Glass	0-6°C	100 mL
Heterotrophic Plate Count (HPC/SPC); SIMPLATE	24 hours	Plastic (sterile)	Na ₂ S ₂ O ₃ + 0-6°C	100 mL
Hardness (by titration); SM 2340 C	180 days	Plastic / Glass	HNO ₃ pH <2	250 mL
Metals, Dissolved (2); EPA 200.8	Filter within 15 minutes(2), 6 months	Plastic / Glass	Filter then add HNO ₃	100 mL
Metals, Total; EPA 200.8	6 months	Plastic / Glass	HNO ₃ pH <2	100 mL
Metals, Total; EPA 6010/6020		Solids in Glass SJ	None	1 8oz
Mercury (Hg) EPA 245.1	28 days	Plastic / Glass	HNO ₃ pH <2	100 mL
Mercury (Hg) EPA 7471		Solids in Glass SJ	0-6°C	1 8oz
Mercury, Total; EPA 1631 (Aqueous)	48 hours to preserve 90 days once preserved	Glass, Dbl Bagged	HCl	100 mL
Mercury, Total; EPA 1631 (Sludge or Solids)	90 days frozen	Solids in Glass SJ	0-6°C	1 8oz
Mercury, Dissolved (2); EPA 1631	Filter within 24 hours, preserve within 48 hours 90 days once preserved	Glass, Dbl Bagged	Filter in lab, then HCl	100 mL
Mercury, Methyl; EPA 1630 (Aqueous)	48 hours to preserve 6 months preserved	Glass, Amber Dbl Bagged	0-6°C + HCl if < 10 ppt salinity (8)	100 mL
Mercury, Methyl; EPA 1630 (Sludge or Solids)	6 months frozen	Solids in Amber Poly SJ	Solids to be Frozen	1 8oz
Mercury, Dissolved (2) Methyl; EPA 1630	Filter & preserve within 48 hours 6 months once preserved	Glass, Amber Dbl Bagged	Filter in Lab, 0-6°C + HCl if < 10 ppt salinity (8)	100 mL
Nitrate (as N); EPA 300.0	48 hours	Plastic / Glass	0-6°C	100 mL
Nitrite (as N); SM 4500NO ₂ B	48 hours	Plastic / Glass	0-6°C	100 mL
Nitrate+Nitrite as N (NO ₃ +NO ₂ -N) EPA 353.2, or SM NO ₃ F	28 days	Plastic / Glass	H ₂ SO ₄ pH <2 +0-6°C	100 mL
Nitrogen, Total Kjeldahl (TKN); SM 4500Norg + SM 4500NH ₃ B	28 days	Plastic / Glass	H ₂ SO ₄ pH <2 +0-6°C	200 mL
Nitrogen, Total Organic (TON) TKN-NH ₃ - TON calc	28 days	Plastic / Glass	H ₂ SO ₄ pH <2 +0-6°C	200 mL
Odor; SM 2150 B	6 hours (recommended) / 24 hour regulatory	Glass only	0-6°C	250 mL
Oil & Grease, Total and/or Hydrocarbons EPA 1664	28 days	Amber Glass only	HCl pH <2 + 0-6°C	1 L {10}
Chlorinated Pesticides & PCBs EPA 608.1/8081/8082	7 days, Aqueous 14 days, Sludge or Solid	Glass Amber Liter (6) Solids in Glass SJ	0-6°C (5) 0-6°C	1 L 1 8oz
Polynuclear Aromatic Hydrocarbons (PAH's) EPA 625.1/8270	7 days, Aqueous 14 days, Sludge or Solid	Glass Amber Liter (6) Solids in Glass SJ	0-6°C (5) 0-6°C	1 L 1 8oz
Organophosphorus Pesticides EPA 614/8141	7 days, Aqueous 14 days, Sludge or Solid	Glass Amber Liter (6) Solids in Glass SJ	0-6°C (5) 0-6°C	1 L 1 8oz

Analytical Parameter	Maximum Holding Time	Required Container Type	Required Preservative	Minimum Amount	
Semivolatile Organics EPA 625.1/8270	7 days, Aqueous 14 days, Sludge or Solid	Glass Amber Liter (6) Solids In Glass SJ	0-6°C (5) 0-6°C	1 L 1 8oz	
Pyrethroid Pesticides GCMS-NCI-SIM/ 8270M / GCMS/MS	7 days /3 days (9) 14 days, soil or sediment	Glass Amber Liter (6) Solids-Amber Glass SJ (11)	0-6°C (5) Solids to be Frozen	1 L 1 8oz	
Carbamate Pesticides EPA 632/8321	7 days, Aqueous 14 days, Sludge or Solid	Glass Amber Liter (6) Solids In Glass SJ	0-6°C	1 L	
Volatile Organics EPA 524.2 (4)	14 days, preserved	Glass VOA vial (1) (sample in triplicate)	HCl pH <2 + 0-6°C	40 mL	
Volatile Organics EPA 624.1 (3) (Includes Acrolein and Acrylonitrile)	14 days unpreserved 14 days HCl preserved to pH 2 (Benzene, Ethyl Benzene, Toluene only) (11) 3 days unpreserved for Acrolein (12) THMS only—3 HCl VOAs	Total of Six 40 mL VOA Vials; Two Pres w/ HCl, Two Unpreserved, Two Client preserved to pH 4-5. (1)	0-6°C (see holding time for additional preservation)	One 40mL of each container type described	
Volatile Organics; EPA 8260 (3)	14 days	Glass VOA vial (1) (sample in triplicate)	HCl pH <2 + 0-6°C	40 mL	
TPH Diesel/Motor Oil; EPA 8015	7 days	Glass Amber Liter (6)	0-6°C	1 L	
Tributyltin (TBT)	7 days (recommended)	Glass Amber Liter (6)	0-6°C	1 L	
TPH Gas/ BTEX/ MTBE; EPA 8260	14 days preserved	Glass VOA vial (1)	HCl pH <2 + 0-6°C	40 mL	
Dioxin; EPA 1613	1 year	Glass Amber Liter (6)	0-6°C (5)	1 L	
Perchlorate; EPA 314.0	28 days	Plastic/Glass	0-6°C	100 mL	
pH; SM 4500 H+ B	15 minutes	Plastic / Glass	0-6°C	100 mL	
Phenols, EPA 420.1	28 days	Glass Amber 250 mL	H ₂ SO ₄ pH <2 +0-6°C	200 mL	
Phosphate, Ortho (as P); SM 4500P E	48 hours	Plastic / Glass	0-6°C	100 mL	
Phosphate, Ortho, Dissolved (as P); SM 4500P E	15 minutes to filter / 48 hrs once filtered	Plastic / Glass	0-6°C	100 mL	
Phosphorus, Total (PO ₄ as P); SM 4500P B/F or B/E	28 days	Plastic / Glass	H ₂ SO ₄ pH <2+0-6°C	100 mL	
Solids, Settleable (SS); SM 2540 F	48 hours	Plastic / Glass	0-6°C	1000 mL	
Solids, Total (mg/L or %); SM 2540 B, or SM 2540 G	7 days	Plastic / Glass	0-6°C	100 mL	
Solids, Total Dissolved (TDS); SM 2540 C	7 days	Plastic / Glass	0-6°C	100 mL	
Solids, Total Suspended (TSS); SM 2540 D	7 days	Plastic / Glass	0-6°C	200 mL	
Solids, Volatile Suspended (VSS); SM 2540 E	7 days	Plastic / Glass	0-6°C	200 mL	
Sulfate (SO ₄ ²⁻), EPA 300.0	28 days	Plastic / Glass	0-6°C	100 mL	
Sulfide, Dissolved; SM 4500 S2- B/D	7 days	Glass 250 mL	AlCl ₃ + NaOH +0-6°C	250 mL	
Sulfide, Total; SM 4500 S2- C/D	7 days	Glass 250 mL	NaOH + ZnAC pH >9 + 0-6°C	250 mL	
Sulfite (SO ₃ ²⁻)	7 days	Glass 500 mL	EDTA + 0-6°C	250 mL	
Surfactants (MBAS); SM 5540 C	48 hours	Plastic / Glass	0-6°C	250 mL	
Suspended Sediment Conc. (SSC); ASTM D3977	7 days	Plastic / Glass	0-6°C (7)	100 mL	
Total Organic Carbon (TOC); SM 5310 B	28 days	Amber Glass VOA vial (in trip)	HCl pH <2 + 0-6°C	40 mL	
Turbidity; SM 2130 B, or EPA 180.1	48 hours	Plastic / Glass	0-6°C	100 mL	
Ultraviolet Absorption (UVA at 254nm); SM 5910 B	48 hours	Glass Amber 125mL	0-6°C	125 mL	

(1) Volatile organic samples need to be filled in multiple VOA vials without air bubbles or headspace.

(2) Dissolved metals require field or lab filtration through 0.45-micron filter prior to preservation. 40 CFR 136.3 requires filtration within 15 minutes.

(3) Volatile organic methods EPA 624 and 8260 require dechlorination using Sodium Thiosulfate (Na₂S₂O₃) at time of sampling if chlorine is present. (Thiosulfate dechlorination bottles are available at the laboratory upon request.) Dechlorination is to occur before transferring to the appropriate VOA.

(4) Volatile organic method EPA 524.2 requires dechlorination using ascorbic acid at time of sampling if chlorine is present. (Ascorbic acid dechlorination kits are available at the laboratory upon request.) If analyzing for THMs only, Sodium Thiosulfate (Na₂S₂O₃) may be used, and acidification can be omitted. Otherwise, dechlorinate with Ascorbic acid, then preserve with HCl. If the sample foams vigorously upon addition of HCl, discard and collect unpreserved dechlorinated sample, and notify the laboratory as the samples must be analyzed within 24 hours of collection if they are to be analyzed for any compounds other than THMs. Method 524.2 requires a travel/trip blank with each sample set collected.

(5) If sampling from a chlorinated location, collect additional bottles with 0.008% Sodium Thiosulfate (Na₂S₂O₃) for dechlorination.

(6) Semi Volatile Organics Amber Liters (AL) should be collected in duplicate, to insure volume for re-extraction if necessary. When possible, please collect 4 AL per method to allow the laboratory to perform matrix Quality Control (MS/MSD).

(7) Suspended Sediment Conc. (SSC) requires its own container and the entire contents are used for the analysis.

(8) Preserve with HCl if less than 10 ppt Salinity, or Preserve with H₂SO₄ if greater than 10 ppt Salinity.

(9) Cyhalothrin in water has a 3 day hold time in reagent water per USGS study. Permethrin in water has a 3 day hold time per Storage Stability Study by CA Dept. of Food and Agriculture.

(10) 1000 mL required for RL of 5 mg/L. 250 mL bottle recommended for samples with expected concentrations of 20 mg/L or higher.

(11) If unpreserved, must be analyzed within 7 days of sampling

(12) Hold time can be extended to 14 days if preserved to pH 4-5 at time of collection.

Note: Multiple analyses may be run from the same container, provided that the bottle type, volume and preservation are appropriate.

(Rev 12.13.2018)

Wastewater Treatment Plant Sampling (*Example Procedure*)

POTW samples are collected in accordance with the National Pollutant Discharge Elimination System (NPDES) permit which sets discharge limits for certain pollutants and specifies sampling frequencies and sample types.

Depending on the POTW, laboratory personnel, operators, or a combination of these are responsible to prepare sample bottles and trip blanks, program composite samplers, and collect grab samples. It is common to collect samples for operational parameters along with permit required samples.

Plant Sampling Procedure (*Example Procedure*)

Ideally, set up two samplers at the plant influent channel and two samplers at the plant effluent channel. Two samplers are used to provide sufficient sample quantity and to minimize the impact of a sampler failure. All sampling equipment must be prepared and cleaned as established in your POTW's SOP's procedures. Teflon hose is required. Sampling locations or sites are specified in each plant's NPDES permit.

Collect the following composite samples at both sites.

- (1) **Metals Sample** - (one 2-liter plastic bottle)

Preserve with 1:1 nitric acid to a pH < 2. Store sample at 4°C.

- (2) **Cyanide Sample** – (one 2-liter plastic bottle)

Collect the cyanide sample as a composite in accordance with NPDES permit. Check the sample for chlorine. If Cl₂ is present, use ascorbic acid to eliminate it. Add NaOH to a pH > 12. Store samples at 4°C.

- (3) EPA Test Method 608 and 625 samples are informational samples only. These results are used for local limits data.

608 and 625 samples are collected as composite samples. From the well-mixed influent channel composite jug: Pour one 1-liter amber glass bottle of each sample (608, 625). Check samples for chlorine. At the effluent channel: Collect and pour one 4-liter amber glass bottle of each sample (608, 625). Check samples for chlorine. If Cl₂ is present in the samples, use sodium thiosulfate (Na₂S₂O₃) to eliminate it. Store samples on ice at 4°C.

- (4) **625/Phenols** are collected as a grab sample. Collect one 4-liter amber glass bottle at the effluent channel only. Check the sample for chlorine. If Cl₂ is present, use sodium thiosulfate (Na₂S₂O₃) to eliminate it. Store sample at 4°C.

Bio-Solids Sampling (*Example Procedure*)

Bio-solids (dried sludge) samples are collected at POTWs.

Normally, bio-solid samples will be collected from the final storage area for dry sludge. The location of the dried bio-solids may vary based on the individual plants. Sampling frequency will be determined on an as needed basis and to comply with the EPA requirements.

Grab samples are useful for bio-solids. Care should be taken to avoid contamination. All samples are collected using a sterile plastic scoop in order to avoid any contamination.

The following is a list of samples to be collected:

PARAMETER	CONTAINER
Helminth Ova & Enteric Virus	1 Qt Plastic Bag (Ziploc)
Metals +	500 ml Plastic Bottle
Nitrogen (total)	4 oz Glass Bottle
TOC (Total Organic Carbon)	4 oz Glass Bottle
Fecal Coliform	500 ml Plastic Bottle

Sample Scheduling

An active file is maintained on each sampling location which contains historical data including past process discharge flow readings, water meter readings, sampling dates, and conditions of sampling site. A calendar of upcoming sampling events should be maintained.

River Sampling Activities (*Example Procedure*)

To judge the impact of a POTW's discharge to a river, it may be necessary to sample the river above and below the plant's outfall. When developing a sampling plan for river sampling, the following considerations must be observed:

- (1) Sampling sites must meet the objectives of the program or study.
- (2) At the sampling sites the river must be flowing freely and the sample must be as representative as possible of river flow at that site. Consideration of all safety factors must be observed.
- (3) Samples must be collected midstream of the main channel at approximately two-thirds of the depth unless specific depths have been requested.
- (4) All safety precautions must be observed during sampling which includes the use of harnesses, waterproof boots and other equipment.

Sewers (*Example Procedure*)

Sewer system and user rate sampling are conducted in manholes. General guidelines for selection of sampling locations include the following:

- (1) Samples should be taken at points of high turbulent flow to ensure good mixing and prevent the deposition of solids.
- (2) The sample location should be easily accessible and free of any major safety hazards.
- (3) Sample lines should not be located where there is surface scum.
- (4) If a flow study or a flow/proportional sampling event is required, make sure that the sewer pipe does not have a curve, a drop in the line or any obstructions. These would cause false flow readings.

Cleaning Automatic Samplers (*Example Procedure*)

Samplers, sample jars, grab beakers, and all other equipment used in collecting samples must be cleaned between their use at each site, to avoid the possibility of cross contamination. Latex or nitrile gloves should be worn to protect against infections and chemical burns. The following steps should be taken to ensure the proper cleaning of the sampling equipment.

Follow the manufactures recommended procedures for cleaning your automatic samplers. Clean composite jugs and caps separately from the samplers, following your labs SOP.

You may also want to read an EPA Operating Procedure [https://www.epa.gov/sites/default/files/2016-01/documents/field_equipment_cleaning_and_decontamination_at_fec206_af.r3_1.pdf].

Many state environmental departments have their own cleaning procedures for field samplers.

Cleaning often includes the following steps:

- (1) Disassemble the sampler into its component parts.
- (2) Add laboratory soap to a bucket and immerse the parts to be cleaned. Use a bottle brush to thoroughly scrub the inside and outside of parts, focusing on areas that sample comes in contact with.
- (3) Sometimes tubing (suction, peristaltic, or discharge) is so contaminated or worn that replacement is a better option than cleaning. Keep extra tubing in stock.
- (4) A dilute acid is sometimes used to remove stubborn contaminants.
- (5) A disinfectant is sometimes called for.
- (6) Lab water is most commonly used for the final rinse before drying. Sometimes a solvent like acetone is used instead.
- (7) Once dry, reassemble the sampler. Return it to your sampling vehicle or storage area. Leave the lid loose so moisture won't be trapped inside.

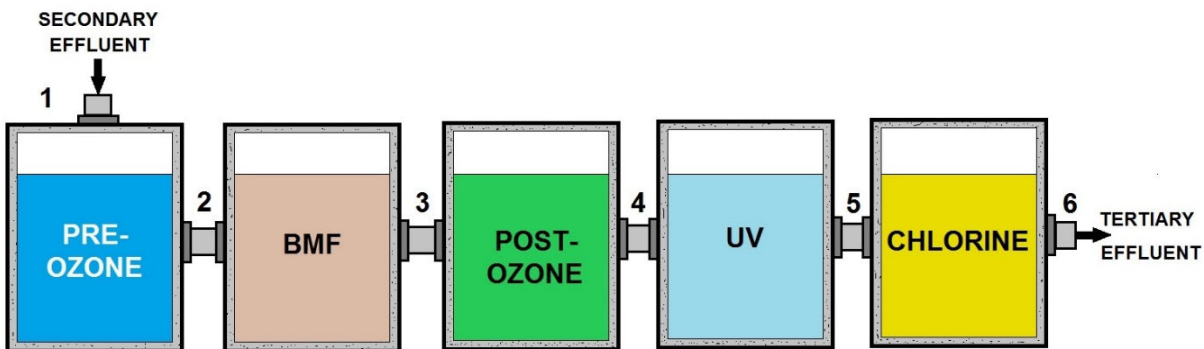

TERTIARY TREATMENT PROCESS SAMPLING POINTS

Selection of Sampling Site

In order to ensure the collection of valid samples, a representative sampling site must be selected. For industrial sampling, the sites are designated in the permit.

QA/QC Field Procedures for Plant Sampling (*Example Procedure*)

Duplicate Sampling Procedure

The purpose of Duplicate Samples is to check the laboratory's ability to reproduce analytical results. Duplicate Samples are to be collected using these steps:

1. Determine amount of sample needed. If a flow proportion sample is required, then base the amount of sample needed on the current flow reading. If a flow-proportion sample is not required, then use the predetermined amount for the sampling site.
2. Collect sample using a grab type sampler or a sampling head.
3. Measure the amount determined in Step 1 using a graduated cylinder or other accurate measuring device.
4. Pour measured sample into sample container that is not marked as the Duplicate Sample.
5. Measure same amount as in Step 1.
6. Pour second measured quantity into sample container marked for Duplicate Sample.
7. Process both samples using standard procedures and submit both samples to laboratory.

Split Sampling Procedure

The purpose of Split Samples is to check analytical procedures by having the samples analyzed by two different laboratories. Collect Split Samples following the procedure used for Duplicate Sampling. The only difference is that the Split Sample is sent to a different lab.

Trip Blank Procedure

The purpose of Trip Blanks is to determine if the purge bottles for the volatile organic samples have been adequately cleaned, and if sample contamination occurs between the time sample bottles leave the laboratory to the time that samples are returned to the lab. Using a purge vile from the same source as the ones to be used for sampling, fill it with DI water in the laboratory. If purge bottles with a preservative are called for, use one of them for the trip blank. Note the time of Trip Blank sample collection on the COC form. Place the trip blank(s) in the ice chest with the purge bottles to be used for sampling. The Blank remains there for the sampling event and is processed with the other samples for testing.

Quality Assurance/Quality Control (*Example*)

Quality Assurance/Quality Control (QA/QC) measures taken by the sampling crew include equipment blanks, trip blanks, split samples and duplicate samples. Equipment blanks and trip blanks are routine QA/QC measures.

- Split samples are taken for Local Limits sampling and when requested by an industry.
- Split samples requested by an industry are analyzed by their lab at their expense.
- Duplicate samples are run when requested by a Project Leader.

According to the EPA, the primary purpose of blanks is to trace sources of artificially introduced contamination. There are five types of blanks used to trace where contamination is introduced, three of which are used in the field and two are used the laboratory. <https://www.epa.gov/sites/default/files/2015-06/documents/blanks.pdf> In addition, temperature blanks are sometimes used. Either laboratory staff or the sampling crew prepare the travel, trip, and/or temperature blanks needed for a sampling event.

Industrial Users - Permitted/Nonpermitted Sampling (Example Procedure)

The sampling points within an industry vary with each industry, depending on the nature of the process and location of pretreatment facilities. Therefore, exact locations must be identified on a case by case basis. However, the following general principles apply in all cases:

- (1) SUOs should give permit writers the ability to require industries to install a sampling vault at a specified location. Depending on the specific site, a special sampling vault may or may not be needed.
- (2) The sampling location should be easily accessible and relatively free of safety hazards.
- (3) The specific location of all sampling points should be part of any permit. It is common to include a map and/or photos to help identify sampling locations.
- (4) If a sampling location can no longer provide access to a representative sample, the permit needs to be modified to identify a location that works.
- (5) When sampling a categorical process or pretreatment system effluent, there should be, if possible, no discharge present other than that from the regulated process. If other wastestreams are combined with the regulated wastestream prior to the sampling location, the combined wastestream formula will need to be utilized. The sampling crew must be aware of lower limits to correctly show analysis on chain of custody.
- (6) When filling out chain of custody forms, be sure to specify a test method sensitive enough to provide concentration results below the limit.
- (7) If mass limitations are to be applied, some means of determining process flow must be available.
- (8) The local limit sampling location needs to be after all flows (industrial and domestic) have combined and before discharge to the public sewer.

Sample Volume -Type and Analyses

Typical sample volumes are required for various analyses. Each laboratory has developed their own standard volumes for routine analyses performed on industrial waste samples. If you are not getting sample bottles from a lab, be sure to ask what volumes they require.

Typical volumes:

- (1) BOD/COD/TSS (1000-2000 ml, plastic)
- (2) Heavy metals (500-2000 ml, plastic)
- (3) Cyanide (2000 ml, plastic)
- (4) Oil and grease (1000 ml, level-one glass)

Selection and Preparation of Sample Containers

The selection of a sample container is based on the parameter to be measured and the volumetric needs of the lab. The primary variables are material, diameter of the opening, and volume. The inspector should be familiar with the type of sampling containers and preservatives that are needed.

It is essential that the sample containers be made of chemically resistant material, and do not affect the concentrations of the pollutants to be measured. In addition, sample containers should have a closure (i.e., leak proof/resistant, Teflon lined) that protects the sample from contamination and should be properly labeled before leaving the sampling site.

Sample Preservation

Wastewater usually contains one or more unstable pollutants that require immediate analysis or preservation until an analysis can be made. Sample preservation is needed for composite samples, for example, which may be stored for as long as 24 hours prior to transferring them to the laboratory.

Chain of Custody (COC)

Documentation of all pertinent data concerning the collection, preservation and transportation of samples is critical to the overall success of the Wastewater Sampling Program. If sampling is performed for the Pretreatment program, any sampling data may be used as evidence in court proceedings against a noncompliant industrial user. In this case, documentation becomes critical. The COC form is a legal document and is of major importance in a court hearing.

Specific procedures with regard to chain of custody are outlined below:

(1) The sampling crew takes a sufficient supply of pre-numbered Industrial Waste Lab Reports, (custody forms) and sample containers into the field.

It is generally possible to fill out much of the form ahead of time, with the notable exceptions of the time of collection and the change in custody signatures.

- a) TURN-AROUND TIME: Check box to indicate if results are needed on a rush basis or in standard turn-around time.
- b) PROJECT #/NAME: The ID # or name assigned for the sampling event.
- c) SITE ID #/NAME: For each sampling location.
- d) DATE SAMPLED: From - Date sampling began. To - Date sample is pulled. If it is a grab sample, only the date the sample was taken will be entered with the other line crossed out.
- e) COLLECTED: Date and Time. For a composite sample, the start, end, and total times are recorded.
- f) MATRIX: Wastewater, DI water, etc.
- g) SAMPLE TYPE: Grab or Composite (hand, flow, or time proportional).
- h) SAMPLE BOTTLE: Material & Size
- i) NUMBER OF CONTAINERS: Used for this sample.
- j) PARAMETER: For example: Metals, Cyanide, O&G, VOC, etc. and,
- k) TEST METHOD: Respectively: EPA 200.7, 4500-CN E, EPA 1664A, EPA 624, etc.
- l) PRESERVATIVE: Codes for each preservative may be specified on the COC form.
- m) NOTES to LAB: Includes any special notes to the lab, such as special analysis required of the sample, a letter code which is assigned to the entity being tested, the amount of flow if sample is flow proportional, grab sample pH and temperature, and/or actual sample temperature.
- n) NOTES (Other): Should include the results of any field tests including pH and temperature.
- o) COLLECTED BY: for the samplers initials and, if needed, the vehicle ID #.
- p) RELINQUISHED BY: Signature w/Date & Time.
- q) RECEIVED BY: Signature w/Date & Time.

(2) When a sample is taken the crew records the time of collection on the COC form.

Field Equipment (Rinsate) Blank Procedure ((*Example Procedure*))

The purpose of Field Equipment Blanks, also known as Rinsate Blanks is to test the procedure for cleaning the sample measuring container to determine if cross contamination between sample sites has occurred. These Blanks are needed only at sites where flow-proportion samples are taken. Follow these steps when collecting a Field Equipment Blank (also see QA/QC check list example):

1. Collect Field Equipment Blank **AFTER** collecting a sample and **BEFORE** moving to the next sampling location.
2. Open a sealed bottle of High Purity Water.
3. After collecting a sample, triple rinse the sample measuring container, usually a graduated cylinder, using High Purity water.
4. Pour the High Purity Water into the sample measuring container that was just rinsed.
5. Pour the High Purity water from sample measuring device into sample bottles labeled for the Field Equipment Blanks.
6. Repeat Steps 3 through 5 until all Field Equipment Blank sample bottles have been filled.
7. Process samples using standard procedures and submit to laboratory.

An equipment blank is high purity water which has been collected in a composite sample bottle or a series of discrete bottles from an automatic sampler. Equipment blanks are used to evaluate the reliability of composite samples collected in the field. The data produced from the equipment blank indicates the performance of the sample collection system, which involves the cleaning of sampling equipment, and accessories, preservation techniques, and handling of samples. The objective is to demonstrate that the samples are not contaminated by inadequate cleaning of equipment, contaminated preservation additives or sample collection techniques, and to provide documented records on Quality Assurance Practices.

Procedures to be followed in collecting the equipment blanks are outlined below. (Also see QA/QC check list, example).

- (1) The sampler is to be assembled completely in the manner determined by the parameters the crew will be sampling (i.e. if sampling for organics, Teflon suction tubing must be used at that site). The composite jar inside the sampler must always be rinsed out thoroughly with high purity water.
- (2) Program the sampler to collect the proper amount of high purity water that is representative of the sample parameters that will be collected at that site. Grab samples are excluded. Pump high purity water through the strainer and intake tubing prior to filling the sampler bottle. Then, place the strainer into as many fresh, uncontaminated bottles of high purity water as needed to collect the necessary volume of sample.
- (3) If the sampler is set up in the discrete mode, the crew must then transfer the collected samples into the field composite bottle and shake to mix thoroughly.
- (4) Transfer the sample from the field composite bottle into its respective lab sample bottles. Test and preserve the samples as appropriate for the parameters being analyzed.
- (5) Follow the chain of custody procedures outlined in SOP for turning the samples in to the laboratory. All paperwork must be completed at this time, and all bottles must be marked accordingly. Custody seals must be used. The crew must note the sampling activity in a logbook that is kept specifically for documenting preparation of equipment blanks and/or any other QA activities.

Sampling Techniques (Example)

General Guidelines

In general, the following guidelines should be observed in conducting sampling activities:

- (1) Samples being collected must be representative of the wastestream being tested.
- (2) Samples shall be collected in uncontaminated containers and preserved properly.
- (3) Samples should be of sufficient volume for the required analyses.
- (4) Samples should be stored in a manner which does not alter the properties of the sample prior to chain of custody transfer.
- (5) Samples should be properly and completely identified by labeling them with the proper information.
- (6) Sample lines should be as short as possible and the smallest practical diameter to facilitate purging, reduce lag time, and give adequate consideration to maximum transport velocity. Also, they should have sufficient strength to prevent structural failure.
- (7) Sample lines should be pitched downward at least 10 percent to prevent settling or separation of solids contained by the sample.
- (8) Samples should be delivered as quickly as possible to the laboratory.

Specific Techniques

Sampling techniques in addition to the above general guidelines must also recognize differences in sampling methodology, preservation, and analytical methods.

The following sections specify techniques that differ by pollutant group and discuss such factors as sampling methodology (e.g., composite, grab, etc.), type of container, preservation and holding time.

Sampling Techniques for Volatile Organics (*Example Procedure*)

Volatile organics are analyzed in accordance with EPA methods 601, 602, 603 and 624.

Due to the volatility of these compounds, only grab samples can be used. If a composite sample is needed, individual grab samples must be collected and composited in the laboratory prior to analysis.

The procedures that must be followed in taking these samples are outlined below.

NOTE: Gloves, clothing, face, and eye protection must be worn when handling volatile organics. In addition, the sampling crew must thoroughly clean those parts of the body that have been exposed to these materials.

(1) For each sampling date, the lab should also provide two additional bottles to be used as a backup in case of breakage. These sampling vials are only good for one week. If any are unused, they must be returned to the lab for disposal.

(2) The lab will provide one sample trip blank per sampling date. This bottle is to be kept on ice until the samples are submitted to the lab. At least one day prior to sampling, go to the lab and request the sample bottles (40 ml vials) for the specific sampling site, as indicated by the sampling plan. The laboratory will arrange to have the appropriate number of sample bottles prepared, based on the number of analyses to be performed. The sampling crew should make sure that all bottles are provided for these samples by the lab technicians.

(3) Collect the sample in a clean glass beaker. Test for chlorine with the Hach test kit. If there is any chlorine residual, neutralize the chlorine with sodium thiosulfate ($\text{Na}_2\text{S}_2\text{O}_3$) and retest for chlorine. Repeat until there is no chlorine residual. Make notes on chain of custody sheet if extra amounts of sodium thiosulfate are required for neutralization.

(4) Remove the vials from the ice. There will be two empty vials for the 601 sample and two vials with HCl for the 602. The HCl will already have been measured into the vials by the lab personnel.

(5) Fill the vial so that the sample is higher than the rim. Surface tension causes this bulge to exist. This is accomplished by pouring the sample from the beaker into the vial along the side of the vial to minimize the possibility of entrapping air in the sample. Do not rinse out or overfill the vials, this will wash out the preservative in the vial.

(6) Seal the vial so that no air bubbles are entrapped in it. Remember to put the Teflon side of the cap facing down onto the vial.

(7) To be sure there are no air bubbles, turn the vial upside down and tap it against the palm of the hand. Check to see if there are air bubbles along the sides or bottom of the vial. If there are bubbles, unseal the vial, top off the vial, and reseal. Check the vial again for the presence of bubbles.

(8) All samples must be maintained at 4°C from the time of collection until the time of extraction. Custody seals must be placed on all samples, and all paper work must be filled out properly.

(9) Return the sample bottles and QA/QC bottles to the laboratory the same day the sample is collected.



Common wastewater sample bottles

Radionuclides, VOCs, (Volatile Organic Compounds), TTHMs, (Total Trihalomethanes), Nitrate, Nitrite.

Most of these sample bottles will come with the preservative already inside the bottle.

Some bottles will come with a separate preservative (acid) for the field preservation.

Slowly add the acid or other preservative to the water sample; not water to the acid or preservative.

Consult the laboratory receiving the sample for any specific volume required. EPA's Methods for Chemical Analysis of Water and Wastes (EPA, 1979a) and Handbook for Sampling and Sample Preservation of Water and Wastewater (EPA, 1982), and the current EPA-approved edition of Standard Methods for the Examination of Water and Wastewater (American Public Health Association (APHA), American Water Works Association (AWWA), and Water Environment Federation (WEF), 2013) contain specific recommended minimum sample volumes for different pollutant parameters.

Synthetic Organic Chemicals (SOC) Sub-Section



Common wastewater sampling bottles. SOC/VOC bottles are the smaller, thin bottles with the septum tops. Be careful not to get any air bubbles in the SOC/VOC bottles

SOC Introduction

Synthetic Organic Chemicals (SOCs) are organic (carbon based) chemicals that are less volatile than Volatile Organic Compounds (VOCs). SOCs are used as pesticides, defoliants, fuel additives and as ingredients for other organic compounds. They are all man made and do not naturally occur in the environment. Some of the more well-known SOCs are Atrazine, 2,4-D, Dioxin and Polychlorinated Biphenyls (PCBs).

SOCs most often enter the natural environment through application of pesticide (including runoff from areas where they are applied), as part of a legally discharged waste stream, improper or illegal waste disposal, accidental releases or as a byproduct of incineration. Some SOCs are very persistent in the environment, whether in soil or water.

SOCs are generally toxic and can have substantial health impacts from both acute (short-term) and chronic (long-term) exposure. Many are known carcinogens (cancer causing). EPA has set Maximum Contaminant Levels (MCL) for 30 SOCs under the Safe Drinking Water Act.

SDWA Act

The Safe Drinking Water Act requires that all water sources of all public water systems be periodically monitored for regulated SOCs. The monitoring frequency can be adjusted through a waiver if SOCs are not detected.

EPA established Maximum Contaminant Levels (MCL), Maximum Contaminant Level Goals (MCLG), monitoring requirements and best available technologies for removal for 65 chemical contaminants over a five year period as EPA gathered and analyzed occurrence and health effects data. This series of rules are known as the Chemical Phase Rules and they define regulations for three contaminant groups:

- Inorganic Chemicals (IOC),
- Synthetic Organic Chemicals (SOC), and
- Volatile Organic Chemicals (VOC).

The Chemical Phase rules provide public health protection through the reduction of chronic risks from:

- cancer;
- organ damage; and
- circulatory,
- nervous, and
- reproductive system disorders.

They also help to reduce the occurrence of Methemoglobinemia or "blue baby syndrome" from ingestion of elevated levels of nitrate or nitrite. All public water systems must monitor for Nitrate and Nitrite. Community water systems and Non-transient non-community water systems must also monitor for IOCs, SOCs, and VOCs.

This is a list of the organic chemicals—which include pesticides, industrial chemicals, and disinfection by-products—that are tested for in public water systems (those that provide water to the public), along with the maximum standard for the contaminant, and a brief description of the potential health effects associated with long-term consumption of elevated levels of the contaminants.

The federal standard for most contaminants is listed as a Maximum Contaminant Level (MCL), the lowest concentration at which that particular contaminant is believed to represent a potential health concern.

Unless otherwise noted, the MCL is expressed as parts per billion (ppb). Also, because of technological limitations or other factors, it is not possible to test for some contaminants in a reliable fashion. Instead, public water systems are required to use specific Treatment Techniques (TT) that are designed to remove these particular contaminants from the water.

In addition to the chemicals listed, monitoring is done for approximately 60 organic chemicals for which MCLs have not been established. If unacceptable levels are found of these "unregulated" contaminants—based on established state health standards and an assessment of the risks they pose—the response is the same as if an MCL has been exceeded: the public water system must notify those served by the system.

Volatile Organic Compounds (VOCs) Sub-Section

Definitions

Volatile Organic Compounds (VOCs) – “VOCs are groundwater contaminants of concern because of very large environmental releases, human toxicity, and a tendency for some compounds to persist in and migrate with groundwater to drinking-water supply well ... In general, VOCs have high vapor pressures, low-to-medium water solubilities, and low molecular weights. Some VOCs may occur naturally in the environment, other compounds occur only as a result of manmade activities, and some compounds have both origins.” - Zogorski and others, 2006

40 CFR 51.100(s) - Definition - Volatile organic compounds (VOC)

(s) "Volatile organic compounds (VOC)" means any compound of carbon, excluding carbon monoxide, carbon dioxide, carbonic acid, metallic carbides or carbonates, and ammonium carbonate, which participates in atmospheric photochemical reactions.

VOCs Explained

Volatile organic compounds (VOCs) are organic chemicals that have a high vapor pressure at ordinary, room-temperature conditions. Their high vapor pressure results from a low boiling point, which causes large numbers of molecules to evaporate or sublime from the liquid or solid form of the compound and enter the surrounding air. An example is formaldehyde, with a boiling point of $-19\text{ }^{\circ}\text{C}$ ($-2\text{ }^{\circ}\text{F}$), slowly exiting paint and getting into the air.

VOCs are numerous, varied, and ubiquitous. They include both human-made and naturally occurring chemical compounds. Most scent or odors are composed of VOC molecules. Industrial use of fossil fuels produces VOCs either directly as products (e.g., gasoline) or indirectly as byproducts (e.g., vehicle exhaust). Some VOCs are dangerous to human health or cause harm to the environment. Anthropogenic VOCs are regulated by law, especially indoors, where concentrations are the highest. Harmful VOCs are typically not acutely toxic, but instead have compounding long-term health effects. Because the concentrations are usually low and the symptoms slow to develop, research into VOCs and their effects is difficult.

Specific Sources of Select VOCs

Paints and Coatings

A major source of man-made VOCs are coatings, especially paints and protective coatings. Solvents are required to spread a protective or decorative film. Approximately 12 billion liters of paints are produced annually.

Typical paint solvents are aliphatic hydrocarbons, ethyl acetate, glycol ethers, and acetone. Motivated by cost, environmental concerns, and regulation, the paint and coating industries are increasingly shifting toward aqueous solvents.

Chlorofluorocarbons and Chlorocarbons

Chlorofluorocarbons, which are banned or highly regulated, were widely used cleaning products and refrigerants. Tetrachloroethene is used widely in dry cleaning and by industry. Industrial use of fossil fuels produces VOCs either directly as products (e.g., gasoline) or indirectly as byproducts (e.g., automobile exhaust).

Benzene

One common VOC that is a known human carcinogen is benzene, which is a chemical found in environmental tobacco smoke, stored fuels, and exhaust from cars in an attached garage. Benzene also has natural sources such as volcanoes and forest fires. It is frequently used to make other chemicals in the production of plastics, resins, and synthetic fibers.

Benzene evaporates into the air quickly and the vapor of benzene is heavier than air allowing the compound to sink into low-lying areas. Benzene has also been known to contaminate food and water and if digested can lead to vomiting, dizziness, sleepiness, rapid heartbeat, and at high levels, even death may occur.

Methylene Chloride

Methylene chloride is another VOC that is highly dangerous to human health. It can be found in adhesive removers and aerosol spray paints and the chemical has been proven to cause cancer in animals. In the human body, methylene chloride is converted to carbon monoxide and a person will suffer the same symptoms as exposure to carbon monoxide. If a product that contains methylene chloride needs to be used the best way to protect human health is to use the product outdoors. If it must be used indoors, proper ventilation is essential to keeping exposure levels down.

Perchloroethylene

Perchloroethylene is another VOC that has been linked to causing cancer in animals. It is also suspected to cause many of the breathing related symptoms of exposure to VOC's. Perchloroethylene is used mostly in dry cleaning. Studies show that people breathe in low levels of this VOC in homes where dry-cleaned clothes are stored and while wearing dry-cleaned clothing. While dry cleaners attempt to recapture perchloroethylene in the dry cleaning process to reuse it in an effort to save money, they can't recapture it all. To avoid exposure to perchloroethylene, if a strong chemical odor is coming from clothing when picked up from the dry cleaner, do not accept them and request that less of the chemical be used as well as a complete drying of the garments

MTBE

MTBE was used as an octane booster and oxygenated-additive. It was banned in the US around 2004 in order to limit further contamination of drinking water aquifers primarily from leaking underground gasoline storage tanks.

Formaldehyde

Many building materials such as paints, adhesives, wall boards, and ceiling tiles slowly emit formaldehyde, which irritates the mucous membranes and can make a person irritated and uncomfortable. Formaldehyde emissions from wood are in the range of 0.02 – 0.04 ppm. Relative humidity within an indoor environment can also affect the emissions of formaldehyde. High relative humidity and high temperatures allow more vaporization of formaldehyde from wood-materials.

Health Risks

Respiratory, allergic, or immune effects in infants or children are associated with man-made VOCs and other indoor or outdoor air pollutants. Some VOCs, such as styrene and limonene, can react with nitrogen oxides or with ozone to produce new oxidation products and secondary aerosols, which can cause sensory irritation symptoms. Unspecified VOCs are important in the creation of smog. VOCs are one category of hazardous air pollutants (HAPs) that are known or suspected to cause cancer, birth defects, and seriously impact the environment. Along with regulating air

emissions, the EPA, through the Clean Water Act, regulates wastewater discharges of these, and other, pollutants from many categories of industries.

Health effects include:

Eye, nose, and throat irritation; headaches, loss of coordination, nausea; damage to liver, kidney, and central nervous system. Some organics can cause cancer in animals; some are suspected or known to cause cancer in humans.

Key signs or symptoms associated with exposure to VOCs include conjunctival irritation, nose and throat discomfort, headache, allergic skin reaction, dyspnea, declines in serum cholinesterase levels, nausea, emesis, epistaxis, fatigue, dizziness.

The ability of organic chemicals to cause health effects varies greatly from those that are highly toxic, to those with no known health effects. As with other pollutants, the extent and nature of the health effect will depend on many factors including level of exposure and length of time exposed. Eye and respiratory tract irritation, headaches, dizziness, visual disorders, and memory impairment are among the immediate symptoms that some people have experienced soon after exposure to some organics. At present, not much is known about what health effects occur from the levels of organics usually found in homes. Many organic compounds are known to cause cancer in animals; some are suspected of causing, or are known to cause, cancer in humans.

Reducing Exposure

To reduce exposure to these toxins, one should buy products that contain Low-VOC's or No VOC's. Only the quantity which will soon be needed should be purchased, eliminating stockpiling of these chemicals. Use products with VOC's in well ventilated areas. When designing homes and buildings, design teams can implement the best possible ventilation plans, call for the best mechanical systems available, and design assemblies to reduce the amount of infiltration into the building. These methods will help improve indoor air quality, but by themselves they cannot keep a building from becoming an unhealthy place to breathe.

While proper building ventilation is a key component to improving indoor air quality, it cannot do the job on its own. As stated earlier, awareness is the key component to improving air quality, when choosing building materials, furnishings, and decorations. When architects and engineers implement best practices in ventilation and mechanical systems, the owner must maintain good air quality levels thereafter.

40 CFR 51.100(s) - Definition - Volatile organic compounds (VOC)

(1) This includes any such organic compound other than the following, which have been determined to have negligible photochemical reactivity:

- methane
- ethane
- methylene chloride (dichloromethane)
- 1,1,1-trichloroethane (methyl chloroform)
- 1,1,2-trichloro-1,2,2-trifluoroethane (CFC-113)
- trichlorofluoromethane (CFC-11)
- dichlorodifluoromethane (CFC-12)
- chlorodifluoromethane (HCFC-22)
- trifluoromethane (HFC-23)
- 1,2-dichloro 1,1,2,2-tetrafluoroethane (CFC-114)
- chloropentafluoroethane (CFC-115)
- 1,1,1-trifluoro 2,2-dichloroethane (HCFC-123)
- 1,1,1,2-tetrafluoroethane (HFC-134a)
- 1,1-dichloro 1-fluoroethane (HCFC-141b)
- 1-chloro 1,1-difluoroethane (HCFC-142b)
- 2-chloro-1,1,1,2-tetrafluoroethane (HCFC-124)
- pentafluoroethane (HFC-125)
- 1,1,2,2-tetrafluoroethane (HFC-134)
- 1,1,1-trifluoroethane (HFC-143a)
- 1,1-difluoroethane (HFC-152a)
- parachlorobenzotrifluoride (PCBTF)
- cyclic, branched, or linear completely methylated siloxanes
- acetone
- perchloroethylene (tetrachloroethylene)
- 3,3-dichloro-1,1,1,2,2-pentafluoropropane (HCFC-225ca)
- 1,3-dichloro-1,1,2,2,3-pentafluoropropane (HCFC-225cb)
- 1,1,1,2,3,4,4,5,5-decafluoropentane (HFC 43-10mee)
- difluoromethane (HFC-32)
- ethylfluoride (HFC-161)
- 1,1,1,3,3,3-hexafluoropropane (HFC-236fa)
- 1,1,2,2,3-pentafluoropropane (HFC-245ca)
- 1,1,2,3,3-pentafluoropropane (HFC-245ea)
- 1,1,1,2,3-pentafluoropropane (HFC-245eb)
- 1,1,1,3,3-pentafluoropropane (HFC-245fa)
- 1,1,1,2,3,3-hexafluoropropane (HFC-236ea)
- 1,1,1,3,3-pentafluorobutane (HFC-365mfc)
- chlorofluoromethane (HCFC-31)
- 1-chloro-1-fluoroethane (HCFC-151a)
- 1,2-dichloro-1,1,2-trifluoroethane (HCFC-123a)
- 1,1,1,2,2,3,3,4,4-nonafluoro-4-methoxy-butane (C₄F₉OCH₃ or HFE-7100)
- 2-(difluoromethoxymethyl)-1,1,1,2,3,3,3-heptafluoropropane ((CF₃)₂CF₂OCH₃)
- 1-ethoxy-1,1,2,2,3,3,4,4,4-nonafluorobutane (C₄F₉OC₂H₅ or HFE-7200)
- 2-(ethoxydifluoromethyl)-1,1,1,2,3,3,3-heptafluoropropane ((CF₃)₂CF₂OC₂H₅)
- methyl acetate

- 1,1,1,2,2,3,3-heptafluoro-3-methoxy-propane (n-C₃F₇OCH₃ or HFE-7000)
- 3-ethoxy-1,1,1,2,3,4,4,5,5,6,6,6-dodecafluoro-2-(trifluoromethyl) hexane (HFE-7500)
- 1,1,1,2,3,3,3-heptafluoropropane (HFC 227ea)
- methyl formate (HCOOCH₃)
- 1,1,1,2,2,3,4,5,5,5-decafluoro-3-methoxy-4-trifluoromethyl-pentane (HFE-7300)
- dimethyl carbonate
- propylene carbonate
- and perfluorocarbon compounds which fall into these classes:
 - (i) cyclic, branched, or linear, completely fluorinated alkanes,
 - (ii) cyclic, branched, or linear, completely fluorinated ethers with no unsaturations,
 - (iii) cyclic, branched, or linear, completely fluorinated tertiary amines with no unsaturations, and
 - (iv) sulfur containing perfluorocarbons with no unsaturations and with sulfur bonds only to carbon and fluorine.

(2) For purposes of determining compliance with emissions limits, VOC will be measured by the test methods in the approved State implementation plan (SIP) or 40 CFR Part 60, Appendix A, as applicable. Where such a method also measures compounds with negligible photochemical reactivity, these negligibly-reactive compounds may be excluded as VOC if the amount of such compounds is accurately quantified, and such exclusion is approved by the enforcement authority.

Toxic - Heavy Metals Sub-Section

Heavy metals, also known as trace metals, are one of the most persistent pollutants in wastewater. The discharge of high amounts of heavy metals into water bodies leads to several environmental and health impacts. The exposure of humans to heavy metals can occur through a variety of routes, which include inhalation as dust or fume, vaporization and ingestion through food and drink. Some negative impacts of heavy metals to aquatic ecosystems include death of aquatic life, algal blooms, habitat destruction from sedimentation, debris, increased water flow, other short and long term toxicity from chemical contaminants.

Abundant amounts of heavy metals present in soils cause reduction in quality and quantity of food preventing plants' growth, uptake of nutrients, physiological and metabolic processes. Severe effects on animals may include reduced growth and development, cancer, organ damage, nervous system damage, and in extreme cases, death. To help mitigate the negative impacts of heavy metals on the health of humans, animals and the environment, a variety of remediation processes exists. These remediation processes are broadly classified into chemical and biological, although the latter is advocated in recent years.

Biological remediation processes (microbial remediation and phytoremediation) are indicated to be very effective in the treatment of heavy metal pollutants in wastewater. Microbial remediation is the restoration of the environment and its quality using microorganisms, such as bacteria, fungi, protozoan and algae while phytoremediation is the use of plants to degrade or accumulate toxic metals, thereby leading to a reduction in the bioavailability of the contaminant in the soil or water.

Heavy metal concentrations from industrial wastewater pollution such as zinc, copper, nickel and chrome, has sparked major environmental compliance initiatives. For this purpose, government agencies established industry compliance standards for metal-contaminated wastewater discharge into municipal sewage treatment plants, and hazardous metal waste solids into landfills.

Industrial metal pollutants that include, but are not limited to:

- Aluminum
- Antimony (a metalloid)
- Arsenic is a metalloid
- Barium
- Beryllium
- Cadmium
- Copper
- Ferric (Iron / Iron Oxide)
- Hexavalent & Trivalent Chrome
- Lead
- Mercury - mercury poisoning
- Molybdenum
- Nickel / Electroless Nickel
- Osmium
- Selenium
- Silver
- Thallium
- Vanadium
- Zinc / Zinc Phosphate

Radioactive metals

- Actinium
- Thorium
- Uranium
- Radium
- The transuraniums, such as plutonium, americium, etc.
- Polonium
- Radioactive isotopes of metallic elements not otherwise strongly toxic, e.g. cobalt-60 and strontium-90.

Aluminum

Aluminum has no biological role and its classification into toxic metals is controversial. Significant toxic effects and accumulation to tissues have been observed in renally impaired patients. However, individuals with healthy kidneys can be exposed to large amounts of aluminum with no ill effects. Thus, aluminum is not considered dangerous to persons with normal elimination capacity.

Trace Elements with Toxicity

- Chromium as hexavalent Cr(VI)
- Nickel – nickel salts are carcinogenic
- Copper – copper toxicity
- Zinc - zinc toxicity
- Iron – iron poisoning
- Fluorine-fluoride poisoning

Non-metals

Some heavy nonmetals may be erroneously called "metals", because they have some metallic properties.

- Selenium – a nonmetal; essential element
- Tellurium

Atomic Spectrometry

Atomic spectrometry converts each metal in the water sample to a particulate emission that can then be weighed. Extrapolations are made to determine each metal concentration in each water sample taken. The complicated analysis requires preserving the sample with acid, heating the sample to convert to a particulate emission and then identifying each metal and its weight. A simple analogy is to capture the steam from a pot of water, separate every atom in the steam, identify each atom, weigh each atom and then apply these numbers back to the original volume of water contained in the pot. The result is an accurate picture of what is in the water.

Heavy Metals in Water

High heavy metals concentrations can be naturally occurring. Every geologic formation contains a certain amount of heavy metal. Mine operations extract and process these metals in areas with the highest concentrations. Water in these areas may have high metal concentrations due to the combination of naturally occurring deposits and mine waste.

Water samples are usually taken randomly within a contaminated area and offsite to identify the source of contamination and the pathway it travels, into the drinkable groundwater system or away from potable water sources. Accurate determination of heavy metal contamination is important to identify cumulative risks to people drinking water derived from these areas.

Sampling Techniques for Heavy Metals *(Example)*

- (1) Generally, all metal samples collected are to be composite samples, i.e., flow/composite, time/composite, or hand composite.
- (2) For composite sampling, place the lid on the bottle and agitate the bottle to completely mix the composite sample.
- (3) Transfer the required amount from the composite container to either a 500 ml or 2000 ml clean plastic bottle. Check the pH of the sample.

Note: For inductively coupled plasma (ICP) metal analysis, a 500 ml clean plastic bottle is required. For extra metals or metals by furnace, a 2000 ml clean plastic bottle is required.

- (4) Add nitric acid (1:1 solution) to the sample to reduce the pH to below 2.0. Usually, 2 ml/500 ml is sufficient. Recheck the pH to be sure it is below 2.0. Make a note on the lab sheet if more than two ml of acid is required to bring the pH below 2.0.
- (5) Label the sample bottle with the corresponding IW number and proper analysis code letter. Attach the custody seal to the sample, then store in the ice chest until transferred to the laboratory. Fill out the IW lab sheet with all the pertinent information, being careful to include all required parameters and the type of analysis required, e.g., ICP/furnace.
- (6) When a grab sample is necessary, rinse out the receiving sample bottle with an aliquot of the wastewater flow or sample stream at least three times. Then fill the sample bottle and proceed with steps two through four described above.
- (7) When a split sample is requested (i.e., one for the samplers and one for the user), the composite sample is prepared as described in item one. Providing there is sufficient sample, a portion is transferred into the bottle provided by the user.
- (8) If more than one site is sampled per day, a clean composite container (i.e., two and one half-gallon glass jar), must be used at each site.
- (9) If a discrete sampler is being used, at the time of collection combine all the samples that have been collected into a single clean composite bottle. Then follow the preceding steps one through four, and refer to step six if a split is requested.

Acid/Base/Neutral Extractable Organics and Pesticides

Acid extractable organics are analyzed in accordance with EPA methods 604 and 625. Base/neutral extractable organics are analyzed in accordance with EPA method 625, or individual methods for various groups of compounds including EPA methods 605, 606, 607, 609, 611, and 612. Pesticides are analyzed in accordance with EPA method 608.

The procedures that must be followed in taking these samples are outlined below.

(1) Samples must be collected in certified clean one-gallon amber glass bottles with Teflon lids.

(2) No travel blanks or QA/QC bottles are required with the samples.

(3) Grab samples must be collected in amber glass bottles. They do not have to be completely filled, but must be a minimum of 1/3 to 1/2 full. Bottles should not be prewashed with samples prior to filling.

(4) For composite sampling, glass composite bottles must be used and precleaned. Teflon tubing must be used for the suction piping. The pump tubing must be medium grade silicone rubber.

(5) The composite bottle in the sampler must be kept refrigerated (putting ice in the sampler) at 4°C. If amber glass is not used (i.e. 2 1/2-gallon clear composite sampler bottle), the sample must be protected from the light during collection and compositing. The compositing must be done in the field (i.e. when discrete sampling has been used).

(6) All samples must be iced at 4°C from the time of collection until extraction.

(7) The sample should be checked for the presence of chlorine using field test kits that provide results in accordance with EPA methods 330.4 and 330.5. If chlorine is determined to be present, 80 mg of sodium thiosulfate should be added to each bottle. The sample must be retested for chlorine. This procedure must be repeated until there is no residual of chlorine shown. The amount of sodium thiosulfate added must be noted on the chain of custody if in excess of 80 mg.

(8) All necessary paperwork must be completed at sampling site. All bottles must be properly labeled, and have custody seals.



Cyanide (*Procedure Example*)

To assure that the sample can be analyzed for cyanide, no chlorine can be present in the sample. Procedures for taking cyanide samples are as follows:

- (1) This sample is normally a grab sample. The cyanide sample is a composite sample when collected as part of Priority Pollutants or Plant Sampling at the POTW.
 - (a) In the sampling file, check the industries' wastewater discharge permit and locate all cyanide (CN) sampling sites. If the sampling sites are located in a confined space, follow Confined Space procedures before collecting the sample or samples.
 - (b) Collect 2000 ml (maximum), 1000 ml (minimum), of CN sample into a plastic bottle.

NOTE: 2000 ml is the standard, but for batch dischargers 1000 ml is adequate.

- (c) Test the cyanide sample for pH and temperature with the pH meter. Record the results on the custody sheet (Industrial Waste (IW) lab sheet).
- (d) Test for chlorine with a Total Chlorine Test Kit (the instructions are located in the kit)
- (e) If chlorine is present in the CN sample, neutralize it with Ascorbic Acid ($C_6H_8O_6$). For ascorbic acid neutralization, add $C_6H_8O_6$, a few crystals at a time, until five mls of sample in the test tube produces no color. Then add an additional 0.06 g of $C_6H_8O_6$ for each liter of sample volume.
- (f) Once all Cl_2 has been neutralized, preserve the sample with Sodium Hydroxide (NaOH) and raise the pH to >12. Verify the >12 pH with a pH meter or pH test strips.
- (g) Mark on the side of the CN sample bottle the COC sheet number (using a water proof marker), and place a corresponding custody seal across the sample bottle tightened cap. Place a Cyanide label on the bottle if cyanide is suspected of being present in the sample.
- (h) Cool and store the CN sample at 4°C and transport it to the laboratory.

Total Sulfides (*Example*)

- (1) The Total Sulfide sample is collected as a grab sample only. Use a clean 500 ml plastic bottle to collect the sample. This sample may be pumped into the sample container or collected directly from the discharge side of the sampling device.
- (2) Preserve the sample with 1 ml of 2N Zinc Acetate ($C_4H_6O_4Zn$) and then add Sodium Hydroxide (NaOH) to raise the pH > 9.
- (3) Label and seal the sample with a custody seal. Cool to 4°C.

Oil and Grease/TPH (*Procedure Example*)

EPA Method 1664A

Extraction of Oil and Grease from Water Samples Using Solid-Phase Extraction (SPE) Disk Configuration

Oil and Grease Disc Configuration Method

Acidify each 1L sample to pH < 2 using 6 M of HCl.

Place required number of samples (1–6) in the sample vial rack. Insert sample lines into each sample bottle.

Collection

Label the collection vials (1–6) and place these into the collection rack. Position the solvent bottles on the left side of the Dionex AutoTrace instrument.

Solvents

Add methanol to solvent bottle

1. Water (pH 2) to solvent bottle
2. Hexane/THF (1:1) to solvent bottle
3. Hexane to solvent bottle
4. And water to solvent bottle
5. Place these solvent bottles to the left side of the Dionex AutoTrace instrument and insert the solvent lines into the corresponding bottle (up to five different solvents can be used with the Dionex AutoTrace instrument). SPE Media Insert SPE disks onto the Dionex AutoTrace instrument (see Dionex (now part of Thermo Scientific) AutoTrace 280 Operation Manual for details¹) and secure the disk into place using the disk holder. The green LED will be illuminated when the disk is locking into place.

METHOD 413.1 (Oil and Grease). Is no longer a valid procedure.

BOD/COD/SS (*Example*)

- (1) 24-hour composite sampling is always used for this test. Agitate the bottle to completely mix the composite sample. Do not allow the solids to settle out before you pour off the sample.
- (2) When more than one sample is being taken from a composite bottle, the BOD/COD/SS is taken first. The lab needs 1000 ml if the sample is cloudy or has solids. If the sample is clear, you must collect 2000 ml. Transfer the appropriate volume to the sample bottle.
- (3) Take the pH/temperature of the sample with either pH paper and a thermometer, or the pH meter carried on the sampling trucks.
- (4) Label the sample bottle and place a custody seal over the lid. Store at 4°C.
- (5) Should split samples be requested, they are only supplied when it is sure there is enough sample for POTW's requirements. Users must provide their own sample containers and allow POTW's staff to pour off samples.

More on these samples in the Laboratory Analysis Chapter.

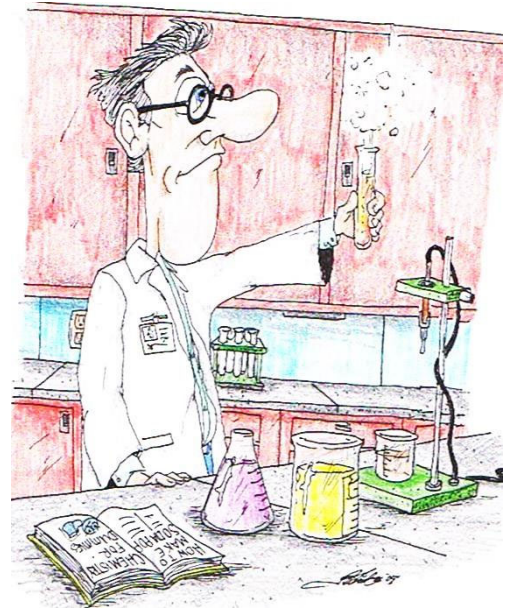

Section References

California State University – Sacramento. Operation of Wastewater Treatment Plants - Volumes I, II, III. Sacramento, California.

International Air Transport Authority (IATA). Dangerous Goods Regulations, Most Recent Version

Metcalf and Eddy, Inc. 2003. Wastewater Engineering: Treatment, Disposal, and Reuse. 4th Edition, McGraw-Hill Book Co., New York, NY

SESD Operating Procedure for Control of Records, SESDPROC-002, Most Recent Version

SESD Operating Procedure for Equipment Inventory and Management (SESDPROC-104, Most Recent Version)

SESD Operating Procedure for Field Equipment Cleaning and Decontamination, SESDPROC-205, Most Recent Version

SESD Operating Procedure for Field Equipment Cleaning and Decontamination at the FEC, SESDPROC-206, Most Recent Version

SESD Operating Procedure for Field pH Measurement, SESDPROC-100, Most Recent Version

SESD Operating Procedure for Field Sampling Quality Control, SESDPROC-011, Most Recent Version

SESD Operating Procedure for Field Specific Conductance Measurement, SESDPROC101, Most Recent Version

SESD Operating Procedure for Field Temperature Measurement, SESDPROC-102, Most Recent Version

SESD Operating Procedure for Logbooks, SESDPROC-010, Most Recent Version

SESD Operating Procedure for Packaging, Marking, Labeling and Shipping of Environmental and Waste Samples, SESDPROC-209, Most Recent Version

SESD Operating Procedure for Sample and Evidence Management, SESDPROC-005, Most Recent Version

SESD Operating Procedure for Surface Water Sampling (SESDPROC-201), Most Recent Version

SESD Operating Procedure for Wastewater Flow Measurement, SESDPROC-109, Most Recent Version

Title 40 Code of Federal Regulations (CFR), Part 136.3, Table II, Most Recent Version

US EPA. 1977. Process Control Manual: Aerobic Biological Treatment Facilities MD-14. EPA 430/09-77-006, Office of Water, Washington, D.C.

US EPA. 2000. Activated Sludge Process Control Testing. ESD, Water Compliance Unit, Athens, GA

US EPA. 2001. Environmental Investigations Standard Operating Procedures and Quality Assurance Manual. Region 4 Science and Ecosystem Support Division (SESD), Athens, GA

Wastewater Sampling Section Post Quiz

True or False

1. Grab samples indicate the condition of the wastewater at that specific time and always represent the normal conditions. True or False
2. Grab samples are required when the analysis may change rapidly. For instance, grab samples are required for certain tests such as temperature, pH, D.O. (dissolved oxygen), and bacteriological analysis. True or False
3. An unweighted composite collects a different sample volume at a constant time interval. True or False
4. A composite sample consists of several grab samples collected from the same spot over a specific period of time and merged into a single sample. True or False
5. A flow meter is usually connected to the composite sampler and the sampler is programmed to draw at different flow intervals. As the flow increases so does the number of samples. True or False
6. A grab sample is more arduous, complicated and usually inconvenient than a simple composite sample. True or False
7. The modern automatic sampler has the capability to be programmed to draw an unknown volume of sample every few minutes and deposit each sample into one bottles that are preserved or refrigerated. At the end of the sampling period, the operator can retrieve the bottles, bring them back to the lab and create a grab sample. True or False
8. Where applicable, wastewater samples should be collected at the location specified in the NPDES permit (if the source has a permit). True or False
9. In some instances, either the sampling location specified in the permit, or the location chosen by the permittee, may be adequate for the collection of a representative wastewater sample. True or False
10. When a conflict exists between the permittee and the regulatory agency regarding the most representative sampling location, both sites should be sampled, and the reason for the conflict should be noted in the field notes and the inspection or study report.
True or False

11. Influent wastewaters are preferably sampled at locations of low turbulent flow where the most desirable location is accessible. True or False

12. When possible, influent samples should be collected upstream from sidestream returns. True or False

13. Composite effluent wastewater samples should never be collected from ponds and lagoons. True or False

14. Even if the ponds or lagoons have long retention times, composite sampling is necessary because ponds and lagoons have the tendency to have flow paths that short circuit, which changes the designed detention time. True or False

15. Effluent samples should be collected at the site generally in the permit, or if no site is specified in the permit, at the most representative site upstream from all entering wastewater streams prior to discharge into the receiving waters. True or False

Wastewater Sampling Section Answers

1. False, 2. True, 3. False, 4. True, 5. True, 6. False, 7. False, 8. True, 9. False, 10. True, 11. False, 12. True, 13. False, 14. True, 15. False

Topic 8- Laboratory Analysis/ Process Control Section

Section Focus: You will learn the basics of wastewater laboratory analyses and process control procedures. At the end of this section, you will be able to describe general laboratory analysis procedures. There is a post quiz at the end of this section to review your comprehension and a final examination in the Assignment for your contact hours.

Scope/Background: Wastewater quality indicators are laboratory analysis methodologies to assess suitability of wastewater for disposal or re-use. The analysis selected and desired test results vary with the intended use or discharge location. Analyses measure physical, chemical, and biological characteristics of the wastewater. The program is important in preventing harm to the environment and to abide with regulations.

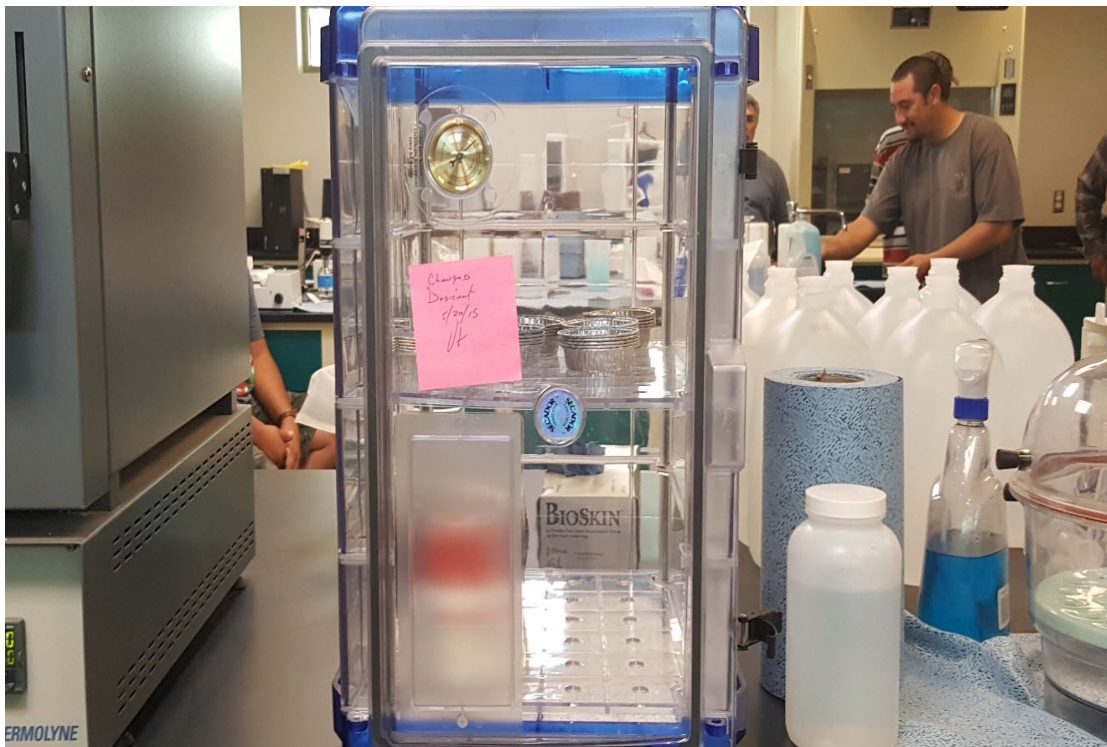

Laboratory Tests and Analyses

Wastewater treatment operators run laboratory tests and analyses to monitor the treatment plant operation. These analyses are for testing the process control and indicate how well a particular process is working. Operators will analyze the results and if needed, will make operational adjustments.

In a typical wastewater treatment plant, there are numerous locations to sample. As wastewater flows through the treatment plant, including the collection system, its characteristics frequently change. By taking samples at different locations throughout the process, the operator has a better understanding of how to treat the flow.

Laboratory duties include some of the following:

- Collect and preserve samples
- Prepare samples for analysis
- Analyze samples and interpret results
- Operate and maintain equipment and instruments
- Handle chemicals and wastes
- Quality assurance/quality control (Engineering and Administrative controls)
- Manage laboratory
- Laboratory safety and proper usage of PPE

Quality Assurance (QA)/Quality Control (QC)

Quality Assurance (QA)/Quality Control (QC) is a program designed by the laboratory that specifies the methods and procedures required to produce measurement-based, technically valid, legally defensible and known quality information. The QA/QC activities are designed to ensure that any problems that may occur are quickly identified and rectified.

The QA/QC Program has Two Components:

1. Quality Assurance (QA) - describes the overall measures that a laboratory uses to ensure the quality of its operations. It is designed to evaluate the precision and accuracy of the sample collection, laboratory analysis and potential sources of contamination encountered during sample collection and delivery to the laboratory.

2. Quality Control (QC) – is part of the overall QA. It consists of operational techniques and activities that are used to fulfil requirements for quality.

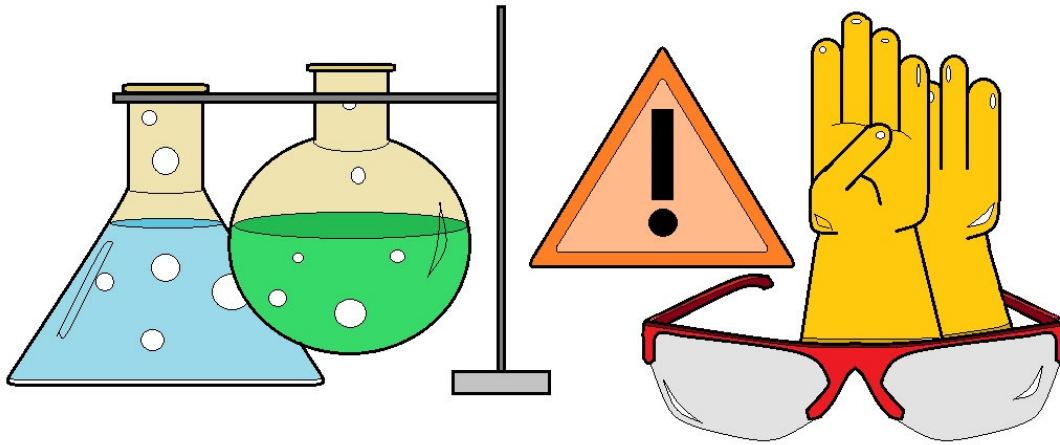

LABORATORY SAFETY GUIDELINES

pH Testing Sub-Section

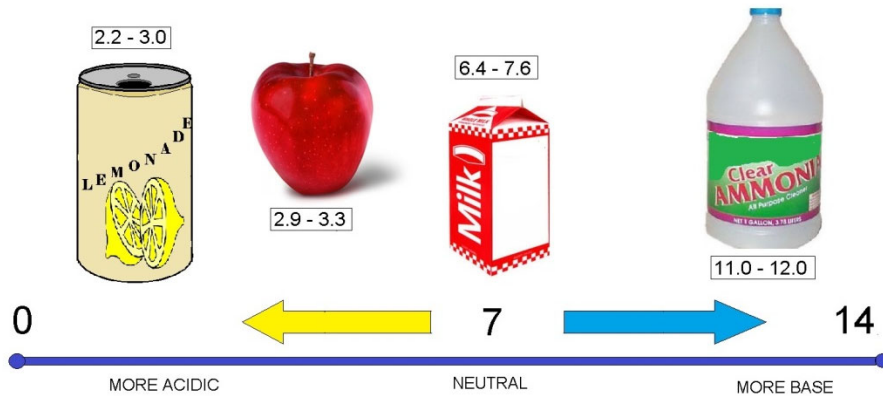

SIMPLE pH SCALE

In water and wastewater processes, **pH** is a measure of the acidity or basicity of an aqueous solution. Solutions with a pH greater than 7 are basic or alkaline and solution or samples with a pH less than 7 are said to be acidic. Pure water has a pH very close to 7. Measurement of pH for aqueous solutions can be done with a glass electrode and a pH meter, or using indicators like strip test paper.

Primary pH standard values are determined using a concentration cell with transference, by measuring the potential difference between a hydrogen electrode and a standard electrode such as the silver chloride electrode. The pH scale is traceable to a set of standard solutions whose pH is established by international agreement.

pH measurements are important in water and wastewater processes (sampling) but also in medicine, biology, chemistry, agriculture, forestry, food science, environmental science, oceanography, civil engineering, chemical engineering, nutrition, water treatment & water purification, and many other applications.

Mathematically, pH is the measurement of hydroxyl ion activity and expressed as the negative logarithm of the activity of the (solvated) hydronium ion, more often expressed as the measure of the hydronium ion concentration.

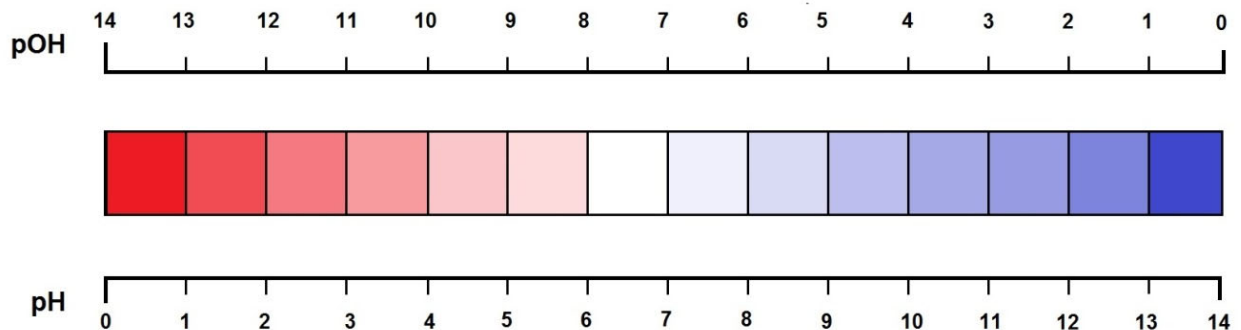

RELATIONSHIP BETWEEN p(OH) & p(H) RED= ACIDIC / BLUE = BASIC

History

The scientific discovery of the p[H] concept was first introduced by Danish chemist Søren Peder Lauritz Sørensen at the Carlsberg Laboratory back in 1909 and revised to the modern pH in 1924 to accommodate definitions and measurements in terms of electrochemical cells. In the first papers, the notation had the "H" as a subscript to the lowercase "p", as so: p_H.

Alkalinity Introduction

We will return to alkalinity in a few pages.

Alkalinity is the quantitative capacity of an aqueous solution to neutralize an acid. Measuring alkalinity is important in determining a stream's ability to neutralize acidic pollution from rainfall or wastewater. It is one of the best measures of the sensitivity of the stream to acid inputs. There can be long-term changes in the alkalinity of rivers and streams in response to human disturbances. Alkalinity is important in wastewater nitrogen removal and an important aspect of potable water quality.

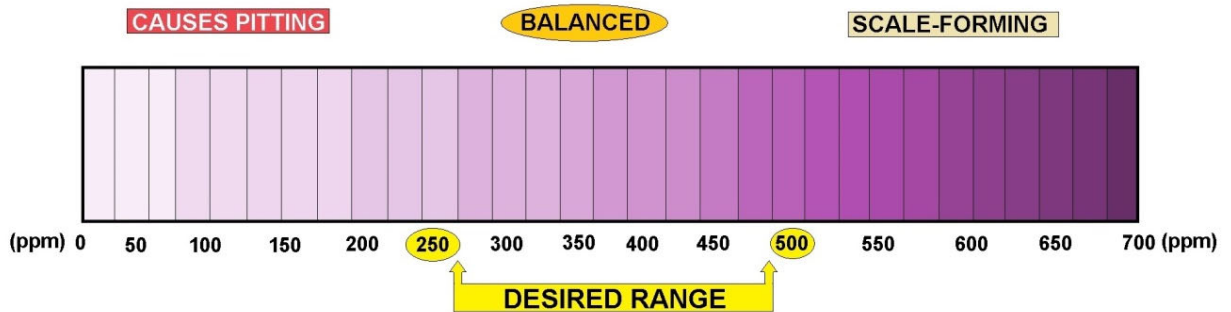

CALCIUM HARDNESS MEASUREMENT

Reference. Bates, Roger G. Determination of pH: theory and practice. Wiley, 1973.

pH Definition and Measurements

CONCENTRATION OF HYDROGEN IONS COMPARED TO DISTILLED H ₂ O	1/10,000,000	14	LIQUID DRAIN CLEANER CAUSTIC SODA	EXAMPLES OF SOLUTIONS AND THEIR RESPECTIVE pH
	1/1,000,000	13	BLEACHES OVEN CLEANERS	
	1/100,000	12	SOAPY WATER	
	1/10,000	11	HOUSEHOLD AMMONIA (11.9)	
	1/1,000	10	MILK OF MAGNESIUM (10.5)	
	1/100	9	TOOTHPASTE (9.9)	
	1/10	8	BAKING SODA (8.4) / SEA WATER EGGS	
	0	7	"PURE" WATER (7)	
	10	6	URINE (6) / MILK (6.6)	
	100	5	ACID RAIN (5.6) BLACK COFFEE (5)	
	1000	4	TOMATO JUICE (4.1)	
	10,000	3	GRAPEFRUIT & ORANGE JUICE SOFT DRINK	
	100,000	2	LEMON JUICE (2.3) VINEGAR (2.9)	
	1,000,000	1	HYDROCHLORIC ACID SECRETED FROM STOMACH LINING (1)	
	10,000,000	0	BATTERY ACID	

pH Scale

pH Indicators

Visual comparison of the color of a test solution with a standard color chart provides a means to measure pH accurate to the nearest whole number. Indicators may be used to measure pH. By making use of the fact that, their color changes with pH. More precise measurements are possible if the color is measured spectrophotometrically, using a colorimeter or spectrophotometer. Universal indicator consists of a mixture of indicators such that there is a continuous color change from about pH 2 to pH 10. Universal indicator paper is made from absorbent paper that has been impregnated with universal indicator.

pOH

pOH is sometimes used as a measure of the concentration of hydroxide ions, OH⁻, or alkalinity. pOH values are derived from pH measurements. The concentration of hydroxide ions in water is related to the concentration of hydrogen ions by

$$[\text{OH}^-] = \frac{K_w}{[\text{H}^+]}$$

where K_w is the self-ionization constant of water. Taking logarithms

$$\text{pOH} = \text{p}K_w - \text{pH}$$

So, at room temperature pOH ≈ 14 – pH. However this relationship is not strictly valid in other circumstances, such as in measurements of soil alkalinity.

Extremes of pH

Measurement of pH below about 2.5 (ca. 0.003 mol dm⁻³ acid) and above about 10.5 (ca. 0.0003 mol dm⁻³ alkali) requires special procedures because, when using the glass electrode, the Nernst law breaks down under those conditions.

Extreme pH measurements imply that the solution may be concentrated, so electrode potentials are affected by ionic strength variation. At high pH the glass electrode may be affected by "alkaline error", because the electrode becomes sensitive to the concentration of cations such as Na⁺ and K⁺ in the solution. Specially constructed electrodes are available which partly overcome these problems. Runoff from industrial outfalls, restaurant grease, mines or mine tailings can produce some very low pH values.

Non-Aqueous Solutions

Hydrogen ion concentrations (activities) can be measured in non-aqueous solvents. pH values based on these measurements belong to a different scale from aqueous pH values, because activities relate to different standard states. Hydrogen ion activity, a_{H^+} , can be defined as:

$$a_{H^+} = \exp \left(\frac{\mu_{H^+} - \mu_{H^+}^\ominus}{RT} \right)$$

where μ_{H^+} is the chemical potential of the hydrogen ion, $\mu_{H^+}^\ominus$ is its chemical potential in the chosen standard state, R is the gas constant and T is the thermodynamic temperature. Therefore pH values on the different scales cannot be compared directly, requiring an intersolvent scale which involves the transfer activity coefficient of hydrolyonium ion.

pH is an example of an acidity function. Other acidity functions can be defined. For example, the Hammett acidity function, H_0 , has been developed in connection with superacids.

The concept of "Unified pH scale" has been developed on the basis of the absolute chemical potential of the proton. This scale applies to liquids, gases and even solids.

Applications

Water has a pH of $pK_w/2$, so the pH of pure water is about 7 at 25 °C; this value varies with temperature. When an acid is dissolved in water, the pH will be less than that of pure water. When a base, or alkali, is dissolved in water, the pH will be greater than that of pure water.

A solution of a strong acid, such as hydrochloric acid, at concentration 1 mol dm⁻³ has a pH of 0.

A solution of a strong alkali, such as sodium hydroxide, at concentration 1 mol dm⁻³, has a pH of 14. Thus, measured pH values will lie mostly in the range 0 to 14, though negative pH values and values above 14 are entirely possible.

Since pH is a logarithmic scale, a difference of one pH unit is equivalent to a tenfold difference in hydrogen ion concentration.

The pH of an aqueous solution of pure water is slightly different from that of a salt such as sodium chloride, even though the salt is neither acidic nor basic. In this case, the hydrogen and hydroxide ions' activity is dependent on ionic strength, so K_w varies with ionic strength.

The pH of pure water decreases with increasing temperatures. One example is the pH of pure water at 50 °C is 6.55.

Seawater

The pH of seawater plays an important role in the ocean's carbon cycle, and there is evidence of ongoing ocean acidification caused by carbon dioxide emissions.

pH measurement can be complicated by the chemical properties of seawater, and several distinct pH scales exist in chemical oceanography.

As part of its operational definition of the pH scale, The International Union of Pure and Applied Chemistry (IUPAC) defines a series of buffer solutions across a range of pH values often denoted with NBS or National Institute of Standard and Technology (NIST) designation.

These solutions have a relatively low ionic strength (~0.1) compared to that of seawater (~0.7), and, as a consequence, are not recommended for use in characterizing the pH of seawater, since the ionic strength differences cause changes in electrode potential.

To resolve this problem, an alternative series of buffers based on artificial seawater was developed. This new series resolves the problem of ionic strength differences between samples and the buffers.

The newest pH scale is referred to as the **total scale**, often denoted as **pH_T**.

Technical Definition of pH

In technical terms, pH is defined as the decimal logarithm of the reciprocal of the hydrogen ion activity, a_{H^+} , in a solution. The pH scale is logarithmic and pH is a dimensionless quantity.

$$pH = -\log_{10}(a_{H^+}) = \log_{10}\left(\frac{1}{a_{H^+}}\right)$$

Ion-selective electrodes are often used to measure pH, respond to activity.

In this calculation of electrode potential, E , follows the Nernst equation, which, for the hydrogen ion can be written as

$$E = E^0 + \frac{RT}{F} \ln(a_{H^+}) = E^0 - \frac{2.303RT}{F} pH$$

where E is a measured potential, E^0 is the standard electrode potential, R is the gas constant, T is the temperature in kelvin, F is the Faraday constant.

For H^+ number of electrons transferred is one. It follows that electrode potential is proportional to pH when pH is defined in terms of activity.

International Standard ISO 31-8 is the standard for the precise measurement of pH as follows: A galvanic cell is set up to measure the electromotive force (EMF) between a reference electrode and an electrode sensitive to the hydrogen ion activity when they are both immersed in the same aqueous solution.

The reference electrode may be a silver chloride electrode or a calomel electrode. The hydrogen-ion selective electrode is a standard hydrogen electrode.

Reference electrode | concentrated solution of KCl || test solution | H_2 | Pt

Firstly, the cell is filled with a solution of known hydrogen ion activity and the emf, E_s , is measured. Then the emf, E_x , of the same cell containing the solution of unknown pH is measured.

$$pH(X) = pH(S) + \frac{E_s - E_x}{Z}$$

The difference between the two measured emf values is proportional to pH. This method of calibration avoids the need to know the standard electrode potential. The proportionality

constant, $1/z$ is ideally equal to $\frac{1}{2.303RT/F}$ the "Nernstian slope".

If you were to apply this practice the above calculation, a glass electrode is used rather than the cumbersome hydrogen electrode. A combined glass electrode has an in-built reference electrode. It is calibrated against buffer solutions of known hydrogen ion activity. IUPAC has proposed the use of a set of buffer solutions of known H^+ activity.

Two or more buffer solutions should be used in order to accommodate the fact that the "slope" may differ slightly from ideal.

The electrode is first immersed in a standard solution and the reading on a pH meter is adjusted to be equal to the standard buffer's value, to implement the proper calibration. The reading from a second standard buffer solution is then adjusted, using the "slope" control, to be equal to the pH for that solution. Further details, are given in the IUPAC recommendations.

When more than two buffer solutions are used the electrode is calibrated by fitting observed pH values to a straight line with respect to standard buffer values. Commercial standard buffer solutions usually come with information on the value at 25 °C and a correction factor to be applied for other temperatures.

pH Calculations

The calculation of the pH of a solution containing acids and/or bases is an example of a chemical speciation calculation, that is, a mathematical procedure for calculating the concentrations of all chemical species that are present in the solution.

The complexity of the procedure for calculating concentrations depends on the nature of the solution.

If the pH of a solution contains a weak acid, it requires the solution of a quadratic equation.

If the pH of a solution contains a weak base, it may require the solution of a cubic equation to solve the concentrations..

For strong acids and bases no calculations are necessary except in extreme situations.

The general case requires the solution of a set of non-linear simultaneous equations.

A complicating factor is that water itself is a weak acid and a weak base. It dissociates according to the equilibrium

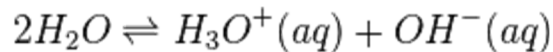

with a dissociation constant, K_w defined as

$$K_w = [H^+][OH^-]$$

where $[H^+]$ represents for the concentration of the aquated hydronium ion and $[OH^-]$ stands for the concentration of the hydroxide ion. K_w has a value of about 10^{-14} at 25 °C, so pure water has a pH of approximately 7.

This equilibrium needs to be considered at high pH and when the solute concentration is extremely low.

Hydrogen Ion pH Comparison Chart

pH	Hydrogen Ion Concentration, mmol/L
14	0.000000000000001
13	0.00000000000001
12	0.0000000000001
11	0.000000000001
10	0.0000000001
9	0.000000001
8	0.00000001
7	0.0000001
6	0.000001
5	0.00001
4	0.0001
3	0.001
2	0.01
1	0.1

Strong Acids and Bases

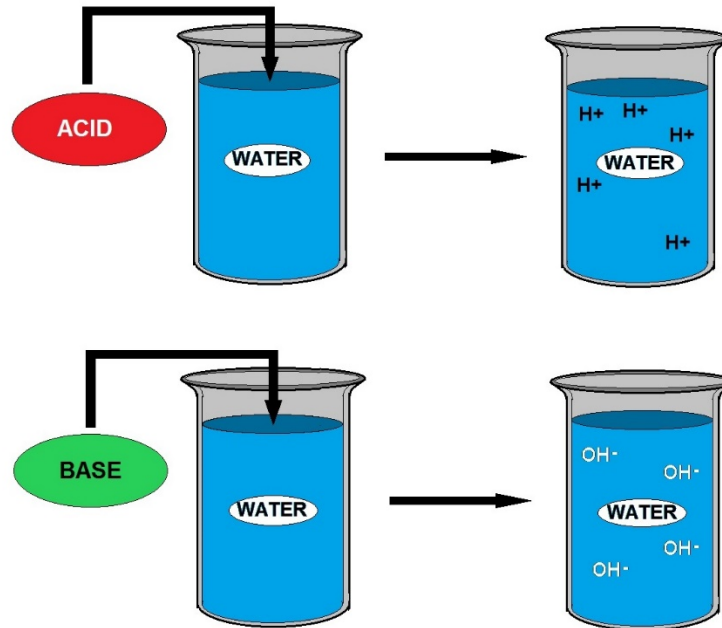

Strong Acids and Bases

Strong acids and bases are compounds that, for practical purposes, are completely dissociated in water. Under normal circumstances this means that the concentration of hydrogen ions in acidic solution can be taken to be equal to the concentration of the acid. The pH is then equal to minus the logarithm of the concentration value.

Hydrochloric acid (HCl) is an example of a strong acid. The pH of a 0.01M solution of HCl is equal to $-\log_{10}(0.01)$, that is, $\text{pH} = 2$.

Sodium hydroxide, NaOH, is an example of a strong base. The p[OH] value of a 0.01M solution of NaOH is equal to $-\log_{10}(0.01)$, that is, $\text{p[OH]} = 2$.

From the definition of p[OH] above, this means that the pH is equal to about 12. For solutions of sodium hydroxide at higher concentrations the self-ionization equilibrium must be taken into account.

Weak Acids and Bases

A weak acid or the conjugate acid of a weak base can be treated using the same formalism.

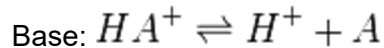
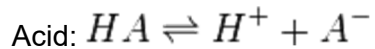

First, an acid dissociation constant is defined as follows. Electrical charges are omitted from subsequent equations for the sake of generality

$$K_a = \frac{[H][A]}{[HA]}$$

and its value is assumed to have been determined by experiment. This being so, there are three unknown concentrations, $[HA]$, $[H^+]$ and $[A^-]$ to determine by calculation. Two additional equations are needed.

One way to provide them is to apply the law of mass conservation in terms of the two "reagents" H and A.

$$\begin{aligned} C_A &= [A] + [HA] \\ C_H &= [H] + [HA] \end{aligned}$$

C stands for analytical concentration. In some texts one mass balance equation is replaced by an equation of charge balance. This is satisfactory for simple cases like this one, but is more difficult to apply to more complicated cases as those below.

Together with the equation defining K_a , there are now three equations in three unknowns. When an acid is dissolved in water $C_A = C_H = C_a$, the concentration of the acid, so $[A] = [H]$. After some further algebraic manipulation an equation in the hydrogen ion concentration may be obtained.

$$[H]^2 + K_a[H] - K_aC_a = 0$$

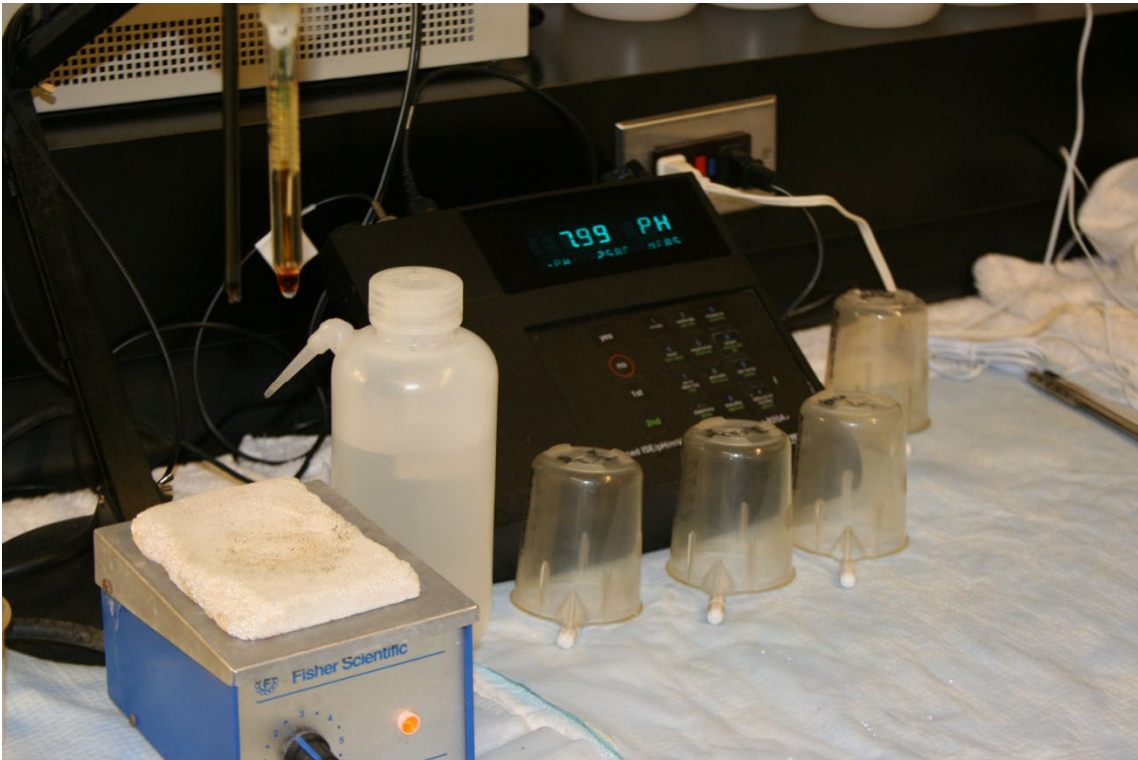

Electronic pH probe, a WWT tool you will use every day.

Alkalinity Sub-Section

Introduction

Alkalinity of water is its acid-neutralizing capacity. It is the sum of all the titratable bases. The measured value may vary significantly with the end-point pH used. Alkalinity is a measure of an aggregate property of water and can be interpreted in terms of specific substances only when the chemical composition of the sample is known.

Alkalinity is significant in many uses and treatments of natural waters and wastewaters. Because the alkalinity of many surface waters is primarily a function of carbonate, bicarbonate, and hydroxide content, it is taken as an indication of the concentration of these constituents. The measured values also may include contributions from borates, phosphates, silicates or other bases if these are present. Alkalinity in excess of alkaline earth metal concentrations is significant in determining the suitability of water for irrigation. Alkalinity measurements are used in the interpretation and control of water and wastewater treatment processes.

Titration Method

a. Principle

Hydroxyl ions present in a sample, because of dissociation or hydrolysis of solutes react with additions of standard acid. Alkalinity thus depends on the end-point pH used.

b. Reagents

- i) Standard Hydrochloric Acid – 0.02 N.
- ii) Methyl Orange Indicator – Dissolve 0.1 g of methyl orange in distilled water and dilute to 1 liter.
- iii) Sodium carbonate solution, 0.02 N : Dry 3 to 5 g primary standard Na_2CO_3 at 250°C for 4 h and cool in a desiccator. Weigh 1.03 gm. (to the nearest mg), transfer to a 1-L volumetric flask, fill flask to the mark with distilled water, dissolve and mix reagent. Do not keep longer than 1 week.

c. Procedure

Titrate over a white surface 100 ml of the sample contained in a 250-ml conical flask with standard hydrochloric acid using two or three drops of methyl orange Indicator. (**NOTE** – If more than 30 ml of acid is required for the titration, a smaller suitable aliquot of the sample shall be taken.)

d. Calculation

Total alkalinity (as CaCO_3), mg/l = $10 V$ or $NxVx50x1000$

T.A. (as CaCO_3) = $\frac{\text{Sample Amount}}{\text{Sample Amount}}$

Where N = Normality of HCl used

V = volume in ml of standard hydrochloric acid used in the titration.

The Titrimetric Method

CHEMetrics' tests determine total or "M" alkalinity using an acid titrant and a pH indicator. The end point of the titration occurs at pH 4.5. Results are expressed as ppm (mg/L) CaCO_3 .

Alkalinity to Phenolphthalein

The sample is titrated against standard acid using phenolphthalein indicator.

a. Reagents

i) Phenolphthalein Indicator Solution :

Dissolve 0.1 g of phenolphthalein in 60 ml of ETHANOL and dilute with Distilled water to 100 ml.

ii) Standard hydrochloric Acid – 0.02 N.

b. Procedure

Add 2 drops of phenolphthalein indicator solution to a sample of suitable size, 50 or 100 ml, in a conical flask and titrate over a while surface with standard hydrochloric acid.

c. Calculation

$$\text{Alkalinity to phenolphthalein (as CaCO}_3\text{), mg/l} = \frac{1000 V_1}{V_2}$$

Where

V₁ = volume in ml of standard hydrochloric acid used in the titration, and

V₂ = Volume in ml of the sample taken for the test.

Caustic Alkalinity

a. General

Caustic alkalinity is the alkalinity corresponding to the hydroxides present in water and is calculated from total alkalinity (T) and alkalinity to phenolphthalein (P).

<p>b. Procedure Determine total alkalinity and alkalinity to phenolphthalein and calculate caustic alkalinity as shown in Table below. Result of Titration Caustic Alkalinity or Hydroxide Alkalinity as CaCO₃ Carbonate Alkalinity as CaCO₃ Bicarbonate Concentration as CaCO₃ Result of Titration</p>	<p>Caustic Alkalinity or Hydroxide Alkalinity as CaCO₃</p>	<p>Carbonate Alkalinity as CaCO₃</p>	<p>Bicarbonate Concentration as CaCO₃</p>
P=0	0	0	0
P<1/2T	0	2P	T-2P
P=1/2T	0	2P	0
P>1/2T	2P-T	2(T-P)	0
P=T	T	0	0

The alkalinity of water is a measure of its capacity to neutralize acids. The alkalinity of natural water is due to the salts of carbonate, bicarbonate, borates, silicates and phosphates along with the hydroxyl ions in free state.

However, the major portion of the alkalinity in natural waters is caused by hydroxide, carbonate, and bicarbonates that may be ranked in order of their association with high pH values.

Alkalinity values provide guidance in applying proper doses of chemicals in water and wastewater treatment processes, particularly in coagulation and softening.

Alkalinity (Total)

References: ASTM D 1067-92, Acidity or Alkalinity of Water.

APHA Standard Methods, 19th ed., p. 2-26, method 2320B (1995).

EPA Methods for Chemical Analysis of Water and Wastes, method 310.1 (1983).

The alkalinity of water is a measurement of its buffering capacity or ability to react with strong acids to a designated pH. Alkalinity of natural waters is typically a combination of bicarbonate, carbonate, and hydroxide ions. Sewage and wastewaters usually exhibit higher alkalinities either due to the presence of silicates and phosphates or to a concentration of the ions from natural waters.

Alkalinity inhibits corrosion in boiler and cooling waters and is therefore a desired quality that must be maintained. Alkalinity is also measured as a means of controlling water and wastewater treatment processes or the quality of various process waters. In natural waters, excessive alkalinity can render water unsuitable for irrigation purposes and may indicate the presence of industrial effluents.

Hardness (Calcium)

Reference: West, T. S., DSC, Ph.D., Complexometry with EDTA and Related Reagents, 3rd ed., p. 46, 164 (1969).

Originally described as water's capacity to precipitate soap, hardness is one of the most frequently determined qualities of water. It is a composite of the calcium, magnesium, strontium, and barium concentrations in a sample. The current practice is to assume total hardness refers to the calcium and magnesium concentrations only.

Completely de-hardened water, resulting from sodium zeolite or other suitable ion exchange treatment, is required for various processes-including power generation, printing and photo finishing, pulp and paper manufacturing, and food and beverage processing.

Hard water can cause scale formation on heat exchange surfaces, resulting in decreased heat transfer and equipment damage.

The Titrimetric Method. This method is specific for calcium hardness. The EGTA titrant in alkaline solution is employed with zincon indicator. Results are expressed as ppm (mg/L) CaCO_3 .

Shelf-life. 8 months. Although the reagent itself is stable, the endpoint indicator has a limited shelf-life. We recommend stocking quantities that will be used within 7 months.

Dissolved Oxygen Testing Sub-Section

Dissolved oxygen (DO) in water is not considered a contaminant. However, the DO level is important because too much or not enough dissolved oxygen can create unfavorable conditions. Generally, a lack of DO in natural waters creates anaerobic conditions. Anaerobic means without air. Certain bacteria thrive under these conditions and utilize the nutrients and chemicals available to exist. *Under anaerobic conditions the reaction is:*

Anaerobic:



Where the intermediates are butyric acid, mercaptans and hydrogen sulfide gas. At least two general forms of bacteria act in balance in a wastewater digester: Saprophytic organisms and Methane Fermenters. The saprophytes exist on dead or decaying materials. The methane fermenters live on the volatile acids produced by these saprophytes. The methane fermenting bacteria require a pH range of 6.6 to 7.6 to be able to live and reproduce. Aerobic conditions indicate that dissolved oxygen is present. Aerobic bacteria require oxygen to live and thrive. When aerobes decompose organics in the water, the result is carbon dioxide and water.

Aerobic:

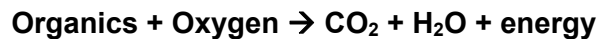

Dissolved oxygen in a water sample can be detrimental to metal pipes in high concentrations because oxygen helps accelerate corrosion. Oxygen is an important component in water plant operations. Its primary value is to oxidize iron and manganese into forms that will precipitate out of the water. It also removes excess carbon dioxide. The amount of dissolved oxygen in a water sample will also affect the taste of drinking water also.

Methods of Determination

There are two methods that we will be using in the lab. The membrane electrode method procedure is based on the rate of diffusion of molecular oxygen across a membrane. The other is a titrimetric procedure (Winkler Method) based on the oxidizing property of the DO. Many factors determine the solubility of oxygen in a water sample. Temperature, atmospheric pressure, salinity, biological activity and pH all have an effect on the DO content.

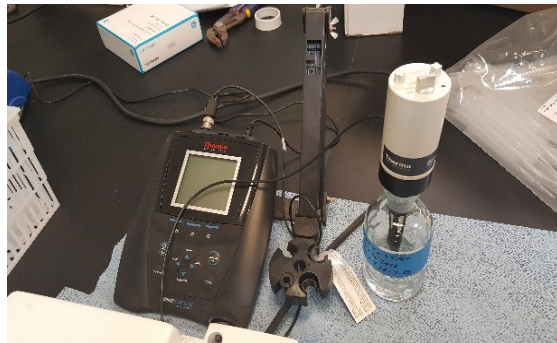

Membrane Electrode DO Meter

Iodometric Test

The Iodometric (titration) test is very precise and reliable for DO analysis of samples free from particulate matter, color and chemical interferences. Reactions take place with the addition of certain chemicals that liberate iodine equivalent to the original DO content. The iodine is then measured to the starch iodine endpoint. We then calculate the dissolved oxygen from how much titrate we use. Certain oxidizing agents can liberate iodine from iodides (positive interferences), and some reducing agents reduce iodine to iodide (negative interferences). The alkaline Iodide-Azide reagent effectively removes interference caused by nitrates in the water sample, so a more accurate determination of DO can be made.

Methods of analysis are highly dependent on the source and characteristics of the sample. The membrane electrode method involves an oxygen permeable plastic membrane that serves as a diffusion barrier against impurities. Only molecular oxygen passes through the membrane and is measured by the meter. This method is excellent for field testing and continuous monitoring. Membrane electrodes provide an excellent method for DO analysis in polluted, highly colored turbid waters and strong waste effluents.

These interferences could cause serious errors in other procedures. Prolonged usage in waters containing such gases as H_2S tends to lower cell sensitivity. Frequent changing and calibrating of the electrode will eliminate this interference. Samples are taken in BOD bottles where agitation or contact with air is at a minimum. Either condition can cause a change in the gaseous content. Samples must be determined immediately for accurate results.

The dissolved oxygen test is the one of the most important analyses in determining the quality of natural waters. The effect of oxidation wastes on streams, the suitability of water for fish and other organisms and the progress of self-purification can all be measured or estimated from the dissolved oxygen content. In aerobic sewage treatment units, the minimum objectionable odor potential, maximum treatment efficiency and stabilization of wastewater are dependent on maintenance of adequate dissolved oxygen. Frequent dissolved oxygen measurement is essential for adequate process control.

Term Review

Aerobic (AIR-O-bick) - a condition in which free or dissolved oxygen is present in the aquatic environment.

Aerobic Bacteria (aerobes) – bacteria which will live and reproduce only in an environment containing oxygen. Oxygen combined chemically, such as in water molecules (H_2O), cannot be used for respiration by aerobes.

Anaerobic (AN-air O-bick) - a condition in which “**free**” or dissolved oxygen is not present in the aquatic environment.

Anaerobic Bacteria (anaerobes) – bacteria that thrive without the presence of oxygen.

Methane Fermenters – bacteria that break down the volatile acids to methane (CH_4) carbon dioxide (CO_2) and water (H_2O).

Saprophytic Bacteria – bacteria that break down complex solids to volatile acids.

Oxidation – the addition of oxygen to an element or compound, or removal of hydrogen or an electron from an element or compound in a chemical reaction. The opposite of reduction.

Reduction – the addition of hydrogen, removal of oxygen or addition of electrons to an element or compound. Under anaerobic conditions in wastewater, elemental sulfur and/or sulfur or compounds are reduced to H_2S or sulfide ions.

Procedures for Dissolved Oxygen Determination

Meter Probe Method

Collect a water sample in the clean 300-ml glass stoppered BOD bottle allow the bottle to sit for two or three minutes to make sure there are no air bubbles trapped in the bottle before inserting each stopper. Do one Tap water sample and one DI water sample. Mark the BOD bottles.

Insert the DO probe from the meter into your BOD bottles. Record the DO for Tap and DI water. Now continue with the Winkler Burette method.



DO Sensor Probe

Winkler Burette Method

Add the contents of one MANGANESE SULFATE powder pillow and one ALKALINE IODIDE-AZIDE reagent powder pillow to each of your BOD bottles (TAP and DI)

1. Immediately insert the stoppers so that no air is trapped in the bottles and invert several times to mix. A flocculent precipitate will form. It will be brownish-orange if dissolved oxygen is present or white if oxygen is absent.
2. Allow the samples to stand until the floc has settled and leaves the solution clear (about 10 minutes). Again invert the bottles several times to mix and let stand until the solution is clear again.
3. Remove the stoppers and add the contents of one SULFAMIC ACID powder pillow to each bottle. Replace the stoppers, being careful not to trap any air bubbles in the bottles, and invert several times to mix. The floc will dissolve and leave a yellow color if dissolved oxygen is present.
4. Measure 200 ml of the prepared solution by filling a clean 250-ml graduated cylinder to the 200-ml mark. Pour the solutions into clean 250-ml Erlenmeyer flasks. Save the last 100 mls for a duplicate.
5. Titrate the prepared solutions with PAO Titrant, 0.025N, to a pale yellow color. Use a white paper under the flask.
6. Add two droppers full of Starch Indicator Solution and swirl to mix. A dark blue color will develop.
7. Continue the titration until the solution changes from dark blue to colorless (end point). Go Slow- drop by drop. Record the burette reading to the nearest 0.01mls.
8. The total number of ml of PAO Titrant used is equal to the mg/L dissolved oxygen.

DO Testing Worksheet -Dissolved Oxygen Results

Meter Results

1. De-ionized water _____mg/L
2. Tap water _____mg/L
3. What is the meter procedure measuring?
4. What factors would determine which the best method to use is?
5. What are two forms of bacteria present in a wastewater digester?

Winkler Method Results

1. De-ionized Water

200ml final Burette reading-
Sample initial Burette reading- - _____ = _____mg/L

100ml final Burette reading-
duplicate initial Burette reading- - _____dup= _____mg/L
mls x 2

2. Tap water

200ml final Burette reading-
Sample initial Burette reading- - _____ = _____mg/L
mls

100ml final Burette reading
Sample initial Burette reading- - _____ = _____mg/L
mls x 2

3. What are some factors that can alter the (DO) content prior to testing?
4. Were your samples anaerobic or aerobic?
5. Why is it important to monitor the (DO) content of water and wastewater?

Be specific and give a detailed explanation.

Biochemical Oxygen Demand (BOD) Sub-Section

In the BOD test, microorganisms are charged with eating all the organics (food). In a BOD bottle, organics from a sample are added to dilution water containing nutrients, oxygen, and microorganisms, then capped and incubated at 20°C for 5 days. Initially the microorganism level is fairly low, but the environmental growing conditions are excellent, so the microorganisms quickly enter the log growth reproduction phase and begin to consume the organics.

The lack of food causes a slowing in the reproduction rate as well as a decrease in the amount of oxygen used. With the high microorganism population, the remaining organics are quickly consumed and the microorganism enter the endogenous phase. During the endogenous phase, the microorganisms utilize internal food reserves, and many die (endogenous phase).

Microorganisms are Hungry

If everything is okay, most of the introduced microorganisms are hungry, but alive and there is still sufficient oxygen left in the bottle to be measured. The amount of oxygen that has been consumed over the 5 days is proportional to the amount of organics (BOD) consumed.

Carbonaceous Demand and Nitrogenous Demand

The test measures the oxygen required for the biochemical degradation of organic material (carbonaceous demand) and the oxygen used to oxidize inorganic material such as sulfides and ferrous iron. It may also measure the oxygen used to oxidize reduced forms of nitrogen (nitrogenous demand) unless their oxidation is prevented by an inhibitor.

The method consists of placing a sample in a full, airtight bottle and incubating the bottle under specified conditions for a specific time. Dissolved oxygen (DO) is measured initially and after incubation. The BOD is calculated from the difference between the initial and final DO.

English Legend

Normally a 5-day BOD test period (English legend has it that 5 days was the time period taken between sewage entering a river and reaching the ocean) is used where samples are incubated in the dark (to restrict algal growth) at 20°C (the temperature believed to be reasonably representative of field conditions).

Most wastewaters contain more oxygen demanding materials than the amount of DO available in air-saturated water. Therefore, it is necessary to dilute certain samples before incubation to bring the oxygen demand and supply into appropriate balance.

Bacterial growth requires nutrients such as nitrogen, phosphorus and trace metals. These are added to dilution water, which is buffered to ensure that the pH of the incubated sample remains in a range suitable for bacterial growth.

Necessary Materials

1. BOD nutrient buffer pillows
2. Nitrification inhibitor
3. D(+)Glucose
4. L-Glutamic acid
5. Purified water or equivalent
6. BOD dilution water container
7. BOD dilution water aerator
8. BOD bottles
9. DO meter and electrode
10. Water bath (20 to 30°C)
11. Balance (4 decimal places)
12. Weighing boats
13. Porcelain crucibles
14. Dessicator
15. Spatula
16. Magnetic stirrer
17. Incubator (20°C +/- 1°C)
18. Oven (103°C)
19. Volumetric flask (1000mL)
20. Graduated cylinders (10 to 1000mL volume)
21. Parafilm
22. Pasteur pipettes
23. Gloves
24. Marker Pen
25. Scissors



Preservation Method

If more than a 2-hour delay before analysis of grab sample(s) takes place the sample(s) should be kept at or below 4°C from the time of collection and analysis should begin within 6 hours of collection. If this is not possible store sample(s) at or below 4°C and report length and temperature of storage with the results. In no case start analysis more than 24 hours after grab sample collection.

Keep composite samples at or below 4°C during compositing. Limit compositing period to 24 hours.

Use the same criteria as for storage of grab samples, starting the measurement of holding time from the end of the compositing period.

State storage time and conditions as part of the results.

Preparation of BOD Dilution Water

1. Place a desired volume of purified water in a BOD dilution water container.
2. Place a BOD aerator in the BOD dilution water
3. Aerate the BOD dilution water overnight.
4. Add a BOD nutrient buffer pillow to the BOD dilution water.
5. Continue aeration of the BOD dilution water until sample dilution is ready to take place.

Preparation of 2% Glucose-Glutamic Acid Solution (Prepare immediately before use)

1. Dry D(+)Glucose and L-Glutamic acid at 103°C for 1 hour.
2. Add 0.150g of D(+)Glucose and 0.150g of L-Glutamic acid to a 1000mL volumetric flask containing purified water, mix thoroughly and make up to the mark with purified water.
3. Prepare a 1:50 (2%) dilution of the Glucose-Glutamic Acid solution using BOD dilution water.

BOD Determination

1. Prepare dilutions, where appropriate, of the sample(s) to be tested. Dilutions that result in a residual DO of at least 1mg/L and a DO uptake of at least 2mg/L after 5 days incubation provide the most reliable results.
2. Transfer the diluted or undiluted sample(s) to a corresponding glass stoppered BOD bottle(s).
3. Bring the diluted or undiluted sample(s) to 20°C.
4. Measure the DO₀ of the sample(s) in mg/L using a DO meter and electrode. The DO should be approximately 9.2mg/L at 20°C.
5. Add an appropriate quantity of nitrification inhibitor to the sample(s).
6. Stopper the BOD bottle.
7. Treat a BOD blank, containing BOD dilution water instead of sample in the same manner as the sample.
8. Treat the 2% Glucose-Glutamic Acid Solution in the same manner as the sample.
9. Incubate the sample(s), blank and Glucose-Glutamic Acid Solution at 20±1°C for 5 days.
10. Measure the DO₅ of the sample(s), blank and Glucose-Glutamic Acid solution and determine their BOD₅ according to the formula in section 6:0.

The DO uptake of the blank after 5 days should not be more than 0.2 mg/L and preferably not more than 0.1 mg/L. If the oxygen depletion exceeds 0.2 mg/L obtain satisfactory water by improving purification or from another source.

The BOD₅ of the Glucose-Glutamic Acid solution should be 200±37mg/L. If it is outside this range reject any BOD determinations made with the BOD dilution water and seek the cause of the problem.

If more than one sample dilution meets the criteria of a residual DO of at least 1mg/L and a DO depletion of at least 2mg/L and there is no evidence of toxicity at higher sample concentrations or the existence of an obvious anomaly, average results in the acceptable range.

BOD Formula

Legend

DO₀ = DO Original, at start of test

DO₅ = DO after 5 days

BOD formula when sample dilution is less than 1:10

$$\text{BOD}_5 = \frac{(\text{DO}_0 - \text{DO}_5)_{\text{Sample}}}{\text{Sample}} \left[(X-1/X) \cdot \frac{(\text{DO}_0 - \text{DO}_5)_{\text{Blank}}}{\text{Blank}} \right] \times X$$

X = Dilution factor

BOD formula when sample dilution is 1:10 or greater than 1:10

$$\text{BOD}_5 = \left[\frac{(\text{DO}_0 - \text{DO}_5)_{\text{Sample}}}{\text{Sample}} - \frac{(\text{DO}_0 - \text{DO}_5)_{\text{Blank}}}{\text{Blank}} \right] \times X$$

X = Dilution factor

BOD formula when sample is undiluted

$$\text{BOD}_5 = \frac{(\text{DO}_0 - \text{DO}_5)_{\text{Sample}}}{\text{Sample}}$$

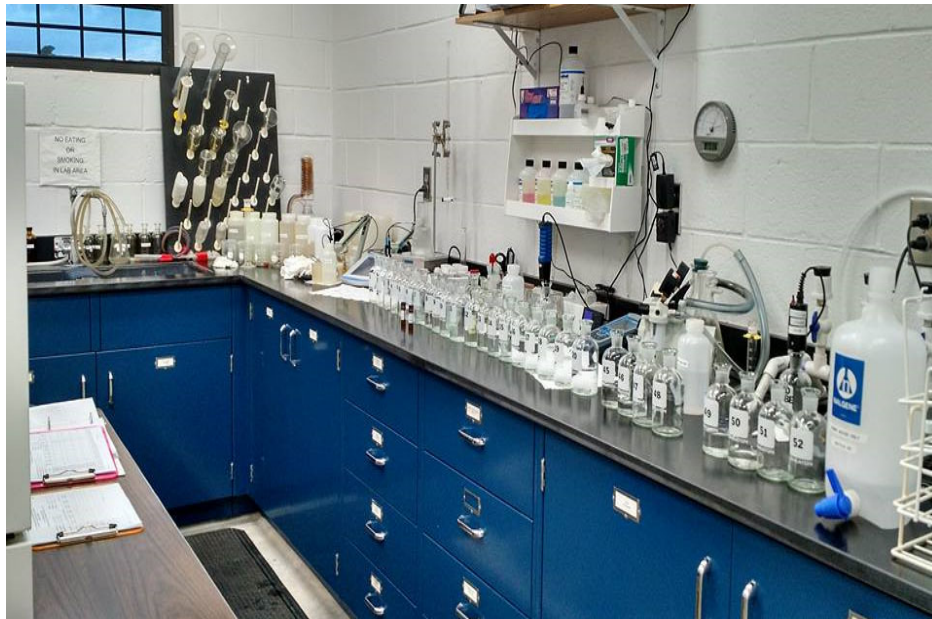

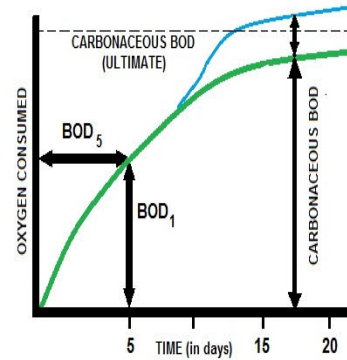
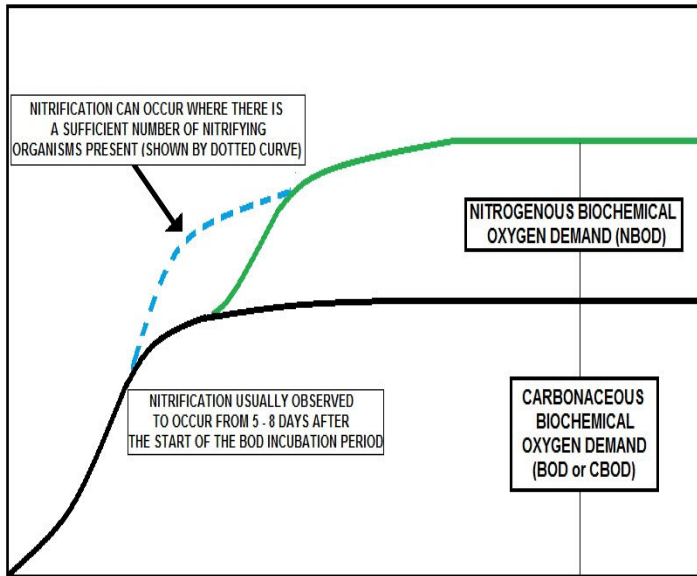

EXAMPLE OF WHY 5th DAY TESTING FOR BOD IS CONDUCTED

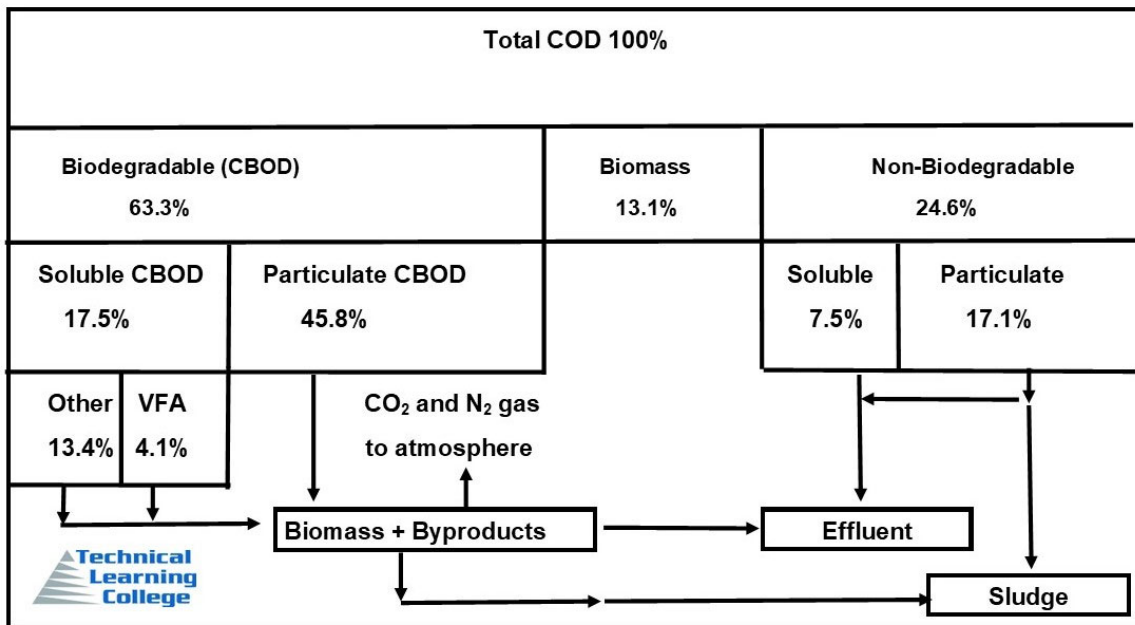

ORGANIC WASTEWATER FRACTION BREAKDOWN DIAGRAM #1

Specific Oxygen Uptake Rate (SOUR) Sub-Section

This laboratory activity explores the Specific Oxygen Uptake Rate analysis (SOUR) and its use in measuring the metabolic activity of organisms in aquatic systems.

Focus

Microorganisms use oxygen as they consume food in an aerobic aquatic system. The rate at which they use oxygen is an indicator of the biological activity of the system and is called the Oxygen Uptake Rate (OUR).

High oxygen uptake rates indicate high biological activity; low oxygen uptake rates indicate low biological activity. In biological waste treatment facilities, oxygen uptake rates are used to monitor performance of process units. The analysis is based on a series of dissolved oxygen (DO) measurements taken on a sample over a period of time. The test is most valuable for plant operations when combined with volatile suspended solids data.

Combining oxygen uptake and volatile suspended solids data yields a value called the Specific Oxygen Uptake Rate (SOUR). Specific Uptake Rates (SOUR) describe the amount of oxygen used by the microorganisms to consume one gram of food and is reported as mg/L of oxygen used per gram of organic material per hour.

The specific uptake rate is valuable when comparing one aquatic system with another or if a single system is to be charted over time. The performance of one aeration basin can be compared with another or the biological activity in a stream can be studied and compared both above and below a waste outfall. Furthermore, toxic or high organic loads can often be detected before severe deterioration of effluent quality occurs. Changes in the SOUR on effluent samples will indicate changes in loading.

Reason for Testing

Biological waste treatment in the activated sludge process is based on the ability of the microorganisms to utilize dissolved oxygen in breaking down soluble organic substances. The oxygen uptake test is a means of measuring the respiration rate of the organisms in the activated sludge process.

Since it measures the oxygen used in the process, it is a useful tool in the evaluation of process performance, aeration equipment and biodegradability of the waste. So that comparisons can be made between various plants, it is usually expressed as the SOUR (specific uptake rate); i.e. the amount of oxygen in mg utilized by one gram of the volatile suspended solids in the activated sludge.

Process Modification SOUR Range (mg/hr/g VSS)

Conventional 8-20

Step aeration 8-20

Extended aeration 3-12

Contact stabilization 5-15

Significance of SOUR Values Values (mg/hr/g VSS)	Rate of Oxygen Consumption	Significance
>20	High	Not enough solids for the BOD loading
12-20	Normal	Good BOD removal and sludge settling
<12	Low	Too many solids or presence of toxicity

Typical Ranges of Specific Oxygen Uptake Rates (SOUR) for Various Modifications of the Activated Sludge Process at Aeration Tank Effluent

$$\text{SOUR, (mg/g)/hr} = \frac{\text{OUR, mg O}_2/\text{L}/\text{min} \times \frac{60 \text{ min}}{1 \text{ hr}}}{\text{VSS (mg/L)} \times \frac{1 \text{ g}}{1000 \text{ mg}}}$$

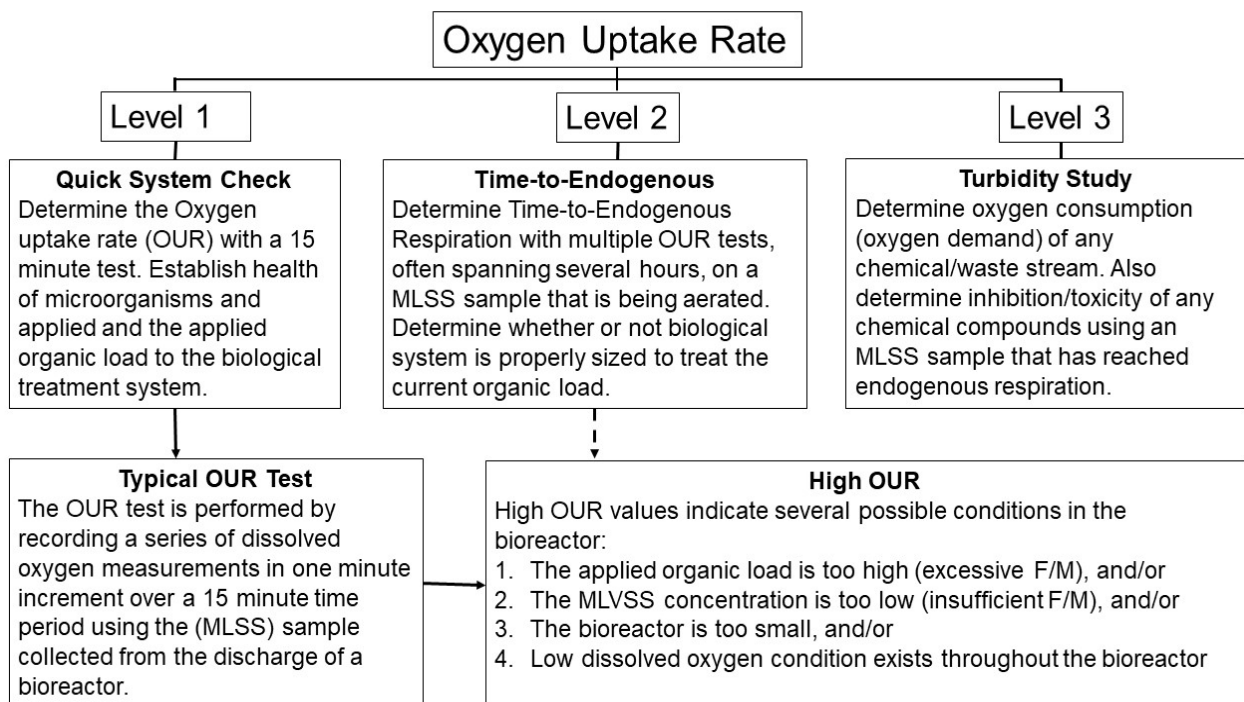

Total Dissolved Solids (TDS) Sub-Section

Water is a good solvent and picks up impurities easily. Pure water is tasteless, colorless, and odorless and is often called the universal solvent. Dissolved solids refer to any minerals, salts, metals, cations or anions dissolved in water. Total dissolved solids (TDS) comprise inorganic salts (principally calcium, magnesium, potassium, sodium, bicarbonates, chlorides and sulfates) and some small amounts of organic matter that are dissolved in water.

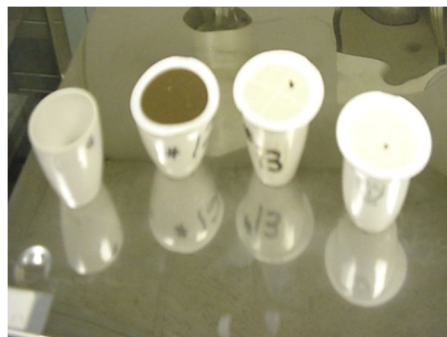

Total Dissolved Solids (TDS) are solids in water that can pass through a filter (usually with a pore size of 0.45 micrometers). TDS is a measure of the amount of material dissolved in water.

This material can include carbonate, bicarbonate, chloride, sulfate, phosphate, nitrate, calcium, magnesium, sodium, organic ions, and other ions. A certain level of these ions in water is necessary for aquatic life.

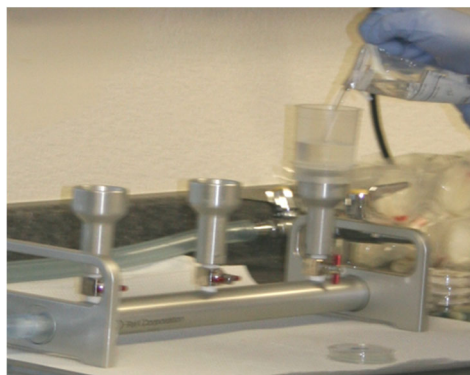

Changes in TDS concentrations can be harmful because the density of the water determines the flow of water into and out of an organism's cells (Mitchell and Stapp, 1992). However, if TDS concentrations are too high or too low, the growth of many aquatic lives can be limited, and death may occur.

Similar to TSS, high concentrations of TDS may also reduce water clarity, contribute to a decrease in photosynthesis, combine with toxic compounds and heavy metals, and lead to an increase in water temperature.

TDS is used to estimate the quality of drinking water, because it represents the amount of ions in the water. Water with high TDS often has a bad taste and/or high water hardness, and could result in a laxative effect.

The TDS concentration of a water sample can be estimated from specific conductance if a linear correlation between the two parameters is first established. Depending on the chemistry of the water, TDS (mg/l) can be estimated by multiplying specific conductance (micromhos/cm) by a factor between 0.55 and 0.75. TDS can also be determined by measuring individual ions and adding them up.

TDS in drinking-water originate from natural sources, sewage, urban run-off, industrial wastewater, and chemicals used in the water treatment process, and the nature of the piping or hardware used to convey the water, i.e., the plumbing. In the United States, elevated TDS has been due to natural environmental features such as: mineral springs, carbonate deposits, salt deposits, and sea water intrusion, but other sources may include: salts used for road de-icing, anti-skid materials, drinking water treatment chemicals,

stormwater and agricultural runoff, and point/non-point wastewater discharges. In general, the total dissolved solids concentration is the sum of the cations (positively charged) and anions (negatively charged) ions in the water. Therefore, the total dissolved solids test provides a qualitative measure of the amount of dissolved ions, but does not tell us the nature or ion relationships.

In addition, the test does not provide us insight into the specific water quality issues, such as: Elevated Hardness, Salty Taste, or Corrosiveness. Therefore, the total dissolved solids test is used as an indicator test to determine the general quality of the water.

Total Suspended Solids (TSS)

Total suspended solids (TSS) is the dry-weight of suspended particles that are not dissolved, in a sample of water that can be trapped by a filter that is analyzed using a filtration apparatus. It is a water quality parameter used to assess the quality of a specimen of any type of water or water body, ocean water for example, or wastewater after treatment in a wastewater treatment plant. It is listed as a conventional pollutant in the U.S. Clean Water Act.

Total dissolved solids is another parameter acquired through a separate analysis which is also used to determine water quality based on the total substances that are fully dissolved within the water, rather than undissolved suspended particles.

Total Solids

The term "total solids" refers to matter suspended or dissolved in water or wastewater, and is related to both specific conductance and turbidity.

Total solids (also referred to as total residue) are the term used for material left in a container after evaporation and drying of a water sample.



Total Solids includes both total suspended solids, the portion of total solids retained by a filter and total dissolved solids, the portion that passes through a filter (American Public Health Association, 1998).

Total solids can be measured by evaporating a water sample in a weighed dish, and then drying the residue in an oven at 103 to 105° C.

The increase in weight of the dish represents the total solids. Instead of total solids, laboratories often measure total suspended solids and/or total dissolved solids.

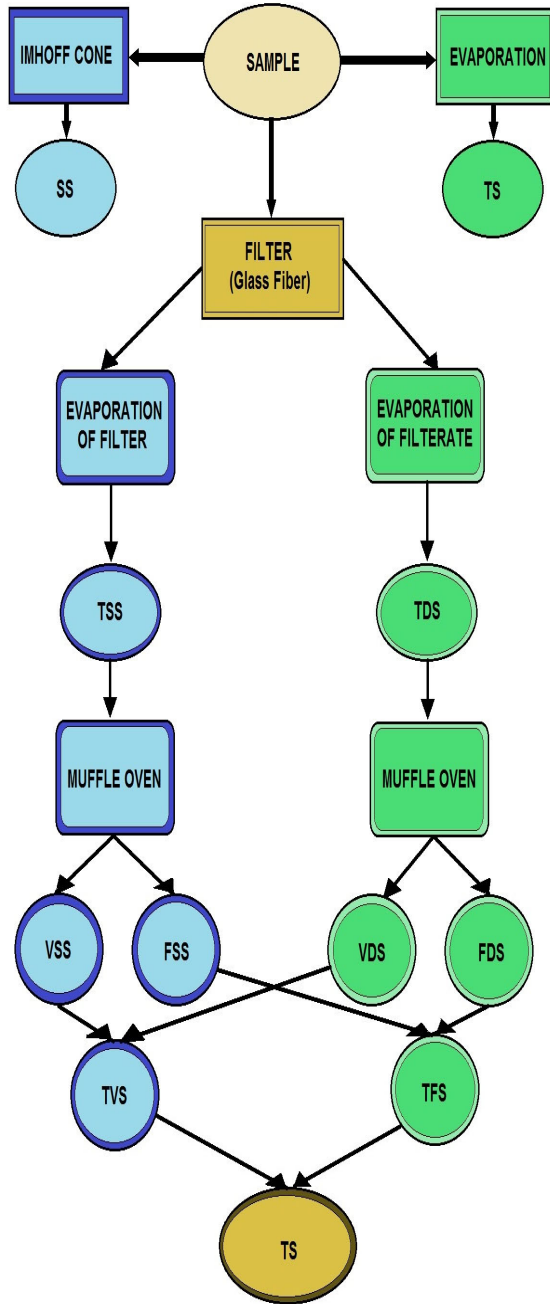

TSS: Total Suspended Solids
SS : Settled Solids
TS : Total Solids
FSS: Fixed Suspended Solids
TDS: Total Dissolved Solids
VDS: Volatile Dissolved Solids
FDS: Fixed Dissolved Solids
TVS: Total Volatile Solids
TFS: Total Fixed Solids
VSS: Volatile Suspended Solids



EQUIPMENT USED TO MEASURE AND DETERMINE TYPES OF SOLIDS

DETERMINATION OF DIFFERENT TYPES OF SOLIDS



Lab tech removing filter for TSS analysis.

Types of Solids in Wastewater

ACRONYM	COMMON TERM	EXPLANATION
TSS	Total Suspended Solids	Solids that cannot pass through a 1.2- μm filter.
TVSS	Total Volatile Suspended Solids	Solids that cannot pass through a 1.2 - μm filter and are burned away when placed in a furnace at 550° C.
TDS	Total Dissolved Solids	Solids that are small enough to pass through a 1.2 - μm filter. The sample must be dried completely before the dissolved solids can be seen with the naked eye.
TS	Total Solids	All of the solid material in a sample. This includes both organic and inorganic solids. $\text{TS} = \text{TSS} + \text{TDS}$
TVS	Total Volatile Solids	All of the solids in a sample that are burned away when placed in a furnace at 550° C

Total Suspended Solids (TSS)

Total Suspended Solids (TSS) are solids in water that can be trapped by a filter. TSS can include a wide variety of material, such as silt, decaying plant and animal matter, industrial wastes, and sewage. High concentrations of suspended solids can cause many problems for stream health and aquatic life.

High TSS can block light from reaching submerged vegetation. As the amount of light passing through the water is reduced, photosynthesis slows down. Reduced rates of photosynthesis causes less dissolved oxygen to be released into the water by plants. If light is completely blocked from bottom dwelling plants, the plants will stop producing oxygen and will die. As the plants are decomposed, bacteria will use up even more oxygen from the water. Low dissolved oxygen can lead to fish kills.



Sampling downstream from a wastewater plant's discharge point.

High TSS can also cause an increase in surface water temperature, because the suspended particles absorb heat from sunlight. This can cause dissolved oxygen levels to fall even further (because warmer waters can hold less DO), and can harm aquatic life in many other ways, as discussed in the temperature section. (The decrease in water clarity caused by TSS can affect the ability of fish to see and catch food.

Suspended sediment can also clog fish gills, reduce growth rates, decrease resistance to disease, and prevent egg and larval development. When suspended solids settle to the bottom of a water body, they can smother the eggs of fish and aquatic insects, as well as suffocate newly hatched insect larvae. Settling sediments can fill in spaces between rocks which could have been used by aquatic organisms for homes.



Dead fish in lake using reclaimed water.

High TSS in a water body can often mean higher concentrations of bacteria, nutrients, pesticides, and metals in the water. These pollutants may attach to sediment particles on the land and be carried into water bodies with storm water. In the water, the pollutants may be released from the sediment or travel farther downstream.

High TSS can cause problems for industrial use, because the solids may clog or scour

pipes and machinery.

Measurement of Total Suspended Solids

To measure TSS, the water sample is filtered through a pre-weighed filter. The residue retained on the filter is dried in an oven at 103 to 105° C until the weight of the filter no longer changes. The increase in weight of the filter represents the total suspended solids. TSS can also be measured by analyzing for total solids and subtracting total dissolved solids.

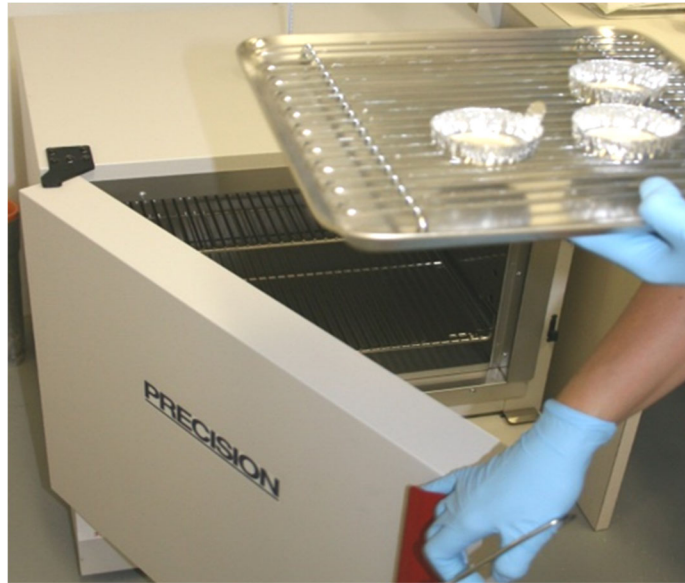

These filters (cookies) contain samples from the primary influent that are lighter than activated sludge samples

Settleometer Test

A simple procedure called the Settleometer Test is used to determine the settling characteristics of mixed liquor. The test requires a settleometer, which is typically a clear plastic cylinder with a capacity of 2 liters. Graduations on the cylinder range from 100 to 1000 cubic centimeters (or milliliters) of settled sludge per liter.

A sample of mixed liquor should be obtained from the discharge end of the aeration tank, being careful not to include scum in the sampling container. Do not allow the sample to set for more than a few minutes before the settling test is performed. Determine the MLSS concentration in milligrams per liter on a portion of this sample.

Mix the sample well, and fill the settleometer to the 1000 graduation. Immediately start a timer and at the end of 30 minutes record the settled sludge volume in the settleometer.

It is a good idea to occasionally record the settled sludge volume every 5 minutes while the solids are settling and prepare a graph of settled sludge volume versus minutes. This allows the operator to see whether the solids are settling too quickly or slowly. Solids that settle too quickly may be an indication of an old sludge that will probably leave straggler floc in the effluent, while solids that settle too slowly or do not compact well may be washed out of the clarifier during times of high hydraulic load.

Denitrification

It is also a good practice to allow the sample to set in the settleometer for an additional 30 to 60 minutes after the settling test. Watch for tiny bubbles that form in the settled sludge. These nitrogen bubbles form as nitrate is reduced to nitrogen gas (denitrification) under anoxic conditions.

As the bubbles rise, they attach themselves to floc particles and float them to the surface. A small amount of denitrification occurring in the secondary clarifier will cause a scum to form on the surface, while a large amount of denitrification may float a significant portion of the biomass to the top of the clarifier. The settleometer test may give the operator the first warning that this may become a problem.

Volume of the Biomass

Two main factors determine the settled sludge volume in the settleometer at the end of the 30 minutes. The first, solids compaction indicates how much volume the biomass will occupy. But the operator must recognize the influence of the second factor, MLSS concentration, in settled sludge volume. As long as the MLSS does not change, settleometer test results can be compared from one day to the next.

Nevertheless, as the MLSS increases, the settled sludge volume in the settleometer will usually increase. Since we use the settleometer test mainly to indicate how well the mixed liquor compacts, we must account for the concentration of the biomass in the settleometer. This allows the operator to track changes in sludge quality even though the MLSS concentration changes.

SETTLING TEST OBSERVATION / LOOKING FOR BULKING SLUDGE

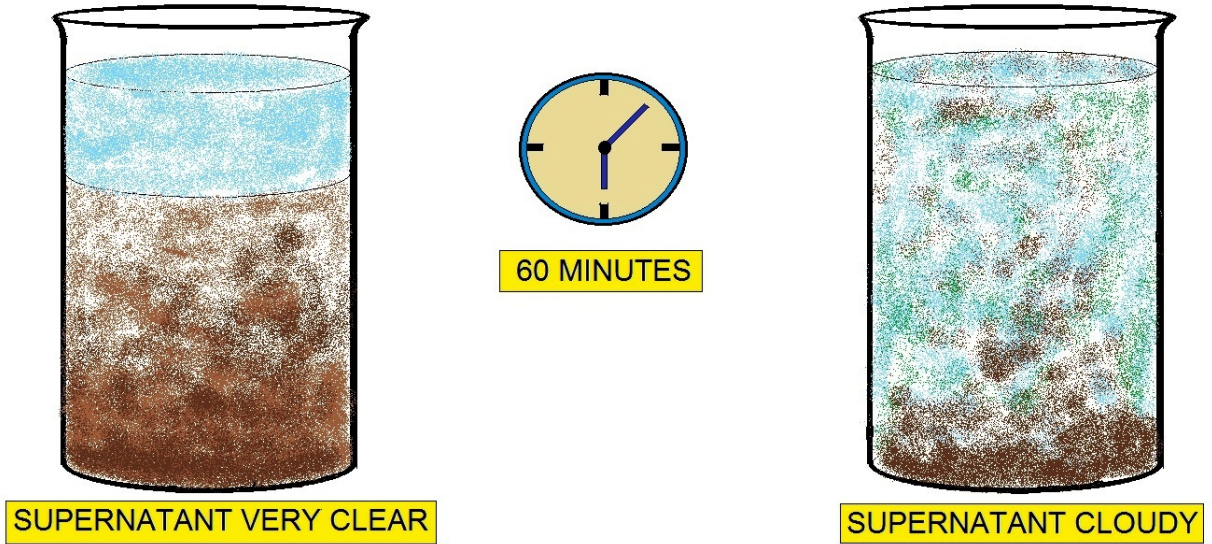

BULKING SLUDGE DOES NOT SETTLE WELL

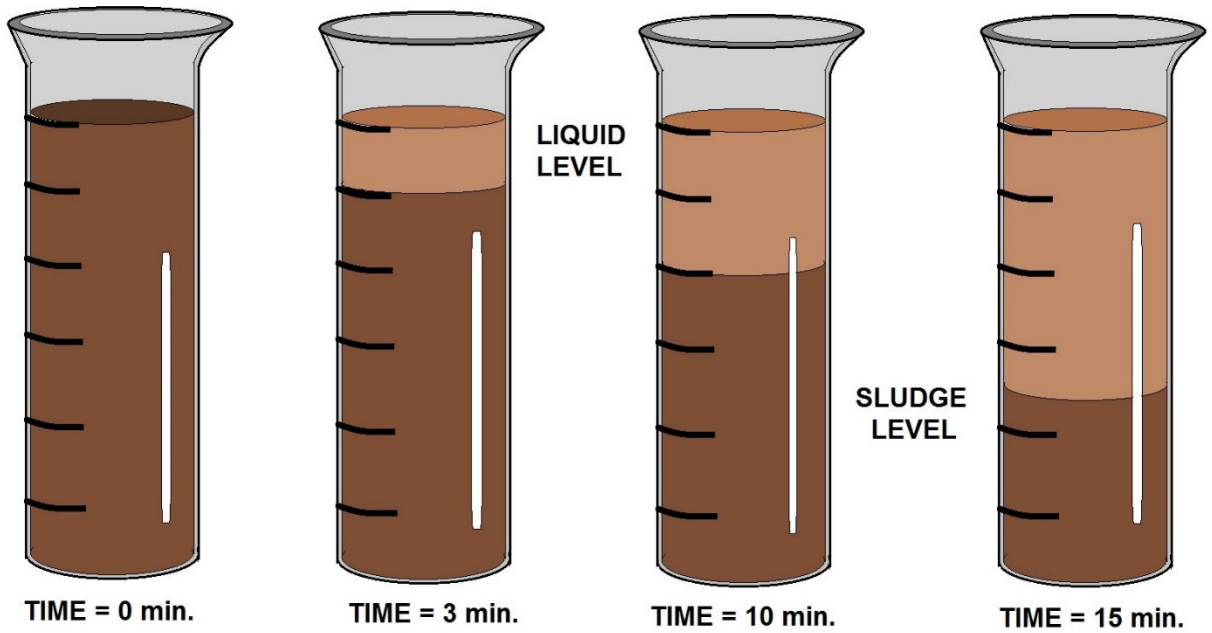

RAPIDLY SETTLING MIXED LIQUOR CAN LEAVE A POOR QUALITY SUPERNATANT

Mixed Liquor and Microorganism Review

This substance (MLSS) in healthy sludge is a brown floc. It is largely composed of saprotrophic bacteria but also has an important protozoan flora component mainly composed of amoebae, Spirotrichs, Peritrichs including Vorticellids and a range of other filter-feeding species. Other important organisms include motile and sedentary Rotifers.

In poorly managed activated sludge, a range of mucilaginous (sticky secretion) filamentous bacteria can develop including *Sphaerotilus natans*, which produces a sludge that is difficult to settle. This result in the sludge blanket decanting over the weirs in the secondary clarifier to severely contaminate the final effluent quality.

In all activated sludge plants, once the wastewater has received sufficient treatment, excess mixed liquor is collected into settling tanks and the treated supernatant is run off to undergo further treatment before discharge. Part of the settled sludge material, is returned to the head of the aeration system to re-seed the new wastewater entering the tank. This fraction of the floc is called *return activated sludge* (RAS).

MLVSS

Mixed liquor volatile suspended solids (MLVSS) is generally defined as the microbiological suspension in the aeration tank of an activated-sludge biological wastewater treatment plant.

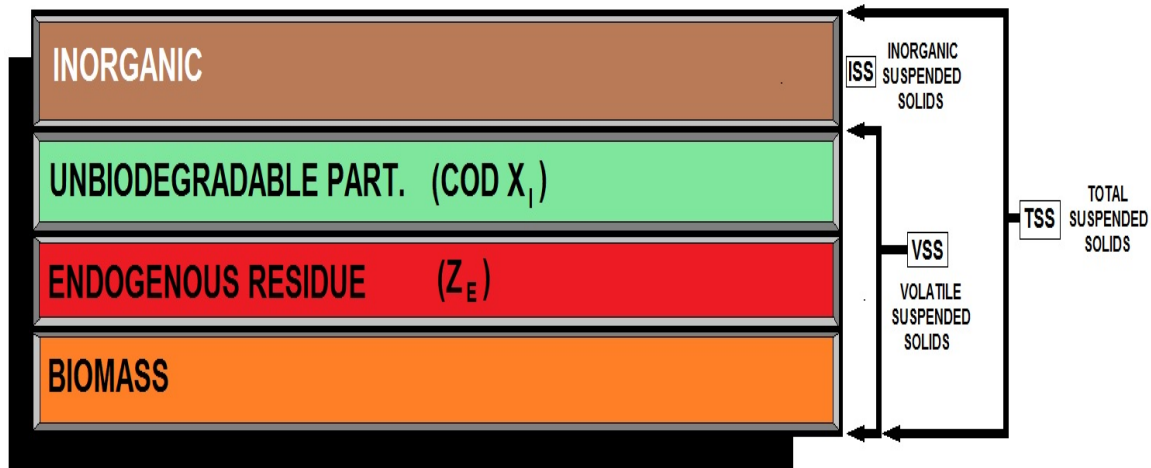

COMPONENTS OF MIXED LIQUOR SUSPENDED SOLIDS

Why Measure MLSS

If MLSS content is too high the process is prone to bulking and the treatment system becomes overloaded, this can cause the dissolved oxygen content to drop with the effect that organic matters are not fully degraded and biological 'die off'.

Conversely, if the MLSS content is too low the process is not working efficiently, and is likely to be wasting energy whilst not treating the effluent effectively. The typical control band is 2,000 to 4,000 mg/l.

RAS and WAS

A proportion of the floc is called Return Activated Sludge (RAS) and is used to maintain the desired MLSS value. Settled activated sludge that is collected in the secondary clarifier or the membrane basin and returned to the aeration basin to mix with incoming raw or primary settled wastewater.

RAS CONCENTRATION

Varying the return activated sludge (RAS) flow rate will affect the concentration and detention time of clarified solids. Adjusting the RAS pumping rate allows the return of more or less concentrated solids while also increasing or decreasing the depth of the sludge blanket. RAS flow rates can be paced off influent flow rates, time, or organic loading.

Measuring the solids concentration of RAS allows the return volume to be adjusted to keep the solids level in the aeration basin within the control parameters. Excess sludge which eventually accumulates beyond that returned is defined as Surplus or Waste Activated Sludge (SAS/WAS). This is removed from the treatment process to keep the ratio of biomass to food supplied (sewage or wastewater) in balance. Typical Range of the RAS is: 4,000 to 6,000 mg/l.

Final Clarifier Operation

The process involves oxygen or air being introduced into a mixture of screened, and primary treated wastewater combined with organisms to develop a biological floc that reduces the organic content of the sewage. Return activated sludge (RAS) comes from this or similar clarifiers. The purpose of the final clarifier is to separate the activated sludge, the biological floc, from the treated water. The floc will settle to form sludge that will be returned to the process or wasted for sludge conditioning.

Suspended Matter for Mixed Liquor and Return Sludge (MLSS)

The quantity of suspended matter in mixed liquor and return sludge can be used to determine process status, estimate the quantity of biomass, and evaluate the results of process adjustments.

Apparatus

- Buchner funnel and adaptor
- Filter flask
- Filter paper 110 mm diam., Whatman 1-4
- 103^o drying oven
- Desiccator
- Balance
- Graduated Cylinder

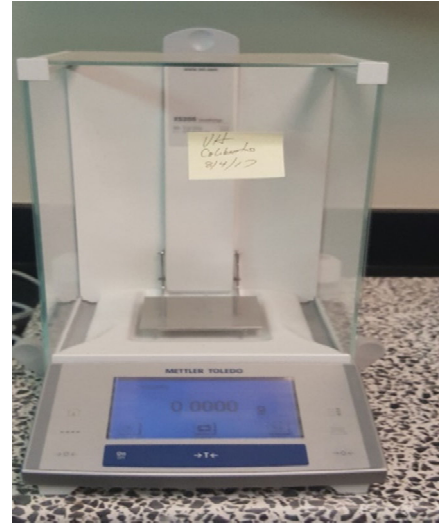

Procedure

1. Dry the filter papers in oven at 103^o c to remove all traces of moisture.
2. Remove papers from oven and desiccate to cool for approximately 5 minutes.
3. Weigh to the nearest 0.01g and record the mass (W₁)
4. Place the paper in the bottom of the Buchner funnel and carefully arrange so that the outer edges lay snugly along the side. Careful not to touch it with your finger. Use a glass rod. Wet the paper, turn on the vacuum and make a good seal, make a pocket covering the bottom of the funnel.
5. Add 20 to 100 mls of sample at a sufficient rate to keep the bottom of the funnel covered, but not fast enough to overflow the pocket made by the filter paper. Record the volume used.
6. Remove the filter paper with tweezers. Dry in a 103^o c oven for 30 minutes. Remove and desiccate. Reweigh the filter paper (W₂) to the nearest 0.01g.

Calculation:

mg/L Suspended Matter

$$\frac{(W_2) - (W_1) \times 1000 \text{ ml/L}}{\text{ml Sample}}$$

Where:

(W₁) and (W₂) are expressed in mg.

(W₁) = mass of the prepared filter

(W₂) = mass of the filter and sample after the filtration step.



Total dissolved solids - The weight per unit volume of all volatile and non-volatile solids dissolved in a water or wastewater after a sample has been filtered to remove colloidal and suspended solids. The lab tech is filtering a wastewater sample.



Top left, filters being baked at 105°C. Right photograph, filters in desiccant.

Sludge Volume Index (SVI) Formula

SVI is used by operators to determine and compare mixed liquor settleability. It mathematically relates settled sludge volume in the settleometer to MLSS concentration.

The definition for SVI is: The volume in milliliters occupied by one gram of activated sludge that has settled for 30 minutes. Note that SVI relates sludge volume in milliliters to MLSS concentration in grams per liter.

A simple formula for SVI is:

$$\text{SVI} = \frac{\text{mls Settled in 30 min}}{\text{MLSS Conc, grams/L}} \quad \text{or} \quad \text{SVI} = \frac{\text{mls Settled}}{\text{MLSS, mg/l} / 1000}$$

Sludge Density Index (SDI)

SDI is another way to express sludge compaction, makes use of the same information as SVI, but expresses it as sludge density (weight per volume rather than volume per weight).

The definition for SDI is: The grams of activated sludge which occupies a volume of 100 ml after 30 minutes of settling.

The formula for SDI is:

$$\text{SDI} = \frac{\text{grams/L of MLSS}}{\text{mls settled in 30 min} / 100} \quad \text{or} \quad \frac{\text{MLSS, mg/L} / 1000}{\text{mls settled in 30 min} / 100}$$

Consider the example given above where MLSS is 2400 mg/L and after 30 minutes of settling the sludge occupies a volume of 260 ml. The SDI is calculated as follows:

$$\text{SDI} = \frac{2400 \text{ mg/l} / 1000}{260 \text{ ml} / 100} = \frac{2.4}{2.6} = 0.92$$

Oxygen Uptake Rate (OUR) and Specific Oxygen Uptake Rate (SOUR)

Oxygen Uptake Rate (OUR) is an important wastewater control parameter for activated sludge process carried out using dissolved oxygen analyzer that measures the amount of oxygen used up by the microorganisms expressed in unit time of **mg/L (ppm) per hour**.

Conducting the Level 1 OUR Test

The OUR test is easily performed by recording a series of dissolved oxygen measurements in one minute increments over a 15 minute time period from a mixed liquor suspended solids (MLSS) sample **collected from the discharge of a bioreactor**. It should be noted that high organic loading conditions will result in oxygen depletion in the MLSS sample in less than 15 minutes.

Sludge Volume Index (SVI) Procedure

1. Pour sample of mixed liquor from the process into a 2-liter settlometer.
2. Allow it to settle for 30 minutes
3. After the time period, read the marking to determine the volume occupied by the settled sludge. The reading is expressed in terms of mL/L and this figure is known as the sludge volume SV value.
4. Next, for MLSS, there are actually two approaches to get the value. A conventional standard approach is by filtering the sludge, drying it and then weigh the second portion of the mixed liquid. However, this can be time consuming and a faster way is by using a MLSS meter.

Calculation:

The results obtained from the suspended matter test and settleability test on aerated mixed liquor are used to obtain the SVI.



Well-settled mixed liquor with a clear supernatant

Calculation:

$$\text{SVI} = \frac{\text{sludge volume SV}}{\text{MLSS}} \times 1000$$

SETTLEABILITY TEST

The settleability test is an analysis of the settling characteristics of the activated sludge mixed liquor suspended solids (MLSS). This analysis is often referred to as "running a settlometer." The analysis is normally done within the treatment plant rather than a certified laboratory.

This analysis includes five basic items:

1. A clear container to hold the MLSS
2. A timing device or clock to track elapsed time
3. A paddle or other mixing device
4. A clip board, or place to record the readings
5. Operator patience, attentiveness and diligence





The settleometer is a great tool for operators. It indicates how the solids will settle in the clarifier and the density of the sludge.

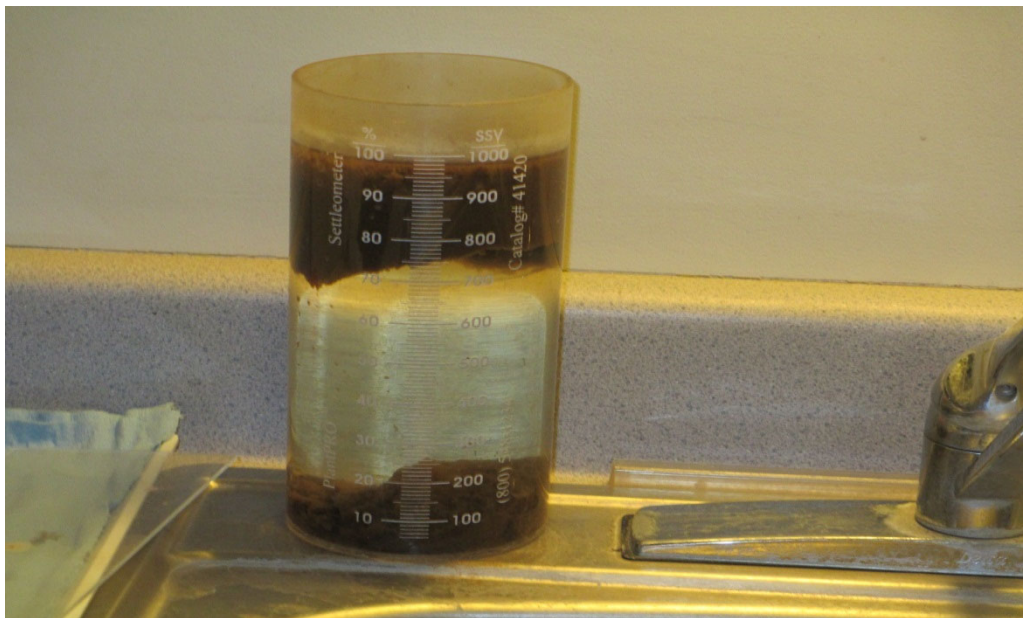

During the settleometer test, operators not only check how the solids settle out they can also determine the rate of denitrification in the clarifier. This rising sludge is the result of denitrification.

Sludge Volume Index Lab Report Worksheet

Suspended Mater Calculations:

(W₁) = _____ mg Duplicate (W₁) = _____ mg

(W₂) = _____ mg (W₂) = _____ mg

mls Sample = _____ mls Sample = _____

mg/L suspended matter = _____ dup. _____

Settleability Calculations:

% settled sludge = _____

$$\frac{(\text{ml of sludge in settled mixed liquor or returned sludge} \times 100)}{1000}$$

Sludge Volume Index Calculations:

$$\frac{(\text{ml of sludge in settled mixed liquor in 30 minutes} \times 1000 \text{ mg/g})}{\text{mg/L of suspended matter in mixed liquor}}$$

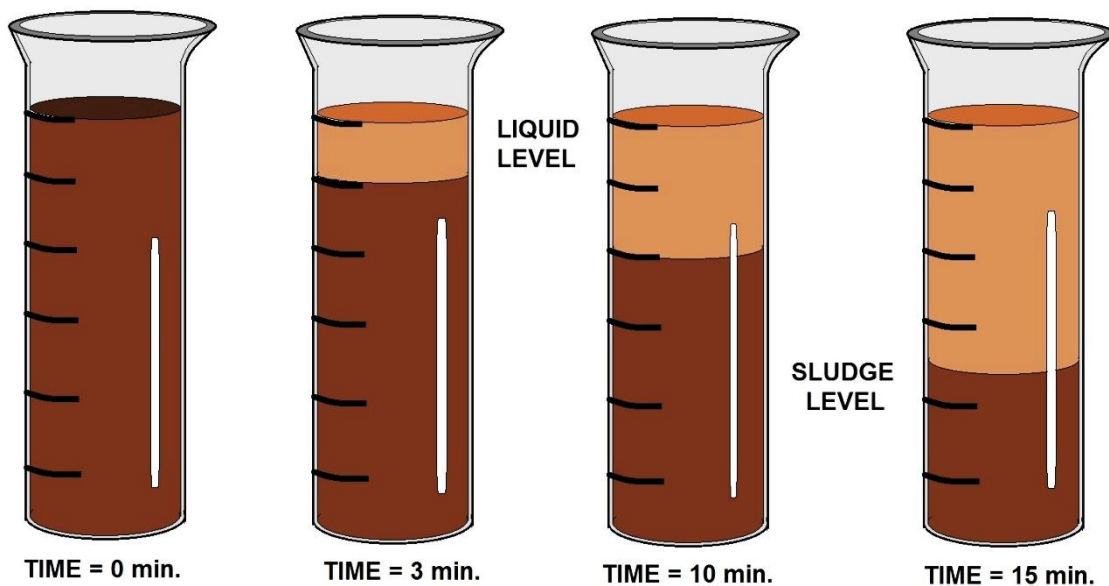

MIXED LIQUOR DEFINITION

Mixed liquor suspended solids (MLSS) is the concentration of suspended solids in an aeration tank during the activated sludge process, in the treatment of wastewater. Mixed liquor is a combination of raw or unsettled wastewater and activated sludge within an aeration tank. The solids are comprised of biomass, nonbiodegradable volatile suspended solids (nbVSS), and inert inorganic total suspended solids (iTSS).

MLSS

Mixed Liquor Suspended Solids (MLSS) is the total suspended solids in a sample of mixed liquor. The units MLSS is primarily measured in are milligrams per liter (mg/L). This test is essentially the same as the test performed for TSS in the last lab, except for the use of mixed liquor as the water sample. In addition, the concentration of suspended solids found in the mixed liquor is much greater than that found in the raw or treated water. MLSS concentrations are usually greater than 1,000 mg/L, but should not exceed 4,000 mg/L.

MLVSS

Mixed Liquor Volatile Suspended Solids is generally defined as the microbiological suspension in the aeration tank of an activated-sludge biological wastewater treatment plant. The biomass solids in a biological waste water reactor are usually indicated as total suspended solids (TSS) and volatile suspended solids (VSS). The mixture of solids resulting from combining recycled sludge with influent wastewater in the bioreactor is termed mixed liquor suspended solids (MLSS) and mixed liquor volatile suspended solids (MLVSS).

MIXED LIQUOR CALCULATION

$$\text{MLSS (g/L)} = \text{SV [mL/L]} / \text{SVI [mL/g]}$$

Where:

SVI = sludge volume index (mL/g)

SV = Volume of settled solids per 1 litre after 30 minutes

SVI is a calculation from two analyses: SV30 and MLSS.

$$0 = (Q + Q_r)(X') - (Q_r X'_r + Q_w X'_r)$$

Where:

Q = wastewater flow rate (m³/d)

Q_r = return sludge flow rate (m³/d)

X' = MLSS (kg/m³)

X'_r = return sludge concentration (kg/m³)

Q_w = sludge wasting flow rate (m³/d)



MIXED LIQUOR ADJUSTMENT

If content is too high

1. The process is prone to bulking of solids and the treatment system can become overloaded.
2. This can cause the dissolved oxygen content to drop; this may reduce the efficiency of nitrification and the settleability of the sludge.
3. Excessive aeration will be required, which wastes electricity.
4. It will create thick foam on upper layer.

If content is too low

1. The process may not remove sufficient organic matter from the wastewater.
2. The sludge age may be too low to enable nitrification.

The typical control band for the concentration of MLSS is 2 to 4 g/L for conventional activated sludge, or up to 15 g/l for membrane bioreactors.



Fecal Coliform Analysis Sub-Section

FECAL TESTING CONCEPT

A sample is collected and analyzed using aseptic (sterile) technique. A measured volume of sample is filtered through a sterile 0.45 μ membrane filter, transferred to an absorbent pad containing m-FC broth, then incubated at 44.5°C for 24 hours. Blue/blue gray colonies are counted and reported as colony forming units (cfu) per 100 ml of sample. The method is limited by turbidity in the sample. Excessive turbidity will reduce fecal coliform recovery, requiring the MPN method to be used instead of the membrane filter method.



Sample Collection

Fecal coliform test samples must be collected in a clean, sterile borosilicate glass or plastic bottle containing sodium thiosulfate. Pre-sterilized bags or bottles containing sodium thiosulfate can also be used. Sodium thiosulfate is added to remove residual chlorine which will kill fecal coliforms during transit. 0.1 ml of 10% sodium thiosulfate is added to a 120 ml sample bottle prior to sterilization. The minimum bottle size should be 120 ml to allow enough head space (1") for proper sample mixing.

Collection Procedure

Select a site that will provide a representative sample. Fecal coliform samples are always grab samples and should be drawn directly from the flow stream without using collection devices. We do not want to cross contaminate the sample. Keep the sample bottle lid closed tightly until it is to be filled.

Remove the cap and do not contaminate the inner surface of the bottle, neck, threads or cap. Fill the container without rinsing, being sure to leave ample air space to allow mixing. Rinsing will remove the dechlorinating agent. All samples should be labeled properly with date and time of collection, sampler's name, and sample collection location. Leaking sample bottles allow for contamination of the sample and should be discarded and the sampling repeated.

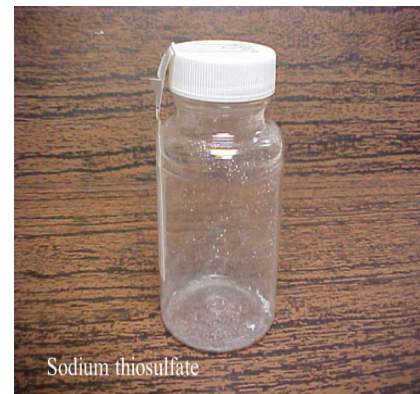

Preservation

Fecal coliform samples should be analyzed as soon as possible after collection to prevent changes to the microorganism population. Fecal coliforms must be transported on ice, if they cannot be analyzed within 1 hour of collection. Fecal coliform samples transported at ambient temperature may reproduce and create a higher bias to the numbers than desired. They may be killed off, resulting in lower numbers, if handled poorly such as transport in sunlight. Fecal coliform samples should be stored by the laboratory in a refrigerator until

time of analysis. The maximum holding time for state or federal permit reporting purposes is 6 hours.

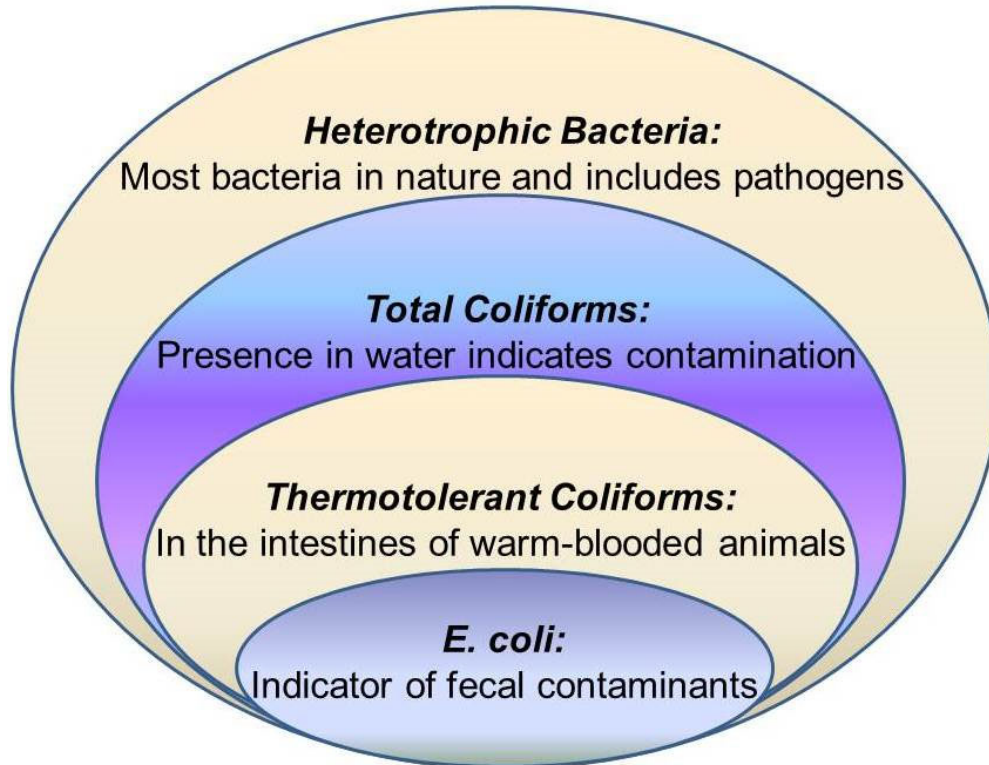

The U.S. EPA published the Methods Update Rule in the *Federal Register* on August 28, 2017, adding another approval to the list for Colilert®-18. This simple, rapid test was already EPA-approved for a wide range of water types, including *E. coli* testing of wastewater.

Now Colilert-18 is also approved for the detection of fecal coliforms in wastewater when incubated at 44.5°C.

- Provides clear, quantifiable results in just 18 hours.
- Eliminates media preparation and colony counting.
- Simplifies training, testing, and quality control (QC).
- Speeds up testing with less than 1 minute of hands-on time—no confirmations needed.
- Expert guidance on state and regional accreditation

Photo Journal #5

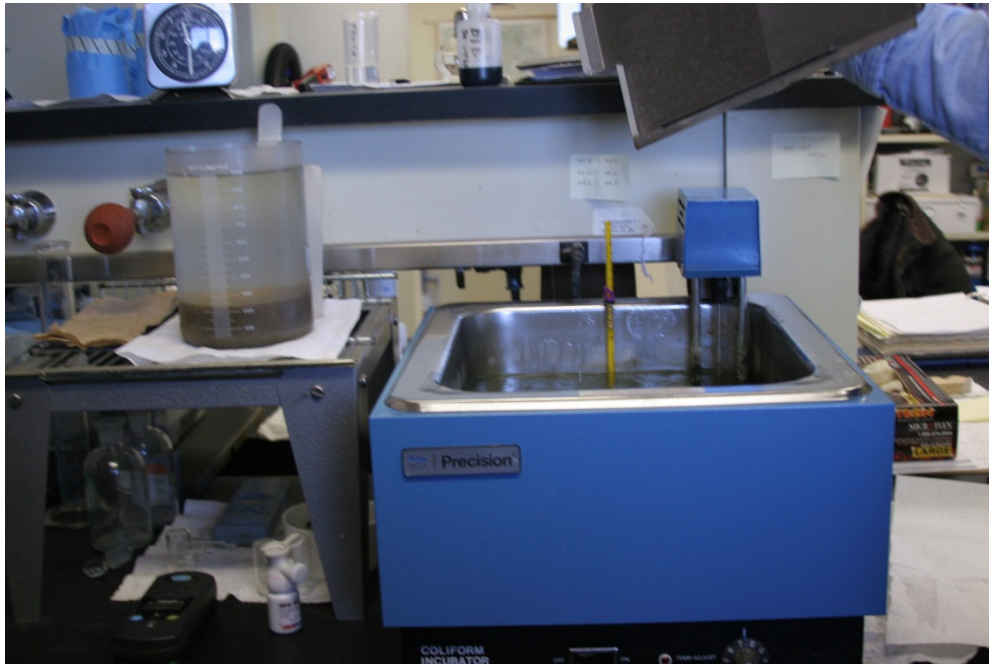

An incubator bath for the coliform test. The operator will place the sample in this device for 24 to 48 hours depending on the desired tests. There are several different methods to calculate coliform bacteria. This is an older true-and-tested method.

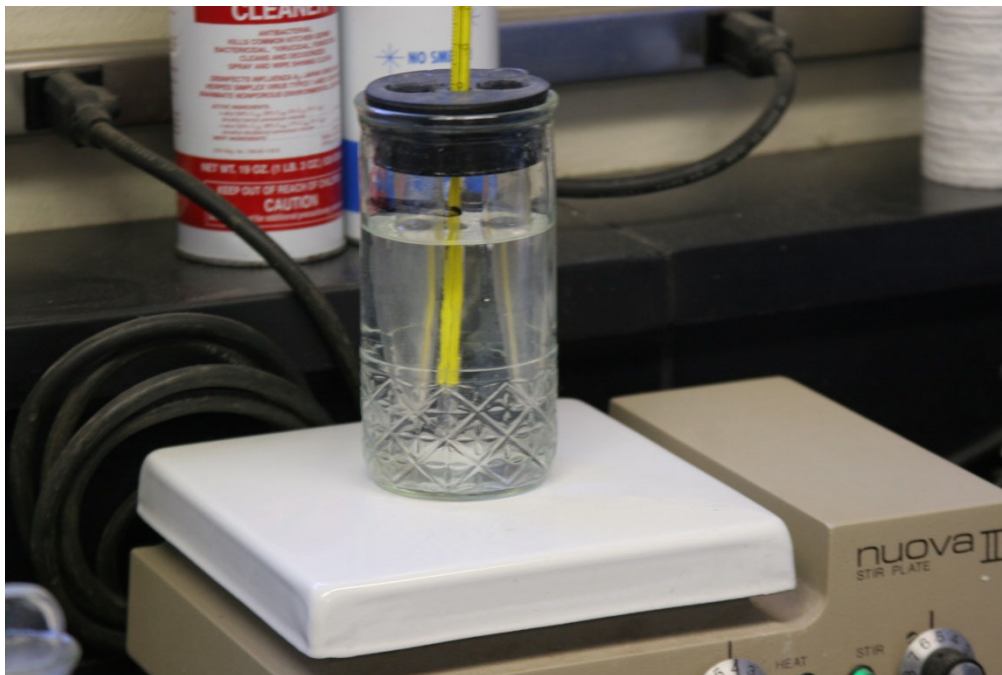

This glass bottle is used for quality control (QA/QC) for bacteria samples tubes.



Lab technician should be wearing safety glasses/goggles for preparation of the fecal test.



This operator is splitting the sample for bacteriological analysis. Always wear gloves for your and others' safety. We have all seen the operator who holds a sandwich in one hand while working in the lab, or the operator who does not wear gloves at all.



Optical microscopes are used to see indicator bugs and other microorganisms. This examination is used so that the operator knows how well the process is working.

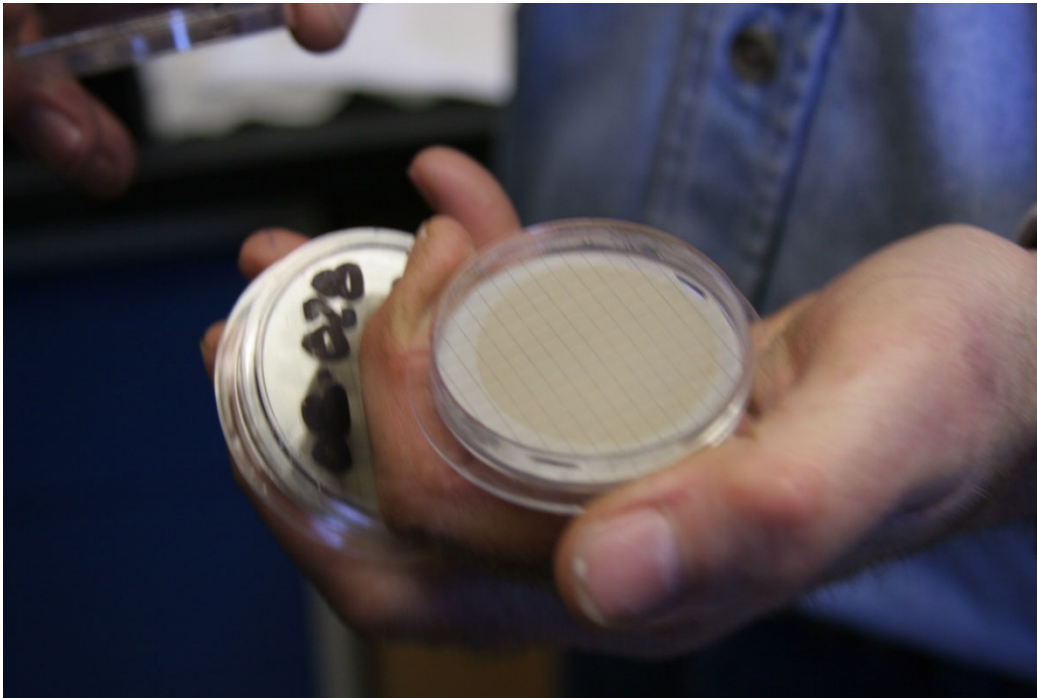

This is a filter used for the coliform test.

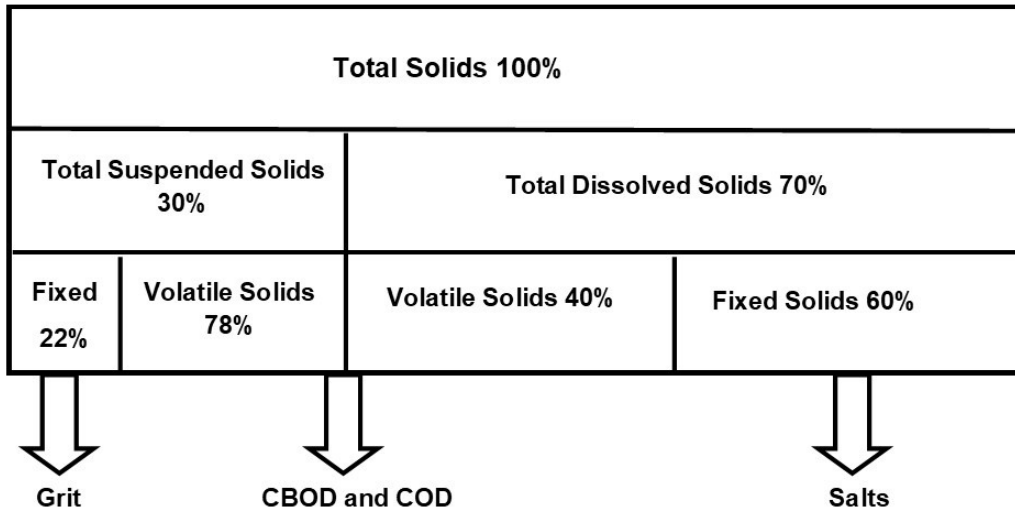

WASTEWATER SOLIDS BREAKDOWN DIAGRAM

Pass-Through /Emerging Wastewater Contaminants Sub-Section

This section provides a brief background on emerging contaminants and key findings from studies on the co-removal of emerging contaminants by nutrient removal technologies.

The term “emerging contaminants” refers broadly to those synthetic or naturally occurring chemicals, or to any microbiological organisms, that have not been commonly monitored in the environment but which are of increasing concern because of their known or suspected adverse ecological or human health effects.

Some chemicals that we use in our everyday lives including medicines (such as prescription and non-prescription drugs), personal hygiene products (for example, soaps, disinfectants, ...) and their chemical additives (such as preservatives) are present in the environment and associated with various sources such as municipal wastewater treatment plants, runoff from agricultural and urban land surfaces, and septic systems. These contaminants are referred to collectively as “contaminants of emerging concern” and represent a shift in traditional thinking as many are produced industrially yet are dispersed to the environment from domestic uses.

This investigation identifies and quantifies the environmental sources, presence, and magnitude of environmental contaminants with the underlying theme of understanding the contaminants from their source to a “receptor organism.” The goal of the investigation is to understand the actual versus the perceived health risks to humans or wildlife due to low-level exposures from understudied chemical contaminants in the environment.

Background on Emerging Contaminants

Emerging contaminants can fall into a wide range of groups defined by their effects, uses, or by their key chemical or microbiological characteristics. Two groups of emerging contaminants that are of particular interest and concern at present are endocrine disrupting chemicals (EDCs) and pharmaceutical and personal care products (PPCPs). These compounds are found in the environment, often as a result of human activities.

EDCs may interfere with the endocrine systems by damaging hormone-producing tissues, changing the processes by which hormones are made or metabolized, or mimicking hormones.

In addition to natural and synthetic forms of human hormones that are released into the environment, there are a multitude of synthetic organic compounds that are able to disrupt the endocrine system. Public concern about EDCs in the environment has been rapidly increasing since the 1990s when researchers reported unusual sexual characteristics in wildlife. A report by the USGS, found that fish in many streams had atypical ratios of male and female sex hormones (Goodbred et al., 1997).

In England, researchers found that male trout kept in cages near WWTP outfalls were developing eggs on their testes and had increased levels of the protein that is responsible for egg production (vitellogenin) (Sumpter, 1995; Kaiser, 1996). Follow-up laboratory studies showed that synthetic forms of estrogen (17 α -ethynylestradiol (EE2)) could increase vitellogenin production in fish at levels as low as 1-10 ng/L, with positive responses seen down to the 0.1-0.5 ng/L level (Purdom et al., 1994).

Human estrogens have the ability to alter sexual characteristics of aquatic species at trace concentrations as low as 1 ng/L (Purdom et al., 1994). WWTP effluents have been identified as a primary source for EDCs in the environment, with the bulk of their endocrine disrupting activity resulting from human estrogen compounds (Desbrow et al., 1998, Snyder et al., 2001). The synthetic estrogen, EE2, and the natural estrogens, estrone (E1) and 17 β -estradiol (E2), are the greatest contributors to endocrine disrupting activity in WWTP effluent (Johnson et al., 2001) with EE2 showing the greatest recalcitrance in WWTPs (Joss et al., 2004). Influent concentrations range from below detection to 70 ng/L for EE2, 670 ng/L for E1 and 150 ng/L for E2 (Vethaak et al., 2005, Clara et al., 2005b). Other EDCs include tributyl tin, which was previously used in paints to prevent marine organisms from sticking to ships, nonylphenol (a surfactant), and bisphenol A (plasticizer and preservative).

PPCPs encompass a wide variety of products that are used by individuals for personal health or cosmetic reasons, and also include certain agricultural and veterinary medicine products.

PPCPs comprise a diverse collection of thousands of chemical substances, including prescription and over-the counter therapeutic drugs, veterinary drugs, fragrances, sun-screen products, vitamins, and cosmetics. Many of these products, notably the pharmaceuticals for human or animal use, are specifically designed to be biologically active, and some PPCPs may also fall into the category of EDCs described previously.

Estrogens of Concern

Name Chemical Structure Name Chemical Structure

E1	Estrone	C ₁₈ H ₂₂ O ₂
E2	17 β -estradiol	C ₁₈ H ₂₄ O ₂
E3	Estriol	C ₁₈ H ₂₄ O ₃
EE2	17 α -ethynylestradiol	C ₂₀ H ₂₄ O ₂

Currently, municipal sewage treatment plants are engineered to remove conventional pollutants such as solids and biodegradable organic material but are not specifically designed for PPCP removal or for other unregulated contaminants. Wastewater treatment commonly consists of primary settling followed by biological treatment, secondary settling, and disinfection. This treatment can remove more than 90 percent of many of the most commonly known or suspected EDCs found in wastewater influent; however, low concentrations of some suspected EDCs may remain in the wastewater treatment sludge or effluent (WERF, 2005). As discussed in the next section, studies have shown enhanced nutrient removal technologies to be effective in removing low concentrations of some emerging contaminants.

Removal of Emerging Contaminants by Nutrient Removal Technologies

Several studies have examined the effectiveness of current wastewater treatment technologies in the removal of emerging contaminants. Some of these studies are discussed below and their major findings are organized under three subsections: role of activated sludge SRT in removal efficiency, role of nitrifying bacteria in biodegradation, and use of RO to improve removal efficiencies. Details regarding the study design, such as evaluated treatments and contaminants, and a summary of major study findings are provided at the end of this section.

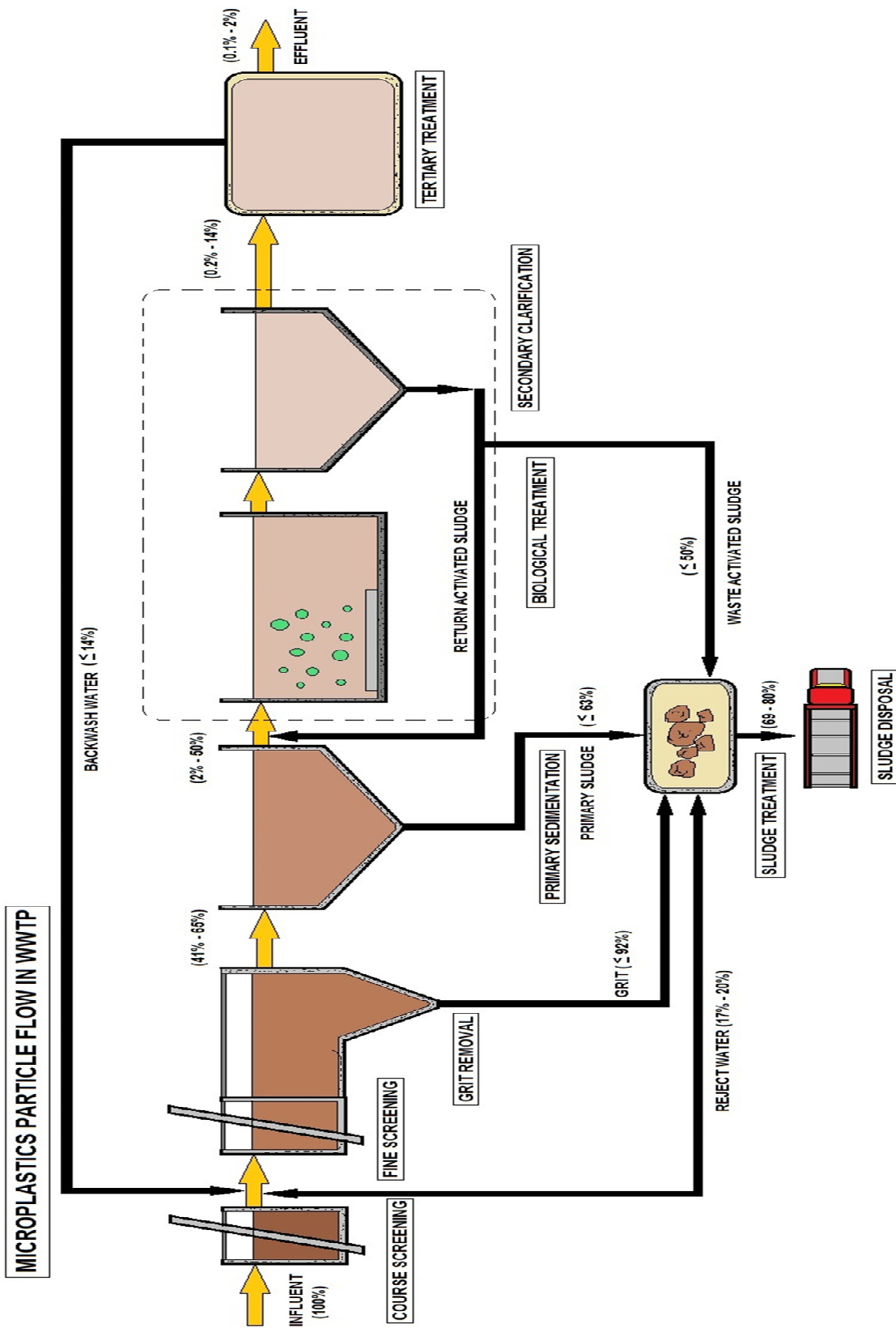

MICROPLASTIC REMOVAL EFFECTIVENESS IN WASTEWATER TREATMENT



The significant findings are also presented as follows:

- Removal efficiencies were enhanced for several investigated contaminants at longer SRTs, with critical SRTs for some beyond which removal rates did not improve.
- Longer SRTs allow for the establishment of slower growing bacteria (e.g., nitrifying bacteria in activated sludge), which in turn provide a more diverse community of microorganisms with broader physiological capabilities.
- Nitrifying bacteria may play a key role in biodegradation but the role of heterotrophic bacteria may also play a significant role.
- Reverse osmosis has been found to effectively remove PPCPs below detection limits including those that were not consistently removed at longer SRTs.

One caveat regarding studies on emerging contaminants is that their concentrations in wastewater influent are often quite low (e.g., concentrations of ng/L to µg/L range) and may be close to method detection limits. Therefore, small variations between measured influent and effluent concentrations may show large variations in apparent removal efficiencies, possibly even producing negative calculated removals.

Role of Solids Retention Time in Removal Efficiency

The focus of several studies has been the relationship of the SRT to the removal of emerging contaminants. In particular, many investigated whether longer SRTs would result in increased removal efficiencies for estrogens and other categories of PPCPs. Longer activated sludge SRTs allow for the establishment of slower growing bacteria (e.g., nitrifying bacteria in activated sludge), which in turn provide a more diverse community of microorganisms with broader physiological capabilities.

Clara et al. (2005a), Kreuzinger et al. (2004), and Oppenheimer et al. (2007) observed enhanced removal with increasing SRTs for most of the EDCs and pharmaceuticals tested and found no significant differences in removal performances between conventional activated sludge systems and MBR when operated at similar SRT₁₀ °C. This is likely due to the molecular weight of the study compounds, which was smaller than the molecular weight cut-off of the ultrafiltration membranes in the MBR.

Researchers have observed similar findings for natural estrogens with higher removal percentages at longer SRTs. Effluent concentrations for three natural estrogens were measured near their detection limits at SRTs₁₀ °C higher than 10 days, with their critical SRTs₁₀ °C estimated between 5 and 10 days (Clara et al., 2005a).

High removal rates of > 90 percent were also observed by Joss et al. (2004) in a study in which they evaluated the removal of E1, E2, and EE2 under aerobic and anaerobic conditions in WWTPs designed for nutrient removal. Joss et al. (2004) also reported that the maximum efficiency is dependent on redox conditions, with the highest removal rate occurring during the reduction of E1 to E2 under aerobic conditions. Clara et al. (2005a) cited examples where conflicting results were obtained for EE2.

Ternes et al. (1999) found no significant elimination of this compound during batch experiments; however, Baronti et al. (2000) and Joss et al. (2004) report greater than 85 percent removal in full-scale WWTPs.

For the pharmaceuticals ibuprofen and bezafibrate, Clara et al. (2005a) reported more than 95 percent removal during treatment and calculated the critical value for SRT_{10° C} at 5 days for ibuprofen and about 10 days for bezafibrate.

Analogous removal results were obtained in several other studies (Stumpf et al., 1998; Buser et al., 1999; Zwiener et al., 2001, as cited in Clara et al., 2005a; Oppenheimer et al., 2007). Clara et al. (2005b) noted no or slight removal of these two pharmaceuticals and two musk fragrances (tonalide and galaxolide) at a WWTP with a low SRT of 1 to 2 days.

Clara et al. (2005a, 2005b) also found that the pharmaceutical carbamazepine was not removed during wastewater treatment.

In addition, these studies found contradictory results for diclofenac (e.g., removal rates ranged from no removal to > 70 percent at SRTs of > 10 days (Clara et al., 2005b)). Clara et al. (2005a) also cited several examples where conflicting results were obtained for diclofenac. No significant removal was reported by Buser et al. (1999) and Heberer (2002a); whereas, Ternes et al. (1998) observed elimination rates of up to 70 percent.

The Classes of EDCs included:

Steroids/sterols (naturally occurring, synthetic, and phytoestrogens), organohalides, metals/ organometals, alkyl phenols, polycyclic aromatic hydrocarbons (PAHs)/crude oil, and plasticizers.

Although the WERF 2005 technical brief states that in general, EDC treatment effectiveness is improved with increased SRT, it does not provide the specific SRTs that are associated with the cited removal rates.

Oppenheimer et al. (2007) examined the relationship of SRT to treatment removal efficiencies for 20 PPCPs that are commonly found in the influent of U.S. treatment facilities. Many of the studies already discussed here have been conducted primarily in Europe, were conducted at small-scale WWTPs and bench/pilot plants under controlled conditions, and focused on estrogens and prescription pharmaceuticals rather than PPCPs. The Oppenheimer et al. (2007) study also noted trends regarding the effect of HRT and pure oxygen systems compared to conventional aeration systems on PPCP removal.

Oppenheimer et al. (2007) defined a minimum critical SRT as the minimum time needed to consistently demonstrate greater than 80 percent removal. The results of the study showed that this critical SRT was compound dependent but that the majority of the 20 PPCPs were consistently removed in those treatment plants operating at SRTs of 5 to 15 days. Specifically, 9 of 12 frequently occurring PPCPs were effectively removed through secondary treatment (e.g., ibuprofen).

Conversely, six compounds that are routinely detected in influent (i.e., detected in at least 20 percent of the influent samples) were not well removed by secondary treatment (BHA, DEET, musk ketone, triclosan, benzophenone, galaxolide).

The results for galaxolide conflicted with those reported by Clara et al. (2005b) who generally found high removal rates with SRTs > 10 days and Kreuzinger et al. (2004) who reported removal at SRT between 25 to 40 days. Oppenheimer et al. (2007) found that

some compounds such as octylphenol, tri-(chloroethyl) phosphate, and triphenylphosphate were not well removed by secondary treatment; however, these were seldom detected in the influent samples.

Based on these results, Oppenheimer et al. (2007) concluded that secondary treatment provides an “effective first barrier” for the 20 PPCPs in the study.

Oppenheimer et al. (2007) also noted trends regarding the effect of HRT and pure oxygen systems compared to conventional aeration systems on PPCP removal but determined that insufficient data existed to make any definitive conclusions.

When the PPCP removal performance of a high-purity oxygenated activated sludge plant was compared to a conventional aeration system, the pure oxygen system showed higher removal rates although its SRT was shorter than the conventional aeration plant (i.e., 1 day versus 3 days).

In addition, different HRTs operating at similar SRTs had similar removal rates, and therefore suggested that HRT does not significantly affect removal effectiveness in the investigated PPCPs.

Role of Nitrifying Bacteria in Biodegradation

As discussed above, longer SRTs allow for the establishment of slow-growing nitrifying bacteria (i.e., ammonia oxidizing bacteria and nitrite-oxidizing bacteria). Several studies evaluated whether nitrifying bacteria improve the biodegradation of certain emerging contaminants. Major findings from some of these studies are discussed in this section.

The WERF (2005) technical brief indicated that secondary biological treatment that includes nitrification, nutrient removal, and disinfection may remove more than 90 percent of certain steroids, and >95 percent of alkyl phenols; whereas, secondary biological treatment without nitrification and disinfection may decrease removal of these by more than 15 percent. Batt et al. (2006) investigated the role of nitrifying bacteria in activated sludge in the biodegradation of two pharmaceuticals, iopromide and trimethoprim.

The biodegradation of these compounds was conducted in two lab-scale bioreactors using biomass from a stage-2 activated sludge WWTP (operated at an SRT of 49 days). In one of the bioreactors, nitrification was not inhibited (Batch-1 reactor); in the other, nitrification was inhibited with allylthiourea (Batch-2 reactor).

Monitoring was also conducted in the WWTP and compared to results obtained from the batch reactors. Both reactors exhibited high removal rates for iopromide; however, for trimethoprim, Batch-1 showed a high removal rate of 70 percent, contrasted to the Batch-2 reactor removal rate of approximately 25 percent with nitrification inhibited.

Removal rates within the treatment plant, however, were consistent for both pharmaceuticals, showing significantly higher removal rate after nitrification (approx. 60 percent for iopromide and 50 percent for trimethoprim) compared to activated sludge treatment only (<1 percent for both).

Based on these results, Batt et al. (2006) concluded that nitrifying bacteria have a key role in the biodegradation of pharmaceuticals in WWTP that are operated at higher SRTs. This conclusion is supported by Marttinen et al. (2003), who investigated the fate of phthalates

Laboratory Analysis/ Process Control Section Post Quiz

1. What is the proper term used that are determined using a concentration cell with transference, by measuring the potential difference between a hydrogen electrode and a standard electrode such as the silver chloride electrode?
2. In chemistry, *pH* is a measure of the acidity or basicity of an aqueous solution. Solutions with a pH less than 7 are said to be acidic and solutions with a pH greater than 7 are basic or alkaline. Pure water has a pH very close to?
3. Mathematically, pH is the negative logarithm of the activity of the (solvated) hydronium ion, more often expressed as the measure of the?
4. Which terms is used for aqueous solutions can be done with a glass electrode and a pH meter, or using indicators?
5. The pH scale is logarithmic and therefore pH is?
6. Measuring alkalinity is important in determining a stream's ability to neutralize acidic pollution from rainfall or wastewater. It is one of the best measures of the sensitivity of the stream to acid inputs. There can be long-term changes in the _____ of rivers and streams in response to human disturbances.
7. pH is defined as the decimal logarithm of the reciprocal of the _____, a_{H^+} , in a solution.
8. Alkalinity is the name given to the quantitative capacity of an aqueous solution to neutralize an?
9. What is the term used for the color of a test solution with a standard color chart provides a means to measure pH accurate to the nearest whole number?
10. The calculation of the pH of a solution containing acids and/or bases is an example of a chemical speciation calculation, that is, a mathematical procedure for calculating the concentrations of all chemical species that are present in the solution. The complexity of the procedure depends on the?

11. Under normal circumstances this means that the concentration of hydrogen ions in acidic solution can be taken to be equal to the concentration of the acid. The pH is then equal to minus the logarithm of?

12. Alkalinity of water is its acid-neutralizing capacity. It is the sum of all the titratable bases. The measured value may vary significantly with the?

13. For strong acids and bases no calculations are necessary except in extreme situations. The pH of a solution containing a weak acid requires the solution of a quadratic equation. The pH of a solution containing a weak base may require the?

14. Alkalinity is a measure of this missing term and can be interpreted in terms of specific substances only when the chemical composition of the sample is known.

15. More precise measurements are possible if the color is measured spectrophotometrically, using a?

16. For strong acids and bases no calculations are necessary except in extreme situations. The pH of a solution containing a weak acid requires?

17. The calculation of the pH of a solution containing acids and/or bases is an example of a _____ calculation, that is, a mathematical procedure for calculating the concentrations of all chemical species that are present in the solution

18. What is the term used for measurements in the interpretation and control of water and wastewater treatment processes?

19. What is the term used for compounds that, for practical purposes, are completely dissociated in water?

Laboratory Analysis/ Process Control Section Post Quiz Answers

1. Primary pH standard values, 2. 7, 3. Hydronium ion concentration, 4. Measurement of pH, 5. A dimensionless quantity, 6. Alkalinity, 7. Hydrogen ion activity, 8. Acid, 9. Visual comparison, 10. Nature of the solution, 11. The concentration value, 12. End-point pH, 13. Solution of a cubic equation, 14. An aggregate property of water, 15. Colorimeter or spectrophotometer, 16. The solution of a quadratic equation, 17. Chemical speciation, 18. Alkalinity, 19. Strong acids and bases

Formulas and Conversions

$$\text{Acid Feed Rate} = \frac{(\text{Waste Flow}) (\text{Waste Normality})}{\text{Acid Normality}}$$

$$\text{Alkalinity} = \frac{(\text{mL of Titrant}) (\text{Acid Normality}) (50,000)}{\text{mL of Sample}}$$

$$\text{Amperage} = \text{Voltage} \div \text{Ohms}$$

$$\text{Area of Circle} = (0.785)(\text{Diameter}^2) \text{ OR } (\pi)(\text{Radius}^2)$$

$$\text{Area of Rectangle} = (\text{Length})(\text{Width})$$

$$\text{Area of Triangle} = \frac{(\text{Base}) (\text{Height})}{2}$$

$$\text{C Factor Slope} = \text{Energy loss, ft.} \div \text{Distance, ft.}$$

$$\text{C Factor Calculation} = \text{Flow, GPM} \div [193.75 (\text{Diameter, ft.})^{2.63}(\text{Slope})^{0.54}]$$

$$\text{Chemical Feed Pump Setting, \% Stroke} = \frac{(\text{Desired Flow}) (100\%)}{\text{Maximum Flow}}$$

$$\text{Chemical Feed Pump Setting, mL/min} = \frac{(\text{Flow, MGD}) (\text{Dose, mg/L}) (3.785\text{L/gal}) (1,000,000 \text{ gal/MG})}{(\text{Liquid, mg/mL}) (24 \text{ hr. / day}) (60 \text{ min/hr.})}$$

$$\text{Chlorine Demand (mg/L)} = \text{Chlorine dose (mg/L)} - \text{Free Chlorine residual (mg/L)}$$

$$\text{Circumference of Circle} = (3.141) (\text{Diameter})$$

$$\text{Composite Sample Single Portion} = \frac{(\text{Instantaneous Flow}) (\text{Total Sample Volume})}{(\text{Number of Portions}) (\text{Average Flow})}$$

$$\text{Detention Time} = \frac{\text{Volume}}{\text{Flow}}$$

$$\text{Digested Sludge Remaining, \%} = \frac{(\text{Raw Dry Solids}) (\text{Ash Solids}) (100\%)}{(\text{Digested Dry Solids}) (\text{Digested Ash Solids})}$$

$$\text{Discharge} = \frac{\text{Volume}}{\text{Time}}$$

$$\text{Dosage, lbs/day} = (\text{mg/L})(8.34)(\text{MGD})$$

$$\text{Dry Polymer (lbs.)} = (\text{gal. of solution}) (8.34 \text{ lbs/gal})(\% \text{ polymer solution})$$

$$\text{Efficiency, \%} = \frac{(\text{In} - \text{Out}) (100\%)}{\text{In}}$$

$$\text{Feed rate, lbs/day} = \frac{(\text{Dosage, mg/L}) (\text{Capacity, MGD}) (8.34 \text{ lbs/gals})}{(\text{Available fluoride ion}) (\text{Purity})}$$

$$\text{Feed rate, gal/min (Saturator)} = \frac{(\text{Plant capacity, gal/min.}) (\text{Dosage, mg/L})}{18,000 \text{ mg/L}}$$

$$\text{Filter Backwash Rate} = \frac{\text{Flow gpm}}{\text{Filter Area ft}^2}$$

$$\text{Filter Yield, lbs/hr./sq. ft} = \frac{(\text{Solids Loading, lbs/day}) (\text{Recovery, \%} / 100\%)}{(\text{Filter operation, hr./day}) (\text{Area, ft}^2)}$$

$$\text{Flow, cu. ft./sec.} = (\text{Area, Sq. Ft.}) (\text{Velocity, ft./sec.})$$

$$\text{Gallons/Capita/Day} = \frac{\text{Gallons / day}}{\text{Population}}$$

$$\text{Hardness} = \frac{(\text{mL of Titrant}) (1,000)}{\text{mL of Sample}}$$

$$\text{Horsepower (brake)} = \frac{(\text{Flow, gpm}) (\text{Head, ft})}{(3,960) (\text{Efficiency})}$$

$$\text{Horsepower (motor)} = \frac{(\text{Flow, gpm}) (\text{Head, ft})}{(3960) (\text{Pump, Eff}) (\text{Motor, Eff})}$$

$$\text{Horsepower (water)} = \frac{(\text{Flow, gpm}) (\text{Head, ft})}{(3960)}$$

$$\text{Hydraulic Loading Rate} = \frac{\text{Flow gpm}}{\text{Area ft}^2}$$

$$\text{Leakage (actual)} = \text{Leak rate (GPD)} \div [\text{Length (mi.)} \times \text{Diameter (in.)}]$$

$$\text{Mean} = \text{Sum of values} \div \text{total number of values}$$

$$\text{Mean Cell Residence Time (MCRT)} = \frac{\text{Suspended Solids in Aeration System, lbs}}{(\text{SS Wasted, lbs / day}) + (\text{SS lost, lbs / day})}$$

$$\text{Organic Loading Rate} = \frac{\text{Organic Load, lbs BOD / day}}{\text{Volume}}$$

$$\text{Oxygen Uptake} = \frac{\text{Oxygen Usage}}{\text{Time}}$$

$$\text{Pounds per day} = (\text{Flow, MGD}) (\text{Dose, mg/L}) (8.34)$$

$$\text{Population Equivalent} = \frac{(\text{Flow MGD}) (\text{BOD, mg/L}) (8.34 \text{ lbs / gal})}{\text{Lbs BOD / day / persons}}$$

$$\text{RAS Suspended Solids, mg/l} = \frac{1,000,000}{\text{SVI}}$$

$$\text{RAS Flow, MGD} = \frac{(\text{Infl. Flow, MGD}) (\text{MLSS, mg/l})}{(\text{RAS Susp. Sol., mg/l}) - (\text{MLSS, mg/l})}$$

$$\text{RAS Flow \%} = \frac{(\text{RAS Flow, MGD}) (100 \%)}{\text{Infl. Flow, MGD}}$$

$$\text{Reduction in Flow, \%} = \frac{(\text{Original Flow} - \text{Reduced Flow}) (100\%)}{\text{Original Flow}}$$

$$\text{Slope} = \frac{\text{Drop or Rise}}{\text{Run or Distance}}$$

$$\text{Sludge Age} = \frac{\text{Mixed Liquor Solids, lbs}}{\text{Primary Effluent Solids, lbs / day}}$$

$$\text{Sludge Index} = \frac{\% \text{ Settleable Solids}}{\% \text{ Suspended Solids}}$$

$$\text{Sludge Volume Index} = \frac{(\text{Settleable Solids, \%}) (10,000)}{\text{MLSS, mg/L}}$$

$$\text{Solids, mg/L} = \frac{(\text{Dry Solids, grams}) (1,000,000)}{\text{mL of Sample}}$$

$$\text{Solids Applied, lbs/day} = (\text{Flow, MGD})(\text{Concentration, mg/L})(8.34 \text{ lbs/gal})$$

$$\text{Solids Concentration} = \frac{\text{Weight}}{\text{Volume}}$$

$$\text{Solids Loading, lbs/day/sq. ft} = \frac{\text{Solids Applied, lbs / day}}{\text{Surface Area, sq. ft}}$$

$$\text{Surface Loading Rate} = \frac{\text{Flow}}{\text{Rate}}$$

$$\text{Total suspended solids (TSS), mg/L} = \frac{(\text{Dry weight, mg})(1,000 \text{ mL/L})}{(\text{Sample vol., mL})}$$

$$\text{Velocity} = \frac{\text{Flow}}{\text{Area}} \quad \text{O R} \quad \frac{\text{Distance}}{\text{Time}}$$

$$\text{Volatile Solids, \%} = \frac{(\text{Dry Solids} - \text{Ash Solids}) (100\%)}{\text{Dry Solids}}$$

Volume of Cone = $(1/3)(0.785)(\text{Diameter}^2)(\text{Height})$

Volume of Cylinder = $(0.785)(\text{Diameter}^2)(\text{Height})$ OR $(\pi)(r^2)(h)$

Volume of Rectangle = $(\text{Length})(\text{Width})(\text{Height})$

Volume of Sphere = $[(\pi)(\text{diameter}^3)] \div 6$

Waste Milliequivalent = $(\text{mL}) (\text{Normality})$

Waste Normality = $\frac{(\text{Titrant Volume}) (\text{Titrant Normality})}{\text{Sample Volume}}$

Weir Overflow Rate = $\frac{\text{Flow gpm}}{\text{Weir Length ft}}$

Conversion Factors

1 acre = 43,560 square feet

1 cubic foot = 7.48 gallons

1 foot = 0.305 meters

1 gallon = 3.785 liters

1 gallon = 8.34 pounds

1 grain per gallon = 17.1 mg/L

1 horsepower = 0.746 kilowatts

1 million gallons per day = 694.45 gallons per minute

1 pound = 0.454 kilograms

1 pound per square inch = 2.31 feet of water

1% = 10,000 mg/L

Degrees Celsius = $(\text{Degrees Fahrenheit} - 32) (5/9)$

Degrees Fahrenheit = $(\text{Degrees Celsius} \cdot 9/5) + 32$

1,000 meters = 1 kilometer

1,000 grams = 1 kilogram

Hyperlink to the Glossary and Appendix

<http://www.abctlc.com/downloads/PDF/WWTGlossary.pdf>

References

- Activated Sludge Model No. 2d: ASM2d. *Water Science and Technology*. 17(1):165-182
- Activated Sludge Process. *Research Journal, Water Pollution Control Federation*, Vol. 63, p. 208.
- Ahmed, Z., B. Lim, J. Cho, K. Song, K. Kim, and K. Ahn. 2007. Biological Nitrogen and Phosphorus Removal and Changes in Microbial Community Structure in a Membrane Bioreactor: Effect of Different Carbon Sources. *Water Research*. 42(1-2): 198-210.
- Alexander, R.B., R.A. Smith, G.E. Schwarz, E.W. Boyer, J.V. Nolan, and J.W. Brakebill. 2008. Differences in Phosphorus and Nitrogen Delivery to the Gulf of Mexico from the Mississippi River Basin. *Environmental Science and Technology*. 42(3): 822-830.
- American Public Health Association (APHA), AWWA, and Water Environment Federation (WEF). 1998. aminopolycarboxylic acids. *FEMS Microbiology Reviews*. 25(1): 69-106.
- Anderson, J.L., and D.M. Gustafson. 1998. *Residential Cluster Development: Alternative Wastewater Treatment Systems*. MI-07059.
- Andreasen, K. and Nielsen, P.H. (2000). In Situ Characterization of Substrate uptake by *Microthrix parvicella* using microautoradiography, *Wat. Sci. Tech.*, 37(4-5), 16-2002)
- Anthony R. Pitman (1996) Bulking and foaming in BNR plants in Johannesburg: problems and solutions. *Water Science and Technology Vol 34 No 3-4 pp 291298*
- APHA. (2005). Standard methods for the examination of water and wastewater 21st Ed.). Washington DC: American Public Health Association/American Water Works Association/Water Environment Federation.
- Arden, E. and W. T. Lockett. 1914a. Experiments on the oxidation of sewage without the aid of filters. *J. Soc. 01 Chemical Industry (England)*, 33:523-539.
- Arden, E. and W. T. Lockett. 1914b. The oxidation of sewage without the aid of filters. Part II. *J. Soc. of Chem Industry (England)*, 33: 1122-1124.
- Assessing the Bioavailability of Wastewater-Derived Organic Nitrogen in Treatment Systems and ATV-DVWK. 2000. ATV-DVWK-Regelwerk, Arbeitsblatt ATV-DVWK-A131. Bemessung von einstufigen Belebungsanlagen. ATV-DVWK Standard A131: Design of Biological Wastewater Treatment Plants. In: Deutsche Vereinigung für Wasserwirtschaft Abwasser und Abfall e.V. (Eds.), GFAGesellschaft zur Available online: <http://ccma.nos.noaa.gov/publications/eutrouupdate/>
- Available online: http://www.epa.gov/owm/mtb/sbr_new.pdf
- Available online: http://www.epa.gov/owm/mtb/trickling_filt_nitrification.pdf
- Barber, W. P. F. (2014). Influence of wastewater treatment on sludge production and processing. *Water and Environment Journal*, 28, 1–10.
- Barker, P.S. and P.L. Dold. 1997. General Model for Biological Nutrient Removal Activated Sludge Systems:
- Barnard, J.L. 1975. Biological Nutrient Removal without the Addition of Chemicals. *Water Research*. 9:
- Barnard, J.L. 1984. Activated Primary Tanks for Phosphate Removal. *Water SA*. 10(3): 121-126.
- Barnard, J.L. 2006. Biological Nutrient Removal: Where We Have Been, Where We are Going? In Baronti, C., R. Curini, G. D'Ascenzo, A. Di Corcia, A. Gentili, and R. Samperi. 2000. Monitoring Natural and Synthetic Estrogens at Activated Sludge Sewage Treatment Plants and in a Receiving River Water.
- Batt, A. L., S. Kim, and D.S. Aga. 2006. Enhanced Biodegradation of Iopromide and Trimethoprim in Nitrifying Activated Sludge. *Environmental Science and Technology*. 40(23): 7367-7373.
- Beychok, M.R. (1971). "Performance of surface-aerated basins". *Chemical Engineering Progress Symposium Series*. 67 (107): 322–339. Available at CSA Illumina website Archived 2007-11-14 at the Wayback Machine.
- Beychok, Milton R. (1967). *Aqueous Wastes from Petroleum and Petrochemical Plants (1st ed.)*. John Wiley & Sons Ltd. LCCN 67019834.
- Biodegradable Dissolved Organic Nitrogen (BDON) Protocol. Presentation at the STAC-WERF Workshop: Biological Nutrient Removal (BNR) Operation in Wastewater Treatment Plants, WEF Manual of Practice (MOP #29), Water Environment Federation, 2005.
- Biotransformation of Pharmaceuticals and Personal Care Products (PPCP) During Nitrification: The Role of Ammonia Oxidizing Bacteria versus Heterotrophic Bacteria.
- Block, T.J., L. Rogacki, C. Voigt, D.G. Esping, D.S. Parker, J.R. Bratby, and J.A. Gruman. 2008. No Chemicals Required: This Minnesota Plant Removes Phosphorus Using a Completely Biological Process. *Water Environment & Technology*. Alexandria, VA: WEF. 20(1): 42-47.

Blue Water Technologies. 2008. Blue Pro Pilot Project Report: Phosphorus Removal from Wastewater Located at a Municipal Wastewater Treatment Plant in Florida. Blue Water Technologies, Inc. Hayden, Idaho.

Boehnke, B., Schulze-Rettmer, R., & Zuckut, S. W. (1998). Cost-effective reduction of high-strength wastewater by adsorption-based activated sludge technology. *Water Engineering & Management*, 145(12), 31–34.

Bott, C.B., S. N. Murthy, T. T. Spano, and C.W. Randall. 2007. WERF Workshop on Nutrient Removal: How Low Can We Go and What is Stopping Us from Going Lower? Alexandria, VA: WERF.

Braghetta, A. and B. Brownawell. 2002. Removal of Pharmaceuticals and Endocrine Disrupting

Braghetta, A.H., T. Gillogly, M.W. Harza, B. Brownawell, and M. Benotti. 2002. Removal of

Brdjanovic, D., M.C.M. van Loosdrecht, P. Versteeg, C.M. Hooijmans, G.J. Alaerts, and J.J. Heijnen. 2000.

Bricker, S., B. Longstaff, W. Dennison, A. Jones, K. Boicourt, C. Wicks, and J. Woerner. 2007. Effects of Nutrient Enrichment in the Nation's Estuaries: A Decade of Change. NOAA Coastal Ocean Program

Bucheli-Witschel, M. and T. Egli. 2001. Environmental fate and microbial degradation of

Bufe, M. 2008. Getting Warm? Climate Change Concerns Prompt Utilities to Rethink Water Resources,

Buser, H.-R., T. Poiger, and M.D. Müller. 1999. Occurrence and Environmental Behavior of the Chiral Pharmaceutical Drug Ibuprofen in Surface Waters and in Wastewater. *Environmental Science and Technology*. 33(15): 2529–2535.

Canadian Council of Ministers of the Environment. Report prepared by Hydromantis Inc., University of Waterloo Dept. of Civil Engineering.

CCME. 2006. Review of the State of Knowledge of Municipal Effluent Science and Research: Review of Existing and Emerging Technologies, Review of Wastewater Treatment Best Management Practices.

Chang, C. R., Liu, J. C., & Lee, D. J. (2001). Co-conditioning and dewatering of chemical sludge and waste activated sludge. *Water Research*, 35(3), 786–794.

Chesapeake Bay Program, 2008. Chesapeake Bay Program – A Watershed Partnership. Accessed July 1, 2008. Available online: <http://www.chesapeakebay.net/nutr1.htm>

Clara, M., B. Strenn, O. Gans, E. Martinez, N. Kreuzinger, and H. Kroiss. 2005b. Removal of Selected Pharmaceuticals, Fragrances and Endocrine Disrupting Compounds in a Membrane Bioreactor and Conventional Wastewater Treatment Plant. *Water Research*. 39: 4797-4807.

Clara, M., N. Kreuzinger, B. Strenn, O. Gans, E. Martinez, and H. Kroiss. 2005a. The Solids Retention Time – A Suitable Design Parameter to Evaluate the Capacity of Wastewater Treatment Plants to Remove Micropollutants. *Water Research*. 39(1):97-106.

Compounds through Advanced Wastewater Treatment Technologies. AWWA – Water Quality

Conventional and Advanced Drinking Water Treatment Processes to Remove Endocrine Disruptors and Pharmaceutically Active Compounds: Bench-Scale Results. In *Proceedings of the 3rd International Conference on Pharmaceuticals and Endocrine Disrupting Compounds in Water*. Minneapolis, MN: The National Ground Water Association. STAC-WERF. 2007. Workshop Considerations and Presentations.

Establishing a Research Agenda for

Crites R. and G. Tchobanoglous. 1998. *Small and Decentralized Wastewater Management Systems*. New York, NY: McGraw Hill.

D. Mamais, A. Andreadakis, C. Noutsopoulos and C. Kalergis Water Science and Technology Vol 37 No 4-5 pp 9-17 1998 Causes of, and control strategies for *Microthrix parvicella* bulking and foaming in nutrient removal activated sludge systems.

de Graaff, M. S., van den Brand, T. P. H., Roest, K., Zandvoort, M. H., Duin, O., & van Loosdrecht, M. C. M. (2016). Full-scale highly-loaded wastewater treatment processes (A-stage) to increase energy production from wastewater: performance and design guidelines. *Environmental Engineering Science*, 33(8), 571–577.

DeBarbadillo, C., J. Barnard, S. Tarallo, and M. Steichen. 2008. Got Carbon? Widespread biological nutrient removal is increasing the demand for supplemental sources. *Water Environment & Technology*. Alexandria, VA: WEF. 20(1): 49-53.

Decision Analysis Series No. 26. Silver Spring, MD: National Centers for Coastal Ocean Science. 328 pp.

Deksissa, T., G.S. Wyche-Moore, and W.W. Hare. 2007. American Water Resources Association. Denver, CO: USGS.

Desbrow, C., E.J. Routledge, G.C. Brighty, J.P. Sumpter, M. Waldock. 1998. Identification of Estrogenic Chemicals in Stw Effluent. (1998) 1. Chemical Fractionation and in Vitro Biological Screening.

Dolan, G. 2007 *Methanol Safe Handling. Proceedings from the 2nd External Carbon Source Workshop*. Washington, DC, December 2007.

Dold, P., I. Takács, Y. Mokhayeri, A. Nichols, J. Hinojosa, R. Riffat, C. Bott, W. Bailey, and S. Murthy. 2008. Denitrification with Carbon Addition—Kinetic Considerations. *Water Environment Research*. 80(5): 417-427. WEF.

Dosing Aluminum chloride as a means to fight *Microthrix parvicella*, Stefania Paris, George Lind, Hilde Lemmer, Peter A. Wilderer. Proceedings of the Post-conference colloquium on Foam and Scum in Biological Wastewater Treatment. 5th September 2003, PICT, Prague, Czech Republic p 51.

Drury, D.D., Shepherd, W., and Narayanan, B. (2005). Phosphorus – How Low Can You Go? Proceedings of the Water Environment Federation, WEFTEC 2005: Session 11 through Session 20 , pp. 1125-1134(10)

E.M. Seviour, R.J. Seviour and K.C. Lindrea, (1999). Description of the filamentous bacteria causing bulking and foaming in activated sludge plants, *in* The Microbiology of Activated Sludge, R.J. Seviour and L.L. Blackall, Eds. Kluwer Academic Publishers Dordrecht, Netherlands. ISBN 0-412-79380-6.

Eberle, K.C. and T.J. Baldwin. 2008. A Winning Combination - Innovative MBR technologies and reclaimed water dispersal systems overcome challenges to wastewater treatment in North Carolina coastal areas. Meeting strict regulations, protecting nearby ecosystems, and appealing to residents. *Water Environment & Technology*. Alexandria, VA: WEF. 20 (2): 35-43.

Eckenfelder, Jr., W. Wesley; Cleary, Joseph G. (2014). *Activated Sludge Technologies for Treating Industrial Wastewaters (1st ed.)*. DEStech Publications. p. 234. ISBN 978-1-60595-019-8. Retrieved 29 December 2014.

Eikelboom DH, The *Microthrix parvicella* puzzle. Selectors for bulking control at domestic plants in the Netherlands. *WaterSci Technol* 29:273-279 (1994).]

Emerging Contaminant Removal Using Reverse Osmosis for Indirect Potable Use. In *Proceedings of the IDA World Congress on Desalination and Water Reuse*. Paradise Island, Bahamas, 2003. New York, NY: International Desalination Association.

Energy Use. State of the Industry. *Water Environment & Technology*. Alexandria, VA: WEF. 20(1): 29-32.

Environment: A Review of Recent Research Data. *Toxicology Letters*. 131(1–2): 5–17.

Environmental Science and Technology. 32 (11): 1549-1558.

Environmental Science and Technology. 34(24): 5059–5066.

Environmental Science and Technology. 38(11):3047-3055.

EPA 832-F-00-023. September 2000.

EPA Region 10. 2007. Advanced Wastewater Treatment to Achieve Low Concentration of Phosphorus. EPA Region 10. EPA 910-R-07-002.

EPA. Washington, DC (2000). "Package Plants." Wastewater Technology Fact Sheet. Document no. EPA 832-F-00-016.

Erdal, U.G., Z.K. Erdal, and C.W. Randall. 2002. Effect of Temperature on EBPR System Performance and Bacterial Community. In *Proceedings of WEFTEC 2002*.

Establishing a Research Agenda for Assessing the Bioavailability of Wastewater-Derived Organic Ethinylestradiol. *Environmental Science and Technology*. 41(12): 4311-4316.

Everest, W.R., K. L. Alexander, S.S. Deshmukh, M.V. Patel, J.L. Daugherty, and J.D. Herberg. 2003.

Federal Register. 2001. Nutrient Criteria Development; Notice of Ecoregional Nutrient Criteria. J. Charles Fox, Assistant Administrator, Office of Water. 66(6): 1671-1674. Available online:

Federal Water Pollution Control Act. 33 U.S.C. §§ 1251-1387, October 18, 1972, as amended 1973-1983, 1987, 1988, 1990-1992, 1994, 1995 and 1996.

Filipe, C.D.M., G.T. Daigger, and C.P. L. Grady Jr. 2001. pH As a Key Factor in the Competition Between Glycogen Accumulating Organisms and Phosphate Accumulating Organisms. *Water Environment Research*. Alexandria, VA: WEF. 73(2): 223-232.

Fissore, C., Baker, A., Hobbie, E., King, J.Y., McFadden, P., Nelson, C. and Jakobsdottir, I. (2011). Carbon, nitrogen, and phosphorus fluxes in household ecosystems in the Minneapolis-Saint Paul, Minnesota, urban region. *Ecological Applications*, 21(3), 2011, pp. 619–639

Förderung der Abwassertechnik. Hefen, Germany, ISBN 3-933707-41-2. <http://www.gfa-verlag.de>.

Fuhs, G.W. and M. Chen. 1975. Microbiological Basis of Phosphate Removal in the Activated Sludge Process for the Treatment of Wastewater. *Microbial Ecology*. 2(2): 119-38.

G. B. Saayman, C. F. Schutte and J. van Leeuwen, (1996) The effect of chemical bulking control on biological nutrient removal in a full scale activated sludge plant. *Water Science and Technology* Vol. 34 No 3-4 pp 275282

Ge, H., Batstone, D. J., & Keller, J. (2013). Operating aerobic wastewater treatment at very short sludge ages enables treatment and energy recovery through anaerobic sludge digestion. *Water Research*, 47(17), 6546–6557.

Gernaey, K.V., M.C.M. VanLoosdracht, M. Henze, M. Lind, and S.B. Jorgensen. 2004. Activated Sludge Wastewater Treatment Plant Modeling and Simulation: State of the Art. *Environmental Modeling and Software*. 19: 763-783.

GLNPO Library. EPA 625/1-76-001a. April 1976.

Gonzalez-Martinez, A., Rodriguez-Sanchez, A., Lotti, T., Garcia-Ruiz, M. J., Osorio, F., Gonzalez-Lopez, J., & van Loosdracht, M. C. M. (2016). Comparison of bacterial communities of conventional and A-stage activated sludge systems. *Scientific Reports*, 6, 1–11.

Goodbred, S. L., R. J. Gilliom, T. S. Gross, N. P. Denslow, W. L. Bryant, and T. R. Schoeb. 1997.

Grinwis, R.V. Kuiper. 2005. An Integrated Assessment of Estrogenic Contamination and Biological Effects in the Aquatic Environment of the Netherlands. *Chemosphere*. 59 (4): 511-524.

Grohmann, K., E. Gilbert and S. H. Eberle. 1998. Identification of nitrogen-containing compounds of low molecular weight in effluents of biologically treated municipal wastewater. *Acta Hydrochimica Et Hydrobiologica* 26(1): 20-30.

Gross, C.M., J.A. Delgado, S.P. McKinney, H. Lal, H. Cover, and M.J. Shaffer. 2008. Nitrogen Trading Tool to Facilitate Water Quality Trading. *Journal of Soil and Water Conservation*. March/April 2008. 63(2): 44-45.

Gujer, W. , M. Henze, T. Mino, and M.C.M. van Loosdracht. 1999. Activated Sludge Model No. 3. *Water Science and Technology*. 39(1):183-193

Gurr, C.J., M. Reinhard. 2006. Harnessing Natural Attenuation of Pharmaceuticals and Hormones in Rivers. *Environmental Science & Technology*. American Chemical Society. 40(8): 2872-2876.

Heberer, T. 2002a. Occurrence, Fate and Removal of Pharmaceutical Residues in the Aquatic

Heinze, E., I.J. Dunn, and G.B. Rhyner. 1993. Modeling and Control for Anaerobic Wastewater

Henze, M., C.P.L. Grady, W. Gujer, G.v.R. Marais, and T. Matsuo. 1987. Activated Sludge Model No. 1. *IAWPRC Scientific and Technical Report No. 1*. London, UK. IWA

Henze, M., Harremoës, P., la Cour Jansen, J., and Arvin, E. (2002). *Wastewater Treatment: Biological and Chemical Processes*, Springer, New York.

Henze, M., W. Gujer, T. Mino, T. Matsuo, M. Wentzel, and G.v.R. Marais. 1995. Activated Sludge Model No. 2. *IAWPRC Scientific and Technical Report No. 3*. London, UK. IWA

Henze, M., W. Gujer, T. Mino, T. Matsuo, M. Wentzel, G.v.R. Marais, and M.C.M. van Loosdracht. 1999.

Ho, S. W., Cheung, K. K., & Fung, W. C. (2014). Sustainable wastewater treatment—ways to achieve energy neutrality. *HKIE Transactions*, 21(4), 240–252.

Hortskotte, G.A., D.G. Niles, D.S. Parker, and D. H. Caldwell. 1974. Full-scale testing of a water

http://mtb/emerging_technologies.pdf

http://water.usgs.gov/nawqa/sparrow/gulf_findings.

<http://www.epa.gov/fedrgstr/EPA-WATER/2001/January/Day-09/w569.htm>

http://www.epa.gov/npdes/pubs/final_local_limits_guidance.pdf

http://www.epa.gov/owm/mtb/etfs_membrane-bioreactors.pdf

<http://www.epa.gov/waterscience/criteria/nutrient/files/policy20070525.pdf>

<http://www.epa.gov/waterscience/criteria/nutrient/strategy/status.html>

<http://www.glerl.noaa.gov/pubs/brochures/mcystisflyer/mcystis.html>

<http://www.longislandsoundstudy.net/pubs/reports/30350report.pdf>

<http://www.werfnutrientchallenge.com/>

Hwang, Y., and T. Tanaka. 1998. Control of *Microthrix parvicella* foaming in activated sludge. *Water Res.* 32 :1678-1686.

Jahan, K. 2003. *A Novel Membrane Process for Autotrophic Denitrification*. Alexandria, VA: WERF and IWA Publishing.

Jenkins, D., M. G. Richard and G. T. Daigger. 1993. *Manual on the Causes and Control of Activated Sludge Bulking and Foaming*. Lewis Publishers, Inc., Chelsea, MI.

Jenkins, D., M. G. Richard, and G. T. Daigger. 1993. *Manual on the causes and control of activated sludge bulking and foaming*, 2nd ed. Lewis Publishers, Chelsea, Mich.

Jenkins, D.I. and W.F. Harper. 2003. *Use of Enhanced Biological Phosphorus Removal for Treating Nutrient-Deficient Wastewater*. Alexandria, VA: WERF and IWA Publishing.

Jimenez, J., La Motta, E. J., & Parker, D. S. (2005). Kinetics of removal of particulate chemical oxygen demand in the activated-sludge process. *Water Environment Research*, 77(5), 437–446.

Jimenez, J., Miller, M., Bott, C., Murthy, S., De Clippeleir, H., & Wett, B. (2015). High-rate activated sludge system for carbon management-evaluation of crucial process mechanisms and design parameters. *Water Research*, 87, 476–482.

Johnson, A. C., J.P. Sumpter. 2001. Removal of Endocrine-Disrupting Chemicals in Activated Sludge Treatment Works. *Environmental Science and Technology*. 35 (24): 4697-4703.

Joss, A., H. Andersen, T. Ternes, P.R. Richle, and H. Siegrist. 2004. Removal of Estrogens in Municipal Wastewater Treatment under Aerobic and Anaerobic Conditions: Consequences for Plant Optimization.

Kaiser, J. 1996. Scientists Angle for Answers. *Science*. 274 (December 13): 1837-1838.

Kalogo, Y., and H. Monteith. 2008. State of Science Report: Energy and Resource Recovery from Sludge. Prepared for Global Water Research Coalition, by WERF, STOWA, and UK Water Industry Research Limited.

Karapinar, I., & Kargi, F. (1996). Effect of wastewater composition on treatment performance of a column bioreactor with recycle. *Bioprocess Engineering*, 14, 245–248.

Katehis, D. 2007. Methanol, glycerol, ethanol, and others (Microc™, Unicarb-DN, corn syrup, etc.) Including Suppliers, Costs, Chemical Physical Characteristics, and Advantages/Disadvantages. 2nd External Carbon Workshop. December 12-13, 2007. Sponsored by WERF, CWEA, VWEA, DC-WASA,

Khan, E., M. Awobamise, K. Jones, and S. Murthy. 2007. Development of Technology Based

Khunjar, W., C. Klein, J. Skotnicka-Pitak, T. Yi, N.G. Love, D. Aga, and W.F. Harper Jr. 2007.

Kinyua, M. N., Elliott, M., Wett, B., Murthy, S., Chandran, K., & Bott, C. B. (2017). The role of extracellular polymeric substances on carbon capture in a high rate activated sludge A-stage system. *Chemical Engineering Journal*, 322, 428–434.

Knocke, W.R., J.W. Nash, and C.W. Randall. 1992. Conditioning and Dewatering of Anaerobically Digested BPR Sludge. *Journal of Environmental Engineering*. 118(5): 642-656.

Kreuzinger, N., M. Clara, and H. Droiss. 2004. Relevance of the Sludge Retention Time (SRT) as Design Criteria for Wastewater Treatment Plants for the Removal of Endocrine Disruptors and Pharmaceuticals from Wastewater. *Water Science Technology*. 50(5): 149-156.

Kümmerer (Ed.). Springer, Berlin, Heidelberg New York, PP. 81–89. *State of Technology Review Report*

Lakay, T. M., M. C. Wentzel, G. A. Ekama, and G. v. R. Marais. 1988. Bulking control with chlorination in a nutrient removal activated sludge system. *Water S.A. No.14* :35-42.

Lancaster, PA: Randall, Ed. Technomic Publishing Co. Inc. pp. 125-126.

Landers, Jay. 2008. Halting Hypoxia. *Civil Engineering*. PP. 54-65. Reston, VA: ASCE Publications. Long Island Sound Study. 2004. Protection+ Progress: Long Island Sound Study Biennial Report 2003–2004. Project Manager/Writer Robert Burg, NEIWPC/LISS. U.S. EPA Long Island Sound Office, Stamford Government Center. Stamford, CT. Available online:

Larsen, T.A., and J. Leinert, Editors. 2007. Novaquatis Final Report. *NoMix – A New Approach to Urban Water Management*. Switzerland: Eawag, Novaquatis.

Lee, C. H., & Liu, J. C. (2001). Sludge dewaterability and floc structure in dual polymer conditioning. *Advances in Environmental Research*, 5(2), 129–136.

Lombardo, P. 2008. Small Communities: Nutrient Management. *Water Environment & Technology*. Alexandria, VA: WEF. 20(1): 14-16.

Love, N. 2007. Maximizing the Dual Benefits of Advanced Wastewater Treatment Plant Processes: Reducing Nutrients and Emerging Contaminants: A Workshop Vision. University of Michigan. Department of Civil and Environmental Engineering.

M. Lebek and K.-H. Rosenwinkel (2002) Control of the growth of *Microthrix parvicella* by using an aerobic selector - results of pilot and full scale plant operation. *Water Science and Technology* Vol 46 No 1-2 pp 491-494.

Management. EPA 832-R-06-006. Available online: <http://www.epa.gov/OWOWM>.

Marten WL and Daigger GT, Full-scale evaluation of factors affecting performance of anoxic selectors. *Water Environ Res* 69:1272-1281 (1997).

Martin, A. J. 1927. *The Activated Sludge Process*. MacDonald and Evans, London.

Martinen, S. K., R. H. Kettunen, and J.A. Rintala. 2003. Occurrence and removal of organic pollutants in sewages and landfill leachates. *The Science of the Total Environment*. 301(1-3): 1-12.

Mathematical Modeling of Biofilms. IWA Task Group on Biofilm Modeling. *Scientific and Technical Mathematics For Wastewater Operators* Archived 2011-08-07 at the Wayback Machine.

Meerburg, F. A., Boon, N., Winckel, T. V., Vercamer, J. A. R., Nopens, I., & Vlaeminck, S. E. (2015). Toward energy-natural wastewater treatment: a high-rate contact stabilization process to maximally recover sewage organics. *Bioresource Technology*, 179, 373–381.

Mega, M., B.L., and R. Sykes. 1998. *Residential Cluster Development: Overview of Key Issues*. MI-07059.

Melcer, H., P.L. Dold, R.M. Jones, C.M. Bye, I. Takacs, H.D. Stensel, A.W. Wilson, P. Sun, and S. Bury. 2003.

Metcalf & Eddy. (2003). *Wastewater Engineering: Treatment and Reuse*, McGraw-Hill, New York.

Methods for Wastewater Characterization in Activated Sludge Modeling. WERF. Project 99-WWF-3.

Miége, C., Choubert, J. M., Ribeiro, L., Eusébe, M., & Coquery, M. (2009). Fate of pharmaceuticals and personal care products in wastewater treatment plants—conception of a database and first results. *Environmental Pollution*, 157(5), 1721–1726.

Mo, W., & Zhang, Q. (2013). Energy-nutrients-water nexus: integrated resource recovery in municipal wastewater treatment plants. *Journal of Environmental Management*, 127, 255–267.

Model Presentation. *Water Environment Research*. 69(5): 969-999.

Modeling COD, N and P Removal in a Full-scale WWTP Haarlem Waarderpolder. *Water Research*. 34(3):846–858.

MT Lakay, A Hulsman, D Ketley, C Warburton, M de Villiers, TG Casey, MC Wentzel and GA Ekama(1999). Filamentous organism bulking in nutrient removal activated sludge systems. Paper 7 Exploratory experimental investigations. *Water SA Vol. 25 No. 4* p383

Munn, B., R. Ott, N. Hatala, and G. Hook. 2008. Tertiary Troubleshooting: Lessons Learned from the Startup of the Largest Tertiary Ballasted Settling System in the United States. *Water Environment & Technology*. Alexandria, VA: WEF. 20(3): 70 -75.

MWCOG. Washington, D.C.

National Association of Clean Water Agencies. 2008. Letter to Ben Grumbles, Assistant Administrator for Water. February 29, 2008.

Neethling, J.B, H.D. Stensel, C. Bott, and D. Clark. 2008. Limits of Technology and Research on Nutrient Removal. WERF Online Conference. October 8.

Neethling, J.B., B. Bakke, M. Benisch, A. Gu, H. Stephens, H.D. Stensel, and R. Moore. 2005. *Factors Influencing the Reliability of Enhanced Biological Phosphorus Removal*. Alexandria, VA: WERF and IWA Publishing.

Nelson, D.J. and T.R. Renner. 2008. Nitrifying in the Cold: A Wisconsin facility experiments with IFAS to ensure nitrification in winter. *Water Environment & Technology*. Alexandria, VA: WEF. 20(4): 54-58.

Ng, H. Y., & Hermanowicz, S. W. (2005). Membrane bioreactor operation at short solids retention times: performance and biomass characteristics. *Water Research*, 39(6), 981–992.

Nitrogen in Treatment Systems and Receiving Waters. Baltimore, MD. September, 27-28, 2007.

Nutrient Control Design Manual: 94 January 2009

Nutrient Control Design Manual State of Technology Review Report: The Cadmus Group, Inc,

Obeng, Letitia A. and Wright, Frederick W. 1987 Integrated Resource Recovery – The cocomposting of domestic solid and human wastes. World Bank Technical Paper Number 57, UNDP Project Management Report Number 7.

Oberstar, J. 2008. Excerpt from Statement of The Honorable James Oberstar, May 12, 2008. *Impacts of Nutrients on Water Quality in the Great Lakes*. Presented before the House Subcommittee on Water Resources and the Environment field hearing. Port Huron, MI.

Occurrence, Fate and Transport of 17β-Estradiol and Testosterone in the Environment. Summer

Oehmen, A., A.M. Sanders, M.T. Vives, Z. Yuan, and J. Keller. 2006. Competition between Phosphate and Glycogen Accumulating Organisms in Enhanced Biological Phosphorus Removal Systems with Acetate and Propionate Carbon Sources. *Journal of Biotechnology*. Elsevier Science BV. 123(1):22-32.

Oehmen, A., Z. Yuan, L.L. Blackall, and J. Keller. 2005. Comparison of Acetate and Propionate Uptake by Polyphosphate Accumulating Organisms and Glycogen Accumulating Organisms. *Biotechnology and Bioengineering*. 91(2). New York, NY: John Wiley & Sons, Inc.

Oldshue, J.Y. (1983). *Fluid Mixing Technology*, McGraw-Hill, New York.

Operation and Control From the Water/ Wastewater Distance Learning Website of the Mountain Empire Community College in Virginia.

Operation of Municipal Wastewater Treatment Plants, Fifth Edition, WEF Manual of Practice (MOP #11), Volume II, Water Environment Federation, 1996.

Operation of Wastewater Treatment Plants, Volume II, Seventh Edition, California State University — Sacramento, Office of Water Programs, 2007.

Oppenheimer, J., R. Stephenson, A. Burbano, and L. Liu. 2007. Characterizing the Passage of Personal Care Products through Wastewater Treatment Processes. *Water Environment Research*. ProQuest Science Journals. 79(13): 2564-2577.

org/Files/Newsletter/Scope%20Newsletter%2057%20Struvite%20conference.pdf

Pagilla, K. 2007. Organic Nitrogen in Wastewater Treatment Plant Effluents. Presentation at the STACWERF Workshop: Establishing a Research Agenda for Assessing the Bioavailability of Wastewater-

Derived Organic Nitrogen in Treatment Systems and Receiving Waters, Baltimore, MD. September, 28, 2007.

Paper: Do You Know Your Sludge Age? Presented at WEFTEC 2008; Water Environment Federation.

Parkin, G. F. and P. L. McCarty. 1981. Production of Soluble Organic Nitrogen During Activated-Sludge Treatment Journal Water Pollution Control Federation. 53(1): 99-112.

Pearson, J.R., D.A. Dievert, D.J. Chelton, and M.T. Formica. 2008. Denitrification Takes a BAF: Starting up the first separate biological anoxic filter in Connecticut requires some problem-solving and know-how.

Pehlivanoglu-Mantas, E. and D. L. Sedlak. 2004. Bioavailability of wastewater-derived organic nitrogen to the alga *Selenastrum capricornutum*. *Water Research* 38(14-15): 3189-3196.

Pehlivanoglu-Mantas, E. and D.L. Sedlak. 2006. Wastewater-Derived Dissolved Organic Nitrogen: Analytical Methods, Characterization, and Effects - A Review. *Critical Reviews in Environmental Science and Technology*. 36:261-285.

Per Halkjaer Nielsen, Caroline Kragelund, Jeppe Lund Nielsen, Senada Tiro, Martin Lebek, Amare Gesesesse.(2003). Control of *Microthrix parvicella* in activated sludge plants: Possible mechanisms. Proceedings of the Post-conference colloquium on Foam and Scum in Biological Wastewater Treatment .5th September 2003, PICT, Prague, Czech Republic p 50.

Pharmaceuticals and Endocrine Disrupting Compounds through Advanced Wastewater Treatment

Poff, L.N., M. Brinson, and J. Day, Jr. 2002. Aquatic Ecosystems and Global Climate Change – Potential Impacts on Inland Freshwater and Coastal Wetland Ecosystems in the United States. Prepared for the Pew Center on Global Climate Change. January 2002.

polyphosphate- and glycogen-accumulating organisms. *Water Research*. 41(6): 1312-1324.

Proceedings of the Water Environment Federation, WEFTEC 2006.

Purdom, C. E., P.A. Hardiman, V.J. Bye, N.C. Eno, C.R. Tyler, J.P. Sumpter. 1994. Estrogenic Effects of Effluents from Sewage Treatment Works. 1994. *Chemistry and Ecology*. 8(4): 275-285.

Rahman, A., Meerburg, F. A., Ravadagundhi, S., Wett, B., Jimenez, J., Bott, C., Al-Omari, A., Riffat, R., Murthy, S., & De Clippeleir, H. (2016). Biofloculation management through high-rate contact-stabilization: a promising technology to recover organic carbon from low-strength wastewater. *Water Research*, 104, 485–496.

Randall, C. W. and R. W. Chapin. 1997. Acetic Acid Inhibition of Biological Phosphorus Removal. *Water Environment Research*. 69(5):955-960.

Randall, C.W., Barnard, J.L., and Stensel, H.D. (1992). "Design and Retrofit of Wastewater Treatment Plants for Biological Nutrient Removal." *Water Quality Management Library*, W.W. Eckenfelder, J.F. Malina, and J.W. Patterson, eds., Technomic Publishing Company, Inc., Lancaster.

Randall, C.W., H.D. Stensel, and J.L. Barnard. 1992. Design of activated sludge biological nutrient removal plants. In *Design and Retrofit of Wastewater Treatment Plants for Biological Nutrient Removal*.

Rauch, W., H. Alderink, P. Krebs, W. Schilling, and P. VanRollegem. 1998. Requirements for Integrated Wastewater Models Driving Receiving Water Objectives. IAWQ Conference, Vancouver.

Reardon, Roderick D. 2005. Tertiary Clarifier Design Concepts and Considerations. Presented at WEFTEC 2005.

Receiving Waters, Baltimore, MD, September, 28, 2007.

reclamation system. *Journal of the Water Pollution Control Federation*. 46(1): 181-197.

Reconnaissance of 17 β -Estradiol, 11-Ketotestosterone, Vitellogenin, and Gonad Histopathology in Common Carp of United States Streams: Potential for Contaminant-Induced Endocrine Disruption.

Reiger, L., G. Koch, M. Kuhni, W. Gujer, and H. Seigrist. 2001. The EAWAG Bio-P Module for Activated Sludge Model No. 3. *Water Research*. 35(16): 3887-3903.

Report 18. London: IWA Publishing. *Water and Wastewater News*. 2008. Research Reveals Silver Nanoparticle Impact. May 6, 2008. Available online: <http://www.wwn-online.com/articles/62252>

Robertson, L. A. and J. G. Kuenen. 1990. Combined Heterotrophic Nitrification and Aerobic Denitrification in *Thiosphaera pantotropha* and other Bacteria. *Antonie Van Leeuwenhoke*, vol. 56, pp. 289-299.

Rogalla, F., S. Tarallo, P. Scanlan, and C. Wallis-Lage. 2008. Sustainable Solutions: Much can be learned from recent work in Europe as well as the United States. *Water Environment & Technology*. Alexandria, VA: WEF. 20(4): 30-33.

S. Rossetti, M.C. Tomei, C. Levantesi, R. Ramadori and V. Tandoi, 2002. "*Microthrix parvicella*": a new approach for kinetic and physiological characterization. *Water Science and Technology* Vol 46 No 12 pp 6572.

Sand/Media Filters. EPA 625/R-00/008.

Scherson, Y. D., & Criddle, C. S. (2014). Recovery of freshwater from wastewater: upgrading process configurations to maximize energy recovery and minimize residuals. *Environmental Science and Technology*, 48(15), 8420–8432.

Schilling, W., W. Bouwens, D. Barcharott, P. Krebs, W. Rauch, and P. VanRollegheem. 1997. Receiving Water Objectives – Scientific Arguments versus Urban Wastewater Management. In *Proceedings IAHR Congress*. San Francisco.

Schuyler, R.G. 1995. Activated Sludge Process Control Troubleshooting Chart. Rothberg, Tamburini and Winsor, Inc., 1600 Stout Street, Suite 1800, Denver, CO 802023126.

SCOPE. 2004. Newsletter No. 57. July. Centre Européen d'Etudes sur les Polyphosphates. Brussels, Belgium. Available online: <http://www.ceepphosphates>.

Sedlak, D. 2007. The Chemistry of Organic Nitrogen in Wastewater Effluent: What It Is, What It Was, and What it Shall Be. Presentation at the STAC-WERF Workshop: Establishing a Research Agenda for Assessing the Bioavailability of Wastewater-Derived Organic Nitrogen in Treatment Systems and Receiving Waters. Baltimore, MD, September, 28, 2007.

Sen, D. and C.W Randall. 2008b. Improved Computational Model (AQUIFAS) for Activated Sludge, IFAS and MBBR Systems, Part II: Biofilm Diffusional Model. *Water Environment Research*. 80(7): 624-632.

Sen, D. and C.W Randall. 2008c. Improved Computational Model (AQUIFAS) for Activated Sludge, IFAS and MBBR Systems, Part III: Analysis and Verification. *Water Environment Research*. 80(7): 633-645.

Sen, D. and C.W. Randall. 2008a. Improved Computational Model (AQUIFAS) for Activated Sludge, Integrated Fixed-Film Activated Sludge, and Moving-Bed Biofilm Reactor Systems, Part I: Semi-Empirical Model Development. *Water Environment Research*. Alexandria, VA: WEF. 80(5):439-453.

Sen, D., S. Murthy, H. Phillips, V. Pattarkine, R.R. Copithorn, C.W. Randall, D. Schwinn, and S. Banerjee. 2008. Minimizing aerobic and post anoxic volume requirements in tertiary integrated fixed-film activated sludge (IFAS) and moving bed biofilm reactor (MBBR) systems using the aquifas model. Courtesy of WEFTEC 2008.

Seuntjens, D., Bundervoet, B. L. M., Mollen, H., De Mulder, C., Wypkema, E., Verliefe, A., Nopens, I., Colsen, J. G. M., & Vlaeminck, S. E. (2016). Energy efficient treatment of A-stage effluent: pilot-scale experiences with shortcut nitrogen removal. *Water Science & Technology*, 75(12), 2150–2158.

Seviour, R. and Nielsen, P.H. (2010). *Microbial Ecology of Activated Sludge*, IWA Publishing, London.

Sherrard, J. H. (1984). Stoichiometric modeling of the activated sludge process. *Water Air Soil Pollution*, 23, 235–247.

Shi, C. Y. (2011). *Mass flow and energy efficiency of municipal wastewater treatment plants*. London: IWA Publishing.

Shi, J., S. Fujisawa, S. Nakai, and M. Hosomi. 2004. Biodegradation of Natural and Synthetic Estrogen by Nitrifying Activated Sludge and Ammonia-oxidizing Bacterium *Nitromonas europaea*. *Water Research*. 38(9): 2323-2330.

Smith, S., I. Takács, S. Murthy, G.T. Daigger, and A. Szabó. Phosphate Complexation Model and Its Implications for Chemical Phosphorus Removal. 2008. *Water Environment Research*. 80(5): 428-438. Alexandria, VA: WEF.

Snyder, S. A., D.L. Villeneuve, E.M. Snyder, J.P. Giesy. 2001. Identification and Quantification of Estrogen Receptor Agonists in Wastewater Effluents. *Environmental Science and Technology*. 35(18): 3620-3625.

Snyder, S. A., P. Westerhoff, Y. Yoon, and D.L. Sedlak. 2003. Pharmaceuticals, Personal Care Products, and Endocrine Disruptors in Water: Implications for the Water Industry. *Environmental Engineering Science*. 20(5): 449-469.

Snyder, S.A., Y. Yoon, P. Westerhoff, B. Vanderford, R. Pearson, D. Rexing. 2003. Evaluation of Specialty Conference. June 25-27, 2007. Vail, Colorado.

Spellman, F. R. (2013). *Water and wastewater infrastructure-energy efficiency and sustainability*. Florida: CRC Press.

Stamatelatos, K., & Tsagarakis, K. P. (2015). *Sewage treatment plants*. London: IWA Publishing.

Standard Methods for the Examination of Water and Wastewater. 20th Edition. 220 pp. Washington, D.C.: APHA, AWWA, and WEF.

State of Technology Review Report

State of Technology Review Report DeCarolis, J., S. Adham, W.R. Pearce, Z. Hirani, S. Lacy, and R. Stephenson. 2008. The Bottom Line: Experts Evaluate the Costs of Municipal Membrane Bioreactors. *Water Environment & Technology*. Alexandria, VA: WEF. 20(1): 54-59.

Stensel H.D. and T.E. Coleman 2000. *Technology Assessments: Nitrogen Removal Using Oxidation Ditches*. Water Environment Research Foundation. Alexandria, VA: WERF and IWA Publishing.

Stenstrom, M.K. and S.S. Song. 1991. Effects of Oxygen Transport Limitations on Nitrification in the

Strom, P.F., H. X. Littleton, and G. Daigger. 2004. Characterizing Mechanisms of Simultaneous Biological Nutrient Removal During Wastewater Treatment. Alexandria, VA: WERF and IWA Publishing.

Strous, M., J. A. Fuerst, E. H. M. Kramer, S. Logemann, G. Muyzert, K. T. Van de Pas-Schoonen, R. Webb, J. G. Kuenen, and M.S. M. Jetten. 1999. Missing Lithotroph Identified as New Planctomycete. *Nature*. Vol. 400

Stumpf, M., T.A. Ternes, K. Haberer, and W. Baumann. 1998. Isolierung von Ibuprofen-Metaboliten und deren Bedeutung als Kontaminanten der aquatischen Umwelt. Isolation of Ibuprofen-Metabolites and their Importance as Pollutants of the Aquatic Environment. In *Fachgruppe Wasserchemie in der Gesellschaft Deutscher Chemiker*. Vom Wasser, Ed. VCH Verlagsgesellschaft mbH. Vol. 91: 291–303.

Sumpter, J. P. 1995. *Toxicology Letters*. Proceedings of the International Congress of Toxicology - VII, Washington State Convention and Trade Center Seattle, Washington, USA, Elsevier Ireland Ltd.

Sürücü, G., & Çetin, F. D. (1990). Effects of temperature, pH and D.O. concentration on settleability of activated sludge. *Environmental Technology*, 11, 205–212.

Szabó, A., I. Takács, S. Murthy, G.T. Daigger, I. Licskó, and S. Smith. 2008. Significance of Design and Operational Variables in Chemical Phosphorus Removal. *Water Environment Research*. 80(5):407-416. Alexandria, VA: WEF.

T. Roels, F. Dauwe, S. Van Damme, K. De Wilde and F. Roelandt (2002). The influence of PAX-14 on activated sludge systems and in particular on *Microthrix parvicella*. *Water Science and Technology* Vol 46 No 1-2 pp 487-490

Takacs, I., Stricker, A.-E., Achleitner, S., Barrie, A., Rauch, W., and Murthy, S. (2008). "Do You Know Your Sludge Age?" WEFTEC Conference Proceedings, Chicago.

Tay, J. and X. Zhang. 2000. A fast Neural Fuzzy Model for High-rate Anaerobic Wastewater Treatment Systems. *Water Research*. Vol. 34(11).

Tchobanoglous, G., F. L. Burton, and H.D. Stensel. 2003. *Wastewater Engineering: Treatment and Reuse*. New York, NY: McGraw-Hill.

Technologies. AWWA – Water Quality Technology Conference.

Technology Conference.

Technology. Alexandria, VA: WEF. 20(1): 85-86.

Ternes, T.A. 1998. Occurrence of drugs in German sewage treatment plants and rivers. *Water Research*. 32(11): 3245–3260.

Ternes, T.A., P. Kreckel, and J. Müller. 1999. Behaviour and Occurrence of Estrogens in Municipal Sewage Treatment Plants—II. Aerobic Batch Experiments with Activated Sludge. *The Science of the Total Environment*. 225(1–2): 91–99.

Tracy, K. D. and A. Flammino. 1987. Biochemistry and Energetics of Biological Phosphorus Removal. Proceeding, IAWPRC International Specialized Conference, Biological Phosphorus Removal from Wastewater. Rome, Italy. September 28-30. In *Biological Phosphorus Removal from Wastewater*. PP. 15-26. R. Ramadori, Ed. New York, NY: Pergamon Press.

Treatment. 04-WEM-6. Alexandria, VA: WERF and IWA Publishing.

Treatment. *Advances in Biochemical Engineering and Biotechnology*. Vol. 48.

U.S. Public Health Service and USEPA. 2008. Clean Watersheds Needs Surveys 2004 Report to Congress. Available online: <http://www.epa.gov/cwns/2004rtc/cwns2004rtc.pdf>

Urgun-Demrtas, M., C. Sattayatewa, and K.R. Pagilla. 2007. Bioavailability Of Dissolved Organic Nitrogen In Treated Effluents. Proceedings from International Water Association/Water Environment Federation Nutrient Removal Conference, Baltimore, MD, March 2007.

USEPA 2000e. Wastewater Technology Fact Sheet Wetlands: Subsurface Flow. USEPA, Office of Water.

USEPA 2004. Local Limits Development Guidance. EPA 833-R-04-002A. Available online:

USEPA. 1976. Process Design Manual for Phosphorus Removal. Great Lakes National Program Office.

USEPA. 1987. Design Manual: Phosphorus Removal. Center for Environmental Research Information. Cincinnati, OH. EPA/625/1-87/001.

USEPA. 1987a. Handbook: Retrofitting POTWs for Phosphorus Removal in the Chesapeake Bay Drainage Basin. Center for Environmental Research Information. Cincinnati, OH. EPA/625/6-87/017.

USEPA. 1993. Nitrogen Control Manual. Office of Research and Development. EPA/625/R-93/010. September 1993.

USEPA. 1999. Decentralized Systems Technology Fact Sheet: Recirculating Sand Filters. USEPA, Office of Water. EPA 832-F-99-079. September 1999.

USEPA. 1999a. Enhanced Coagulation and Enhanced Precipitative Softening Guidance Manual. Office of Water. EPA 815-R-99-012.

USEPA. 1999b. Wastewater Technology Fact Sheet: Fine Bubble Aeration. EPA 831-F-99-065. Available online: <http://epa.gov/OWM/mtb/mtbfact.htm>

USEPA. 1999c. Wastewater Technology Fact Sheet: Sequencing Batch Reactors. EPA 832-F-99-073.

USEPA. 2000a. Wastewater Technology Fact Sheet: Trickling Filter Nitrification. EPA 832-F-00-015.

USEPA. 2000b. Wastewater Technology Fact Sheet: Ammonia Stripping. EPA 832-F-00-019. Available online: http://www.epa.gov/owm/mtb/ammonia_stripping.pdf

USEPA. 2000c. Wastewater Technology Fact Sheet: Oxidation Ditches. EPA 832-F-00-013. Available online: http://www.epa.gov/owm/mtb/oxidation_ditch.pdf

USEPA. 2000d. Wastewater Technology Fact Sheet: Chemical Precipitation. Office of Water. EPA 832-F-00-018.

USEPA. 2003. Wastewater Technology Fact Sheet: Ballasted Flocculation. Office of Waste Management. Municipal Technology Branch. EPA 832-F-03-010.

USEPA. 2007. Biological Nutrient Removal Processes and Costs. U.S. Environmental Protection Agency Factsheet. EPA 823-R-07-002. June 2007.

USEPA. 2007a. Current Status of States & Territories Numeric Nutrient Criteria for Class of Waters Adopted Post-1997. Updated May 14, 2007. Available online:

USEPA. 2007b. Memorandum from Benjamin Grumbles, Assistant Administrator for Water. Nutrient Pollution and Numeric Water Quality Standards. May 25, 2007. Available online:

USEPA. 2007c. Wastewater Management Fact Sheet: Denitrifying Filters. EPA 832-F-07-014.

USEPA. 2007d. Wastewater Management Fact Sheet: Membrane Bioreactors. Available online:

USEPA. 2007e. Wastewater Technology Fact Sheet: Side Stream Nutrient Removal. EPA 832-F-07-017.

USEPA. 2008a. Emerging Technologies for Wastewater Treatment and In-Plant Wet Weather

USEPA. 2008b. Mississippi River Basin & Gulf of Mexico Hypoxia. EPA Office of Wetlands, Oceans and Watersheds. Updated June 26, 2008. Available online: <http://www.epa.gov/msbasin/>

USEPA. 2008c. Onsite Wastewater Treatment Systems Technology Fact Sheet 2: Fixed Film Processes. EPA 625/R-00/008.

USEPA. 2008d. Onsite Wastewater Treatment Systems Technology Fact Sheet 3: Sequencing Batch Reactor Systems. EPA 625/R-00/008.

USEPA. 2008e. Onsite Wastewater Treatment Systems Technology Fact Sheet 8: Enhanced Nutrient Removal – Phosphorus. EPA 625/R-00/008.

USEPA. 2008f. Onsite Wastewater Treatment Systems Technology Fact Sheet 9 :Enhanced Nutrient Removal – Nitrogen. EPA 625/R-00/008.

USEPA. 2008g. Onsite Wastewater Treatment Systems Technology Fact Sheet 10: Intermittent

USEPA. 2008h. Onsite Wastewater Treatment Systems Technology Fact Sheet 11: Recirculating

Vaccari, D.A., Fagedes, T., and Longtin, J. (1985). "Calculation of Mean Cell Residence Time for Unsteady-State Activated Sludge Systems." *Biotechnology and Bioengineering*, 27(5), 695-703.

Vader, J., C. van Ginkel, F. Sperling, F. de Jong, W. de Boer, J. de Graaf, M. van der Most, and P.G.W. Stokman. 2000. Degradation of Ethinyl Estradiol by Nitrifying Activated Sludge. *Chemosphere*. 41 (8):1239-1243.

Vanderploeg, H. 2002. The Zebra Mussel Connection: Nuisance Algal Blooms, Lake Erie Anoxia, and other Water Quality Problems in the Great Lakes. 2002. Great Lake Environmental Research Laboratory. Ann Arbor, MI. Revised September 2002. Available online:

Vanhooren, H., J. Meirlaen, V. Amerlink, F. Claeys, H. Vangheluwe, and P.A. Vanrolleghem. 2003. WEST Modelling Biological Wastewater Treatment. *Journal of Hydroinformatics*. London: IWA Publishing. 5(2003)27-50.

VanRollegheem, P.A. and D. Dochan. 1997. *Model Identification in Advanced Instrumentation, Data Interpretation, and Control of Biotechnological Processes*. Eds. J. Van Impe, P.A. VanRollegheem, and B. Igerentant. Netherlands: Kluwer Publishers.

VanRollegheem, P.A., W. Schilling, W. Rauch, P. Krebs, and H. Alderink. 1998. Setting up Campaigns for Integrated Wastewater Modeling. AWQ Conference: Applications of Models in Wastewater Management. Amsterdam.

Verma, M., S.K. Brar, J.F. Blais, R.D Tyagi, and R.Y. Surampalli. 2006. Aerobic Biofiltration Processes---Advances in Wastewater Treatment. *Pract. Periodical of Haz., Toxic, and Radioactive Waste Mgmt.* 10:264-276.

Versprille, A. I., Zuurveen, B., & Stein, T. (1984). The A-B process: a novel two-stage wastewater treatment system. *Water Science & Technology*, 17, 235–246.

Verstraete, W., Van de Caveye, P., & Diamantis, V. (2009). Maximum use of resources present in domestic “used water”. *Bioresource Technology*, 100(23), 5537–5545.

Vethaak, A. D., J. Lahr, S.M. Schrap, A.C. Belfroid, G.B.J. Rijs, A. Gerritsen, J. de Boer, A.S. Bulder, G.C.M. Wan, J., Gu, J., Zhao, Q., & Liu, Y. (2016). COD capture, a feasible option towards energy self-sufficient domestic wastewater treatment. *Scientific Reports*, 6, 25054.

Wanner, O., H. Eberl, E. Morgenroth, D. Noguera, C. Picioreanu, B. Rittman, and M.V. Loosdrecht. 2006. *Wastewater engineering : treatment and reuse (4th ed.)*. Metcalf & Eddy, Inc., McGraw Hill, USA. 2003. p. 1456. ISBN 0-07-112250-8.

Water Environment & Technology. Alexandria, VA: WEF. 20(5): 48-55.

Water Environment Federation (WEF). (2011). Nutrient Removal: WEF Manual of Practice No. 34, McGraw-Hill, New York.

WE&T. 2008a. Plant Profile: H.L. Mooney Water Reclamation Facility. *Water Environment & Technology*. Alexandria, VA: WEF. 20 (4): 70-71.

WE&T. 2008b. Problem Solvers: Enhanced Nutrient Removal Achieved. *Water Environment & Technology*. Alexandria, VA: WEF. 20(4): 16.

WE&T. 2008c. Research Notes: Seeking to Destroy Hormone like Pollutants in Wastewater. *Water Environment & Technology*. Alexandria, VA: WEF. 20(4): 16.

WE&T. 2008d. Research Notes: Study Examines Impacts of Membrane Residuals. *Water Environment & Technology*. Alexandria, VA: WEF. 20(2): 6-8.

WE&T. 2008e. Small Communities: Distributed Wastewater Management, A practical, cost-effective, and sustainable approach to solving wastewater problems. *Water Environment & Technology*. Alexandria, VA: WEF. 20(2): 12-16.

WE&T. 2008f. Waterline: Composting Toilets Serve Bronx Zoo Visitors. *Water Environment & Technology*. Alexandria, VA: WEF. 20(3): 35.

WEF and ASCE. 1998. Design of Municipal Wastewater Treatment Plants - MOP 8, 4th Ed. Water Environment Federation and American Society of Civil Engineers. Alexandria, VA: WEF.

WEF and ASCE. 2006. Biological Nutrient Removal (BNR) Operation in Wastewater Treatment Plants - MOP 29. Water Environment Federation and the American Society of Civil Engineers. Alexandria, VA: WEF Press.

WEF. 2000. *Aerobic Fixed-Growth Reactors*, a special publication prepared by the Aerobic Fixed-Growth Reactor Task Force. WEF, Alexandria VA.

WEF. 2001. Natural Systems for Wastewater Treatment - MOP FD-16, 2nd Ed. Alexandria, VA: WEF.

WEF. 2005. *Membrane Systems for Wastewater Treatment*. Alexandria, VA: WEF Press.

WERF. 2000a. Technology Assessments: Nitrogen Removal Using Oxidation Ditches. Alexandria, VA, WERF.

WERF. 2000b. Investigation of Hybrid Systems for Enhanced Nutrient Control. Final Report, Collection and Treatment. Project 96-CTS-4. Alexandria, VA: WERF.

WERF. 2003a. A Novel Membrane Process for Autotrophic Denitrification. Alexandria, VA: WERF and IWA Publishing.

WERF. 2003b. Executive Summary: Methods for Wastewater Characterization in Activated Sludge Modeling. Alexandria, VA: WERF and IWA Publishing.

WERF. 2004. Preliminary Investigation of an Anaerobic Membrane Separation Process for Treatment of Low-Strength Wastewaters. Alexandria, VA: WERF and IWA Publishing.

WERF. 2004a. *Acclimation of Nitrifiers for Activated Sludge Treatment: A Bench-Scale Evaluation*. Alexandria, VA: WERF and IWA Publishing.

WERF. 2005. Technical Brief: Endocrine Disrupting Compounds and Implications for Wastewater Treatment. Alexandria, VA: WERF and IWA Publishing.

WERF. 2005a. Nutrient Farming and Traditional Removal: An Economic Comparison. Alexandria, VA: WERF and IWA Publishing.

WERF. 2005b. Technical Approaches for Setting Site-Specific Nutrient Criteria. Alexandria, VA: WERF and IWA Publishing.

WERF. 2007. Nutrient Challenge Research Plan – 2007. October 31, 2007. Available online: http://www.werf.org/Portals/0/PDF/2007_Nutrient_Challenge_Research_Plan.pdf

Wett B., Buchauer K. & Fimml C. (2007). Energy self-sufficiency as a feasible concept for wastewater treatment systems. IWA Leading Edge Technology Conference Singapore, Asian Water 21–24.

Whang, L.M., C.D.M. Filipe, and J.K. Park. 2007. Model-based evaluation of competition between

Wilson, T.E. and J. McGettigan. 2007. Biological Limitations: Chemical processes may be better at achieving strict effluent phosphorus limits. *Water Environment & Technology*. 19(6): 77-81. Alexandria, VA: WEF.

Woods, N.C., S.M. Sock, and G.T. Daigger. 1999. Phosphorus Recovery Technology Modeling and Feasibility Evaluation for Municipal Wastewater Treatment Plants. *Environmental Technology*. 20(7): 663-679.

Yi, T. and W. F. Harper. 2007. The Link between Nitrification and Biotransformation of 17 -

Zhao, W., Ting, Y. P., Chen, J. P., Xing, C. H., & Shi, S. Q. (2000). Advanced primary treatment of wastewater using a bio-flocculation-adsorption sedimentation process. *Acta Biotechnology*, 20(1), 53–64.

Zwiener, C., T.J. Gremm, and F.H. Frimmel. 2001. Pharmaceutical Residues in the Aquatic Environment and Their Significance for Drinking Water Production. In *Pharmaceuticals in the Environment*. Klaus.



We welcome you to complete the assignment in Microsoft Word. You can easily find the assignment at www.abctlc.com.

Once complete, just simply fax or e-mail the answer key along with the registration page to us and allow two weeks for grading.

Once we grade it, we will mail a certificate of completion to you. Call us if you need any help. If you need your certificate back within 48 hours, you may be asked to pay a rush service fee of \$50.00.

You can download the assignment in Microsoft Word from TLC's website under the Assignment Page. www.abctlc.com

You will have 90 days in order to successfully complete this assignment with a score of 70% or better. If you need any assistance, please contact TLC's Student Services. Once you are finished, please mail, e-mail or fax your answer sheet along with your registration form.