

# PUMPS 303

CONTINUING EDUCATION  
PROFESSIONAL DEVELOPMENT COURSE



 **Technical  
Learning  
College**



## Printing and Saving Instructions

It is recommended that you download this pdf document and assignment to your computer desktop and open it with Adobe Acrobat DC reader.

Adobe Acrobat DC reader is a free computer software program and you can find it at Adobe Acrobat's website.

You can complete the course by viewing the course on your computer or you can print it out. This course booklet does not have the assignment (the test). Please visit our website and download the assignment (the test).

**Printing Instructions:** Once you have purchased the program, we will give you permission to print this document. If you are going to print this document, it was designed to be printed double-sided or duplexed but can be printed single-sided.

### Hyperlink to Assignment...

<http://www.ABCTLC.COM/downloads/PDF/PUMPS303ASS.pdf>

**State Approval Listing Link,** check to see if your State accepts or has pre-approved this course. Not all States are listed. Not all courses are listed. Do not solely trust our list for it may be outdated. It is your sole responsibility to ensure this course is accepted for credit. No refunds.

### State Approval Listing URL...

<http://www.ABCTLC.com/PDF/CEU%20State%20Approvals.pdf>

**Professional Engineers;** Most states will accept our courses for credit but we do not officially list the States or Agencies. Please check with your State Agency for acceptance.

*You can obtain a printed version from TLC for an additional \$129.95 plus shipping charges.*

*All downloads are electronically tracked and monitored for security purposes.*

### Hyperlink to the Glossary and Appendix

<http://www.abctlc.com/downloads/PDF/PumpGlossary.pdf>





**Some States and many employers require the final exam to be proctored.**

**Do not solely depend on TLC's Approval list for it may be outdated.**

Most of our students prefer to do the assignment in Word and e-mail or fax the assignment back to us. We also teach this course in a conventional hands-on class. Call us and schedule a class today.



**Library of Congress Card Number 6584962**  
**ISBN 978-0-9799559-6-9**

**Copyright Notice**

1999-2020 Technical Learning College (TLC) No part of this work may be reproduced or distributed in any form or by any means without TLC's prior written approval. Permission has been sought for all images and text where we believe copyright exists and where the copyright holder is traceable and contactable. Other materials including text and artwork are in the public domain or fair use (the state of belonging or being available to the public as a whole, and therefore not subject to copyright.) All material that is not credited or acknowledged or referenced in the rear of this course is the copyright of Technical Learning College. All other unacknowledged references are in the Water/ Wastewater Sampling and Water Chemistry Courses.

Most unaccredited photographs have been taken by TLC instructors or TLC students. All written, graphic, photographic or other material is provided for educational information only. We will be pleased to hear from any copyright holder and will make good on your work if any unintentional copyright infringements were made as soon as these issues are brought to the editor's attention. This educational training course and assignment is intended for educational purposes only.

Every possible effort was made to ensure that all information provided in this course is accurate. Therefore, Technical Learning College accepts no responsibility or liability whatsoever for the application or misuse of any information included herein.

Requests for acknowledgements or permission to make copies shall be made to the following address: TLC, P.O. Box 3060, Chino Valley, AZ 86323

Information in this document is subject to change without notice. TLC is not liable for errors or omissions appearing in this document.





## Important Information about this Manual

This manual has been prepared to educate operators in the general education of pumping, pumps, motors, and hydraulic principles including basic water training and different pump applications. For most students, the study of pumping and hydraulics is quite large, requiring a major effort to bring it under control.

This manual should not be used as a guidance document for employees who are involved with cross-connection control. It is not designed to meet the requirements of the United States Environmental Protection Agency (EPA), the Department of Labor-Occupational Safety and Health Administration (OSHA), or your state environmental or health agency. Technical Learning College or Technical Learning Consultants, Inc. makes no warranty, guarantee or representation as to the absolute correctness or appropriateness of the information in this manual and assumes no responsibility in connection with the implementation of this information.

It cannot be assumed that this manual contains all measures and concepts required for specific conditions or circumstances. This document should be used for educational purposes and is not considered a legal document. Individuals who are responsible for hydraulic equipment, cross-connection control, backflow prevention or water distribution should obtain and comply with the most recent federal, state, and local regulations relevant to these sites and are urged to consult with OSHA, the EPA and other appropriate federal, state and local agencies.

### Contributing Editors

**James L. Six** Received a Bachelor of Science Degree in Civil Engineering from the University of Akron in June of 1976, Registered Professional Engineer in the State of Ohio, Number 45031 (Retired), Class IV Water Supply Operator issued by Ohio EPA, Number WS4-1012914-08, Class II Wastewater Collection System Operator issued by Ohio EPA, Number WC2-1012914-94

**Joseph Camerata** has a BS in Management with honors (magna cum laude). He retired as a Chemist in 2006 having worked in the field of chemical, environmental, and industrial hygiene sampling and analysis for 40 years.

**James Bevan**, Water Quality Inspector S.M.E. Twenty years of experience in the environmental field dealing with all aspects of water regulations on the federal, state, and local levels. Teacher and Proctor in Charge for Backflow Certification Testing at the ASETT Center in Tucson for the past 15 years and possess an Arizona Community College, Special Teaching Certificate in Environmental Studies.

**Dr. Pete Greer** S.M.E., Retired biology instructor, chemistry and biological review.

**Jack White**, Environmental, Health, Safety expert, City of Phoenix. Art Credits.



# Technical Learning College's Scope and Function

Welcome to the Program,

Technical Learning College (TLC) offers affordable continuing education for today's working professionals who need to maintain licenses or certifications. TLC holds several different governmental agency approvals for granting of continuing education credit.

TLC's delivery method of continuing education can include traditional types of classroom lectures and distance-based courses or independent study. TLC's distance based or independent study courses are offered in a print - based distance educational format. We will beat any other training competitor's price for the same CEU material or classroom training.

Our courses are designed to be flexible and for you to finish the material at your convenience. Students can also receive course materials through the mail. The CEU course or e-manual will contain all your lessons, activities and instruction to obtain the assignments. All of TLC's CEU courses allow students to submit assignments using e-mail or fax, or by postal mail. (See the course description for more information.)

Students have direct contact with their instructor—primarily by e-mail or telephone. TLC's CEU courses may use such technologies as the World Wide Web, e-mail, CD-ROMs, videotapes and hard copies. (See the course description.) Make sure you have access to the necessary equipment before enrolling; i.e., printer, Microsoft Word and/or Adobe Acrobat Reader. Some courses may require proctored closed-book exams, depending upon your state or employer requirements.

## **Flexible Learning**

At TLC there are no scheduled online sessions or passwords you need contend with, nor are you required to participate in learning teams or groups designed for the "typical" younger campus based student. You will work at your own pace, completing assignments in time frames that work best for you. TLC's method of flexible individualized instruction is designed to provide each student the guidance and support needed for successful course completion.

## **Course Structure**

TLC's online courses combine the best of online delivery and traditional university textbooks. You can easily find the course syllabus, course content, assignments, and the post-exam (Assignment). This student-friendly course design allows you the most flexibility in choosing when and where you will study.

## **Classroom of One**

TLC offers you the best of both worlds. You learn on your own terms, on your own time, but you are never on your own. Once enrolled, you will be assigned a personal Student Service Representative who works with you on an individualized basis throughout your program of study. Course specific faculty members (S.M.E.) are assigned at the beginning of each course providing the academic support you need to successfully complete each course. Please call or email us for assistance.

### **Satisfaction Guaranteed**

We have many years of experience, dealing with thousands of students. We assure you, our customer satisfaction is second to none. This is one reason we have taught more than 20,000 students.

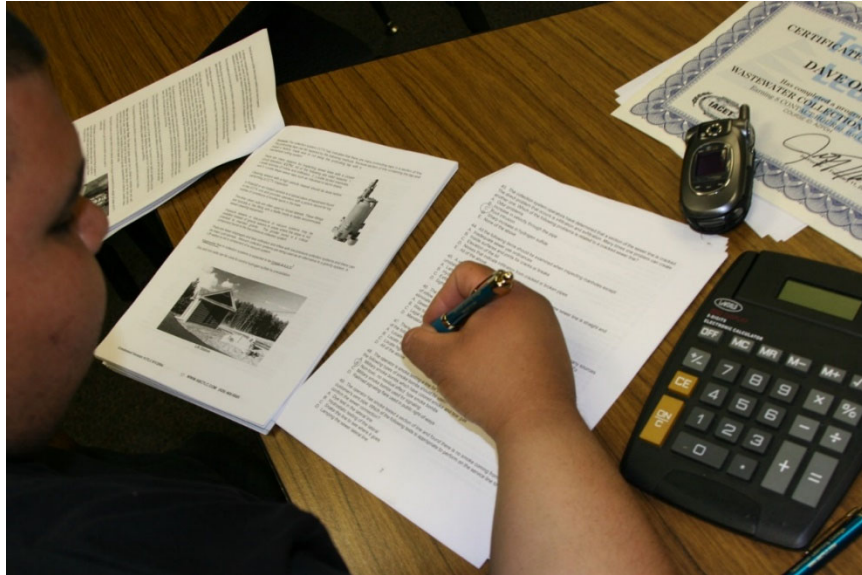

We welcome you to do the electronic version of the assignment and submit the answer key and registration to us either by fax or e-mail. If you need this assignment graded and a certificate of completion within a 48-hour turn around, prepare to pay an additional rush charge of \$50.

**Contact Numbers**  
**Fax (928) 468-0675**  
**Email [Info@tlch2o.com](mailto:Info@tlch2o.com)**  
**Telephone (866) 557-1746**

# Course Description

## Pumps 303 CEU Training Course

This distance learning CEU training course will examine commonly found conventional water/well/wastewater/collection lift station fluid pumping methods, and related motor and components. This course was designed to provide continuing education credit to water and/ or wastewater treatment/onsite operators and well drillers.

### Course Purpose

The main purpose of this course is to provide continuing education in understanding various water lifting procedures, basic pump fundamentals, hydraulic principles, theory, maintenance, related electrical and motor principles.

### Target Audience

*Water Distribution, Well Drillers, Pump Installers, Water Treatment Operators, Wastewater Treatment Operators, Wastewater Collection Operators, Industrial Wastewater Operators and General Backflow Assembly Testers.* The target audience for this course is the person interested in working in a water or wastewater treatment or distribution/collection facility and/or wishing to maintain CEUs for certification license or to learn how to do the job safely and effectively, and/or to meet education needs for promotion. There are no prerequisites, and no other materials are needed for this course.

### Prerequisite

Basic math knowledge at a high school level is recommended for successful completion of this course.

### Final Examination for Credit

Opportunity to pass the final comprehensive examination is limited to three attempts per course enrollment.

### Course Procedures for Registration and Support

All of Technical Learning College's correspondence courses have complete registration and support services offered. Delivery of services will include, e-mail, web site, telephone, fax and mail support. TLC will attempt immediate and prompt service.

When a student registers for a distance or correspondence course, he/she is assigned a start date and an end date. It is the student's responsibility to note dates for assignments and keep up with the course work. If a student falls behind, he/she must contact TLC and request an end date extension in order to complete the course. It is the prerogative of TLC to decide whether to grant the request. All students will be tracked by a unique number assigned to the student.

### Instructions for Assignment

The Pumps 303 CEU training course uses a multiple choice type answer key. You can find a copy of the answer key in Word format on TLC's website under the Assignment Page. You can write your answers in this manual or type out your own answer key. TLC would prefer that you type out and fax or e-mail the final exam to TLC, but it is not required.

**Feedback Mechanism (Examination Procedures)**

Each student will receive a feedback form as part of their study packet. You will be able to find this form in the front of the course assignment or lesson.

**Security and Integrity**

All students are required to do their own work. All lesson sheets and final exams are not returned to the student to discourage sharing of answers. Any fraud or deceit and the student will forfeit all fees and the appropriate agency will be notified.

**Grading Criteria**

TLC will offer the student either pass/fail or a standard letter grading assignment. If TLC is not notified, you will only receive a pass/fail notice.

**Required Texts**

The ***Pumps 303*** CEU training course will not require any other materials. This course comes complete. No other materials are needed.

**ADA Compliance**

TLC will make reasonable accommodations for persons with documented disabilities. Students should notify TLC and their instructors of any special needs. Course content may vary from this outline to meet the needs of this particular group. Please check with your State for special instructions.

You will have 90 days from receipt of this manual to complete it in order to receive your Continuing Education Units (CEUs) or Professional Development Hours (PDHs). A score of 70% or better is necessary to pass this course. If you should need any assistance, please email all concerns and the final test to: [info@tlch2o.com](mailto:info@tlch2o.com).

**Educational Mission****The educational mission of TLC is:**

*To provide TLC students with comprehensive and ongoing training in the theory and skills needed for the environmental education field,*

*To provide TLC students with opportunities to apply and understand the theory and skills needed for operator certification,*

*To provide opportunities for TLC students to learn and practice environmental educational skills with members of the community for the purpose of sharing diverse perspectives and experience,*

*To provide a forum in which students can exchange experiences and ideas related to environmental education,*

*To provide a forum for the collection and dissemination of current information related to environmental education, and to maintain an environment that nurtures academic and personal growth.*

# Table of Contents

Topic Legend.....	20
<b>Section 1 – PHYSICAL SCIENCE AND RELATED LAWS.....</b>	<b>21</b>
Physical Science Key Terms- SCI &TECH & PE.....	23
Physical Science and Related Laws Introduction- SCI &TECH & PE.....	25
Newton’s Laws- SCI &TECH & PE.....	25
Force- SCI &TECH & PE .....	27
Inertia- SCI &TECH & PE .....	28
Mass- SCI &TECH & PE .....	28
The Hypothesis of Force- SCI &TECH & PE .....	31
Three Laws of Motion- SCI &TECH & PE .....	33
Conservation of Mass and Energy- SCI &TECH & PE .....	33
The Law of Thermodynamics- SCI &TECH & PE .....	33
Continuum Assumption- SCI &TECH & PE .....	37
Knudsen Number- SCI &TECH & PE .....	38
Pascal’s Law- SCI &TECH & PE .....	38
Static Pressure- SCI &TECH & PE .....	41
Volume and Velocity of Flow- SCI &TECH & PE .....	42
Understanding the Venturi- SCI &TECH & PE .....	43
Bernoulli’s Principle- SCI &TECH & PE .....	44
Post Quiz .....	47
References.....	49
<b>Section 2 – FLUID MECHANICS AND HYDRAULIC PRINCIPLES.....</b>	<b>51</b>
Key Terms.....	53
Hydraulic Systems Intro- SCI &TECH & PE.....	55
Hydraulics- SCI &TECH & PE .....	57
Fluid Mechanics- SCI &TECH & PE .....	59
Properties of Fluids- SCI &TECH & PE .....	61
Fluid Statics- SCI &TECH & PE.....	61
Fluid Dynamics- SCI &TECH & PE .....	61
Gases and Liquids- SCI &TECH & PE .....	62
Surface Tension- SCI &TECH & PE .....	71
Friction Section- SCI &TECH & PE.....	73
Kinetic Energy- SCI &TECH & PE .....	73
Drag Force- SCI &TECH & PE .....	74
Types of Drag - SCI &TECH & PE .....	75
Parshall Flumes- SCI &TECH & PE.....	77
Hydraulic/Electrical Analogy - SCI &TECH & PE.....	81
Post Quiz.....	91
References.....	93

<b>Section 3- FLUID AND HYDRAULIC FORCES AND PRESSURES.....</b>	<b>97</b>
Key Terms.....	99
Fluid/Hydraulic Principles & Pressures- SCI &TECH & PE.....	101
Atmospheric Pressure- SCI &TECH & PE .....	101
Atmospheric Pressure and its Effects- SCI &TECH & PE.....	103
Vacuum- SCI &TECH & PE .....	104
Barometric Loop- SCI &TECH & PE &CC.....	105
Water Pressure- SCI &TECH & PE .....	107
Pressure and Force- SCI &TECH & PE.....	108
Free Surface Perpendicular to Gravity- SCI &TECH & PE.....	111
Computing Force, Pressure, and Area- SCI &TECH & PE.....	112
Post Quiz.....	115
References.....	117
<b>Section 4 – EXPERIEMENTS AND EARLY APPLICATIONS.....</b>	<b>121</b>
Application Key Terms–PE & TECH &FM .....	123
Modern Application–PE & TECH &FM .....	125
The Hydraulic Lever –PE & TECH &FM.....	127
Dudley Castle Engine- SCI &TECH & PE & FM .....	129
Hawksbee's Dual Cylinder Pump- SCI &TECH & PE & FM .....	130
Bell-Jar Receiver- SCI &TECH & PE & FM .....	131
Forces on Submerged Surfaces- SCI &TECH & PE & FM .....	133
Buoyancy- SCI &TECH & PE & FM .....	137
Measurement of Specific Gravity- SCI &TECH & PE & FM .....	139
Variations in Specific Gravity- SCI &TECH & PE & FM.....	139
Hydrometer- SCI &TECH & PE .....	142
Application Post Quiz.....	147
Application References.....	149
<b>Section 5 –HYDRAULIC FOUNDATIONS AND THEORIES.....</b>	<b>151</b>
Blaise Pascal- SCI &TECH & PE & FM .....	151
Key Terms- SCI &TECH & PE & FM .....	153
Hydraulic Foundations and Theories Intro- SCI &TECH & PE & FM.....	155
Archimedes- SCI &TECH & PE & FM .....	155
Daniel Bernoulli- SCI &TECH & PE & FM.....	159
Development of Hydraulics- SCI &TECH & PE & FM .....	161
Pascal Law- SCI &TECH & PE & FM.....	161
Evangelista Torricelli- SCI &TECH & PE & FM .....	163
Post Quiz.....	165
References.....	167
<b>Section 6- PUMPS AND PUMPING WATER.....</b>	<b>171</b>
General Pumping Fundamentals-PE & FM & TECH & O&M.....	173
Types of Water Pumps-PE & FM & TECH & O&M .....	175



Simple Pumps-PE & FM & TECH & O&M .....	177
Impulse Pump - PE & FM & TECH & O&M.....	183
Gravity Pump - PE & FM & TECH & O&M.....	187
Wind Mills- PE & FM & TECH & O&M.....	191
Sling Pump- PE & FM & TECH & O&M.....	193
Pump Definition-PE & FM & TECH .....	197
Pumps and Pumping Water Post Quiz.....	199
<b>Section 7- COMPLICATED PUMPS.....</b>	<b>201</b>
Types of Pumps-PE & FM & TECH.....	203
Pump Categories-PE & FM & TECH & O&M .....	204
Complicated Pumps Intro-PE & FM & TECH & O&M .....	205
Pump Diagrams -PE & FM & TECH.....	207
Pump Operation-PE & FM & TECH & O&M .....	213
Positive Displacement-PE & FM & TECH .....	219
Centrifugal Pump-PE & FM & TECH .....	221
Progressive Cavity-PE & FM & TECH .....	229
Peristaltic Pump-PE & FM & TECH .....	233
Reciprocating Pump-PE & FM & TECH.....	243
Vapor Pressure and Cavitation -PE & FM & TECH.....	247
Submersible Pump-PE & FM & TECH & O&M .....	251
Vertical Turbine-PE & FM & TECH & O&M & GP .....	265
Pump Troubleshooting-PE & FM & TECH & O&M & GP.....	277
Pump Not Delivering Water-PE & FM & TECH & O&M & GP .....	283
Complicated Pumps Post Quiz.....	289
References.....	291
<b>Section 8- PUMP OPERATION AND PERFORMANCE.....</b>	<b>293</b>
Key Terms.....	295
Pump Requirements-PE & FM & TECH .....	299
Pump Specifications.....	307
Pump Efficiency-PE & FM & TECH .....	311
Net Positive Suction Head Section-PE & FM & TECH .....	312
Pump Viscosity-PE & FM & TECH .....	315
Moody Chart-PE & FM & TECH .....	319
Suction Lift-PE & FM & TECH .....	323
Affinity Laws - Centrifugal Pumps-PE & FM & TECH .....	327
Motor and Pump Calculations-PE & FM & TECH .....	333
Pump Operation Post Quiz.....	339
Pump Operation References.....	341
<b>Section 9- MOTOR AND COUPLING SECTION.....</b>	<b>345</b>
Coupling Introduction-PE & FM & TECH & O&M & GP.....	347
Alignment of Couplings-PE & FM & TECH & O&M & GP.....	348

Packing Seals-PE & FM & TECH & O&M & GP.....	349
Mechanical Seals-PE & FM & TECH & O&M & GP.....	353
Pump Operating Problems-PE & FM & TECH & O&M & GP.....	355
Stuffing Box Installation-PE & FM & TECH & O&M & GP.....	361
Impeller Adjustment-PE & FM & TECH & O&M & GP.....	365
Post Quiz.....	367
<b>Section 10- GROUNDWATER PRODUCTION.....</b>	<b>369</b>
Groundwater Introduction -O&M.....	371
Aquifer Introduction -O&M and TECH.....	373
Cone of Depression O&M and TECH .....	375
Well Reports - O&M and TECH .....	379
Permeability of Aquifer - O&M and TECH .....	383
Well Tests-PE & TECH & O&M & GP .....	387
Well Drilling- O&M and TECH -PE & TECH & O&M & GP.....	391
Direct Rotary-PE & TECH & O&M & GP .....	393
Reverse Mud Rotary-PE & TECH & O&M & GP .....	397
Drill Through Casing Driver- O&M and TECH .....	399
Solid Stem Auger Method-PE & TECH & O&M & GP .....	402
Hollow Stem Auger-PE & TECH & O&M & GP .....	403
Cable Tool Method-PE & TECH & O&M & GP .....	407
Selecting an Appropriate Well Site-PE & TECH & O&M & GP .....	409
Common Well Construction-PE & TECH & O&M & GP .....	409
Choice of Casing-PE & TECH & O&M & GP .....	413
Concrete Collar-PE & TECH & O&M & GP .....	417
Well Development Section- O&M and TECH .....	419
Well Backwashing-PE & TECH & O&M & GP .....	421
Selecting a Pumping Rate-PE & TECH & O&M & GP .....	423
Changing Well Pump Speed-PE & TECH & O&M & GP .....	431
Well Head Assembly-PE & TECH & O&M & GP .....	433
Post Quiz.....	435
<b>Section 11- ELECTRICAL MOTORS.....</b>	<b>437</b>
Motor Starter.....	441
Two Types of Enclosed Motors-PE & TECH & O&M & GP.....	443
Motor Lubrication- O&M & TECH & SPARK.....	444
Understanding Motors- O&M & TECH & SPARK.....	447
AC Motors- O&M & TECH & SPARK.....	451
DC Motors- O&M & TECH & SPARK.....	443
Rotary Motors- O&M & TECH & SPARK.....	463
Motor Maintenance-PE & TECH & O&M & GP.....	467
Understanding Three Phase- O&M & TECH & SPARK.....	473
Transformers- O&M & TECH & SPARK.....	481
Calculating Voltage- O&M & TECH & SPARK.....	489

Polyphase- O&M & TECH & SPARK.....	497
Electrical Glossary.....	501
Post Quiz.....	505
<b>Section 12- SCADA .....</b>	<b>507</b>
SCADA Explained-SCADA & TECH.....	509
SCADA Concepts-SCADA & TECH .....	511
SCADA Considerations-SCADA & TECH .....	513
SCADA Benefits-SCADA & TECH .....	513
Human Machine Interface Introduction-SCADA & TECH .....	514
Remote Terminal Unit-SCADA & TECH .....	515
Operational Philosophy-SCADA & TECH .....	517
PLC/RTV Programming-SCADA & TECH .....	518
SCADA Architectures-SCADA & TECH .....	519
Community Infrastructures-SCADA & TECH .....	520
SCADA Security Issues-SCADA & TECH .....	521
References.....	524
Post Quiz.....	525
Math Conversion Factors .....	527
Formula/Conversion Table.....	531
Math Review Section.....	535
Production Math Numbering System.....	537
Flow and Velocity.....	539
Metric Math Section.....	543
Temperature.....	545
Complete Math Answers.....	553

### **Hyperlink to the Glossary and Appendix**

*<http://www.abctlc.com/downloads/PDF/PumpGlossary.pdf>*

## Topic Legend

This CEU course covers several educational topics/functions/purposes/objectives of hydraulic and pumping principles including groundwater production, engineering, physics laws, hydraulic theories and pump operation. Educational topic (objectives assessment) categories were determined by Task Analysis and Training Needs Assessments. The topic categories listed below are to assist in determining which educational objective or goal to be covered in a specific topic area:

**CROSS-CONNECTION (CC):** Having to do with cross-connection control and backflow prevention. Simple hydraulic principles. This may be considered O&M training for many operators.

**ELECTRICAL (SPARK):** This section has to do with electrical principles and difficult math calculations. Maybe good for credit for those who hold an electrician or instrumentation certification. This may be considered O&M training for many operators.

**FLUID MECHANICS (FM):** Having to do with hydraulic or fluid mechanics. A highly technical and specialized engineering field. This may be considered O&M training for many operators or credit for pump engineers or well drillers.

**GROUNDWATER MINING OR PRODUCTION (GP):** This may be considered O&M training for many operators or credit for pump engineers or well drillers.

**MOTOR:** Having to do with the electrical-mechanical portion of moving water. This may be considered O&M training for many operators. Maybe good for credit for those who hold an electrician or instrumentation certification.

**OPERATIONS AND MAINTENANCE O&M:** This area is for normal operation and/or maintenance of the distribution system. Part of O&M training requirement for many operators.

**PUMP ENGINEERING (PE):** The technical science of pumping and pump performance principles. May be a law or theory or calculation related to pumping. Information that a pump engineer or well operator may need.

**SCADA:** Having to do with data acquisition and control methods. Remote operation of pumps and motors from a distant location or cell phone. Maybe good for credit for those who hold an electrician or instrumentation certification.

**SCIENCE (SCI):** Having to do with scientific principles, laws or theories. A principle that can be observed or repeated in the Laboratory. May be good for laboratory or engineering credit.

**TECHNICAL (TECH):** The engineering or administrative, mechanical or physical pumping related process/component. The applications, engineering, history or theory that is critical to the pump operation or composition of water (pH). May include advanced groundwater treatment methods or centrifugal pump operation. This may be considered O&M training for many operators or credit for pump engineers or well drillers.

## Section 1 - Physical Science and Related Laws

**Section Focus:** You will learn the basics of hydraulic science, theories, laws and principles. At the end of this section, you will be able to describe scientific laws relating to water and hydraulics. There is a post quiz at the end of this section to review your comprehension and a final examination in the Assignment for your contact hours.

**Scope/Background:** Fluid mechanics (water, hydraulics and hydrodynamics) entails many different scientific laws and theories. At the end of this section, you will describe the properties of water, various laws of physics, examine thermodynamics and friction.

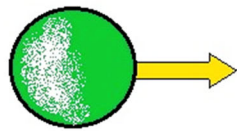

**THE FORCE OF GRAVITY ACTS BETWEEN ALL OBJECTS**

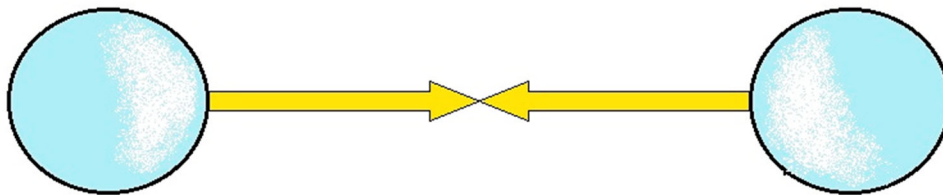
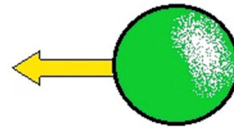

**AS MASS INCREASES, FORCE OF GRAVITY THEN INCREASES**

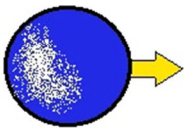

**AS THE DISTANCE INCREASES, FORCE OF GRAVITY THEN DECREASES**

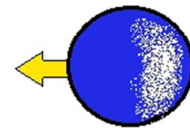

### GRAVITY

**A Natural Phenomenon by which all things with energy are brought towards one another**

Without gravity, water would not flow downhill. The gravity of Earth pulls the water onto the surface of the planet and is responsible for some of the propagation of waves. The gravity of the Moon and Sun pull on Earth's water and are responsible for the tides.

When you put something in water, gravity can pull the object down through the water only if an equal volume of water is allowed to go up against the force of gravity; this is called displacement. In effect gravity has to choose which it will pull down, the water or the immersed object. What we call buoyancy is, in effect, forcing gravity to make this choice.

# Physical Law

## What is a Physical Law?

A **physical law** or **scientific law** is a theoretical statement "inferred from particular facts, applicable to a defined group or class of phenomena, and expressible by the statement that a particular phenomenon always occurs if certain conditions be present."

Physical laws are typically conclusions based on repeated scientific experiments and observations over many years and which have become accepted universally within the scientific community. The production of a summary description of our environment in the form of such laws is a fundamental aim of science. These terms are not used the same way by all authors.

The distinction between natural law in the political-legal sense and law of nature or physical law in the scientific sense is a modern one, both concepts being equally derived from *physis*, the Greek word (translated into Latin as *natura*) for *nature*.

## Physical Law Description

Several general properties of physical laws have been identified.

### Physical laws are:

- True, at least within their regime of validity. By definition, there have never been repeatable contradicting observations.
- Universal. They appear to apply everywhere in the universe.
- Simple. They are typically expressed in terms of a single mathematical equation.
- Absolute. Nothing in the universe appears to affect them.
- Stable. Unchanged since first discovered (although they may have been shown to be approximations of more accurate laws).
- Omnipotent. Everything in the universe apparently must comply with them (according to observations).
- Generally conservative of quantity.
- Often expressions of existing homogeneities (symmetries) of space and time.
- Typically, theoretically reversible in time (if non-quantum), although time itself is irreversible.

## Physical Science Key Terms

### **Bernoulli's Principle**

In fluid dynamics, Bernoulli's principle states that an increase in the speed of a fluid occurs simultaneously with a decrease in pressure or a decrease in the fluid's potential energy. The principle is named after Daniel Bernoulli who published it in his book *Hydrodynamica* in 1738.

### **Continuum Assumption**

The continuum assumption is the assumption that a fluid is composed of a continuous material so that properties such as density, pressure, temperature, and velocity are well-defined at "infinitely" small points; that is, we can take the limit as volume goes to zero.

### **Force**

In physics, a **force** is any interaction that, when unopposed, will change the motion of an object. A force can cause an object with mass to change its velocity (which includes to begin moving from a state of rest), i.e., to accelerate. Force can also be described intuitively as a push or a pull. A force has both magnitude and direction, making it a vector quantity. It is measured in the SI unit of newtons and represented by the symbol **F**.

### **Gravity**

The force that attracts a body toward the center of the earth, or toward any other physical body having mass. For most purposes Newton's laws of gravity apply, with minor modifications to take the general theory of relativity into account.

### **Inertia**

Inertia is the resistance of any physical object to any change in its state of motion (this includes changes to its speed, direction or state of rest). It is the tendency of objects to keep moving in a straight line at constant velocity.

### **Laws of Thermodynamics**

The four laws of thermodynamics define fundamental physical quantities (temperature, energy, and entropy) that characterize thermodynamic systems. The laws describe how these quantities behave under various circumstances, and forbid certain phenomena (such as perpetual motion).

### **Mass**

Mass is both a property of a physical body and a measure of its resistance to acceleration (a change in its state of motion) when a net force is applied. It also determines the strength of its mutual gravitational attraction to other bodies. The basic SI unit of mass is the kilogram (kg). In physics, mass is not the same as weight, even though mass is often determined by measuring the object's weight using a spring scale, rather than balance scale comparing it directly with known masses.

### **Newton's Laws**

Newton's laws of motion are three physical **laws** that, together, laid the foundation for classical mechanics. They describe the relationship between a body and the forces acting upon it, and its motion in response to those forces.

## Pascal's Law

Pascal's law or the principle of transmission of fluid-pressure (also Pascal's Principle) is a principle in fluid mechanics that states that pressure exerted anywhere in a confined incompressible fluid is transmitted equally in all directions throughout the fluid such that the pressure variations (initial differences) remain the same. The law was established by French mathematician Blaise Pascal.

## Physical Law

A physical law or scientific law "is a theoretical statement inferred from particular facts, applicable to a defined group or class of phenomena, and expressible by the statement that a particular phenomenon always occurs if certain conditions be present."

## Science

Science (from Latin *scientia*, meaning "knowledge") is a systematic enterprise that builds and organizes knowledge in the form of testable explanations and predictions about the universe.

## Static Pressure

In fluid mechanics, the term static pressure has several uses: In the design and operation of aircraft, static pressure is the air pressure in the aircraft's static pressure system. In fluid dynamics, many authors use the term static pressure in preference to just pressure to avoid ambiguity.

Often however, the word 'static' may be dropped and in that usage pressure is the same as static pressure at a nominated point in a fluid. The term static pressure is also used by some authors in fluid statics.

## Three Laws of Motion

Newton's **laws of motion** are **three physical laws** that directly relate the forces acting on a body to the **motion** of the body. The first **law** states that every object in a state of uniform **motion** tends to remain in that state of **motion** unless an external force is applied to it.

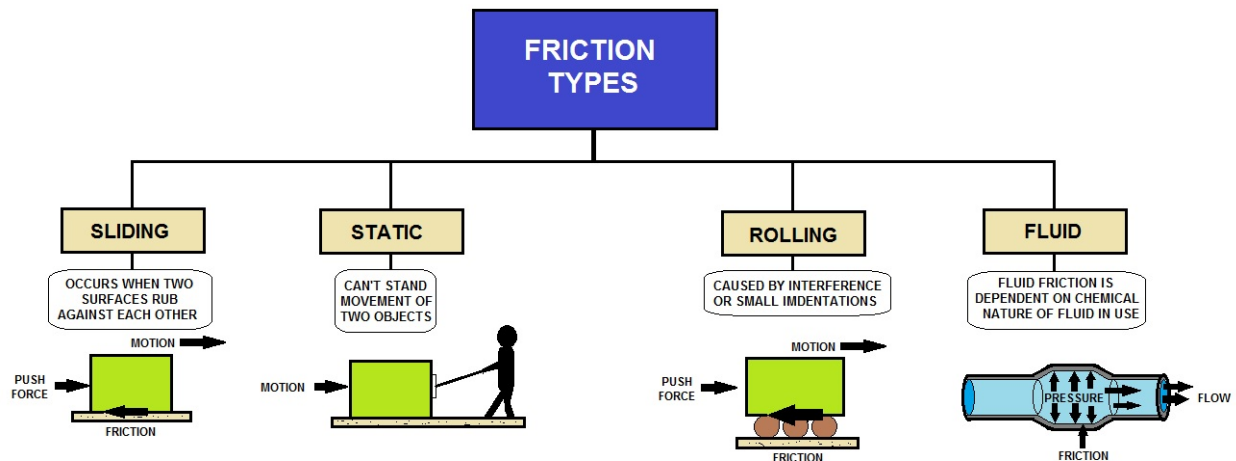

FRICTION TYPE EXAMPLES





## Physical Science and Related Laws - Introduction

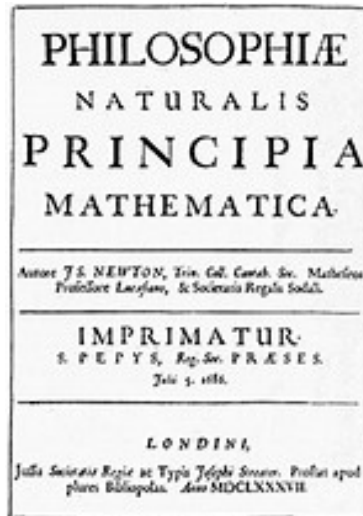

### Newton's Laws

Sir Isaac Newton's groundbreaking work in physics was first published in 1687 in his book "The Mathematical Principles of Natural Philosophy," generally known as the *Principia*. In it, he outlined theories about gravity and of motion.

Newton's physical law of gravity states that an object attracts another object in direct proportion to their combined mass and inversely related to the square of the distance between them.

Newton developed the theories of gravitation in 1666, when he was only 23 years old. Some twenty years later, in 1686, he exhibited his three laws of motion in the "Principia Mathematica Philosophiæ Naturalis."

Newton's first law states that every object will remain at rest or in uniform motion in a straight line unless compelled to change its state by the action of an external force. This is normally taken as the definition of **inertia**.

The key point here is that if there is **no net force** acting on an object (if all the external forces cancel each other out) then the object will maintain a **constant velocity**. If that velocity is zero, then the object remains at rest.

If an external force is applied, the velocity will change because of the force.

The second law explains how the velocity of an object changes when it is subjected to an external force.

The law defines a **force** to be equal to change in **momentum** (mass times velocity) per change in time.

Newton also established the calculus of mathematics, and the "changes" expressed in the second law are most accurately defined in differential forms. (Calculus can also be used to determine the velocity and location variations experienced by an object subjected to an external force.)

For an object with a constant mass **m**, the second law states that the force **F** is the product of an object's mass and its acceleration **a**:

$$F = m * a$$

For an external applied force, the change in velocity depends on the mass of the object. A force will cause a change in velocity; and likewise, a change in velocity will generate a force. The equation works both ways.

The third law states that for every action (force) in nature there is an equal and opposite reaction. In other words, if object A exerts a force on object B, then object B also exerts an equal force on object A.

Notice that the forces are exerted on different objects. The third law can be used to explain the production of lift by a wing and the generation of thrust by a jet engine.

$\text{PRESSURE} = \frac{\text{FORCE}}{\text{AREA}}$
$\text{AREA} = \frac{\text{FORCE}}{\text{PRESSURE}}$
$\text{FORCE} = \text{AREA} \times \text{PRESSURE}$

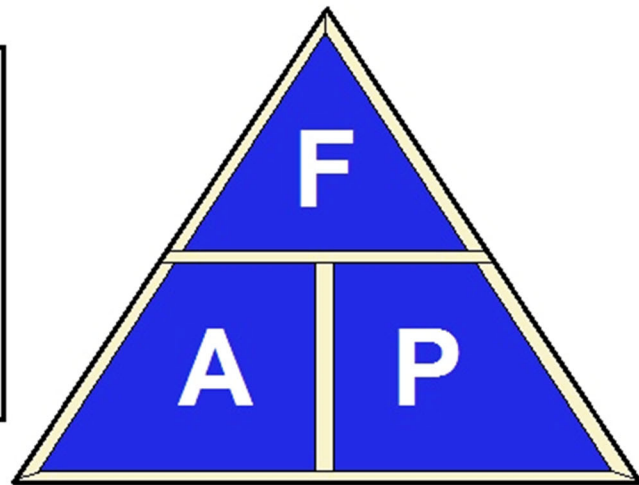

## FORMULAS TO CALCULATE FORCE, AREA & PRESSURE



## Force

In physics, a **force** is any interaction that, when unopposed, will change the motion of an object. A force can cause an object with mass to change its velocity (which includes to begin moving from a state of rest), i.e., to accelerate.

Force can also be described intuitively as a push or a pull. A force has both magnitude and direction, making it a vector quantity. It is measured in the SI unit of newtons and represented by the symbol **F**.

The prototype form of Newton's second law states that the net force acting upon an object is equal to the rate at which its momentum changes with time.

If the mass of the object is constant, this law implies that the acceleration of an object is directly proportional to the net force acting on the object, is in the direction of the net force, and is inversely proportional to the mass of the object

Concepts related to force include: thrust, which increases the velocity of an object; drag, which decreases the velocity of an object; and torque, which produces changes in rotational speed of an object. In an extended body, each part usually applies forces on the adjacent parts; the distribution of such forces through the body is the internal mechanical stress.

Such internal mechanical stresses cause no acceleration of that body as the forces balance one another.

Pressure, the distribution of many small forces applied over an area of a body, is a simple type of stress that if unbalanced can cause the body to accelerate. Stress usually causes deformation of solid materials, or flow in fluids.

## Gravity

The force that attracts a body toward the center of the earth, or toward any other physical body having mass. For most purposes, Newton's laws of gravity will apply, along with minor alterations to taking the General Theory of Relativity into account.

Gravity is one of the four forces of nature. The strength of the gravitational force between two objects depends on their masses.

The more immense or massive the objects are, the stronger the gravitational attraction. When you pour water out of a bucket, the earth's gravity pulls the water towards the ground. The same thing happens when you put two containers of water, with a tube between them, at two different heights. You must work to start the flow of water from one bucket to the other, but then gravity takes over and the process will continue on its own.

Gravity, applied forces, and atmospheric pressure are static factors that apply equally to fluids at rest or in motion, while inertia and friction are dynamic factors that apply only to fluids in motion.

The mathematical sum of gravity, applied force, and atmospheric pressure is the static pressure obtained at any one point in a fluid at any given time.

## Fundamental Interactions

Fundamental interactions, also known as fundamental forces, are the interactions in physical systems that do not appear to be reducible to more basic interactions. There are four conventionally accepted fundamental interactions—gravitational, electromagnetic, strong nuclear, and weak nuclear. Each one is understood as the dynamics of a field.

## Inertia

Inertia is the resistance of any physical object to any change in its state of motion (this includes changes to its speed, direction or state of rest). It is the tendency of objects to keep moving in a straight line at constant velocity.

## Mass

Mass is both a property of a physical body and a measure of its resistance to acceleration (a change in its state of motion) when a net force is applied. It also determines the strength of its mutual gravitational attraction to other bodies. The basic SI unit of mass is the kilogram (kg).

In physics, mass is not the same as weight, even though mass is often determined by measuring the object's weight using a spring scale, rather than balance scale comparing it directly with known masses.

An object on the Moon would weigh less than it does on Earth because of the lower gravity, but it would still have the same mass. This is because weight is a force, while mass is the property that (along with gravity) determines the strength of this force.

In Newtonian physics, mass can be generalized as the amount of matter in an object. However, at very high speeds, special relativity states that the kinetic energy of its motion becomes a significant additional source of mass.

Therefore, any stationary body having mass has an equivalent amount of energy, and all forms of energy resist acceleration by a force and have gravitational attraction. In modern physics, matter is not a fundamental concept because its definition has proven elusive.

There are several distinct experiences which can be used to measure mass. Although some theorists have speculated that some of these experiences could be independent of each other, current experiments have found no difference in results regardless of how it is measured:

- *Inertial mass* measures an object's resistance to being accelerated by a force (represented by the relationship  $F = ma$ ).
- *Active gravitational mass* measures the gravitational force exerted by an object.
- *Passive gravitational mass* measures the gravitational force exerted on an object in a known gravitational field.

The mass of an object determines its acceleration in the presence of an applied force.

The inertia and the inertial mass describe the same properties of physical bodies at the qualitative and quantitative level respectively, by other words, the mass quantitatively describes the inertia. According to Newton's second law of motion, if a body of fixed mass  $m$  is subjected to a single force  $F$ , its acceleration  $a$  is given by  $F/m$ .

A body's mass also determines the degree to which it generates or is affected by a gravitational field.

If a first body of mass  $m_A$  is placed at a distance  $r$  (center of mass to center of mass) from a second body of mass  $m_B$ , each body is subject to an attractive force  $F_g = Gm_A m_B / r^2$ , where  $G = 6.67 \times 10^{-11} \text{ N kg}^{-2} \text{ m}^2$  is the "universal gravitational constant".

This at times is referred to as gravitational mass. Repeated experiments since the 17th century have demonstrated that inertial and gravitational mass are identical; since 1915, this observation has been entailed *a priori* in the equivalence principle of general relativity.

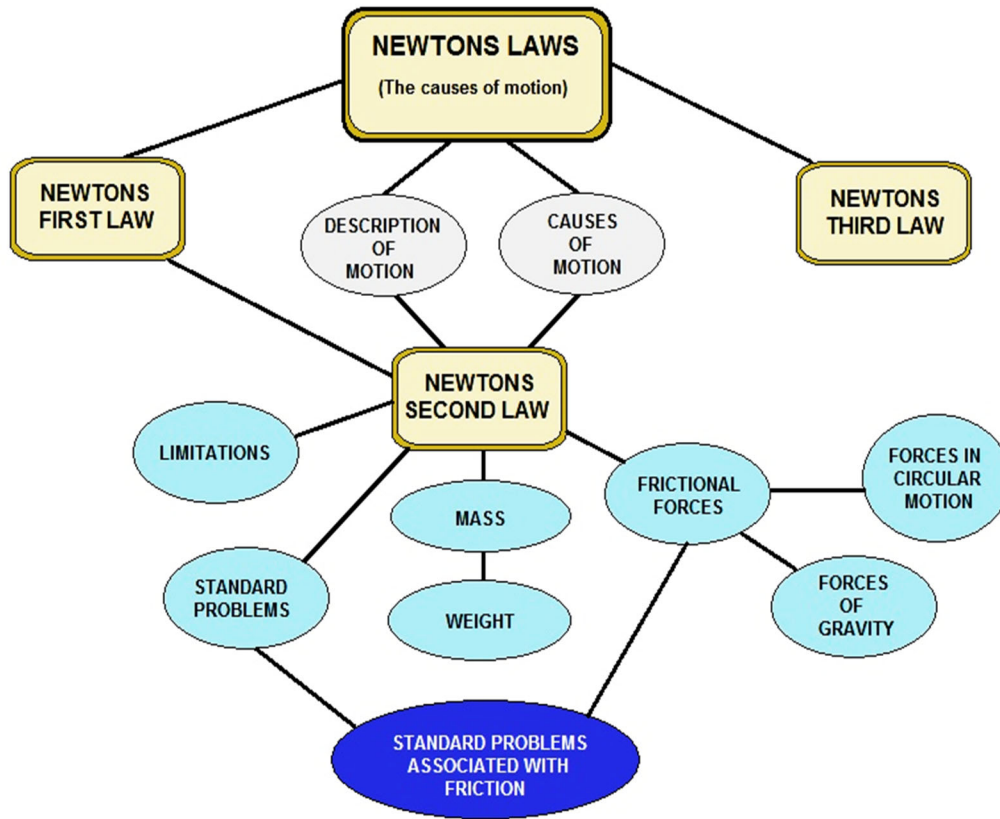

<b>FIRST LAW:</b>	Objects at rest remain at rest and objects in motion in a straight line unless acted upon by an unbalanced force.
<b>SECOND LAW:</b>	Forces equal mass times acceleration ( $f = ma$ ).
<b>THIRD LAW:</b>	For every action, there is an equal and opposite reaction

## NEWTON'S THREE LAWS OF MOTION

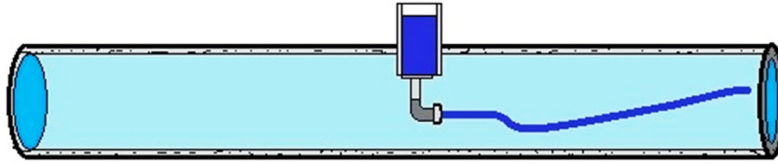

**LAMINAR FLOW**  
- PREDICTABLE, SLOW MIXING

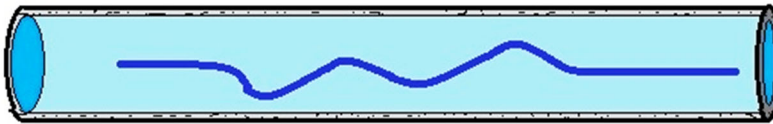

**TRANSITIONAL**  
- TURBULENT OUTBURSTS

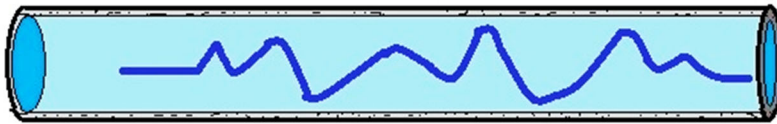

**TURBULENT FLOW**  
- UNPREDICTABLE, RAPID MIXING

## FLOW CHARACTERISTICS IN PIPING



## Technical Understanding

**In the absence of forces**, ("body") at rest will stay at rest, and a body **moving at a constant velocity in a straight line** continues doing so indefinitely.

**When a force is applied to an object, it accelerates.** The acceleration  $a$  is in the direction of the force and proportional to its strength, and is also inversely proportional to the mass being moved. In suitable units:

$$a = F/m$$

or in the form usually found in textbooks

$$F = m a$$

More accurately, one should write

$$\mathbf{F} = m \mathbf{a}$$

with both  $\mathbf{F}$  and  $\mathbf{a}$  vectors in the same direction (denoted here in bold face). However, when only a single direction is understood, the simpler form can also be used.

"The law of reaction," sometimes stated as "to every action there exists an equal and opposite reaction." In more explicit terms:

**Forces are always produced in pairs, with opposite directions and equal magnitudes.** If body #1 acts with a force  $F$  on body #2, then body #2 acts on body #1 with a force of equal strength and opposite direction.

## The Hypothesis of Force

As a functioning definition, "force" is that which **causes or changes motion**.

One force everyone is familiar with is the **weight** of objects, the force which tries to make them move downwards, to fall towards the center of the Earth.

We may therefore measure force (at least now, temporarily) in kilograms of weight, and view as force anything that can be matched by weight.

For instance, a **spiral spring** can be compressed or stretched by weight, so it is reasonable to say that it, too, exerts a force when compressed or stretched.

Based on hindsight--on experience with forces noted by many people, including Newton--we may distinguish **two basic situations** in which force creates motion:

1. The force moves an object **overcoming** external resistance.
2. The force moves an object against **negligible** external resistance.

### Motion against Outside Resistance

This kind of motion will be covered later, in connection with the concept of "**work**."

### Examples include:

- --Lifting a book from the floor to the table (the force produced by the hand doing the lifting must overcome the downward pull of gravity)
- --Dragging a table across the room (the pull of your hand must overcome the friction of the floor),
- --An airliner flying at 600 mph (the thrust of its engines overcomes air resistance)

The **speed of the motion** does not enter here, so in principle it can even cover the case when the opposing force **completely balances** the applied one, resulting in **no motion at all**:

- --A table stands on the floor, without moving. The downward force of the weight of the table encounters resistance by the floor, which does not allow it to move any further downwards. The downward velocity is zero and the forces are balanced or "**in equilibrium.**"

### Motions without Significant Resistance

It was Sir Isaac Newton's insight that in the absence of external resistance, motions in a straight line and at constant speed would continue indefinitely. **No force is necessary.** That is **Newton's first law of motion**:

" In the absence of external forces, motion in a straight line and at constant speed continues indefinitely. "

A smooth rock sliding on a sheet of ice can travel great distances, and the smoother the ice, the further it goes. Newton realized that what ultimately stopped such motions was the **friction** of the surface. If an ideally smooth ice could be produced, with no friction at all and extending to unlimited distances, the rock would continue indefinitely, never stopping, in the same direction and with the same velocity as the ones with which it had started.

**What a force can do** in the absence of resistance is **increase the velocity of an object - accelerate it.**

Nevertheless, even without external resistance, there remains an **internal resistance, by the object itself.**

An astronaut pushing a one-ton satellite out of the cargo bay of the space shuttle quickly finds that even though the satellite seems "weightless," it is not easily moved. Given a push by the astronaut, it will indeed start to move, but **very slowly.** It resists being put in motion, and once moving, it resists just as much being slowed down or stopped.

People were quite familiar with the docking of ships and large boats. A heavy boat acts very much like a "weightless" satellite: the water supports its weight, but offers very little resistance to slow motion. And there too, when such a boat is pushed away from the dock, it starts moving very gradually: but once it is moving, it is just as hard to stop.) Newton named that internal resistance **inertia.**

Clearly, inertia increases with the amount of matter. A bowling ball is harder to get moving and harder to stop than a hollow rubber ball of the same size. The bowling ball is also **heavier**, that is, it is pulled downward with greater force: but weight is an effect of gravity, while inertia is not.



## Three Laws of Motion Review

Newton's three laws of motion, also found in the *Principia*, govern how the motion of physical objects change. They define the fundamental relationship between the acceleration of an object and the forces acting upon it.

- **First rule:** An object will remain at rest or in a uniform state of motion unless that state is changed by an external force.
- **Second rule:** Force is equal to the change in momentum (mass times velocity) over time. In other words, the rate of change is directly proportional to the amount of force applied.
- **Third rule:** For every action in nature there is an equal and opposite reaction.

Jointly, these three principles in which Newton outlined form the basis of classical mechanics, describes how bodies behave physically under the influence of outside forces.

## Conservation of Mass and Energy

Albert Einstein introduced his famous equation  $E = mc^2$  in 1905 journal submission titled, "On the Electrodynamics of Moving Bodies." The paper presented his theory of special relativity, based on two postulates:

- **Principle of relativity:** The laws of physics are the same for all inertial reference frames.
- **Principle of constancy of the speed of light:** Light always propagates through a vacuum at a definite velocity, which is independent of the state of motion of the emitting body.

The first principle describes that the laws of physics apply equally to everyone in all situations. The second principle is the more important one. It stipulates that the speed of light in a vacuum is constant. Unlike all other forms of motion, it is not measured differently for observers in different inertial frames of reference.

## Laws of Thermodynamics

The four laws of thermodynamics define basic physical quantities (temperature, energy, and entropy) that characterize thermodynamic systems. The laws define how these quantities behave under various circumstances, and forbid certain phenomena (such as perpetual motion).

The laws of thermodynamics are actually specific manifestations of the law of conservation of mass-energy as it relates to thermodynamic processes. The field was first explored in the 1650s by Otto von Guericke in Germany and Robert Boyle and Robert Hooke in Britain.

All three scientists used vacuum pumps, which von Guericke pioneered, to study the principles of pressure, temperature, and volume.

- **The zeroeth law of thermodynamics** makes the notion of temperature possible.
- **The first law of thermodynamics** demonstrates the relationship between internal energy, added heat, and work within a system.
- **The second law of thermodynamics** relates to the natural flow of heat within a closed system.
- **The third law of thermodynamics** states that it is impossible to create a thermodynamic process that is perfectly efficient.

## ***Thermodynamics Defined***

Thermodynamics is a division of physics concerned with heat and temperature and their relation to energy and work. The performance of these quantities is governed by the four laws of thermodynamics, irrespective of the composition or specific properties of the material or system in question.

The laws of thermodynamics are explained in terms of microscopic elements by statistical mechanics. Thermodynamics applies to a wide variety of topics in science and engineering, especially physical chemistry, chemical engineering and mechanical engineering.

Thermodynamic research developed out of a desire to increase the efficiency of early steam engines, particularly through the work of French physicist Nicolas Léonard Sadi Carnot (1824) who believed that engine efficiency was the key that could help France win the Napoleonic Wars.

Scottish physicist Lord Kelvin was the first to formulate a concise definition of thermodynamics in 1854 which stated, "*Thermo-dynamics is the subject of the relation of heat to forces acting between contiguous parts of bodies, and the relation of heat to electrical agency.*"

Chemical thermodynamics studies the nature of the role of entropy in the process of chemical reactions and has provided the bulk of expansion and knowledge of the field. The initial application of thermodynamics to mechanical heat engines was extended early on to the study of chemical compounds and chemical reactions.

Other formulations of thermodynamics emerged in the following decades. Statistical thermodynamics, or statistical mechanics, concerned itself with statistical predictions of the collective motion of particles from their microscopic behavior.

In 1909, Constantin Carathéodory presented a purely mathematical approach to the field in his axiomatic formulation of thermodynamics, a description often referred to as *geometrical thermodynamics*.

## More on the Law of Thermodynamics

The four laws of thermodynamics define fundamental physical quantities (temperature, energy, and entropy) that characterize thermodynamic systems at thermal equilibrium.

The laws describe how these quantities behave under various circumstances, and forbid certain phenomena (such as perpetual motion).

### The four laws of thermodynamics are

- Zeroth law of thermodynamics: If two systems are in thermal equilibrium with a third system, they are in thermal equilibrium with each other. This law helps define the concept of temperature.
- First law of thermodynamics: When energy passes, as work, as heat, or with matter, into or out from a system, the system's internal energy changes in accord with the law of conservation of energy. Equivalently, perpetual motion machines of the first kind (machines that produce work with no energy input) are impossible.
- Second law of thermodynamics: In a natural thermodynamic process, the sum of the entropies of the interacting thermodynamic systems increases. Equivalently, perpetual motion machines of the second kind (machines that spontaneously convert thermal energy into mechanical work) are impossible.
- Third law of thermodynamics: The entropy of a system approaches a constant value as the temperature approaches absolute zero. With the exception of non-crystalline solids (glasses) the entropy of a system at absolute zero is typically close to zero, and is equal to the natural logarithm of the product of the quantum ground states.

The laws of thermodynamics are important fundamental laws in physics and they are applicable in other natural sciences.

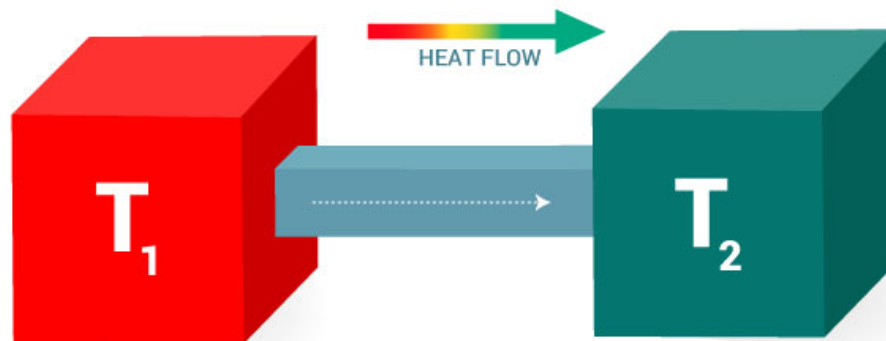

## More on Energy Conservation

The first law of thermodynamics asserts that energy must be conserved in any process involving the exchange of heat and work between a system and its surroundings. A machine that violated the first law would be called a perpetual motion machine of the first kind because it would manufacture its own energy out of nothing and thereby run forever. Such a machine would be impossible even in theory. However, this impossibility would not prevent the construction of a machine that could extract essentially limitless amounts of heat from its surroundings (earth, air, and sea) and convert it entirely into work. Although such a hypothetical machine would not violate conservation of energy, the total failure of inventors to build such a machine, known as a perpetual motion machine of the second kind, led to the discovery of the second law of thermodynamics. The second law of thermodynamics can be precisely stated in the following two forms, as originally formulated in the 19th century by the Scottish physicist William Thomson (Lord Kelvin) and the German physicist Rudolf Clausius, respectively:

*A cyclic transformation whose only final result is to transform heat extracted from a source which is at the same temperature throughout into work is impossible.*

*A cyclic transformation whose only final result is to transfer heat from a body at a given temperature to a body at a higher temperature is impossible.*

The two statements are in fact equivalent because, if the first were possible, then the work obtained could be used, for example, to generate electricity that could then be discharged through an electric heater installed in a body at a higher temperature. The net effect would be a flow of heat from a lower temperature to a higher temperature, thereby violating the second (Clausius) form of the second law. Conversely, if the second form were possible, then the heat transferred to the higher temperature could be used to run a heat engine that would convert part of the heat into work. The final result would be a conversion of heat into work at constant temperature—a violation of the first (Kelvin) form of the second law.

## Assumptions

### RATE OF PROPERTY CHANGE, "N" FOR A SYSTEM

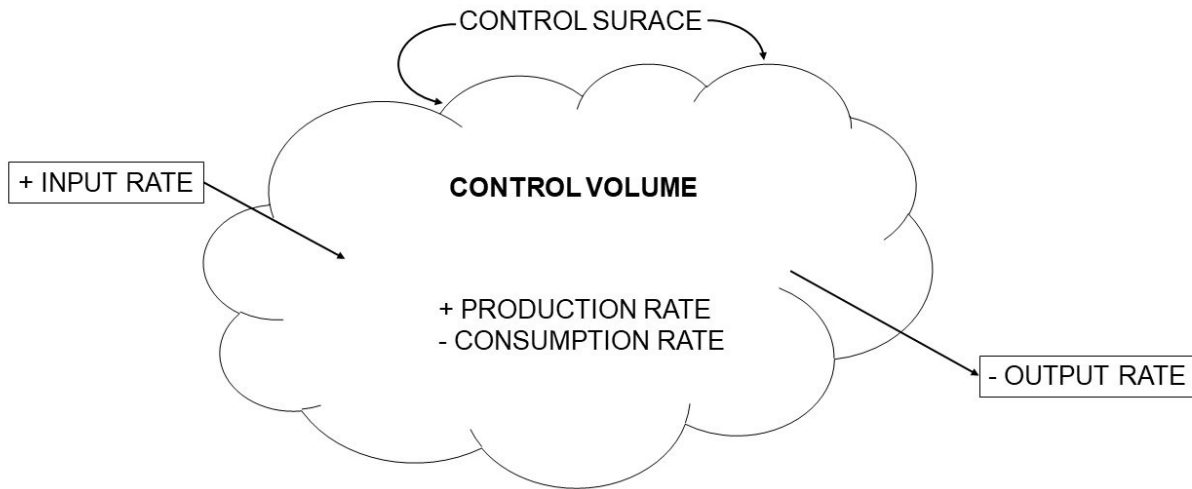

## INTEGRATED FLUID QUANTITY BALANCE

Equilibrium for some integrated fluid quantity in a control volume enclosed by a control surface.

The assumptions inherent to a fluid mechanical treatment of a physical system can be expressed in terms of mathematical equations. Basically, every fluid mechanical system is assumed to obey:

- Conservation of mass
- Conservation of energy
- Conservation of momentum
- The continuum assumption

For example, the assumption that mass is conserved means that for any fixed control volume (for example, a spherical volume) – enclosed by a control surface – the rate of change of the mass contained in that volume is equal to the rate at which mass is passing through the surface from *outside* to *inside*, minus the rate at which mass is passing from *inside* to *outside*. This can be expressed as an equation in integral form over the control volume.

### Continuum Assumption

The continuum assumption is an invention of continuum mechanics under which fluids can be treated as continuous, even though, on a microscopic scale, they are composed of molecules.

Under the continuum assumption, macroscopic (observed/measurable) properties such as density, pressure, temperature, and bulk velocity are taken to be well-defined at "infinitesimal" volume elements -- small in comparison to the characteristic length scale of the system, but large in comparison to molecular length scale.

Fluid properties can vary continuously from one volume element to another and are average values of the molecular properties. The continuum hypothesis can lead to inaccurate results in applications like supersonic speed flows, or molecular flows on nano scale. Those problems for which the continuum hypothesis fails, can be solved using statistical mechanics.

## Knudsen Number

To determine whether or not the continuum hypothesis relates, the Knudsen number, defined as the ratio of the molecular mean free path to the characteristic length scale, is evaluated. Problems with Knudsen numbers below 0.1 can be evaluated using the continuum hypothesis, but molecular approach (statistical mechanics) can be applied for all ranges of Knudsen numbers. You can find more on this subject in the glossary.

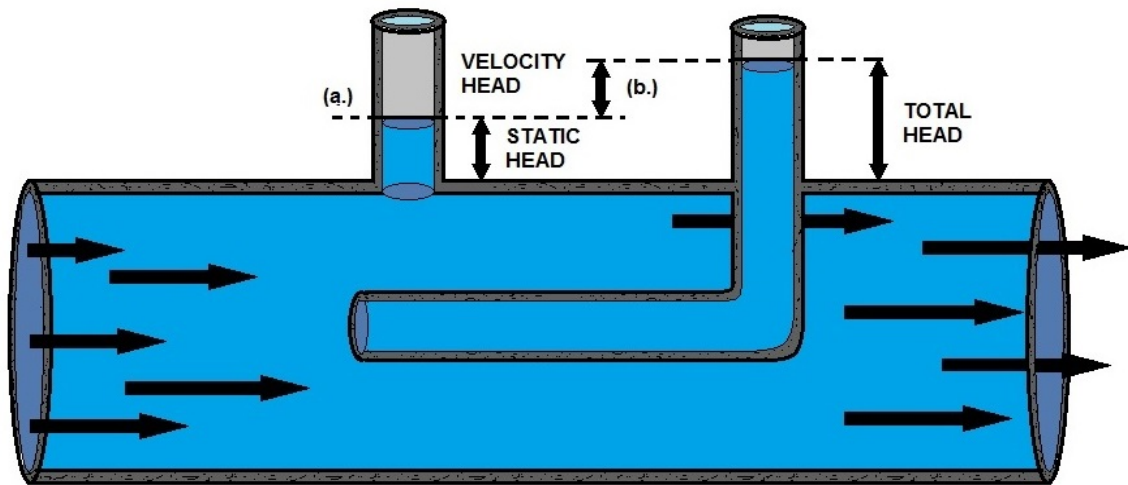

**MEASURING STATIC HEAD (a) AND TOTAL HEAD (b) OF WATER THROUGH A PIPE**

## Pascal's Law- Introduction

The groundwork of modern hydraulics was established when Pascal discovered that pressure in a fluid acts equally in all directions. This pressure acts at right angles to the containing surfaces.

If some type of pressure gauge, with an exposed face, is placed beneath the surface of a liquid at a specific depth and pointed in different directions, the pressure will read the same. Therefore, we can say that pressure in a liquid is independent of direction.

Pressure due to the weight of a liquid, at any level, depends on the depth of the fluid from the surface. If the exposed face of the pressure gauges is moved closer to the surface of the liquid, the indicated pressure will be less.

When the depth is doubled, the indicated pressure is doubled. Thus the pressure in a liquid is directly proportional to the depth.

Consider a container with vertical sides that is 1-foot-long and 1 foot wide. Let it be filled with water 1-foot-deep, providing 1 cubic foot of water.

1 cubic foot of water weighs 62.4 pounds. Using this information and equation,  $P = F/A$ , we can calculate the pressure on the bottom of the container.

Since there are 144 square inches in 1 square foot, this can be stated as follows: the weight of a column of water 1-foot-high, having a cross-sectional area of 1 square inch, is 0.433 pound.

If the depth of the column is tripled, the weight of the column will be  $3 \times 0.433$ , or 1.299 pounds, and the pressure at the bottom will be  $1.299 \text{ lb/in}^2$  (psi), since pressure equals the force divided by the area.

Therefore, the pressure at any depth in a liquid is equal to the weight of the column of liquid at that depth divided by the cross-sectional area of the column at that depth.

The volume of a liquid that produces the pressure is referred to as the fluid head of the liquid.

The pressure of a liquid due to its fluid head is also dependent on the density of the liquid.

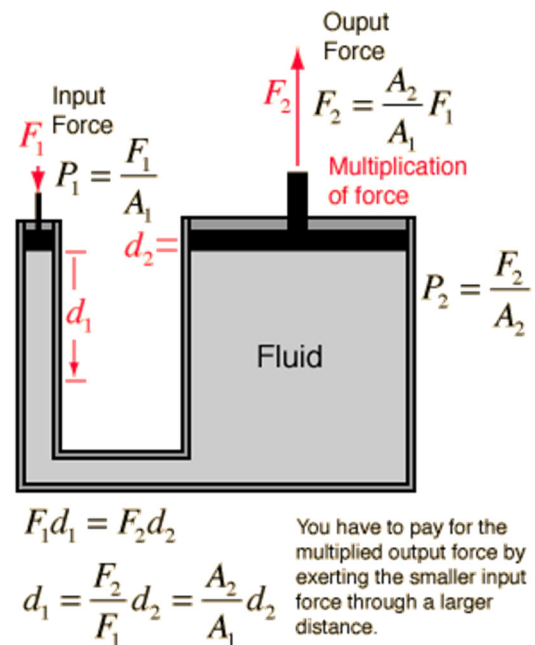

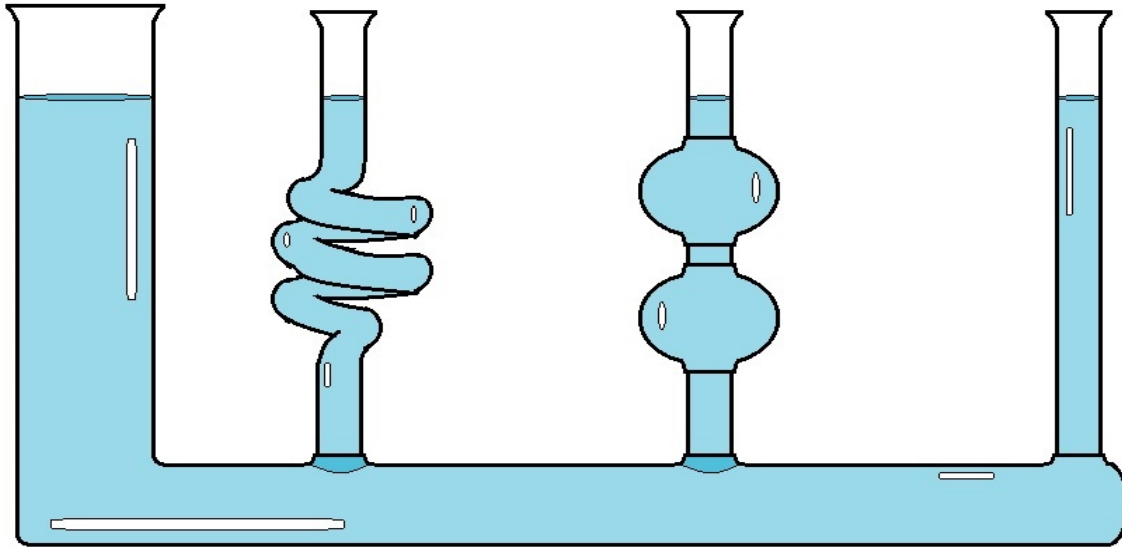

### PRESSURE IN LIQUIDS

PASCAL'S VASES DEMONSTRATE THE FACT THAT THE PRESSURE OF THE LIQUID DEPENDS SOLELY ON THE DEPTH ALONE, AND NOT THE VOLUME OR THE SHAPE OF THE FLUID

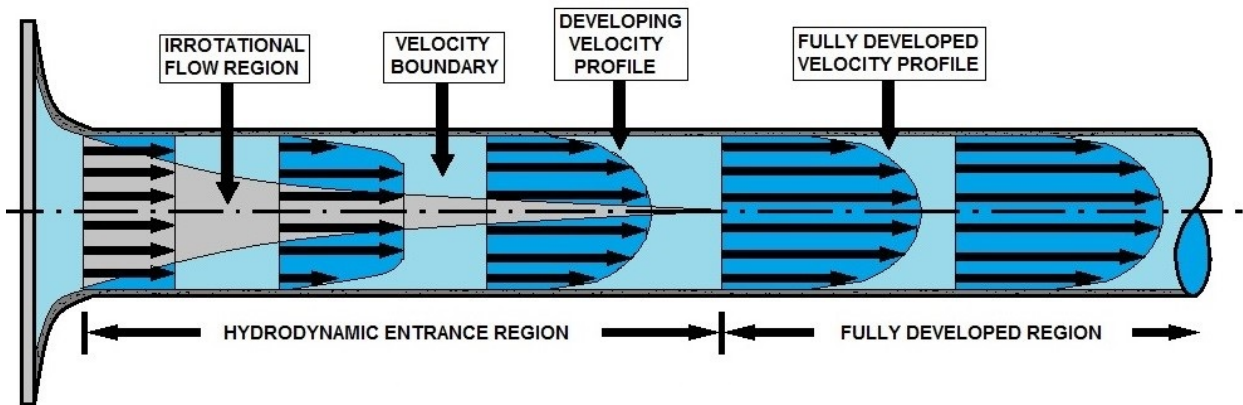

### BREAKDOWN OF WATER'S ACTION IN A PIPE



## Static Pressure

***We will cover these areas in detail in another section.***

Static pressure exists in addition to any dynamic factors that may also be present at the same time. Pascal's law states that a pressure set up in a fluid acts equally in all directions and at right angles to the containing surfaces. This will cover the situation only for fluids at rest or practically at rest. It is true only for the factors making up static head.

Clearly, when velocity becomes a factor it must have a direction, and as previously explained, the force related to the velocity must also have a direction, so that Pascal's law alone does not apply to the dynamic factors of fluid power.

The dynamic factors of inertia and friction are related to the static factors.

Velocity head and friction head are obtained at the expense of static head. Nevertheless, a portion of the velocity head can always be reconverted to static head.

Force, which can be produced by pressure or head when dealing with fluids, is necessary to start a body moving if it is at rest, and is present in some form when the motion of the body is arrested; thus, whenever a fluid is given velocity, some part of its original static head is used to impart this velocity, which then exists as velocity head.

***Static Head = Pressure*** resulting from the ***Weight of Liquid;***

- Acting on internal of the vessel
- Higher Liquid Height → Greater The Pressure

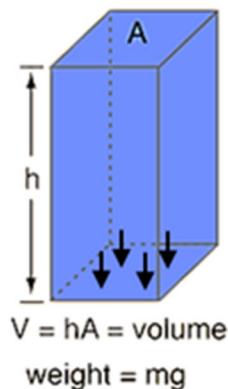

Static fluid pressure does not depend on the shape, total mass, or surface area of the liquid.

$$\text{Pressure} = \frac{\text{weight}}{\text{area}} = \frac{mg}{A} = \frac{\rho Vg}{A} = \rho gh$$

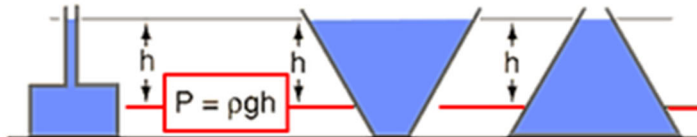

## Volume and Velocity of Flow

The volume of a liquid passing a point in a given time is known as its *volume of flow* or flow rate.

The volume of flow is usually expressed in gallons per minute (gpm) and is associated with relative pressures of the liquid, such as 5 gpm at 40 psi.

The *velocity of flow* or velocity of the fluid is defined as the average speed at which the fluid moves past a given point. It is usually expressed in feet per second (fps) or feet per minute (fpm).

Velocity of flow is an important consideration in sizing the hydraulic lines.

Volume and velocity of flow are often considered together. With other conditions unaltered—that is, with volume of input unchanged—the velocity of flow increases as the cross section or size of the pipe decreases, and the velocity of flow decreases as the cross section increases.

For example, the velocity of flow is slow at wide parts of a stream and rapid at narrow parts, yet the volume of water passing each part of the stream is the same.

$$Q = AV$$

Where: Q = Quantity of flow in *cubic feet per minute*  
A = Cross sectional area of duct in *square feet*  
V = Average velocity in *feet per minute*

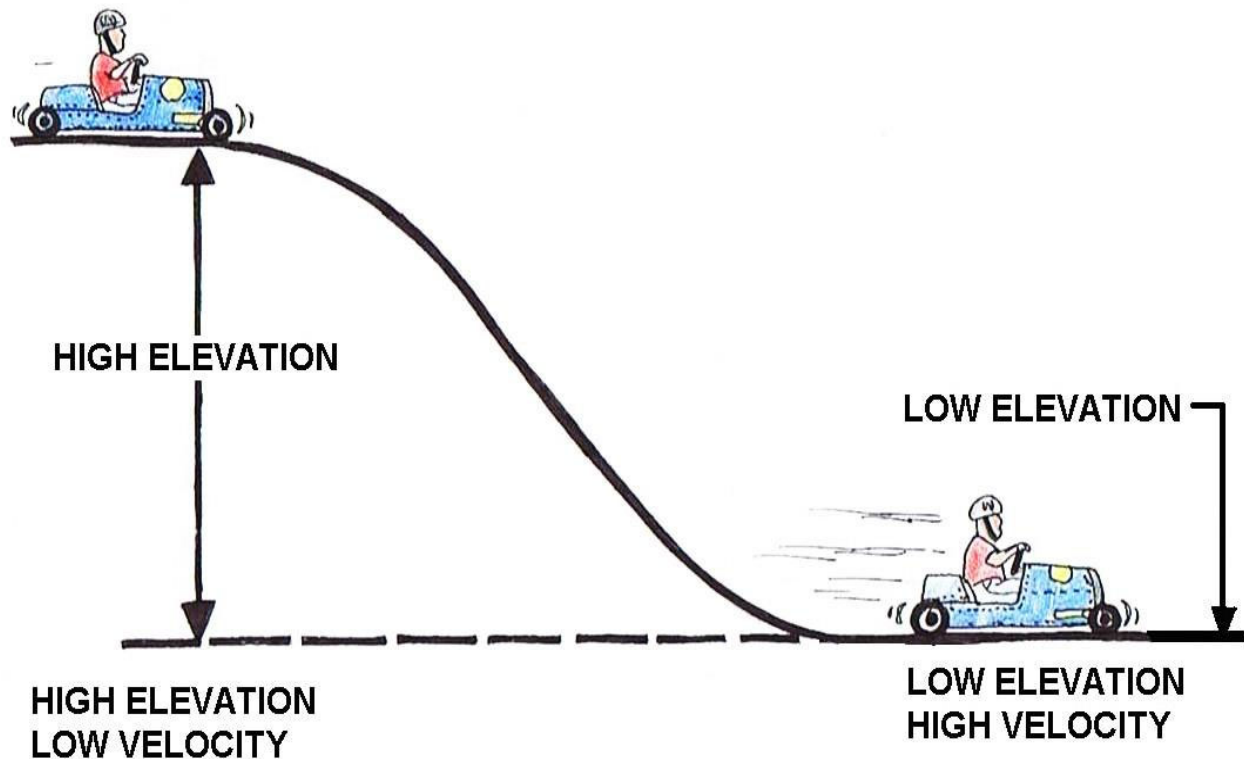

## Understanding the Venturi

It is difficult to understand the reason low pressure occurs in the small diameter area of the venturi. The following explanation may seem to help the principle.

It is clear that all the flow must pass from the larger section to the smaller section. Or in other words, the flow rate will remain the same in the large and small portions of the tube. The flow rate is the same rate, but the velocity changes.

The velocity is greater in the small portion of the tube. There is a relationship between the pressure energy and the velocity energy; if velocity increases the pressure energy must decrease.

This is known as the principle of conservation of energy at work which is also Bernoulli's law. This is similar to the soapbox derby car in the illustration at the top of a hill. At the top or point, the elevation of the soapbox derby car is high and the velocity low.

At the bottom the elevation is low and the velocity is high, elevation (potential) energy has been converted to velocity (kinetic) energy.

Pressure and velocity energies behave in the same way. In the large part of the pipe the pressure is high and velocity is low, in the small part, pressure is low and velocity high.

## Bernoulli's Principle

Bernoulli's principle thus says that a rise (fall) in pressure in a flowing fluid must always be accompanied by a decrease (increase) in the speed, and conversely, if an increase (decrease) in, the speed of the fluid results in a decrease (increase) in the pressure.

This is at the heart of a number of everyday phenomena. As an example, Bernoulli's principle is responsible for the fact that a shower curtain gets "**sucked inwards**" when the water is first turned on. What happens is that the increased water/air velocity inside the curtain (relative to the still air on the other side) causes a pressure drop.

The pressure difference between the outside and inside causes a net force on the shower curtain which sucks it inward.

A practical example is provided by the functioning of a perfume bottle: squeezing the bulb over the fluid creates a low pressure area due to the higher speed of the air, which subsequently draws the fluid up. This is illustrated in the following figure.

Bernoulli's principle also tells us why windows tend to explode, rather than implode in hurricanes: the very high speed of the air just outside the window causes the pressure just outside to be much less than the pressure inside, where the air is still.

The difference in force pushes the windows outward, and hence they explode. If you know that a hurricane is coming it is therefore better to open as many windows as possible, to equalize the pressure inside and out.

Another example of Bernoulli's principle at work is in the lift of aircraft wings and the motion of "**curve balls**" in baseball.

In both cases, the design is such as to create a speed differential of the flowing air past the object on the top and the bottom - for aircraft wings this comes from the movement of the flaps, and for the baseball it is the presence of ridges.

Such a speed differential leads to a pressure difference between the top and bottom of the object, resulting in a net force being exerted, either upwards or downwards.

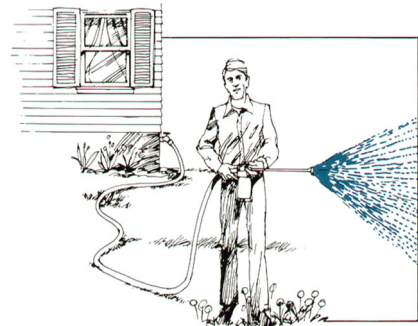

*Action of a spray atomizer*



# Bernoulli's Equation

Glenn  
Research  
Center

## Restrictions :

- Inviscid
- Steady
- Incompressible (low velocity)
- No heat addition.
- Negligible change in height.

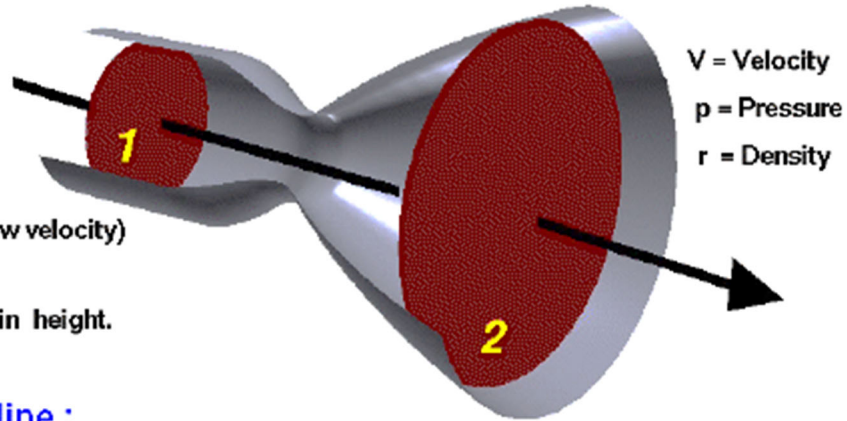

## Along a streamline :

static pressure + dynamic pressure = total pressure

$$p_s + \frac{rV^2}{2} = p_t$$

$$\left( p_s + \frac{rV^2}{2} \right)_1 = \left( p_s + \frac{rV^2}{2} \right)_2$$

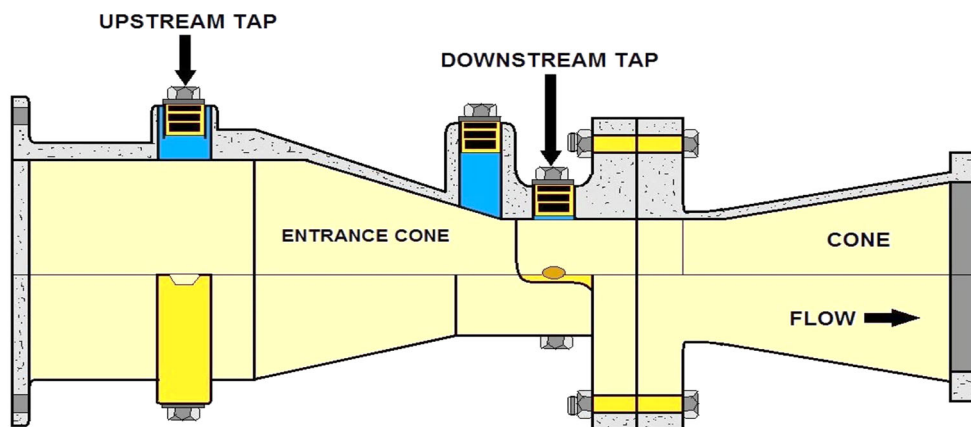

**VENTURI TUBE**



## Physical Science and Laws Section- Post Quiz

### Link to Assignment...

<http://www.ABCTLC.COM/downloads/PDF/PUMPS303ASS.pdf>

### Physical Law Description

Physical laws are:

1. Absolute. \_\_\_\_\_ in the universe appears to affect them.
2. \_\_\_\_\_. Unchanged since first discovered (although they may have been shown to be approximations of more accurate laws).

### Three Laws of Motion

3. **First rule:** An object will remain at rest or in a uniform state of motion unless that state is changed by?
4. **Second rule:** \_\_\_\_\_ is equal to the change in momentum (mass times velocity) over time. In other words, the rate of change is directly proportional to the amount of force applied.
5. **Third rule:** For \_\_\_\_\_ in nature there is an equal and opposite reaction.

### Laws of Thermodynamics

6. **The first law of thermodynamics** demonstrates the relationship between internal energy, added heat, and \_\_\_\_\_ within a system.
7. **The third law of thermodynamics** states that it is impossible to create a thermodynamic process that is?

### Pascal's Law

8. Pressure due to the weight of a liquid, at any level, depends on the depth of the fluid from the?

### Gravity

9. Gravity is one of the four forces of nature. The strength of the \_\_\_\_\_ between two objects depends on their masses.

**Static Pressure**

10. Which term states that a pressure set up in a fluid acts equally in all directions and at right angles to the containing surfaces?

**Answers** 1. Nothing, 2. Stable, 3. An external force, 4. Force, 5. Every action, 6. Work, 7. Perfectly efficient, 8. Surface, 9. Gravitational force, 10. Pascal's law



## Physical Science and Laws References

- Adkins, C.J. (1968). *Equilibrium Thermodynamics*, McGraw-Hill, London, ISBN 0-07-084057-1.
- Adkins, C.J. (1968/1983). *Equilibrium Thermodynamics*, (first edition 1968), third edition 1983, Cambridge University Press, ISBN 0-521-25445-0, pp. 18–20.
- Bailyn, M. (1994). *A Survey of Thermodynamics*, American Institute of Physics Press, New York, ISBN 0-88318-797-3, p. 26.
- Belkin, A.; et., al. (2015). "Self-Assembled Wiggling Nano-Structures and the Principle of Maximum Entropy Production". *Sci. Rep.* 5. Bibcode:2015NatSR...5E8323B. doi:10.1038/srep08323.
- Ben-Naim, A. (2008). *A Farewell to Entropy: Statistical Thermodynamics Based on Information*, World Scientific, New Jersey, ISBN 978-981-270-706-2.
- Buchdahl, H.A. (1966), *The Concepts of Classical Thermodynamics*, Cambridge University Press, London, pp. 30, 34ff, 46f, 83.
- Chris Vuille; Serway, Raymond A.; Faughn, Jerry S. (2009). *College physics*. Belmont, CA: Brooks/Cole, Cengage Learning. p. 355. ISBN 0-495-38693-6.
- De Groot, S.R., Mazur, P. (1962). *Non-equilibrium Thermodynamics*, North Holland, Amsterdam.
- Glansdorff, P., Prigogine, I. (1971). *Thermodynamic Theory of Structure, Stability and Fluctuations*, Wiley-Interscience, London, ISBN 0-471-30280-Guggenheim (1985), p. 8.
- Guggenheim, E.A. (1985). *Thermodynamics. An Advanced Treatment for Chemists and Physicists*, seventh edition, North Holland, Amsterdam, ISBN 0-444-86951-4.
- Kittel, C. Kroemer, H. (1980). *Thermal Physics*, second edition, W.H. Freeman, San Francisco, ISBN 0-7167-1088-9.
- Lebon, G., Jou, D., Casas-Vázquez, J. (2008). *Understanding Non-equilibrium Thermodynamics. Foundations, Applications, Frontiers*, Springer, Berlin, ISBN 978-3-540-74252-4.
- Münster, A. (1970), *Classical Thermodynamics*, translated by E.S. Halberstadt, Wiley–Interscience, London, ISBN 0-471-62430-6, p. 22.
- Onsager, L. (1931). "Reciprocal Relations in Irreversible Processes". *Phys.Rev.*37. Bibcode:1931PhRv...37..405O. doi:10.1103/PhysRev.37.405.
- Pippard, A.B. (1957/1966). *Elements of Classical Thermodynamics for Advanced Students of Physics*, original publication 1957, 1966, Cambridge University Press, Cambridge UK, p. 10.
- Serrin, J. (1978). The concepts of thermodynamics, in *Contemporary Developments in Continuum Mechanics and Partial Differential Equations. Proceedings of the International Symposium on Continuum Mechanics and Partial Differential Equations, Rio de Janeiro, August 1977*, edited by G.M. de La Penha, L.A.J. Medeiros, North-Holland, Amsterdam, ISBN 0-444-85166-6, pages 411-451.
- Serrin, J. (1986). Chapter 1, 'An Outline of Thermodynamical Structure', pages 3-32, in *New Perspectives in Thermodynamics*, edited by J. Serrin, Springer, Berlin, ISBN 3-540-15931-2.
- Sommerfeld, A. (1951/1955). *Thermodynamics and Statistical Mechanics*, vol. 5 of *Lectures on Theoretical Physics*, edited by F. Bopp, J. Meixner, translated by J. Kestin, Academic Press, New York, page 1.
- Wilson, H.A. (1966). *Thermodynamics and Statistical Mechanics*, Cambridge University Press, London UK, pp. 4, 8, 68, 86, 97, 311.
- Ziegler, H. (1983). *An Introduction to Thermomechanics*. North Holland, Amsterdam.



## Section 2- Fluid Mechanics and Hydraulic Principles

**Section Focus:** You will learn the basics of fluid mechanics and hydraulic principles. At the end of this section, you will be able to describe primary water mechanics and hydraulic principles. There is a post quiz at the end of this section to review your comprehension and a final examination in the Assignment for your contact hours.

**Scope/Background:** In order to design flow rates, pumping system, calculate pump flows, we need to master this area of engineering.

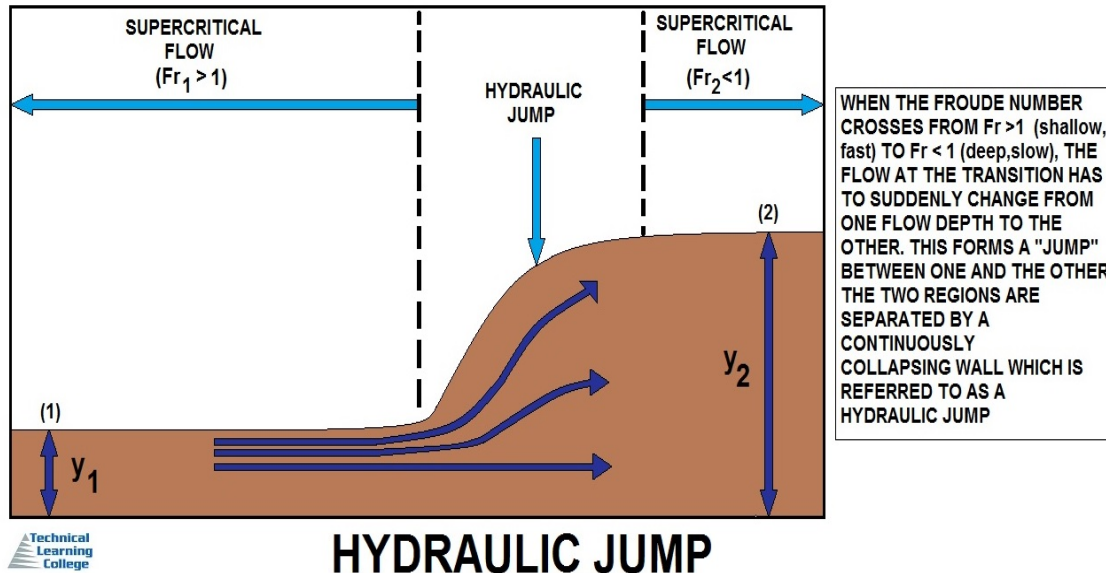

A hydraulic jump is a phenomenon in the science of hydraulics which is frequently observed in open channel flow such as rivers and spillways. When liquid at high velocity discharges into a zone of lower velocity, a rather abrupt rise occurs in the liquid surface. Hydraulic jump is the jump or standing wave formed when the depth of flow of water changes from supercritical to subcritical state.

### Applicable Equations

**Froude Number:**  $Fr = V/\sqrt{gL}$

Where:  $Fr$  = Froude number  $V$  = Velocity  $g$  = gravity  $L$  = depth of flow

**Critical Flow Depth:**  $y_c = (y_1/2)(\sqrt{1+8Fr_1^2}-1)$

Where:  $y_c$  = critical flow depth  $y_1$  = upstream measured depth  $Fr$  = Froude number

**Upstream Energy Level:**  $E_1 = y_1 + (V_1^2/2g)$

Where:  $E_1$  = upstream energy level  $V_1$  = Velocity upstream  $y_1$  = upstream measured depth  $g$  = gravity

**Head Loss:**  $h_L = (y_2 - y_1)^3 / (4y_1y_2)$

Where:  $h_L$  = head loss in the hydraulic jump  $y_1$  = upstream measured depth  $y_2$  = downstream measured depth

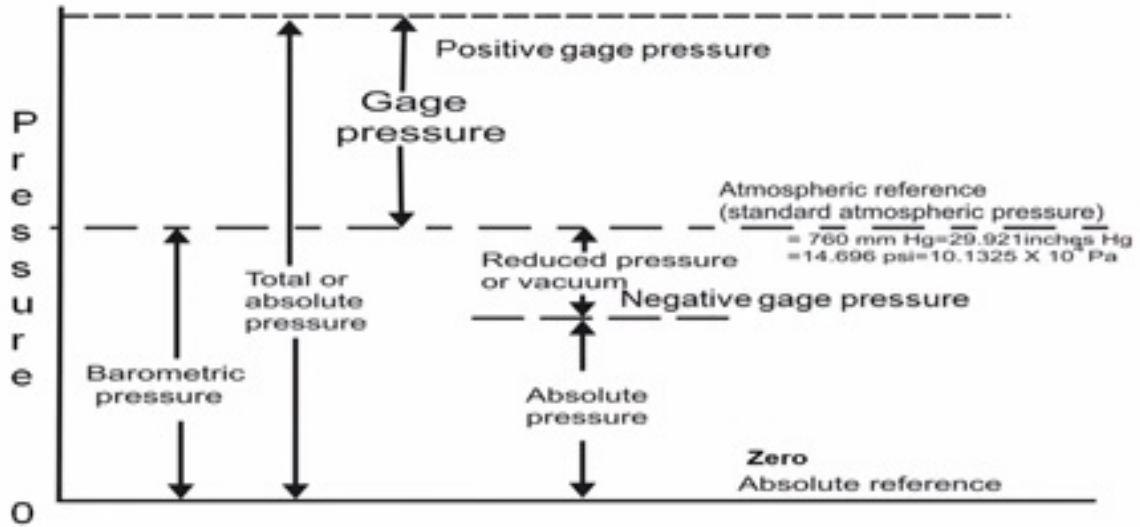

UNIT	ABBREVIATION	EQUIVALENT NUMBER OF PASCALS
ATMOSPHERE	atm	1 atm = 101,325 Pa
BAR	bar	1 bar = 100,025 Pa
MILLIMETER OF MERCURY	mmHg	1 mmHg = 133.322 Pa
INCHES OF MERCURY	inHg	1 inHg = 3386 Pa
PASCAL	Pa	1
KILOPASCAL	kPa	1 kPa = 1000 Pa
POUNDS PER SQUARE INCH	psi	1 psi = 6,893 Pa
TORR	torr	1 torr = 133.322 Pa



## DIFFERENT UNITS OF PRESSURE

# Fluid Mechanics and Hydraulic Principles Key Terms

## Fluid Dynamics

In physics, fluid dynamics is a sub-discipline of fluid mechanics that deals with fluid flow—the natural science of fluids (liquids and gases) in motion. It has several sub-disciplines itself, including aerodynamics (the study of air and other gases in motion) and hydrodynamics (the study of liquids in motion).

## Head

The height of a column or body of fluid above a given point expressed in linear units. Head is often used to indicate gauge pressure. Pressure is equal to the height times the density of the liquid.

## Head, Friction

The head required to overcome the friction at the interior surface of a conductor and between fluid particles in motion. It varies with flow, size, type, and conditions of conductors and fittings, and the fluid characteristics.

## Head, Static

The height of a column or body of fluid above a given point.

## Hydraulics

Engineering science pertaining to liquid pressure and flow.

## Hydrokinetics

Engineering science pertaining to the energy of liquid flow and pressure.

## Pascal's Law

A pressure applied to a confined fluid at rest is transmitted with equal intensity throughout the fluid.

## Pressure

The application of continuous force by one body upon another that it is touching; compression. Force per unit area, usually expressed in pounds per square inch (Pascal or bar).

## Pressure, Absolute

The pressure above zero absolute, i.e. the sum of atmospheric and gauge pressure. In vacuum related work it is usually expressed in millimeters of mercury. (mmHg). Is the pressure exported by the atmosphere at any specific location.

## Pressure, Atmospheric

Pressure exerted by the atmosphere at any specific location. (Sea level pressure is approximately 14.7 pounds per square inch absolute, 1 bar = 14.5psi.)

## Pressure, Gauge

Pressure differential above or below ambient atmospheric pressure.

## Pressure, Static

The pressure in a fluid at rest.



## Fluid Fiction

We need to think about complicated piping arrangements and the friction losses that are created that restrict water flows.

The concepts of fluid friction vary depending on whether the motion is taking place in a liquid or gas. One item that both media share is that the resistance to motion contributes to an object reaching its terminal velocity. This occurs when the resistance from a gas or fluid is equal to the weight of the object, and it remains constant until another force is introduced.

For motion in a liquid, viscous resistance caused by a drag force is proportional to the velocity of the object at slow speeds. This drag force is based on the object's geometry and the viscosity of the liquid, which can vary between fluids.

For motion through air, friction at slow speeds is proportional to the velocity. At higher speeds, the drag force depends on the cross-sectional area of an object, the object's density and the drag coefficient. This drag force has a negative value, as the resistance is always opposite the direction of velocity.

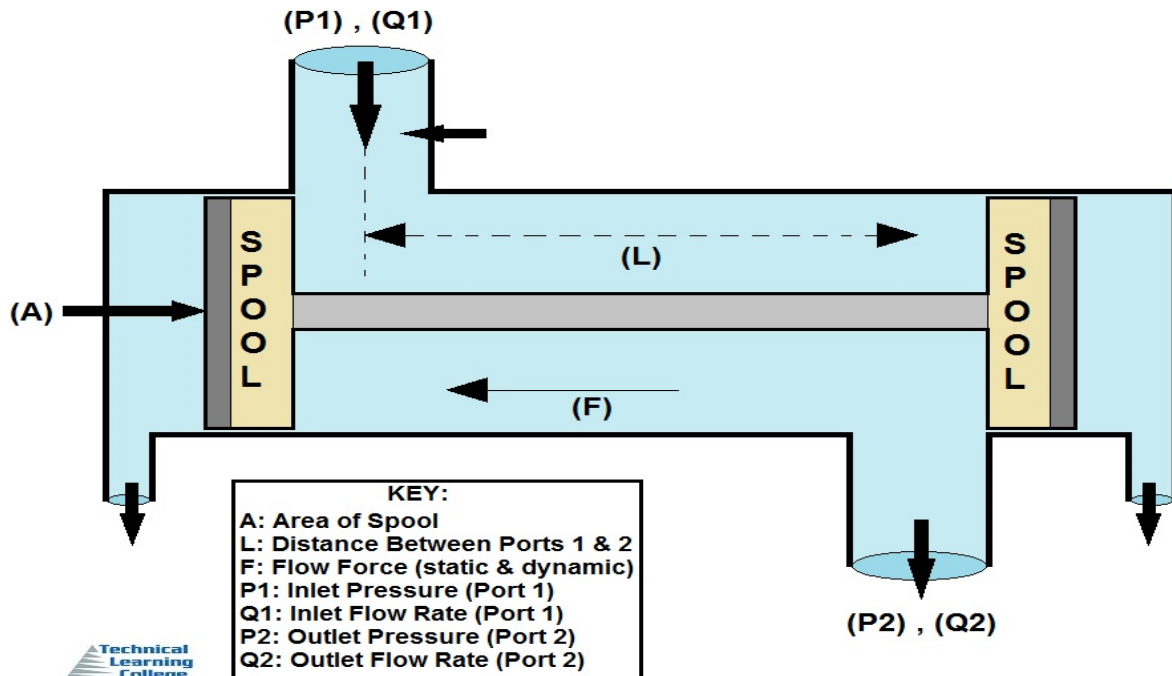

### BASIC HYDRAULIC PRINCIPAL

## Hydraulic Systems - Closed or Open Systems

A closed loop system is one where the inlet of the pump is supplied by the oil leaving outlet of the actuator (usually a motor) the pump is driving, hence the closed loop.

An open loop system is one where the outlet of the actuator will return to the tank via a directional valve, with the pump inlet drawing fluid from the same common tank.

The open loop system relatively speaking has no pressurized connection between actuator outlet and pump inlet and is the most common type used in industrial hydraulics as it can perform multiple tasks and therefore multiple sequences.

The closed loop with its pressurized connection is most commonly found hydro-static transmissions in mobile applications.

## Fluid Mechanics Review

Fluid mechanics provides the theoretical foundation for hydraulics, which focuses on the applied engineering using the properties of fluids. In its fluid power applications, hydraulics is used for the generation, control, and transmission of power by the use of pressurized liquids.

Hydraulic topics range through some parts of science and most of engineering modules, and cover concepts such as pipe flow, dam design, fluidics and fluid control circuitry. The principles of hydraulics are in use naturally in the human body within the vascular system and erectile tissue. Free surface hydraulics is the branch of hydraulics dealing with free surface flow, such as occurring in rivers, canals, lakes, estuaries and seas. Its sub-field open-channel flow studies the flow in open channels.



THE FORCE OF GRAVITY ACTS BETWEEN ALL OBJECTS

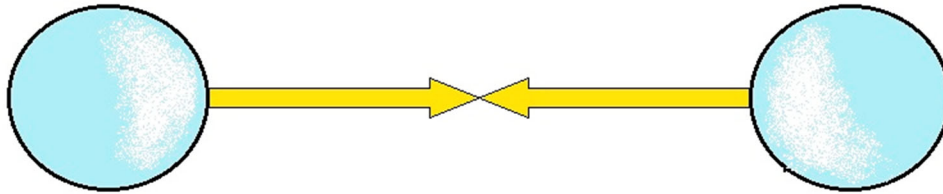

AS MASS INCREASES, FORCE OF GRAVITY THEN INCREASES



AS THE DISTANCE INCREASES, FORCE OF GRAVITY THEN DECREASES

## GRAVITY

A Natural Phenomenon by which all things with energy are brought towards one another

### Specific Gravity Introduction

When you put something in water, gravity can pull the object down through the water only if an equal volume of water is allowed to go up against the force of gravity; this is called displacement. In effect, gravity has to choose which it will pull down, the water or the immersed object. What we call buoyancy is, in effect, forcing gravity to make this choice.

Faced with this choice, gravity will act more strongly on whichever has more mass (thus, more weight) per given volume. So if the thing you immerse is denser than water it will sink, but its apparent weight is reduced by the volume of water that gets displaced upward. If instead the water is denser, the immersed object will float up to the point where the displaced volume of water matches the whole object's mass. Then the net weight is zero

**Specific gravity** is the ratio of the density of a substance to the density of a reference substance; equivalently, it is the ratio of the mass of a substance to the mass of a reference substance for the same given volume. *Apparent* specific gravity is the ratio of the weight of a volume of the substance to the weight of an equal volume of the reference substance.

The reference substance for liquids is nearly always water at its densest (at 4 °C or 39.2 °F); for gases it is air at room temperature (20 °C or 68 °F). Nonetheless, the temperature and pressure must be specified for both the sample and the reference. Pressure is nearly always 1 atm (101.325 kPa).



## Fluid Mechanics and Hydraulic Principles- Introduction

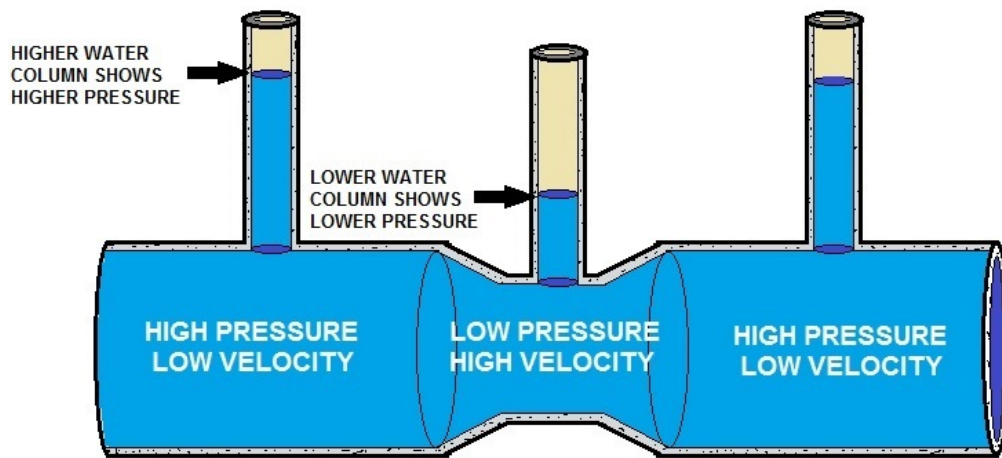

### BERNOULLI'S PRINCIPAL

FAST MOVING FLUID WILL GENERATE LOW PRESSURE  
SLOW MOVING FLUID WILL GENERATE HIGHER PRESSURE



## Hydraulics

*The Engineering science pertaining to liquid pressure and flow.*

Hydraulics is a branch of engineering concerned mainly with moving liquids. This term is applied commonly to the study of the mechanical properties of water, other liquids, and even gases when the effects of compressibility are small. Hydraulics can be separated into two areas, hydrostatics and hydrokinetics.

The word *hydraulics* is based on the Greek word for water, and originally covered the study of the physical behavior of water at rest and in motion. Use has broadened its meaning to include the behavior of all liquids, although it is primarily concerned with the motion of liquids.

Hydraulics includes the method in which liquids act in tanks and pipes, deals with their properties, and explores ways to take advantage of these properties.

Hydrostatics is the study of liquids at rest, involves problems of buoyancy and flotation, pressure on dams and submerged devices, and hydraulic presses. The relative incompressibility of liquids is one of hydrostatics' basic principles.

Hydrodynamics is the study of liquids in motion, is concerned with such matters as friction and turbulence generated by flowing liquids inside pipes, the flow of water over weirs and through nozzles, and the use of hydraulic pressure in machinery.

## Hydrostatics

Hydrostatics is the study about the pressures exerted by a fluid at rest. Any fluid is meant, not just water. Research and careful study on water yields many useful results of its own, thus, such as forces on dams, buoyancy and hydraulic actuation, and is well worth studying for such practical reasons.

Hydrostatics is a superb example of deductive mathematical physics, one that can be understood easily and completely from a very few fundamentals, and in which the predictions agree closely with experiment.

There are few better illustrations of the use of the integral calculus, as well as the principles of ordinary statics, available to the student.

A great deal can be done with only elementary mathematics. Properly adapted and converted, the material can be used from the earliest introduction of school science, giving an excellent example of a quantitative science with many possibilities for hands-on experiences. The definition of a fluid deserves careful thought.

Generally, time is not a factor in hydrostatics, it enters in the approach to hydrostatic equilibrium. It is usually stated that a fluid is a substance that cannot resist a shearing stress, so that pressures are normal to confining surfaces.

The study of geology has now shown us that there are substances which can resist shearing forces over short time intervals, and appear to be typical solids, but which flow like liquids over long time intervals. Such materials include wax and pitch, ice, and even rock.

A ball of pitch, which can be shattered by a hammer, will spread out and flow in months. Ice, a typical solid, will flow in a period of years, as shown in glaciers, and rock will flow over hundreds of years, as in convection in the mantle of the earth.

Shear earthquake waves, with periods of seconds, propagate deep in the earth, though the rock there can flow like a liquid when considered over centuries. The rate of shearing may not be strictly proportional to the stress, but exists even with low stress.

Viscosity may be the physical property that varies over the largest numerical range, competing with electrical resistivity. There are several familiar topics in hydrostatics which often appears in expositions of introductory science, and which are also of historical interest and can enliven their presentation.



## **Archimedes**

Archimedes instituted the study of hydrostatics in about 250 B.C. when, according to legend, he leapt out of his bath and ran naked through the streets of Syracuse crying “Eureka!”; it has undergone rather little development since.

The foundations of hydrodynamics, on the other hand, were not laid until the 18th century when mathematicians such as Leonhard Euler and Daniel Bernoulli began to explore the consequences, for a virtually continuous medium like water, of the dynamic principles that Newton had enunciated for systems composed of discrete particles. Their work was continued in the 19th century by several mathematicians and physicists of the first rank, notably G.G. Stokes and William Thomson.

By the end of the century, explanations had been found for a host of intriguing phenomena having to do with the flow of water through tubes and orifices, the waves that ships moving through water leave behind them, raindrops on windowpanes, and the like. There was still no proper understanding, thus, of problems as fundamental as that of water flowing past a fixed obstacle and exerting a drag force upon it; the theory of potential flow, which worked so well in other contexts, yielded results that at relatively high flow rates were grossly at variance with experiment.

## **Ludwig Prandtl**

This problem was not properly comprehended until 1904, when the German physicist Ludwig Prandtl introduced the concept of the boundary layer. Prandtl’s career continued into the period in which the first manned aircraft were developed. Since that time, the flow of air has been of as much interest to physicists and engineers as the flow of water, and hydrodynamics has, as an after-affect, become fluid dynamics. The term fluid mechanics, as used here, embraces both fluid dynamics and the subject still generally referred to as hydrostatics.

## **Geoffrey Taylor**

One other representative of the 20th century who deserves reference here besides Prandtl is Geoffrey Taylor of England. Taylor remained a classical physicist while most of his contemporaries were turning their attention to the problems of atomic structure and quantum mechanics, and he made several unexpected and important discoveries in the field of fluid mechanics.

The value of fluid mechanics is due in large part to a term in the basic equation of the motion of fluids which is nonlinear—*i.e.*, one that involves the fluid velocity twice over. It is characteristic of systems described by nonlinear equations that under certain conditions they become unstable and begin behaving in ways that seem at first sight to be totally chaotic. In the case of fluids, chaotic behavior is very common and is called turbulence.

Mathematicians have now begun to recognize patterns in chaos that can be analyzed fruitfully, and this development suggests that fluid mechanics will remain a field of active research well into the 21st century.

Fluid mechanics is a subject with almost endless results, and the account that follows is necessarily incomplete. Some knowledge of the basic properties of fluids will be needed; a survey of the most relevant properties will be given in the next section.

## Properties of Fluids

Fluids are not strictly continuous media in the way that all the successors of Euler and Bernoulli have assumed, for fluids are composed of discrete molecules. The molecules, though, are so small and, except in gases at very low pressures, the number of molecules per milliliter is so enormous that they need not be viewed as individual entities.

There are a few liquids, known as liquid crystals, in which the molecules are packed together in such a way as to make the properties of the medium locally anisotropic, but the vast majority of fluids -including air and water- are isotropic.

In fluid mechanics, the state of an isotropic fluid may be completely described by defining its mean mass per unit volume, or density ( $\rho$ ), its temperature ( $T$ ), and its velocity ( $v$ ) at every point in space, and just what the connection is between these macroscopic properties and the positions and velocities of individual molecules is of no direct relevance.

### Isotropic Fluid or Newtonian Fluid

If the fluid is also isotropic (that is, its mechanical properties are the same along any direction), the viscosity tensor reduces to two real coefficients, describing the fluid's resistance to continuous shear deformation and continuous compression or expansion, respectively.

### Fluid Statics

Fluid statics or hydrostatics is the branch of fluid mechanics that studies fluids at rest. It embraces the study of the conditions under which fluids are at rest in stable equilibrium; and is contrasted with fluid dynamics, the study of fluids in motion.

Hydrostatics offers physical explanations for many wonders of everyday life, such as why atmospheric pressure changes with altitude, why wood and oil float on water, and why the surface of water is always flat and horizontal whatever the shape of its container.

Hydrostatics is fundamental to hydraulics, the engineering of equipment for storing, transporting and using fluids. It is also relevant to some aspect of geophysics and astrophysics (i.e., in understanding plate tectonics and anomalies in the Earth's gravitational field), to meteorology, to medicine (with the context of blood pressure), and many other fields.

### Fluid Dynamics

Fluid dynamics is a sub-discipline of fluid mechanics that deals with fluid flow—the science of liquids and gases in motion. Fluid dynamics offers a systematic structure—which underlies these practical disciplines—that embraces empirical and semi-empirical laws derived from flow measurement and used to solve practical problems.

The solution to a fluid dynamics problem typically involves calculating various properties of the fluid, such as velocity, pressure, density, and temperature, as functions of space and time.

It has several sub-disciplines itself, including aerodynamics (the study of air and other gases in motion) and hydrodynamics (the study of liquids in motion).

Fluid dynamics has a wide range of applications, including calculating forces and moments on aircraft, determining the mass flow rate of petroleum through pipelines, predicting evolving weather patterns, even understanding nebulae in interstellar space and modeling explosions.

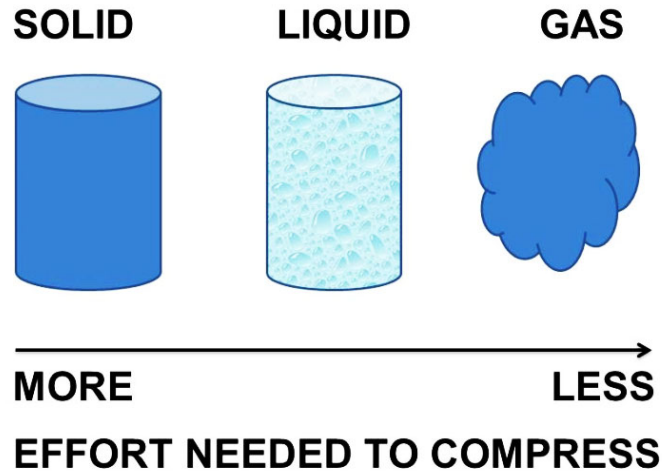

## Gases and Liquids

A word is needed about the difference between gases and liquids, though the difference is easier to perceive than to describe.

In gases, the molecules are sufficiently far apart to move almost independently of one another, and gases tend to expand to fill any volume available to them.

In liquids, the molecules are more or less in contact, and the short-range attractive forces between them make them cohere; the molecules are moving too fast to settle down into the ordered arrays that are characteristic of solids, but not so fast that they can fly apart.

Thus, samples of liquid can exist as drops or as jets with free surfaces, or they can sit in beakers constrained only by gravity, in a way that samples of gas cannot.

Such samples may evaporate in time, as molecules one by one pick up enough speed to escape across the free surface and are not replaced. The lifetime of liquid drops and jets, yet, is normally long enough for evaporation to be ignored.

## Properties of Fluids Key Terms

The term fluid includes both liquid and gases. The main difference between a liquid and a gas is that the volume of a liquid remains definite because it takes the shape of the surface on or in which it comes into contact, whereas a gas occupies the complete space available in the container in which it is kept. In hydraulics in civil engineering, the fluid for consideration is liquid, so, we will examine some terms and properties of the liquids

### 1. DENSITY OR MASS DENSITY

Density or mass density of a fluid is defined as the ratio of the mass of a fluid to its volume. Thus mass per unit volume of a fluid is called density.

It is denoted by the symbol  $\rho$  (rho). The unit of mass density in SI unit is kg per cubic meter. The density of liquids may be considered as constant while that of gases changes with the variation of pressure and temperature.

$$\rho = \frac{\text{Mass of fluid}}{\text{Volume of fluid}}$$

The value of density of water is 1gm per cubic centimeter or 1000 kg per cubic meter.

### 2. SPECIFIC WEIGHT AND WEIGHT DENSITY

Specific weight or weight density of a fluid is the ratio between the weight of a fluid to its volume. Thus weight per unit volume of a fluid is called weight density and it is denoted by the symbol

$$\begin{aligned} w &= \frac{\text{Weight of fluid}}{\text{Volume of fluid}} = \frac{(\text{Mass of fluid}) \times \text{Acceleration due to gravity}}{\text{Volume of fluid}} \\ &= \frac{\text{Mass of fluid} \times g}{\text{Volume of fluid}} = \rho \times g \\ \Rightarrow w &= \rho g \end{aligned}$$

The value of specific weight of specific density ( $w$ ) of water is  $9.81 \times 1000 \text{ Newton/m}^3$

### 3. SPECIFIC VOLUME

Specific volume of a fluid is defined as the volume of a fluid occupied by a unit mass or volume per unit mass of a fluid.

$$\frac{\text{Volume of fluid}}{\text{Mass of fluid}} = \frac{1}{\frac{\text{Mass of fluid}}{\text{Volume of fluid}}} = \frac{1}{\rho}$$

Specific volume =

Thus, specific volume is the reciprocal of mass density. It is expressed as  $\text{m}^3/\text{kg}$ . It is commonly applied to gases.

#### 4. SPECIFIC GRAVITY

Specific gravity is defined as the ratio of the weight density (or density) of a fluid to the weight density (or density) of a standard fluid. For liquids, the standard fluid is taken as water and for gases, the standard fluid is taken as air.

Specific gravity is also called relative density. It is a dimensionless quantity and is denoted by the symbol S.

$$S \text{ (for liquids)} = \frac{\text{Weight density of liquid}}{\text{Weight density of water}}$$

$$S \text{ (for gases)} = \frac{\text{Weight density of gas}}{\text{Weight density of air}}$$

Thus, weight density of a liquid = S x weight density of water = S x  $9.81 \times 1000 \text{ Newton/m}^3$

The density of liquid = S x Density of water = S x  $1000 \text{ kg/m}^3$ .

If the specific gravity of a fluid is known, then the density of the liquid will be equal to specific gravity of fluid multiplied by the density of water. For example, the specific gravity of mercury is

13.6. Hence density of mercury =  $13.6 \times 1000 \text{ kg/m}^3$ .

#### 5. VISCOSITY OF LIQUID:

Viscosity is defined as the property of a fluid which offers resistance to the movement of one layer of fluid over another adjacent layer of fluid. When two layers of a fluid, a distance apart move over one other at different velocities, the viscosity together with relative velocity causes a shear stress acting between the fluid layers.

The top layer causes a shear stress on the adjacent layer while the lower layer causes a shear stress on the top layer. This shear stress is proportional to the rate of change of velocity. It is denoted by the symbol  $\tau$ .

$$\tau \propto \frac{du}{dy}$$

$$\tau = \mu \frac{du}{dy}$$

Where  $\mu$  (mu) is the constant of proportionality and is known as the coefficient of dynamic

viscosity or only viscosity,  $\frac{du}{dy}$  represents the rate of shear strain or rate of shear deformation or velocity gradient.

$$\Rightarrow \mu = \frac{\tau}{\frac{du}{dy}}$$

The viscosity is also defined as the shear stress required to produce unit rate of shear strain.



## Units of Viscosity

In MKS system, unit of viscosity =  $\frac{\text{kgf} \cdot \text{cm}}{\text{m}^2}$

CGS unit of viscosity (also called Poise) =  $\frac{\text{dyne} \cdot \text{sec}}{\text{cm}^2}$

SI unit of viscosity =  $\text{Ns} / \text{m}^2 = \text{Pa-s}$

## Unit Conversion

Conversion between MKS and CGS system

$$\frac{1 \text{ kgf-sec}}{\text{m}^2} = \frac{9.81 \text{ N-sec}}{\text{m}^2}$$

$$\text{dyne} = \text{gm} \times \frac{\text{cm}}{\text{sec}^2}$$

$$1 \text{ N} = 1000 \times 100 \text{ dyne}$$

$$\frac{1 \text{ kgf-sec}}{\text{m}^2} = \frac{9.81 \text{ N-sec}}{\text{m}^2} = 98.1 \text{ poise}$$

$$1 \text{ poise} = \frac{1 \text{ Ns}}{10 \text{ m}^2}$$

$$1 \text{ centipoise} = \frac{1}{100} \text{ poise}$$

## KINEMATIC VISCOSITY

It is defined as the ratio between the dynamic viscosity and density of fluid. It is denoted by the Greek symbol ( $\nu$ ) called nu. Thus,

$$\nu = \frac{\text{Viscosity}}{\text{Density}} = \frac{\mu}{\rho}$$

In MKS and SI, the unit of kinematic viscosity is  $\text{m}^2 / \text{sec}$  while in CGS units, it is written as  $\text{cm}^2 / \text{s}$ . In CGS system, kinematic viscosity is also known as stoke.

One stoke =  $1 \text{ cm}^2 / \text{s}$

**Newton's Law of Viscosity:**

It states that the shear stress ( $\tau$ ) on a fluid element layer is directly proportional to the rate of change of shear strain. The constant of proportionality is called the co-efficient of viscosity.

$$\tau \propto \frac{du}{dy}$$

$$\tau = \mu \frac{du}{dy}$$

Fluids which obey the above relation are known as Newtonian fluids and the fluids which do not obey the above relation are called Non-Newtonian fluids.

**Variation of Viscosity with temperature:**

The viscosity of liquids decreases with the increase in temperature, while the viscosity of gases increases with the increase in temperature.

**(i) For liquids:**

$$\mu = \mu_0 \left( \frac{1}{1 + \alpha t + \beta t^2} \right)$$

Where,  $\mu$  = viscosity of liquid at  $t^\circ C$  in poise

$\mu_0$  = viscosity of liquid at  $0^\circ C$  in poise

$\alpha, \beta$  are constants for the liquid.

For water,  $\mu_0 = 1.79 \times 10^{-3}$  poise,  $\alpha = 0.03368$  and  $\beta = 0.000221$

**(ii) For Gases**

$$\mu = \mu_0 + \alpha t - \beta t^2$$

For air,  $\mu_0 = 0.00017$ ,  $\alpha = 0.000000056$  and  $\beta = 0.1189 \times 10^{-9}$

**TYPES OF FLUIDS BASED ON VISCOSITY**

The fluids may be classified into following five types:

1. Ideal fluid
2. Real fluid
3. Newtonian fluid
4. Non-Newtonian fluid
5. Ideal plastic fluid

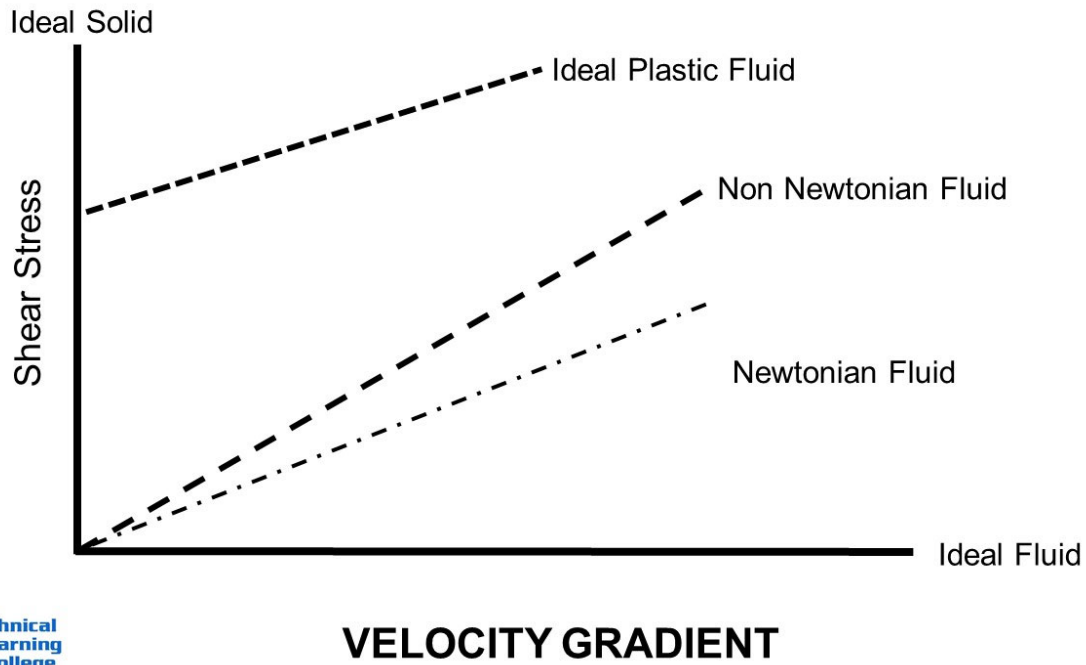

## Type of Fluids

### 1. Ideal Fluid

A fluid which is incompressible and is having no viscosity, is known as ideal fluid. Ideal fluid is only an imaginary fluid as all the fluids which exists have some viscosity.

### 2. Real Fluids

A fluid which possesses viscosity is known as real fluid. All the fluids in actual practice are real fluids.

### 3. Newtonian Fluids

A real fluid in which the shear stress is directly proportional to rate of shear strain (or velocity gradient).

### 4. Non-Newtonian Fluid

A real fluid in which the shear stress is not proportional to the rate of shear strain.

### 5. Ideal Plastic Fluid

A fluid in which shear stress is more than the yield value and shear stress is proportional to the rate of shear strain (or velocity gradient).

# UNITS OF PRESSURE

	Pascal	Bar	Technical atmosphere	Standard atmosphere	Torr	Pounds per square inch
	(Pa)	(bar)	(at)	(atm)	(Torr)	(lbf/in <sup>2</sup> )
1 Pa	≡ 1 N/m <sup>2</sup>	10 <sup>-5</sup>	1.0197 × 10 <sup>-5</sup>	9.8692 × 10 <sup>-6</sup>	7.5006 × 10 <sup>-3</sup>	0.000 145 037 737 730
1 bar	10 <sup>5</sup>	≡ 100 kPa ≡ 10 <sup>6</sup> dyn/cm <sup>2</sup>	1.0197	0.986 92	750.06	14.503 773 773 022
1 at	98 066.5	0.980 665	≡ 1 kgf/cm <sup>2</sup>	0.967 841 105 354 1	735.559 240 1	14.223 343 307 120 3
1 atm	101 325	1.013 25	1.0332	1	760	14.695 948 775 514 2
1 Torr	133.322 368 421	0.001 333 224	0.001 359 51	$\frac{1}{760} \approx 0.001 315 789$	1 Torr ≈ 1 mmHg	0.019 336 775
1 lbf/in <sup>2</sup>	6894.757 293 168	0.068 947 573	0.070 306 958	0.068 045 964	51.714 932 572	≡ 1 lbf/in <sup>2</sup>

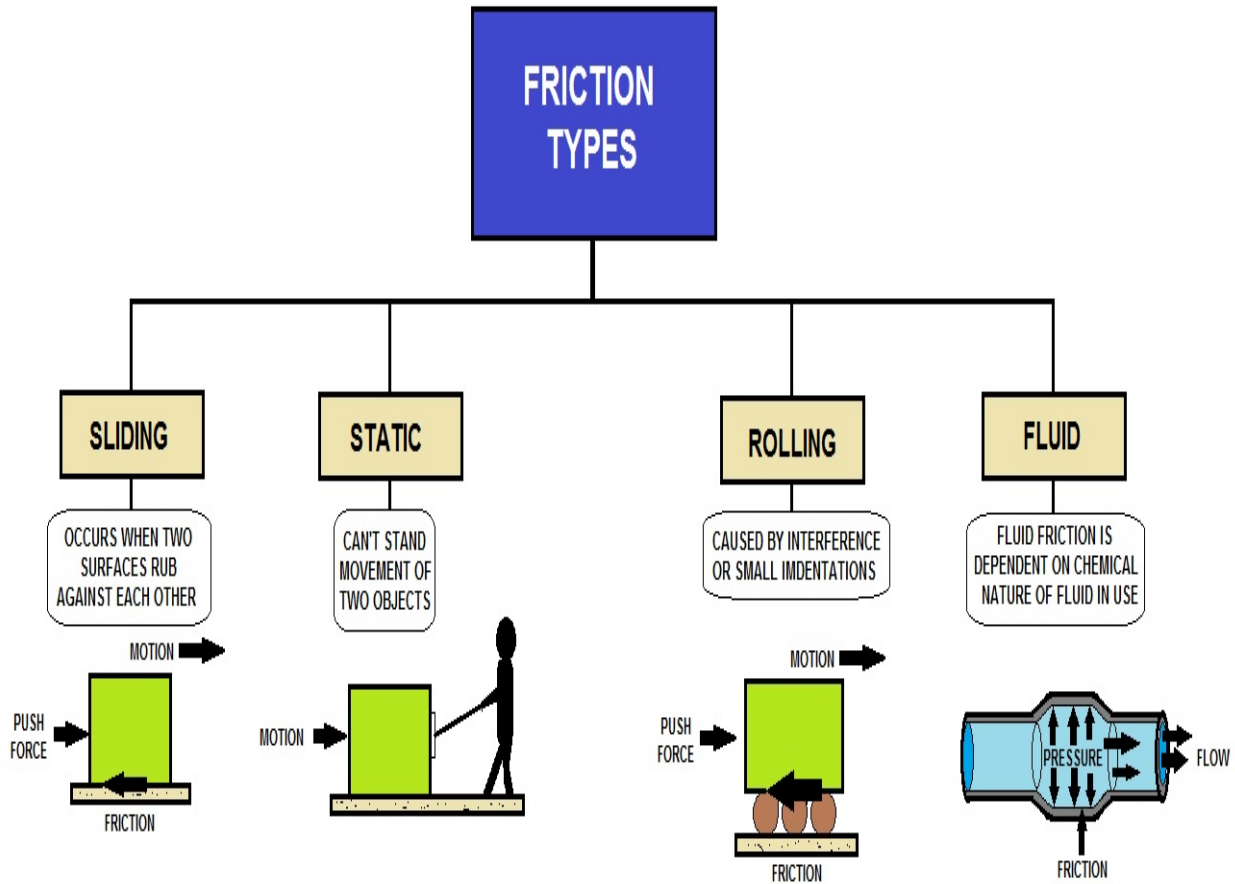

## FRICTION TYPE EXAMPLES



## Stresses and Pressure

There are two sorts of stress that may exist in any solid or fluid medium, and the difference between them may be demonstrated by holding a brick held between two hands. If the holder moves his hands toward each other, he exerts pressure on the brick; if he moves one hand toward his body and the other away from it, then he exerts what is called a shear stress.

A solid substance such as a brick can withstand stresses of both types, but fluids, by definition, yield to shear stresses no matter how small these stresses may be. They do so at a rate determined by the fluid's viscosity.

This property, about which more will be said later, is a measure of the friction that arises when adjacent layers of fluid slip over one another. It follows that the shear stresses are everywhere zero in a fluid at rest and in equilibrium, and from this it follows that the pressure (that is, force per unit area) acting perpendicular to all planes in the fluid is the same irrespective of their orientation (Pascal's law).

For an isotropic fluid in equilibrium there is only one value of the local pressure ( $p$ ) consistent with the stated values for  $p$  and  $T$ . These three quantities are linked together by what is called the equation of state for the fluid.

For gases at low pressures the equation of state is simple and well known. It is

$$p = \left( \frac{RT}{M} \right) \rho \quad (118)$$

where  $R$  is the universal gas constant (8.3 joules per degree Celsius per mole) and  $M$  is the molar mass, or an average molar mass if the gas is a mixture; for air, the appropriate average is about  $29 \times 10^{-3}$  kilogram per mole.

For other fluids, knowledge of the equation of state is often incomplete. Except under very extreme conditions, however, all one needs to know is how the density changes when the pressure is changed by a small amount, and this is described by the compressibility of the fluid—either the isothermal compressibility,  $\beta_T$ , or the adiabatic compressibility,  $\beta_S$ , according to circumstance. When an element of fluid is compressed, the work done on it tends to heat it up.

If the heat has time to dissipate away to the surroundings and the temperature of the fluid remains essentially unchanged throughout, then  $\beta_T$  is the relevant quantity.

If virtually none of the heat escapes, as is more commonly the case in flow problems because the thermal conductivity of most fluids is poor, then the flow is said to be adiabatic, and  $\beta_S$  is needed instead.

(The  $S$  refers to entropy, which remains constant in an adiabatic process provided that it takes place slowly enough to be treated as “reversible” in the thermodynamic sense.)

For gases that obey equation (118), it is evident that  $p$  and  $\rho$  are proportional to one another in an isothermal process, and

$$\beta_T = \rho^{-1} \left( \frac{\partial \rho}{\partial P} \right)_T = p^{-1} \quad (119)$$

### Reversible Adiabatic Processes

In reversible adiabatic processes for such gases, however, the temperature rises on compression at a rate such that

$$T \propto p^{(\gamma-1)}, \quad p \propto \rho^\gamma \quad (120)$$

and

$$\beta_S = \rho^{-1} \left( \frac{\partial \rho}{\partial P} \right)_S = (\gamma p)^{-1} = \frac{\beta_T}{\gamma} \quad (121)$$

where  $\gamma$  is about 1.4 for air and takes similar values for other common gases. For liquids the ratio between the isothermal and adiabatic compressibilities is much closer to unity. For liquids, however, both compressibilities are normally much less than  $p^{-1}$ , and the simplifying assumption that they are zero is often justified.

The factor  $\gamma$  is not only the ratio between two compressibilities; it is also the ratio between two principal specific heats.

The molar specific heat is the amount of heat required to raise the temperature of one mole through one degree. This is greater if the substance is allowed to expand as it is heated, and therefore to do work, than if its volume is fixed.

The principal molar specific heats,  $C_P$  and  $C_V$ , refer to heating at constant pressure and constant volume, respectively, and

$$\gamma = \left( \frac{C_P}{C_V} \right) \quad (122)$$

For air,  $C_P$  is about 3.5  $R$ .

## Solids

Solids can be stretched without breaking, and liquids, though not gases, can withstand stretching, too. Therefore, if the pressure is steadily reduced in a specimen of very pure water, bubbles will ultimately appear, but they may not do so until the pressure is negative and well below  $-10^7$  newton per square meter; this is 100 times greater in magnitude than the (positive) pressure exerted by the Earth's atmosphere.

Water owes its high ideal strength to the fact that rupture involves breaking links of attraction between molecules on either side of the plane on which rupture occurs; work must be done to break these links.

Yet, its strength is drastically reduced by anything that provides a nucleus at which the process known as cavitation (formation of vapor- or gas-filled cavities) can begin, and a liquid containing suspended dust particles or dissolved gases is liable to cavitate quite easily.

## Surface Tension

Work also must be done if a free liquid drop of spherical shape is to be drawn out into a long thin cylinder or deformed in any other way that increases its surface area. Here again work is needed to break intermolecular links.

The surface of a liquid behaves as if it were an elastic membrane under tension, except that the tension exerted by an elastic membrane increases when the membrane is stretched in a way that the tension exerted by a liquid surface does not.

Surface tension is what causes liquids to rise up capillary tubes, what supports hanging liquid drops, what limits the formation of ripples on the surface of liquids, and so on.

PRESSURE =  $\frac{F}{A}$  (FORCE DIVIDED BY AREA)

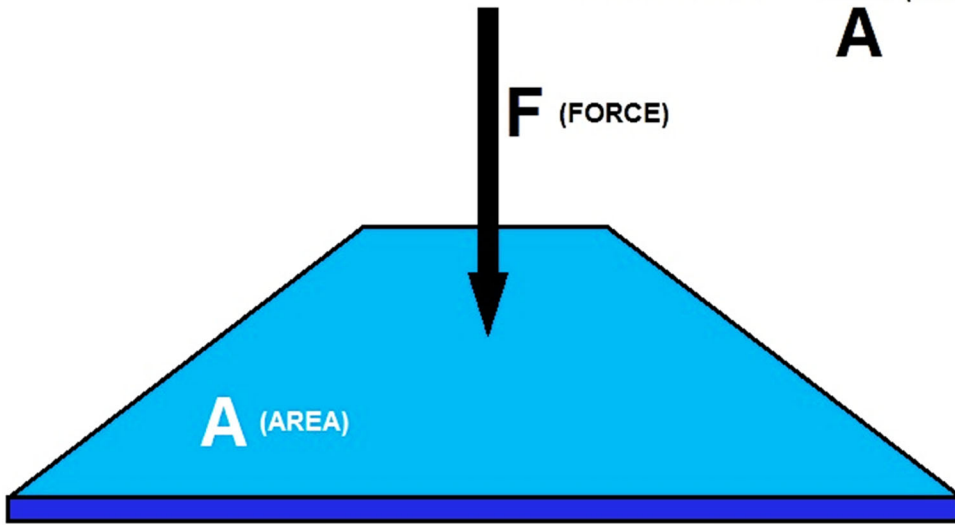

**WHAT IS PRESSURE?**

PRESSURE IS THE AMOUNT OF FORCE ACTING ON A SPECIFIC AREA AND IS EQUAL TO THE FORCE DIVIDED BY THE AREA





## Friction Sub-Section

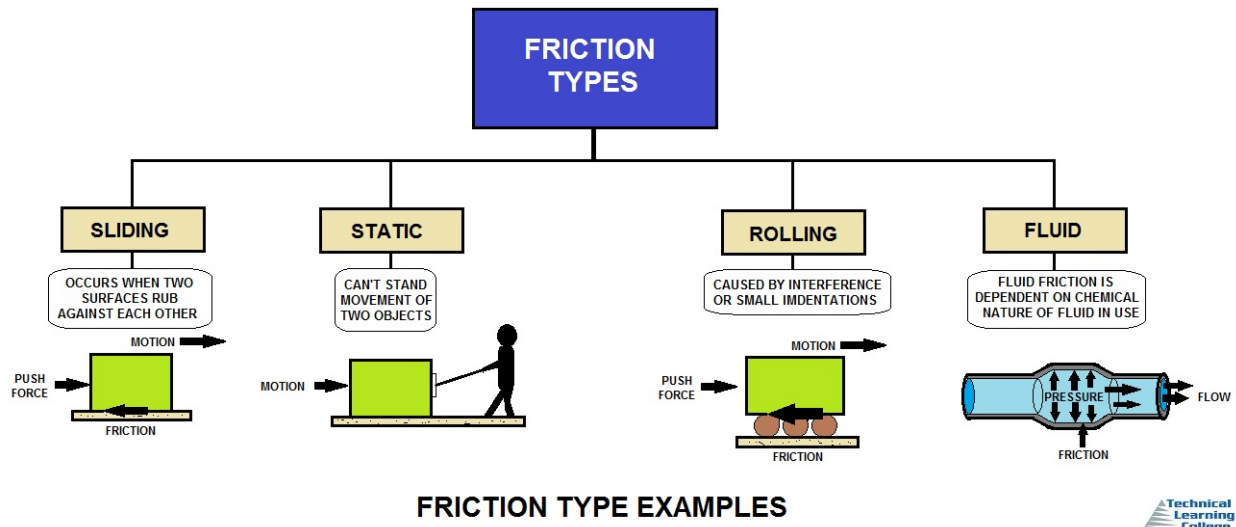

Friction is the force resisting the relative motion of solid surfaces, fluid layers, and material elements sliding against each other.

### There are several classes or types of friction:

- Dry friction is a force that opposes the relative lateral motion of two solid surfaces in contact. Dry friction is subdivided into static friction ("stiction") between non-moving surfaces, and kinetic friction between moving surfaces. With the exception of atomic or molecular friction, dry friction generally arises from the interaction of surface features, known as asperities.
- Fluid friction explains the friction between layers of a viscous fluid that are moving relative to each other.
- Lubricated friction is a case of fluid friction where a lubricant fluid separates two solid surfaces.
- Skin friction is a component of drag, the force resisting the motion of a fluid across the surface of a body.
- Internal friction is the force resisting motion between the elements making up a solid material while it undergoes deformation.

## Kinetic Energy

When surfaces in contact move relative to each other, the friction between the two surfaces converts kinetic energy into thermal energy -that is, it converts work to heat. This property can have dramatic consequences, as illustrated by the use of friction created by rubbing pieces of wood together to start a fire.

Kinetic energy is converted to thermal energy whenever motion with friction occurs, for example when a viscous fluid is stirred. Another important consequence of many types of friction can be wear, which may lead to performance degradation or damage to components. Friction is a component of the science of tribology.

Friction is desirable and important in supplying traction to facilitate motion on land. Most land vehicles rely on friction for acceleration, deceleration and changing direction. Sudden reductions in traction can cause loss of control and accidents. Friction is not itself a fundamental force.

Dry friction arises from a combination of inter-surface adhesion, surface roughness, surface deformation, and surface contamination. The complexity of these interactions makes the calculation of friction from first principles impractical and necessitates the use of empirical methods for analysis and the development of theory. Friction is a non-conservative force - work done against friction is path dependent. In the presence of friction, some energy is always lost in the form of heat. Thus mechanical energy is not conserved.

### **What is Tribology?**

Tribology is the science and engineering of interacting surfaces in relative motion. It includes the study and application of the principles of friction, lubrication and wear. Tribology is a branch of mechanical engineering and materials science.

### **Fluid Friction (Drag)**

Fluid friction is observed in the flow of liquids and gases. Fluid friction causes are similar to those responsible for friction between solid surfaces, for it also depends on the chemical nature of the fluid and the nature of the surface over which the fluid is flowing. The tendency of the liquid to resist flow, one example, is its degree of viscosity, is another important factor.

Fluid friction is affected by increased velocities, and the modern streamline design of airplanes and automobiles is the result of engineers' efforts to minimize fluid friction while retaining speed and protecting structure.

In fluid dynamics, drag (occasionally called air resistance, a type of friction, or fluid resistance, another type of friction or fluid friction) is a force acting opposite to the relative motion of any object moving with respect to a surrounding fluid. This can exist between two fluid layers (or surfaces) or a fluid and a solid surface. Unlike other resistive forces, such as dry friction, which are nearly independent of velocity, drag forces depend on velocity.

### **Drag Force**

Drag force is proportional to the velocity for a laminar flow and the squared velocity for a turbulent flow. Even though the basic cause of a drag is viscous friction, the turbulent drag is independent of viscosity. Drag forces always decrease fluid velocity relative to the solid object in the fluid's path.

### **Examples of Drag**

Examples of drag include the component of the net aerodynamic or hydrodynamic force acting opposite to the direction of movement of a solid object such as cars, aircraft and boat hulls; or acting in the same geographical direction of motion as the solid, as for sails attached to a downwind sail boat, or in intermediate directions on a sail depending on points of sail.

In the case of viscous drag of fluid in a pipe, drag force on the immobile pipe decreases fluid velocity relative to the pipe.

In physics of sports, the drag force is necessary to explain the performance of runners, particularly of sprinters.

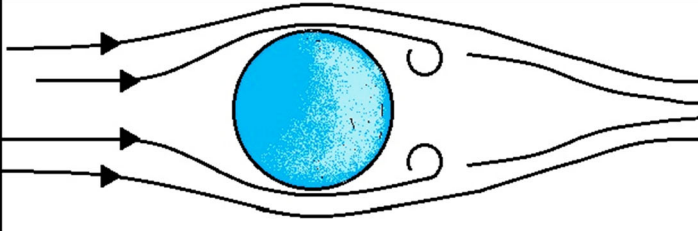
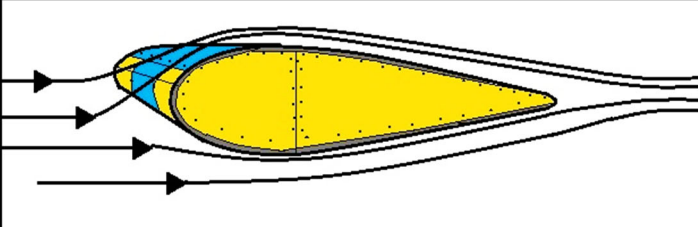
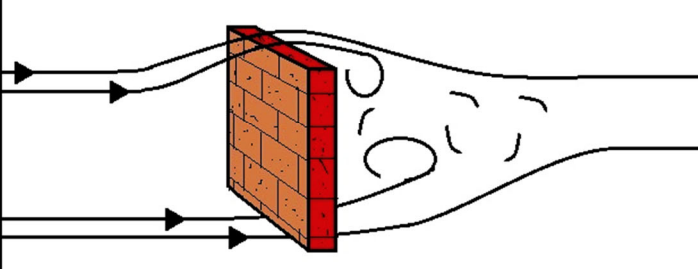
	<p style="text-align: center;"><b>SPHERE</b></p> <p>-ROUND OBJECTS SUCH AS BASEBALLS / SOFTBALLS EXPERIENCE A MEDIUM AMOUNT OF DRAG</p>
	<p style="text-align: center;"><b>AIRFOIL</b></p> <p>-THE SHAPE OF AIRPLANE WINGS MINIMIZE DRAG</p>
	<p style="text-align: center;"><b>SQUARE</b></p> <p>-FLAT OBJECTS, SUCH AS BOXES OR WALLS EXPERIENCE A VERY HIGH AMOUNT OF DRAG</p>

### DRAG FORCE (VISCOUS)

- THIS IS THE FORCE OF FRICTION CAUSED BY FLOWING FLUID
- IN THE OPPOSITE DIRECTION TO THE MOVEMENT OF FLUID



### Types of Drag

Types of drag are generally divided into the following categories:

#### Parasitic drag, consisting of

- ✓ form drag,
- ✓ skin friction,
- ✓ interference drag,
- ✓ lift-induced drag, and
- ✓ wave drag (aerodynamics) or wave resistance (ship hydrodynamics).

The phrase parasitic drag is mainly used in aerodynamics, since for lifting wings drag it is in general small compared to lift. For flow around bluff bodies, form and interference drags often dominate, and then the qualifier "parasitic" is meaningless.

Further, lift-induced drag is only relevant when wings or a lifting body are present, and is therefore usually discussed either in aviation or in the design of semi-planing or planing hulls.

Wave drag occurs either when a solid object is moving through a fluid at or near the speed of sound or when a solid object is moving along a fluid boundary, as in surface waves.

## What is Fluid Friction?

Fluid friction occurs between fluid layers that are moving relative to each other. This internal resistance to flow is named viscosity. In everyday terms, the viscosity of a fluid is described as its “thickness”. All real fluids offer some resistance to shearing and therefore are viscous. It is helpful to use the concept of an inviscid fluid or an ideal fluid which offers no resistance to shearing and so is not viscous.

## Several Types of Friction

- **Dry friction** resists relative lateral motion of two solid surfaces in contact.
- **Fluid friction** describes the friction between layers of a viscous fluid that are moving relative to each other.
- **Lubricated friction** is a case of fluid friction where a lubricant fluid separates two solid surfaces.
- **Skin friction** is a component of drag, the force resisting the motion of a fluid across the surface of a body.
- **Internal friction** is the force resisting motion between the elements making up a solid material while it undergoes deformation.

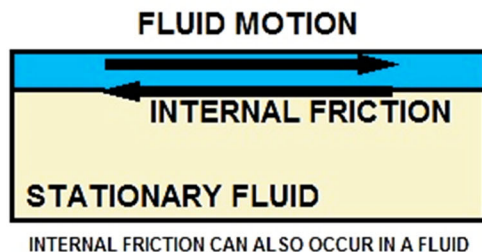
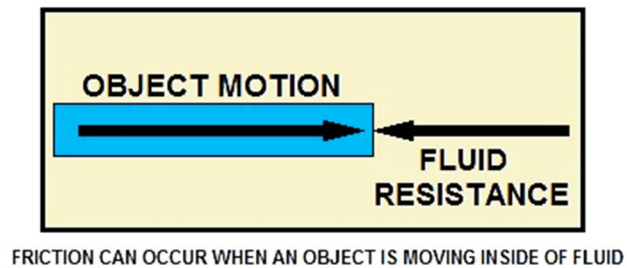
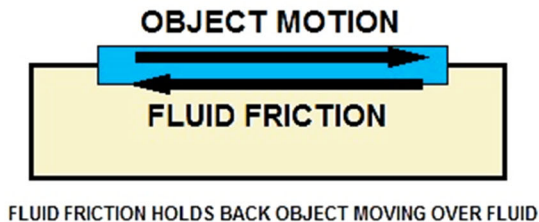
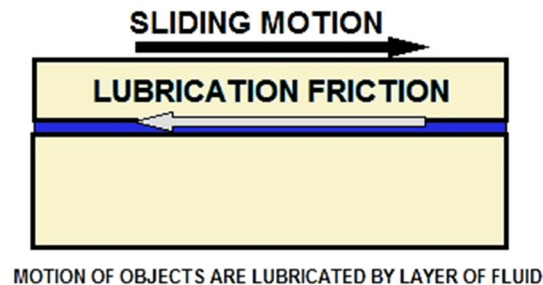
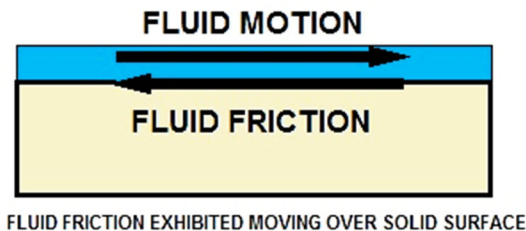

## Parshall Flumes and Measuring Flow

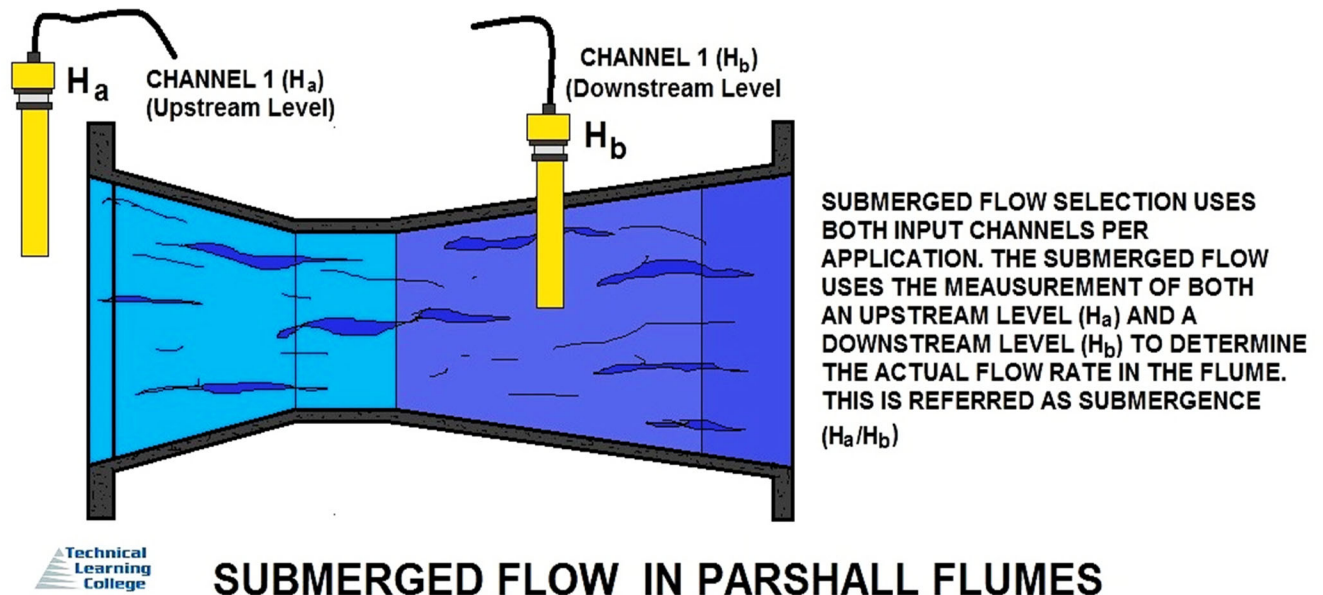

The **Parshall flume** is an open channel flow-metering device that was developed to measure the flow of surface waters and irrigation flows. The Parshall flume is a fixed hydraulic structure. It is used to measure volumetric flow rate in industrial discharges, municipal sewer lines, and influent/effluent flows in wastewater treatment plants.

The Parshall flume accelerates flow through a contraction of both the parallel sidewalls and a drop in the floor at the flume throat. Under free-flow conditions, the depth of water at specified location upstream of the flume throat can be converted to a rate of flow. Some states specify the use of Parshall flumes, by law, for certain situations (commonly water rights).

The design of the Parshall flume is standardized under ASTM D1941, ISO 9826:1992, and JIS B7553-1993. The flumes are not patented and the discharge tables are not copyright protected. A hydraulic jump occurs downstream of the flume for free flow conditions. As the flume becomes submerged, the hydraulic jump diminishes and ultimately disappears as the downstream conditions increasingly restrict the flow out of the flume.

The free-flow discharge can be summarized as

$$Q = CH_a^n$$

where

- $Q$  is flow rate
- $C$  is the free-flow coefficient for the flume
- $H_a$  is the head at the primary point of measurement
- $n$  varies with flume size (e.g. 1.55 for a 1-inch flume)

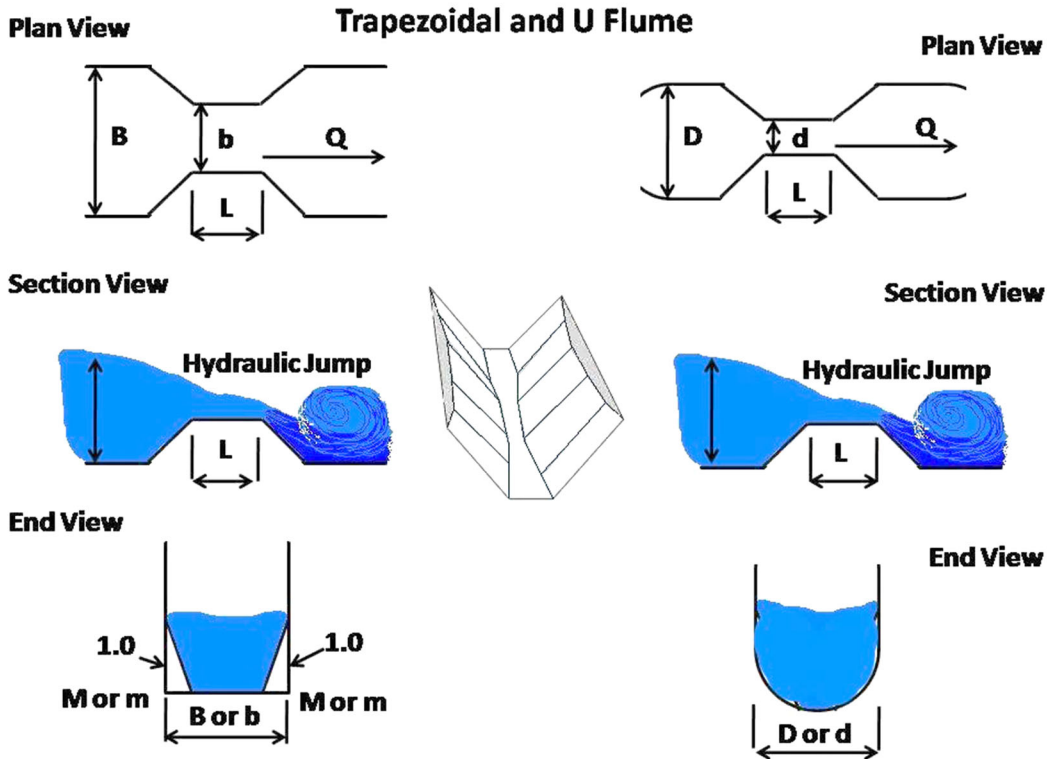

## More on Parshall Flumes

**Parshall Flume** provides both accuracy and rangeability. Dimensions and capacities are in accordance with those published in the U.S. Department of the Interior's Water Measurement Manual.

**Parshall Flumes** are a primary flow element for flow measurement in open channels. The big advantages of Parshall Flumes are their self-cleaning capabilities, low head loss, single-head measurement, and wide operating range.

While commonly used in rectangular channels, they can also be adapted for use in circular channels. Flumes feature stiffening ribs, braces and anchor clips. Options include stilling well, staff gauge, flow sensors, adaptors, etc.

### Clarification

Clarification on category-specific wastestream classifications may be provided by consulting the applicable regulation(s) and associated development documents, since wastestream types are addressed in the effluent guideline and categorical standard development process. When in doubt, the Control Authority can always require the CIU to monitor the wastestream(s) in question to quantify the presence (or lack thereof) of categorically regulated pollutants.

Reasonably accurate flow data must also be obtained for each wastestream type flowing through the monitoring point to ensure categorical pretreatment standards are adjusted accordingly.

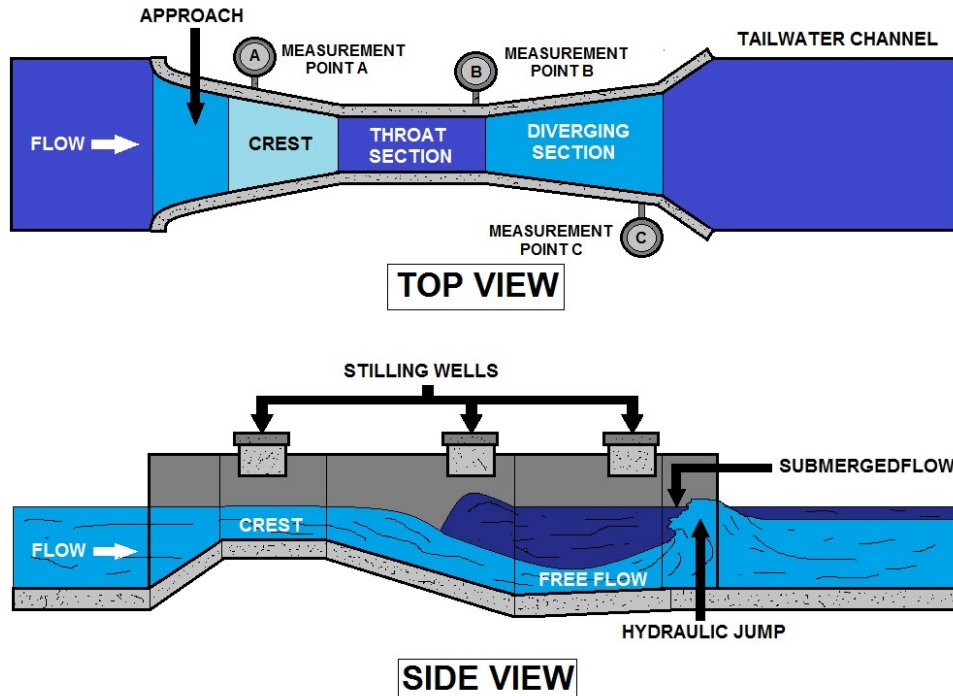

**PARSHALL FLUME DIAGRAM**

### Varieties of Flumes

Some varieties of flumes are used in measuring water flow of a larger channel. When used to measure the flow of water in open channels, a flume is defined as a specially shaped, fixed hydraulic structure that under free-flow conditions forces flow to accelerate in such a manner that the flow rate through the flume can be characterized by a level-to-flow relationship as applied to a single head (level) measurement within the flume.

Acceleration is accomplished through a convergence of the sidewalls, a change in floor elevation, or a combination of the two.

Flow measurement flumes typically consist of a converging section, a throat section, and a diverging section. Not all sections, however, need to be present. In the case of the Cutthroat flume, the converging section directly joins the diverging section, resulting in a throat section of no length (hence the term "Cutthroat").

Other flumes omit the diverging section (Montana and HS / H / HL -flumes). Flumes offer distinct advantages over sharp-crested weirs:

- For the same control width, the head loss for a flume is about one-fourth of that needed to operate a sharp-crested weir
- The velocity of approach is part of the calibration equations for flumes
- Unauthorized altering of the dimensions of constructed flumes is difficult (and therefore unlikely)
- Most flume styles readily allow for the passage of sedimentation and floating debris – reducing the time and effort associated with maintaining a flume installation





## Hydraulic/Electrical Analogy Principles

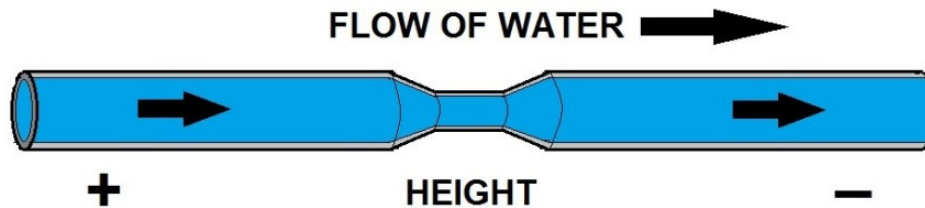

**Electricity flow can be compared to flow of water:**

- When pressure is applied at one end of a pipe (or wire) then, water (or electricity) will come out the other end.

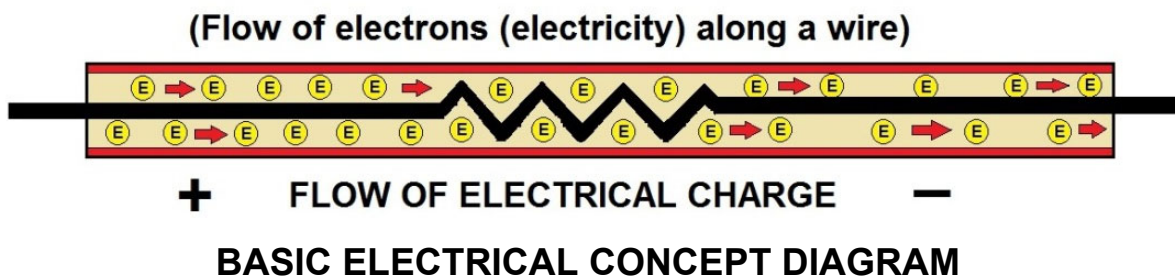

## Water (Hydraulic) and Electrical Principles Are Very Similar

The electronic–**hydraulic analogy** (derisively referred to as the **drain-pipe theory** by Oliver Heaviside) is the most widely used analogy for "electron fluid" in a metal conductor. Since electric current is invisible and the processes at play in electronics are often difficult to demonstrate, the various electronic components are represented by hydraulic equivalents.

Electricity (as well as heat) was originally understood to be a kind of fluid, and the names of certain electric quantities (such as current) are derived from hydraulic equivalents. As all analogies, it demands an intuitive and competent understanding of the baseline paradigms (electronics and hydraulics).

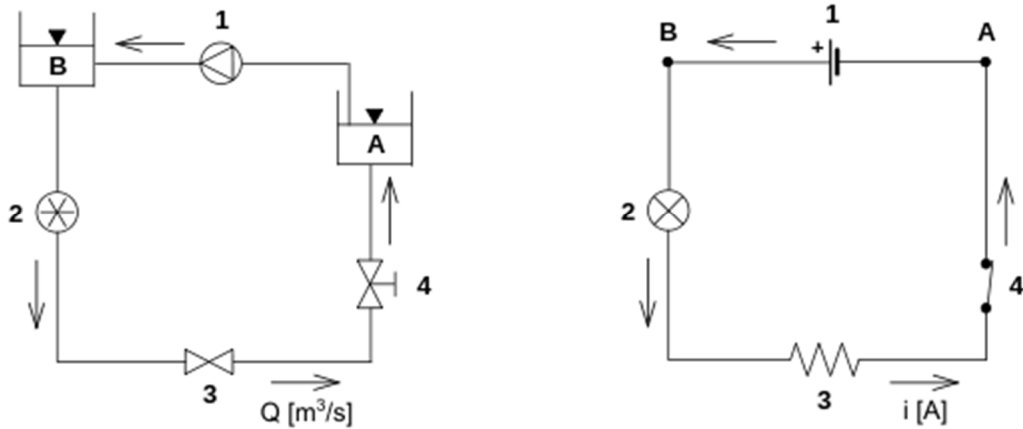

Analogy between a hydraulic circuit (left) and an electronic circuit (right).

### Basic Hydraulic Ideas

There are two basic paradigms:

- Version with pressure induced by gravity. Large tanks of water are held up high, or are filled to differing water levels, and the potential energy of the water head is the pressure source. This is reminiscent of electrical diagrams with an up arrow pointing to +V, grounded pins that otherwise are not shown connecting to anything, and so on.
- Completely enclosed version with pumps providing pressure only; no gravity. This is reminiscent of a circuit diagram with a voltage source shown and the wires actually completing a circuit.

**Applications:** Flow and pressure variables can be calculated in fluid flow network with the use of the hydraulic ohm analogy. The method can be applied to both steady and transient flow situations.

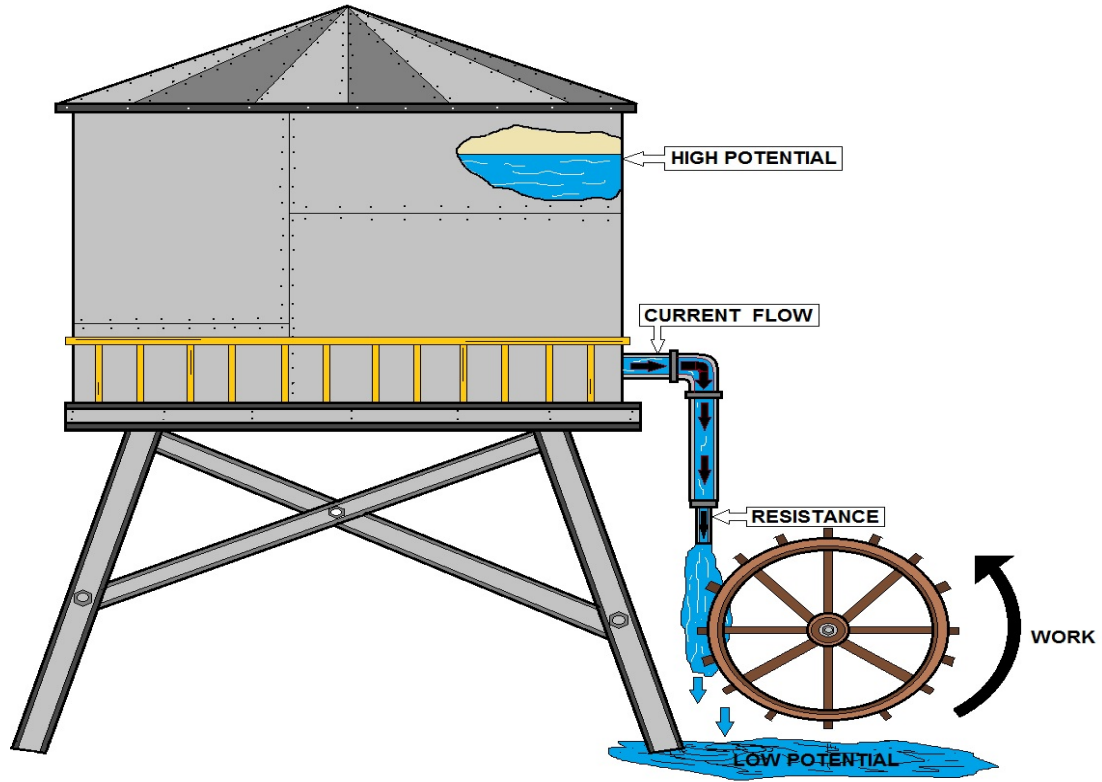

**WATER FLOWS LIKE ELECTRICITY**

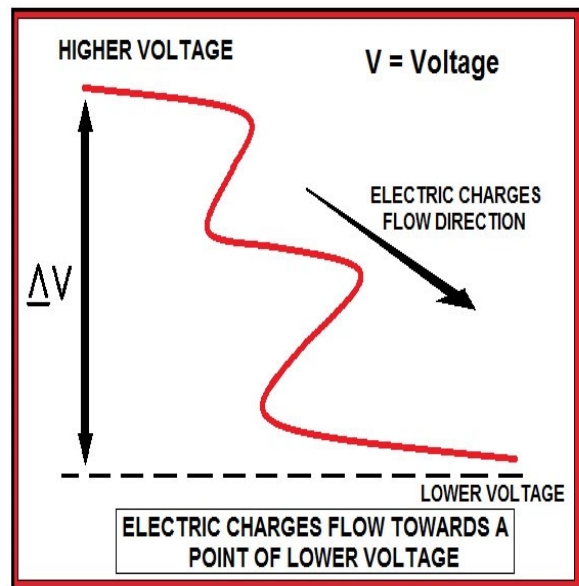
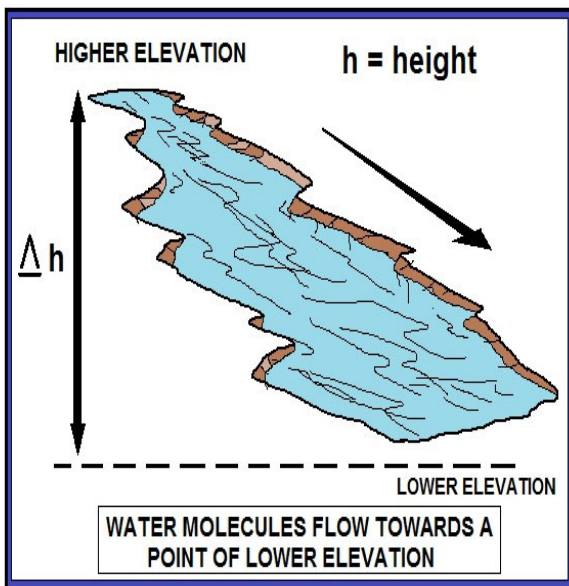

**WATER FLOWS LIKE ELECTRICITY EXAMPLE**

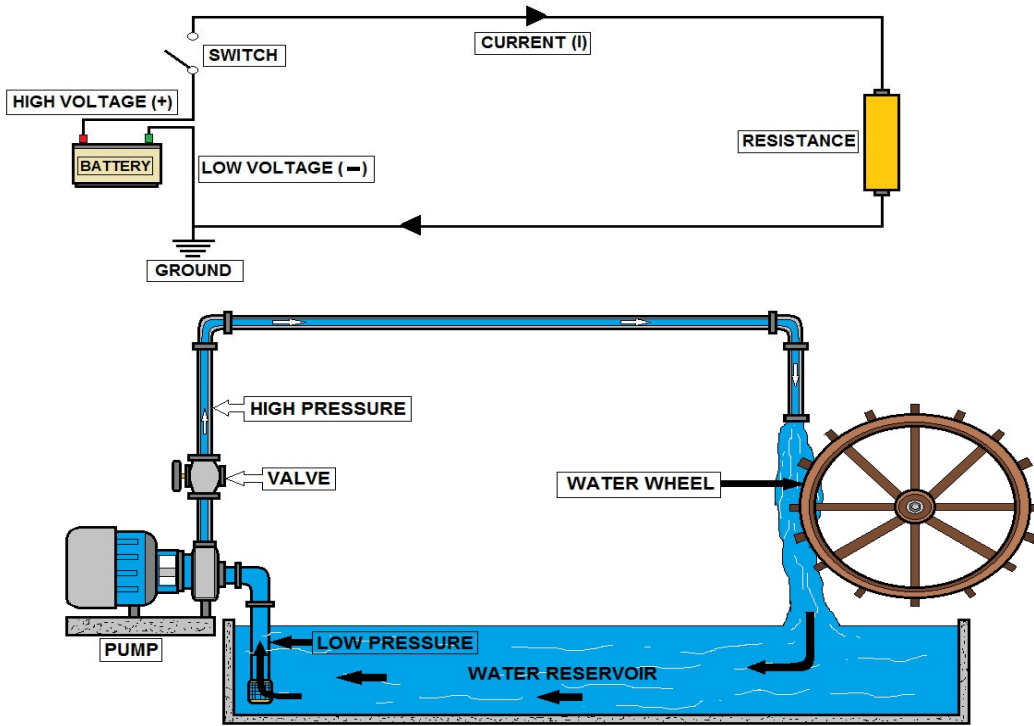

EXAMPLE OF HOW WATER FLOWS SIMILAR TO ELECTRICITY

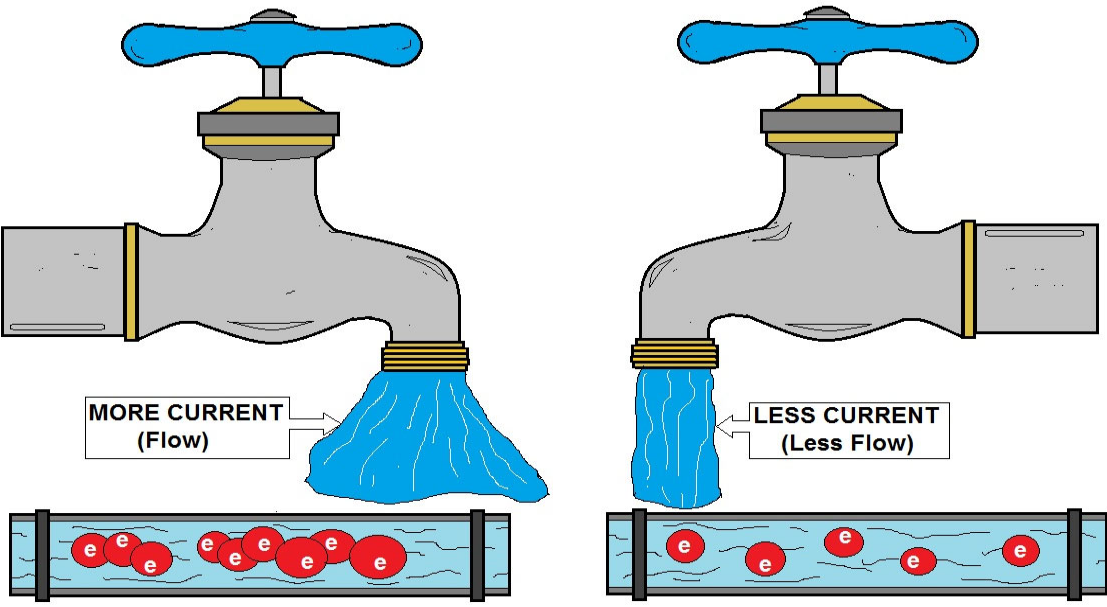

ELECTRIC CURRENT - WATER ANALOGY

## Hydraulic Component Equivalents

### Wires

A relatively wide pipe completely filled with water is equivalent to a piece of wire. When comparing to a piece of wire, the pipe should be thought of as having semi-permanent caps on the ends. Connecting one end of a wire to a circuit is equivalent to forcibly un-capping one end of the pipe and attaching it to another pipe. With few exceptions (such as a high-voltage power source), a wire with only one end attached to a circuit will do nothing; the pipe remains capped on the free end, and thus adds nothing to the circuit.

### Electric potential

In general, it is equivalent to hydraulic head. In this article, it is assumed that the water is flowing horizontally, so that the force of gravity can be ignored, and then electric potential is equivalent to pressure.

### Voltage

Also called voltage drop or *potential difference*. A difference in pressure between two points. Usually measured in volts.

### Electric charge

Equivalent to a quantity of water.

### Current

Equivalent to a hydraulic volume flow rate; that is, the volumetric quantity of flowing water over time. Usually measured in amperes.

### Ideal voltage source, or ideal battery

A dynamic pump with feedback control. A pressure meter on both sides shows that regardless of the current being produced, this kind of pump produces constant pressure difference. If one terminal is kept fixed at ground, another analogy is a large body of water at a high elevation, sufficiently large that the drawn water does not affect the water level.

### Ideal current source

A positive displacement pump. A current meter (little paddle wheel) shows that when this kind of pump is driven at a constant speed, it maintains a constant speed of the little paddle wheel.

### Resistor

A constriction in the bore of the pipe which requires more pressure to pass the same amount of water. All pipes have some resistance to flow, just as all wires have some resistance to current.

### Capacitor

A tank with one connection at each end and a rubber sheet dividing the tank in two lengthwise (a hydraulic accumulator). When water is forced into one pipe, equal water is simultaneously forced out the other pipe, yet no water can penetrate the rubber diaphragm. Energy is stored by the stretching of the rubber. As more current flows "through" the capacitor, the back-pressure (voltage) becomes greater, thus current "leads" voltage in a capacitor. As the back-pressure from the stretched rubber approaches the applied pressure, the current becomes less and less. Thus capacitors "filter out" constant pressure differences and slowly varying, low-frequency pressure differences, while allowing rapid changes in pressure to pass through.

Note that the device described will pass all changes in pressure "through" equally well, regardless of rate of change, just as an electrical capacitor will. Any device in series must obey (electrical) Kirchhoff's Current Law, or its hydraulic equivalent. Considering the "filter" action, a better and more exact analogy is the hydraulic accumulator "pressure tank", as described, but with a closed, pressurized air bladder and only one water connection. Such accumulators are commonly used in hydraulic power systems exactly for the purpose of damping out pressure surges and "hammers" due to valves opening and closing.

### **Inductor**

A heavy paddle wheel placed in the current. The mass of the wheel and the size of the blades restrict the water's ability to rapidly change its rate of flow (current) through the wheel due to the effects of inertia, but, given time, a constant flowing stream will pass mostly unimpeded through the wheel, as it turns at the same speed as the water flow. The mass and surface area of the wheel and its blades are analogous to inductance, and friction between its axle and the axle bearings corresponds to the resistance that accompanies any non-superconducting inductor.

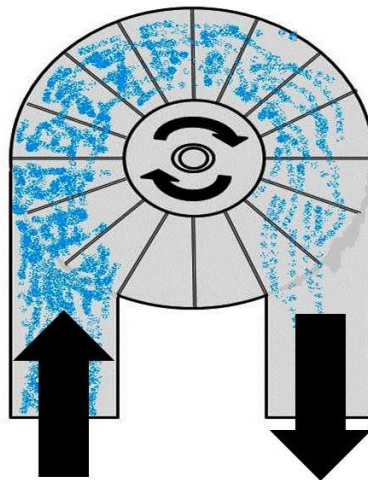

**TURBINE INDUCTOR PADDLE**

Inductors are analogous to a heavy paddle wheel/turbine placed in the current.

An alternative inductor model is simply a long pipe, perhaps coiled into a spiral for convenience. This fluid-inertia device is used in real life as an essential component of a hydraulic ram. The inertia of the water flowing through the pipe produces the inductance effect; inductors "filter out" rapid changes in flow, while allowing slow variations in current to be passed through. The drag imposed by the walls of the pipe is somewhat analogous to parasitic resistance.

In either model, the pressure difference (voltage) across the device must be present before the current will start moving, thus in inductors voltage "leads" current. As the current increases, approaching the limits imposed by its own internal friction and of the current that the rest of the circuit can provide, the pressure drop across the device becomes lower and lower.

**Diode**

Equivalent to a one-way check valve with a slightly leaky valve seat. As with a diode, a small pressure difference is needed before the valve opens. And like a diode, too much reverse bias can damage or destroy the valve assembly.

**Transistor**

A valve in which a diaphragm, controlled by a low-current signal (either constant current for a BJT or constant pressure for a FET), moves a plunger which affects the current through another section of pipe.

**CMOS**

A combination of two MOSFET transistors. As the input pressure changes, the pistons allow the output to connect to either zero or positive pressure.

**Memristor**

A needle valve operated by a flow meter. As water flows through in the forward direction, the needle valve restricts flow more; as water flows the other direction, the needle valve opens further providing less resistance.

**Hydraulic - Electrical Principle Equivalents****EM Wave Speed (velocity of propagation)**

Speed of sound in water. When a light switch is flipped, the electric wave travels very quickly through the wires.

**Charge Flow Speed (drift velocity)**

Particle speed of water. The moving charges themselves move rather slowly.

**DC**

Constant flow of water in a circuit of pipe.

**Low Frequency AC**

Water oscillating back and forth in a pipe.

**Higher-Frequency AC and Transmission Lines**

Sound being transmitted through the water pipes: Be aware that this does not properly mirror the cyclical reversal of alternating electric current. As described, the fluid flow conveys pressure fluctuations, but fluids "do not" reverse at high rates in hydraulic systems, which the above "low frequency" entry does accurately describe. A better concept (if sound waves are to be the phenomenon) is that of direct current with high-frequency "ripple" superimposed.

**Inductive Spark**

Used in induction coils, similar to water hammer, caused by the inertia of water.

## Hydraulic Equation Examples

Some examples of equivalent electrical and hydraulic equations:

type	hydraulic	electric	thermal	mechanical
quantity	volume $V$ [m <sup>3</sup> ]	charge $q$ [C]	heat $Q$ [J]	momentum $P$ [Ns]
potential	pressure $P$ [Pa=J/m <sup>3</sup> ]	potential $\phi$ [V=J/C]	temperature $T$ [K=J/ $k_B$ ]	velocity $v$ [m/s]
flux	Volumetric flow rate $\Phi_V$ [m <sup>3</sup> /s]	current $I$ [A=C/s]	heat transfer rate $\dot{Q}$ [J/s]	force $F$ [N]
flux density	velocity $v$ [m/s]	current density $j$ [C/(m <sup>2</sup> ·s) = A/m <sup>2</sup> ]	heat flux $\dot{Q}''$ [W/m <sup>2</sup> ]	stress $\sigma$ [N/m <sup>2</sup> = Pa]
linear model	Poiseuille's law $\Phi_V = \frac{\pi r^4}{8\eta} \frac{\Delta p^*}{\ell}$	Ohm's law $j = -\sigma \nabla \phi$	Fourier's law $\dot{Q}'' = \kappa \nabla T$	Dashpot $\sigma = c \Delta v$

If the differential equations have the same form, the response will be similar.



## Limits to the Hydraulic Analogy

If taken too far, the water analogy can create misconceptions. For it to be useful, we must remain aware of the regions where electricity and water behave very differently.

### Fields (Maxwell equations, Inductance)

Electrons can push or pull other distant electrons via their fields, while water molecules experience forces only from direct contact with other molecules. For this reason, waves in water travel at the speed of sound, but waves in a sea of charge will travel much faster as the forces from one electron are applied to many distant electrons and not to only the neighbors in direct contact. In a hydraulic transmission line, the energy flows as mechanical waves through the water, but in an electric transmission line the energy flows as fields in the space surrounding the wires, and does not flow inside the metal. Also, an accelerating electron will drag its neighbors along while attracting them, both because of magnetic forces.

### Charge

Unlike water, movable charge carriers can be positive or negative, and conductors can exhibit an overall positive or negative net charge. The mobile carriers in electric currents are usually electrons, but sometimes they are charged positively, such as  $H^+$  ions in proton conductors or holes in p-type semiconductors and some (very rare) conductors.

### Leaking Pipes

The electric charge of an electrical circuit and its elements is usually almost equal to zero, hence it is (almost) constant. This is formalized in Kirchhoff's current law, which does not have an analogy to hydraulic systems, where amount of the liquid is not usually constant. Even with incompressible liquid the system may contain such elements as pistons and open pools, so the volume of liquid contained in a part of the system can change. For this reason, continuing electric currents require closed loops rather than hydraulics' open source/sink resembling spigots and buckets.

#### **James Thurber spoke of his maternal grandmother thus:**

*She came naturally by her confused and groundless fears, for her own mother lived the latter years of her life in the horrible suspicion that electricity was dripping invisibly all over the house. - My Life and Hard Times (1933).*

### Fluid Velocity and Resistance of Metals

As with water hoses, the carrier drift velocity in conductors is directly proportional to current. However, water only experiences drag via the pipes' inner surface, while charges are slowed at all points within a metal. Also, typical velocity of charge carriers within a conductor is less than centimeters per minute, and the "electrical friction" is extremely high. If charges ever flowed as fast as water can flow in pipes, the electric current would be immense, and the conductors would become incandescently hot and perhaps vaporize.

To model the resistance and the charge-velocity of metals, perhaps a pipe packed with sponge, or a narrow straw filled with syrup, would be a better analogy than a large-diameter water pipe. Resistance in most electrical conductors is a linear function: as current increases, voltage drop increases proportionally (Ohm's Law). Liquid resistance in pipes is not linear with volume, varying as the square of volumetric flow (see Darcy–Weisbach equation).

## Quantum Mechanics

Conductors and insulators contain charges at more than one discrete level of atomic orbit energy, while the water in one region of a pipe can only have a single value of pressure. For this reason there is no hydraulic explanation for such things as a battery's charge pumping ability, a diode's voltage drop, solar cell functions, Peltier effect, etc., however equivalent devices can be designed which exhibit similar responses, although some of the mechanisms would only serve to regulate the flow curves rather than to contribute to the component's primary function.

Usefulness requires that the reader or student has a substantial understanding of the model (hydraulic) system's principles. It also requires that the principles can be transferred to the target (electrical) system. Hydraulic systems are deceptively simple: the phenomenon of pump cavitation is a known, complex problem that few people outside of the fluid power or irrigation industries would understand. For those who do, the hydraulic analogy is amusing, as no "cavitation" equivalent exists in electrical engineering. The hydraulic analogy can give a mistaken sense of understanding that will be exposed once a detailed description of electrical circuit theory is required.

One must also consider the difficulties in trying to make the analogy work. The above "electrical friction" example, where the hydraulic analog is a pipe filled with sponge material, illustrates the problem: the model must be increased in complexity beyond any realistic scenario.

## Electrical Measurements and Equipment

Molecule of liquid → electron of electricity

Flow rate (gpm) → current (ampere) I, A

Pressure (psi) → potential (V)

Pressure drop → voltage drop

Pump → generator

# Fluid Mechanics and Hydraulic Principles Post Quiz

## Hydraulics

1. Hydraulics can be divided into two areas, hydrostatics and?

## Hydrostatics

2. Which term may be the physical property that varies over the largest numerical range, competing with electrical resistivity?

## Fluid Statics

3. The solution to a fluid dynamics problem typically involves calculating various properties of the fluid, such as velocity, pressure, density, and temperature, as functions of?

## Gases and Liquids

4. In liquids the molecules are more or less in contact, and the short-range attractive forces between them make them cohere; the molecules are moving too \_\_\_\_\_ into the ordered arrays that are characteristic of solids, but not so fast that they can fly apart.

## Solids

5. Water owes its high ideal strength to the fact that rupture involves breaking links of attraction between molecules on either side of the plane on which \_\_\_\_\_ occurs; work must be done to break these links.

## Surface Tension

6. The surface of a liquid behaves, in fact, as if it were an elastic membrane under tension, except that the tension exerted by \_\_\_\_\_ increases when the membrane is stretched in a way that the tension exerted by a liquid surface does not.

## Friction

7. Which term is a force that opposes the relative lateral motion of two solid surfaces in contact?

## Kinetic Energy

8. Kinetic energy is converted to thermal energy whenever \_\_\_\_\_ occurs, for example when a viscous fluid is stirred.

**Fluid Friction (Drag)**

9. Fluid friction is affected by increased \_\_\_\_\_, and the modern streamline design of airplanes and automobiles is the result of engineers' efforts to minimize fluid friction while retaining speed and protecting structure.

**Drag Force**

10. Drag force is proportional to the velocity for a \_\_\_\_\_ and the squared velocity for a turbulent flow.

**Answers** 1. Hydrokinetics, 2. Viscosity, 3. Space and time, 4. Fast to settle down, 5. Rupture, 6. An elastic membrane, 7. Dry friction, 8. Motion with friction, 9. Velocities, 10. Laminar flow

## Fluid Mechanics and Hydraulic Principles References

- "Coefficients of Friction of Human Joints".
- "Friction Factors - Coefficients of Friction".
- "friction". Merriam-Webster Dictionary.
- "Leonhard Euler". Friction Module. Nano World. 2002.
- "SriLanka – History". Asian Studies Center, Michigan State University.
- "SriLanka-A Country study" (PDF). USA Government, Department of Army. 1990.
- "The Engineering Toolbox: Friction and Coefficients of Friction".
- "Ultra-low friction coefficient in alumina–silicon nitride pair lubricated with water". *Wear*. 296: 656–659. doi:10.1016/j.wear.2012.07.030.
- 1974-, Fu, Chunjiang,; Liping, Yang,; N., Han, Y.; Editorial., Asiapac (2006). *Origins of Chinese science and technology*. Asiapac. ISBN 9812293760. OCLC 71370433.
- Acary, V.; Brogliato, B. (2008). *Numerical Methods for Nonsmooth Dynamical Systems. Applications in Mechanics and Electronics*. 35. Springer Verlag Heidelberg.
- Acary, V.; Cadoux, F.; Lemaréchal, C.; Malick, J. (2011). "A formulation of the linear discrete Coulomb friction problem via convex optimization". *Journal of Applied Mathematics and Mechanics / Zeitschrift für Angewandte Mathematik und Mechanik*. 91 (2): 155–175. Bibcode:2011ZaMM...91..155A. doi:10.1002/zamm.201000073.
- Adams, G. G. (1995). "Self-excited oscillations of two elastic half-spaces sliding with a constant coefficient of friction". *Journal of Applied Mechanics*. 62: 867–872. Bibcode:1995JAM...62..867A. doi:10.1115/1.2896013.
- Air Brake Association (1921). *The Principles and Design of Foundation Brake Rigging*. Air brake association. p. 5.
- Alart, P.; Curnier, A. (1991). "A mixed formulation for frictional contact problems prone to Newton like solution method". *Computer Methods in Applied Mechanics and Engineering*. 92 (3): 353–375. Bibcode:1991CMAME..92..353A. doi:10.1016/0045-7825(91)90022-X.
- Armstrong-Hélouvy, Brian (1991). *Control of machines with friction*. USA: Springer. p. 10. ISBN 0-7923-9133-0.
- Beatty, William J. "Recurring science misconceptions in K-6 textbooks".
- Beer, Ferdinand P.; Johnston, E. Russel, Jr. (1996). *Vector Mechanics for Engineers (Sixth ed.)*. McGraw-Hill. p. 397. ISBN 0-07-297688-8.
- Bhavikatti, S. S.; K. G. Rajashekarappa (1994). *Engineering Mechanics*. New Age International. p. 112. ISBN 978-81-224-0617-7.
- Bigoni, D. *Nonlinear Solid Mechanics: Bifurcation Theory and Material Instability*. Cambridge University Press, 2012. ISBN 9781107025417.
- Bigoni, D.; Noselli, G. (2011). "Experimental evidence of flutter and divergence instabilities induced by dry friction". *Journal of the Mechanics and Physics of Solids*. 59 (10): 2208–2226. Bibcode:2011JMPSo..59.2208B. doi:10.1016/j.jmps.2011.05.007.
- Bird, David. *Pliny's Arrugia Water Mining in Roman Gold-Mining*. Papers Presented at the National Association of Mining History Organizations' Conference July 2002. Obtained from: [http://www.goldchartsrus.com/papers/PlinysArrugia-Centre, UNESCO World Heritage. "Las Médulas"](http://www.goldchartsrus.com/papers/PlinysArrugia-Centre, UNESCO World Heritage. ). whc.unesco.org. Retrieved 2017-06-13.
- Chatterjee, Sudipta (2008). *Tribological Properties of Pseudo-elastic Nickel-titanium (Thesis)*. University of California. pp. 11–12. ISBN 9780549844372 – via ProQuest. Classical Greek philosophers like Aristotle, Pliny the Elder and Vitruvius wrote about the existence of friction, the effect of lubricants and the advantages of metal bearings around 350 B.C.
- De Saxcé, G.; Feng, Z.-Q. (1998). "The bipotential method: A constructive approach to design the complete contact law with friction and improved numerical algorithms". *Mathematical and Computer Modelling*. 28 (4): 225–245. doi:10.1016/S0895-7177(98)00119-8.

Deng, Zhao; et al. (October 14, 2012). "Adhesion-dependent negative friction coefficient on chemically modified graphite at the nanoscale". *Nature*. 11: 1032–7. Bibcode:2012NatMa..11.1032D. doi:10.1038/nmat3452. PMID 23064494. Retrieved November 18, 2012. Lay summary – R&D Magazine (October 17, 2012).

Dienwiebel, Martin; et al. (2004). "Superlubricity of Graphite" (PDF). *Phys. Rev. Lett.* 92 (12): 126101. Bibcode:2004PhRvL..92I6101D. doi:10.1103/PhysRevLett.92.126101.

Dowson, Duncan (1997). *History of Tribology* (2nd ed.). Professional Engineering Publishing. ISBN 1-86058-070-X.

Einstein, A. (1909). On the development of our views concerning the nature and constitution of radiation. Translated in: *The Collected Papers of Albert Einstein*, vol. 2 (Princeton University Press, Princeton, 1989). Princeton, NJ: Princeton University Press. EngineersHandbook.com

Feynman, Richard P.; Leighton, Robert B.; Sands, Matthew (1964). "The Feynman Lectures on Physics, Vol. I, p. 12-5". Addison-Wesley.

Fishbane, Paul M.; Gasiorowicz, Stephen; Thornton, Stephen T. (1993). *Physics for Scientists and Engineers. I* (Extended ed.). Englewood Cliffs, New Jersey: Prentice Hall. p. 135. ISBN 0-13-663246-7. Themistius first stated around 350 B.C. [SIC] that kinetic friction is weaker than the maximum value of static friction.

Fleeming Jenkin & James Alfred Ewing (1877) "On Friction between Surfaces moving at Low Speeds", *Philosophical Magazine Series 5*, volume 4, pp 308–10; link from Biodiversity Heritage Library

Forest de Bélidor, Bernard. "Richtige Grund-Sätze der Friction-Berechnung" ("Correct Basics of Friction Calculation"), 1737, (in German)

Goeddecke, Andreas (2014). *Transient Effects in Friction: Fractal Asperity Creep*. Springer Science and Business Media. p. 3. ISBN 370911506X.

Greenwood J.A. and JB Williamson (1966). "Contact of nominally flat surfaces". *Proceedings of the Royal Society of London A: Mathematical, Physical and Engineering Sciences*. 295 (1442).

Hanaor, D.; Gan, Y.; Einav, I. (2016). "Static friction at fractal interfaces" (PDF). *Tribology International*. 93: 229–238.

Haslinger, J.; Nedlec, J.C. (1983). "Approximation of the Signorini problem with friction, obeying the Coulomb law". *Mathematical Methods in the Applied Sciences*. 5: 422–437. Bibcode:1983MMAS...5..422H. doi:10.1002/mma.1670050127.

Hecht, Eugene (2003). *Physics: Algebra/Trig* (3rd ed.). Cengage Learning. ISBN 9780534377298.

Hibbeler, R. C. (2007). *Engineering Mechanics* (Eleventh ed.). Pearson, Prentice Hall. p. 393. ISBN 0-13-127146-6.

Higdon, C.; Cook, B.; Harringa, J.; Russell, A.; Goldsmith, J.; Qu, J.; Blau, P. (2011). "Friction and wear mechanisms in AlMgB14-TiB2 nanocoatings". *Wear*. 271 (9–10): 2111–2115. doi:10.1016/j.wear.2010.11.044.  
<http://mechanicalemax.blogspot.com/2016/03/tribology-introduction.html>  
<http://www.industrialoutpost.com/human-circulatory-system-heart-modern-hydraulic>

Hutchings, Ian M. (2016). "Leonardo da Vinci's studies of friction" (PDF). doi:10.1016/j.wear.2016.04.019.

Hutchings, Ian M. (2016-08-15). "Leonardo da Vinci's studies of friction". *Wear*. 360–361: 51–66. doi:10.1016/j.wear.2016.04.019.

J., Flint; J., Hultén, (2002). "Lining-deformation-induced modal coupling as squeal generator in a distributed parameter disk brake model". *J. Sound and Vibration*. 254: 1–21. Bibcode:2002JSV...254....1F. doi:10.1006/jsvi.2001.4052.

Kirk, Tom (July 22, 2016). "Study reveals Leonardo da Vinci's 'irrelevant' scribbles mark the spot where he first recorded the laws of friction". *phys.org*.

Kleiner, Kurt (2008-11-21). "Material slicker than Teflon discovered by accident".

M, Nosonovsky,; G., Adams G. (2004). "Vibration and stability of frictional sliding of two elastic bodies with a wavy contact interface". *Journal of Applied Mechanics*. 71: 154–161. Bibcode:2004JAM....71..154N. doi:10.1115/1.1653684.

M., Kröger,; M., Neubauer,; K., Popp, (2008). "Experimental investigation on the avoidance of self-excited vibrations". *Phil. Trans. R. Soc. A*. 366 (1866): 785–810. Bibcode:2008RSPTA.366..785K. doi:10.1098/rsta.2007.2127. PMID 17947204.

Makkonen, L (2012). "A thermodynamic model of sliding friction". *AIP Advances*. 2: 012179. Bibcode:2012AIPA....2a2179M. doi:10.1063/1.3699027.

Martins, J.A., Faria, L.O. & Guimarães, J. (1995). "Dynamic surface solutions in linear elasticity and viscoelasticity with frictional boundary conditions". *Journal of Vibration and Acoustics*. 117: 445–451. doi:10.1115/1.2874477.

Meriam, J. L.; Kraige, L. G. (2002). *Engineering Mechanics* (fifth ed.). John Wiley & Sons. p. 328. ISBN 0-471-60293-0.

Meriam, James L.; Kraige, L. Glenn; Palm, William John (2002). *Engineering Mechanics: Statics*. Wiley and Sons. p. 330. ISBN 0-471-40646-5. Kinetic friction force is usually somewhat less than the maximum static friction force.

Museum, Victoria and Albert. "Catalogue of the mechanical engineering collection in the Science Division of the Victoria and Albert Museum, South Kensington, with descriptive and historical notes." Ulan Press. 2012.

Nichols, Edward Leamington; Franklin, William Suddards (1898). *The Elements of Physics*. 1. Macmillan. p. 101.

Nosonovsky, Michael (2013). *Friction-Induced Vibrations and Self-Organization: Mechanics and Non-Equilibrium Thermodynamics of Sliding Contact*. CRC Press. p. 333. ISBN 978-1466504011.

Persson, B. N. J. (2000). *Sliding friction: physical principles and applications*. Springer. ISBN 978-3-540-67192-3.

Persson, B. N.; Volokitin, A. I (2002). "Theory of rubber friction: Nonstationary sliding". *Physical Review B*. 65 (13): 134106. Bibcode:2002PhRvB..65m4106P. doi:10.1103/PhysRevB.65.134106.

R., Rice, J.; L., Ruina, A. (1983). "Stability of Steady Frictional Slipping" (PDF). *Journal of Applied Mechanics*. 50 (2): 343–349. Bibcode:1983JAM....50..343R. doi:10.1115/1.3167042.

ricardo (2014-10-30). "Las Médulas". *Castilla y León World Heritage UNESCO* (in Spanish).

Ruina, Andy; Pratap, Rudra (2002). *Introduction to Statics and Dynamics* (PDF). Oxford University Press. p. 713.

Sambursky, Samuel (2014). *The Physical World of Late Antiquity*. Princeton University Press. pp. 65–66. ISBN 9781400858989.

Sheppard, Sheri; Tongue, Benson H.; Anagnos, Thalia (2005). *Statics: Analysis and Design of Systems in Equilibrium*. Wiley and Sons. p. 618. ISBN 0-471-37299-4. In general, for given contacting surfaces

Simo, J.C.; Laursen, T.A. (1992). "An augmented lagrangian treatment of contact problems involving friction" *Computers and Structures*42 (2): 97–116. doi:10.5-7949(92)90540-G.

Soutas-Little, Robert W.; Inman, Balint (2008). *Engineering Mechanics*. Thomson. p. 329. ISBN 0-495-29610-4.

Ternes, Markus; Lutz, Christopher P.; Hirjibehedin, Cyrus F.; Giessibl, Franz J.; Heinrich, Andreas J. (2008-02-22). "The Force Needed to Move an Atom on a Surface". *Science*. 319 (5866): 1066–1069. Bibcode:2008Sci...319.1066T. doi:10.1126/science.1150288. PMID 18292336.

Tian, Y.; Bastawros, A. F.; Lo, C. C. H.; Constant, A. P.; Russell, A.M.; Cook, B. A. (2003). "Superhard self-lubricating AlMgB[sub 14] films for microelectromechanical devices". Applied Physics Letters. 83 (14): 2781. Bibcode:2003ApPhL..83.2781T. doi:10.1063/1.1615677.

Tomlinson, R. A. (2013). "The Perachora Waterworks: Addenda". The Annual of the British School at Athens. 71: 147–8. doi:10.1017/S0068245400005864. JSTOR 30103359.

Traditional SriLanka or Ceylon". Sam Houston State University.

van Beek, Anton. "History of Science Friction". tribology-abc.com. Retrieved 2011-03-24.



## Section 3 - Fluid/Hydraulic Forces & Pressures

**Section Focus:** You will learn advanced fluid mechanics and hydraulic principle theories. At the end of this section, you will be able to describe primary water mechanics and hydraulic theories and related components. There is a post quiz at the end of this section to review your comprehension and a final examination in the Assignment for your contact hours.

**Scope/Background:** In order to design hydraulic or water distribution systems or calculate pumping rates or flow rates, we need to master this area of engineering.

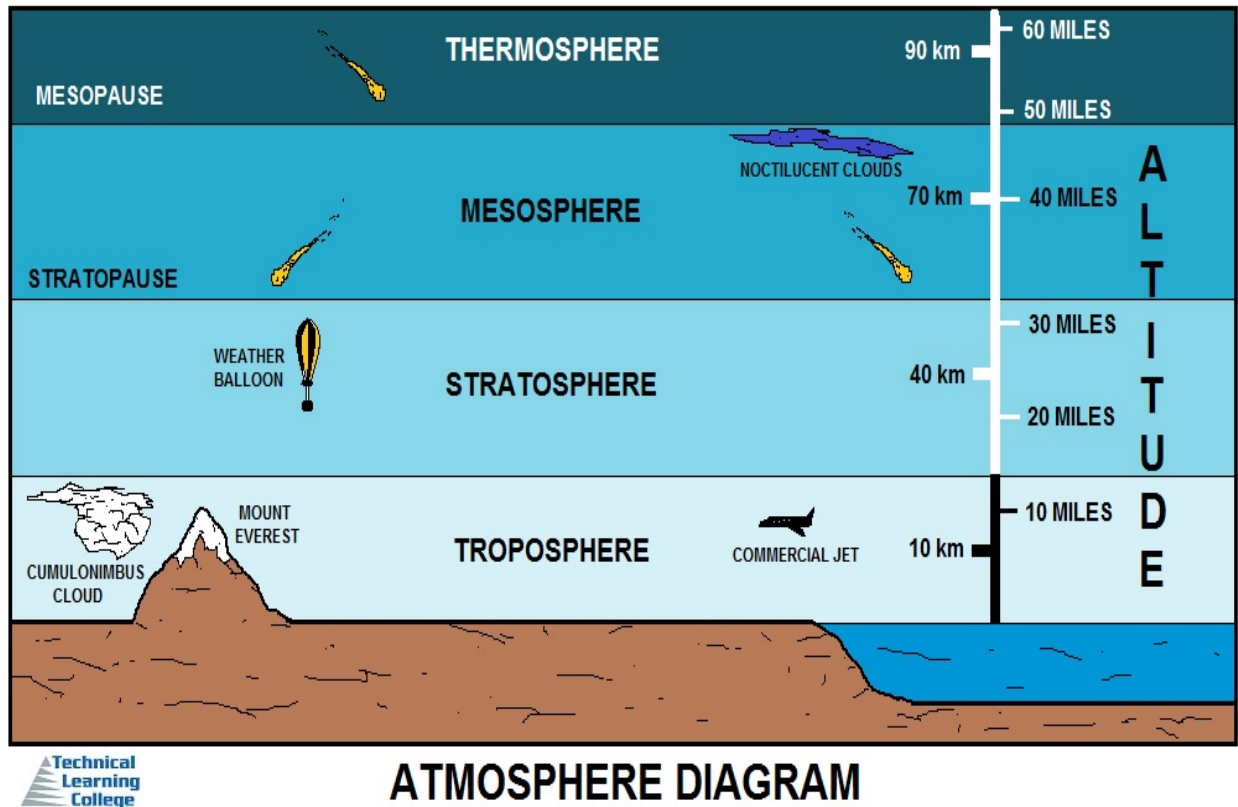

The actual pressure of the atmosphere on the Earth's surface -- at sea level it's always around 1 bar, or 14.7 pounds per square inch. The other is the proportion of this pressure attributable to water vapor in the air, or saturated vapor pressure, which rises or falls with water vapor levels.

Air pressure is ruled by Dalton's Law. John Dalton was the nineteenth century scientist who first stated that the total pressure of the air is the sum of the partial pressures of all of its components. These components include major and minor gases, water vapor and particulate matter -- tiny solid pieces, such as dust and smoke. The vast majority of pressure is contributed by nitrogen, which comprises around 78 percent of the Earth's atmosphere. Oxygen is second, at around 21 percent. Argon, which comes in third, makes up only 1 percent of the Earth's atmosphere. All other gases normally exist in proportions of less than 1 percent -- except for highly variable water vapor.

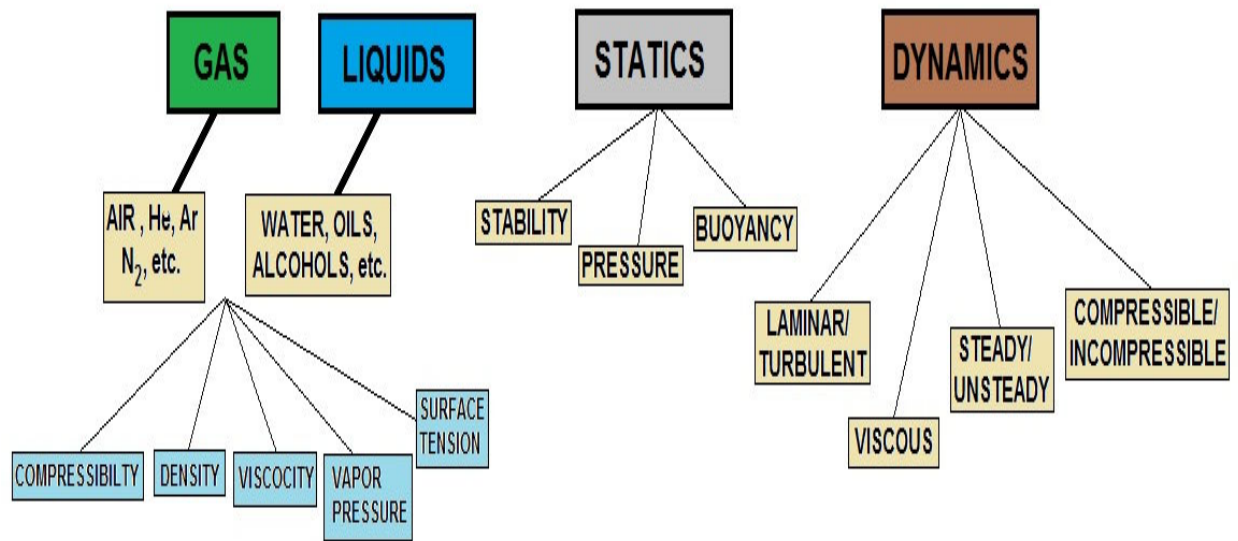

# FLUID MECHANICS OVERVIEW



## A Fluid

A fluid is a substance that may flow like water. Particles making up the fluid continuously change their positions relative to one another. Fluids do not offer any lasting resistance to the displacement of one layer over another when a shear force is applied. This means that if a fluid is at rest, then no shear forces can exist in it, which is different from solids; solids can resist shear forces while at rest. To summarize, if a shear force (like a moving impeller) is applied to a fluid it will cause flow.

# Fluid/Hydraulic Forces & Pressures Key Terms

## Atmospheric Pressure

Atmospheric pressure, sometimes also called barometric pressure, is the pressure exerted by the weight of air in the atmosphere of Earth (or that of another planet). In most circumstances atmospheric pressure is closely approximated by the hydrostatic pressure caused by the weight of air above the measurement point.

## ATM – Standard Atmosphere Pressure Unit

Standard Atmosphere is mainly used as a reference value for the average atmospheric pressure at sea level. It is often used to indicate the depth rating for a water resistant watch, but otherwise is rarely used as a unit for measuring pressure. 1 standard atmosphere is defined as being exactly equal to 101,325 pascals. Since the atmospheric pressure varies with changes in weather and altitude, it is convenient to standardize on a single value so that ratings, measurements and specifications can be compared. In particular, 1 Standard Atmosphere is used by the Aviation industry as the reference standard for sea level pressure.

## Barometric Loop

The barometric loop consists of a continuous section of supply piping that abruptly rises to a height of **approximately 33-35 feet** and then returns back down to the originating level. It is a loop in the piping system that effectively protects against back-siphonage. It may not be used to protect against back-pressure.

## Geometric Arguments

An input to a function: a variable that affects a functions result. Example: imagine a function that works out the height of a tree is:  $h(\text{year}) = 20 \times \text{year}$ , then "year" is an argument of the function "h".

## Liquids at Rest

**Fluid statics** or **hydrostatics** is the branch of fluid mechanics that studies fluids at rest. It encompasses the study of the conditions under which fluids are at rest in stable equilibrium as opposed to fluid dynamics, the study of fluids in motion. Hydrostatics are categorized as a part of the fluid statics, which is the study of all fluids, incompressible or not, at rest. Hydrostatics is fundamental to hydraulics, the engineering of equipment for storing, transporting and using fluids.

## Mean Sea Level Pressure

The mean sea level pressure (MSLP) is the average atmospheric pressure at sea level. This is the atmospheric pressure normally given in weather reports on radio, television, and newspapers or on the Internet. When barometers in the home are set to match the local weather reports, they measure pressure adjusted to sea level, not the actual local atmospheric pressure. The altimeter setting in aviation, is an atmospheric pressure adjustment. Average sea-level pressure is 1013.25 mbar (101.325 kPa; 29.921 inHg; 760.00 mmHg). In aviation weather reports (METAR), QNH is transmitted around the world in millibars or hectopascals (1 hectopascal = 1 millibar), except in the United States, Canada, and Colombia where it is reported in inches (to two decimal places) of mercury. The United States and Canada also report sea level pressure SLP, which is adjusted to sea level by a different method, in the remarks section, not in the internationally transmitted part of the code, in hectopascals or millibars. However, in Canada's public weather reports, sea level pressure is instead reported in kilopascals.

In the US weather code remarks, three digits are all that are transmitted; decimal points and the one or two most significant digits are omitted: 1013.2 mbar (101.32 kPa) is transmitted as 132; 1000.0 mbar (100.00 kPa) is transmitted as 000; 998.7 mbar is transmitted as 987; etc. The highest sea-level pressure on Earth occurs in Siberia, where the Siberian High often attains a sea-level pressure above 1050 mbar (105 kPa; 31 inHg), with record highs close to 1085 mbar (108.5 kPa; 32.0 inHg). The lowest measurable sea-level pressure is found at the centers of tropical cyclones and tornadoes, with a record low of 870 mbar (87 kPa; 26 inHg) (see Atmospheric pressure records).

### **Pressure**

Pressure is the force applied perpendicular to the surface of an object per unit area over which that force is distributed. Gauge pressure is the pressure relative to the ambient pressure. Various units are used to express pressure.

### **Standard Temperature and Pressure**

Standard temperature and pressure, abbreviated STP, refers to nominal conditions in the atmosphere at sea level. This value is important to physicists, chemists, engineers, and pilots and navigators.

Standard temperature is defined as zero degrees Celsius ( $0^{\circ}\text{C}$ ), which translates to 32 degrees Fahrenheit ( $32^{\circ}\text{F}$ ) or 273.15 degrees kelvin ( $273.15^{\circ}\text{K}$ ). This is essentially the freezing point of pure water at sea level, in air at standard pressure.

Standard pressure supports 760 millimeters in a mercurial barometer (760 mmHg). This is about 29.9 inches of mercury, and represents approximately 14.7 pounds per inch ( $14.7\text{ lb/in}^2$ ).

Imagine a column of air measuring one inch square, extending straight up into space beyond the atmosphere. The air in such a column would weigh about 14.7 pounds. The density of air at STP is approximately 1.29 kilogram per meter cubed ( $1.29\text{ kg/m}^3$ ). This fact comes as a surprise to many people; a cubic meter of air weighs nearly three pounds!

### **Vacuum**

Vacuum is space void of matter. The word stems from the Latin adjective *vacuus* for "vacant" or "void". An approximation to such vacuum is a region with a gaseous pressure much less than atmospheric pressure.

### **Water Pressure**

Water pressure is a term used to describe the flow strength of water through a pipe or other type of channel.

## Fluid/Hydraulic Forces & Pressures Introduction

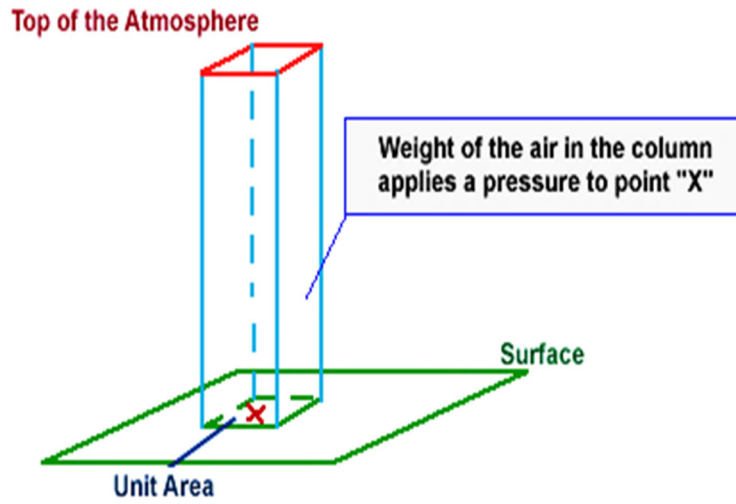

In the diagram, the pressure at point "X" increases as the weight of the air above it increases. The same can be said about decreasing pressure, where the pressure at point "X" decreases if the weight of the air above it also decreases.

### Atmospheric Pressure

The atmosphere is the entire mass of air that surrounds the earth. While it extends upward for about 300 miles, the section of primary interest is the portion that rests on the earth's surface and extends upward for about 7 1/2 miles. This layer is called the troposphere.

If a column of air 1-inch square extending all the way to the "**top**" of the atmosphere could be weighed, this column of air would weigh approximately 14.7 pounds at sea level. Thus, atmospheric pressure at sea level is approximately 14.7 psi.

As one ascends, the atmospheric pressure decreases by approximately 1.0 psi for every 2,343 feet. However, below sea level, in excavations and depressions, atmospheric pressure increases. Pressures under water differ from those under air because the weight of the water must be added to the pressure of the air.

Atmospheric pressure can be measured by any of several methods. The common laboratory method uses the mercury column barometer. The height of the mercury column serves as an indicator of atmospheric pressure. At sea level and at a temperature of 0° Celsius (**C**), the height of the mercury column is approximately 30 inches, or 76 centimeters. This represents a pressure of approximately 14.7 psi. The 30-inch column is used as a reference standard.

Another device used to measure atmospheric pressure is the aneroid barometer. The aneroid barometer uses the change in shape of an evacuated metal cell to measure variations in atmospheric pressure. The thin metal of the aneroid cell moves in or out with the variation of pressure on its external surface. This movement is transmitted through a system of levers to a pointer, which indicates the pressure.

The atmospheric pressure does not vary uniformly with altitude. It changes very rapidly. Atmospheric pressure is defined as the force per unit area exerted against a surface by the weight of the air above that surface.

### Fluid and Pressure

By a fluid, we have a material in mind like water or air, two very common and important fluids. Water is incompressible, while air is very compressible, but both are fluids. Water has a definite volume; air does not. Water and air have low viscosity; that is, layers of them slide very easily on one another, and they quickly change their shapes when disturbed by rapid flows. Other fluids, such as molasses, may have high viscosity and take a long time to come to equilibrium, but they are no less fluids. The coefficient of viscosity is the ratio of the shearing force to the velocity gradient. Hydrostatics deals with permanent, time-independent states of fluids, so viscosity does not appear.

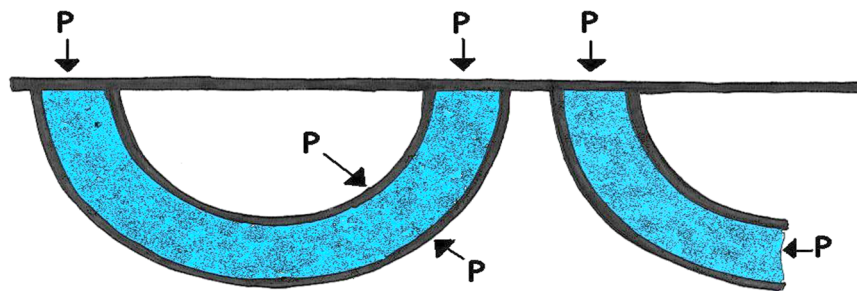

**EQUALITY OF PRESSURE –CURTIAN RINGS DIAGRAM**

### Pressure Definition

A fluid, therefore, is a substance that cannot exert any permanent forces tangential to a boundary. Any force that it exerts on a boundary must be normal perpendicular to the boundary. Such a force is proportional to the area on which it is exerted, and is called a pressure.

We can imagine any surface in a fluid as dividing the fluid into parts pressing on each other, as if it were a thin material membrane, and so think of the pressure at any point in the fluid, not just at the boundaries. In order for any small element of the fluid to be in equilibrium, the pressure must be the same in all directions (or the element would move in the direction of least pressure), and if no other forces are acting on the body of the fluid, the pressure must be the same at all neighboring points.

### Pascal's Principle

Therefore, in this case the pressure will be the same throughout the fluid, and the same in any direction at a point (Pascal's Principle). Pressure is expressed in units of force per unit area such as dyne/cm<sup>2</sup>, N/cm<sup>2</sup> (pascal), pounds/in<sup>2</sup> (psi) or pounds/ft<sup>2</sup> (psf). The axiom that if a certain volume of fluid were somehow made solid, the equilibrium of forces would not be disturbed, is useful in reasoning about forces in fluids.

### Equality of Pressure

On earth, fluids are also subject to the force of gravity, which acts vertically downward, and has a magnitude  $\gamma = \rho g$  per unit volume, where  $g$  is the acceleration of gravity, approximately 981 cm/s<sup>2</sup> or 32.15 ft/s<sup>2</sup>,  $\rho$  is the density, the mass per unit volume, expressed in g/cm<sup>3</sup>, kg/m<sup>3</sup>, or slug/ft<sup>3</sup>, and  $\gamma$  is the specific weight, measured in lb/in<sup>3</sup>, or lb/ft<sup>3</sup> (pcf).

## Atmospheric Pressure and its Effects

Suppose a vertical pipe is stood in a pool of water, and a vacuum pump applied to the upper end. Before we start the pump, the water levels outside and inside the pipe are equal, and the pressures on the surfaces are also equal and are equal to the atmospheric pressure.

Now start the pump. When it has sucked all the air out above the water, the pressure on the surface of the water inside the pipe is zero, and the pressure at the level of the water on the outside of the pipe is still the atmospheric pressure. There is the vapor pressure of the water to worry about if you want to be precise, but we neglect this complication in making our point.

A column of water 33.9 ft. high inside the pipe, with a vacuum above it, to balance the atmospheric pressure is required. If you were to do the same thing with liquid mercury, whose density at 0 °C is 13.5951 times that of water. The height of the column is 2.494 ft., 29.92 in, or 760.0 mm.

## Standard Atmospheric Pressure

This definition of the standard atmospheric pressure was established by Regnault back in the mid-19th century. In Great Britain, 30 in. Hg (inches of mercury) had been used previously. As a real-world matter, it is convenient to measure pressure differences by measuring the height of liquid columns, a practice known as manometry.

The barometer is a familiar example of this, and atmospheric pressures are traditionally given in terms of the length of a mercury column. To make a barometer, the barometric tube, closed at one end, is filled with mercury and then inverted and placed in a mercury reservoir.

Corrections must be made for temperature, because the density of mercury depends on the temperature, and the brass scale expands for capillarity if the tube is less than about 1 cm in diameter, and even slightly for altitude, since the value of  $g$  changes with altitude.

The vapor pressure of mercury is only 0.001201 mmHg at 20°C, so a correction from this source is negligible. For the usual case of a mercury column ( $\alpha = 0.000181792$  per °C) and a brass scale ( $\alpha = 0.0000184$  per °C) the temperature correction is -2.74 mm at 760 mm and 20°C.

Before reading the barometer scale, the mercury reservoir is raised or lowered until the surface of the mercury just touches a reference point, which is mirrored in the surface so it is easy to determine the proper position.

An aneroid barometer uses a partially evacuated chamber of thin metal that expands and contracts according to the external pressure. This movement is communicated to a needle that revolves in a dial. The materials and construction are arranged to give a low temperature coefficient. The instrument must be calibrated before use, and is usually arranged to read directly in elevations.

An aneroid barometer is much easier to use in field observations, such as in reconnaissance surveys. In a particular case, it would be read at the start of the day at the base camp, at various points in the vicinity, and then finally at the starting point, to determine the change in pressure with time.

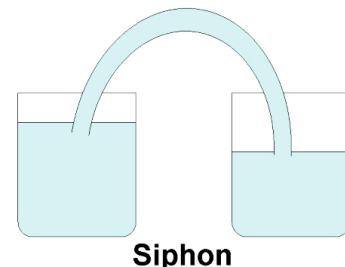

The height differences can be calculated from  $h = 60,360 \log (P/p) [1 + (T + t - 64)/986]$  feet, where P and p are in the same units, and T, t are in °F.

An absolute pressure is referring to a vacuum, while a gauge pressure is referring to the atmospheric pressure at the moment.

A negative gauge pressure is a partial vacuum. When a vacuum is stated to be so many inches, this means the pressure below the atmospheric pressure of about 30 in.

A vacuum of 25 inches is the same thing as an absolute pressure of 5 inches (of mercury).

## **Vacuum**

The term ***vacuum*** indicates that the absolute pressure is less than the atmospheric pressure and that the gauge pressure is negative.

A complete or total vacuum would mean a pressure of 0 psia or -14.7 psig.

Since it is impossible to produce a total vacuum, the term vacuum, as used in this document, will mean all degrees of partial vacuum.

In a partial vacuum, the pressure would range from slightly less than 14.7 psia (0 psig) to slightly greater than 0 psia (-14.7 psig).

Again, backsiphonage results from atmospheric pressure exerted on a liquid, forcing it toward a supply system that is under a vacuum.



## Barometric Loop

The barometric loop consists of a continuous section of supply piping that rises to a height of approximately 35 feet and then returns back down to the originating level. It is a loop in the piping system that effectively protects against backsiphonage. It may not be used to protect against backpressure. Backpressure refers to pressure opposed to the desired flow of a fluid in a confined place such as a pipe. It is often caused by obstructions or tight bends in the confinement vessel along which it is moving, such as piping or air vents.

The barometric loop's operation, in the protection against backsiphonage, is based upon the principle that a water column, at sea level pressure, will not rise above 33.9 feet.

Generally speaking, barometric loops are locally fabricated, and are 35 feet high.

Pressure may be referred to using an absolute scale, pounds per square inch absolute (psia), or gauge scale, (psig). Absolute pressure and gauge pressure are related.

Absolute pressure is equal to gauge pressure plus the atmospheric pressure.

At sea level, the atmospheric pressure is 14.7 psia.

Absolute pressure is the total pressure.

Gauge pressure is simply the pressure read on the gauge. If there is no pressure on the gauge other than atmospheric, the gauge will read zero. Then the absolute pressure would be equal to 14.7 psi, which is the atmospheric pressure.

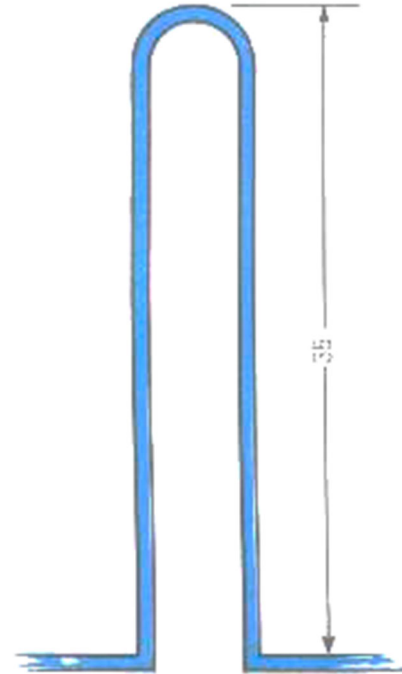

## Barometric Pressure

Generally speaking, barometric pressure, or atmospheric pressure, drops as you go up in elevation. For example, at 18,000 ft. above sea level, the average barometric pressure is about half the average pressure at sea level.

Barometric pressure also varies widely with the weather (weather charts almost always show the movement of low pressure and high pressure zones), so true barometric pressure cannot simply be calculated, but must be measured.

In the United States, the National Oceanic and Atmospheric Administration provides hourly barometric readings for many locations across the country.

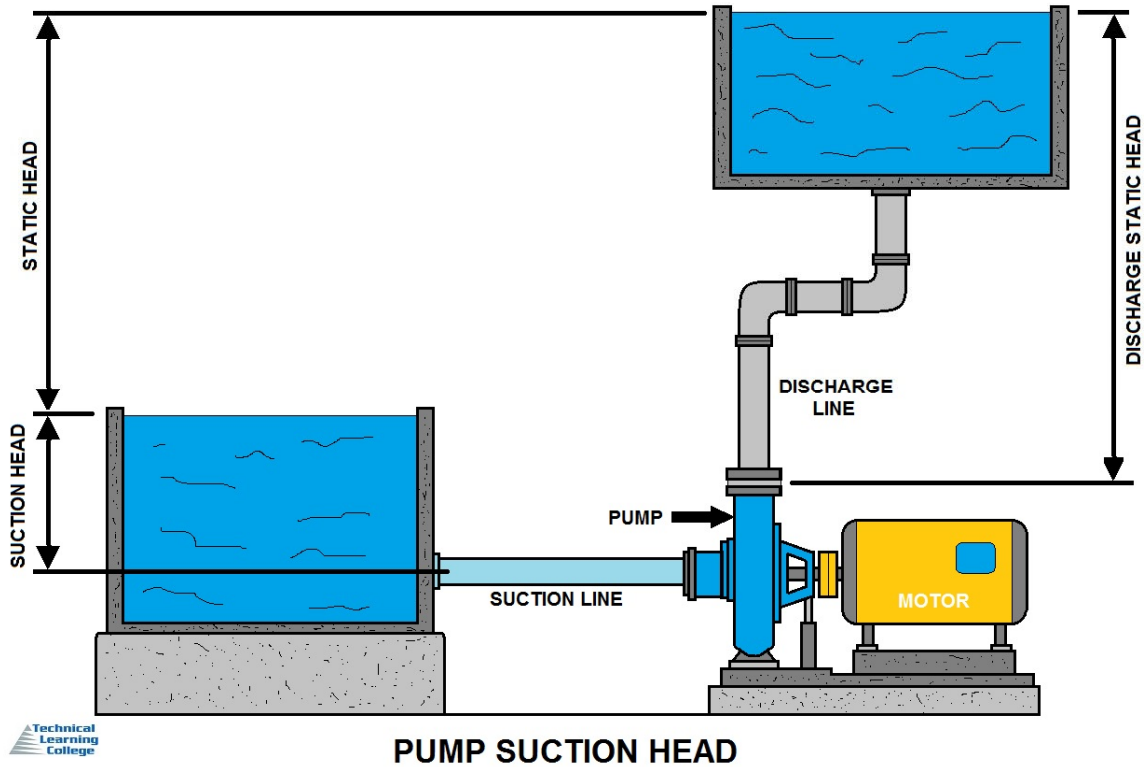

## Pump Suction Head

A **pump's suction head** is similar to its **pump head** except it is the opposite. Rather than being a measure of the maximum discharge, it is a measure of the maximum depth from which a **pump** can raise water via **suction**.

## Water Head Pressure

Water head pressure is static pressure caused by the weight of water solely due to its height above the measuring point. The pressure at the bottom of a 30-foot deep lake or a 30-foot high thin tube would be identical, since only height is involved.

The value may be expressed as pounds-per-square-inch (psi) or inches-of-water column pressure (in. W.C. or in.H<sub>2</sub>O), or metric. This basic calculation is widely used to solve many different practical problems involving water and other liquids of known density.

## Water Head Pressure Calculation

Divide the depth in inches by **27.71-inches/psi**, or the depth in feet by 2.31-feet/psi, which are the conversion factors. The result is the water head pressure expressed in psi.

We will cover this area (pressure) in more detail later in the course.

## Pressure Sub-Section

### Water Pressure

The weight of a cubic foot of water is 62.4 pounds per square foot. The base can be subdivided into 144-square inches with each subdivision being subjected to a pressure of 0.433 psig. Suppose you placed another cubic foot of water on top of the first cubic foot. The pressure on the top surface of the first cube which was originally atmospheric, or 0 psig, would now be 0.4333 psig as a result of the additional cubic foot of water. The pressure of the base of the first cubic foot would be increased by the same amount of 0.866 psig or two times the original pressure.

Pressures are very frequently stated in terms of the height of a fluid. If it is the same fluid whose pressure is being given, it is usually called "head," and the factor connecting the head and the pressure is the weight density  $\rho g$ .

In the English engineering system, weight density is in pounds per cubic inch or cubic foot.

A head of 10 ft is equivalent to a pressure of 624 psf, or 4.33 psi. It can also be considered an energy availability of ft-lb per lb.

Water with a pressure head of 10 ft can furnish the same energy as an equal amount of water raised by 10 ft. Water flowing in a pipe is subject to head loss because of friction.

Take a jar and a basin of water. Fill the jar with water and invert it under the water in the basin. Raise the jar as far as you can without allowing its mouth to come above the water surface. It is always a little surprising to see that the jar does not empty itself, but the water remains with no visible means of support.

By blowing through a straw, one can put air into the jar, and as much water leaves as air enters. In fact, this is a famous method of collecting insoluble gases in the chemical laboratory, or for supplying hummingbird feeders. It is good to remind oneself of exactly the balance of forces involved.

Another application of pressure is the siphon. The name is Greek for the tube that was used for pulling wine from a cask. This is a tube filled with fluid connecting two containers of fluid, normally rising higher than the water levels in the two containers, at least to pass over their rims.

In the diagram on the right side, the two water levels are the same, so there will be no flow. When a siphon goes below the free water levels, it is called an inverted siphon.

If the levels in the two basins are not equal, fluid flows from the basin with the higher level into the one with the lower level, until the levels are equal.

A siphon can be made by filling the tube, closing the ends, and then putting the ends under the surface on both sides.

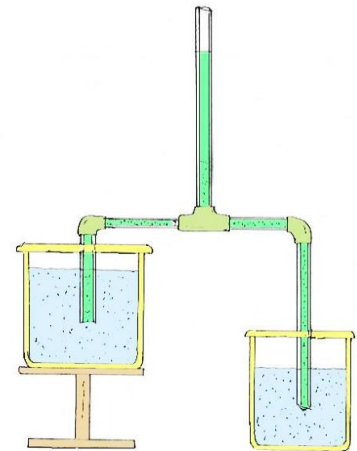

PASCAL'S SIPHON

Alternatively, the tube can be placed in one fluid and filled by sucking on it. When it is full, the other end is put in place.

The examination of the siphon is easy, and should be obvious. The pressure rises or falls as described by the barometric equation through the siphon tube.

There is obviously a maximum height for the siphon which is the same as the limit of the suction pump, about 34 feet. Inverted siphons are sometimes used in pipelines to cross valleys.

Differences in elevation are usually too great to use regular siphons to cross hills, so the fluids must be pressurized by pumps so the pressure does not fall to zero at the crests.

## Liquids at Rest

In studying fluids at rest, we are concerned with the transmission of force and the factors which affect the forces in liquids. Furthermore, pressure in and on liquids and factors affecting pressure are of great importance.

## Pressure and Force

Pressure is the force that pushes water through pipes. Water pressure determines the flow of water from the tap. If pressure is not sufficient then the flow can reduce to a trickle and it will take a long time to fill a kettle or a cistern.

The terms **force** and **pressure** are used extensively in the study of fluid power. It is essential that we distinguish between the terms.

Force means a total push or pull. It is the push or pull exerted against the total area of a particular surface and is expressed in pounds or grams.

Pressure means the amount of push or pull (force) applied to each unit area of the surface and is expressed in pounds per square inch (lb/in<sup>2</sup>) or grams per square centimeter (gm/cm<sup>2</sup>).

Pressure maybe exerted in one direction, in several directions, or in all directions.

## Other Pressure Terms and Conditions

Everyday pressure measurements, such as for vehicle tire pressure, are usually made relative to ambient air pressure. In other cases measurements are made relative to a vacuum or to some other specific reference. When distinguishing between these zero references, the following terms are used:

- **Absolute pressure** is zero-referenced against a perfect vacuum, using an absolute scale, so it is equal to gauge pressure plus atmospheric pressure.
- **Gauge pressure** is zero-referenced against ambient air pressure, so it is equal to absolute pressure minus atmospheric pressure. Negative signs are usually omitted. To distinguish a negative pressure, the value may be appended with the word "vacuum" or the gauge may be labeled a "vacuum gauge". These are further divided into two subcategories: high and low vacuum (and sometimes ultra-high vacuum). The applicable pressure ranges of many of the techniques used to measure vacuums have an overlap. Hence, by combining several different

types of gauge, it is possible to measure system pressure continuously from 10 mbar down to  $10^{-11}$  mbar.

- **Differential pressure** is the difference in pressure between two points.

For most working fluids where a fluid exists in a closed system, gauge pressure measurement prevails. Pressure instruments connected to the system will indicate pressures relative to the current atmospheric pressure. The situation changes when extreme vacuum pressures are measured, then absolute pressures are typically used instead.

Differential pressures are commonly used in industrial process systems. Differential pressure gauges have two inlet ports, each connected to one of the volumes whose pressure is to be monitored. In effect, such a gauge performs the mathematical operation of subtraction through mechanical means, obviating the need for an operator or control system to watch two separate gauges and determine the difference in readings.

Moderate vacuum pressure readings can be ambiguous without the proper context, as they may represent absolute pressure or gauge pressure without a negative sign. Thus a vacuum of 26 inHg gauge is equivalent to an absolute pressure of 4 inHg, calculated as 30 inHg (typical atmospheric pressure) – 26 inHg (gauge pressure).

Atmospheric pressure is typically about 100 kPa at sea level, but is variable with altitude and weather. If the absolute pressure of a fluid stays constant, the gauge pressure of the same fluid will vary as atmospheric pressure changes. For example, when a car drives up a mountain, the (gauge) tire pressure goes up because atmospheric pressure goes down. The absolute pressure in the tire is essentially unchanged.

Using atmospheric pressure as reference is usually signified by a "g" for gauge after the pressure unit, e.g. 70 psig, which means that the pressure measured is the total pressure minus atmospheric pressure. There are two types of gauge reference pressure: vented gauge (vg) and sealed gauge (sg).

### **Gravitation**

Gravitation is an example of a body force that disturbs the equality of pressure in a fluid. The presence of the gravitational body force causes the pressure to increase with depth, according to the equation  $dp = \rho g dh$ , in order to support the water above.

We call this relation the barometric equation, for when this equation is integrated, we find the variation of pressure with height or depth. If the fluid is incompressible, the equation can be integrated at once, and the pressure as a function of depth  $h$  is  $p = \rho gh + p_0$ .

The density of water is about  $1 \text{ g/cm}^3$ , or its specific weight is 62.4 pcf.

We may ask what depth of water gives the normal sea-level atmospheric pressure of 14.7 psi, or 2117 psf.

This is simply  $2117 / 62.4 = 33.9$  ft of water. This is the maximum height to which water can be raised by a suction pump, or, more correctly, can be supported by atmospheric pressure.

## Equality of Pressure

Professor James Thomson (brother of William Thomson, Lord Kelvin) illustrated the equality of pressure by a "curtain-ring" analogy shown in the diagram. A section of the toroid was identified, imagined to be solidified, and its equilibrium was analyzed.

The forces exerted on the curved surfaces have no component along the normal to a plane section, so the pressures at any two points of a plane must be equal, since the fluid represented by the curtain ring was in equilibrium.

The diagrams illustrates the equality of pressures in orthogonal directions. This can be extended to any direction whatever, so Pascal's Principle is established. This demonstration is similar to the usual one using a triangular prism and considering the forces on the end and lateral faces separately.

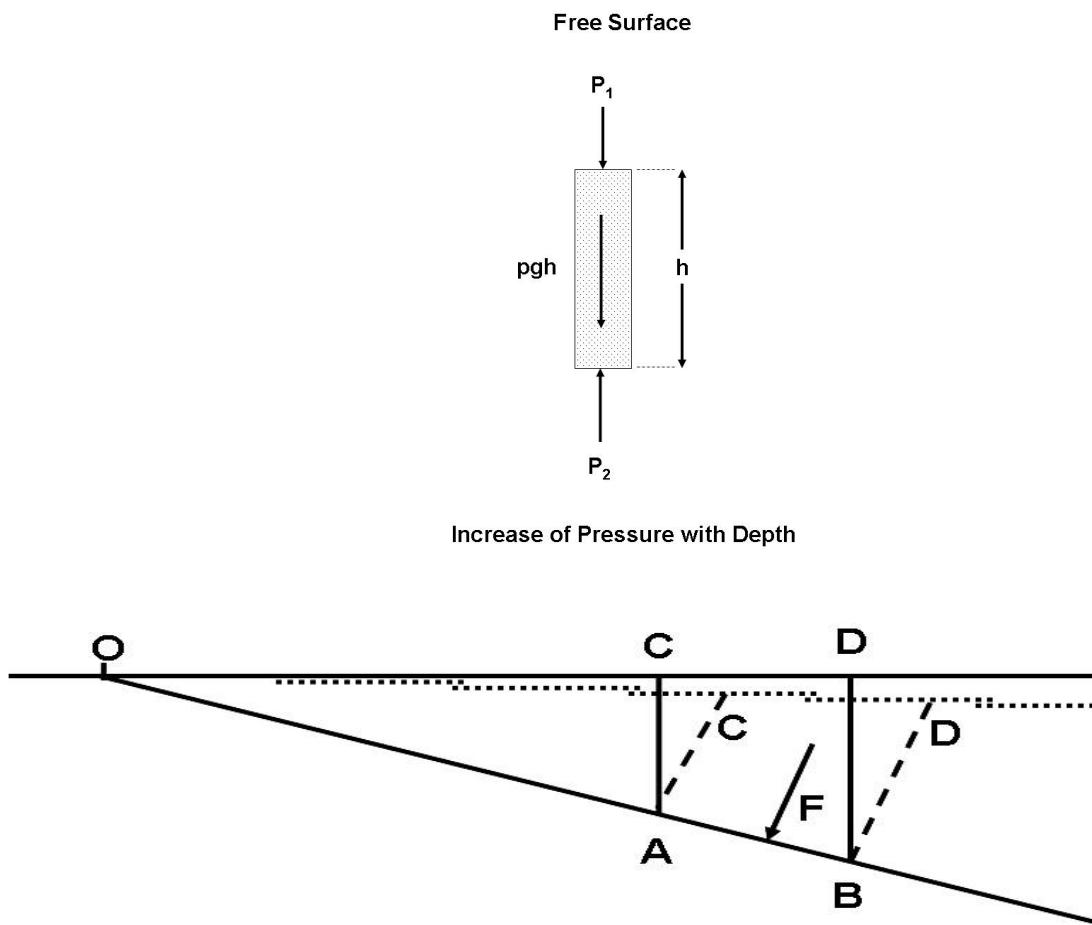

**THRUST ON A PLANE DIAGRAM**

## Free Surface Perpendicular to Gravity

With the action of gravity, a liquid assumes a free surface perpendicular to gravity, which can be proved by Thomson's method. A straight cylinder of unit cross-sectional area (assumed only for ease in the arithmetic) can be used to find the increase of pressure with depth. Definitely, we see that  $p_2 = p_1 + \rho gh$ .

The upper surface of the cylinder can be placed at the free surface if desired. The pressure is now the same in any direction at a point, but is greater at points that lie deeper.

From this calculation, it is easy to prove Archimedes' Principle that the buoyant force is equal to the weight of the displaced fluid, and passes through the center of mass of this displaced fluid.

## Geometric Arguments

Creative geometric arguments can be used to substitute for easier, but less transparent arguments using calculus.

One example, the force acting on one side of an inclined plane surface whose projection is AB can be found as in the diagram on the previous page.

O is the point at which the prolonged projection intersects the free surface.

The line AC' perpendicular to the plane is made equal to the depth AC of point A, and line BD' is similarly drawn equal to BD.

The line OD' also passes through C', by proportionality of triangles OAC' and OAD'.

Therefore, the thrust F on the plane is the weight of a prism of fluid of cross-section AC'D'B, passing through its centroid normal to plane AB.

Note that the thrust is equal to the density times the area times the depth of the center of the area; its line of action does not pass through the center, but below it, at the center of thrust.

The same result can be obtained with calculus by summing the pressures and the moments.

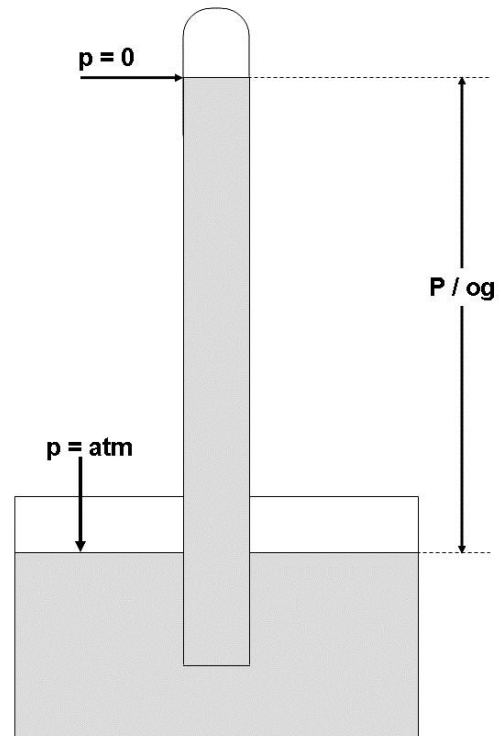

## Computing Force, Pressure, and Area

A formula is used in computing force, pressure, and area in fluid power systems. In this formula, P refers to pressure, F indicates force, and A represents area. Force equals pressure times area.

Therefore, the formula is written:

$$\text{PRESSURE} = \frac{\text{FORCE}}{\text{AREA}}$$
$$\text{AREA} = \frac{\text{FORCE}}{\text{PRESSURE}}$$
$$\text{FORCE} = \text{AREA} \times \text{PRESSURE}$$

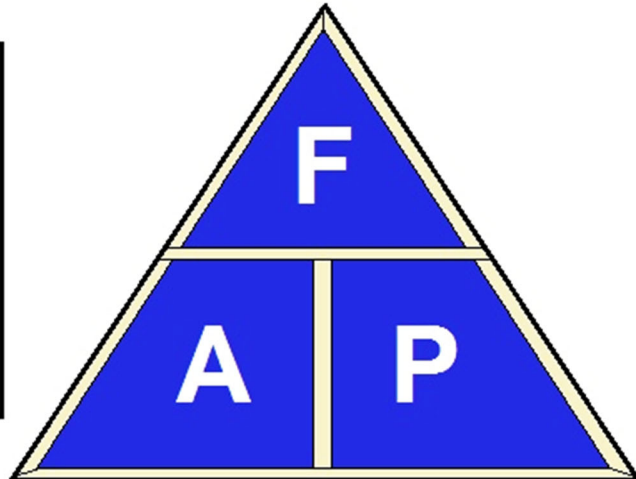

### FORMULAS TO CALCULATE FORCE, AREA & PRESSURE





## Hydraulic Gradient

The hydraulic gradient is a **vector gradient between two or more hydraulic head measurements over the length of the flow path**. For groundwater, it is also called the 'Darcy slope', since it determines the quantity of a Darcy flux or discharge.

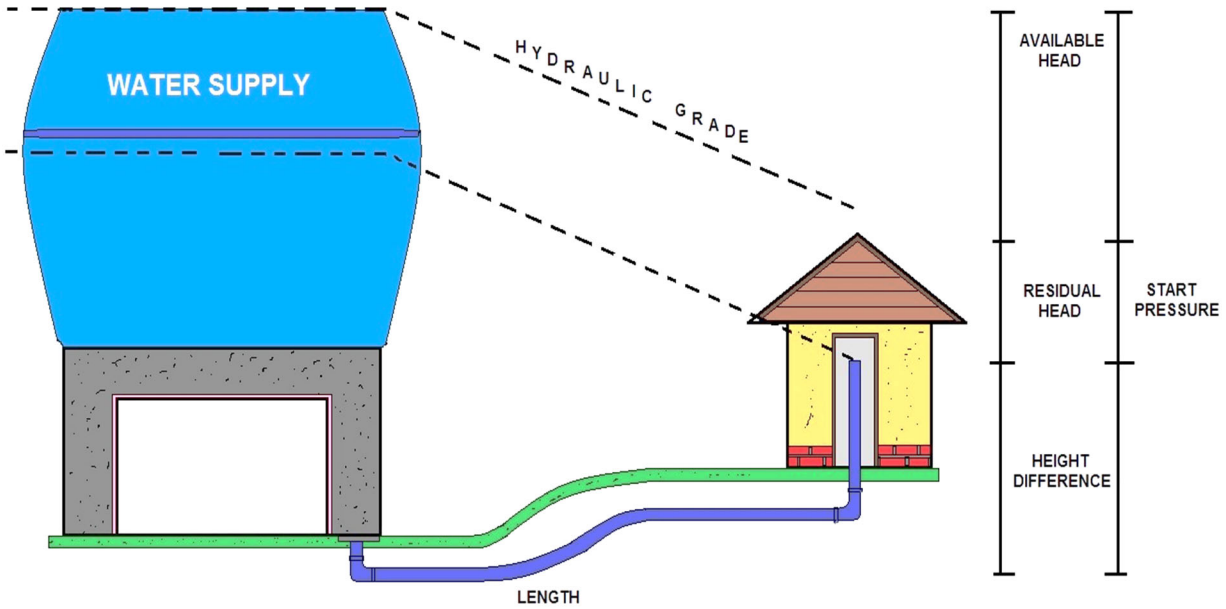

## HYDRAULIC GRADIENT

### What is Static Pressure?

Static pressure is the **pressure when water is motionless**. In a closed level piping system, the static pressure is the same at every point. There are two ways to create static pressure, by elevating water in tanks and reservoirs above where the water is needed and by utilizing a pump.

### Quick Definitions

#### Water Pressure

The **force of water pushing on a unit area**, usually measured in pounds per square inch (psi).

#### Static Water Pressure

Water pressure, measured in psi, at the service line when there is not any water running.

#### Residual Water Pressure

Water pressure at the service line when faucets are running.

## A Pressure of 1 atm can also be Stated as:

- ≡ 1.01325 bar
- ≡ 101325 pascal (Pa) or 101.325 kilopascal (kPa)
- ≡ 1013.25 millibars (mbar, also mb)
- ≡ 760 torr
- ≈ 760.001 mm-Hg, 0 °C, subject to revision as more precise measurements of mercury's density become available
- ≈ 29.9213 in-Hg, 0 °C, subject to revision as more precise measurements of mercury's density become available
- ≈ 1.033 227 452 799 886 kgf/cm<sup>2</sup>
- ≈ 1.033 227 452 799 886 technical atmosphere
- ≈ 1033.227 452 799 886 cm-H<sub>2</sub>O, 4 °C
- ≈ 406.782 461 732 2385 in-H<sub>2</sub>O, 4 °C
- ≈ 14.695 948 775 5134 pounds-force per square inch (psi)
- ≈ 2116.216 623 673 94 pounds-force per square foot (psf)
- = 1 ata (atmosphere absolute).

The ata unit is used in place of atm to indicate that the pressure shown is the total ambient pressure, compared to vacuum, of the system being calculated or measured. For example, for underwater pressures, a pressure of 3.1 ata would mean that the 1 atm of the air above water is included in this value and the pressure due to water would total 2.1 atm.

### Notes:

1. Torr and mm-Hg, 0°C are often taken to be identical. For most practical purposes (to 5 significant digits), they are interchangeable.
2. This is the customarily accepted value for cm-H<sub>2</sub>O, 4 °C. It is precisely the product of 1 kg-force per square centimeter (one technical atmosphere) times 1.013 25 (bar/atmosphere) divided by 0.980 665 (one gram-force). It is not accepted practice to define the value for water column based on a true physical realization of water (which would be 99.997 495% of this value because the true maximum density of Vienna Standard Mean Ocean Water is 0.999 974 95 kg/l at 3.984 °C). Also, this "physical realization" would *still* ignore the 8.285 cm-H<sub>2</sub>O reduction that would actually occur in a true physical realization due to the vapor pressure over water at 3.984 °C.
3. NIST value of 13.595 078(5) g/ml assumed for the density of Hg at 0 °C

## Fluid/Hydraulic Forces & Pressures Post Quiz

### Barometric Loop

1. Its operation, in the protection against backsiphonage, is based upon the principle that a water column, at sea level pressure, will not rise above \_\_\_\_\_ feet.
2. Absolute pressure is the \_\_\_\_\_ pressure.
3. Which term is an example of a body force that disturbs the equality of pressure in a fluid?

### Standard Atmospheric Pressure

4. An absolute pressure is referring to a vacuum, while a \_\_\_\_\_ pressure is referring to the atmospheric pressure at the moment.

### Vacuum

5. A complete or total vacuum would mean a pressure of 0 psia or \_\_\_\_\_ psig.

### Water Pressure

6. The weight of a cubic foot of water is \_\_\_\_\_ pounds per square foot.

### Pressure and Force

7. Pressure is the \_\_\_\_\_ that pushes water through pipes. Water pressure determines the flow of water from the tap.
8. Which term means a total push or pull?
9. Pressure means the amount of push or pull (force) applied to each unit area of the \_\_\_\_\_ and is expressed in pounds per square inch ( $\text{lb/in}^2$ ) or grams per square centimeter ( $\text{gm/cm}^2$ ).
10. Which term maybe exerted in one direction, in several directions, or in all directions?

**Answers** 1. 33.9, 2. Total, 3. Gravitation, 4. Gauge, 5. -14.7, 6. 62.4, 7. Force, 8. Force, 9. Surface, 10. Pressure

## Fluid/Hydraulic Forces & Pressures References

- "Fermions & Bosons". The Particle Adventure.
- "Introduction to Free Body Diagrams". Physics Tutorial Menu. University of Guelph. Archived from the original on 2008-01-16.
- "Powerful New Black Hole Probe Arrives at Paranal".
- "Seminar: Visualizing Special Relativity". The Relativistic Raytracer.
- "Sir Isaac Newton: The Universal Law of Gravitation". Astronomy 161 The Solar System. Retrieved 2008-01-04.
- "Standard model of particles and interactions". Contemporary Physics Education Project. 2000. Retrieved 2 January 2017.
- "Static Equilibrium". Physics Static Equilibrium (forces and torques). University of the Virgin Islands. Archived from the original on October 19, 2007. Retrieved 2008-01-02.
- "Tension Force". Non-Calculus Based Physics I.
- A quick derivation relating altitude to air pressure Archived 2011-09-28 at the Wayback Machine. by Portland State Aerospace Society, 2004, accessed 05032011
- Berberan-Santos, M. N.; Bodunov, E. N.; Pogliani, L. (1997). "On the barometric formula". *American Journal of Physics*. 65 (5): 404–412. Bibcode:1997AmJPh..65..404B. doi:10.1119/1.18555.
- BIPM Definition of the standard atmosphere
- C. Hellingman (1992). "Newton's third law revisited". *Phys. Educ.* 27 (2): 112–115. Bibcode:1992PhyEd.27..112H. doi:10.1088/0031-9120/27/2/011. Quoting Newton in the Principia: It is not one action by which the Sun attracts Jupiter, and another by which Jupiter attracts the Sun; but it is one action by which the Sun and Jupiter mutually endeavor to come nearer together.
- Chris Landsea (2010-04-21). "Subject: E1), Which is the most intense tropical cyclone on record?". Atlantic Oceanographic and Meteorological Laboratory. Archived from the original on 6 December 2010. Retrieved 2010-11-23.
- Cook, A. H. (1965). "A New Absolute Determination of the Acceleration due to Gravity at the National Physical Laboratory". *Nature*. 208 (5007): 279. Bibcode:1965Natur.208..279C. doi:10.1038/208279a0.
- Coulomb, Charles (1784). "Recherches théoriques et expérimentales sur la force de torsion et sur l'élasticité des fils de metal". *Histoire de l'Académie Royale des Sciences*: 229–269. Cutnell & Johnson 2003
- Davis, Doug. "Conservation of Energy". General physics. Retrieved 2008-01-04.
- Dr. Nikitin (2007). "Dynamics of translational motion". Retrieved 2008-01-04.
- Drake, Stillman (1978). *Galileo At Work*. Chicago: University of Chicago Press. ISBN 0-226-16226-5
- Duffin, William (1980). *Electricity and Magnetism*, 3rd Ed. McGraw-Hill. pp. 364–383. ISBN 0-07-084111-X.
- Feynman volume 1- Feynman volume 2
- Fitzpatrick, Richard (2006-02-02). "Strings, pulleys, and inclines".
- Fitzpatrick, Richard (2007-01-07). "Newton's third law of motion".
- Heath, T.L. "The Works of Archimedes (1897). The unabridged work in PDF form (19 MB)". Internet Archive. Retrieved 2007-10-14.
- Henderson, Tom (2004). "The Physics Classroom". The Physics Classroom and Mathsoft Engineering & Education, Inc. Archived from the original on 2008-01-01.

Hetherington, Norriss S. (1993). *Cosmology: Historical, Literary, Philosophical, Religious, and Scientific Perspectives*. Garland Reference Library of the Humanities. p. 100. ISBN 0-8153-1085-4.

Hewitt, Rachel, *Map of a Nation – a Biography of the Ordnance Survey* ISBN 1-84708-098-7

Hibbeler, Russell C. (2010). *Engineering Mechanics*, 12th edition. Pearson Prentice Hall. p. 222. ISBN 0-13-607791-9.

High Altitude Cooking, Crisco.com, 2010-09-30.

Howland, R. A. (2006). *Intermediate dynamics a linear algebraic approach* (Online-Ausg. ed.). New York: Springer. pp. 255–256. ISBN 9780387280592.

International Civil Aviation Organization. *Manual of the ICAO Standard Atmosphere, Doc 7488-CD, Third Edition, 1993*. ISBN 92-9194-004-6.

IUPAC.org, Gold Book, Standard Pressure

Jammer, Max (1999). *Concepts of force: a study in the foundations of dynamics* (Facsim. ed.). Mineola, N.Y.: Dover Publications. pp. 220–222. ISBN 9780486406893.

Kleppner & Kolenkow 2010

Kollerstrom, Nick (2001). "Neptune's Discovery. The British Case for Co-Prediction". University College London. Archived from the original on 2005-11-11. Retrieved 2007-03-19.

Kramer, MR; Springer C; Berkman N; Glazer M; Bublil M; Bar-Yishay E; Godfrey S (March 1998). "Rehabilitation of hypoxemic patients with COPD at low altitude at the Dead Sea, the lowest place on earth" (PDF). *Chest*. 113 (3): 571–575. doi:10.1378/chest.113.3.571. PMID 9515826. Archived from the original (PDF) on 2013-10-29. PMID 9515826

Lang, Helen S. (1998). *The order of nature in Aristotle's physics: place and the elements* (1. publ. ed.). Cambridge: Cambridge Univ. Press. ISBN 9780521624534.

Mallette, Vincent (1982–2008). "Inwit Publishing, Inc. and Inwit, LLC – Writings, Links and Montreal Current Weather, CBC Montreal, Canada.

Nave, C. R. (2014). "Force". *Hyperphysics*. Dept. of Physics and Astronomy, Georgia State University.

Nave, Carl Rod. "Centripetal Force". *HyperPhysics*. University of Guelph.

Nave, Carl Rod. "Elasticity". *HyperPhysics*. University of Guelph.

Nave, Carl Rod. "Newton's 2nd Law: Rotation". *HyperPhysics*. University of Guelph.

Nave, Carl Rod. "Pauli Exclusion Principle". *HyperPhysics*. University of Guelph. Retrieved 2013-10-28.

Newton, Isaac (1999). *The Principia Mathematical Principles of Natural Philosophy*. Berkeley: University of California Press. ISBN 0-520-08817-4. This is a recent translation into English by I. Bernard Cohen and Anne Whitman, with help from Julia Budenz.

Noll, Walter (April 2007). "On the Concept of Force" (pdf). Carnegie Mellon University. Retrieved 28 October 2013.

One exception to this rule is: Landau, L. D.; Akhiezer, A. I.; Lifshitz, A. M. (196). *General Physics; mechanics and molecular physics* (First English ed.). Oxford: Pergamon Press. ISBN 0-08-003304-0. Translated by: J. B. Sykes, A. D. Petford, and C. L. Petford. Library of Congress Catalog Number 67-30260. In section 7, pages 12–14, this book defines force as  $dp/dt$ .

Sample METAR of CYVR Nav Canada

Scharf, Toralf (2007). *Polarized light in liquid crystals and polymers*. John Wiley and Sons. p. 19. ISBN 0-471-74064-0. , Chapter 2, p. 19

Shifman, Mikhail (1999). *ITEP lectures on particle physics and field theory*. World Scientific. ISBN 981-02-2639-X.

Siegel, Ethan (20 May 2016). "When Did Isaac Newton Finally Fail?". *Forbes*. Retrieved 3 January 2017.

Singh, Sunil Kumar (2007-08-25). "Conservative force". *Connexions*. Retrieved 2008-01-04.

Software Distributions – The Coriolis Force". Publications in Science and Mathematics, Computing and the Humanities. Inwit Publishing, Inc. Retrieved 2008-01-04.

Stevens, Tab (10 July 2003). "Quantum-Chromodynamics: A Definition – Science Articles". The Science Realm: John's Virtual Sci-Tech Universe.

Young, Hugh; Freedman, Roger; Sears, Francis and Zemansky, Mark (1949) University Physics. Pearson Education. pp. 59–82

University Physics, Sears, Young & Zemansky, pp.18–38

Vapour Pressure, Hyperphysics.phy-astr.gsu.edu.

Wandmacher, Cornelius; Johnson, Arnold (1995). Metric Units in Engineering. ASCE Publications. p. 15. ISBN 0-7844-0070-9.

Watkins, Thayer. "Perturbation Analysis, Regular and Singular". Department of Economics. San José State University.

Weinberg, S. (1994). Dreams of a Final Theory. Vintage Books USA. ISBN 0-679-74408-8.

Wilson, John B. "Four-Vectors (4-Vectors) of Special Relativity: A Study of Elegant Physics". World: Highest Sea Level Air Pressure Above 750 m, Wmo.asu.edu, 2001-12-19.

World: Highest Sea Level Air Pressure Below 750 m, Wmo.asu.edu, 1968-12-31.





## Section 4 – Experiments and Early Applications

**Section Focus:** You will learn the history of hydraulic principle theories and pumps. At the end of this section, you will be able to describe simple hydraulic theories and the start of modern pumping principles. There is a post quiz at the end of this section to review your comprehension and a final examination in the Assignment for your contact hours.

**Scope/Background:** You will be able to explain various and commonly found water/fluid mechanic related components and principles. In order to understand how pumps operate or to manufacture a simple pump or to calculate pumping rates or flow rates, we need to master this area of engineering.

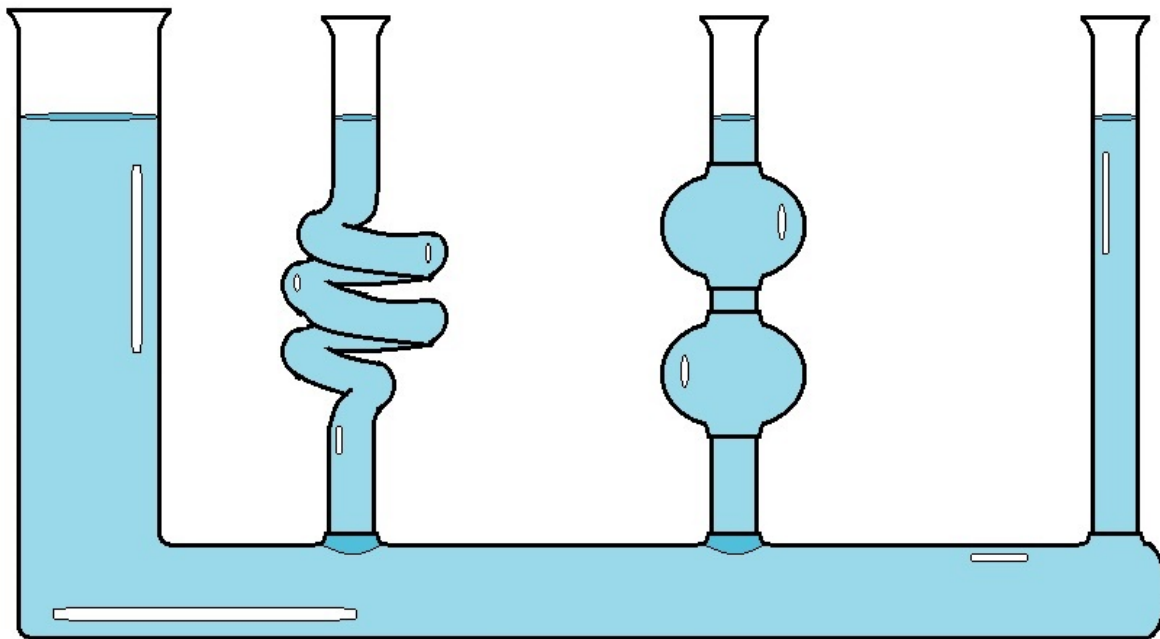

### PRESSURE IN LIQUIDS

PASCAL'S VASES DEMONSTRATE THE FACT THAT THE PRESSURE OF THE LIQUID DEPENDS SOLELY ON THE DEPTH ALONE, AND NOT THE VOLUME OR THE SHAPE OF THE FLUID



### Pascal's Vases

A liquid in a number of different shaped communicating vessels will find the same level in each. The pressure at the bottom of the fluid depends upon the depth of the fluid and not on the shape of the container. The apparatus consists of a group of glass flasks of assorted shape (see *above diagram*) linked at their base by a communal reservoir. With the pressure being dependent on the depth of liquid only, an equilibrium situation must have the surface level in each vase equal. This proves pressure depends on depth only and not on the shape of the vessel. The reservoir on the right is adjusted for the same level of fluid in each "vase", and the gauge reads the corresponding pressure.

## Early Hydraulic Foundations

*Many of these devices or methods are still in use today.*



Ancient public toilet with running water.

### **Ancient Rome**

In Ancient Rome, many different hydraulic applications were developed, including public water supplies, innumerable aqueducts, power using watermills and hydraulic mining. They were among the first to make use of the siphon to carry water across valleys, and used hushing on a large scale to prospect for and then extract metal ores. They used lead widely in plumbing systems for domestic and public supply, such as feeding thermae.

Hydraulic mining was used in the gold-fields of northern Spain, which was conquered by Augustus in 25 BC. The alluvial gold-mine of Las Medulas was one of the largest of their mines. It was worked by at least 7 long aqueducts, and the water streams were used to erode the soft deposits, and then wash the tailings for the valuable gold content.

### **Ancient Greek**

The Greeks constructed sophisticated water and hydraulic power systems. An example is the construction by Eupalinos, under a public contract, of a watering channel for Samos, the Tunnel of Eupalinos. An early example of the usage of hydraulic wheel, probably the earliest in Europe, is the Perachora wheel (3rd century BC).

The construction of the first hydraulic automata by Ctesibius (flourished c. 270 BC) and Hero of Alexandria (c. 10 – 80 AD) is notable. Hero describes a number of working machines using hydraulic power, such as the force pump, which is known from many Roman sites as having been used for raising water and in fire engines.

## Experiments and Early Applications Key Terms

### Archimedes' Principle

Archimedes' principle indicates that the upward buoyant force that is exerted on a body immersed in a fluid, whether fully or partially submerged, is equal to the weight of the fluid that the body displaces and it acts in the upward direction at the center of mass of the displaced fluid. Archimedes' principle is a law of physics fundamental to fluid mechanics.

### Buoyancy

In physics, **buoyancy** or **upthrust**, is an upward force exerted by a fluid that opposes the weight of an immersed object. In a column of fluid, pressure increases with depth as a result of the weight of the overlying fluid. Thus the pressure at the bottom of a column of fluid is greater than at the top of the column. Similarly, the pressure at the bottom of an object submerged in a fluid is greater than at the top of the object. This pressure difference results in a net upwards force on the object. The magnitude of that force exerted is proportional to that pressure difference, and (as explained by Archimedes' principle) is equivalent to the weight of the fluid that would otherwise occupy the volume of the object, i.e. the displaced fluid.

### Coriolis Force

An effect whereby a mass moving in a rotating system experiences a force (the Coriolis force) acting perpendicular to the direction of motion and to the axis of rotation. On the earth, the effect tends to deflect moving objects to the right in the northern hemisphere and to the left in the southern and is important in the formation of cyclonic weather systems.

### Electrolysis

In chemistry and manufacturing, electrolysis is a technique that uses a direct electric current (DC) to drive an otherwise non-spontaneous chemical reaction. Electrolysis is commercially important as a stage in the separation of elements from naturally occurring sources such as ores using an electrolytic cell.

### Galileo's Thermometer

A Galileo thermometer (or Galilean thermometer) is a thermometer made of a sealed glass cylinder containing a clear liquid and several glass vessels of varying densities. As the temperature changes, the individual floats rise or fall in proportion to their respective density.

### Hydrometer

A hydrometer is an instrument that measures the specific gravity (relative density) of liquids—the ratio of the density of the liquid to the density of water. A hydrometer is usually made of glass, and consists of a cylindrical stem and a bulb weighted with mercury or lead shot to make it float upright.

### Hydrostatic Paradox

The hydrostatic paradox arises from our failure to accept, at first sight, the conclusion published by Blaise Pascal in 1663: the pressure at a certain level in a fluid is proportional to the *vertical* distance to the surface of the liquid.

## Isobar(s)

**Isobar** may refer to:

- Isobar (meteorology), a line connecting points of equal atmospheric pressure
- Isobaric process, a process taking place at constant pressure
- Isobar (nuclide), one of multiple nuclides with the same mass but with different numbers of protons (or, equivalently, different numbers of neutrons).

## Meteorology

Meteorology is a branch of the atmospheric sciences which includes atmospheric chemistry and atmospheric physics, with a major focus on weather forecasting. The study of meteorology dates back millennia, though significant progress in meteorology did not occur until the 18th century. The 19th century saw modest progress in the field after weather observation networks were formed across broad regions. Prior attempts at prediction of weather depended on historical data. It wasn't until after the elucidation of the laws of physics and, more particularly, the development of the computer, allowing for the automated solution of a great many equations that model the weather, in the latter half of the 20th century that significant breakthroughs in weather forecasting were achieved.

## Pycnometer

A standard container of accurately defined volume used to determine the relative density of liquids and solids.

## Specific Gravity

Specific gravity is the ratio of the density of a substance to the density of a reference substance; equivalently, it is the ratio of the mass of a substance to the mass of a reference substance for the same given volume. Apparent specific gravity is the ratio of the weight of a volume of the substance to the weight of an equal volume of the reference substance.

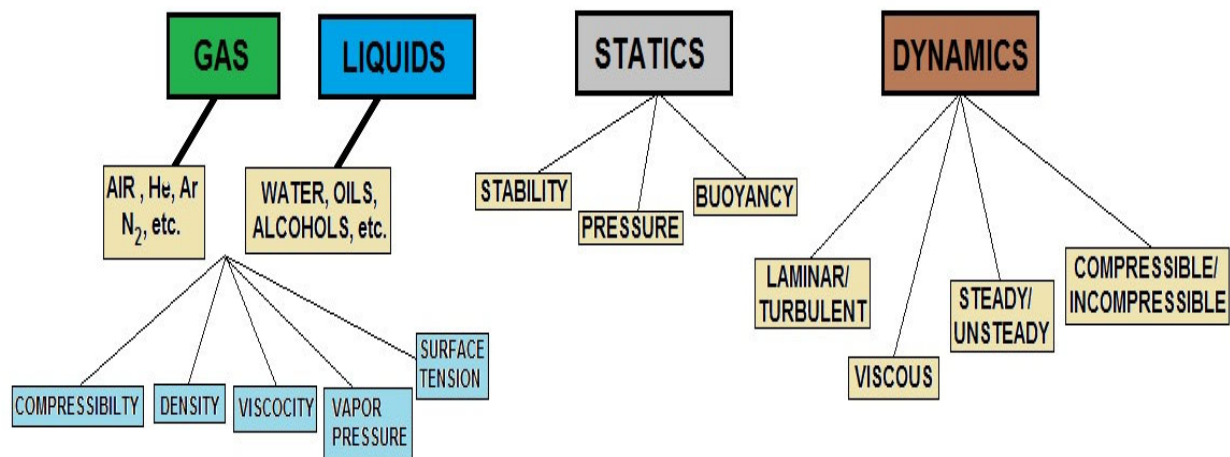

# FLUID MECHANICS OVERVIEW



## Modern Applications of Ancient Technology

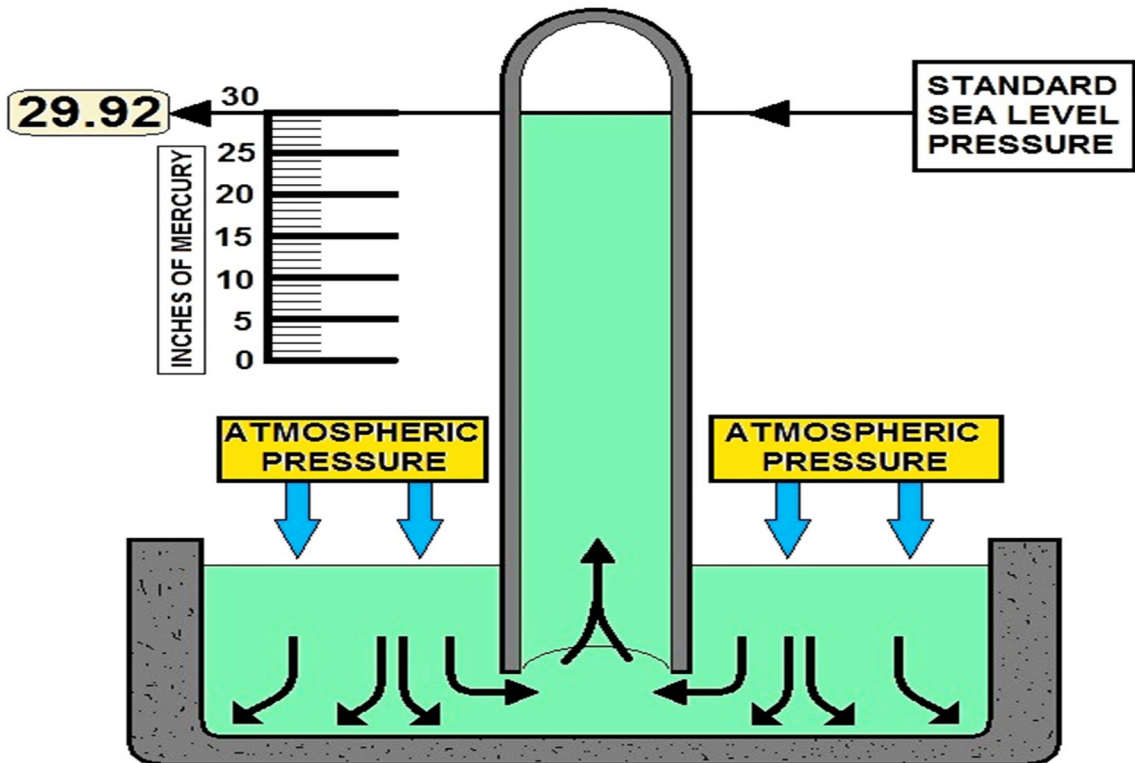

### MEASURING ATMOSPHERIC PRESSURE

## Meteorology

The study of atmospheric pressure is of great importance in meteorology. Atmospheric pressure determines the winds, which generally move at right angles to the direction of the most rapid change of pressure, that is, along the isobars, which are contours of constant pressure.

Certain characteristic weather patterns are associated with relatively high and relatively low pressures, and how they vary with time. The barometric pressure may be given in popular weather forecasts, though few people know what to do with it.

If you live at a high altitude, your local weather reporter may report the pressure to be, 29.2 inches, but if you have a real barometer, you may well find that it is closer to 25 inches. At an elevation of 1500 m (near Denver, or the top of the Puy de Dôme), the atmospheric pressure is about 635 mm, and water boils at 95 °C.

Actually, altitude is quite a problem in meteorology, since pressures must be measured at a common level to be meaningful.

The barometric pressures quoted in the weather report are reduced to sea level by standard formulas that amount to assuming that there is a column of air from your feet to sea level with a certain temperature distribution, and adding the weight of this column to the actual barometric pressure.

This is only an arbitrary 'fix' and leads to some strange conclusions, such as the permanent winter highs above high plateaus that are really imaginary.

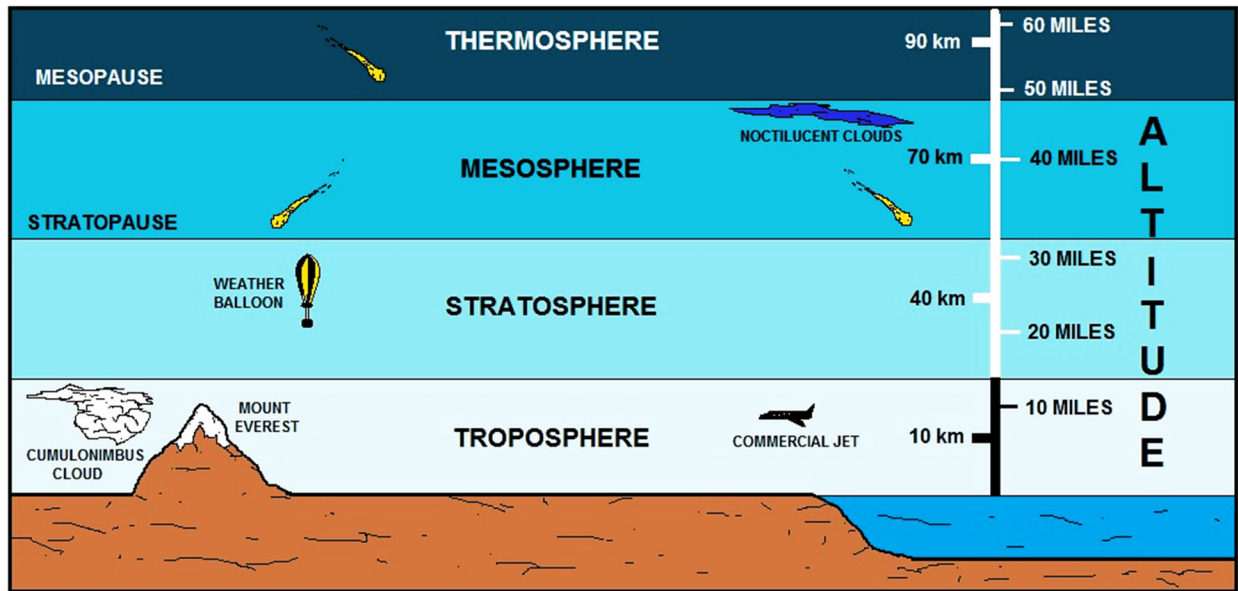

Technical Learning College

**ATMOSPHERE DIAGRAM**

## The Hydraulic Lever

Hydraulic systems use an incompressible fluid, such as oil or water, to transmit forces from one location to another within the fluid. Most aircraft use hydraulics in the braking systems and landing gear.

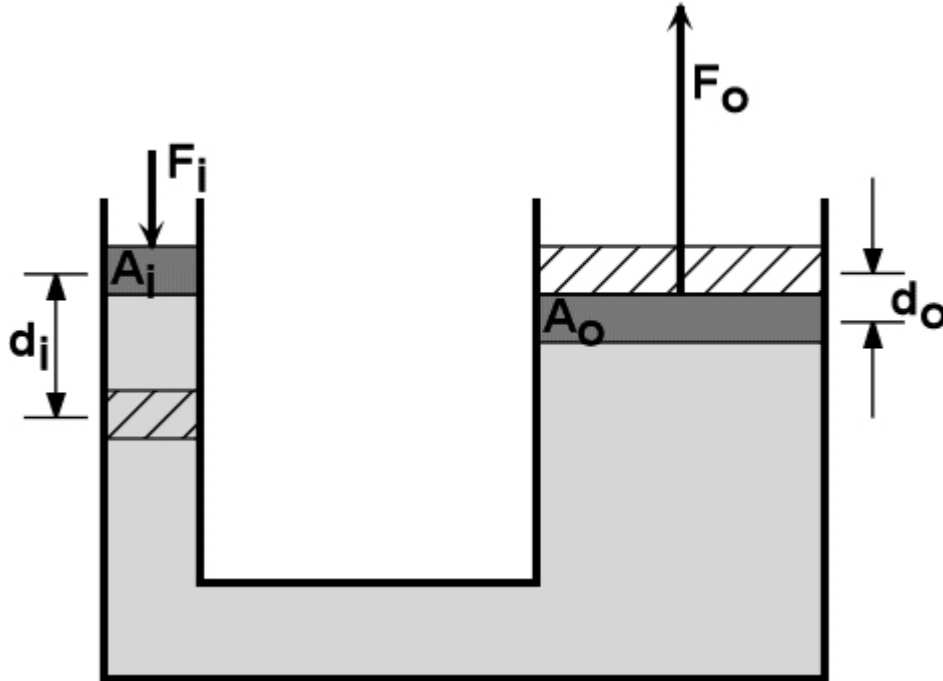

The hydraulic lever is a cylinder and piston is a chamber of variable volume, a mechanism for transforming pressure to force.

If  $A$  is the area of the cylinder, and  $p$  the pressure of the fluid in it, then  $F = pA$  is the force on the piston. If the piston moves outwards a distance  $dx$ , then the change in volume is  $dV = A dx$ .

The work done by the fluid in this displacement is  $dW = F dx = pA dx = p dV$ . If the movement is slow enough that inertia and viscosity forces are negligible, then hydrostatics will still be valid.

A process for which this is true is called quasi-static. Now consider two cylinders, possibly of different areas  $A$  and  $A'$ , connected with each other and filled with fluid. For simplicity, suppose that there are no gravitational forces.

Then the pressure is the same,  $p$ , in both cylinders. If the fluid is incompressible, then  $dV + dV' = 0$ , so that  $dW = p dV + p dV' = F dx + F' dx' = 0$ .

This says the work done on one piston is equal to the work done by the other piston: the conservation of energy.

The ratio of the forces on the pistons is  $F' / F = A' / A$ , the same as the ratio of the areas, and the ratios of the displacements  $dx' / dx = F / F' = A / A'$  is in the inverse ratio of the areas. This mechanism is the hydrostatic analogue of the lever, and is the basis of hydraulic activation.

## Bramah Hydraulic Press

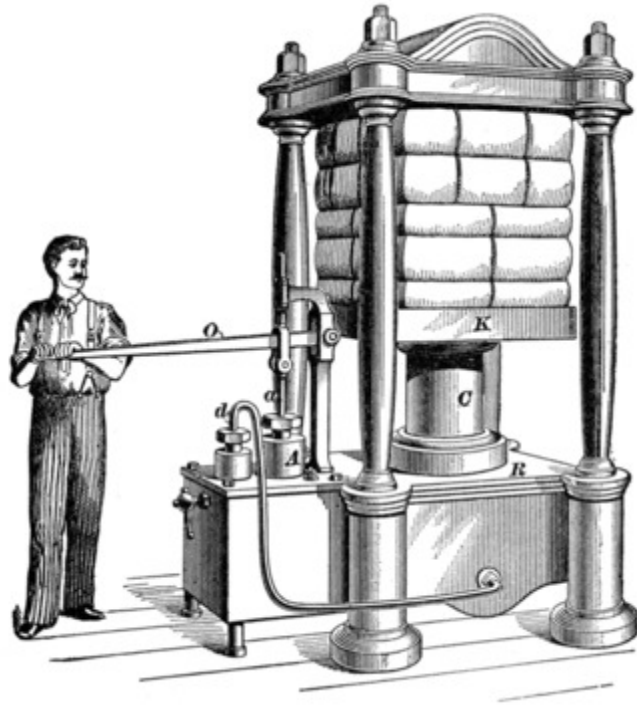

The most famous application of the hydraulic press/lever principle is the Bramah hydraulic press, invented by Joseph Bramah (1748-1814), who also invented many other useful machines, including a lock and a toilet.

Today, it was not very remarkable to see the possibility of a hydraulic press. It was difficult to find a way to seal the large cylinder properly. This was the crucial problem that Bramah solved by his leather seal that was held against the cylinder and the piston by the hydraulic pressure itself.

In the presence of gravity,  $p' = p + \rho gh$ , where  $h$  is the difference in elevation of the two cylinders.

Now,  $p' dV' = -dV (\rho + \rho gh) = -\rho dV - (\rho dV) gh$ , or the net work done in the process is  $p' dV' + \rho dV = -dM gh$ , where  $dM$  is the mass of fluid displaced from the lower cylinder to the upper cylinder.

Once more, energy is conserved if we take into account the potential energy of the fluid. Pumps are seen to fall within the province of hydrostatics if their operation is quasi-static, which means that dynamic or inertia forces are insignificant.



## Dudley Castle Engine



The first operating engine may have been erected in Cornwall in 1710, but the Dudley Castle engine of 1712 is much better known and thoroughly documented. The first pumps used in Cornwall were called bucket pumps, which we know now as lift pumps, with the pistons somewhat miscalled buckets.

These pumped on the up-stroke, when a clack in the bottom of the pipe opened and allowed water to enter beneath the piston. At the same time, the piston lifted the column of water above it, which could be of any length. The piston could only "suck" water 33 ft., or 28 ft. more practically, of course, but this occurred at the bottom of the shaft, so this was only a limit on the piston stroke.

On the down stroke, a clack in the bucket opened, allowing it to sink through the water to the bottom, where it would be ready to make another lift. More satisfactory were the plunger pumps, also placed at the bottom of the shaft.

A plunger displaced volume in a chamber, forcing the water in it through a check valve up the shaft, when it descended. When it rose, water entered the pump chamber through a clack, as in the bucket pump.

Only the top of the plunger had to be packed; it was not necessary that it fit the cylinder accurately. In this case, the engine at the surface lifted the heavy pump rods on the up-stroke. When the atmospheric engine piston returned, the heavy timber pump rods did the actual pumping, borne down by their weight. A special application for pumps is to produce a vacuum by exhausting a container, called the receiver.

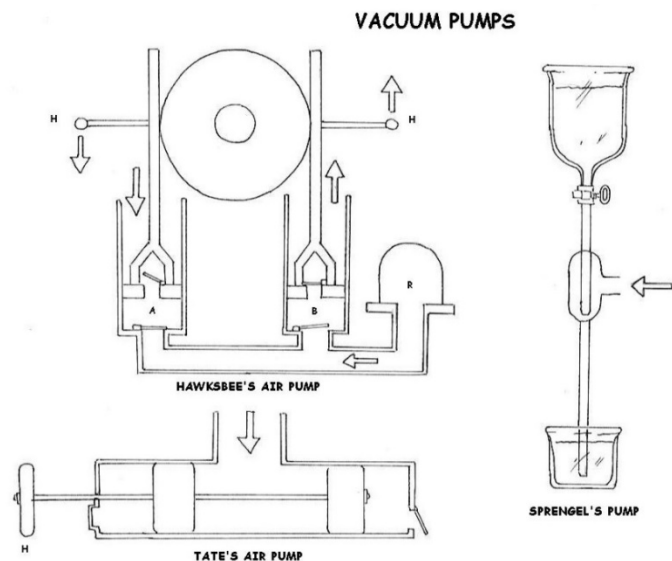

## Hawksbee's Dual Cylinder Pump



Hawksbee's dual cylinder pump, designed in the 18th century, is the final form of the air pump invented by Guericke by 1654.

It is a useful and good pump could probably reach about 5-10 mmHg, the limit set by the valves. The cooperation of the cylinders made the pump much easier to work when the pressure was low. In the diagram, piston A is descending, helped by the partial vacuum remaining below it, while piston B is rising, filling with the low-pressure air from the receiver.

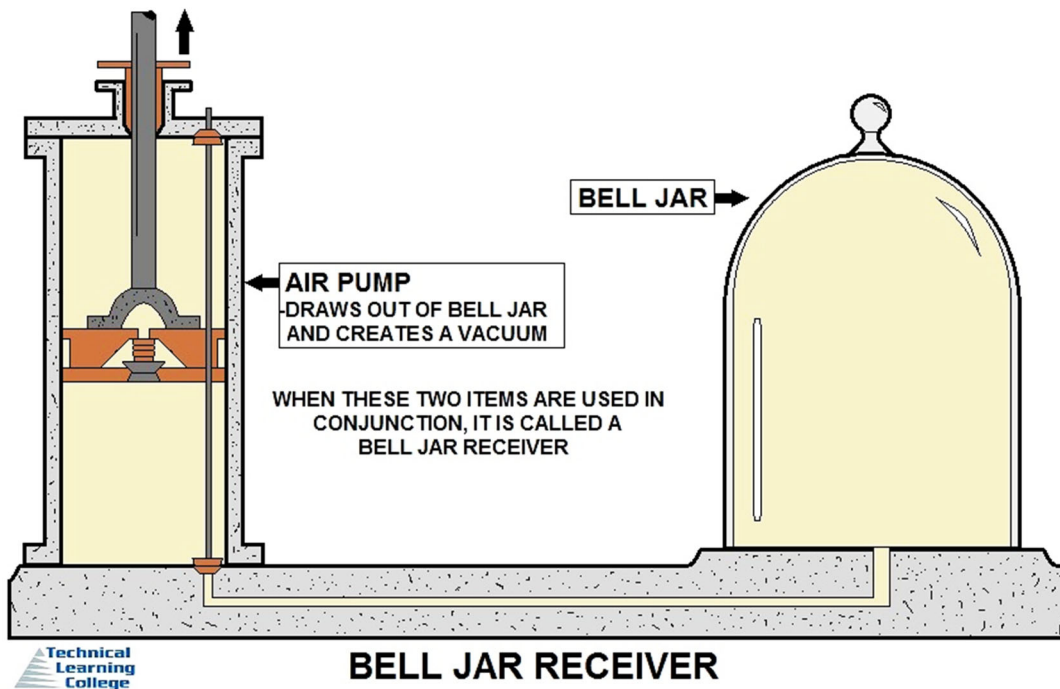

## Bell-Jar Receiver

The bell-jar receiver, invented by Huygens, a cumbersome globe was the usual receiver. Tate's air pump is a 19th century pump that would be used for simple vacuum demonstrations and for utility purposes in the lab. It has no valves on the low-pressure side, just exhaust valves V, V', so it could probably reach about 1 mmHg. It is operated by pushing and pulling the handle H. At the present day, motor-driven rotary-seal pumps sealed by running in oil are used for the same purpose. Below on the left is Sprengel's pump, with the valves replaced by drops of mercury.

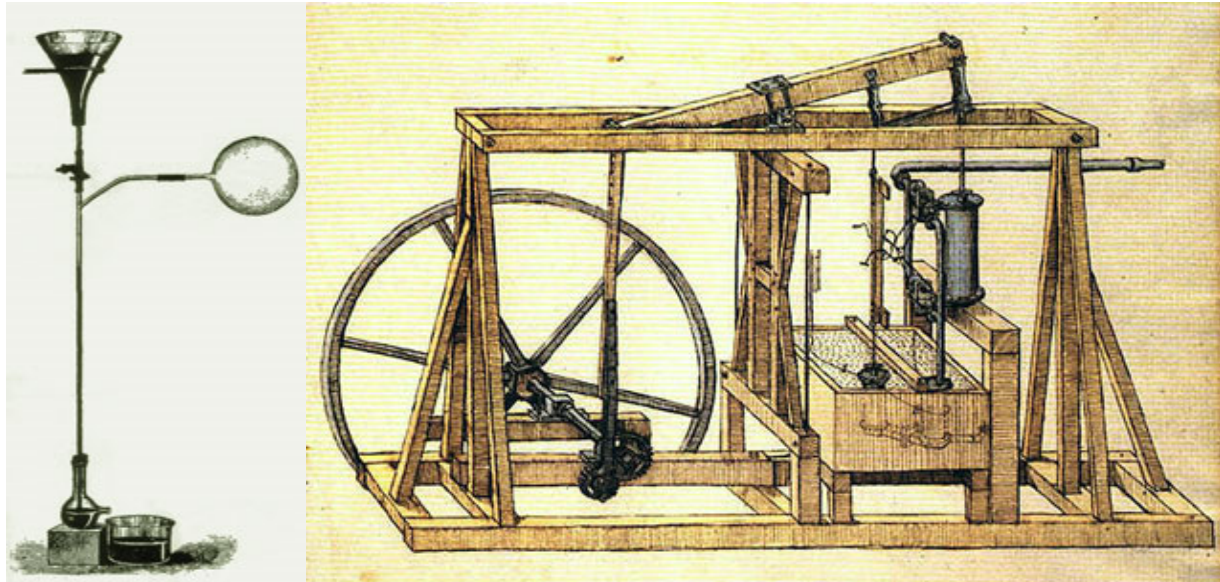

Small amounts of gas are trapped at the top of the fall tube as the mercury drops, and moves slowly down the fall tube as mercury is steadily added, coming out at the bottom carrying the air with it. The length of the fall tube must be greater than the barometric height, of course.

Theoretically, a vacuum of about  $1 \mu\text{m}$  can be obtained with a Sprengel pump, but it is very slow and can only evacuate small volumes. Later, Langmuir's mercury diffusion pump, which was much faster, replaced Sprengel pumps, and led to oil diffusion pumps that can reach very high vacua. The column of water or hydrostatic engine is the inverse of the force pump, used to turn a large head (pressure) of water into rotary motion. It looks like a steam engine, with valves operated by valve gear, but of course is not a heat engine and can be of high efficiency.

However, it is not of as high efficiency as a turbine, and is much more complicated, but has the advantage that it can be operated at variable speeds, as for lifting. A few very impressive column of water engines were made in the 19th century, but they were never popular and remained rare. Richard Trevithick, famous for high pressure steam engines, also built hydrostatic engines in Cornwall.

The drawing on the top right shows a column-of-water engine built by Georg von Reichenbach, and placed in service in 1917. It was used to pump brine for the Bavarian state salt industry.

## Solehebemaschine



This machine, a Solehebemaschine or "brine-lifting machine", entered service in 1821. It had two pressure-operated poppet valves for each cylinder. These engines are brass to resist corrosion by the salt water. Water pressure engines must be designed taking into account the incompressibility of water, so both valves must not close at the same time, and abrupt changes of rate of flow must not be made.

Air chambers can be used to eliminate shocks. Georg von Reichenbach (1771-1826) is much better known as an optical designer than as a mechanical engineer. He was associated with Joseph Fraunhofer, and they died within days of each other in 1826. He was of an aristocratic family, and was Salinenrat, or manager of the state salt works, in southeastern Bavaria, which was centered on the town of Reichenhall, now Bad Reichenhall, near Salzburg.

The name derives from "rich in salt." This famous salt region had salt springs flowing nearly saturated brine, at 24% to 26% (saturated is 27%) salt, that from ancient times had been evaporated over wood fires. A brine pipeline to Traunstein was constructed in 1617-1619, since wood fuel for evaporating the brine was exhausted in Reichenhall. The pipeline was further extended to Rosenheim, where there was turf as well as wood, in 1818-10.

Von Reichenbach is said to have built this pipeline, for which he designed a water-wheel-driven, four-barrel pump. Maximilian I, King of Bavaria, commissioned von Reichenbach to bring brine from Berchtesgaden, elevation 530 m, to Reichenhall, elevation 470 m, over a summit 943 m high. Fresh water was also allowed to flow down to the salt beds, and the brine was then pumped to the surface. This was a much easier way to mine salt than underground mining.

## Ancient Hydraulic Foundations –Explained

### Forces on Submerged Surfaces

Assume we wanted to know the force exerted on a vertical surface of any shape with water on one side, assuming gravity to act, and the pressure on the surface of the water zero. We have already solved this problem by a geometrical argument, but now we apply calculus, which is easier but not as enlightening.

The force on a small area  $dA$  a distance  $x$  below the surface of the water is  $dF = p \, dA = \rho g x \, dA$ , and the moment of this force about a point on the surface is  $dM = p x \, dA = \rho g x^2 \, dA$ .

By integration, we can find the total force  $F$ , and the depth at which it acts,  $c = M / F$ . If the surface is not symmetrical, the position of the total force in the transverse direction can be obtained from the integral of  $dM' = \rho g x \, dA$ , the moment about some vertical line in the plane of the surface.

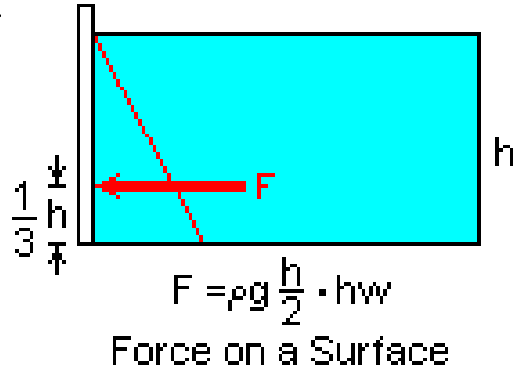

If there happens to be a pressure on the free surface of the water, then the forces due to this pressure can be evaluated separately and added to this result. We must add a force equal to the area of the surface times the additional pressure, and a moment equal to the product of this force and the distance to the centroid of the surface.

The simplest case is a rectangular gate of width  $w$ , and height  $h$ , whose top is a distance  $H$  below the surface of the water.

In this case, the integrations are very easy, and  $F = \rho g w [(h + H)^2 - h^2]/2 = \rho g H (H + 2h)/2 = \rho g (h + H/2) H w$ .

The total force on the gate is equal to its area times the pressure at its center.  $M = \rho g w [(h + H)^3 - h^3]/3 = \rho g (H^2/3 + Hh + h^2) H w$ , so that  $c = (H^2/3 + Hh + h^2) / (h + H/2)$ .

In the simple case of  $h = 0$ ,  $c = 2H/3$ , or two-thirds of the way from the top to the bottom of the gate. If we take the atmospheric pressure to act not only on the surface of the water, but also the dry side of the gate, there is no change to this result. This is the reason atmospheric pressure often seems to have been neglected in solving sub  $h$  problems.

Consider a curious rectangular tank, with one side vertical but the opposite side inclined inwards or outwards. The horizontal forces exerted by the water on the two sides must be equal and opposite, or the tank would scoot off. If the side is inclined outward, then there must be a downward vertical force equal to the weight of the water above it, and passing through the centroid of this water.

If the side is inclined inward, there must be an upward vertical force equal to the weight of the 'missing' water above it. In both cases, the result is demanded by ordinary statics.

## Hydrostatic Paradox

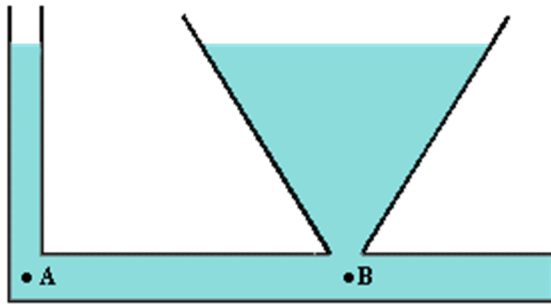

**FIGURE #1**

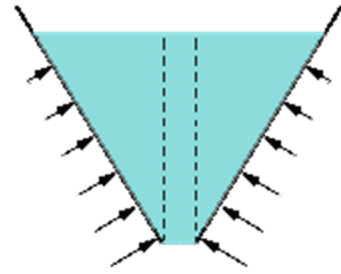

**FIGURE #2**

Blaise Pascal asked the question of this paradox nearly 300 years ago. He even built an apparatus, now known as 'Pascal's vases', to demonstrate the paradox. It was basically the vessel shown in Figure 1 with several more differently shaped chambers, but all open at the top and having the same base areas. In effect, if Pascal's vases are generalized to include compartments with any shapes, inclinations, or different base areas, the results will always be the same: the water levels in all chambers will be identical.

What we have here has been called the 'hydrostatic paradox.' It was conceived by the celebrated Flemish engineer Simon Stevin (1548-1620) of Brugge, the first modern scientist to investigate the statics of fluids and solids.

Consider three tanks with bottoms of equal sizes and equal heights, filled with water. The pressures at the bottoms are equal, so the vertical force on the bottom of each tank is the same. But suppose that one tank has vertical sides, one has sides inclined inward, and third sides inclined outwards. The tanks do not contain the same weight of water, yet the forces on their bottoms are equal! I am sure that you can spot the resolution of this paradox.

Occasionally the forces are required on curved surfaces. The vertical and horizontal components can be found by considering the equilibrium of volumes with a plane surface equal to the projected area of the curved surface in that direction.

The general result is usually a force plus a couple, since the horizontal and vertical forces are not necessarily in the same plane.

Simple surfaces, such as cylinders, spheres and cones, may often be easy to solve. In general, however, it is necessary to sum the forces and moments numerically on each element of area, and only in simple cases can this be done analytically.

If a volume of fluid is accelerated uniformly, the acceleration can be added to the acceleration of gravity. A free surface now becomes perpendicular to the total acceleration, and the pressure is proportional to the distance from this surface.

### Hydrostatic Paradox

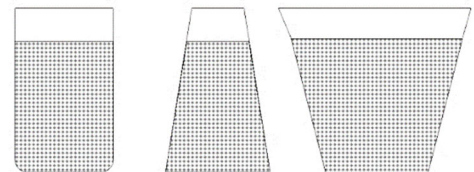

The same can be done for a rotating fluid, where the centrifugal acceleration is the important quantity. The earth's atmosphere is an example. When air moves relative to the rotating system, the Coriolis force must also be taken into account. However, these are dynamic effects and are not strictly a part of hydrostatics.

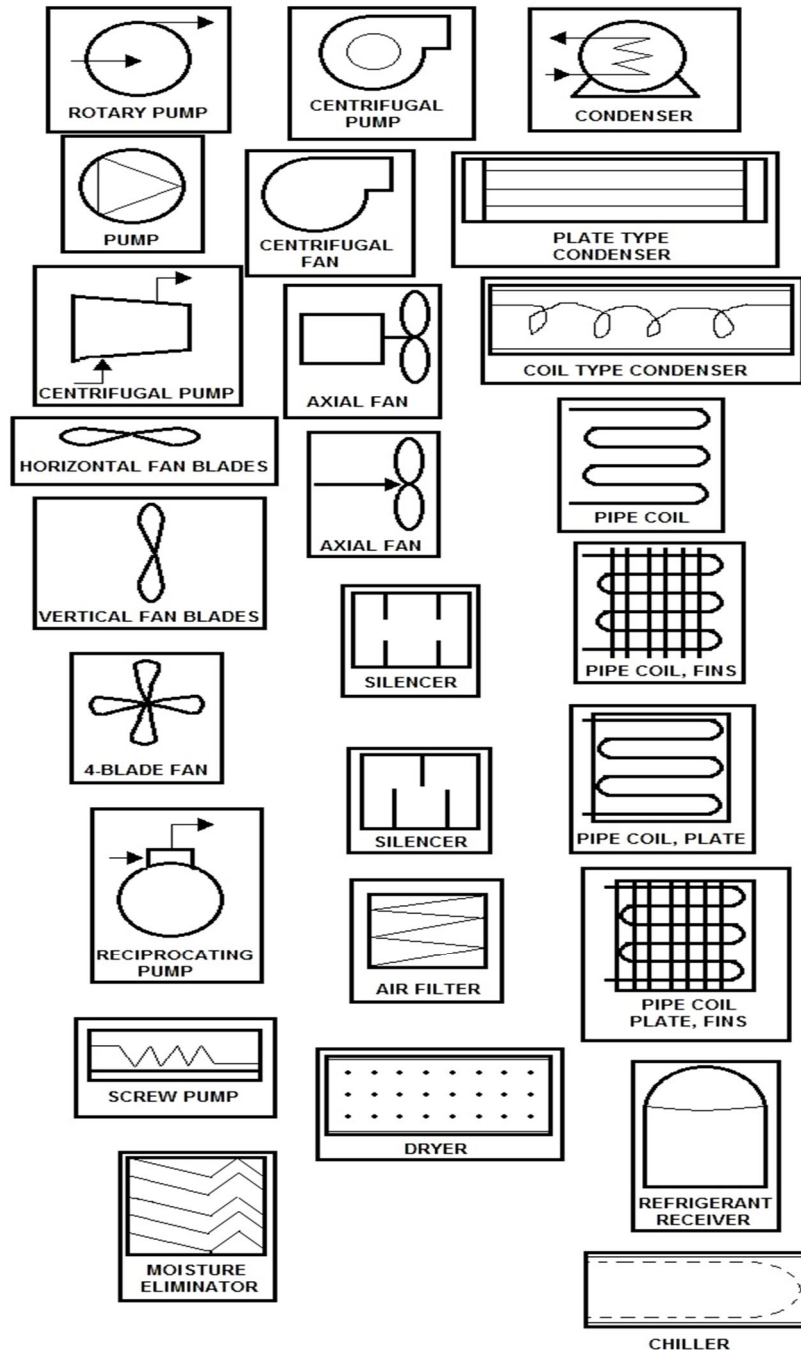

**FLUID MECHANICS SYMBOLS  
(Common)**







## Buoyancy

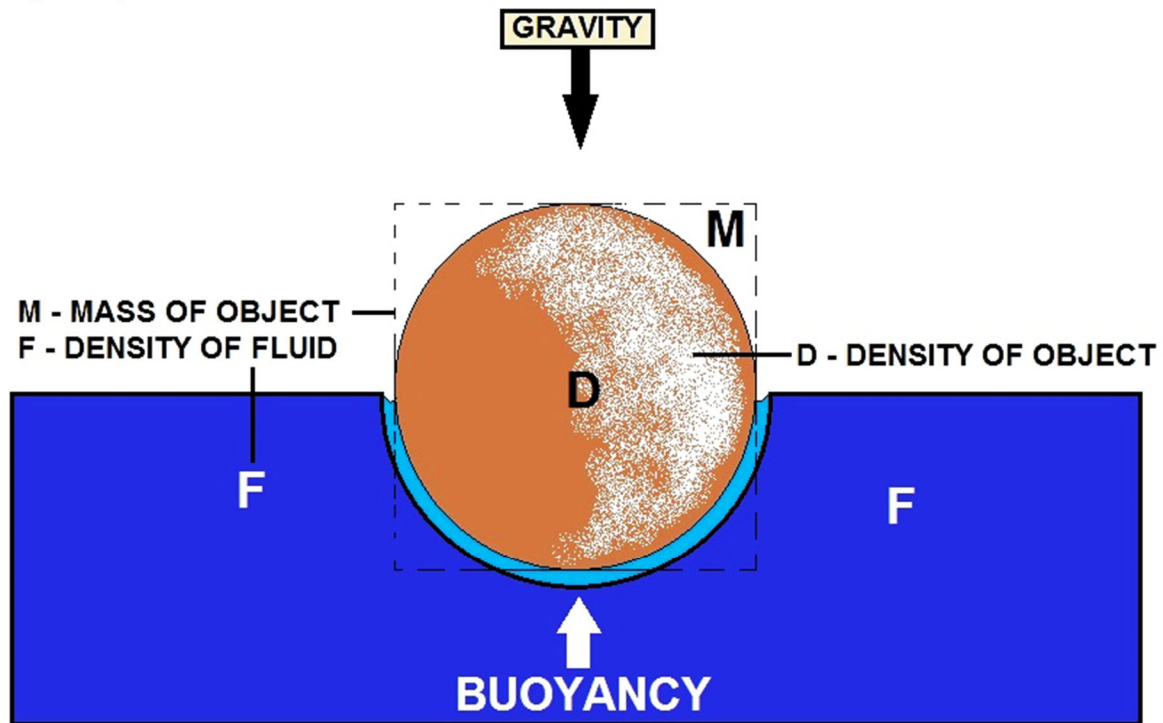

### BASICS THAT IMPACT HOW BUOYANCY WORKS



In physics or fluid mechanics, **buoyancy** or **upthrust**, is an upward force exerted by a fluid that opposes the weight of an immersed object. In a column of fluid, pressure increases with depth as a result of the weight of the overlying fluid. Thus the pressure at the bottom of a column of fluid is greater than at the top of the column.

Likewise, the pressure at the bottom of an object submerged in a fluid is greater than at the top of the object. This pressure difference results in a net upwards force on the object. The magnitude of that force exerted is proportional to that pressure difference, and as explained by Archimedes' principle is equivalent to the weight of the fluid that would otherwise occupy the volume of the object, i.e. the displaced fluid.

For this reason, an object whose density is greater than that of the fluid in which it is submerged tends to sink. If the object is either less dense than the liquid or is shaped appropriately (as in a boat), the force can keep the object afloat.

This can occur only in a non-inertial reference frame, which either has a gravitational field or is accelerating due to a force other than gravity defining a "downward" direction. In a situation of fluid statics, the net upward buoyancy force is equal to the magnitude of the weight of fluid displaced by the body.

The center of buoyancy of an object is the centroid of the displaced volume of fluid

## **Archimedes**

Archimedes, so the legend runs, was asked to determine if the goldsmith who made a golden crown for Hieron, Tyrant of Syracuse, had substituted cheaper metals for gold. The story is told by Vitruvius. A substitution could not be detected by simply weighing the crown, since it was craftily made to the same weight as the gold supplied for its construction. Archimedes realized that finding the density of the crown, that is, the weight per unit volume, would give the answer.

The weight was known, of course, and Archimedes cunningly measured its volume by the amount of water that ran off when it was immersed in a vessel filled to the brim. By comparing the results for the crown, and for pure gold, it was found that the crown displaced more water than an equal weight of gold, and had, hence, been adulterated.

This story, typical of the charming way science was made more interesting in classical times, may or may not actually have taken place, but whether it did or not, Archimedes taught that a body immersed in a fluid lost apparent weight equal to the weight of the fluid displaced, called Archimedes' Principle.

Specific gravity is the ratio of the density of a substance to the density of water, can be determined by weighing the body in air, and then in water. The specific gravity is the weight in air divided by the loss in weight when immersed. This avoids the difficult determination of the exact volume of the sample.

## How Buoyancy Works

To see how buoyancy works, consider a submerged brick, of height  $h$ , width  $w$  and length  $l$ . The difference in pressure on top and bottom of the brick is  $\rho gh$ , so the difference in total force on top and bottom of the brick is simply  $(\rho gh)(wl) = \rho gV$ , where  $V$  is the volume of the brick.

The forces on the sides have no vertical components, so they do not matter. The net upward force is the weight of a volume  $V$  of the fluid of density  $\rho$ .

## Change of Ship Stability

Anybody can be considered made up of brick shapes, as small as desired, so the result applies in general.

Consider a man in a rowboat on a lake, with a large rock in the boat. He throws the rock into the water. What is the effect on the water level of the lake?

Suppose you make a drink of ice water with ice cubes floating in it. What happens to the water level in the glass when the ice has melted?

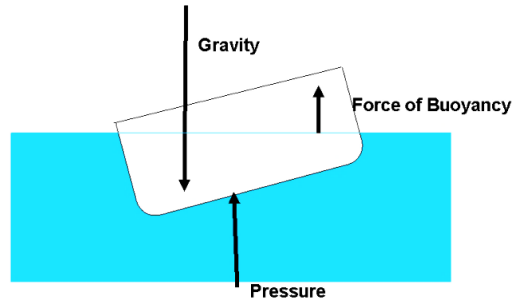

The force exerted by the water on the bottom of a boat acts through the center of gravity  $B$  of the displaced volume, while the force exerted by gravity on the boat acts through its own center of gravity  $A$ . This looks bad for the boat, since the boat's c.g. will naturally be higher than the c.g. of the displaced water, so the boat will tend to capsize. Well, a boat floats, and can tell us why. Should the boat start to rotate to one side, the displaced volume immediately moves to that side, and the buoyant force tends to correct the rotation.

A floating body will be stable provided the line of action of the buoyant force passes through a point  $M$  above the c.g. of the body, called the metacenter, so that there is a restoring couple when the boat heels. A ship with an improperly designed hull will not float. It is not as easy to make boats as it might appear.

## Pycnometer



A pycnometer is a flask with a close-fitting ground glass stopper with a fine hole through it, so a given volume can be accurately obtained.

The name comes from the Greek word meaning "density." If the flask is weighed empty, full of water, and full of a liquid whose specific gravity is desired, the specific gravity of the liquid can easily be calculated.

A sample in the form of a powder, to which the usual method of weighing cannot be used, can be put into the pycnometer. The weight of the powder and the weight of the displaced water can be determined, and from them the specific gravity of the powder.

The specific gravity of a liquid can be found with a collection of small weighted, hollow spheres that will just float in certain specific gravities.

The closest spheres that will just float and just sink put limits on the specific gravity of the liquid. This method was once used in Scotland to determine the amount of alcohol in distilled liquors.

Since the density of a liquid decreases as the temperature increases, the spheres that float are an indication of the temperature of the liquid. Galileo's thermometer worked this way.

## Measurement of Specific Gravity

The specific gravity of a material is the ratio of the mass (or weight) of a certain sample of it to the mass or weight of an equal volume of water, the conventional reference material.

In the metric system, the density of water is 1 g/cc, which makes the specific gravity numerically equal to the density.

Strictly speaking, density has the dimensions' g/cc, while specific gravity is a dimensionless ratio. Nevertheless, in casual speech the two are often confounded.

In English units, however, density, perhaps in lb/cu.ft or pcf, is numerically different from the specific gravity, since the weight of water is 62.5 lb/cu.ft.

## Variations in Specific Gravity

The basic idea in finding specific gravity is to weigh a sample in air, and then immersed in water. Then the specific gravity is  $W / (W - W')$ , if  $W$  is the weight in air, and  $W'$  the weight immersed.

The denominator is the buoyant force, the weight of a volume of water equal to the volume of the sample. This can be carried out with an ordinary balance, but special balances, such as the Jolly balance, have been created specifically for this application.

Adding an extra weight to the sample allows measurement of specific gravities less than 1.

Things are complicated by the variation of the density of water with temperature, and also by the confusion that gave us the distinction between cc and ml.

The milliliter is the volume of 1.0 g of water at 4°C, by definition. The actual volume of 1.0 g of water at 4°C is 0.999973 cm<sup>3</sup> by measurement.

Since most densities are not known, or needed, to more than three significant figures, it is clear that this difference is of no practical importance, and the ml can be taken equal to the cc.

The density of water at 0°C is 0.99987 g/ml, at 20° 0.99823, and at 100°C 0.95838.

The temperature dependence of the density may have to be taken into consideration in accurate work. Mercury, while we are at it, has a density 13.5955 at 0°C, and 13.5461 at 20°C.

## Hydrometer

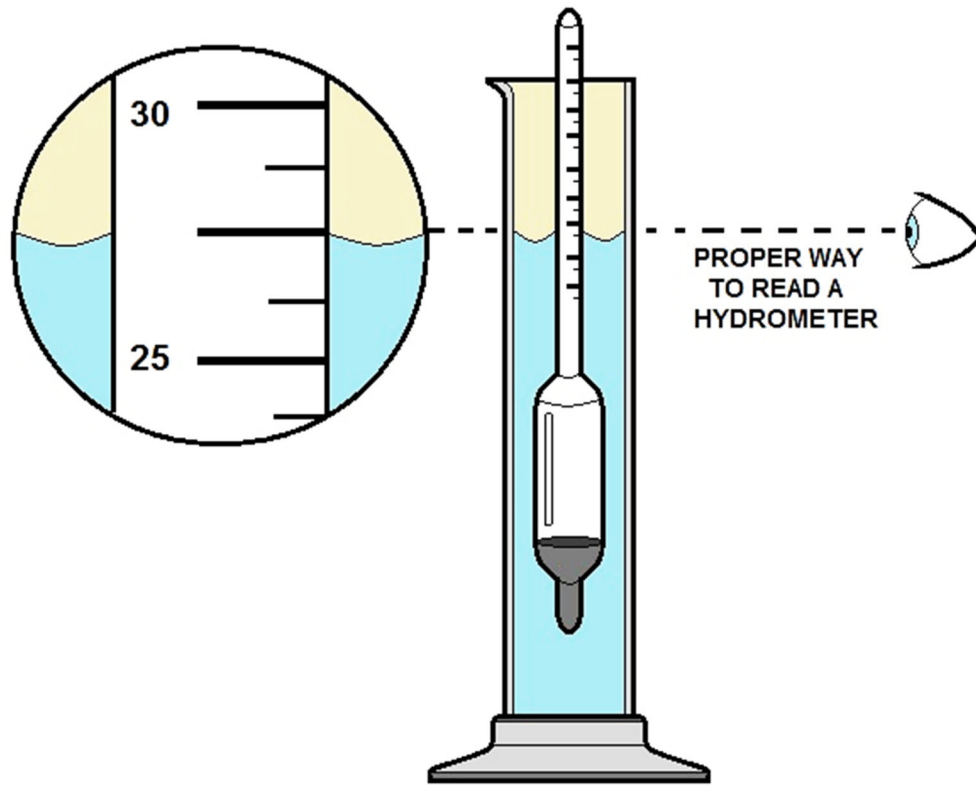

## HYDROMETER

A better instrument for the measurement of specific gravity is the hydrometer, which consists of a weighted float and a calibrated stem that protrudes from the liquid when the float is entirely immersed.

A higher specific gravity will result in a greater length of the stem above the surface, while a lower specific gravity will cause the hydrometer to float lower.

The small cross-sectional area of the stem makes the instrument very sensitive. Obviously, it must be calibrated against standards. In most cases, the graduations or "degrees" are arbitrary and reference is made to a table to determine the specific gravities.

Hydrometers are used to determine the specific gravity of lead-acid battery electrolyte, and the concentration of antifreeze compounds in engine coolants, as well as the alcohol content of whiskey.

## Montgolfier Brothers' Hot Air Balloon

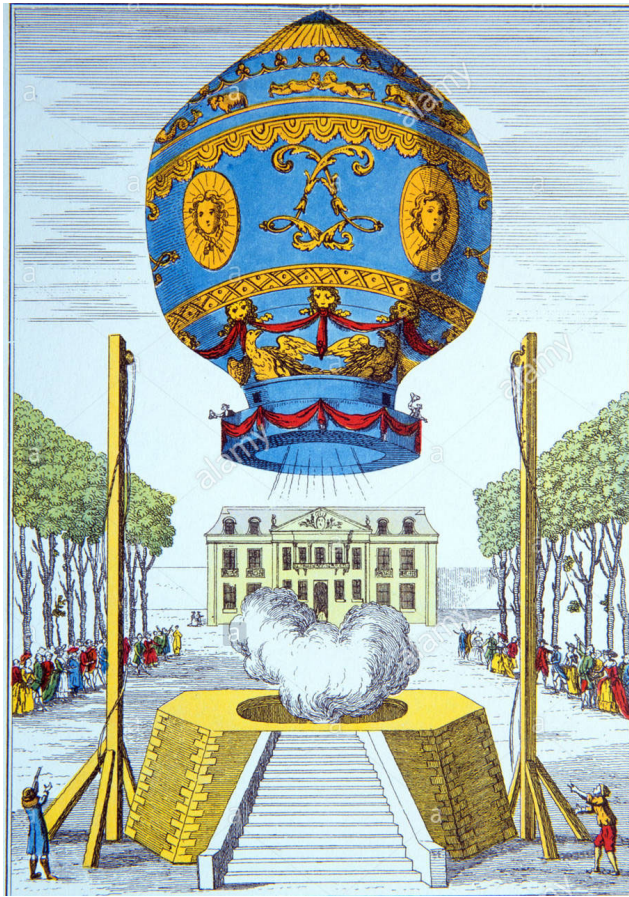

Archimedes' Principle can also be functional with balloons. The Montgolfier brothers' hot air balloon with a paper envelope ascended first in 1783 with the brothers got Pilâtre de Rozier and Chevalier d'Arlandes to go up in it. These early "fire balloons" were then replaced with hydrogen-filled balloons, and then with balloons filled with coal gas, which was easier to obtain and did not diffuse through the envelope quite as rapidly.

Methane would be a good filler, with a density 0.55 that of air. Slack balloons, like most large ones, can be contrasted with taut balloons with an elastic envelope, such as weather balloons. Slack balloons will not be filled full on the ground, and will plump up at altitude. Balloons are naturally stable, since the center of buoyancy is above the center of gravity in all practical balloons.

Submarines are another application of buoyancy, with their own characteristic problems. Small neoprene or natural rubber balloons have been used for meteorological observations, with hydrogen filling. A 10g ceiling balloon was about 17" in diameter when inflated to have a free lift of 40g. It ascended 480ft the first minute, 670ft in a minute and a half, and 360ft per minute afterwards, to find cloud ceilings by timing, up to 2500ft, when it subtended about 2' of arc, easily seen in binoculars.

Large sounding balloons were used to lift a radiosonde and a parachute for its recovery. An AN/AMT-2 radiosonde of the 1950's weighed 1500g, the paper parachute 100g, and the balloon 350g. The balloon was inflated to give 800g free lift, so it would rise 700-800 ft/min to an altitude of about 50,000 ft. (15 km) before it burst. This balloon was about 6 ft. in diameter when inflated at the surface, 3 ft. in diameter before inflation.

The information was returned by radio telemetry, so the balloon did not have to be followed optically. Of intermediate size was the pilot balloon, which was followed with a theodolite to determine wind directions and speeds. At night, a pilot balloon could carry a light for ceiling determinations.



## Weather Balloons

Weather balloons had to be launched promptly after filling, or the desired free lift would not be obtained. Helium is a little better in this respect, but it also diffuses rapidly.

The lift obtained with helium is almost the same as with hydrogen - density 4 compared to 2, where air is 28.97. But helium is exceedingly rare, and only its unusual occurrence in natural gas from Kansas makes it available. Great caution must be taken when filling balloons with hydrogen to avoid sparks and the accumulation of hydrogen in air, since hydrogen is exceedingly flammable and explosive over a wide range of concentrations. Helium has the great advantage in that it is not inflammable.

The hydrogen for filling weather balloons came from compressed gas in cylinders, from the reaction of granulated aluminum with sodium hydroxide and water, or from the reaction of calcium hydroxide with water. The chemical reactions are  $2Al + 2NaOH + 2H_2O \rightarrow 2NaAlO_2 + 3H_2$ , or  $CaH_2 + 2H_2O \rightarrow Ca(OH)_2 + 2H_2$ .

In the first formula, silicon or zinc could be used instead of aluminum, and in the second, any similar metal hydride. Both are rather expensive sources of hydrogen, but very convenient when only small amounts are required. Most hydrogen is made from the catalytic decomposition of hydrocarbons, or the reaction of hot coke with steam.

Electrolysis of water is an expensive source, since more energy is used than is recovered with the hydrogen. Any enthusiasm for a "hydrogen economy" should be tempered by the fact that there are no hydrogen wells, and all the hydrogen must be made with an input of energy usually greater than that available from the hydrogen, and often with the appearance of carbon.

Although about 60,000 Btu/lb is available from hydrogen, compared to 20,000 Btu/lb from gasoline, hydrogen compressed to 1000 psi requires 140 times as much volume for the same weight as gasoline.

For the energy content of a 13-gallon gasoline tank, a 600-gallon hydrogen tank would be required. The critical temperature of hydrogen is 32K, so liquid storage is out of the question for general use.



## Experiments and Early Applications Post Quiz

### Meteorology

1. The atmospheric pressure is of great importance in meteorology, since it determines the winds, which generally move at \_\_\_\_\_ to the direction of the most rapid change of pressure, that is, along the isobars, which are contours of constant pressure.
2. The barometric pressures quoted in the news are reduced to sea level by standard formulas that amount to assuming that there is a \_\_\_\_\_ from your feet to sea level with a certain temperature distribution, and adding the weight of this column to the actual barometric pressure.

### The Hydraulic Lever

3. A cylinder and piston is a chamber of variable volume, a mechanism for transforming?

### Bramah Hydraulic Press

4. The most famous application of this principle is the Bramah hydraulic press, invented by Joseph Bramah (1748-1814), who also invented many other useful machines, including a lock and a?
5. Pumps are seen to fall within the province of hydrostatics if their operation is quasi-static, which means that \_\_\_\_\_ are negligible.

### Bell-Jar Receiver

6. Small amounts of gas are trapped at the top of the fall tube as the \_\_\_\_\_ drops, and moves slowly down the fall tube as mercury is steadily added, coming out at the bottom carrying the air with it. The length of the fall tube must be greater than the barometric height, of course.

### Solehebeemaschine

7. Water pressure engines must be designed taking into account the \_\_\_\_\_, so both valves must not close at the same time, and abrupt changes of rate of flow must not be made.
8. This missing term can be used to eliminate shocks?

### Forces on Submerged Surfaces

9. Suppose we want to know the force exerted on a vertical surface of any shape with water on one side, assuming gravity to act, and the pressure on the surface of the water?

### **Hydrostatic Paradox**

10. Sometimes the forces are required on curved surfaces. The vertical and horizontal components can be found by considering the \_\_\_\_\_ with a plane surface equal to the projected area of the curved surface in that direction.

**Answers** 1. Right angles, 2. Column of air, 3. Pressure to force, 4. Toilet, 5. Dynamic or inertia forces, 6. Mercury, 7. Incompressibility of water, 8. Air chambers, 9. Zero, 10. Equilibrium of volumes

## Experiments and Early Applications References

- "A Course of Experimental Philosophy", John Theophilus Desaguliers, 1744, Vol II p. 474.
- "Advantages of Hydraulic Presses". MetalFormingFacts.com. The Lubrizol Corporation.
- "Bramah, Joseph". Encyclopædia Britannica. Encyclopædia Britannica Online.
- "BRAMAH'S HISTORY - Chronological History of Bramah" (PDF). bramah.co.uk. Retrieved 6 November 2014.
- "Chapter 7: Second Patent". www.history.rochester.edu.
- "Floater clustering in a standing wave: Capillarity effects drive hydrophilic or hydrophobic particles to congregate at specific points on a wave" (PDF).
- "Memories of Dartmouth – Dartmouth Museum". Dartmouth Museum. Retrieved 22 May 2012.
- The engine on display in Dartmouth was donated by the British Transport Commission to the Newcomen Society in 1963 and erected within an old electricity substation. This particular engine was built around 1725 at Griff Colliery, before moving elsewhere.
- "Science and Society Picture Library – Search". www.scienceandsociety.co.uk. Retrieved 6 July 2009.
- "Science Museum – Home – Atmospheric engine by Francis Thompson, 1791". www.sciencemuseum.org.uk.
- "Welcome to the 'Hydraulic Press' YouTube channel, a truly crushing experience". The Washington Post.
- "What Hydraulic Press Machine Is". BPTai. Retrieved 2016-06-19.
- Acott, Chris (1999). "The diving "Law-ers": A brief resume of their lives". South Pacific Underwater Medicine Society journal. 29 (1). ISSN 0813-1988. OCLC 16986801. Archived from the original on 2 April 2011. Retrieved 13 June 2009.
- B. Trinder, Industrial Revolution in Shropshire (3rd edn, Phillimore, Chichester, 2000), 48.
- Belford, P. (2007). "Sublime cascades: Water and Power in Coalbrookdale" (PDF). Industrial Archaeology Review. 29 (2): 136. doi:10.1179/174581907x234027. Archived from the original (PDF) on 22 February 2012.
- Black Country Living Museum: Newcomen Steam Engine
- Blackmore, H. (1986). "A Dictionary of London Gunmakers" p59
- Carlisle, Rodney (2004). Scientific American Inventions and Discoveries, p. 266. John Wiley & Sons, Inc., New Jersey. ISBN 0-471-24410-4.
- Chamber Colliery Co, Grace's Guide, retrieved 17 September 2011
- Day, L and McNeil, I, Biographical Dictionary of the History of Technology, p163
- Dionysius Lardner, The steam engine familiarly explained and illustrated
- Earl, Bryan (1994). Cornish Mining: The Techniques of Metal Mining in the West of England, Past and Present (2nd ed.). St Austell: Cornish Hillside Pub. p. 38. ISBN 0-9519419-3-3.
- Figuer, Louis "Merveilles de la science" Furne Jouvett et Cie, Paris 1868. Vol 1, pp. 53,54
- GB 177801177, Bramah, Joseph, "Flushing Toilet"
- GB 178501478, Bramah, Joseph, "Hydrostatical Machine and Boiler, Propelling Vessels, Carriages, &c."
- GB 179502045, Bramah, Joseph, "Obtaining and Applying Motive Power"
- Hills, Richard L. (1970). Power in the Industrial revolution. Manchester University Press. pp. 134–135. ISBN 0719003776.
- <http://www.bramah.co.uk/> accessed 2 March 2015
- J. H. Andrew and J. S. Allen, 'A confirmation of the location of the 1712 "Dudley Castle" Newcomen engine at Coneygree, Tipton' International Journal for the history of Engineering and Technology 72(2) (2009), 174–182.

Morris, Charles R. Morris; illustrations by J.E. (2012). The dawn of innovation the first American Industrial Revolution (1st ed.). New York: PublicAffairs. p. 42. ISBN 978-1-61039-049-1.

Parker, Dana T. Building Victory: Aircraft Manufacturing in the Los Angeles Area in World War II, p. 87, Cypress, CA, 2013. ISBN 978-0-9897906-0-4.

Preece, Geoff; Ellis, Peter (1981). Coalmining, a handbook to the History of Coalmining Gallery, Salford Museum of Mining. City of Salford Cultural Services. p. 16.

Roach, Peter (2011), Cambridge English Pronouncing Dictionary (18th ed.), Cambridge: Cambridge University Press, ISBN 9780521152532

Rolt, L. T. C. (1963). Thomas Newcomen – The Prehistory of the Steam Engine. Dawlish: David & Charles. p. 86.

Skempton (2002), p.70

Suhail Rana, 'New evidence supporting Wolverhampton as the location of the first working Newcomen engine' International Journal for the history of Engineering and Technology 72(2) (2009), 162–173.

The Miners Friend Archived 11 May 2009 at the Wayback Machine.  
University of Rochester, NY, The growth of the steam engine online history resource, chapter one. Archived 4 February 2012 at the Wayback Machine.

Wells, John C. (2008), Longman Pronunciation Dictionary (3rd ed.), Longman, ISBN 9781405881180

## Section 5 - Hydraulic Foundations and Theories

**Section Focus:** You will learn the foundations of fluid mechanics and hydraulic principle theories. At the end of this section, you will be able to describe early hydraulic scientists who founded hydraulic ideas. There is a post quiz at the end of this section to review your comprehension and a final examination in the Assignment for your contact hours.

**Scope/Background:** In order to design water systems or calculate pumping rates or flow rates, we need to master this area of engineering.



### Blaise Pascal

Blaise Pascal (19 June 1623 – 19 August 1662) was a French mathematician, physicist, inventor, writer and Christian philosopher. He was a child prodigy who was educated by his father, who was a tax collector in Rouen. Pascal's earliest work was in the natural and applied sciences where he made important contributions to the study of fluids, and clarified the concepts of pressure and vacuum by generalizing the work of Evangelista Torricelli. Pascal also wrote in defense of the scientific method.

In 1642, while still a teenager, he started some pioneering work on calculating machines. After three years of effort and fifty prototypes, he invented the mechanical calculator. He built 20 of these machines, called Pascal's calculator and later pascaline in the following ten years.

Pascal was an important mathematician, helping create two major new areas of research: he wrote a significant treatise on the subject of projective geometry at the age of 16, and later corresponded with Pierre de Fermat on probability theory, strongly influencing the development of modern economics and social science.

Following Galileo and Torricelli, in 1646 he refuted Aristotle's followers who insisted that nature abhors a vacuum. Pascal's results caused many disputes before being accepted.

Between 1658 and 1659 he wrote on the cycloid and its use in calculating the volume of solids. Pascal had poor health especially after his 18th year and his death came just two months after his 39th birthday.

Pascal's inventions and discoveries have been instrumental to developments in the fields of geometry, physics and computer science, influencing 17th-century visionaries like Gottfried Wilhelm Leibniz and Isaac Newton. During the 20th century, the Pascal (Pa) unit was named after the thinker in honor of his contributions to the understanding of atmospheric pressure and how it could be estimated in terms of weight.

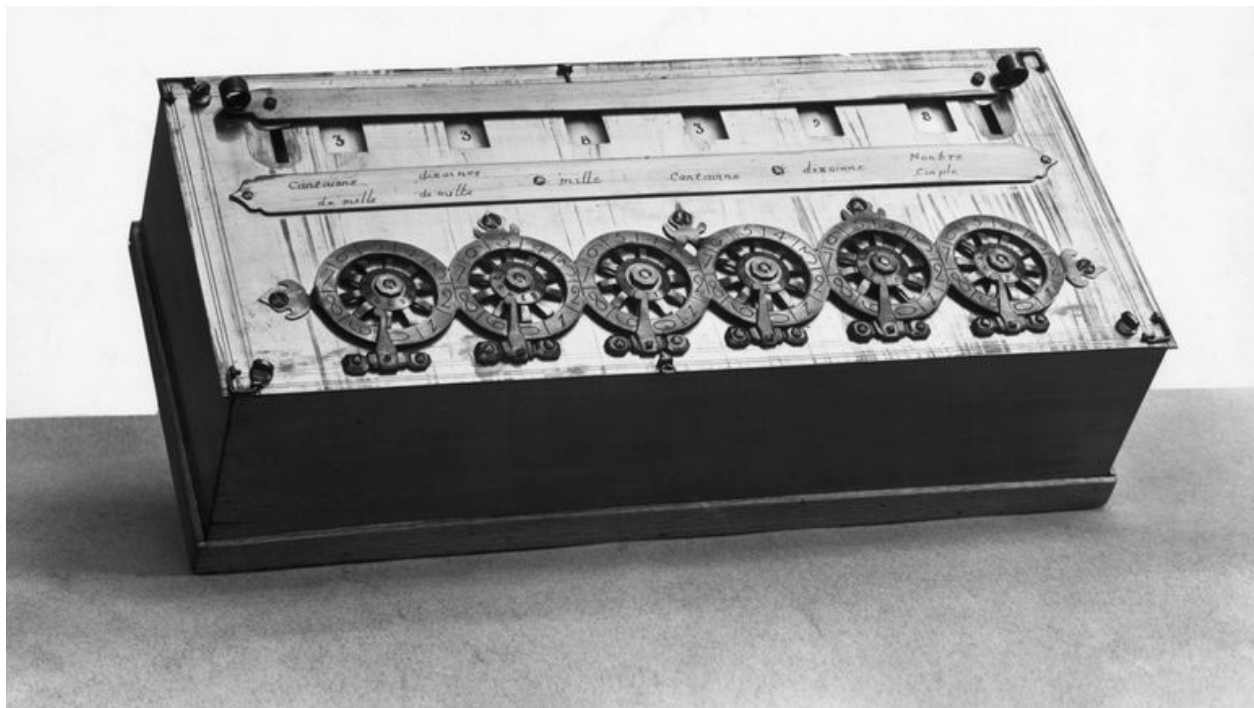

In the late 1960s, Swiss computer scientist Nicklaus Wirth invented a computer language and insisted on naming it after Pascal. This was Wirth's way of memorializing Pascal's invention of the Pascaline, one of the earliest forms of the modern computer.



# Hydraulic Foundations and Theories Key Terms

## English Units

English units of measurement, principal system of weights and measures weights and measures, units and standards for expressing the amount of some quantity, such as length, capacity, or weight; the science of measurement standards and methods is known as metrology.

## Floating Bodies

*On Floating Bodies*, which is thought to have been written around 250 BC, survives only partly in Greek, the rest in medieval Latin translation from the Greek. It is the first known work on hydrostatics, of which Archimedes is recognized as the founder.

## Horror vacui

In physics, horror vacui, or plenism, is commonly stated as "Nature abhors a vacuum." It is a postulate attributed to Aristotle, who articulated a belief, later criticized by the atomism of Epicurus and Lucretius, that nature contains no vacuums because the denser surrounding material continuum would immediately fill the rarity of an incipient void. He also argued against the void in a more abstract sense (as "separable"), for example, that by definition a void, itself, is nothing, and following Plato, nothing cannot rightly be said to exist. Furthermore, in so far as it would be featureless, it could neither be encountered by the senses, nor could its supposition lend additional explanatory power. Hero of Alexandria challenged the theory in the first century AD, but his attempts to create an artificial vacuum failed. The theory was debated in the context of 17th-century fluid mechanics, by Thomas Hobbes and Robert Boyle, among others, and through the early 18th century by Sir Isaac Newton and Gottfried Leibniz.

## Hydrodynamica

*Hydrodynamica* (Latin for *Hydrodynamics*) is a book published by Daniel Bernoulli in 1738. The title of this book eventually christened the field of fluid mechanics as hydrodynamics. The book deals with fluid mechanics and is organized around the idea of conservation of energy, as received from Christiaan Huygens's formulation of this principle. The book describes the theory of water flowing through a tube and of water flowing from a hole in a container. In doing so, Bernoulli explained the nature of hydrodynamic pressure and discovered the role of loss of *vis viva* in fluid flow, which would later be known as the Bernoulli principle. The book also discusses hydraulic machines and introduces the notion of work and efficiency of a machine. In the tenth chapter, Bernoulli discussed the first model of the kinetic theory of gases. Assuming that heat increases the velocity of the gas particles, he demonstrated that the pressure of air is proportional to kinetic energy of gas particles, thus making the temperature of gas proportional to this kinetic energy as well.

## Isothermal

An isothermal process is a change of a *system*, in which the temperature remains constant:  $\Delta T = 0$ . This typically occurs when a system is in contact with an outside thermal reservoir (heat bath), and the change will occur slowly enough to allow the system to continually adjust to the temperature of the reservoir through heat exchange. In contrast, an *adiabatic process* is where a system exchanges no heat with its surroundings ( $Q = 0$ ). In other words, in an isothermal process, the value  $\Delta T = 0$  and therefore  $\Delta U = 0$  (only for an ideal gas) but  $Q \neq 0$ , while in an adiabatic process,  $\Delta T \neq 0$  but  $Q = 0$

## Liquid

A liquid is a nearly incompressible fluid that conforms to the shape of its container but retains a (nearly) constant volume independent of pressure. As such, it is one of the four fundamental states of matter (the others being solid, gas, and plasma), and is the only state with a definite volume but no fixed shape.

## Measurement of the Circle

The area of a **circle** is to the square on its diameter as 11 to 14. The ratio of the circumference of any **circle** to its diameter is greater than but less than. Measurement of a Circle (Greek: Κύκλου μέτρησις, Kuklou metrēsis) is a treatise that consists of three propositions by Archimedes.

## Mercury

Mercury is a chemical element with symbol Hg and atomic number 80. It is commonly known as quicksilver and was formerly named hydrargyrum. A heavy, silvery d-block element, mercury is the only metallic element that is liquid at standard conditions for temperature and pressure; the only other element that is liquid under these conditions is bromine, though metals such as Caesium, gallium, and rubidium melt just above room temperature.

## Plane Equilibrium

On the Equilibrium of Planes (or Centers of Gravity of Planes; in two books) is mainly concerned with establishing the centers of gravity of various rectilinear plane figures and segments of the parabola and the paraboloid.

## Torr

The **torr** (symbol: Torr) is a unit of pressure based on an absolute scale, now defined as exactly  $1/760$  of a standard atmosphere. Thus one torr is exactly  $101325/760$  pascals ( $\sim 133.3$  Pa). Historically, one torr was intended to be the same as one "millimeter of mercury".

However, subsequent redefinitions of the two units made them slightly different (by less than 0.000015%). The torr is not part of the International System of Units (SI), but it is often combined with the metric prefix milli to name one **millitorr** (mTorr) or 0.001 Torr. The unit was named after Evangelista Torricelli, an Italian physicist and mathematician who discovered the principle of the barometer in 1644.

## Hydraulic Foundations and Theories - Introduction

### Section Focus

We will explain various scientists and their theories relating to fluid mechanics including the history and development of Pascal's Law.

### Archimedes - *The King of Hydraulics*



### Archimedes

Archimedes was a great mathematician of ancient times. His greatest contributions were in geometry. He also spent some time in Egypt, where he invented the machine now called Archimedes' screw, which was a mechanical water pump.

Among his most famous works is *Measurement of the Circle*, where he determined the exact value of pi between the two fractions,  $3 \frac{10}{71}$  and  $3 \frac{1}{7}$ . He got this information by inscribing and circumscribing a circle with a 96-sided regular polygon.

Archimedes made many contributions to geometry in his work in the areas of plane figures and in the areas of area and volumes of curved surfaces. His methods started the idea for calculus which was "invented" 2,000 years later by Sir Isaac Newton and Gottfried Wilhelm von Leibniz.

Archimedes proved that the volume of an inscribed sphere is two-thirds the volume of a circumscribed cylinder. He requested that this formula/diagram be inscribed on his tomb.

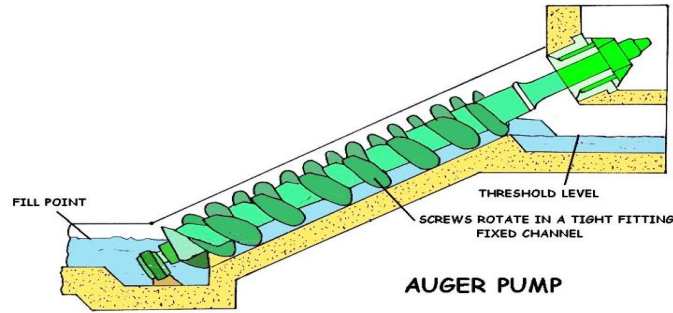

**This pump is at least 2,000 years old.**

## Archimedes Screw

The Archimedes Screw also called an Archimedes Snail, was used for irrigation and powered by horses, people, mules, etc. This pump is even used today, while rarely! The helix revolves inside a tube and the water rises accordingly. Whether or not it was actually invented by Archimedes is certainly debatable, though his overall brilliance is not.

His works that survived include:

- Measurement of a Circle
- On the Sphere and Cylinder
- On Spirals
- The Sand Reckoner

The Roman's highest numeral was a myriad (10,000). Archimedes was not content to use that as the biggest number, so he decided to conduct an experiment using large numbers. The question: How many grains of sand there are in the universe?

He made up a system to measure the sand. While solving this problem, Archimedes discovered something called powers. The answer to Archimedes' question was one with 62 zeros after it ( $1 \times 10^{62}$ ).

When numbers are multiplied by themselves, they are called powers.

Some powers of two are:

$$1 = 0 \text{ power} = 2^0$$

$$2 = 1^{\text{st}} \text{ power} = 2^1$$

$$2 \times 2 = 2^{\text{nd}} \text{ power (squared)} = 2^2$$

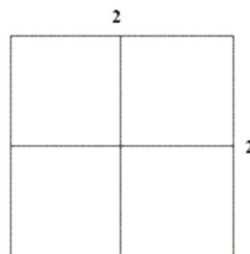

Two squared = 4

$2 \times 2 \times 2 = 3^{\text{rd}}$  power (cubed)  $= 2^3$

$2 \times 2 \times 2 \times 2 = 4^{\text{th}}$  power  $= 2^4$

There are short ways to write exponents.

For example, a short way to write 81 is  $3^4$ .

This is read as three to the fourth power.

- On Plane Equilibriums
- On Floating Bodies

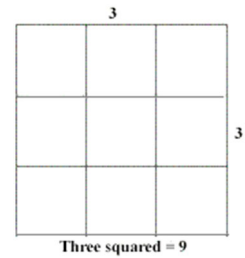

This problem was after Archimedes had solved the problem of King Hiero's gold crown. He experimented with liquids. He discovered *density* and *specific gravity*.

## Other Archimedes' Inventions

### Iron Hand

The iron hand, also called the Archimedes claw, was a weapon designed by Archimedes to defend Syracuse from attack from the Roman Empire's fleet in 213 B.C. It consisted of a huge lever. At one end was a grappling hook, or the claw. The claw was maneuvered to grasp the bow of an approaching ship, lift the ship out of the water, then drop it onto the water or onto nearby rocks. The ship's stern would be flooded and the unfortunate crew would be thrown out of the vessel in many directions.

### Integral Calculus

Integral calculus -- a mathematical theory that derives the areas and volumes of spaces and the relationships between variables such as speed, distance and time -- remains one of Archimedes' greatest accomplishments. He calculated areas of figures by breaking them up into a number of tiny rectangles and adding them up together to give a total. Today, this process is called integration and forms the basis of advanced mathematics.





**DANIEL BERNOULLI (1700-1782)**

### **Daniel Bernoulli**

Daniel Bernoulli was born in Groningen, in the Netherlands, into a family of distinguished mathematicians. The Bernoulli family came originally from Antwerp, at that time in the Spanish Netherlands, but emigrated to escape the Spanish persecution of the Huguenots. After a brief period in Frankfurt the family moved to Basel, in Switzerland.

Daniel was the son of Johann Bernoulli (one of the "early developers" of calculus), nephew of Jakob Bernoulli (who "was the first to discover the theory of probability"), and older brother of Johann II. Daniel Bernoulli was described by W. W. Rouse Ball as "by far the ablest of the younger Bernoullis". He is said to have had a troubled relationship with his father, Johann.

Upon both of them entering and tying for first place in a scientific contest at the University of Paris, Johann, unable to bear the "shame" of being compared as Daniel's equal, and banned Daniel from his house. Johann Bernoulli also plagiarized some key ideas from Daniel's book *Hydrodynamica* in his own book *Hydraulica* which he backdated to before *Hydrodynamica*. Despite Daniel's attempts at reconciliation, his father carried the grudge until his death.

When Daniel was seven, his younger brother Johann II Bernoulli was born. Around schooling age, his father, Johann Bernoulli, encouraged him to study business, since being poor rewards awaiting a mathematician. However, Daniel refused, because he wanted to study mathematics. He later gave in to his father's wish and studied business.

## Daniel Bernoulli's Other Inventions

### Blood Pressure Measurements

After developing his first mathematical principles, Bernoulli realized that the flow of fluids would also be adaptable to the idea of energy conservation. To investigate his theory, Bernoulli punctured the wall of a pipe and stuck in a small straw. He realized that the height the fluid rose within the straw was reflective of how much pressure was being generated. Being a physician as well, Bernoulli realized this would also work to measure the blood pressure of patients if a small tube was stuck in an artery. This was the preferred method of checking blood pressure for almost 200 years and this method is still used today to measure aircraft speeds.

### Risk Measurements

Economic theory is all about measuring risks and rewards. Sometimes you want to avert risk and sometimes the right risks can pay off with a premium amount. In 1738, Bernoulli wrote a piece where the St. Petersburg paradox, an idea that relates probability and decision theory, as a means of being able to measure risk within an economic environment. He also attempted to analyze statistics involving censored data to measure the efficacy of vaccines within the general population.

### Euler-Bernoulli Beam Equation

Theories about beams and their elasticity had been being developed for some time before Bernoulli began working on it. This equation shores up the elasticity of a beam, or how flexible it can be, yet still be considered a rigid beam. By knowing this information, it is possible to understand the tolerances of the beam, how much weight it is able to bear, and how functional the beam can be over an extended period of time. This equation is critical to the development of proper aerodynamics and you can see this equation applied every day on vehicles, airplanes, and anything else that moves with some version of improved velocity.

### Quotes

*It would be better for the true physics if there were no mathematicians on earth.*

*There is no philosophy which is not founded upon knowledge of the phenomena, but to get any profit from this knowledge it is absolutely necessary to be a mathematician.*



## Early Development of Hydraulics

The Egyptians and the ancient people of Persia, India, and China transferred water along channels for irrigation and domestic purposes, using dams and sluice gates to control the flow. The ancient Cretans and Romans had intricate plumbing system. Archimedes studied the laws of floating and submerged bodies.

The Romans constructed aqueducts to carry water to their cities. Although the modern development of hydraulics is comparatively recent, the ancients were conversant with many hydraulic principles and their applications.

After the breakup of the ancient world, there were few new developments for many centuries. Then, over a comparatively short period, beginning near the end of the seventeenth century, Italian physicist, Evangelista Torricelle, French physicist, Edme Mariotte, and later, Daniel Bernoulli conducted experiments to study the elements of force in the discharge of water through small openings in the sides of tanks and through short pipes.

## Pascal Law-Continued

During the same period, Blaise Pascal, a French scientist, discovered the basic law for the science of hydraulics. Pascal's law states that increase in pressure on the surface of a confined fluid is transmitted undiminished throughout the confining vessel or system.

For Pascal's law to be made effective for practical applications, it was necessary to have a piston that "fit exactly." It was not until the latter part of the eighteenth century that methods were found to make these snugly fitted parts required in hydraulic systems.

This was accomplished by the invention of machines that were used to cut and shape the necessary closely fitted parts and, particularly, by the development of gaskets and packings. Since that time, components such as valves, pumps, actuating cylinders, and motors have been developed and refined to make hydraulics one of the leading methods of transmitting power.

Liquids are almost incompressible. For example, if a pressure of 100 pounds per square inch (**psi**) is applied to a given volume of water that is at atmospheric pressure, the volume will decrease by only 0.03 percent.

It would take a force of approximately 32 tons to reduce its volume by 10 percent; however, when this force is removed, the water immediately returns to its original volume. Other liquids behave in about the same manner as water.

Another characteristic of a liquid is the tendency to keep its free surface level. If the surface is not level, liquids will flow in the direction which will tend to *make* the surface level.

## Burgomeister of Magdeburg



The noteworthy Otto von Guericke (1602-1686), Burgomeister of Magdeburg, Saxony, took up the cause, making the first vacuum pump, which he used in vivid demonstrations of the pressure of the atmosphere to the Imperial Diet at Regensburg in 1654. Notably, he evacuated a sphere consisting of two well-fitting hemispheres about a foot in diameter, and showed that 16 horses, 8 on each side, could not pull them apart.

An original vacuum pump and hemispheres from 1663 are shown at the right (photo edited from the Deutsches Museum; see on right).



He also showed that air had weight, and how much force it did require to separate evacuated hemispheres. Later, in England, Robert Hooke (1635-1703) made a vacuum pump for Robert Boyle (1627-1691). Christian Huygens (1629-1695) became interested in a visit to London in 1661 and had a vacuum pump built for him.

By this time, Torricelli's doctrine had triumphed over the Catholic Church's support for horror vacui. This was one of the first victories for rational physics over the illusions of experience, and is well worth consideration.

Pascal demonstrated that the siphon worked by atmospheric pressure, not by horror vacui. The two beakers of mercury are connected by a three-way tube as shown, with the upper branch open to the atmosphere. As the large container is filled with water, pressure on the free surfaces of the mercury in the beakers pushes mercury into the tubes.

When the state shown is reached, the beakers are connected by a mercury column, and the siphon starts, emptying the upper beaker and filling the lower. The mercury has been open to the atmosphere all this time, so if there were any horror vacui, it could have flowed in at will to soothe itself.

## Evangelista Torricelli



**Evangelista Torricelli** (1608-1647) was an Italian physicist and mathematician, best known for his invention of the barometer, but is also known for his advances in optics and work on the method of indivisibles. Evangelista Torricelli incredibly was one of Galileo's student and secretary and a member of the Florentine Academy of Experiments, invented the mercury barometer in 1643, and brought the weight of the atmosphere to light.

The mercury column was held up by the pressure of the atmosphere, not by horror vacui as Aristotle had supposed. Torricelli's early death was a blow to science, but his ideas were furthered by Blaise Pascal (1623-1662).

Pascal had a barometer carried up the 1465 m high Puy de Dôme, an extinct volcano in the Auvergne just west of his home of Clermont-Ferrand in 1648 by Périer, his brother-in-law. Pascal's experimentum crucis is one of the triumphs of early modern science. The Puy de Dôme is not the highest peak in the Massif Central--the Puy de Sancy, at 1866 m is, but it was the closest. Clermont is now the center of the French pneumatics industry.

### **Torricelli's law**

Torricelli also discovered Torricelli's law, regarding the speed of a fluid flowing out of an opening, which was later shown to be a particular case of Bernoulli's principle. "Evangelista Torricelli found that water leaks out a small hole in the bottom of a container at a rate proportional to the square root of the depth of the water.

### **The Study of projectiles**

Torricelli studied projectiles and how they traveled through the air. "Perhaps his most notable achievement in the field of projectiles was to establish for the first time the idea of an envelope: projectiles sent out at [...] the same speed in all directions trace out parabolas which are all tangent to a common paraboloid. This envelope became known as the *parabola di sicurezza* (safety parabola)."

### **Cause of Wind**

Torricelli gave the first scientific description of the cause of wind:

*... winds are produced by differences of air temperature, and hence density, between two regions of the ear*

## Torr

The mm of mercury is sometimes called a torr after Torricelli, and Pascal also has been honored by a unit of pressure, a newton per square meter or 10 dyne/cm<sup>2</sup>. A cubic centimeter of air weighs 1.293 mg under standard conditions, and a cubic meter 1.293 kg, so air is by no means even approximately weightless, though it seems so.

The weight of a sphere of air as small as 10 cm in diameter is 0.68 g, easily measurable with a chemical balance. The pressure of the atmosphere is also considerable, like being 34 ft. under water, but we do not notice it. A bar is 106 dyne/cm<sup>2</sup>, very close to a standard atmosphere, which is 1.01325 bar. In meteorology, the millibar, mb, is used. 1 mb = 1.333 mmHg = 100 Pa = 1000 dyne/cm<sup>2</sup>.

A kilogram-force per square centimeter is 981,000 dyne/cm<sup>2</sup>, also close to one atmosphere. In Europe, it has been considered approximately 1 atm, as in tire pressures and other engineering applications.

As we have seen, in English units the atmosphere is about 14.7 psi, and this figure can be used to find other approximate equivalents. For example, 1 psi = 51.7 mmHg. In Britain, tons per square inch has been used for large pressures. The ton in this case is 2240 lb, not the American short ton. 1 tsi = 2240 psi, 1 tsf = 15.5 psi (about an atmosphere!).

The fluid in question here is air, which is by no means incompressible. As we rise in the atmosphere and the pressure decreases, the air also expands.

To see what happens in this case, we can make use of the ideal gas equation of state,  $p = \rho RT/M$ , and assume that the temperature  $T$  is constant. Then the change of pressure in a change of altitude  $dh$  is  $dp = -\rho g dh = -(\rho M/RT) g dh$ , or  $dp/p = -(Mg/RT) dh$ .

This is a little harder to integrate than before, but the result is  $\ln p = -Mgh/RT + C$ , or  $\ln (p/p_0) = -Mgh/RT$ , or finally  $p = p_0 \exp(-Mgh/RT)$ .

In an isothermal atmosphere, the pressure decreases exponentially. The quantity  $H = RT/Mg$  is called the "height of the homogeneous atmosphere" or the scale height, and is about 8 km at  $T = 273K$ .

This quantity gives the rough scale of the decrease of pressure with height. Of course, the real atmosphere is by no means isothermal close to the ground, but cools with height nearly linearly at about 6.5°C/km up to an altitude of about 11 km at middle latitudes, called the tropopause.

Above this is a region of nearly constant temperature, the stratosphere, and then at some higher level the atmosphere warms again to near its value at the surface. Of course, there are variations from the average values. When the temperature profile with height is known, we can find the pressure by numerical integration quite easily.

## Hydraulic Foundations and Theories Post Quiz

### Archimedes

1. Archimedes made many contributions to geometry in his work in the areas of plane figures and in the areas of area and volumes of curved surfaces. His methods started the idea for \_\_\_\_\_ which was "invented" 2,000 years later by Sir Isaac Newton and Gottfried Wilhelm von Leibniz.
2. Archimedes proved that the volume of an inscribed sphere is two-thirds the volume of a circumscribed cylinder. He requested that this formula/diagram be inscribed on his?

### Daniel Bernoulli

3. Daniel was the son of Johann Bernoulli (one of the "early developers" of calculus), nephew of Jakob Bernoulli (who "was the first to discover the \_\_\_\_\_"), and older brother of Johann II.
4. Daniel Bernoulli was described by W. W. Rouse Ball as "by far the ablest of the younger Bernoullis". He is said to have had a bad relationship with his father, Johann. Upon both of them entering and tying for first place in a scientific contest at the University of Paris, Johann, unable to bear the "shame" of being compared as Daniel's equal, banned?

### Blaise Pascal

5. Pascal's earliest work was in the natural and applied sciences where he made important contributions to the study of fluids, and clarified the concepts of pressure and vacuum by generalizing the work of?
6. In 1642, while still a teenager, he started some pioneering work on calculating machines. After three years of effort and fifty prototypes, he invented the?
7. Between 1658 and 1659 he wrote on the \_\_\_\_\_ and its use in calculating the volume of solids. Pascal had poor health especially after his 18th year and his death came just two months after his 39th birthday.

### Evangelista Torricelli

8. Evangelista Torricelli (1608-1647), \_\_\_\_\_ student and secretary and a member of the Florentine Academy of Experiments, invented the mercury barometer in 1643, and brought the weight of the atmosphere to light.

**Burgomeister of Magdeburg**

9. Famously, he evacuated a sphere consisting of two well-fitting hemispheres about a foot in diameter, and showed that \_\_\_\_\_, could not pull them apart.

10. Pascal demonstrated that the siphon worked by atmospheric pressure, not by?

**Answers** 1. Calculus, 2. Tomb, 3. Theory of probability, 4. Daniel from his house, 5. Evangelista Torricelli, 6. Mechanical calculator, 7. Cycloid, 8. Galileo's, 9. 16 horses, 8 on each side, 10. Horror vacui

## Hydraulic Foundations and Theories References

- "Archimedes – The Palimpsest". Walters Art Museum.
- "Archimedes (c.287 - c.212 BC)". BBC History.
- "Archimedes of Syracuse". The MacTutor History of Mathematics archive. January 1999. Retrieved 2008-06-09.
- "Archimedes' Weapon". Time Magazine. November 26, 1973.
- "Archimedes". Collins Dictionary.
- "Blaise Pascal on Duplicity, Sin, and the Fall". global.oup.com.
- "Blaise Pascal". Catholic Encyclopedia.
- "CEMC – Pascal, Cayley and Fermat – Mathematics Contests – University of Waterloo". Cemc.uwaterloo.ca.
- "Chaires Blaise Pascal". Chaires Blaise Pascal. Archived from the original on 13 June 2009.
- "Daniel Bernoulli", Encyclopædia Britannica
- "Incompressibility of Water". Harvard University.
- "Library and Archive Catalogue". Royal Society.
- "Pascal". Random House Webster's Unabridged Dictionary.
- "SS Archimedes". wrecksite.eu.
- "The Death of Archimedes: Illustrations". math.nyu.edu. New York University.
- "The Mathematical Leibniz". Math.rutgers.edu.
- "World's Largest Solar Furnace". Atlas Obscura.
- A complete list of known Pascalines and also a review of contemporary replicas can be found at Surviving Pascalines and Replica Pascalines at <http://things-that-count.net>
- Anderson, John David (1997). A History of Aerodynamics and its Impact on Flying Machines. New York, NY: Cambridge University Press. ISBN 0-521-45435-2.
- Aristotle, Physics, VII, 1.
- Aubert, André (1989). "Prehistory of the Zeta-Function". In Bombieri and Goldfeld, eds.
- Blower, S; Bernoulli, D (2004). "An attempt at a new analysis of the mortality caused by smallpox and of the advantages of inoculation to prevent it" (PDF). Reviews in medical virology.
- Bonsor, Kevin. "How Wildfires Work". HowStuffWorks. Archived from the original on 14 July 2007. Retrieved 2001-07-23.
- Bursill-Hall, Piers. "Galileo, Archimedes, and Renaissance engineers". sciencelive with the University of Cambridge. Archived from the original on 2007-09-29. Retrieved 2007-08-07.
- Calinger, Ronald (1999). A Contextual History of Mathematics. Prentice-Hall. p. 150. ISBN 0-02-318285-7. Shortly after Euclid, compiler of the definitive textbook, came Archimedes of Syracuse (ca. 287 212 BC), the most original and profound mathematician of antiquity.
- Carroll, Bradley W. "Archimedes' Claw – watch an animation". Weber State University. Archived from the original on 13 August 2007. Retrieved 2006-08-12.
- Carroll, Bradley W. "Archimedes' Principle". Weber State University. Archived from the original on 8 August 2007. Retrieved 2004-07-23.
- Casson, Lionel (1971). Ships and Seamanship in the Ancient World. Princeton University Press. ISBN 0-691-03536-9.
- Charles Perrault, Parallèle des Anciens et des Modernes (Paris, 1693), Vol. I, p. 296.
- Connor, James A., Pascal's wager: the man who played dice with God (HarperCollins, NY, 2006) ISBN 0-06-076691-3 p. 42
- Connor, James A., Pascal's wager: the man who played dice with God (HarperCollins, NY, 2006) ISBN 0-06-076691-3 p. 70
- Cooter & Ulen (2016), pp. 44–45.

Dalley, Stephanie; Oleson, John Peter. "Sennacherib, Archimedes, and the Water Screw: The Context of Invention in the Ancient World". *Technology and Culture* Volume 44, Number 1, January 2003 (PDF). Retrieved 2007-07-23.

David Pengelley - "Pascal's Treatise on the Arithmetical Triangle"  
de Gandt (1987). *L'oeuvre de Torricelli*. Les Belles Lettres.

Devlin, Keith, *The Unfinished Game: Pascal, Fermat, and the Seventeenth-Century Letter that Made the World Modern*, Basic Books; 1 edition (2008), ISBN 978-0-465-00910-7, p. 20.

Devlin, Keith, *The Unfinished Game: Pascal, Fermat, and the Seventeenth-Century Letter that Made the World Modern*, Basic Books; 1 edition (2008), ISBN 978-0-465-00910-7, p. 24.

d'Ocagne, Maurice (1893). *Le calcul simplifié* (in French). Gauthier-Villars et fils. p. 245.

Driver, R. (May 1998). "Torricelli's Law: An Ideal Example of an Elementary ODE". *The American Mathematical Monthly*. 105 (5): 454. doi:10.2307/3109809. JSTOR 3109809.

English translation in Bernoulli, D. (1954). "Exposition of a New Theory on the Measurement of Risk" (PDF). *Econometrica*. 22 (1): 23–36. doi:10.2307/1909829. JSTOR 1909829.

Fuels and Chemicals – Auto Ignition Temperatures

Hald, Anders A *A History of Probability and Statistics and Its Applications before 1750*, (Wiley Publications, 1990) pp.44

Heath, T. L., *Works of Archimedes*, 1897

Hippias, 2 (cf. Galen, *On temperaments* 3.2, who mentions pyreia, "torches"); Anthemius of Tralles, *On miraculous engines* 153 [Westerman].

HyperPhysics. "Buoyancy". Georgia State University. Archived from the original on 14 July 2007. Retrieved 2007-07-23.

Jacqueline Pascal, "Memoir" p. 87

Jervis-Smith, Frederick John (1908). *Evangelista Torricelli*. Oxford University Press. p. 9. ISBN 9781286262184.

John Wesley. "A Compendium of Natural Philosophy (1810) Chapter XII, Burning Glasses".  
Jump up

Kieren MacMillan, Jonathan Sondow (2011). "Proofs of power sum and binomial coefficient congruences via Pascal's identity". *American Mathematical Monthly*. 118: 549–551. arXiv:1011.0076?. doi:10.4169/amer.math.monthly.118.06.549.

Knorr, Wilbur R. (1978). "Archimedes and the spirals: The heuristic background". *Historia Mathematica*. Elsevier. 5 (1): 43–75. "To be sure, Pappus does twice mention the theorem on the tangent to the spiral [IV, 36, 54]. But in both instances the issue is Archimedes' inappropriate use of a "solid neusis," that is, of a construction involving the sections of solids, in the solution of a plane problem. Yet Pappus' own resolution of the difficulty [IV, 54] is by his own classification a "solid" method, as it makes use of conic sections." (page 48)

Mancosu, Paolo; Ezio, Vailati (1991). "Torricelli's Infinitely Long Solid and Its Philosophical

Mangold, Max (1990) *Duden — Das Aussprachewörterbuch*. 3. Auflage.  
Mannheim/Wien/Zürich, Dudenverlag.

Marcel Berthelot - *Sur l'histoire de la balance hydrostatique et de quelques autres appareils et procédés scientifiques*, *Annales de Chimie et de Physique* [série 6], 23 / 1891, pp. 475-485

Mary Jaeger. *Archimedes and the Roman Imagination*, p. 113.

MathPages, *Hold Your Horses*. For the sources on which the hypothesis of a link between a carriage accident and Pascal's second conversion is based, and for a sage weighing of the evidence for and against, see Henri Gouhier, *Blaise Pascal: Commentaires*, Vrin, 1984, pp. 379ff.

Miel, Jan. *Pascal and Theology*. (Balt: Johns Hopkins University Press, 1969), p. 122-124

MIT, "Inventor of the Week Archive: Pascal: Mechanical Calculator", May 2003. "Pascal worked on many versions of the devices, leading to his attempt to create a perpetual motion machine.



He has been credited with introducing the roulette machine, which was a by-product of these experiments."

Mourlevat, Guy (1988). *Les machines arithmétiques de Blaise Pascal* (in French). Clermont-Ferrand: La Française d'Édition et d'Imprimerie. p. 12.

Muir, Jane. *Of Men and Numbers*. (New York: Dover Publications, Inc, 1996). ISBN 0-486-28973-7, p. 103-104.

Number Theory, Trace Formulas and Discrete Groups. Academic Press.

O. A. W. Dilke. *Gnomon*. 62. Bd., H. 8 (1990), pp. 697-699 Published by: Verlag C.H.Beck

O'Connor, J.J.; Robertson, E.F. "Archimedes of Syracuse". University of St Andrews. Archived from the original on 6 February 2007.

O'Connor, J.J.; Robertson, E.F. (August 2006). "Étienne Pascal". University of St. Andrews, Scotland.

O'Connor, J.J.; Robertson, E.F. (February 1996). "A history of calculus". University of St Andrews. Archived from the original on 15 July 2007. Retrieved 2007-08-07.

O'Connor, John J.; Robertson, Edmund F., "Daniel Bernoulli", MacTutor History of Mathematics archive, University of St Andrews. (1998)

Online text at Wesley Center for Applied Theology. Archived from the original on 2007-10-12. Retrieved 2005-09-14.

Pascal, Blaise. *Oeuvres complètes*. (Paris: Seuil, 1960), p. 618

Périer to Pascal, 22 September 1648, Pascal, Blaise. *Oeuvres complètes*. (Paris: Seuil, 1960), 2:682.

Plutarch. "Parallel Lives Complete e-text from Gutenberg.org". Project Gutenberg. Retrieved 2007-07-23.

Pour faire qu'une hypothèse soit évidente, il ne suffit pas que tous les phénomènes s'en ensuivent, au lieu que, s'il s'ensuit quelque chose de contraire à un seul des phénomènes, cela suffit pour assurer de sa fausseté, in *Les Lettres de Blaise Pascal: Accompagnées de Lettres de ses Correspondants Publiées*, ed. Maurice Beaufreton, 6th edition (Paris: G. Crès, 1922), 25–26, available at <http://gallica.bnf.fr> and translated in Saul Fisher, *Pierre Gassendi's Philosophy and Science: Atomism for Empiricists Brill's Studies in Intellectual History* 131 (Leiden: E. J. Brill, 2005), 126 n.7

Reception in the Seventeenth Century". *Isis*. 82 (1): 50–70. doi:10.1086/355637.

Richard H. Popkin, Paul Edwards (ed.), *Encyclopedia of Philosophy*, 1967 edition, s.v. "Pascal, Blaise.", vol. 6, p. 52–55, New York: Macmillan

Robinson, Philip (March 1994). "Evangelista Torricelli". *The Mathematical Gazette* 78 (481): 37.

Rorres, Chris. "Archimedes' Claw – Illustrations and Animations – a range of possible designs for the claw". Courant Institute of Mathematical Sciences. Retrieved 2007-07-23.

Rorres, Chris. "Archimedes' screw – Optimal Design". Courant Institute of Mathematical Sciences.

Rorres, Chris. "Death of Archimedes: Sources". Courant Institute of Mathematical Sciences.

Rorres, Chris. "Siege of Syracuse". Courant Institute of Mathematical Sciences.

Rorres, Chris. "The Golden Crown". Drexel University.

Rorres, Chris. "The Golden Crown: Galileo's Balance". Drexel University.

Rorres, Chris. "Tomb of Archimedes – Illustrations". Courant Institute of Mathematical Sciences. Retrieved 2011-03-15.

Rorres, Chris. "Tomb of Archimedes: Sources". Courant Institute of Mathematical Sciences.

Archived from the original on 9 December 2006. Retrieved 2007-01-02.

Ross, John F. (2004). "Pascal's legacy". *EMBO Reports*. 5 (Suppl 1): S7–S10.

doi:10.1038/sj.embor.7400229. PMC 1299210?. PMID 15459727.

Rothbard, Murray. *Daniel Bernoulli and the Founding of Mathematical Economics*, Mises Institute (excerpted from *An Austrian Perspective on the History of Economic Thought*)

Rouse Ball, W. W. (2003) [1908]. "The Bernoullis". A Short Account of the History of Mathematics (4th ed.). Dover. ISBN 0-486-20630-0.

Sainte-Beuve, Seventeenth Century ISBN 1-113-16675-4 p. 174 (2009 reprint).

See Schickard versus Pascal: An Empty Debate? and Marguin, Jean (1994). Histoire des instruments et machines à calculer, trois siècles de mécanique pensante 1642–1942 (in French). Hermann. p. 48. ISBN 978-2-7056-6166-3.

Segre, Michael (1991) In the wake of Galileo. New Brunswick: Rutgers University Press.

Shampo, M. A.; Kyle, R A (March 1986). "Italian physicist-mathematician invents the barometer". Mayo Clin. Proc. 61 (3): 204. doi:10.1016/s0025-6196(12)61850-3. PMID 3511332.

Stanford Encyclopedia of Philosophy: "The St. Petersburg Paradox by R. M. Martin

The Story of Civilization: Volume 8, "The Age of Louis XIV" by Will & Ariel Durant; chapter II, subsection 4.1 p.56)

The Story of Civilization: Volume 8, "The Age of Louis XIV" by Will & Ariel Durant, chapter II, Subsection 4.4, p. 66 ISBN 1-56731-019-2

The Turner Collection, Keele University, includes Bernoulli's diagram to illustrate how pressure is measured. See also part of Bernoulli's original Latin explanation.

Timbs, John (1868). Wonderful Inventions: From the Mariner's Compass to the Electric Telegraph Cable. London: George Routledge and Sons. p. 41. ISBN 978-1172827800.

Vincent Jullien (ed.), Seventeenth-Century Indivisibles Revisited, Birkhäuser, 2015, p. 188.

Vitruvius. "De Architectura, Book IX, paragraphs 9–12, text in English and Latin". University of Chicago. Retrieved 2007-08-30.

## Section 6 –Pumps and Pumping Water

**Section Focus:** You will learn the basics of various pumps. At the end of this section, you will be able to describe water pumps and the associated hydraulic principles. There is a post quiz at the end of this section to review your comprehension and a final examination in the Assignment for your contact hours.

**Scope/Background:** The main purpose of this section is to provide understanding of various water lifting procedures, basic pump fundamentals, hydraulic principles, theory, and maintenance.

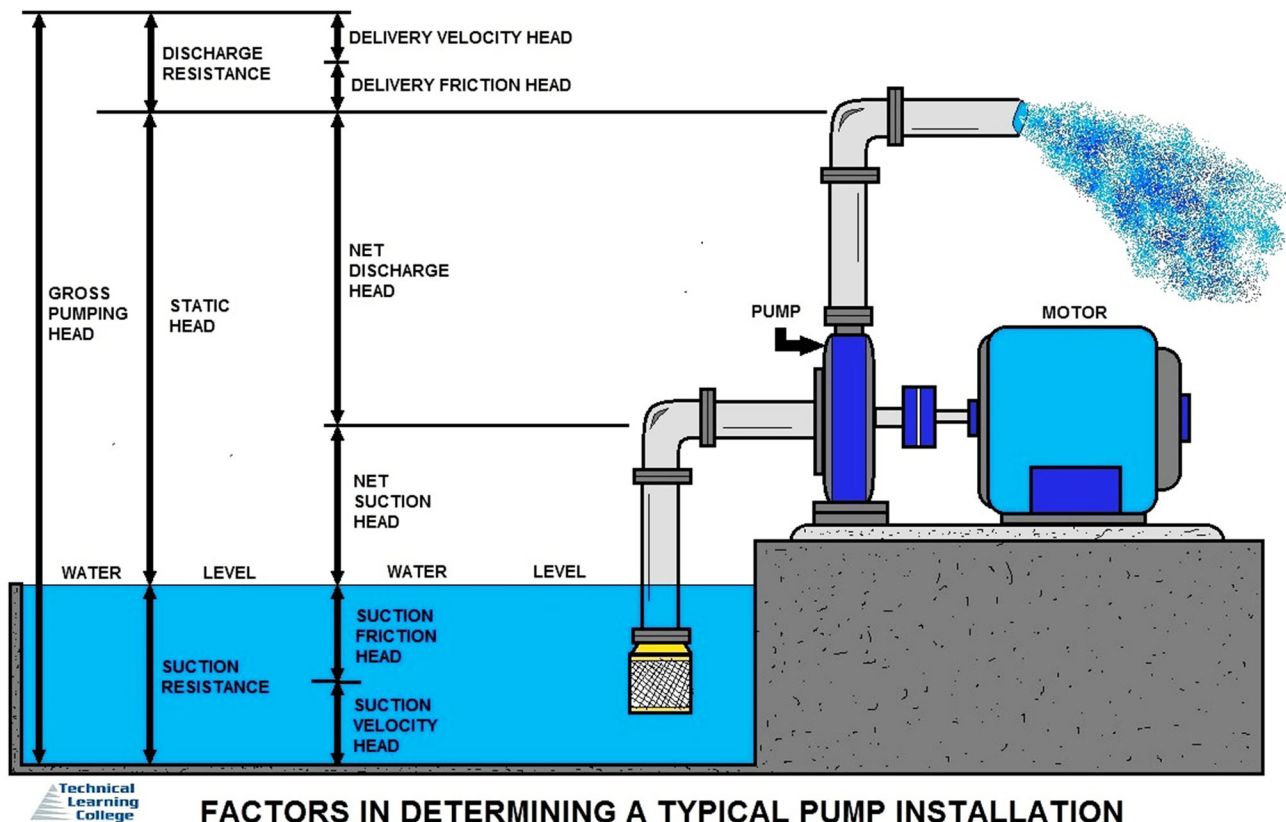

### Pump Introduction

Moving fluids plays a major role in the process of a plant. Liquid can only move on its own power from top to bottom or from a high pressure to a lower pressure system. This means that energy to the liquid must be added to move the liquid from a low to a higher level.

To add the required energy to liquids, pumps are used. There are many different definitions of a pump but it can be described as: A machine used for the purpose of transferring quantities of liquids, gases and even solids from one location to another.

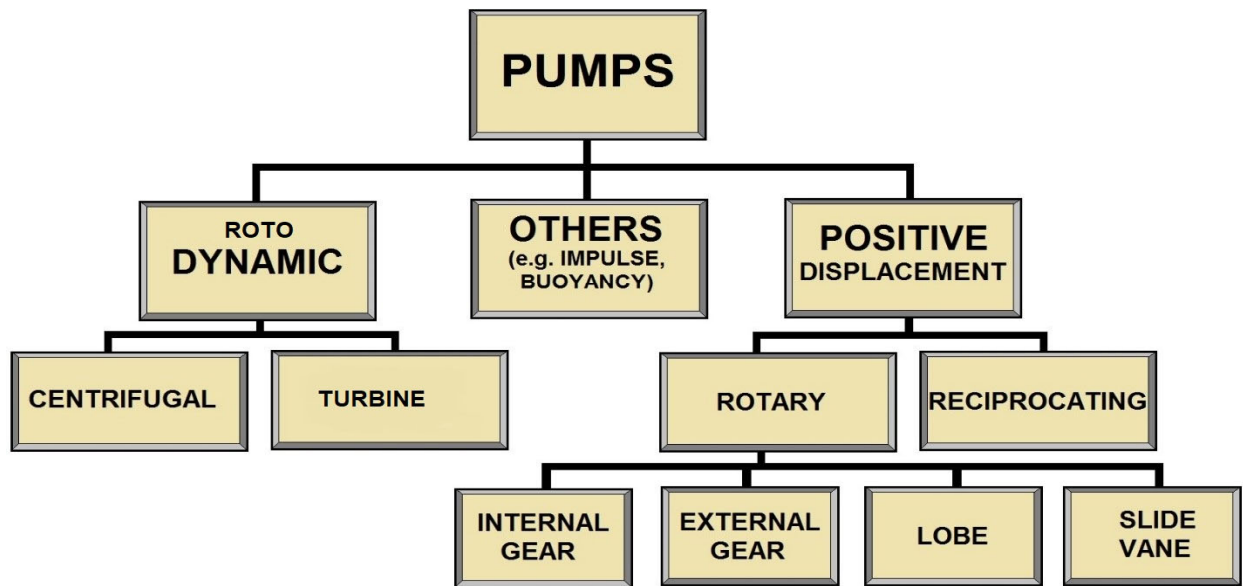

## PUMP CATEGORIES

### Types of Pumps

Pump types generally fall into two main categories - Rotodynamic and Positive Displacement, of which there are many forms.

The Rotodynamic pump transfers rotating mechanical energy into kinetic energy in the form of fluid velocity and pressure. The Centrifugal and Liquid Ring pumps are types of rotodynamic pump, which utilize centrifugal force to transfer the fluid being pumped.

The Rotary Lobe pump is a type of positive displacement pump, which directly displaces the pumped fluid from pump inlet to outlet in discrete volumes.

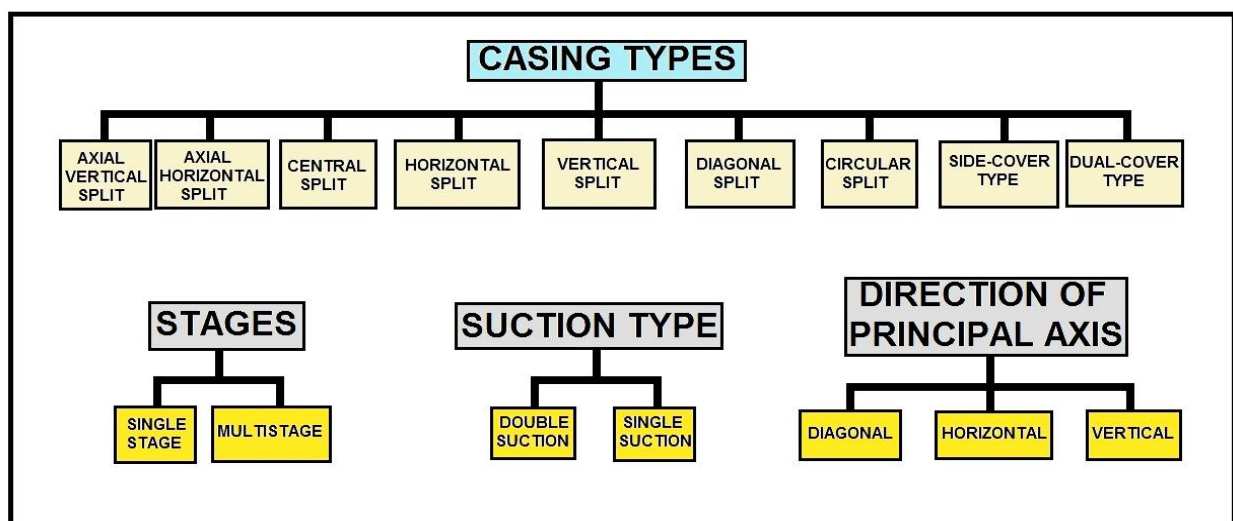

## PUMP CONFIGURATIONS

# Pumps and Pumping Water - Introduction

## General Pumping Fundamentals

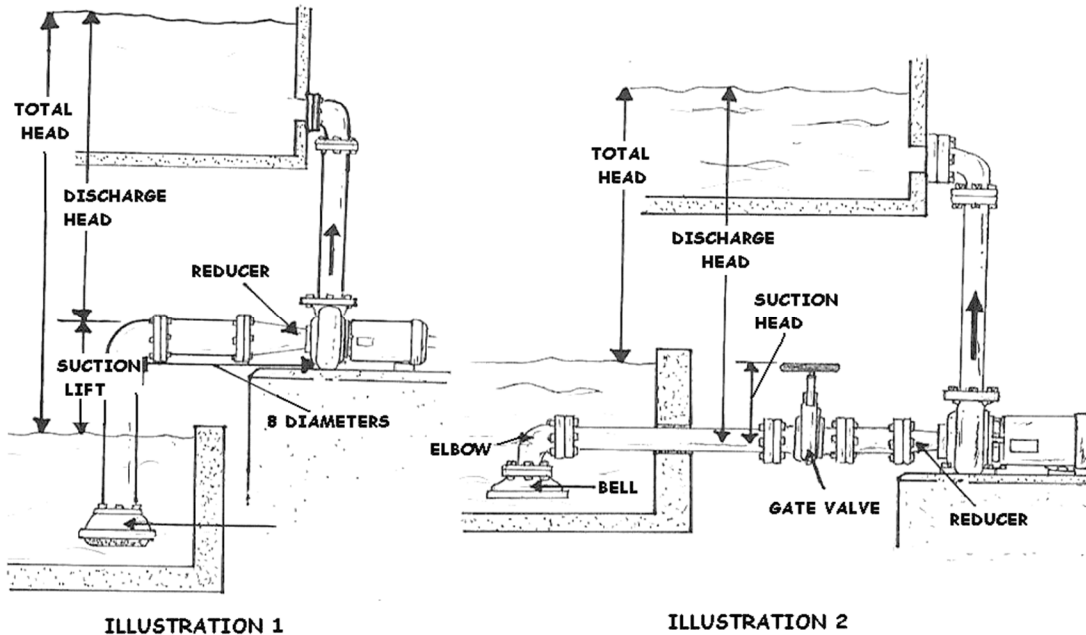

Here are the important points to consider about suction piping when the liquid being pumped is below the level of the pump:

- First, suction lift is when the level of water to be pumped is below the centerline of the pump. Sometimes suction lift is also referred to as '**negative suction head**'.
- The ability of the pump to lift water is the result of a partial vacuum created at the center of the pump.
- This works similar to sucking soda from a straw. As you gently suck on a straw, you are creating a vacuum or a pressure differential. Less pressure is exerted on the liquid inside the straw, so that the greater pressure is exerted by the atmosphere on the liquid around the outside of the straw, causing the liquid in the straw to move up. By sucking on the straw, this allows atmospheric pressure to move the liquid.
- Look at the diagram illustrated as "1". The foot valve is located at the end of the suction pipe of a pump. It opens to allow water to enter the suction side, but closes to prevent water from passing back out of the bottom end.
- The suction side of pipe should be one diameter larger than the pump inlet. The required eccentric reducer should be turned so that the top is flat and the bottom tapered.

Notice in illustration "2" that the liquid is above the level of the pump. Sometimes this is referred to as '**flooded suction**' or '**suction head**' situations.

**Points to Note are:**

If an elbow and bell are used, they should be at least one pipe diameter from the tank bottom and side. This type of suction piping must have a gate valve which can be used to prevent the reverse flow when the pump has to be removed. In the illustrations you can see in both cases the discharge head is from the centerline of the pump to the level of the discharge water. The total head is the difference between the two liquid levels.

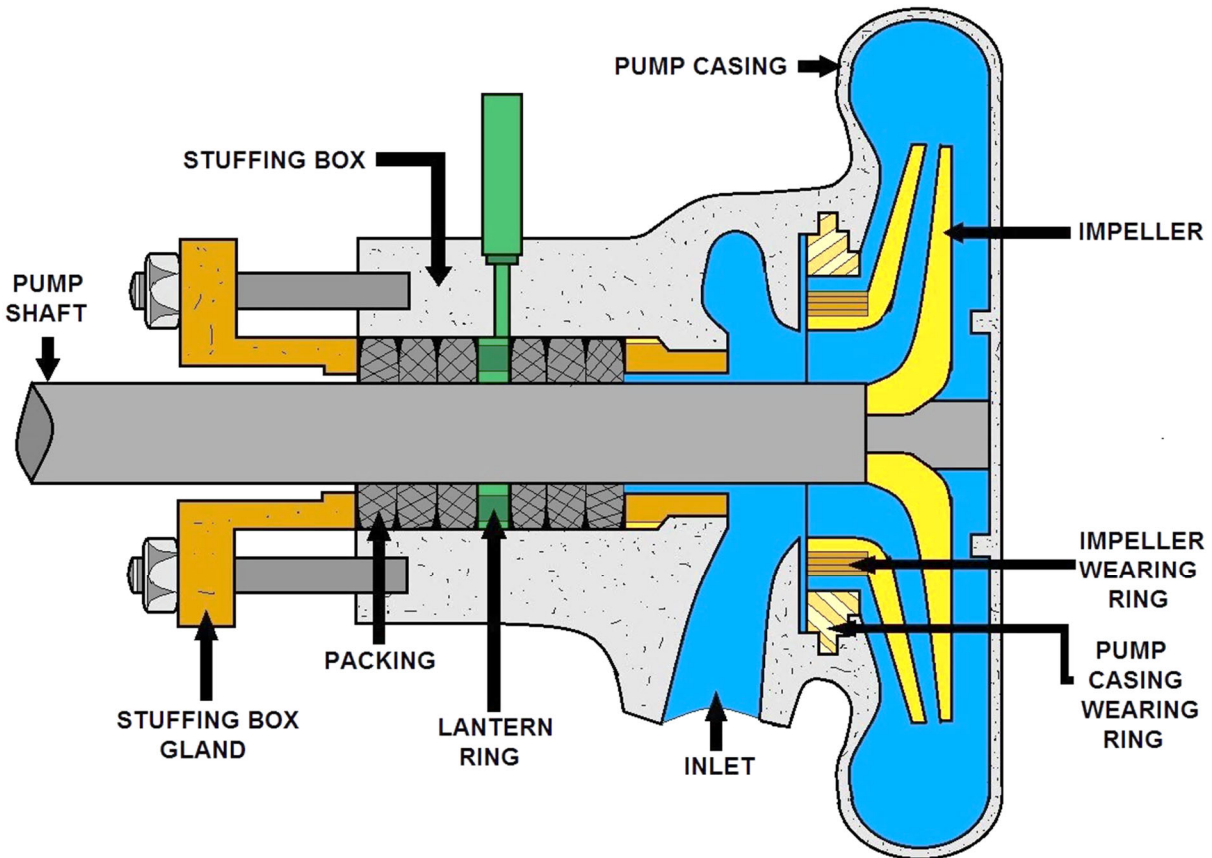

**CENTRIFUGAL PUMP BREAKDOWN**

**A centrifugal pump has two main components:**

- I. A rotating component comprised of an impeller and a shaft
- II. A stationary component comprised of a casing, casing cover, and bearings.

*We will cover this pump and other complicated pumps in detail in the next section.*

## Common Types of Water Pumps

The most common type of water pumps used for municipal and domestic water supplies are *variable displacement* pumps another term for dynamic pumps. A variable displacement pump will produce at different rates relative to the amount of pressure or lift the pump is working against. *Centrifugal* pumps are variable displacement pumps that are by far used the most. The water production well industry almost exclusively uses *Turbine* pumps, which are a type of centrifugal pump.

The turbine pump utilizes *impellers* enclosed in single or multiple *bowls or stages* to lift water by *centrifugal force*. The impellers may be of either a *semi-open or closed type*. Impellers are rotated by the *pump motor*, which provides the horsepower needed to overcome the pumping head. A more thorough discussion of how these and other pumps work is presented later in this section. The size and number of stages, horsepower of the motor and pumping head are the key components relating to the pump's lifting capacity.

**Vertical turbine pumps** are commonly used in groundwater wells but also in many other applications. These pumps are driven by a shaft rotated by a motor that is usually found on the surface. The shaft turns the impellers within the pump housing while the water moves up the column.

This type of pumping system is also called a *line-shaft turbine*. The rotating shaft in a line shaft turbine is actually housed within the column pipe that delivers the water to the surface. The size of the column, impeller, and bowls are selected based on the desired pumping rate and lift requirements.

Column pipe sections can be threaded or coupled together while the drive shaft is coupled and suspended within the column by *spider bearings*. The spider bearings provide both a seal at the column pipe joints and keep the shaft aligned within the column. The water passing through the column pipe serves as the lubricant for the bearings. Some vertical turbines are lubricated by oil rather than water. These pumps are essentially the same as water lubricated units; only the drive shaft is enclosed within an *oil tube*.

Food grade oil is supplied to the tube through a gravity feed system during operation. The oil tube is suspended within the column by *spider flanges*, while the line shaft is supported within the oil tube by *brass or redwood bearings*. A continuous supply of oil lubricates the drive shaft as it proceeds downward through the oil tube.

A small hole located at the top of the pump bow unit allows excess oil to enter the well. This results in the formation of an oil film on the water surface within oil-lubricated wells. Careful operation of oil lubricated turbines is needed to ensure that the pumping levels do not drop enough to allow oil to enter the pump. Both water and oil lubricated turbine pump units can be driven by electric or fuel powered motors. Most installations use an electric motor that is connected to the drive shaft by a keyway and nut.

However, where electricity is not readily available, fuel powered engines may be connected to the drive shaft by a right angle drive gear. Also, both oil and water lubricated systems will have a strainer attached to the intake to prevent sediment from entering the pump.

When the line shaft turbine is turned off, water will flow back down the column, turning the impellers in a reverse direction. A pump and shaft can easily be broken if the motor were to turn on during this process.

This is why a *time delay* or *ratchet* assembly is often installed on these motors to either prevent the motor from turning on before reverse rotation stops or simply not allow it to reverse at all.

### **Three Main Types of Diaphragm Pumps**

In the first type, the diaphragm is sealed with one side in the fluid to be pumped, and the other in air or hydraulic fluid. The diaphragm is flexed, causing the volume of the pump chamber to increase and decrease. A pair of non-return check valves prevents reverse flow of the fluid.

The second type of diaphragm pump works with volumetric positive displacement, but differs in that the prime mover of the diaphragm is neither oil nor air; but is electro-mechanical, working through a crank or geared motor drive. This method flexes the diaphragm through simple mechanical action, and one side of the diaphragm is open to air.

The third type of diaphragm pump has one or more unsealed diaphragms with the fluid to be pumped on both sides. The diaphragm(s) again are flexed, causing the volume to change.

When the volume of a chamber of either type of pump is increased (the diaphragm moving up), the pressure decreases, and fluid is drawn into the chamber. When the chamber pressure later increases from decreased volume (the diaphragm moving down), the fluid previously drawn in is forced out. Finally, the diaphragm moving up once again draws fluid into the chamber, completing the cycle. This action is similar to that of the cylinder in an internal combustion engine.

### **Cavitation**

Cavitation is defined as the phenomenon of formation of vapor bubbles of a flowing liquid in a region where the pressure of the liquid falls below its vapor pressure.

Cavitation is usually divided into two classes of behavior: inertial (or transient) cavitation and non-inertial cavitation. Inertial cavitation is the process where a void or bubble in a liquid rapidly collapses, producing a shock wave. Such cavitation often occurs in pumps, propellers, impellers, and in the vascular tissues of plants. Non-inertial cavitation is the process in which a bubble in a fluid is forced to oscillate in size or shape due to some form of energy input, such as an acoustic field. Such cavitation is often employed in ultrasonic cleaning baths and can also be observed in pumps, propellers etc.

Cavitation is, in many cases, an undesirable occurrence. In devices such as propellers and pumps, cavitation causes a great deal of noise, damage to components, vibrations, and a loss of efficiency. When the cavitation bubbles collapse, they force liquid energy into very small volumes, thereby creating spots of high temperature and emitting shock waves, the latter of which are the source of rattling noise. The noise created by cavitation is a particular problem for military submarines, as it increases the chances of being detected by passive sonar.

Although the collapse of a cavity is a relatively low-energy event, highly localized collapses can erode metals, such as steel, over time. The pitting caused by the collapse of cavities produces great wear on components and can dramatically shorten a propeller's or pump's lifetime.



## Simple Pumps Sub-Section

### Screw or Auger Pump

The Archimedes' screw, Archimedean screw, or screw pump is a machine historically used for transferring water from a low-lying body of water into irrigation ditches. It was one of several inventions and discoveries traditionally attributed to Archimedes in the 3rd century BC.

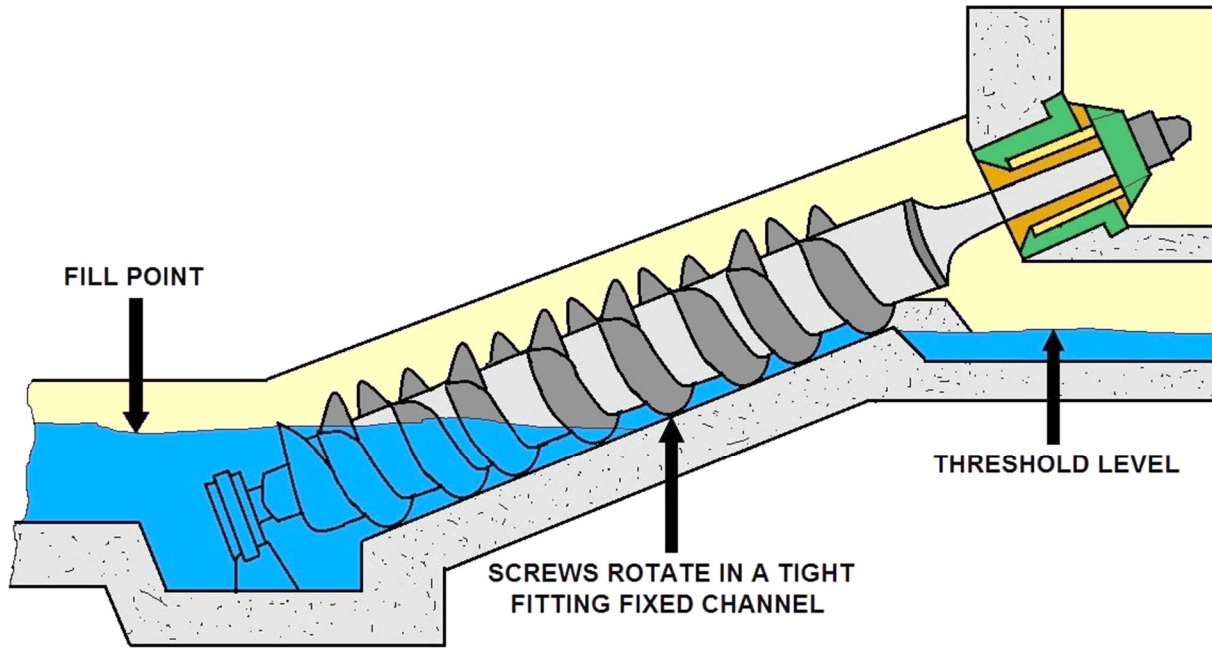

### AUGER PUMP DIAGRAM

The machine consists of a screw inside a hollow pipe. Some attribute its invention to Archimedes in the 3rd century BC, while others attribute it to Nebuchadnezzar II in the 7th century BC. A screw can be thought of as an inclined plane (another simple machine) wrapped around a cylinder.

The screw is turned (usually by a windmill or by manual labor). As the bottom end of the tube turns, it scoops up a volume of water. This amount of water will slide up in the spiral tube as the shaft is turned, until it finally pours out from the top of the tube and feeds the irrigation system.

The contact surface between the screw and the pipe does not need to be perfectly water-tight because of the relatively large amount of water being scooped at each turn with respect to the angular speed of the screw.

Also, water leaking from the top section of the screw leaks into the previous one and so on. So a sort of equilibrium is achieved while using the machine, thus preventing a decrease in efficiency.

The "screw" does not necessarily need to turn inside the casing, but can be allowed to turn with it in one piece. A screw could be sealed with pitch or some other adhesive to its casing, or, cast as a single piece in bronze, as some researchers have postulated as being the devices used to irrigate Nebuchadnezzar II's Hanging Gardens of Babylon.

Depictions of Greek and Roman water screws show the screws being powered by a human treading on the outer casing to turn the entire apparatus as one piece, which would require that the casing be rigidly attached to the screw.

In this type of pump, a large screw provides the mechanical action to move the liquid from the suction side to the discharge side of the pump. Here are some typical characteristics of screw pumps:

- ☞ Most screw pumps rotate in the 30 to 60 rpm range, although some screw pumps are faster.
- ☞ The slope of the screw is normally either 30° or 38°.

The maximum lift for the larger diameter pumps is about 30 feet. The smaller diameter pumps have lower lift capabilities.

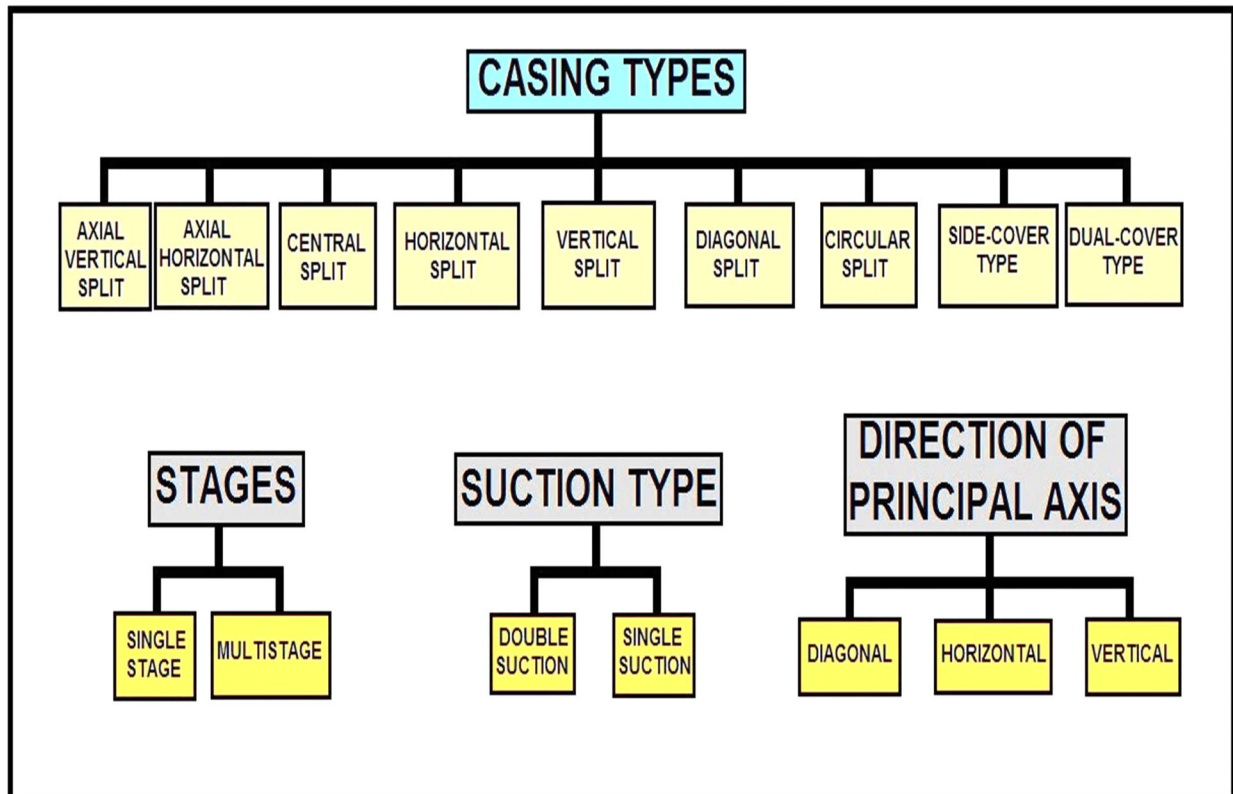

**PUMP CONFIGURATION DIAGRAM**

## Rope Pump Sub-Section

Devised in China as chain pumps over 1000 years ago, these pumps can be made from very simple materials: A rope, a wheel and a PVC pipe are sufficient to make a simple rope pump. For this reason, they have become extremely popular around the world since the 1980s. Rope pump efficiency has been studied by grass roots organizations and the techniques for making and running them has been continuously improved.

The pumping elements of the rope pump are the pistons and the endless rope, which pull the water to the surface through the pumping pipe made of PVC or plastic. The rotation of the wheel, moved by the handle, pulls the rope and the pistons. The pistons, made of polypropylene or polyethylene injected into molds, are of high precision to prevent hydraulic losses.

The structure is basically made out of angle iron, piping and concrete steel. The pulley wheel is made out of the two internal rings cut out of truck tires and joined by staples and spokes, which must be strong for intensive use. A guide box at the bottom of the well leads the rope into the pumping pipe. The guide box is made out of concrete with an internal glazed ceramic piece to prevent any wear. The rope pump can be operated by the whole family and is also used at the community level, for small agriculture production or cattle watering. It is also a high efficiency and low cost technology, but includes some pieces of high precision and high quality.

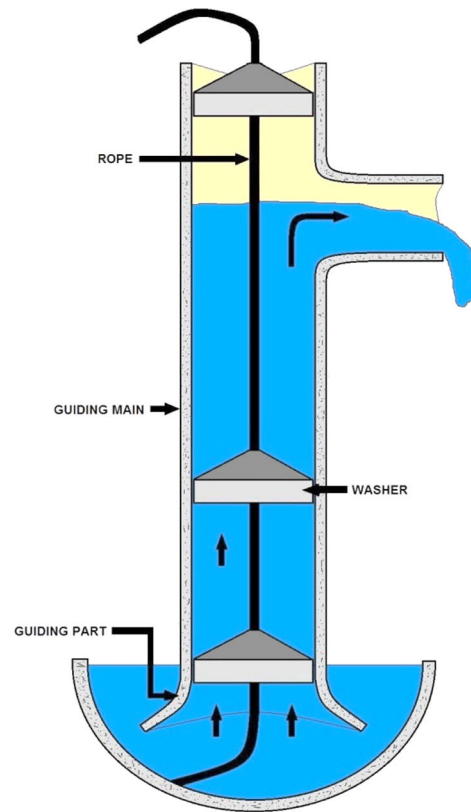

**ROPE PUMP DESIGN**

### The Guide

The guide is installed at the bottom of the well and is where the pumping process is initiated. Its function consists of guiding the rope with pistons attached so that it enters into the pumping pipe from below, as well as maintaining the pipes taut (plumbed) with the appropriate tension. Therefore, the guide has various functions integrated into one piece. It serves as well as a counterweight to tauten the rope in order to avoid sliding on the wheel.

The guide is a concrete box with a base piece, an entry pipe, a pumping pipe and support pipe, and a ceramic piece inside.

These parts of the guide must be made in such a way that the rope never touches the concrete, which would cause wear to it as well as to the pistons. In the production are no iron parts involved and therefore, the rope pump is not susceptible to rust problems and can be used in very corrosive water. The entry and pumping pipes on the guide have a wide mouth to facilitate the entry of the rope and pistons.

The water enters the guide through the base piece (2" PVC pipe) located at about five centimeters from the bottom of the guide. The guide itself is placed on the bottom of the well. This allows practically all of the water to be drained from the well.

This is important when a well has very little water, as water can still be extracted, which would not be the case with a bucket and rope.

### The Ceramic Piece

The ceramic piece in the center of the guide has a design that was developed based on practical work and corresponds to various needs at the moment of assembly. The ceramic piece is shaped like a horse saddle to stop the rope from leaving the canal formed by the saddle. The ceramic piece is made of refractory clay similar to white porcelain. Its vitrification temperature is between 1250° C and 1300° C. The ceramic piece has a coat of enamel, which makes it completely smooth there where it touches the rope. This enamel does not wear.

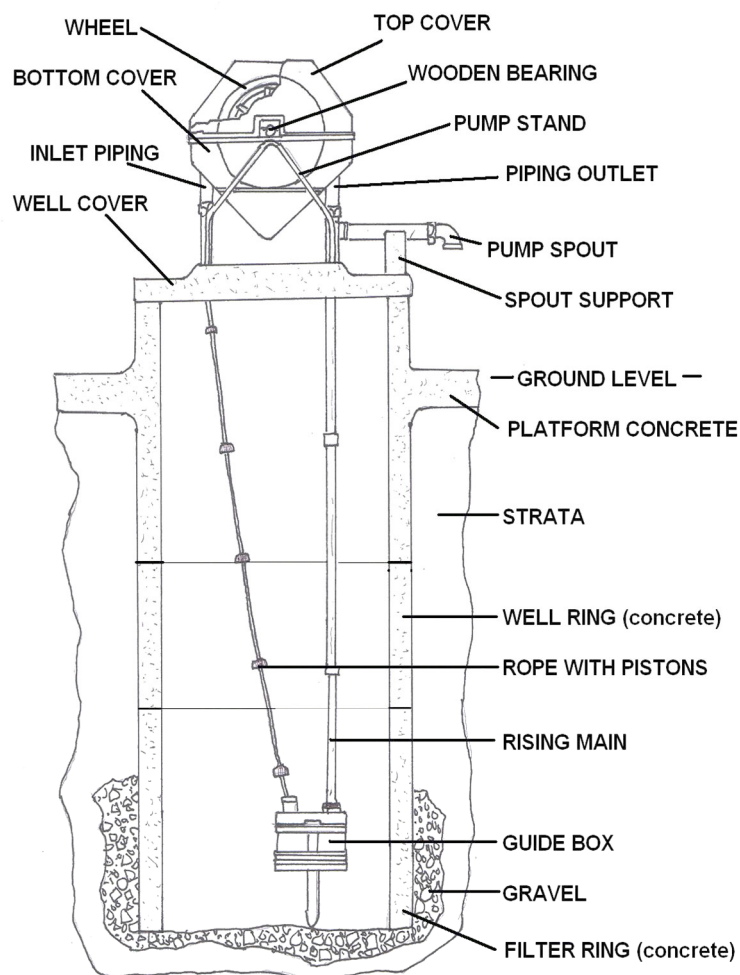

**ROPE PUMP**

## Wheel

The function of the rope pump structure is to support the efforts of the axle, wheel, and crank, as well as fix the pumping pipe, both entry and exit sections. It is the esthetic part (Visible) of the pump and is installed on the well cover. The types of materials and their diameters depend on the use given to the equipment. The structure is basically made out of pipes, iron rods, iron strip and angle iron. The pulley wheel is made out of the two internal rings cut out of truck tires and joined by clamps and spokes, which must be strong for intensive use. The 20" inch truck tires are used, but for wells deeper than 29 meters 16" inch tires are used.

## Pistons

The pistons are one of the most sensitive parts of the pump. Together with the rope they form an endless chain. When the rope rotates it leads the piston through the pumping pipe, pushing the water inside upwards.

### ROPE PUMP

ROTATING MOVEMENT  
(constant force)

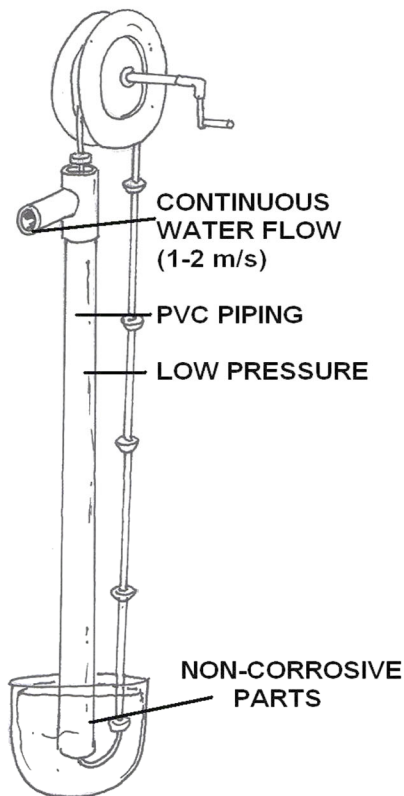

### PISTON PUMP

RECIPROCATING MOVEMENT  
(dynamic force)

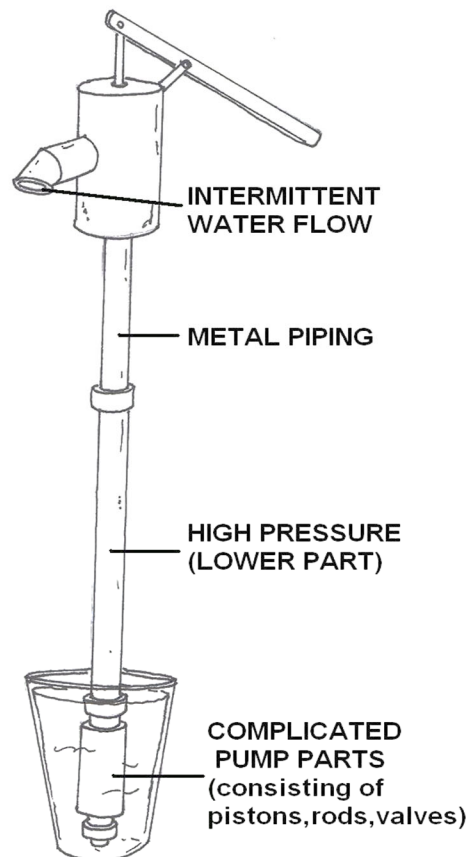

**The piston is a cone shaped part with a hole on its top and must meet the following norms:**

- ✓ Exact dimensions.
- ✓ Cone shape to reduce friction.
- ✓ Strong and water-resistant material.
- ✓ The piston diameters vary with depth as do the pumping pipe.
- ✓ Piston diameter is determined by the type of pipe to be used and the well's depth. Pistons should be made of injected polypropylene or polyethylene. Neither rubber nor wood are recommended.
- ✓ The rope's length, diameter and amount of pistons are determined by the well's depth.
- ✓ Two-inch (0 - 3.5 meters depth) and 1 ½" inch (3.5 - 5 meters depth) pistons are used in wells which are not too deep or when motor driven rope pumps are used.
- ✓ A perfect fit is required between the pistons and the pumping pipe. The space between piston and inner wall of the pipe is only 0.15 mm for the 1/2-inch pipe and up to 0.40 mm for the 1-inch pipe. The production of the molds thus requires high precision.

Piston production requires a small plastic injection machine, and different-size molds. The pistons are made of high-density polypropylene or polyethylene. Polyethylene is poured in the injection machine hopper. As the plastic passes through the heated hopper bottom, it becomes fluid and is injected into the mold. As it cools, the plastic adopts the mold's form.

### **Pipes**

The pumping pipes are a fundamental part of the rope pump. The recommended pipe should meet ASTM D-2241 standards. All piping is the pressure type used for potable water. In Nicaragua, measurements are in inches, whereas other countries use millimeter measurements, requiring adaptation. Several countries have changed from PVC to plastic pipes, these equally can be used in rope pump production.

A fundamental difference with the traditional piston pumps is that the weight of the water column is distributed over the pistons and is thus hanging on the rope. The inside pressure on the pipe wall is minimum and as high as the water column between two pistons.

The pumping process is a continuous process and not an intermittent up and down movement, therefore there is no fatiguing breakage. Only the pumping pipes plus the guide box are hanging on the upper pumping pipe.

Pumping pipes vary according to the depth of the well. The deeper the well, the smaller the diameter of the pipe. The maximum weight of the water in the pipes is 10 kilograms and should not be exceeded. Therefore, if pipes with different measurements are used, the maximum depth should be adapted to the maximum weight of 10 kilograms. The diameter of the pipes is determined by the depth from wellhead to water level. Deficiencies have been encountered in the pipes depending on their origin of production.

## Impulse Pump

Impulse pumps use pressure created by gas (usually air). In some impulse pumps the gas trapped in the liquid (usually water), is released and accumulated somewhere in the pump, creating a pressure that can push part of the liquid upwards.

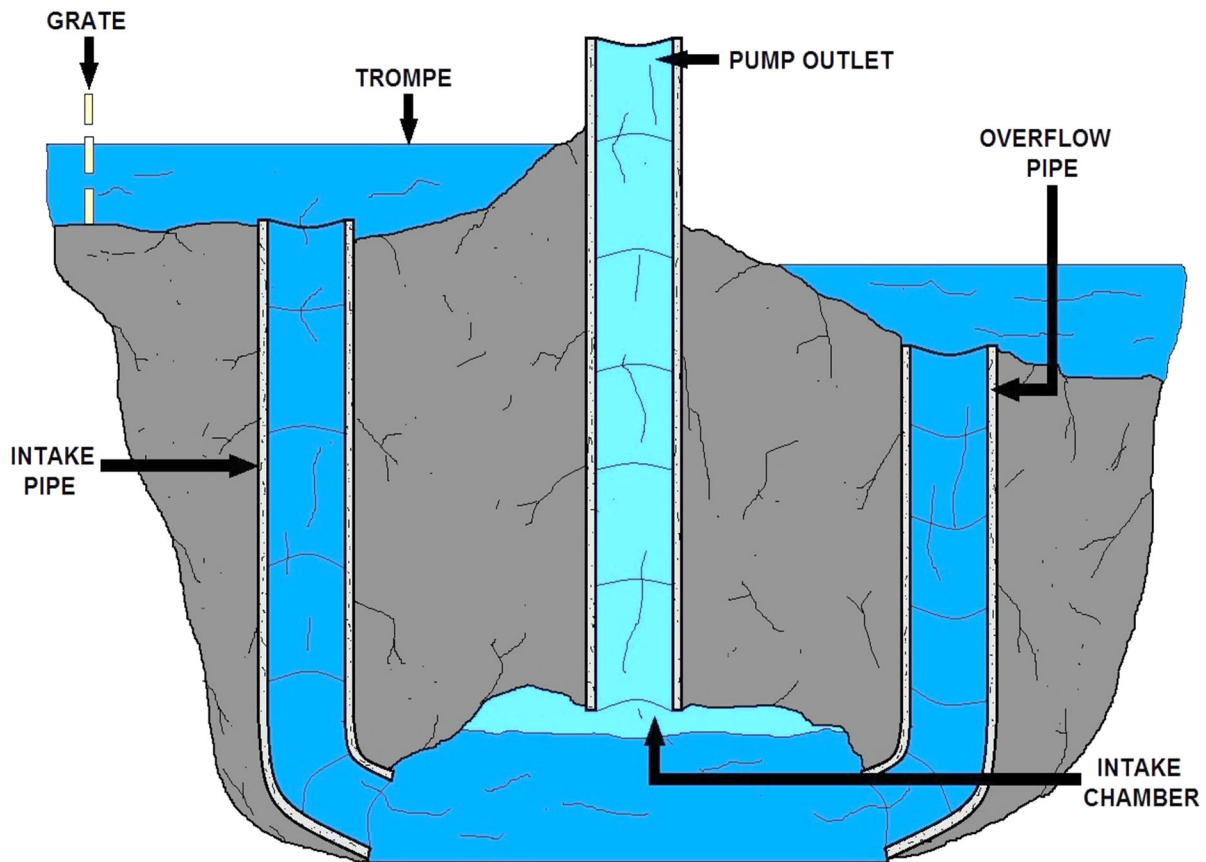

**PULSER PUMP DIAGRAM**

### Impulse pumps include:

- ✓ Hydraulic ram pumps - uses pressure built up internally from released gas in liquid flow.
- ✓ Pulser pumps - run with natural resources, by kinetic energy only.
- ✓ Airlift pumps - run on air inserted into pipe, pushing up the water, when bubbles move upward, or on pressure inside pipe pushing water up.

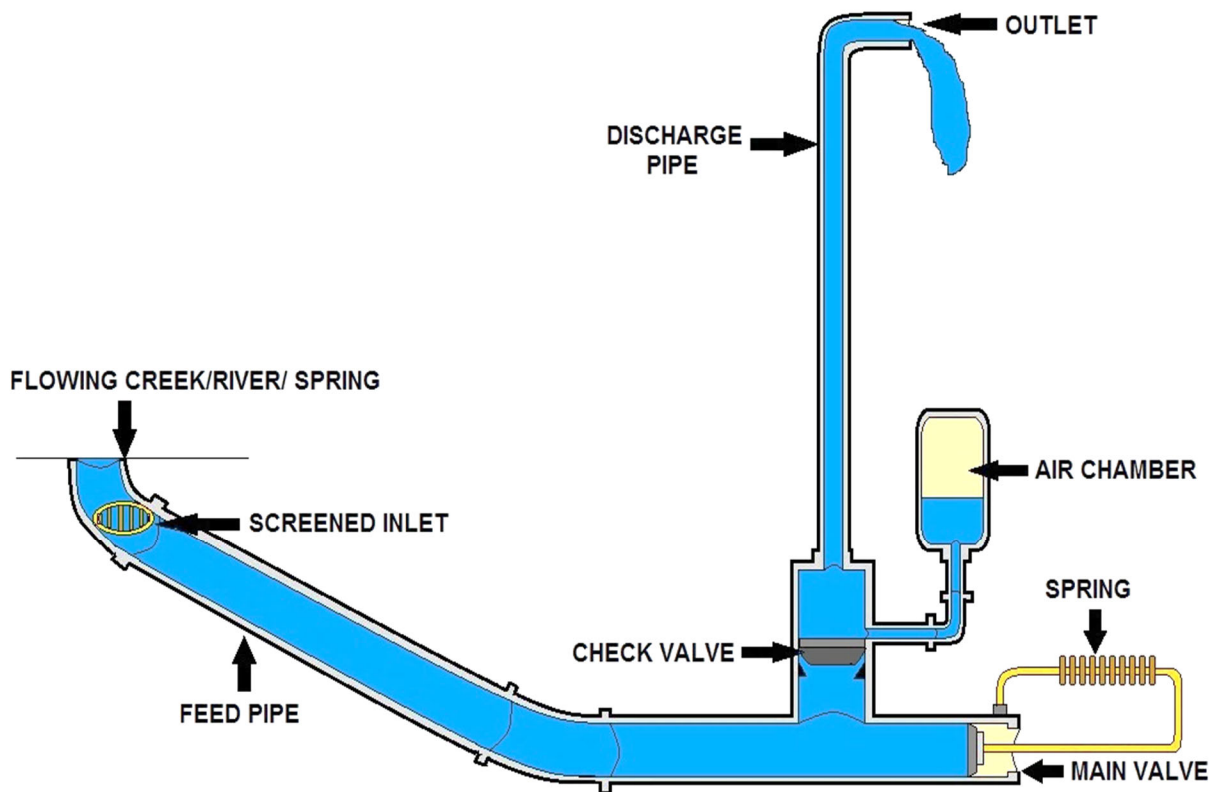

**HYDRAULIC RAM PUMP DIAGRAM**

### Hydraulic Ram Pumps

A hydraulic ram is a water pump powered by hydropower. It functions as a hydraulic transformer that takes in water at one "hydraulic head" (pressure) and flow-rate, and outputs water at a higher hydraulic-head and lower flow-rate. The device uses the water hammer effect to develop pressure that allows a portion of the input water that powers the pump to be lifted to a point higher than where the water originally started.

The hydraulic ram is sometimes used in remote areas, where there is both a source of low-head hydropower, and a need for pumping water to a destination higher in elevation than the source. In this situation, the ram is often useful, since it requires no outside source of power other than the kinetic energy of flowing water.

### Velocity Pumps

Rotodynamic pumps (or dynamic pumps) are a type of velocity pump in which kinetic energy is added to the fluid by increasing the flow velocity. This increase in energy is converted to a gain in potential energy (pressure) when the velocity is reduced prior to or as the flow exits the pump into the discharge pipe. This conversion of kinetic energy to pressure can be explained by the First law of thermodynamics or more specifically by Bernoulli's principle. Dynamic pumps can be further subdivided according to the means in which the velocity gain is achieved.



**These types of pumps have a number of characteristics:**

1. Continuous energy
2. Conversion of added energy to increase in kinetic energy (increase in velocity)
3. Conversion of increased velocity (kinetic energy) to an increase in pressure head

One practical difference between dynamic and positive displacement pumps is their ability to operate under closed valve conditions. Positive displacement pumps physically displace the fluid; hence closing a valve downstream of a positive displacement pump will result in a continual build up in pressure resulting in mechanical failure of either pipeline or pump.

Dynamic pumps differ in that they can be safely operated under closed valve conditions (for short periods of time).

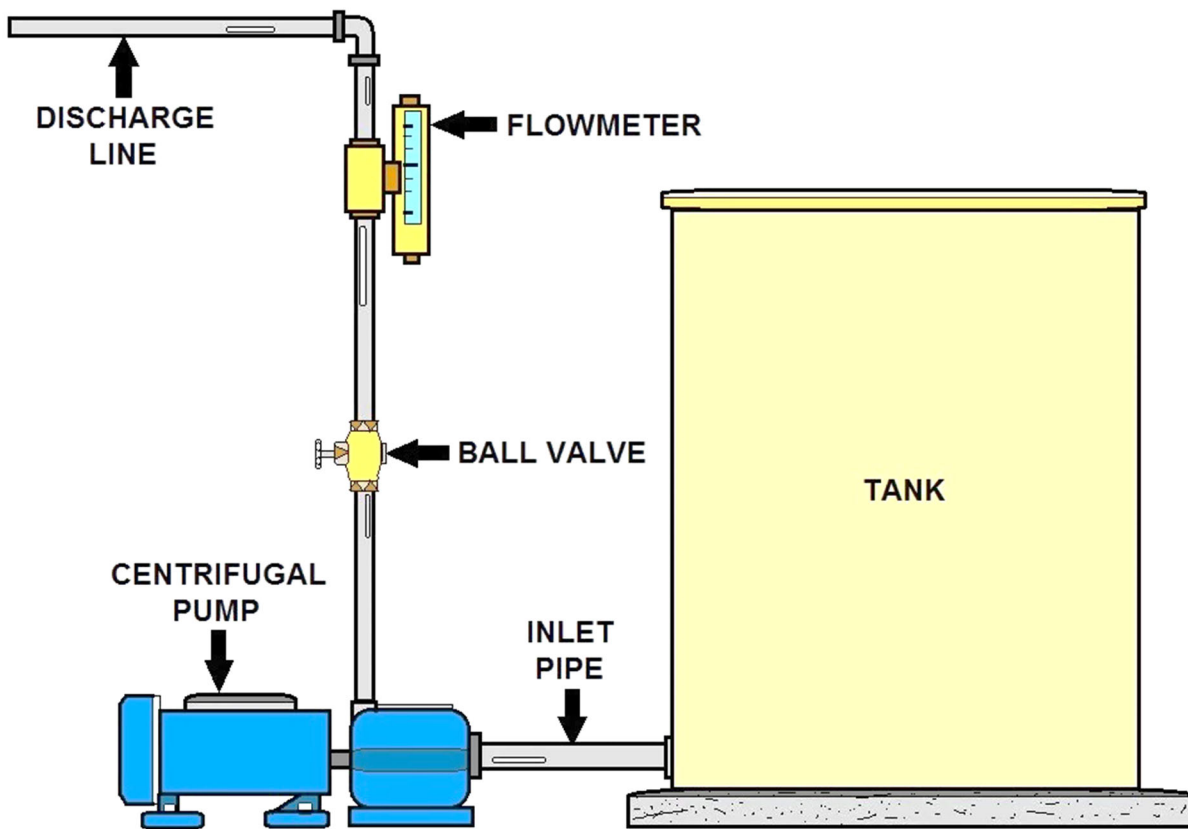

**GRAVITY FEED SYSTEM DIAGRAM**

**Gravity Pumps**

Gravity pumps include the syphon and Heron's fountain – and there also important qanat or foggara systems which simply use downhill flow to take water from far-underground aquifers in high areas to consumers at lower elevations. The hydraulic ram is also sometimes referred to as a gravity pump.



## Gravity Pump Sub-Section

The ability of water to flow from higher to lower elevations makes a gravity system the one to utilize whenever possible. With no moving parts or energy inputs, these systems can provide dependable, low-maintenance service. To allow for flow resistance in the pipe, a minimum delivery pipe diameter 1 1/4 in. should be used where the grade is over 1%. For grades between 0.5% and 1.0%, a 1 1/2 in. minimum size is recommended. Grades less than 0.2% are not recommended for gravity systems. Lay the delivery pipe on a uniform grade to prevent airlocks from forming. Water tank volume should reflect livestock numbers and water demand. If necessary, add gravel to ensure the tank area is stable to withstand herd traffic. A float at the water tank or an overflow outlet would control these conditions. Put a shade canopy over the tank to control seasonal algae growth.

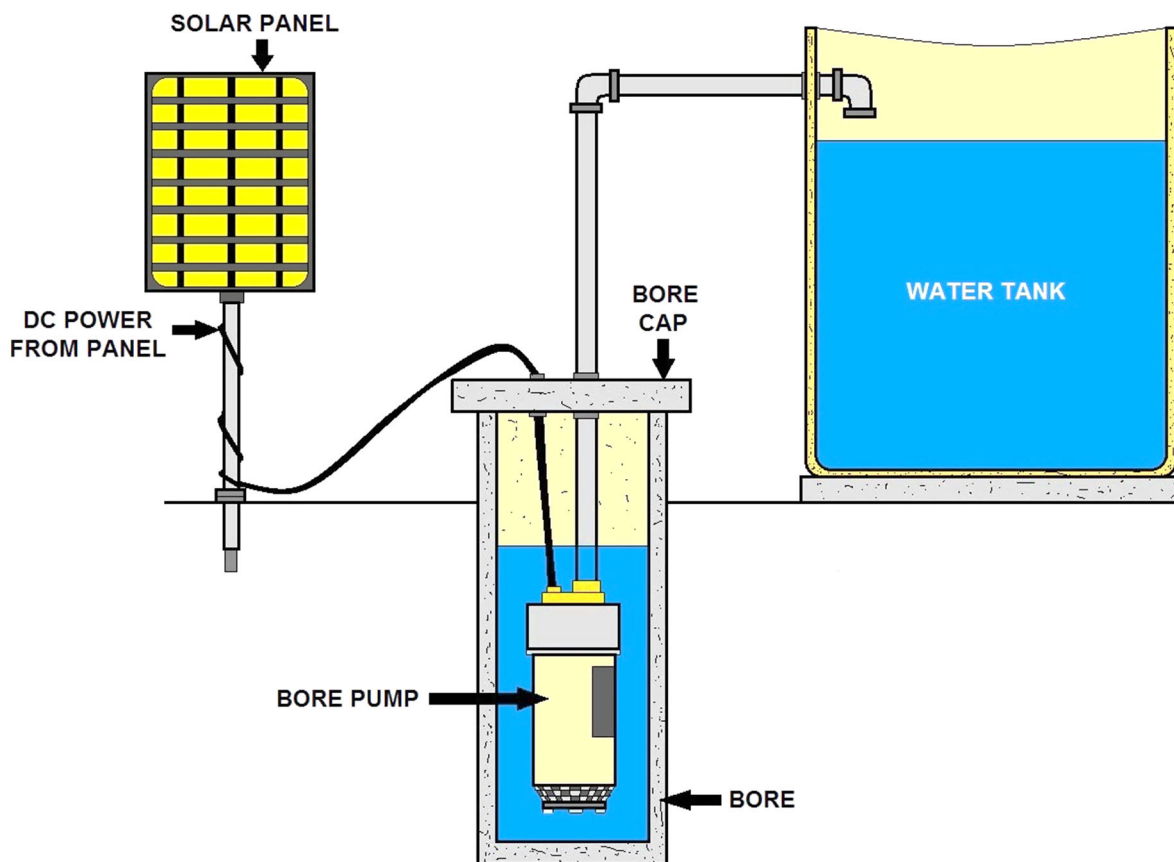

## SOLAR WATER PUMP

### Solar Power

Photovoltaic (PV) or solar panels can be used to power pumping systems for a wide range of output requirements. Solar systems can be very reliable and low in maintenance, but are expensive and require good design for practical service. Two system designs can be used depending upon the application.

Both systems involve storing energy to compensate for variances in solar radiation intensity. Systems that use energy storage in the form of pumped water held in an elevated reservoir have the advantage of design simplicity. Solar panels supply power to the water pump through a maximum power point device to deliver water to the reservoir only during periods of bright sunlight. Water from the reservoir is gravity fed to the stock trough and controlled by a float valve. Battery systems also store energy for use during periods of low sunlight intensity. Through a sequencing device, solar panels charge the batteries that power the water pump. Pump operation is controlled by an electric float switch to allow flow on demand to the stock trough. Proper design of a solar system is critical to meet the specific needs of the user. Consider a suntracker if you are concerned about space for sufficient number of panels. A tracker follows the sun as the day progresses and maximizes panel exposure to the sun.

### **Heissler Pump**

This pump was designed by Paul Heissler of Frankford, Ontario. It is an inexpensive system and can be built from materials around the farm. It has a 12-volt submersible pump sitting in shallow water driven by a tractor battery. A 45-gallon drum acts as a reservoir with a float to control water level. A small trough is attached. Water flows into the trough by gravity as the livestock drink it down. The pump will deliver 22 gallons per minute. The battery is covered to protect it from the weather. This unit sits on top of the reservoir.

The height and distance water is pumped limits the use of the Heissler pump. The more energy required for pumping water the more often the battery needs recharging. The battery charge has lasted 24 days, drawing water up 10 ft and providing water to 44 head of cattle.

### **Hydraulic Rams**

Hydraulic ram pumps have been used since the 1700s. New designs with the same principles are being used today. Falling water is required to operate a hydraulic ram pump. If installed correctly the pump moves water as high as 10 times the fall. The weight of falling water drives a lesser amount to an elevation above the source of supply. The pump operates on the basis of the falling water opening and closing 2 valves with air pressure forcing the water to its destination.

The volume of water a ram pumps depends on the size of the pump, the fall between the source of supply and the ram, the height to which the water is to be raised and the quantity of water available. Output ranges from 700 to 3,000 gallons per day depending on these factors. A small stream is an excellent source to water livestock.

Water needs to flow into the pump at 1 to 5 gallons per minute. A fall of 2 ft. or more is sufficient to drive a ram capable of pumping water to a stock trough at considerable elevation and distance. As the pumping rate is constant but generally slow, a storage reservoir may be necessary to accommodate high demand periods.

Hydraulic ram pumps are a time-tested technology that uses the energy of a large amount of water falling a small height to lift a small amount of that water to a much greater height. In this way, water from a spring or stream in a valley can be pumped to a village or irrigation scheme on the hillside.

Depending on the difference in heights between the inlet pipe and the outlet pipe, these water pumps will lift 1-20 percent of the water that flows into it. In general, a ram can pump approximately one tenth of the received water volume to a height ten times greater than the intake.

A hydraulic ram pump is useful where the water source flows constantly and the usable fall from the water source to the pump location is at least 91 cm (3 ft).

Since ram pumps can only be used in situations where falling water is available, their use is restricted to three main applications:

- ✓ lifting drinking water from springs to settlements on higher ground.
- ✓ pumping drinking water from streams that have significant slope.
- ✓ lifting irrigation water from streams or raised irrigation channels.

**Ram Pump Advantages include:**

1. Inexpensive
2. Very simple construction and easy to install yourself.
3. Does not consume petrol, diesel or electricity.
4. Minimum maintenance.
5. Pollution free.
6. Quiet pumping 24 hours per day.



## Wind Mills

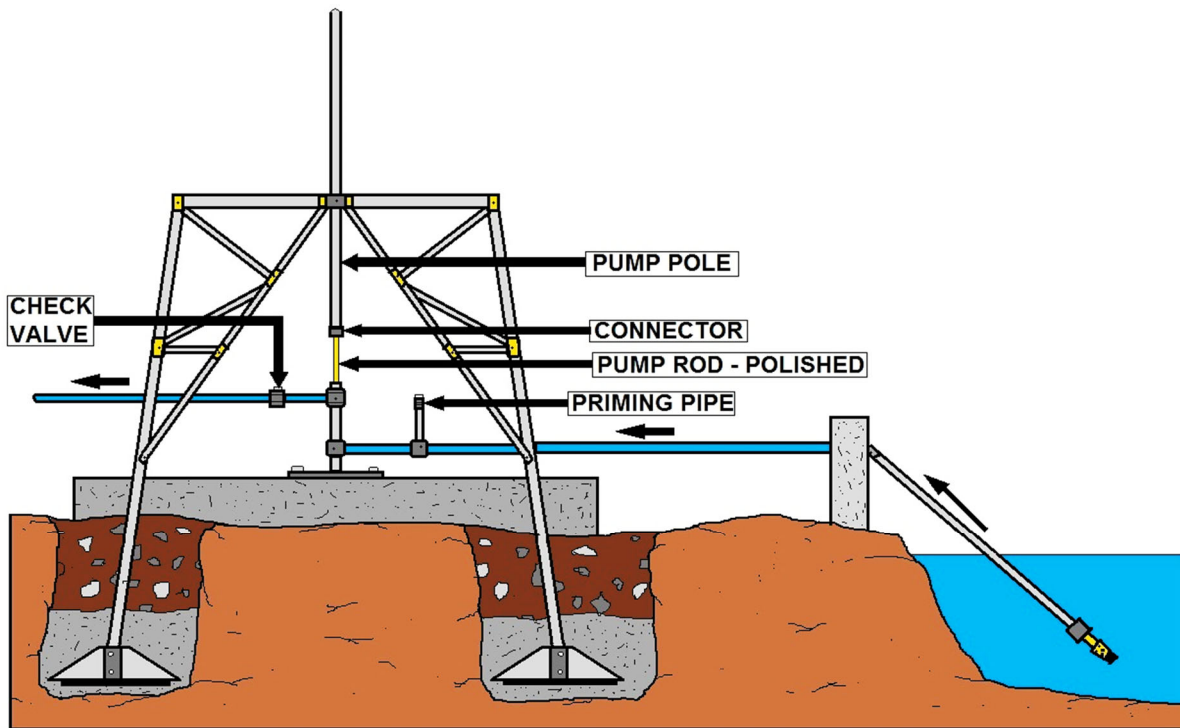

**WINDMILL DRIVEN WATER PUMP**

### Wind Mills

In the past, windmills have been a proven part of the farm enterprise and could find greater use for livestock water purposes today. Though now a fairly expensive technology, currently manufactured windmills are reliable and need little maintenance, equal to their antique counterparts.

Old windmills can be successfully rebuilt and may offer a practical alternative to the expense of new equipment. Modern windmills will operate in a stream, pond or shallow well. The pump sits on the surface or in the water. An airline connects the pump to the windmill. Air pressure generated by the windmill activates the pump. Water is pumped when there is wind. The windmill can be located up to 300 ft. from the water source and at the best location to catch the wind. It can lift water up to 20 ft. and pump 5 gallons per minute. As wind is a variable energy source, use a storage reservoir to provide a supply for periods of low wind velocity. Locate the storage reservoir within 1,000 ft. of the water source.

### Pasture (Nose) Pumps

Using a simple pumping mechanism to draw water to a bowl, the nose pump is a good alternative to in stream watering. Installation is quick and easy - easy enough to use as portable system for rotation pastures. Animals push a plunger with their nose to move water with a diaphragm pump into a bowl. The pump is a rubber diaphragm and 2 check valves.

One push of the plunger brings water in on the forward stroke and again as it is released. The intake line incorporates a foot valve and strainer for reliable operation.

The water source may be a nearby stream, pond or well of suitable quality. A disadvantage of the nose pump is that stock must water individually, limiting practical use to about 25 animals per unit. Maximum lift from the water source is 25 ft. Where there is very little lift required nose pumps can draw water from 200 to 3,000 ft, depending on the pump size. Nose pumps are relatively low in cost and installation expense is minimal. Animals must be trained to use them. Young calves may have difficulty at the beginning.

- Nose pumps are generally not the least cost or the most desirable watering facility option unless the site is too distant from farmstead facilities, water lines, springs, etc. to make conventional pipeline and water tubs impracticable or cost prohibitive.
- The livestock watering system shall have capacity to meet the water requirements of the livestock.
- Due to the water requirements of dairy milkers, nose pumps may not be a viable option unless the number of animals being served is very low.
- The site should be well drained, or if not, drainage measures will be provided. Areas adjacent to the nose pump that will be trampled by livestock shall be graveled, or otherwise treated to provide firm footing and to reduce erosion.
- Design and install watering facilities to prevent overturning by wind and animals.
- Nose pump sites must be chosen that have a low risk on contaminating surface or ground water.
- Water intake pipes shall be protected to prevent damage by livestock.
- Nose pump(s) will be protected from freezing by draining and storing under cover.

**The following O&M activities will be planned and applied as needed:**

- Repair damaged components as necessary.
- Install and maintain fences as needed to prevent livestock damage to the system and appurtenances.
- Maintain the area adjacent to the nose pump(s) in a stable, well-drained condition to prevent rutting, ponding and erosion from livestock use. Maintain surface treatment for livestock footing.
- During winter months, the nose pump and hose must be removed and placed under cover, drained of water, and stored out of reach of children.

**Priming a Pump**

Liquid and slurry pumps can lose prime and this will require the pump to be primed by adding liquid to the pump and inlet pipes to get the pump started. Loss of "prime" is usually due to ingestion of air into the pump. The clearances and displacement ratios in pumps used for liquids and other more viscous fluids cannot displace the air due to its lower density.



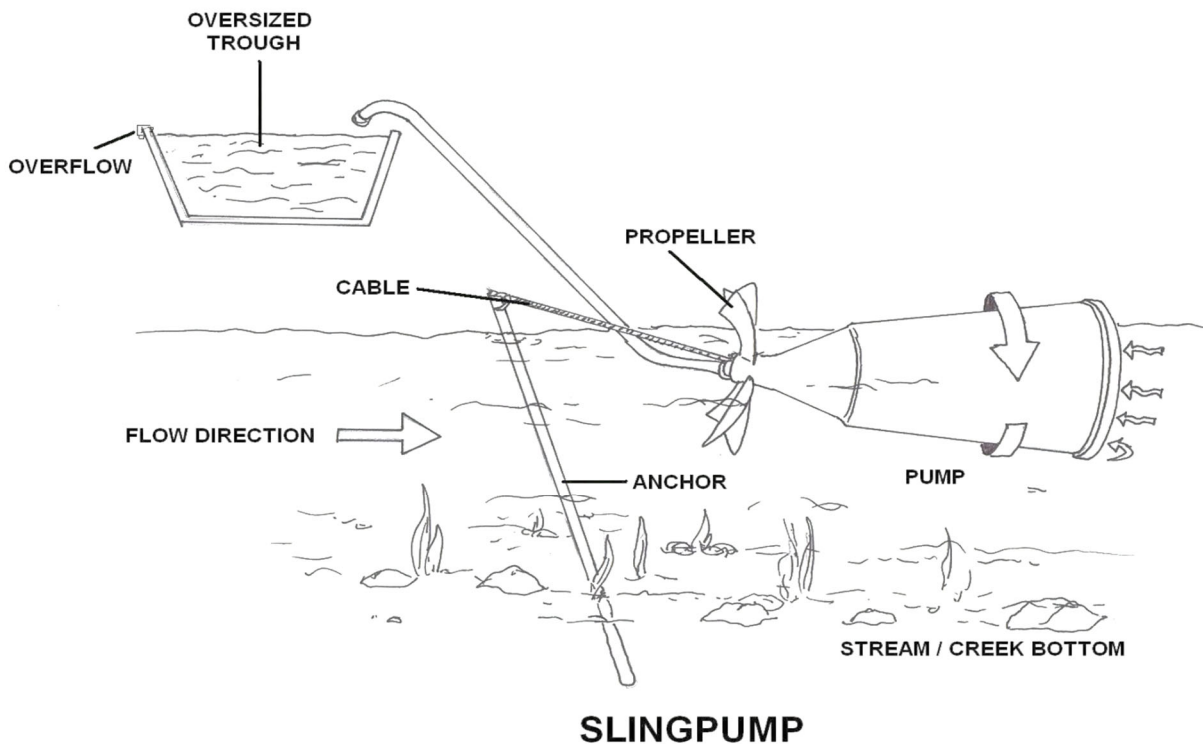

## Sling Pump

A sling pump is powered by flowing water or wind. It floats on top of the water and is anchored in the water. A water powered pump is driven by water flowing past the pump. This rotates the propellers and will pump 24 hr/day. A water flow velocity of 2 ft/sec is necessary. A wind powered sling pump is often used where there is little water flow such as in a pond. It sits on 2 pontoons for floatation, but is anchored. Power is moved from the propellers to a belt that rotates the pump. A holding is used to store water for use in low wind periods. The minimum depth of water required is 16 in. It will pump from 800 to 3,300 Imperial gallons per day. Floating debris such as leaves and branches can hinder the operation of a sling pump. Silt or sand can also plug water hoses.

The Sling Pump, with only one moving part, is a modern application of an Archimedes Snail Pump. A helical intake coil is wrapped around and around the inside surface of a cone. The coil is connected to an output tube via a water-lubricated swivel coupling at the extreme upstream side of the pump and is open at the downstream (fat) end. The downstream end of the cone has slats to let water in but keep debris out. A rope or pair of ropes holds it in place.

The pump floats partially submerged, being largely of plastic, with aluminum propeller blades and buoyant Styrofoam in the nose. With each revolution of the cone, the coil picks up air during the top portion of the cycle and water during the bottom portion. This causes a pulsed output, and also means the output water is highly oxygenated. The Rife Hydraulic Engine Mfg. Co., Inc. claims some models of their Sling Pumps (inset) can raise water over 80 feet high or move it a mile horizontally, from a stream moving at just 1.5 feet per second. (Head doesn't change with speed, only volume.) The unit weighs about 44 lbs. and uses a 1/2" hose.

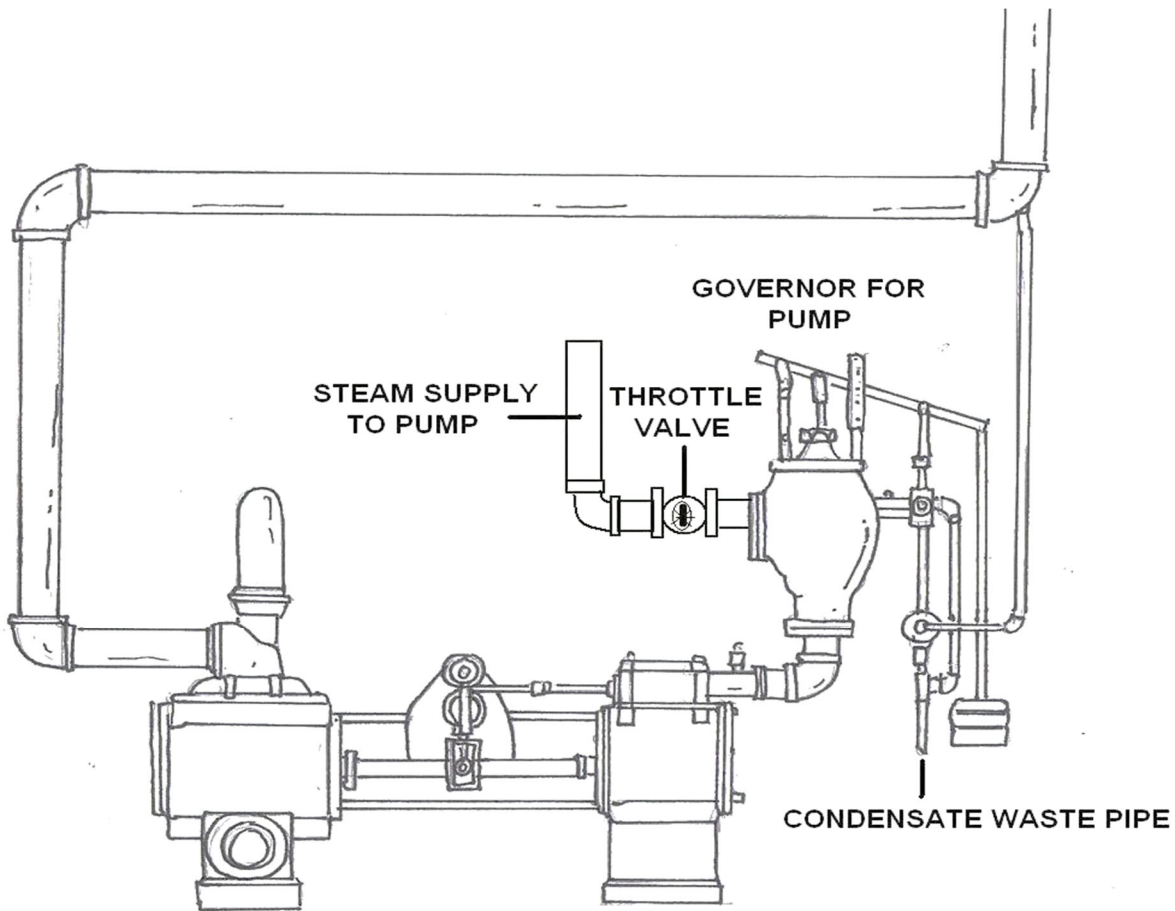

**STEAM PUMP DIAGRAM**

## Steam Pumps

Steam pumps have been for a long time mainly of historical interest. They include any type of pump powered by a steam engine and also pistonless pumps such as Thomas Savery's, the Pulsometer steam pump or the Steam injection pump.

This extremely simple pump was made of cast iron, and had no pistons, rods, cylinders, cranks, or flywheels. It operated by the direct action of steam on water. The mechanism consisted of two chambers. As the steam condensed in one chamber, it acted as a suction pump, while in the other chamber, steam was introduced under pressure and so it acted as a force pump.

At the end of every stroke, a ball valve consisting of a small rubber ball moved slightly, causing the two chambers to swap functions from suction-pump to force-pump and vice versa. The result was that the water was first suction pumped and then force pumped. The pump ran automatically without attendance.

It was praised for its "extreme simplicity of construction, operation, compact form, high efficiency, economy, durability, and adaptability". Later designs were improved upon to enhance efficiency and to make the machine more accessible for inspection and repairs, thus reducing maintenance costs.

Recently there has been a resurgence of interest in low power solar steam pumps for use in smallholder irrigation in developing countries. Previously small steam engines have not been viable because of escalating inefficiencies as vapor engines decrease in size. However, the use of modern engineering materials coupled with alternative engine configurations has meant that these types of system are now a cost effective opportunity.

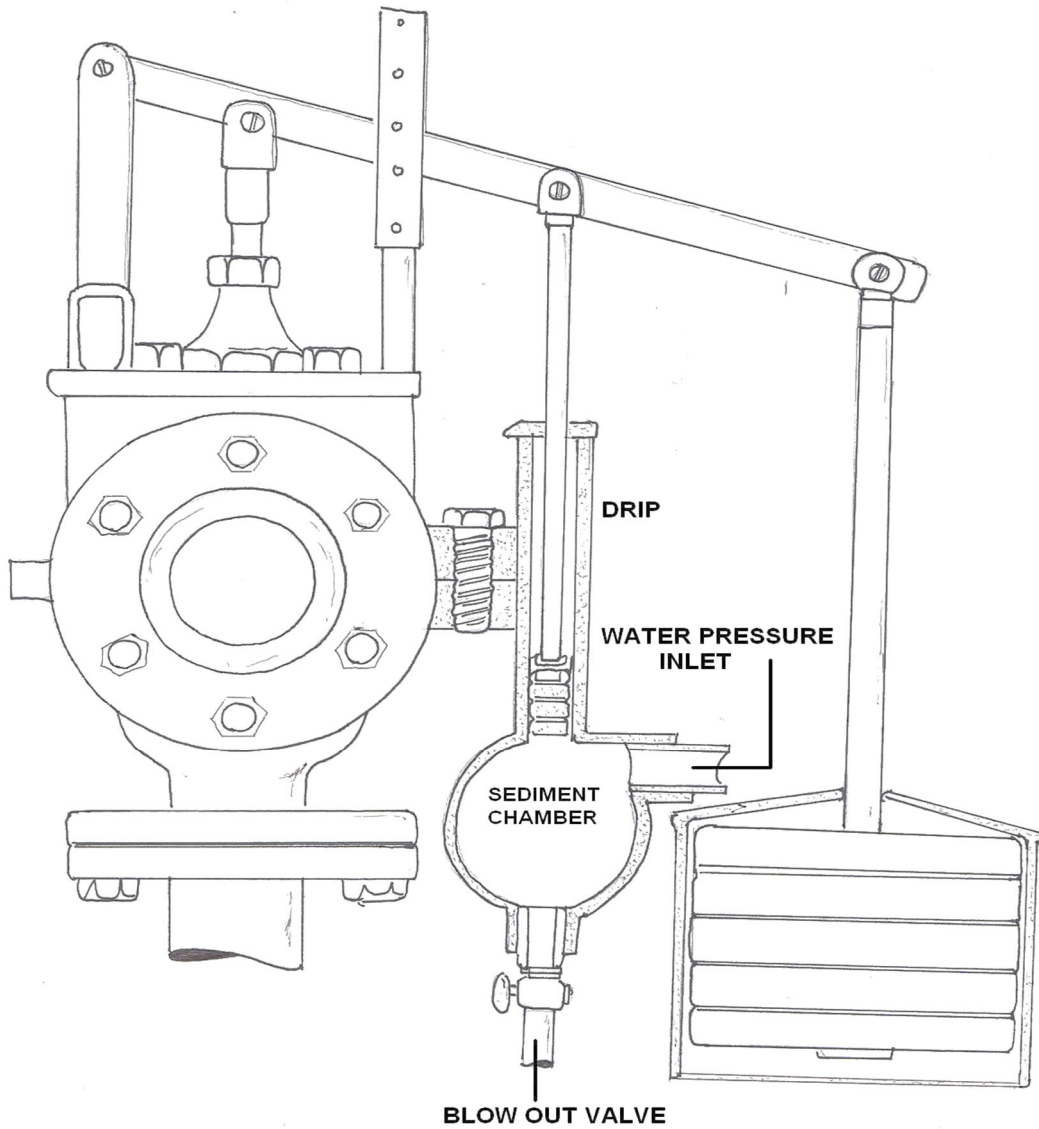

**STEAM PUMP REGULATOR**



## Pump Definitions

### Hyperlink to the Glossary and Appendix

<http://www.abctlc.com/downloads/PDF/PumpGlossary.pdf>

**Fluid:** Any substance that can be pumped such as oil, water, refrigerant, or even air.

**Gasket:** Flat material that is compressed between two flanges or faces to form a seal.

**Gland follower:** A bushing used to compress the packing in the stuffing box and to control leakoff.

**Gland sealing line:** A line that directs sealing fluid to the stuffing box.

**Horizontal pumps:** Pumps in which the center line of the shaft is horizontal.

**Impeller:** The part of the pump that increases the speed of the fluid being handled.

**Inboard:** The end of the pump closest to the motor.

**Inter-stage diaphragm:** A barrier that separates stages of a multi-stage pump.

**Key:** A rectangular piece of metal that prevents the impeller from rotating on the shaft.

**Keyway:** The area on the shaft that accepts the key.

**Kinetic energy:** Energy associated with motion.

**Lantern ring:** A metal ring located between rings of packing that distributes gland sealing fluid.

**Leak-off:** Fluid that leaks from the stuffing box.

**Mechanical seal:** A mechanical device that seals the pump stuffing box.

**Mixed flow pump:** A pump that uses both axial-flow and radial-flow components in one impeller.

**Multi-stage pumps:** Pumps with more than one impeller.

**Outboard:** The end of the pump farthest from the motor.

**Packing:** Soft, pliable material that seals the stuffing box.

**Positive displacement pumps:** Pumps that move fluids by physically displacing the fluid inside the pump.

**Radial bearings:** Bearings that prevent shaft movement in any direction outward from the center line of the pump.

**Radial flow:** Flow at 90° to the center line of the shaft.

**Retaining nut:** A nut that keeps the parts in place.

**Rotor:** The rotating parts, usually including the impeller, shaft, bearing housings, and all other parts included between the bearing housing and the impeller.

**Score:** To cause lines, grooves, or scratches.

**Shaft:** A cylindrical bar that transmits power from the driver to the pump impeller.

**Shaft sleeve:** A replaceable tubular covering on the shaft.

**Shroud:** The metal covering over the vanes of an impeller.

**Slop drain:** The drain from the area that collects leak-off from the stuffing box.

**Slurry:** A thick, viscous fluid, usually containing small particles.

**Stages:** Impellers in a multi-stage pump.

**Stethoscope:** A metal device that can amplify and pinpoint pump sounds.

**Strainer:** A device that retains solid pieces while letting liquids through.

**Stuffing box:** The area of the pump where the shaft penetrates the casing.

**Suction:** The place where fluid enters the pump.

**Suction eye:** The place where fluid enters the pump impeller.

**Throat bushing:** A bushing at the bottom of the stuffing box that prevents packing from being pushed out of the stuffing box into the suction eye of the impeller.

**Thrust:** Force, usually along the center line of the pump.

**Thrust bearings:** Bearings that prevent shaft movement back and forth in the same direction as the center line of the shaft.

**Troubleshooting:** Locating a problem.

**Vanes:** The parts of the impeller that push and increase the speed of the fluid in the pump.

**Vertical pumps:** Pumps in which the center line of the shaft runs vertically.

**Volute:** The part of the pump that changes the speed of the fluid into pressure.

**Wearing rings:** Replaceable rings on the impeller or the casing that wear as the pump operates.

## **Pumps and Pumping Water Section Post Quiz**

### **Pump Definitions**

1. What definition represents is a mechanical device that seals the pump stuffing box?
2. What definition represents is the energy associated with motion?
3. What definition represents is the fluid that leaks from the stuffing box?

### **Hydraulic Terms**

4. Which of the following definitions is the engineering science pertaining to liquid pressure and flow?
5. Which of the following definitions is the engineering science pertaining to the energy of liquid flow and pressure?
6. Which of the following definitions is the pressure applied to a confined fluid at rest is transmitted with equal intensity throughout the fluid?
7. What definition represents is often used to indicate gauge pressure?

### **Pump Introduction**

8. The key to understanding a pumps operation is that a pump is to move water and generate the \_\_\_\_\_ we call pressure.
9. Pump operation like with a centrifugal pump — pressure is not referred to in pounds per square inch but rather as the equivalent in elevation, called?
10. According to the text, pumps may be classified on the basis of the application they serve.  
A. True                      B. False

11. According to the text, all pumps may be divided into two major categories: (1) dynamic and (2)?

### Understanding the Basic Water Pump

12. According to the text, the centrifugal pumps work by spinning water around in a circle inside a?

13. The pump makes the water spin by pulling it with an impeller.

A. True                      B. False

14. The blades of this impeller project inward from an axle like the arms of a turnstile and, as the impeller spins, the water moves through it.

A. True                      B. False

15. In a centrifugal pump, the water pressure at the edge of the turning impeller rises until it is able to keep water circling with the?

16. In a centrifugal pump, as water drifts outward between the \_\_\_\_\_ of the pump, it must move faster and faster because its circular path is getting larger and larger.

17. As the water slows down and its kinetic energy decreases, that water's pressure potential energy increases.

A. True                      B. False

18. As the water spins, the pressure near the outer edge of the pump housing becomes much lower than near the center of the impeller.

A. True                      B. False

19. The impeller blades cause the water to move faster and faster.

A. True                      B. False

**References** are found in the next section.

**Answers:** 1. Mechanical seal, 2. Kinetic energy, 3. Leak-off, 4. Hydraulics, 5. Hydrokinetics, 6. Pascal's Law, 7. Head, 8. Delivery force, 9. Head, 10. True, 11. Displacement, 12. Cylindrical pump housing, 13. False, 14. False, 15. Impeller blade(s), 16. Impeller blade(s), 17. True, 18. False, 19. True



## Section 7 - Complicated Pump Section

**Section Focus:** You will learn the more about pumps, specifically, the complicated pumps. At the end of this section, you will be able to describe types of complicated based on application and capabilities with a focus upon the two major groups of pumps are dynamic and positive displacement. There is a post quiz at the end of this section to review your comprehension and a final examination in the Assignment for your contact hours.

**Scope/Background:** Pump engineers, well drillers and many water operators work daily on various complicated water, or sludge pumps. This section is a continuation of the prior section.

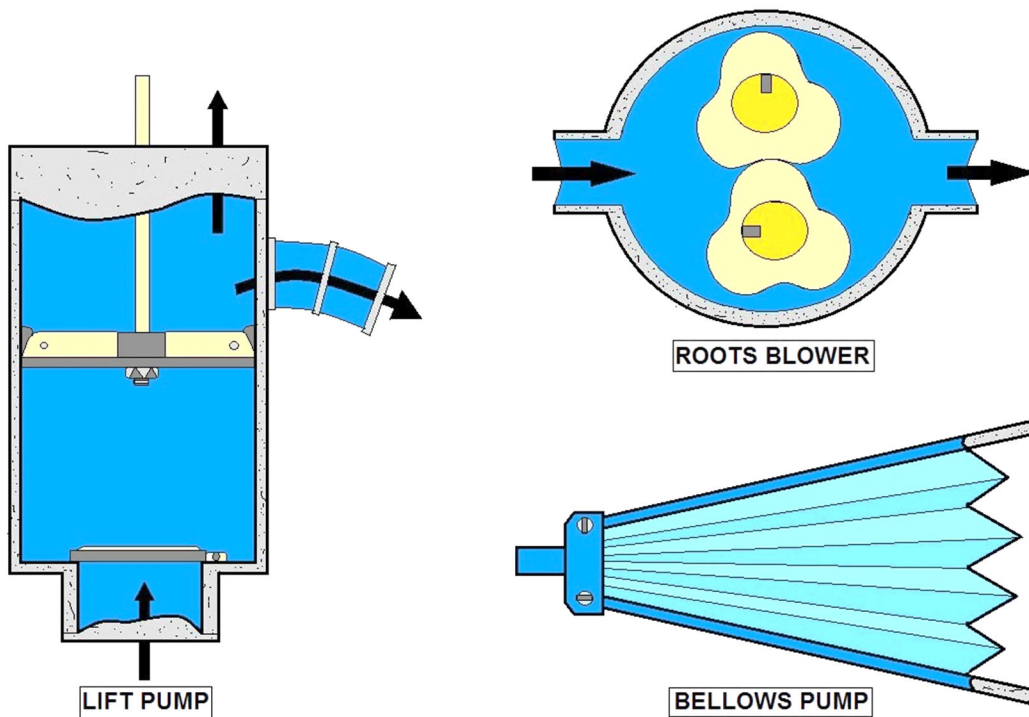

### TYPES OF POSITIVE DISPLACEMENT PUMPS

The pump is a machine or mechanical equipment which is required to lift liquid from low level to high level or to flow liquid from low pressure area to high pressure area or as a booster in a piping network system.

***Principally, pump converts mechanical energy of motor into fluid flow energy.***

Pumps are used in process operations that requires a high hydraulic pressure. This can be seen in heavy duty equipment's. Often heavy duty equipment's requires a high discharge pressure and a low suction pressure. Due to low pressure at suction side of pump, fluid will lift from certain depth, whereas due to high pressure at discharge side of pump, it will push fluid to lift until reach desired height.

## Classification of Pumps

Pump types generally fall into two main categories –

1. Dynamic (Centrifugal) Pumps
2. Positive Displacement Pumps

The family of pumps comprises a large number of types based on application and capabilities. The two major groups of pumps are dynamic and positive displacement.

## Differences between the Dynamic and Positive Displacement Pumps

Factor	Dynamic (Centrifugal) Pump	Positive Displacement Pump
Mechanics	Impellers pass on velocity from the motor to the liquid which helps move the fluid to the discharge port (produces flow by creating pressure).	Traps confined amounts of liquid and forces it from the suction to the discharge port (produces pressure by creating flow).
Performance	Flow rate varies with a change in pressure.	Flow rate remains constant with a change in pressure.
Viscosity	Flow rate rapidly decreases with increasing viscosity, even any moderate thickness, due to frictional losses inside the pump.	Due to the internal clearances high viscosities are handled easily and flow rate increases with increasing viscosity.
Efficiency	Efficiency peaks at a specific pressure; any variations decrease efficiency dramatically. Does not operate well when run off the middle of the curve; can cause damage and cavitation.	Efficiency is less affected by pressure, but if anything tends to increase as pressure increases. Can be run at any point on their curve without damage or efficiency loss.
Suction Lift	Standard models cannot create suction lift, although self-priming designs are available and manometric suction lift is possible through a non-return valve on the suction line.	Create a vacuum on the inlet side, making them capable of creating suction lift.
Shearing	High speed motor leads to shearing of liquids. Not good for shear sensitive mediums.	Low internal velocity means little shear is applied to the pumped medium. Ideal for shear sensitive fluids.

### Hyperlink to the Glossary and Appendix

<http://www.abctlc.com/downloads/PDF/PumpGlossary.pdf>

## Types of Pumps

The family of pumps comprises a large number of types based on application and capabilities. The two major groups of pumps are dynamic and positive displacement.

### Dynamic Pumps (Centrifugal Pump)

**Centrifugal pumps are classified into three general categories:**

**Radial flow**—a centrifugal pump in which the pressure is developed wholly by centrifugal force.

**Mixed flow**—a centrifugal pump in which the pressure is developed partly by centrifugal force and partly by the lift of the vanes of the impeller on the liquid.

**Axial flow**—a centrifugal pump in which the pressure is developed by the propelling or lifting action of the vanes of the impeller on the liquid.

### Plunger Pump

The plunger pump is a positive displacement pump that uses a plunger or piston to force liquid from the suction side to the discharge side of the pump. It is used for heavy sludge. The movement of the plunger or piston inside the pump creates pressure inside the pump, so you have to be careful that this kind of pump is never operated against any closed discharge valve.

All discharge valves must be open before the pump is started, to prevent any fast build-up of pressure that could damage the pump.

### Diaphragm Pumps

In this type of pump, a diaphragm provides the mechanical action used to force liquid from the suction to the discharge side of the pump. The advantage the diaphragm has over the plunger is that the diaphragm pump does not come in contact with moving metal. This can be important when pumping abrasive or corrosive materials.

**There are three main types of diaphragm pumps available:**

1. Diaphragm sludge pump
2. Chemical metering or proportional pump
3. Air-powered double-diaphragm pump

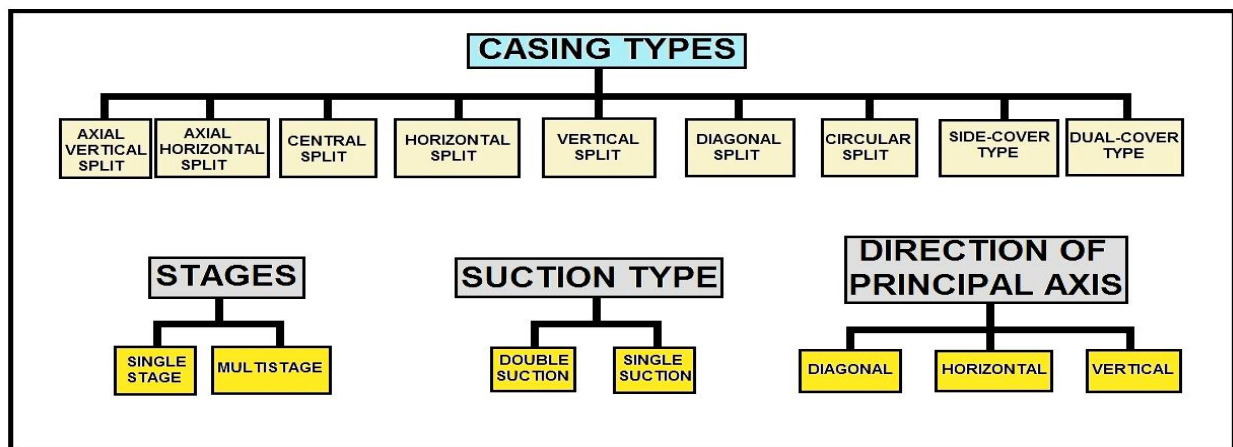

## PUMP CONFIGURATIONS

## Pump Categories

Let's cover the essentials first. The key to the whole operation is, of course, the *pump*. And regardless of what type it is (reciprocating piston, centrifugal, turbine or jet-ejector, for either shallow or deep well applications), its purpose is to move water and generate the delivery force we call pressure.

From time to time— with centrifugal pumps in particular — pressure is not referred to in pounds per square inch but rather as the equivalent in elevation, called “head”.

Head in feet divided by 2.31 equals pressure, so it's simple enough to establish a common figure.

Pumps may be classified on the basis of the application they serve.

**All pumps may be divided into two major categories:**

(1) dynamic, in which energy is continuously added to increase the fluid velocities within the machine, and

(2) displacement, in which the energy is periodically added by application of force.

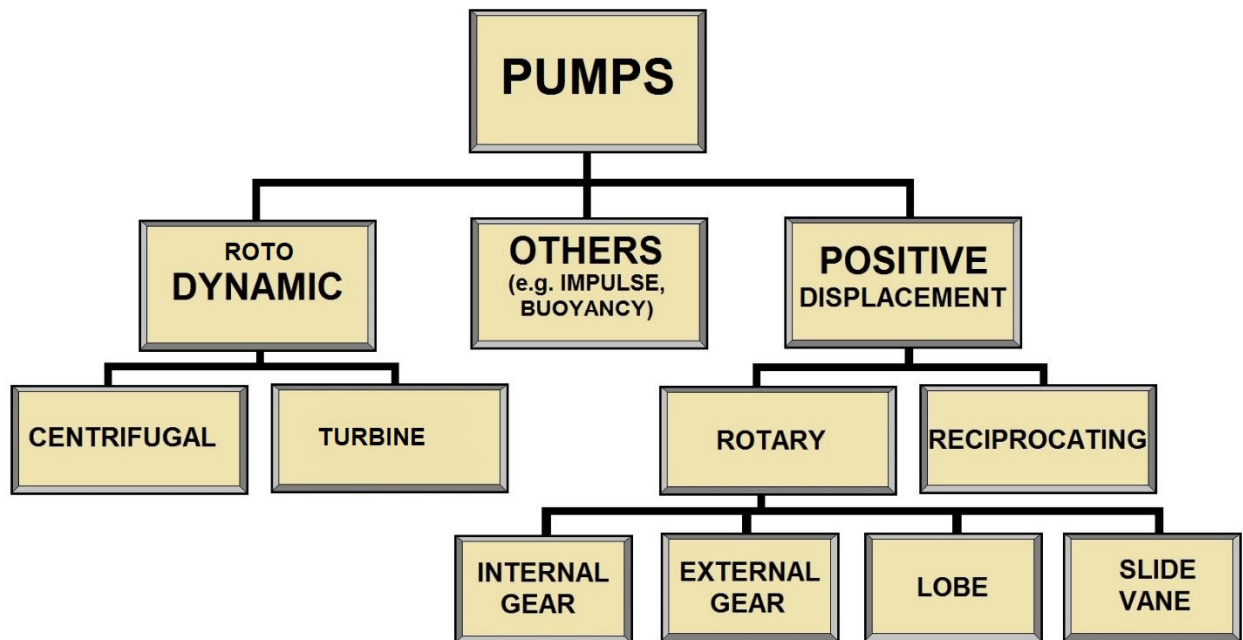

**PUMP CATEGORIES**

## Complicated Pumps - Introduction

More complicated pumps have valves allowing them to work repetitively. These are usually check valves that open to allow passage in one direction, and close automatically to prevent reverse flow. There are many kinds of valves, and they are usually the most trouble-prone and complicated part of a pump. The force pump has two check valves in the cylinder, one for supply and the other for delivery. The supply valve opens when the cylinder volume increases, the delivery valve when the cylinder volume decreases.

The lift pump has a supply valve and a valve in the piston that allows the liquid to pass around it when the volume of the cylinder is reduced. The delivery in this case is from the upper part of the cylinder, which the piston does not enter.

Diaphragm pumps are force pumps in which the oscillating diaphragm takes the place of the piston. The diaphragm may be moved mechanically, or by the pressure of the fluid on one side of the diaphragm.

Some positive displacement pumps are shown below. The force and lift pumps are typically used for water. The force pump has two valves in the cylinder, while the lift pump has one valve in the cylinder and one in the piston. The maximum lift, or "suction," is determined by the atmospheric pressure, and either cylinder must be within this height of the free surface.

The force pump, however, can give an arbitrarily large pressure to the discharged fluid, as in the case of a diesel engine injector. A nozzle can be used to convert the pressure to velocity, to produce a jet, as for firefighting. Fire fighting force pumps usually have two cylinders feeding one receiver alternately. The air space in the receiver helps to make the water pressure uniform.

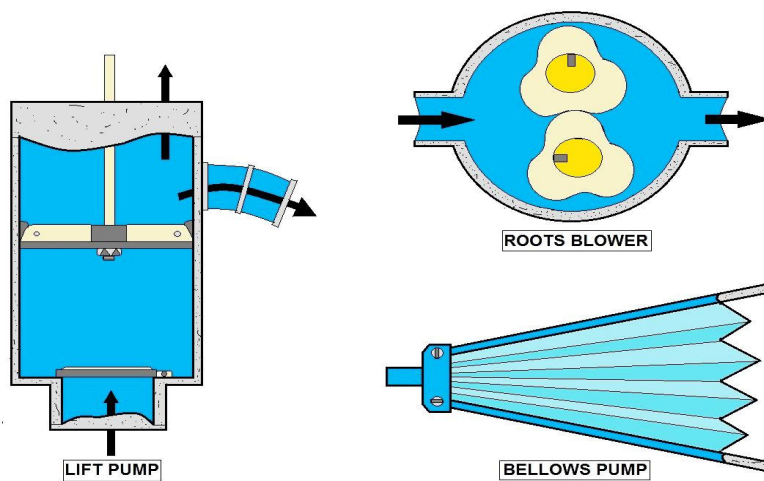

### POSITIVE DISPLACEMENT PUMP TYPES

The three pumps above are typically used for air, but would be equally applicable to liquids. The Roots blower has no valves, their place taken by the sliding contact between the rotors and the housing.

The Roots blower (Rotary Lobe) can either exhaust a receiver or provide air under moderate pressure, in large volumes.

The Bellows is a very old device, requiring no accurate machining. The single valve is in one or both sides of the expandable chamber. Another valve can be placed at the nozzle if required. The valve can be a piece of soft leather held close to holes in the chamber.

The Bicycle pump uses the valve on the valve stem of the tire or inner tube to hold pressure in the tire. The piston, which is attached to the discharge tube, has a flexible seal that seals when the cylinder is moved to compress the air, but allows air to pass when the movement is reversed.

Diaphragm and vane pumps are not shown, but they act the same way by varying the volume of a chamber, and directing the flow with check valves.

### **Fluid Properties**

The properties of the fluids being pumped can significantly affect the choice of pump.

#### **Key considerations include:**

- **Acidity/alkalinity (pH) and chemical composition.** Corrosive and acidic fluids can degrade pumps, and should be considered when selecting pump materials.
- **Operating temperature.** Pump materials and expansion, mechanical seal components, and packing materials need to be considered with pumped fluids that are hotter than 200°F.
- **Solids concentrations/particle sizes.** When pumping abrasive liquids such as industrial slurries, selecting a pump that will not clog or fail prematurely depends on particle size, hardness, and the volumetric percentage of solids.
- **Specific gravity.** The fluid specific gravity is the ratio of the fluid density to that of water under specified conditions. Specific gravity affects the energy required to lift and move the fluid, and must be considered when determining pump power requirements.
- **Vapor pressure.** A fluid's vapor pressure is the force per unit area that a fluid exerts in an effort to change phase from a liquid to a vapor, and depends on the fluid's chemical and physical properties. Proper consideration of the fluid's vapor pressure will help to minimize the risk of cavitation.
- **Viscosity.** The viscosity of a fluid is a measure of its resistance to motion. Since kinematic viscosity normally varies directly with temperature, the pumping system designer must know the viscosity of the fluid at the lowest anticipated pumping temperature. High viscosity fluids result in reduced centrifugal pump performance and increased power requirements. It is particularly important to consider pump suction-side line losses when pumping viscous fluids.

### **Environmental Considerations**

Important environmental considerations include ambient temperature and humidity, elevation above sea level, and whether the pump is to be installed indoors or outdoors.

### **Software Tools**

Most pump manufacturers have developed software or Web-based tools to assist in the pump selection process. Pump purchasers enter their fluid properties and system requirements to obtain a listing of suitable pumps. Software tools that allow you to evaluate and compare operating costs are available from private vendors.

## Complicated Pump Diagrams

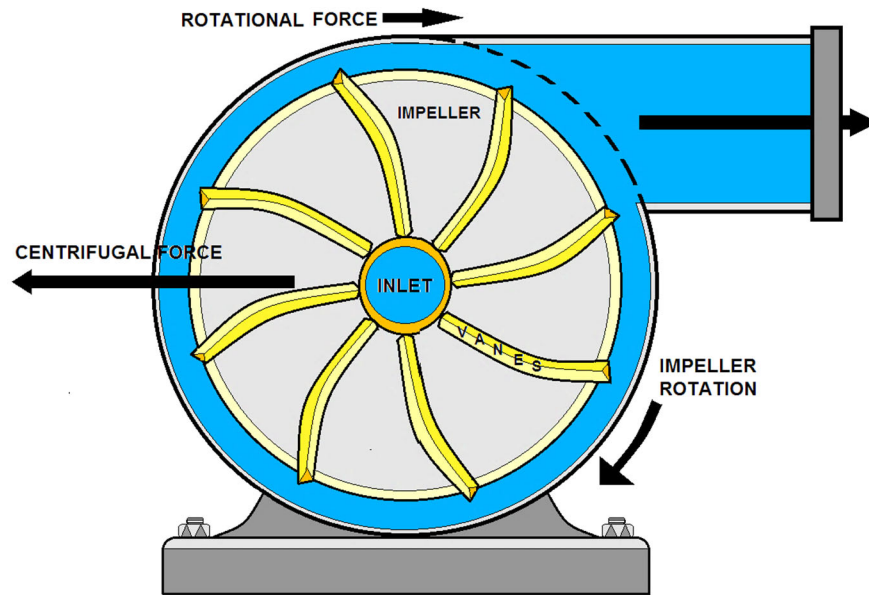

**BASIC PUMP IMPELLER DIAGRAM**

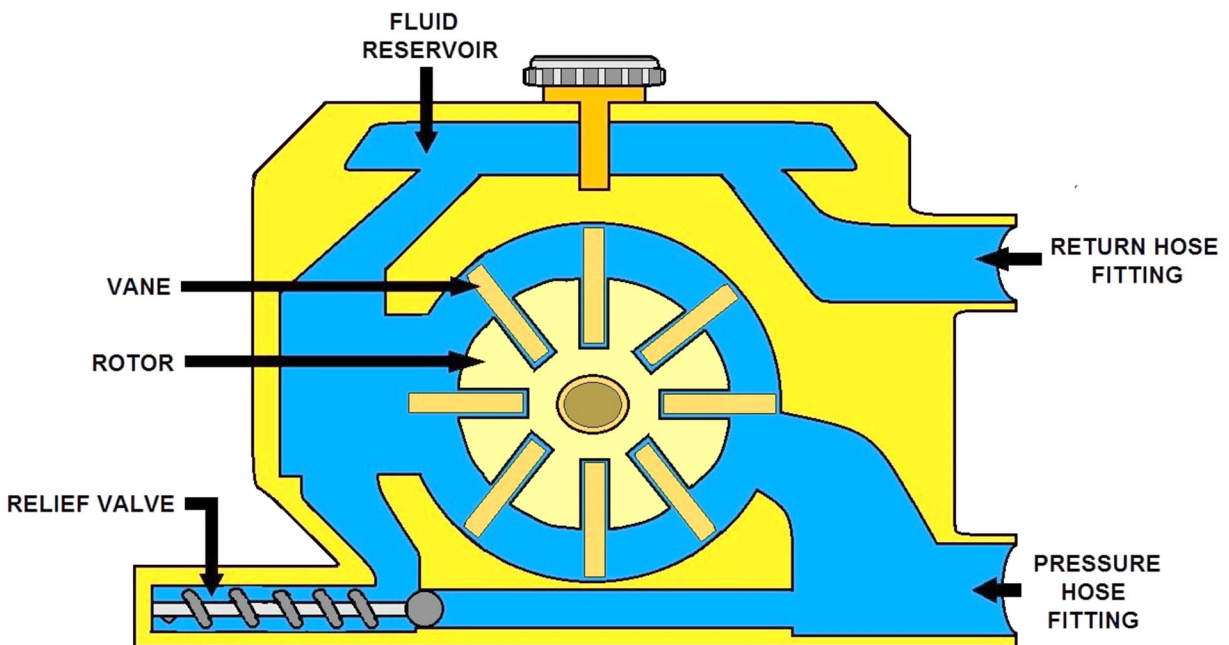

**FLEX VANE PUMP DIAGRAM**

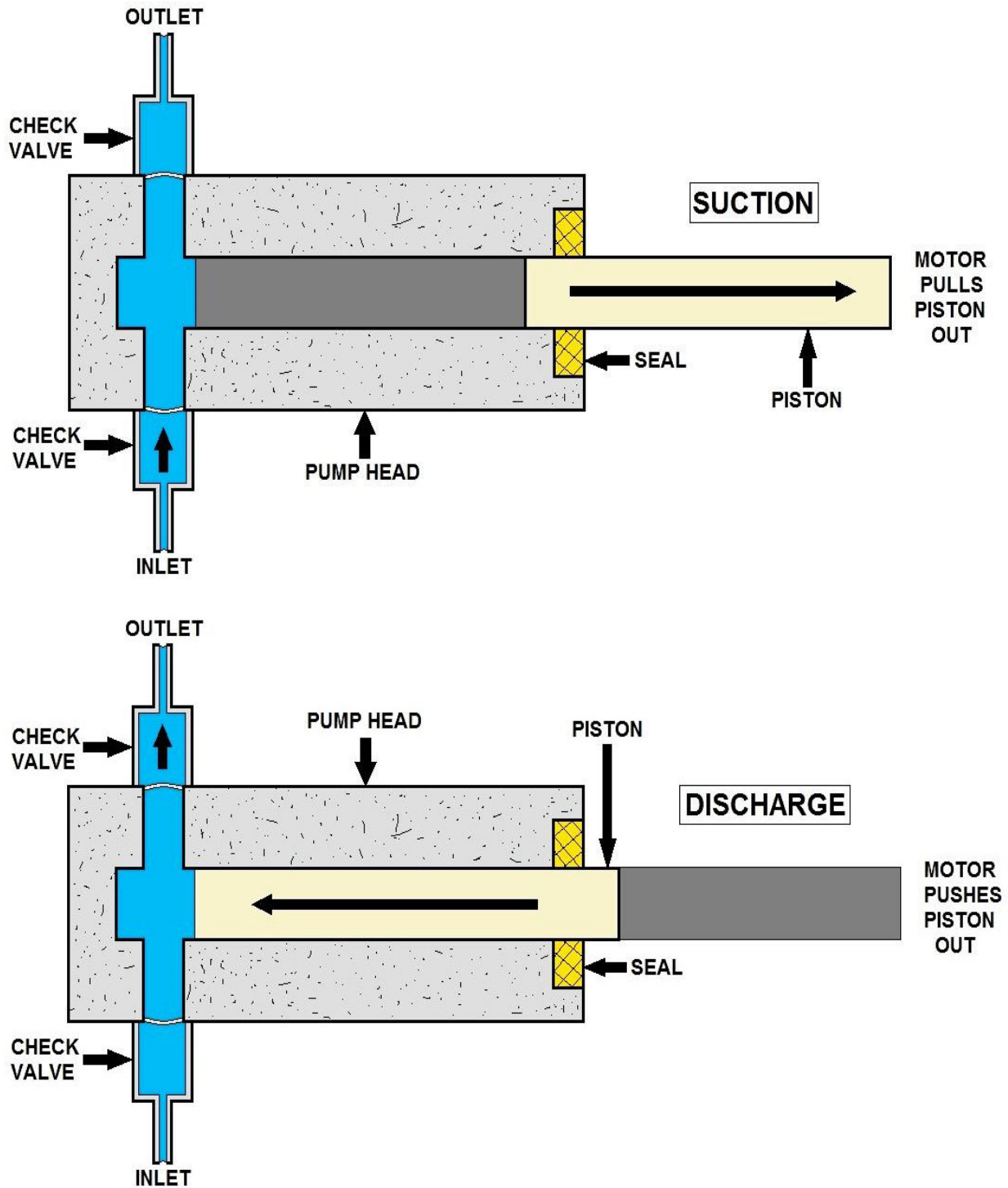

**POSITIVE DISPLACEMENT PUMP DIAGRAM  
RECIPROCATING TYPE**



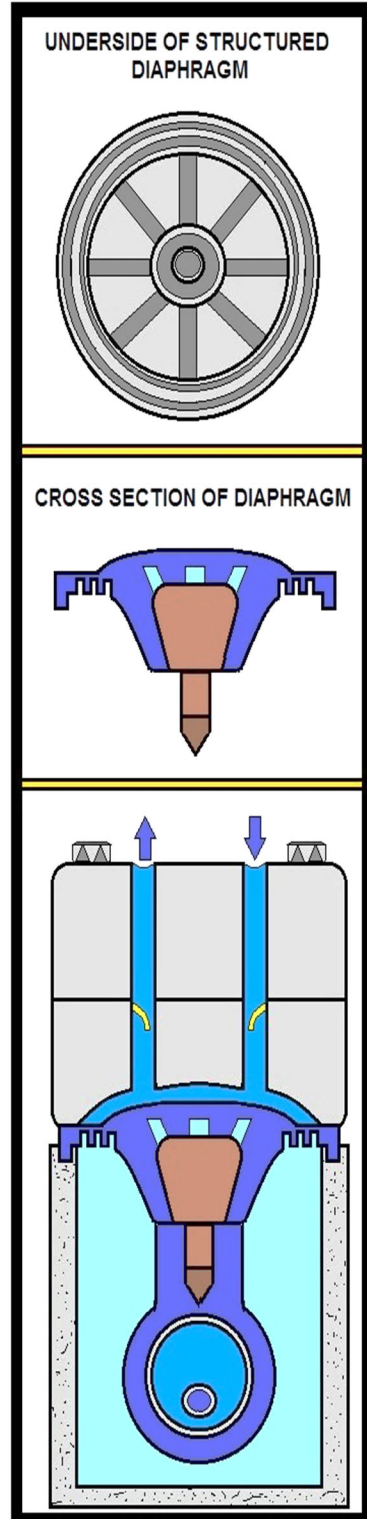
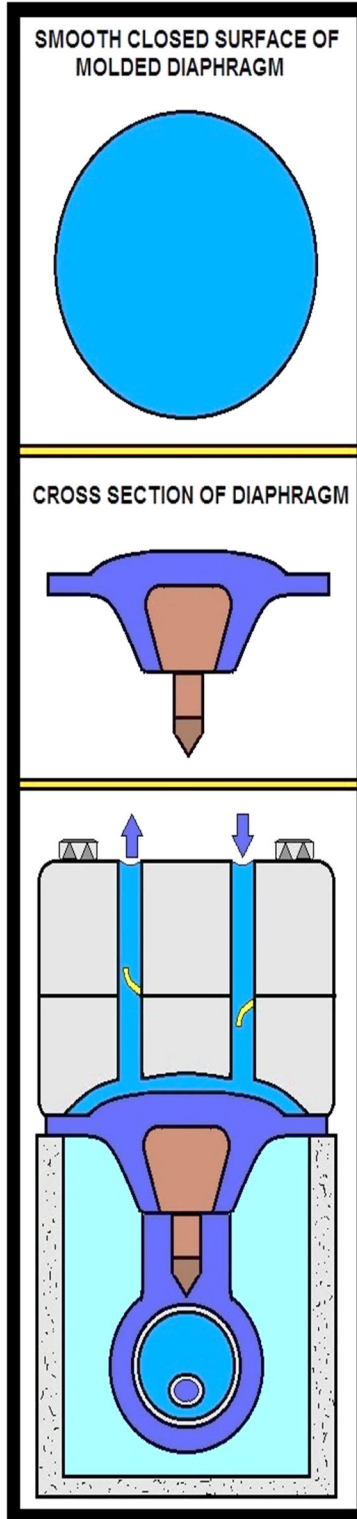
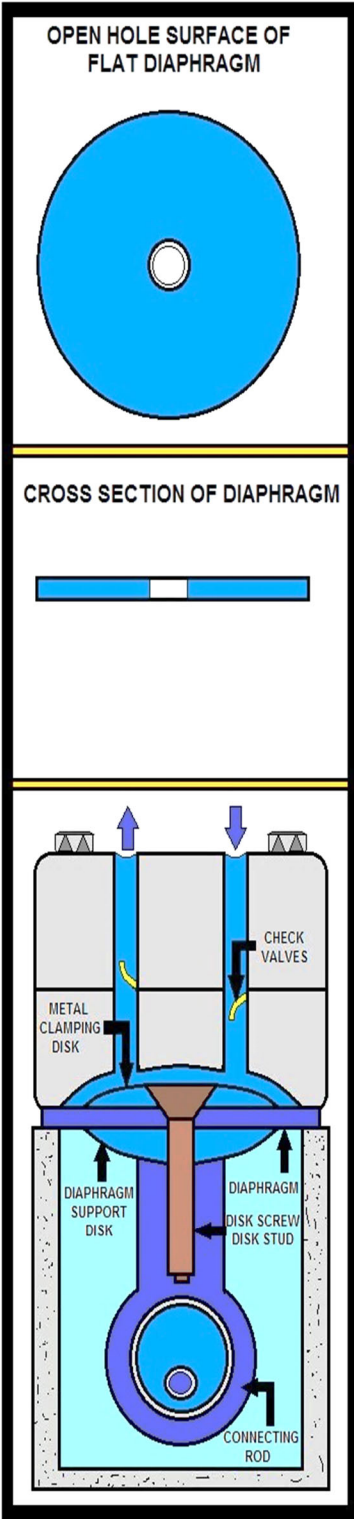

**TYPES OF DIAPHRAGM PUMPS**

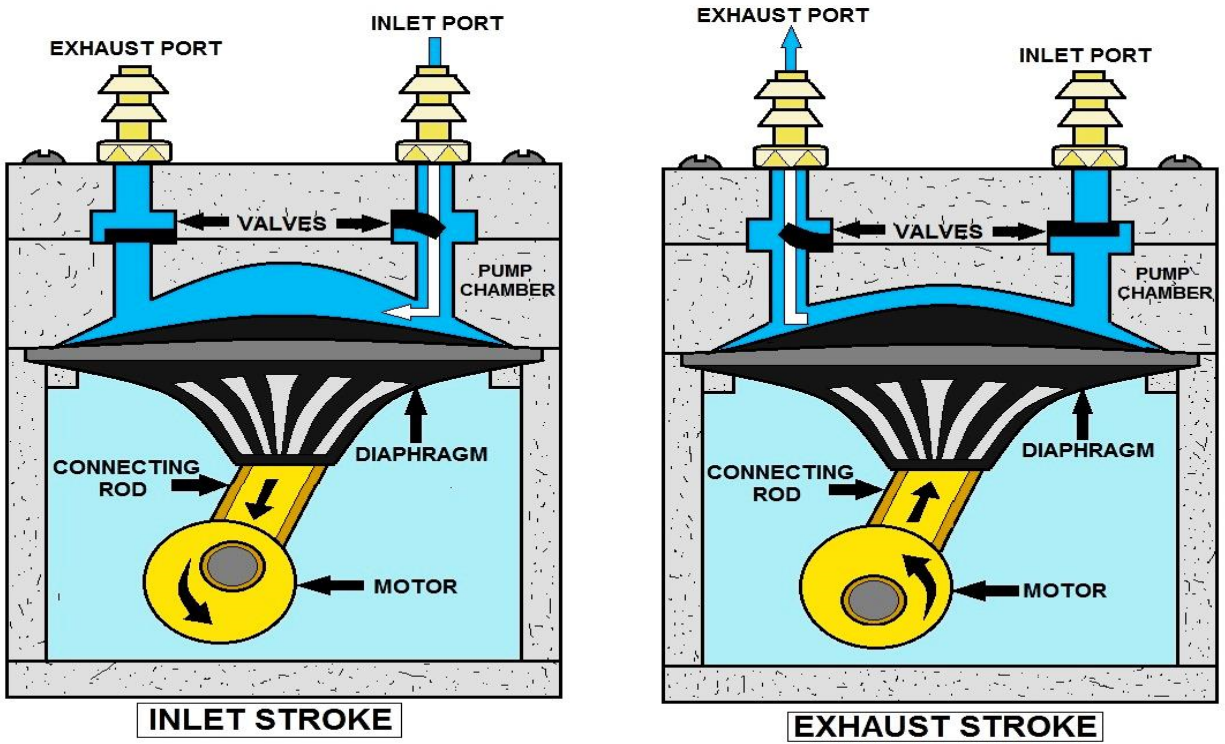

**HOW A FLUID HANDLING DIAPHRAGM PUMP WORKS**

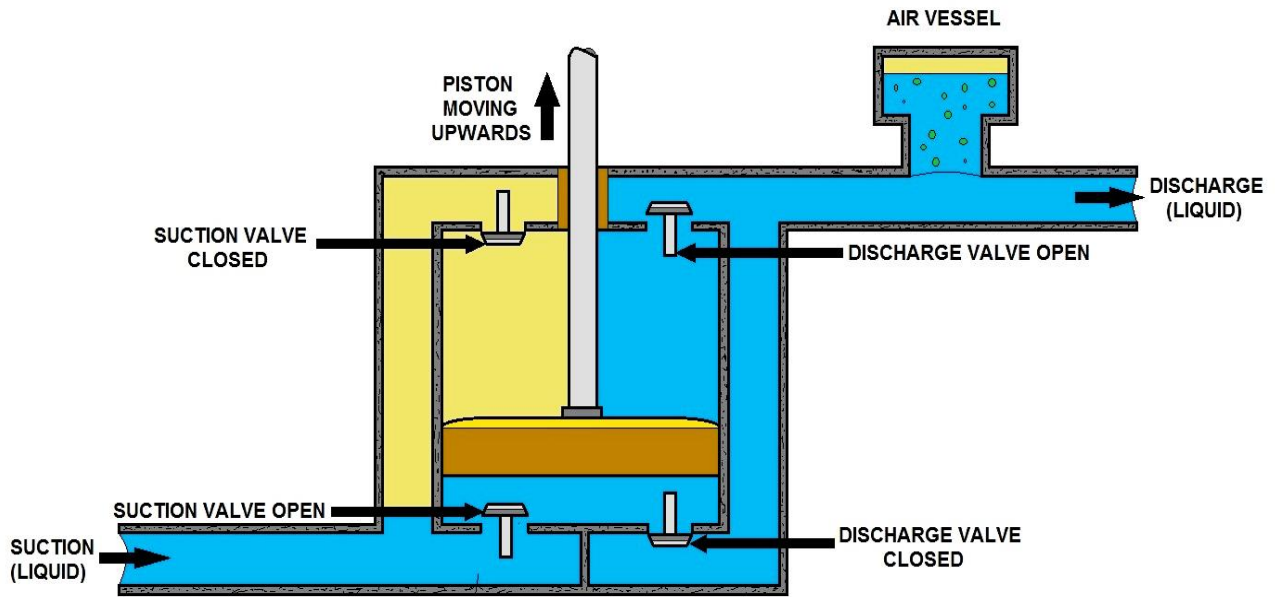

**POSITIVE DISPLACEMENT PUMP  
RECIPROCATING PISTON TYPE**

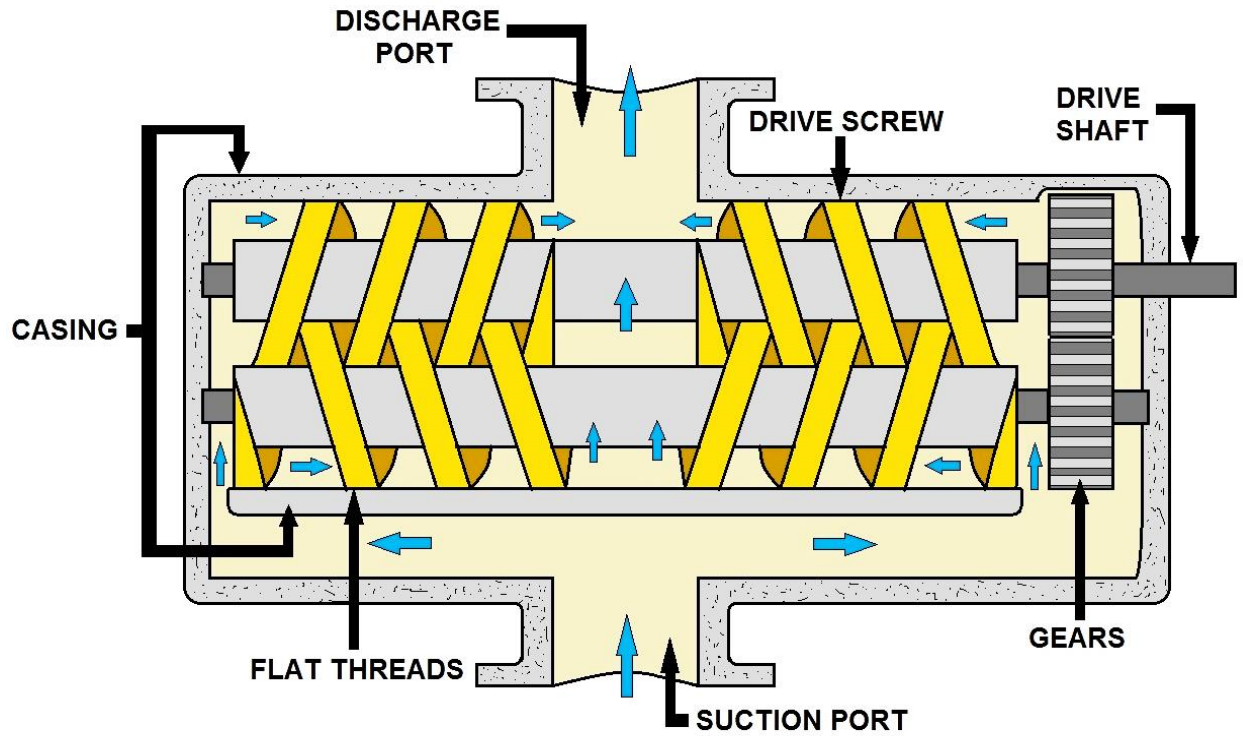

**POSITIVE DISPLACEMENT PUMP  
SCREW TYPE**

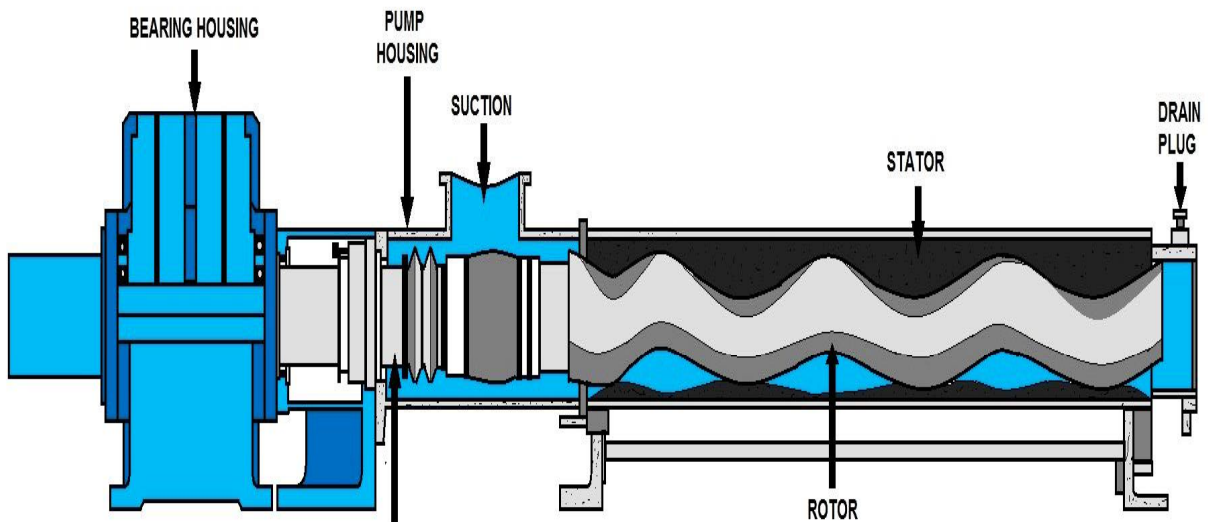

**POSITIVE DISPLACEMENT PUMP  
PROGRESSIVE CAVITY TYPE**

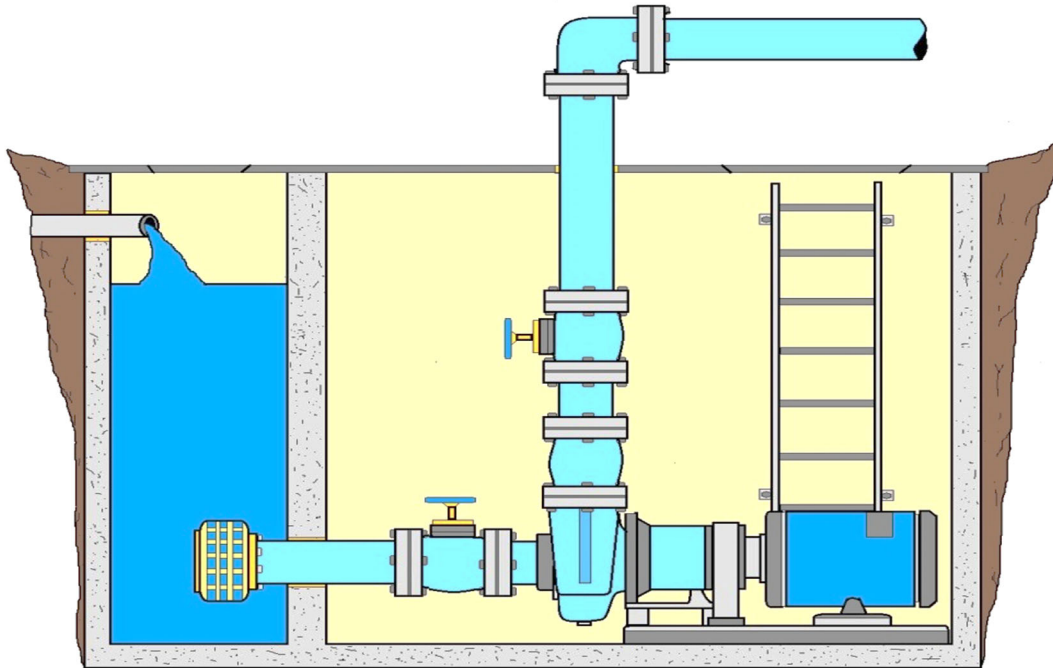

**CLOSED COUPLED CENTRIFUGAL PUMP**

**Viscous Drag Pump**

A pump whose impeller has no vanes but relies on fluid contact with a flat rotating plate turning at high speed to move the liquid.

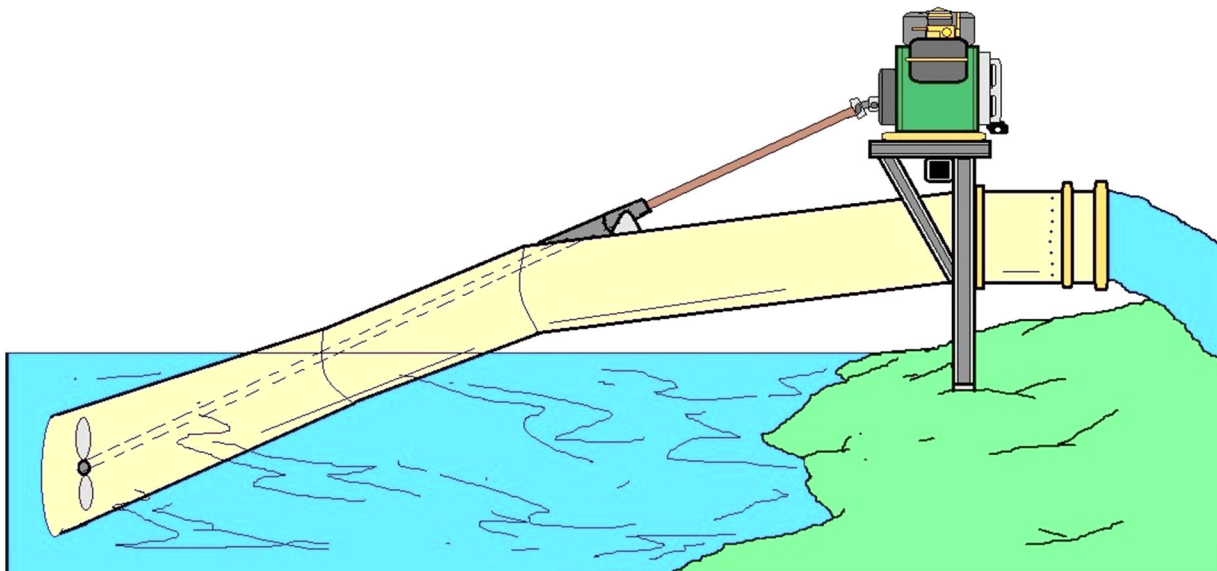

**SIMPLE PROPELLER PUMP**

## The Basic Water Pump – Pump Operation

The water pump commonly found in our systems is centrifugal pumps. These pumps work by spinning water around in a circle inside a cylindrical pump housing. The pump makes the water spin by pushing it with an impeller. The blades of this impeller project outward from an axle like the arms of a turnstile and, as the impeller spins, the water spins with it. As the water spins, the pressure near the outer edge of the pump housing becomes much higher than near the center of the impeller.

*There are many ways to understand this rise in pressure, and here are two:*

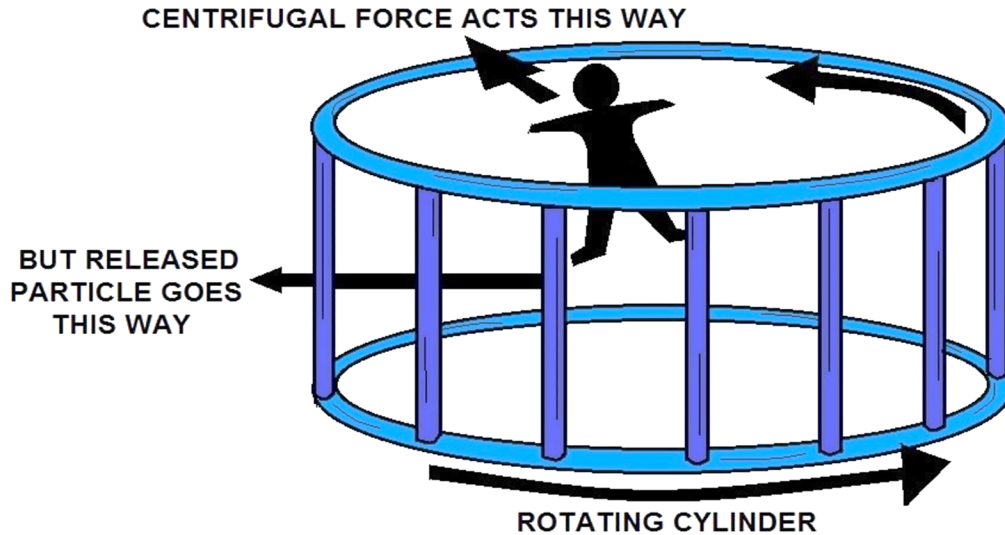

### CENTRIFUGAL PUMPING ACTION – WATER EFFECTS

First, you can view the water between the impeller blades as an object traveling in a circle. Objects do not naturally travel in a circle--they need an inward force to cause them to accelerate inward as they spin.

Without such an inward force, an object will travel in a straight line and will not complete the circle. In a centrifugal pump, that inward force is provided by high-pressure water near the outer edge of the pump housing. The water at the edge of the pump pushes inward on the water between the impeller blades and makes it possible for that water to travel in a circle. The water pressure at the edge of the turning impeller rises until it is able to keep water circling with the impeller blades.

You can also view the water as an incompressible fluid, one that obeys Bernoulli's equation in the appropriate contexts. As water drifts outward between the impeller blades of the pump, it must move faster and faster because its circular path is getting larger and larger. The impeller blades cause the water to move faster and faster.

By the time the water has reached the outer edge of the impeller, it is moving quite fast. However, when the water leaves the impeller and arrives at the outer edge of the cylindrical pump housing, it slows down.



# Bernoulli's Equation

Glenn  
Research  
Center

## Restrictions :

- Inviscid
- Steady
- Incompressible (low velocity)
- No heat addition.
- Negligible change in height.

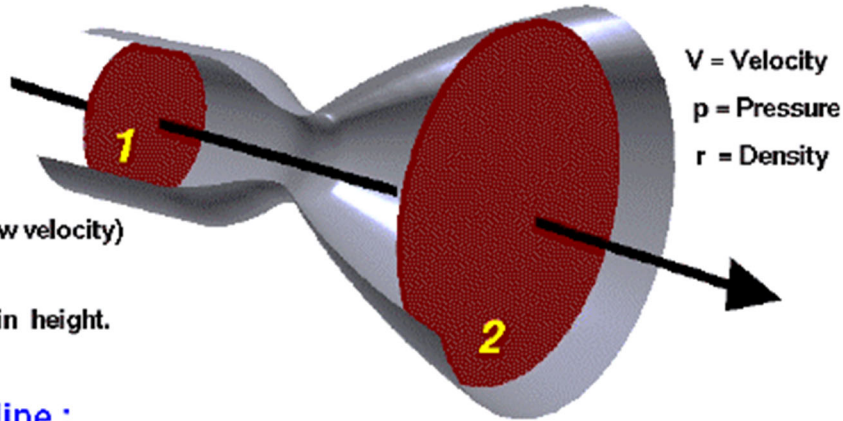

## Along a streamline :

static pressure + dynamic pressure = total pressure

$$p_s + \frac{rV^2}{2} = p_t$$

$$\left( p_s + \frac{rV^2}{2} \right)_1 = \left( p_s + \frac{rV^2}{2} \right)_2$$

Here is where Bernoulli's equation figures in. As the water slows down and its kinetic energy decreases, that water's pressure potential energy increases (**to conserve energy**). Thus, the slowing is accompanied by a pressure rise.

That is why the water pressure at the outer edge of the pump housing is higher than the water pressure near the center of the impeller.

When water is actively flowing through the pump, arriving through a hole near the center of the impeller and leaving through a hole near the outer edge of the pump housing, the pressure rise between center and edge of the pump is not as large.

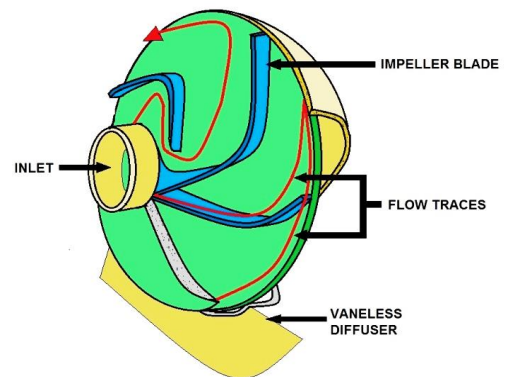

COMMON PUMP IMPELLER

## Key Pump Words

**NPSH:** Net positive suction head - related to how much suction lift a pump can achieve by creating a partial vacuum. Atmospheric pressure then pushes liquid into the pump. A method of calculating if the pump will work or not in a given application.

**S.G.:** Specific gravity. The weight of liquid in comparison to water at approx. 20 degrees C (SG = 1).

**Specific Speed:** A number which is the function of pump flow, head, efficiency etc. Not used in day to day pump selection, but very useful, as pumps with similar specific speed will have similar shaped curves, similar efficiency / NPSH / solids handling characteristics.

**Vapor Pressure:** If the vapor pressure of a liquid is greater than the surrounding air pressure, the liquid will boil.

**Viscosity:** A measure of a liquid's resistance to flow. i.e.: how thick it is. The viscosity determines the type of pump used, the speed it can run at, and with gear pumps, the internal clearances required.

**Friction Loss:** The amount of pressure / head required to 'force' liquid through pipe and fittings.

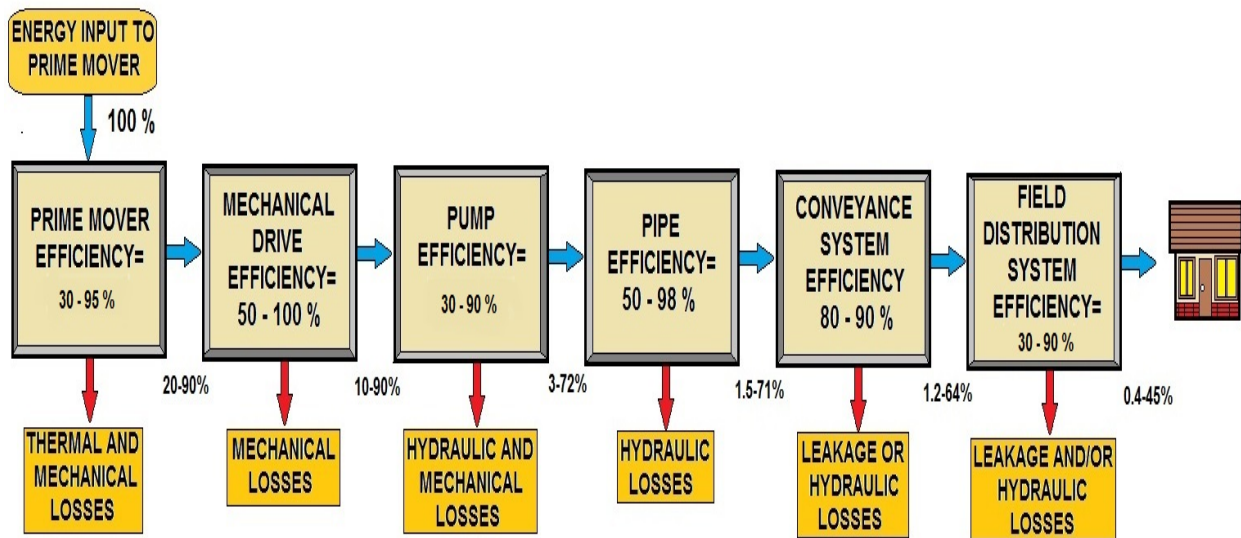

SYSTEM ENERGY EFFICIENCY LOSSES DIAGRAM

**Hyperlink to the Glossary and Appendix**

<http://www.abctlc.com/downloads/PDF/PumpGlossary.pdf>

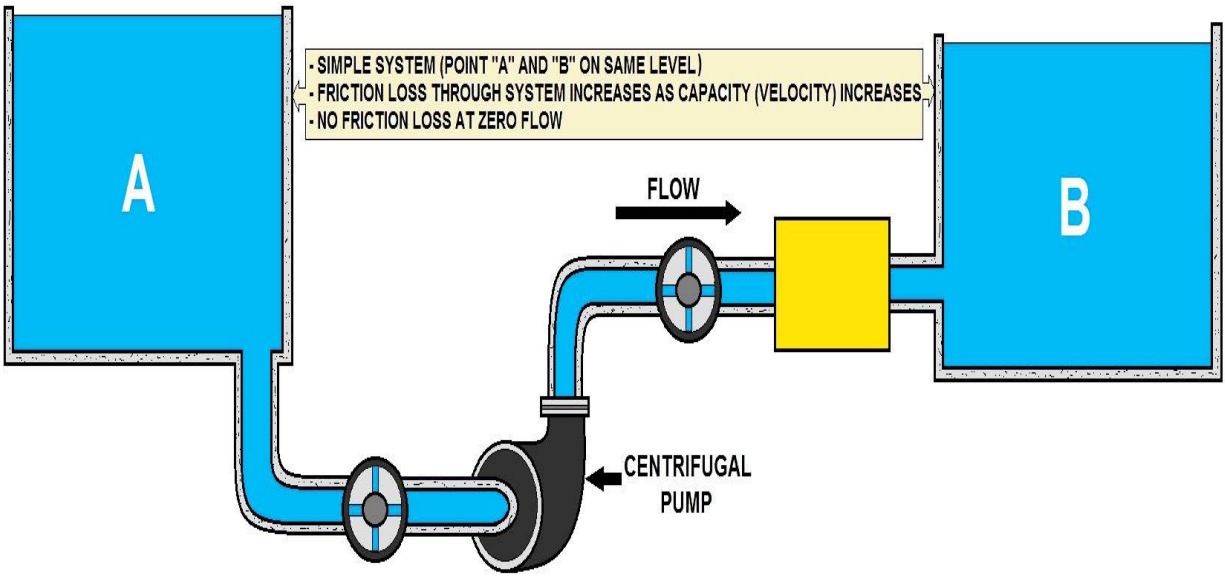

**CENTRIFUGAL PUMP CURVE CHARACTERISTICS**

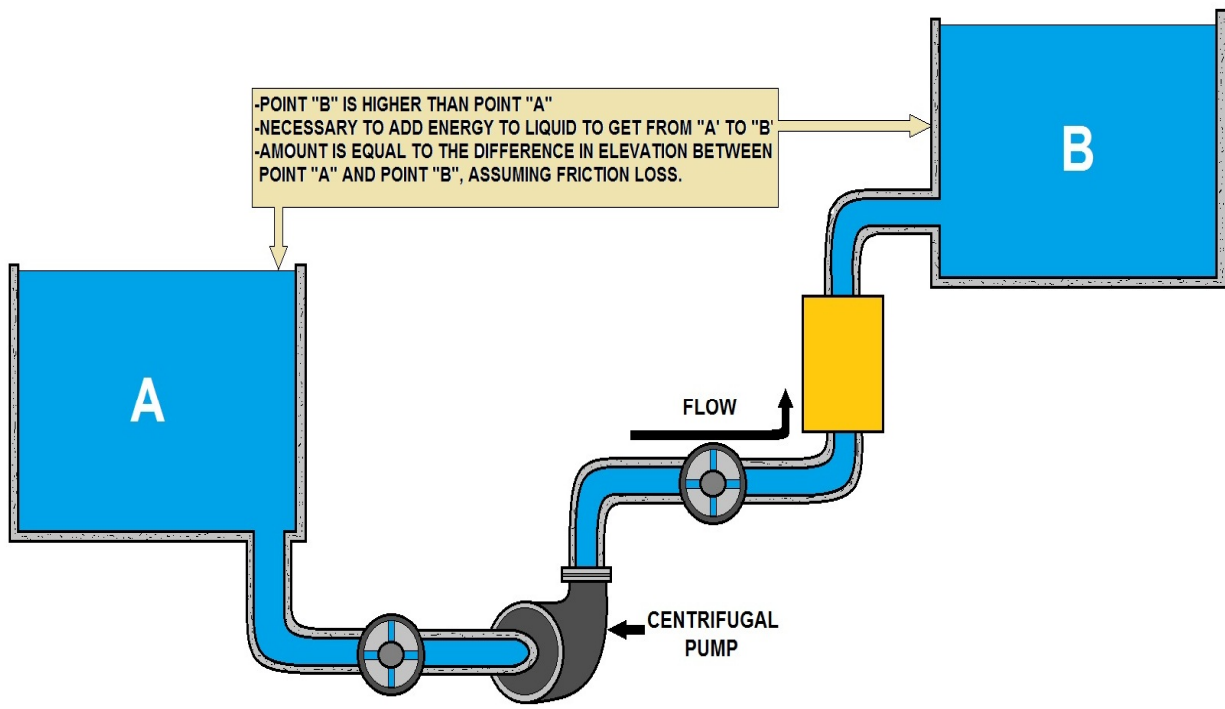

**CENTRIFUGAL PUMP CURVE CHARACTERISTICS**



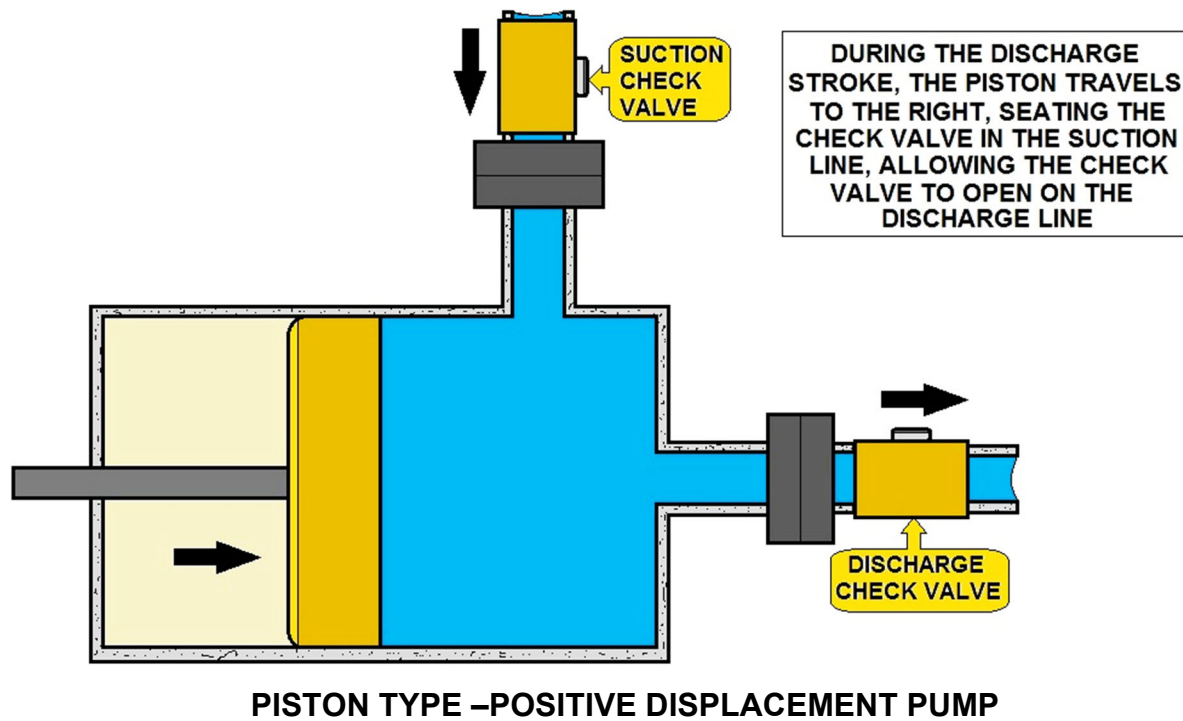

## Pumping Operation

We have already seen an important example of this in the hydraulic lever or hydraulic press, which we have called quasi-static. The simplest pump is the syringe, filled by withdrawing the piston and emptied by pressing it back in, as its port is immersed in the fluid or removed from it.

More complicated pumps have valves allowing them to work repetitively. These are usually check valves that open to allow passage in one direction, and close automatically to prevent reverse flow. There are many kinds of valves, and they are usually the most trouble-prone and complicated part of a pump.

The force pump has two check valves in the cylinder, one for supply and the other for delivery. The supply valve opens when the cylinder volume increases, the delivery valve when the cylinder volume decreases.

The lift pump has a supply valve and a valve in the piston that allows the liquid to pass around it when the volume of the cylinder is reduced. The delivery in this case is from the upper part of the cylinder, which the piston does not enter.

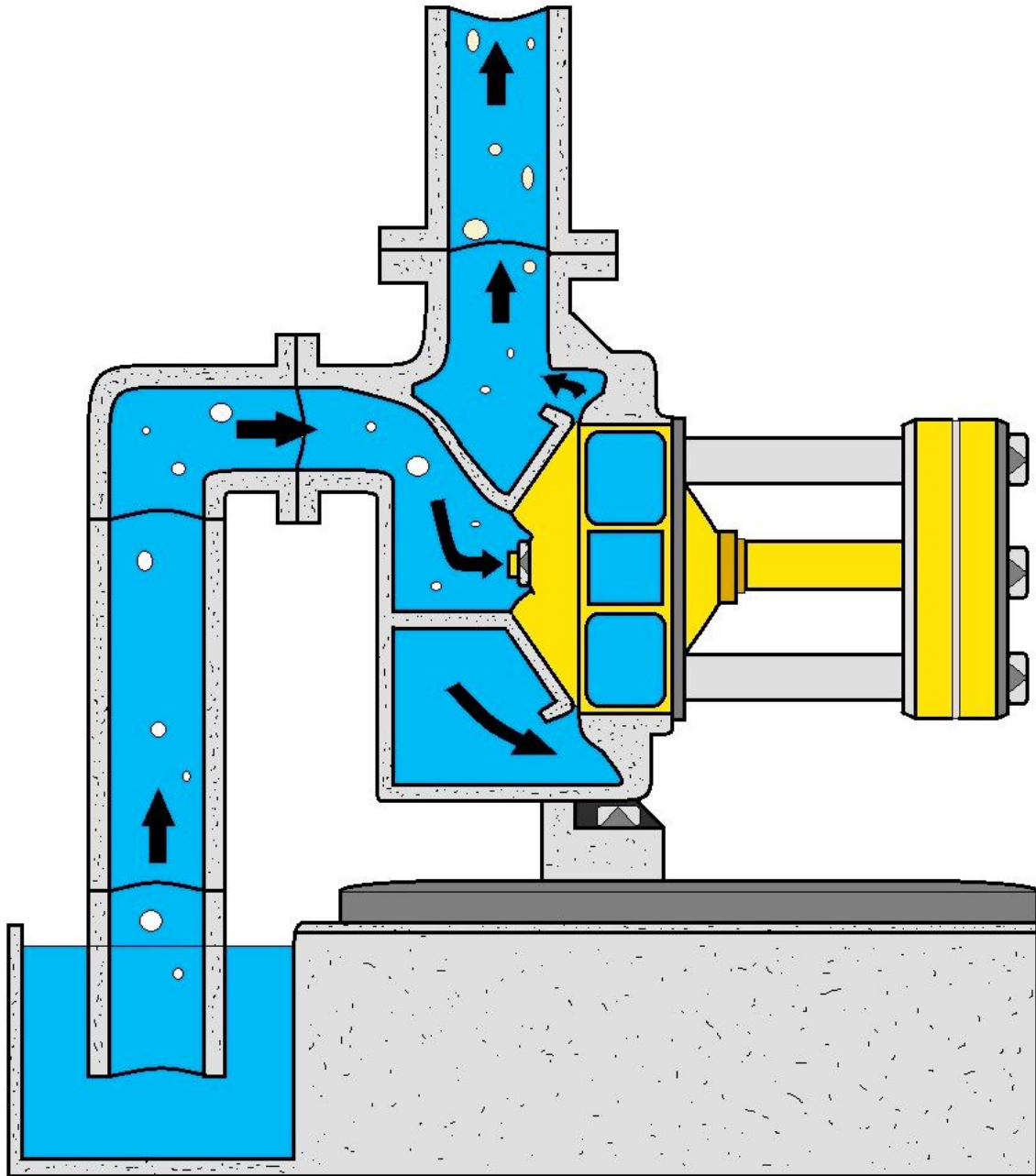

**PUMP PRIMING DIAGRAM**

**Self-Priming Pump**

A pump that does not require priming or initial filling with liquid. The pump casing carries a reserve of water that helps create a vacuum that will lift the fluid from a low source.

## Positive Displacement Pump Sub-Section

A positive displacement pump has an expanding cavity on the suction side of the pump and a decreasing cavity on the discharge side. Liquid is allowed to flow into the pump as the cavity on the suction side expands and the liquid is forced out of the discharge as the cavity collapses. This principle applies to all types of positive displacement pumps whether the pump is a rotary lobe, gear within a gear, piston, diaphragm, screw, progressing cavity, etc.

A positive displacement pump, unlike a centrifugal pump, will produce the same flow at a given RPM no matter what the discharge pressure is. A positive displacement pump cannot be operated against a closed valve on the discharge side of the pump, i.e. it does not have a shut-off head like a centrifugal pump does. If a positive displacement pump is allowed to operate against a closed discharge valve, it will continue to produce flow that will increase the pressure in the discharge line until either the line bursts or the pump is severely damaged or both.

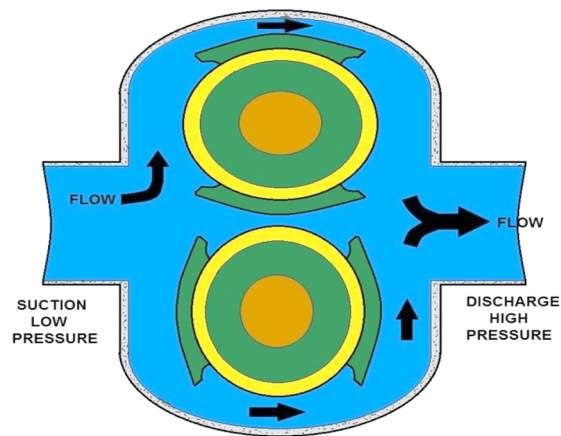

**POSITIVE DISPLACEMENT PUMP WITH ROTATING LOBES**

### Types of Positive Displacement Pumps

Single Rotor	Multiple Rotor
Vane	Gear
Piston	Lobe
Flexible Member	Circumferential Piston
Single Screw	Multiple Screw

**There are many other types of positive displacement pumps. We will look at:**

- ☛ Plunger pumps
- ☛ Diaphragm pumps
- ☛ Progressing cavity pumps, and
- ☛ Screw pumps

## Single Rotator Positive Displacement Pump

Component	Description
Vane	The vane(s) may be blades, buckets, rollers, or slippers that cooperate with a dam to draw fluid into and out of the pump chamber.
Piston	Fluid is drawn in and out of the pump chamber by a piston(s) reciprocating within a cylinder(s) and operating port valves.
Flexible Member	Pumping and sealing depends on the elasticity of a flexible member(s) that may be a tube, vane, or a liner.
Single Screw	Fluid is carried between rotor screw threads as they mesh with internal threads on the stator.

## Multiple Rotator

Component	Description
Gear	Fluid is carried between gear teeth and is expelled by the meshing of the gears that cooperate to provide continuous sealing between the pump inlet and outlet.
Lobe	Fluid is carried between rotor lobes that cooperate to provide continuous sealing between the pump inlet and outlet.
Circumferential piston	Fluid is carried in spaces between piston surfaces not requiring contacts between rotor surfaces.
Multiple Screw	Fluid is carried between rotor screw threads as they mesh.

## Plunger Pump

The plunger pump is a positive displacement pump that uses a plunger or piston to force liquid from the suction side to the discharge side of the pump. It is used for heavy sludge. The movement of the plunger or piston inside the pump creates pressure inside the pump, so you have to be careful that this kind of pump is never operated against any closed discharge valve. All discharge valves must be open before the pump is started, to prevent any fast build-up of pressure that could damage the pump.

## Diaphragm Pumps

In this type of pump, a diaphragm provides the mechanical action used to force liquid from the suction to the discharge side of the pump. The advantage the diaphragm has over the plunger is that the diaphragm pump does not come in contact with moving metal. This can be important when pumping abrasive or corrosive materials.

### There are three main types of diaphragm pumps available:

1. Diaphragm sludge pump
2. Chemical metering or proportional pump
3. Air-powered double-diaphragm pump

## Centrifugal Pump Sub-Section

By definition, a centrifugal pump is a simple machine. Specifically, a pump is a machine that imparts energy to a fluid. This energy infusion can cause a liquid to flow, rise to a higher level, or both.

The centrifugal pump is an extremely simple machine. It is a member of a family known as rotary machines and consists of two basic parts: 1) the rotary element or impeller and 2) the stationary element or casing (volute). The figure at the bottom of the page is a cross section of a centrifugal pump and shows the two basic parts.

In the operation of a centrifugal pump, the pump “slings” liquid out of the impeller via centrifugal force. One fact that must always be remembered: A pump does not create pressure; it only provides flow. Pressure is just an indication of the amount of resistance to flow. Centrifugal pumps may be classified in several ways. For example, they may be either Single Stage or Multi-Stage. A single-stage pump has only one impeller. A multi-stage pump has two or more impellers housed together in one casing.

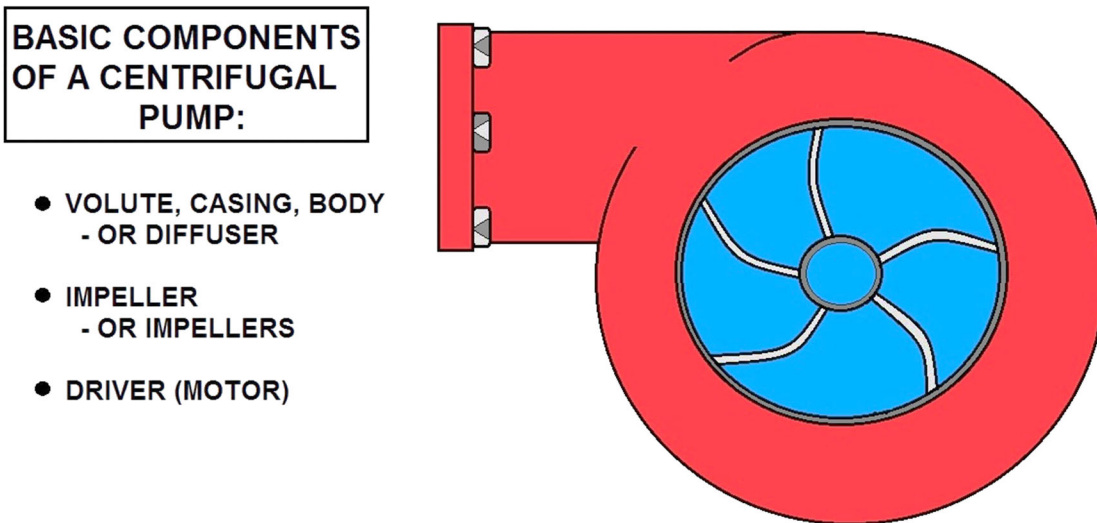

### BASICS OF A CENTRIFUGAL PUMP

As a standard, each impeller acts separately, discharging to the suction of the next stage impeller. This arrangement is called series staging. Centrifugal pumps are also classified as Horizontal or Vertical, depending upon the position of the pump shaft.

The impellers used on centrifugal pumps may be classified as single suction or double suction. The single-suction impeller allows liquid to enter the eye from one side only. The double-suction impeller allows liquid to enter the eye from two directions.

Impellers are also classified as opened or closed. Closed impellers have side walls that extend from the eye to the outer edge of the vane tips. Open impellers do not have these side walls. Some small pumps with single-suction impellers have only a casing wearing ring and no impeller ring. In this type of pump, the casing wearing ring is fitted into the end plate.

Recirculation lines are installed on some centrifugal pumps to prevent the pumps from overheating and becoming vapor bound, in case the discharge is entirely shut off or the flow of fluid is stopped for extended periods.

Seal piping is installed to cool the shaft and the packing, to lubricate the packing, and to seal the rotating joint between the shaft and the packing against air leakage. A lantern ring spacer is inserted between the rings of the packing in the stuffing box.

Seal piping leads the liquid from the discharge side of the pump to the annular space formed by the lantern ring. The web of the ring is perforated so that the water can flow in either direction along the shaft (between the shaft and the packing).

Water flinger rings may be fitted on the shaft between the packing gland and the pump bearing housing. These flingers prevent water in the stuffing box from flowing along the shaft and entering the bearing housing.

### Let's Look at the Components of the Centrifugal Pump...

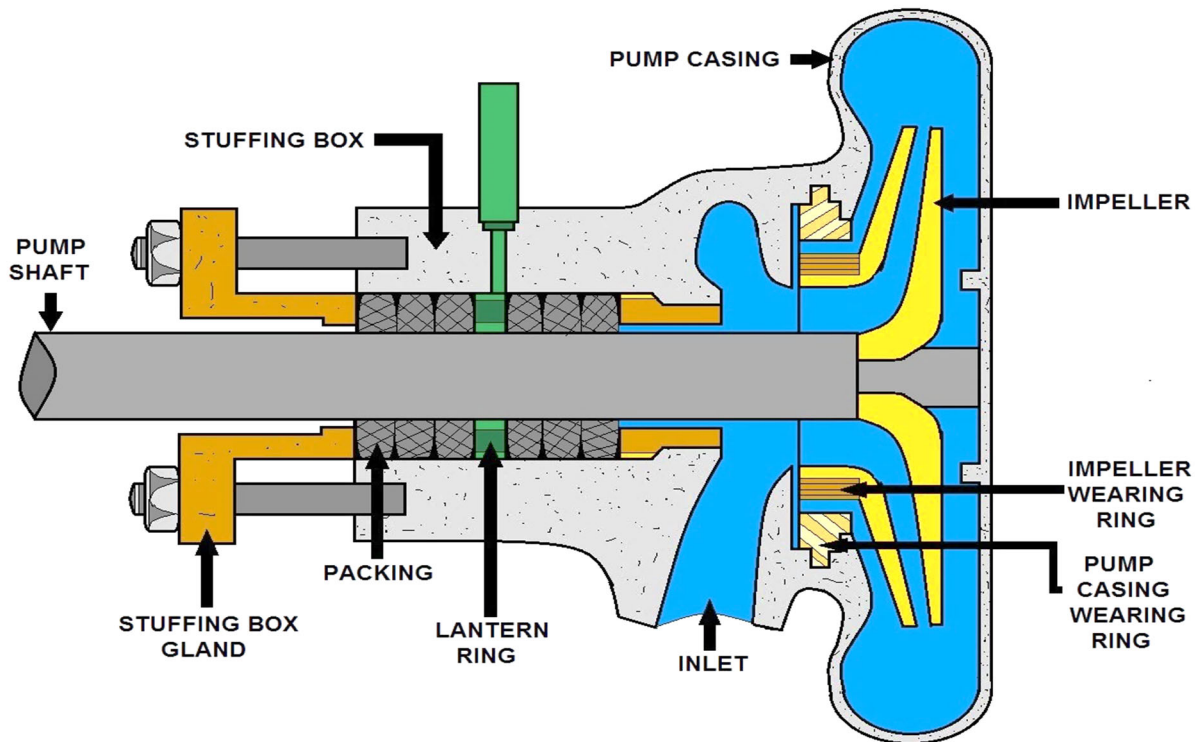

### CENTRIFUGAL PUMP CUT-AWAY DIAGRAM #1

As the impeller rotates, it sucks the liquid into the center of the pump and throws it out under pressure through the outlet. The casing that houses the impeller is referred to as the volute, the impeller fits on the shaft inside. The volute has an inlet and outlet that carries the water as shown above.

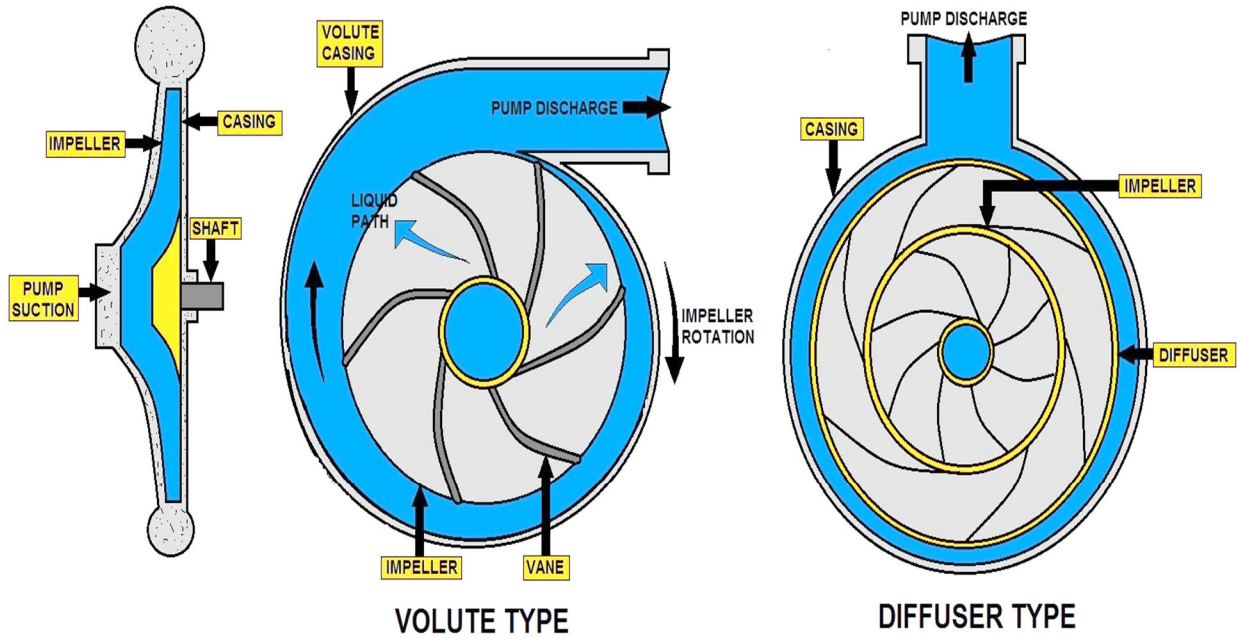

## TYPES OF CENTRIFUGAL PUMPS

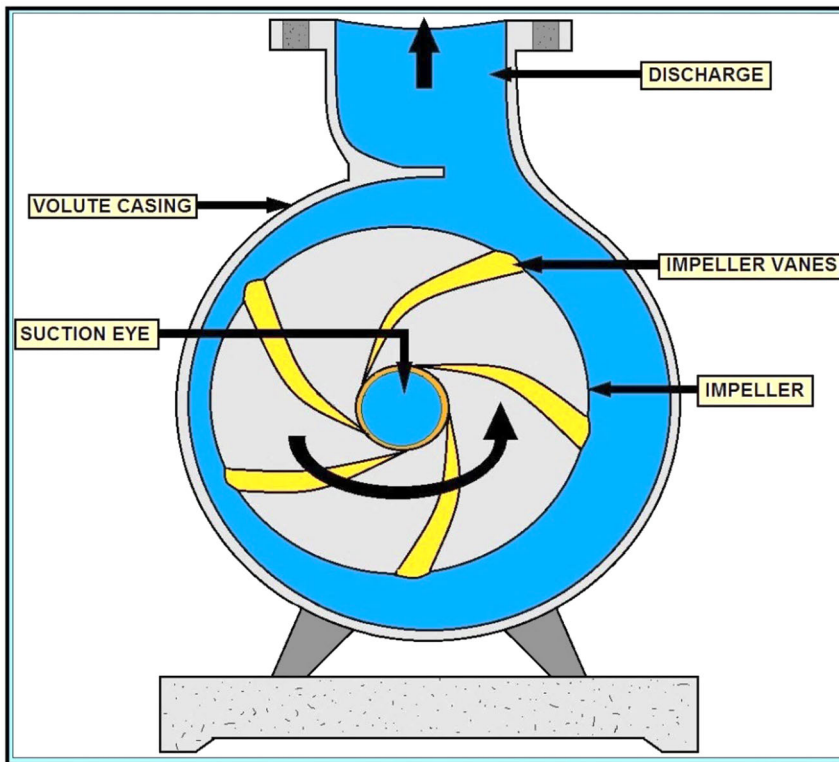

- LIQUID FORCED INTO IMPELLER
- VANES PASS KINETIC ENERGY TO LIQUID BEING PUMPED: LIQUID IS ROTATED AND LEAVES THE IMPELLER
- VOLUTE CASING CONVERTS THE KINETIC ENERGY INTO PRESSURE ENERGY

## HOW A CENTRIFUGAL PUMP WORKS

## Pump Casing

There are many variations of centrifugal pumps. The most common type is an end suction pump. Another type of pump used is the split case. There are many variations of split case, such as; two-stage, single suction, and double suction. Most of these pumps are horizontal.

There are variations of vertical centrifugal pumps. The line shaft turbine is really a multistage centrifugal pump.

## Impeller

In most centrifugal pumps, the impeller looks like a number of cupped vanes on blades mounted on a disc or shaft. Notice in the picture below how the vanes of the impeller force the water into the outlet of the pipe.

The shape of the vanes of the impeller is important. As the water is being thrown out of the pump, this means you can run centrifugal pumps with the discharged valve closed for a SHORT period of time. Remember the motor sends energy along the shaft, and if the water is in the volute too long it will heat up and create steam. Not good!

***Impellers are designed in various ways. We will look at:***

- Closed impellers
- Semi-open impellers
- Opened impellers, and
- Recessed impellers

The impellers all cause a flow from the eye of the impeller to the outside of the impeller. These impellers cause what is called **radial flow**, and they can be referred to as radial flow impellers.

The **critical distance** of the impeller and how it is installed in the casing will determine if it is high volume / low pressure or the type of liquid that could be pumped.

**Axial flow** impellers look like a propeller and create a flow that is parallel to the shaft.

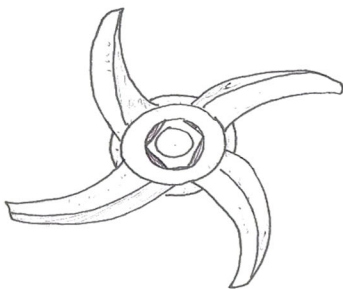

**OPEN**

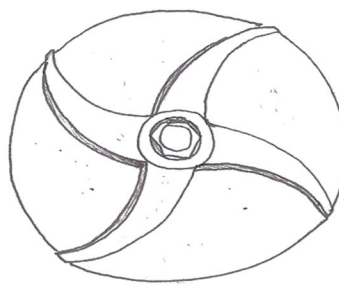

**SEMI-OPEN**

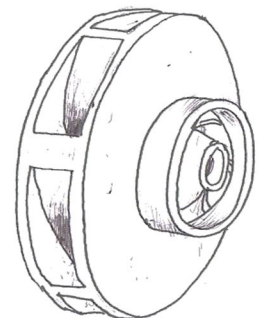

**CLOSED**



## More on Centrifugal or Roto-Dynamic Pump

The centrifugal or roto-dynamic pump produce a head and a flow by increasing the velocity of the liquid through the machine with the help of a rotating vane impeller. Centrifugal pumps include radial, axial and mixed flow units.

### Centrifugal Pumps Can Further be Classified As...

- ✓ end suction pumps
- ✓ in-line pumps
- ✓ double suction pumps
- ✓ vertical multistage pumps
- ✓ horizontal multistage pumps
- ✓ submersible pumps
- ✓ self-priming pumps
- ✓ axial-flow pumps
- ✓ regenerative pumps

The fact of the matter is that there are three types of problems mostly encountered with centrifugal pumps:

- ✓ design errors
- ✓ poor operation
- ✓ poor maintenance practices

### Working Mechanism of a Centrifugal Pump

A centrifugal pump is one of the simplest pieces of equipment in any process plant. Its purpose is to convert energy of a prime mover (an electric motor or turbine) first into velocity or kinetic energy and then into pressure energy of a fluid that is being pumped.

The energy changes occur by virtue of two main parts of the pump, the impeller and the volute or diffuser. The impeller is the rotating part that converts driver energy into the kinetic energy. The volute or diffuser is the stationary part that converts the kinetic energy into pressure energy.

**Note:** All of the forms of energy involved in a liquid flow system are expressed in terms of feet of liquid i.e. head.

### Generation of Centrifugal Force

The process liquid enters the suction nozzle and then into eye (center) of a revolving device known as an impeller. When the impeller rotates, it spins the liquid sitting in the cavities between the vanes outward and provides centrifugal acceleration.

As liquid leaves the eye of the impeller a low-pressure area is created causing more liquid to flow toward the inlet. Because the impeller blades are curved, the fluid is pushed in a tangential and radial direction by the centrifugal force. This force acting inside the pump is the same one that keeps water inside a bucket that is rotating at the end of a string.

### Selecting between Centrifugal or Positive Displacement Pumps

Selecting between a Centrifugal Pump or a Positive Displacement Pump is not always straight forward.

### **Flow Rate and Pressure Head**

The two types of pumps behave very differently regarding pressure head and flow rate: The centrifugal pump has varying flow depending on the system pressure or head. The positive displacement pump has more or less a constant flow regardless of the system pressure or head. positive displacement pumps generally gives more pressure than centrifugal pumps. Depending on how the measurement is taken suction lift and head may also be referred to as static or dynamic. Static indicates the measurement does not take into account the friction caused by water moving through the hose or pipes. Dynamic indicates that losses due to friction are factored into the performance. The following terms are usually used when referring to lift or head.

**Static Suction Lift** - The vertical distance from the water line to the centerline of the impeller.

**Static Discharge Head** - The vertical distance from the discharge outlet to the point of discharge or liquid level when discharging into the bottom of a water tank.

**Dynamic Suction Head** - The Static Suction Lift plus the friction in the suction line. Also referred to as a Total Suction Head.

**Dynamic Discharge Head** - The Static Discharge Head plus the friction in the discharge line. Also referred to as Total Discharge Head.

**Total Dynamic Head** - The Dynamic Suction Head plus the Dynamic Discharge Head. Also referred to as Total Head.

### **Capacity and Viscosity**

Another major difference between the pump types is the effect of viscosity on the capacity:

- ✓ In the centrifugal pump the flow is reduced when the viscosity is increased.
- ✓ In the positive displacement pump the flow is increased when viscosity is increased

Liquids with high viscosity fills the clearances of a positive displacement pump causing a higher volumetric efficiency and a positive displacement pump is better suited for high viscosity applications.

A centrifugal pump becomes very inefficient at even modest viscosity.

### **Mechanical Efficiency**

The pumps behaves different considering mechanical efficiency as well.

- ✓ Changing the system pressure or head has little or no effect on the flow rate in the positive displacement pump.
- ✓ Changing the system pressure or head has a dramatic effect on the flow rate in the centrifugal pump.

### **Net Positive Suction Head - NPSH**

Another consideration is the Net Positive Suction Head NPSH.

- ✓ In a centrifugal pump, NPSH varies as a function of flow determined by pressure.
- ✓ In a positive displacement pump, NPSH varies as a function of flow determined by speed. Reducing the speed of the positive displacement pump reduces the NPSH.

## Darcy-Weisbach Formula

### Flow of Fluid Through a Pipe

The flow of liquid through a pipe is resisted by viscous shear stresses within the liquid and the turbulence that occurs along the internal walls of the pipe, created by the roughness of the pipe material. This resistance is usually known as pipe friction and is measured in feet or meters head of the fluid, thus the term head loss is also used to express the resistance to flow.

Many factors affect the head loss in pipes, the viscosity of the fluid being handled, the size of the pipes, the roughness of the internal surface of the pipes, the changes in elevations within the system and the length of travel of the fluid.

The resistance through various valves and fittings will also contribute to the overall head loss. A method to model the resistances for valves and fittings is described elsewhere. In a well-designed system the resistance through valves and fittings will be of minor significance to the overall head loss, many designers choose to ignore the head loss for valves and fittings at least in the initial stages of a design.

Much research has been carried out over many years and various formulas to calculate head loss have been developed based on experimental data. Among these is the Chézy formula which dealt with water flow in open channels. Using the concept of 'wetted perimeter' and the internal diameter of a pipe the Chézy formula could be adapted to estimate the head loss in a pipe, although the constant 'C' had to be determined experimentally.

### The Darcy-Weisbach Equation

Weisbach first proposed the equation we now know as the Darcy-Weisbach formula or Darcy-Weisbach equation:

$$h_f = f (L/D) \times (v^2/2g)$$

where:

$h_f$  = head loss (m)

$f$  = friction factor

$L$  = length of pipe work (m)

$d$  = inner diameter of pipe work (m)

$v$  = velocity of fluid (m/s)

$g$  = acceleration due to gravity ( $m/s^2$ )

or:

$h_f$  = head loss (ft)

$f$  = friction factor

$L$  = length of pipe work (ft)

$d$  = inner diameter of pipe work (ft)

$v$  = velocity of fluid (ft/s)

$g$  = acceleration due to gravity ( $ft/s^2$ )

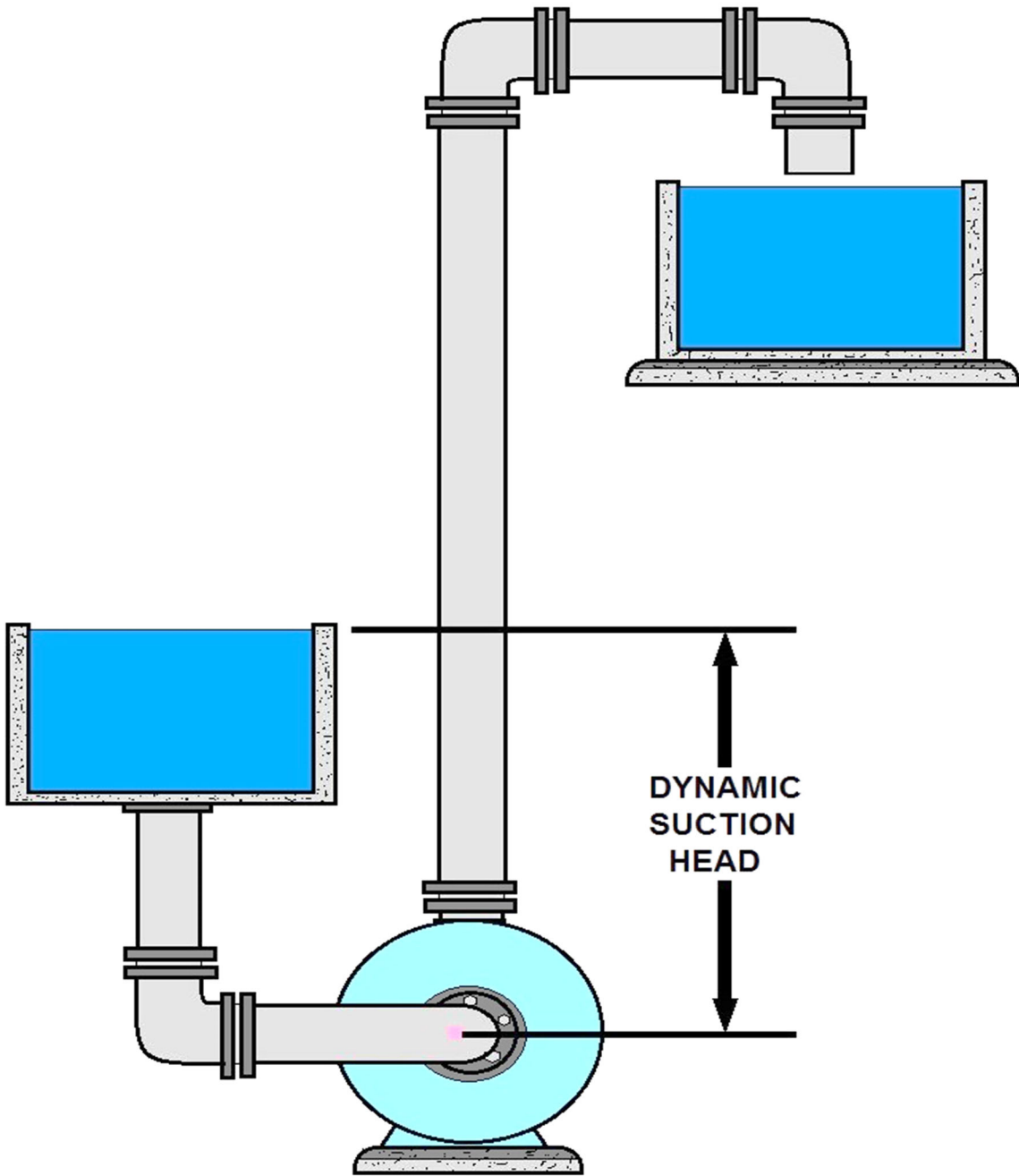

**DYNAMIC SUCTION HEAD DIAGRAM  
THE SUCTION LIFT PLUS FRICTION IN SUCTION LINE**

## Progressing Cavity Pump Sub-Section

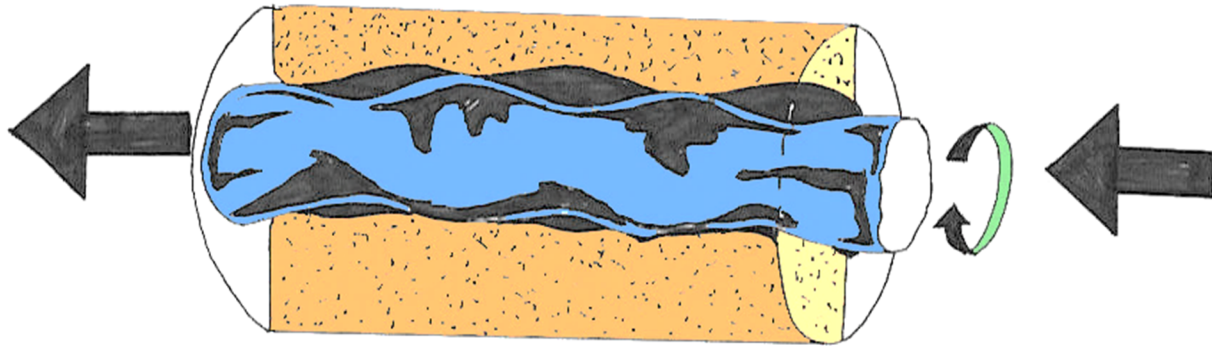

### PROGRESSING CAVITY ACTION

In this type of pump, components referred to as a rotor and an elastic stator provide the mechanical action used to force liquid from the suction side to the discharge side of the pump. As the rotor turns within the stator, cavities are formed which progress from the suction to the discharge end of the pump, conveying the pumped material.

The continuous seal between the rotor and the stator helices keeps the fluid moving steadily at a fixed flow rate proportional to the pump's rotational speed. Progressing cavity pumps are used to pump material very high in solids content. The progressive cavity pump must never be run dry, because the friction between the rotor and stator will quickly damage the pump.

#### More on the Progressive Cavity Pump

A progressive cavity pump is also known as a progressing cavity pump, eccentric screw pump, or even just cavity pump, and as is common in engineering generally, these pumps can often be referred to by using a generalized trademark. Hence, names can vary from industry to industry and even regionally; examples include: Mono pump, Moyno pump, Mohno pump, and Nemo pump.

This type of pump transfers fluid by means of the progress, through the pump, of a sequence of small, fixed shape, discrete cavities, as its rotor is turned. This leads to the volumetric flow rate being proportional to the rotation rate (bi-directionally) and to low levels of shearing being applied to the pumped fluid.

Therefore, these pumps have application in fluid metering and pumping of viscous or shear sensitive materials. It should be noted that the cavities taper down toward their ends and overlap with their neighbors, so that, in general, no flow pulsing is caused by the arrival of cavities at the outlet, other than that caused by compression of the fluid or pump components.

The principle of this pumping technique is frequently misunderstood; often it is believed to occur due to a dynamic effect caused by drag, or friction against the moving teeth of the screw rotor.

Nevertheless, in reality it is due to sealed cavities, like a piston pump, and so has similar operational characteristics, such as being able to pump at extremely low rates, even to high pressure, revealing the effect to be purely positive displacement.

The mechanical layout that causes the cavities to, uniquely, be of fixed dimensions as they move through the pump, is hard to visualize (it's essentially 3D nature renders diagrams quite ineffective for explanation), but it is accomplished by the preservation in shape of the gap formed between a helical shaft and a two start, twice the wavelength and double the diameter, helical hole, as the shaft is "rolled" around the inside surface of the hole. The motion of the rotor being the same as the smaller gears of a planetary gears system. This form of motion gives rise to the curves called Hypocycloids.

In order to produce a seal between cavities, the rotor requires a circular cross-section and the stator an oval one. The rotor so takes a form similar to a corkscrew, and this, combined with the off-center rotary motion, leads to the name; *Eccentric screw pump*.

Different rotor shapes and rotor/stator pitch ratios exist, but are specialized in that they don't generally allow complete sealing, so reducing low speed pressure and flow rate linearity, but improving actual flow rates, for a given pump size, and/or the pump's solids handling ability.

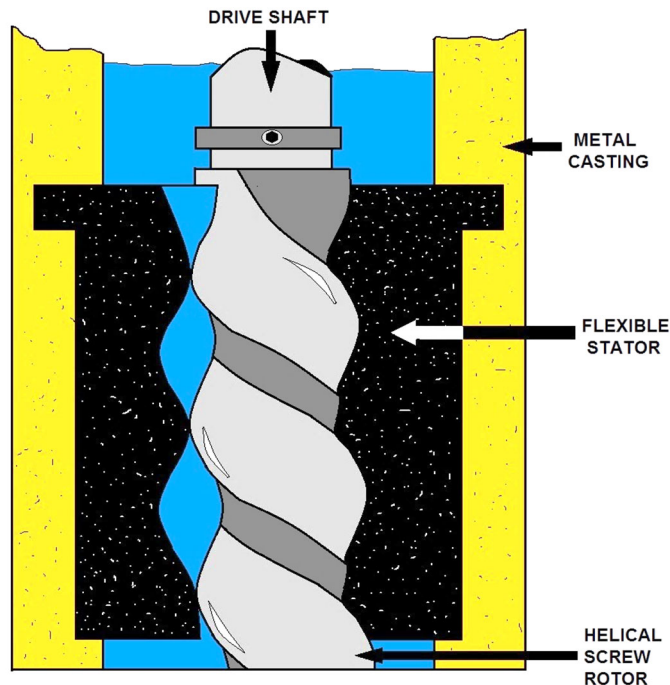

### PROGRESSIVE CAVITY PUMP

At a high enough pressure the sliding seals between cavities will leak some fluid rather than pumping it, so when pumping against high pressures a longer pump with more cavities is more effective, since each seal has only to deal with the pressure difference between adjacent cavities. Pumps with between two and a dozen or so cavities exist.

In operation, progressive cavity pumps are fundamentally fixed flow rate pumps, like piston pumps and peristaltic pumps. This type of pump needs a fundamentally different understanding to the types of pumps to which people are more commonly first introduced, namely ones that can be thought of as generating a pressure.

This can lead to the mistaken assumption that all pumps can have their flow rates adjusted by using a valve attached to their outlet, but with this type of pump this assumption is a problem, since such a valve will have practically no effect on the flow rate and completely closing it will involve very high, probably damaging, pressures being generated.

In order to prevent this, pumps are often fitted with cut-off pressure switches, burst disks (deliberately weak and easily replaced points), or a bypass pipe that allows a variable amount of a fluid to return to the inlet. With a bypass fitted, a fixed flow rate pump is effectively converted to a fixed pressure one.

At the points where the rotor touches the stator, the surfaces are generally traveling transversely, so small areas of sliding contact occur, these areas need to be lubricated by the fluid being pumped (Hydrodynamic lubrication), this can mean that more torque is required for starting, and if allowed to operate without fluid, called 'run dry', rapid deterioration of the stator can result.

While progressive cavity pumps offer long life and reliable service transporting thick or lumpy fluids, abrasive fluids will significantly shorten the life of the stator. However, slurries (particulates in a medium) can be pumped reliably, as long as the medium is viscous enough to maintain a lubrication layer around the particles and so provide protection to the stator.

Specific designs involve the rotor of the pump being made of a steel, coated in a smooth hard surface, normally chromium, with the body (the stator) made of a molded elastomer inside a metal tube body. The Elastomer core of the stator forms the required complex cavities.

The rotor is held against the inside surface of the stator by angled link arms, bearings (which have to be within the fluid) allowing it to roll around the inner surface (un-driven).

Elastomer is used for the stator to simplify the creation of the complex internal shape, created by means of casting, and also improves the quality and longevity of the seals by progressively swelling due to absorption of water and/or other common constituents of pumped fluids. Elastomer/pumped fluid compatibility will thus need to be taken into account.

Two common designs of stator are the "Equal-walled" and the "Unequal walled". The latter, having greater elastomer wall thickness at the peaks, allows larger-sized solids to pass through because of its increased ability to distort under pressure.

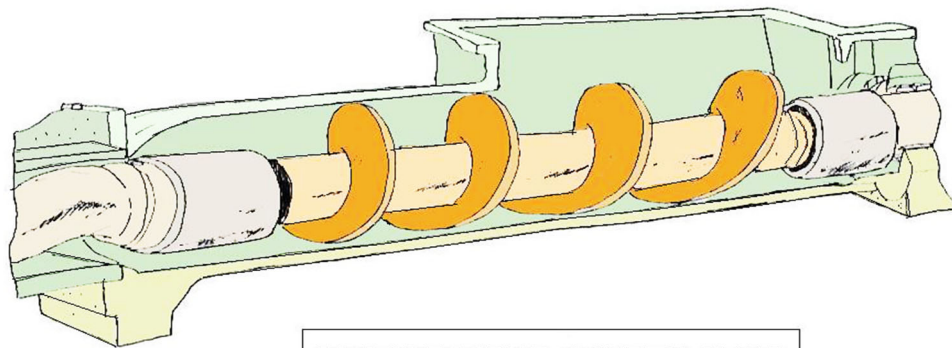

**PROGRESSIVE CAVITY PUMP**

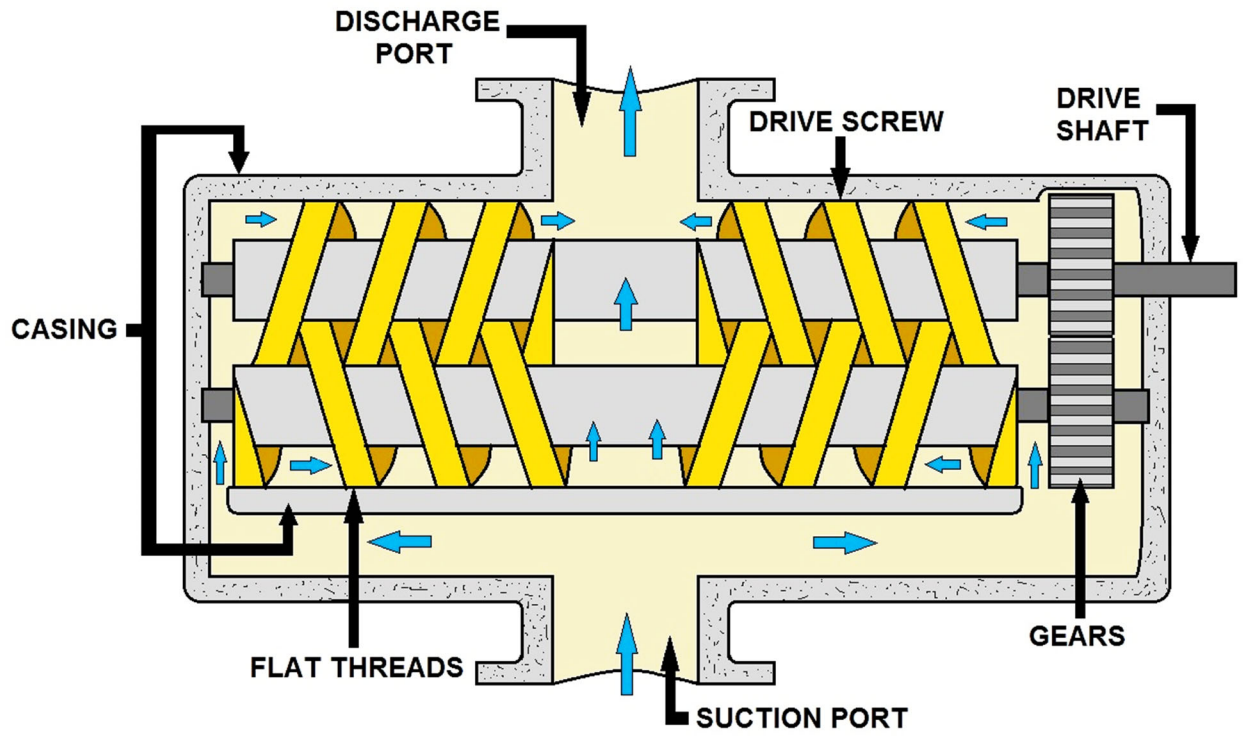

**POSITIVE DISPLACEMENT PUMP  
SCREW TYPE**



## Peristaltic Pump Sub-Section

A peristaltic pump is a type of positive displacement pump used for pumping a variety of fluids. The fluid is contained within a flexible tube fitted inside a circular pump casing (though linear peristaltic pumps have been made). A rotor with a number of "rollers", "shoes" or "wipers" attached to the external circumference compresses the flexible tube.

As the rotor turns, the part of the tube under compression closes (or "occludes") thus forcing the fluid to be pumped to move through the tube. Additionally, as the tube opens to its natural state after the passing of the cam ("restitution") fluid flow is induced to the pump. This process is called peristalsis and is used in many biological systems such as the gastrointestinal tract.



### Priming a Pump

Liquid and slurry pumps can lose prime and this will require the pump to be primed by adding liquid to the pump and inlet pipes to get the pump started. Loss of "prime" is usually due to ingestion of air into the pump. The clearances and displacement ratios in pumps used for liquids and other more viscous fluids cannot displace the air due to its lower density.

### Plunger Pumps

Plunger pumps are reciprocating positive displacement pumps. They consist of a cylinder with a reciprocating plunger in them. The suction and discharge valves are mounted in the head of the cylinder. In the suction stroke the plunger retracts and the suction valves open causing suction of fluid into the cylinder. In the forward stroke the plunger pushes the liquid out of the discharge valve.

### **Efficiency and Common Problems**

With only one cylinder in plunger pumps, the fluid flow varies between maximum flow when the plunger moves through the middle positions and zero flow when the plunger is at the end positions. A lot of energy is wasted when the fluid is accelerated in the piping system. Vibration and "water hammer" may be a serious problem. In general, the problems are compensated for by using two or more cylinders not working in phase with each other.

### **Priming a Pump**

Liquid and slurry pumps can lose prime and this will require the pump to be primed by adding liquid to the pump and inlet pipes to get the pump started.

Loss of "prime" is usually due to ingestion of air into the pump. The clearances and displacement ratios in pumps used for liquids and other more viscous fluids cannot displace the air due to its lower density.

### **Compressed-Air-Powered Double-Diaphragm Pumps**

One modern application of positive displacement diaphragm pumps is compressed-air-powered double-diaphragm pumps.

Run on compressed air these pumps are intrinsically safe by design, although all manufacturers offer ATEX certified models to comply with industry regulation.

Commonly seen in all areas of industry from shipping to processing, Wilden Pumps, Graco, SandPiper or ARO are generally the larger of the brands.

They are relatively inexpensive and can be used for almost any duty from pumping water out of bunds, to pumping hydrochloric acid from secure storage (dependent on how the pump is manufactured – elastomers / body construction).

Lift is normally limited to roughly 18 feet (6m) although heads can reach almost 200 Psi.



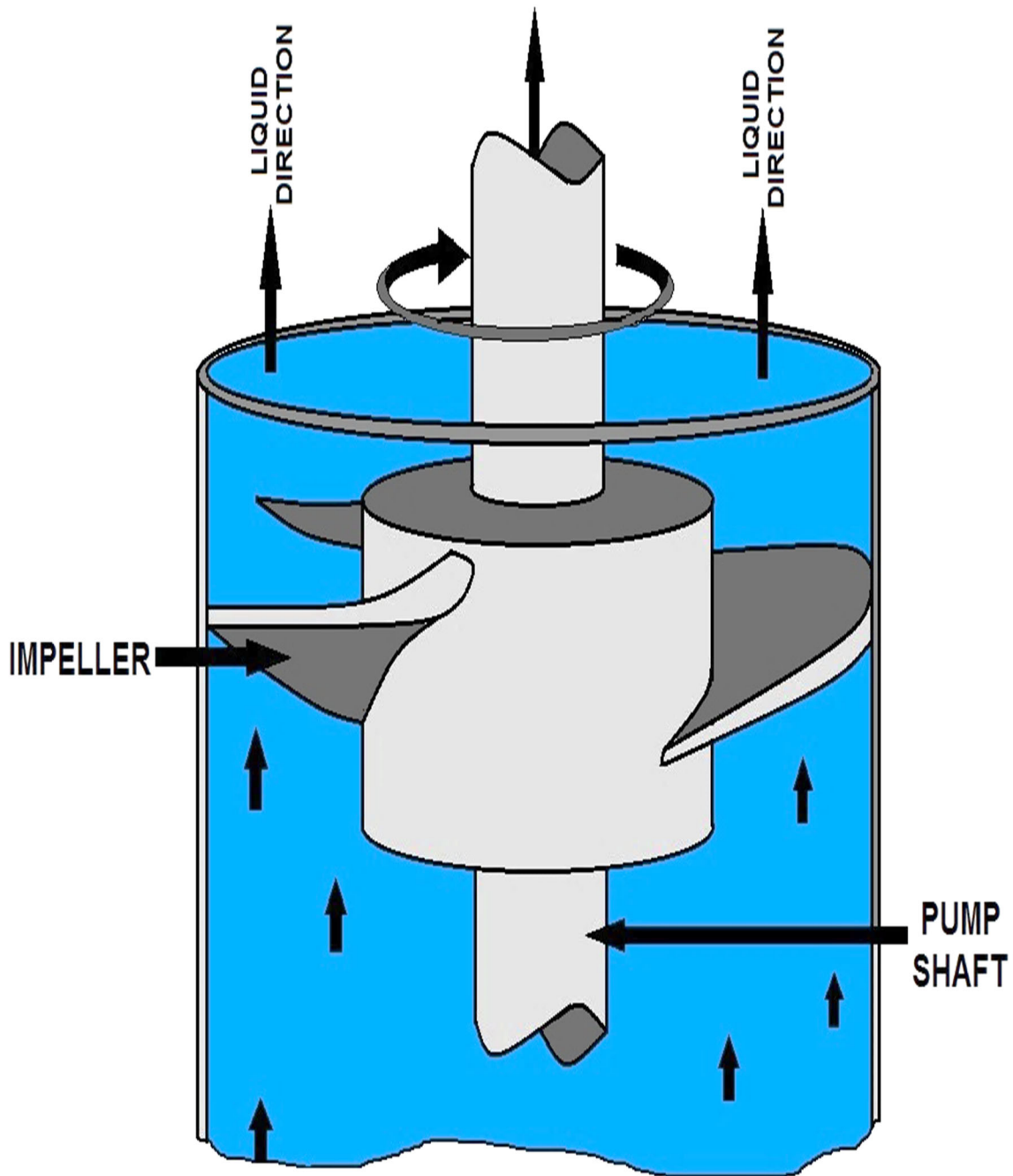

**AXIAL FLOW PUMPING PRINCIPAL  
IMPELLER FORCES LIQUID IN DIRECTION PARALLEL TO SHAFT**

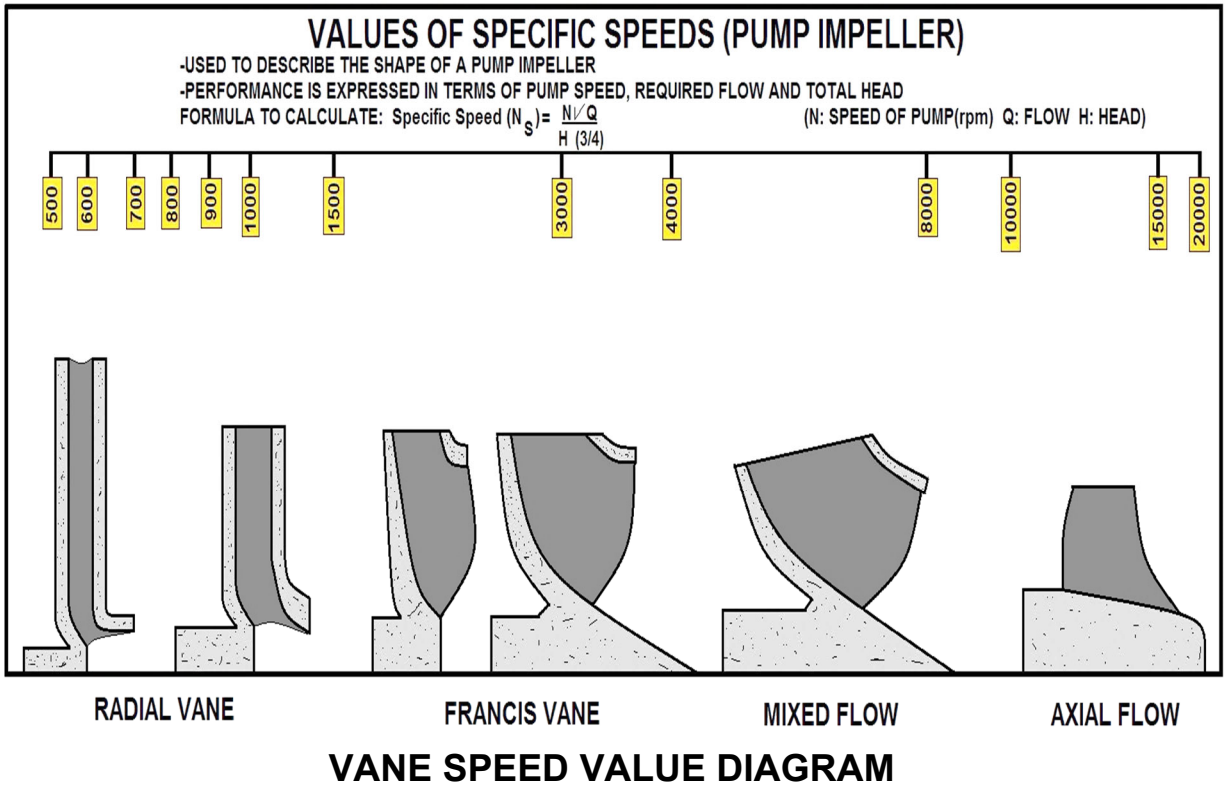

## Understanding Progressing Cavity Pump Theory

Progressing cavity pumps (PCPs) are a special type of rotary positive displacement pump where the produced fluid is displaced axially at a constant rate. This characteristic enables progressing cavity pumps to produce viscous, abrasive, multiphase and gaseous fluids and slurries over a wide range of flow rates and differential pressures. Progressing cavity pumps are comprised of two helicoidal gears (rotor and stator), where the rotor is positioned inside the stator. The combination of rotational movement and geometry of the rotor inside the stator results in the formation of cavities that move axially from pump suction to pump discharge.

Rotors are typically machined from high-strength steel and then coated with a wear resistant material to resist abrasion and reduce stator/rotor friction. Stators consist of steel tubular with an elastomer core bonded to the steel. The elastomer is molded into the shape of an internal helix to match the rotor.

Progressive cavity pumps are fundamentally fixed flow rate pumps, like piston pumps and peristaltic pumps, and this type of pump needs a fundamentally different understanding to the types of pumps to which people are more commonly first introduced, namely ones that can be thought of as generating pressure.

This can lead to the mistaken assumption that all pumps can have their flow rates adjusted by using a valve attached to their outlet, but with this type of pump this assumption is a problem, since such a valve will have practically no effect on the flow rate and completely closing it will involve very high pressures being generated.

To prevent this, pumps are often fitted with cut-off pressure switches, burst disks (deliberately weak and easily replaced), or a bypass pipe that allows a variable amount a fluid to return to the inlet. With a bypass fitted, a fixed flow rate pump is effectively converted to a fixed pressure one.

At the points where the rotor touches the stator, the surfaces are generally traveling transversely, so small areas of sliding contact occur. These areas need to be lubricated by the fluid being pumped (Hydrodynamic lubrication). This can mean that more torque is required for starting, and if allowed to operate without fluid, called 'run dry', rapid deterioration of the stator can result. Progressive cavity pumps offer long life and reliable service transporting thick or lumpy substances.

### **Helical Rotor and a Twin Helix**

The progressive cavity pump consists of a helical rotor and a twin helix, twice the wavelength and double the diameter helical hole in a rubber stator. The rotor seals tightly against the rubber stator as it rotates, forming a set of fixed-size cavities in between. The cavities move when the rotor is rotated but their shape or volume does not change. The pumped material is moved inside the cavities.

The principle of this pumping technique is frequently misunderstood. Often it is believed to occur due to a dynamic effect caused by drag, or friction against the moving teeth of the screw rotor. In reality, it is due to the sealed cavities, like a piston pump, and so has similar operational characteristics, such as being able to pump at extremely low rates, even to high pressure, revealing the effect to be purely positive displacement.

At a high enough pressure, the sliding seals between cavities will leak some fluid rather than pumping it, so when pumping against high pressures a longer pump with more cavities is more effective, since each seal has only to deal with the pressure difference between adjacent cavities. Pumps with between two and a dozen (or so) cavities exist.

When the rotor is rotated, it rolls around the inside surface of the hole. The motion of the rotor is the same as the smaller gears of a planetary gears system. As the rotor simultaneously rotates and moves around, the combined motion of the eccentrically mounted drive shaft is in the form of a hypocycloid. In the typical case of single-helix rotor and double-helix stator, the hypocycloid is just a straight line. The rotor must be driven through a set of universal joints or other mechanisms to allow for the movement.

The rotor takes a form similar to a corkscrew, and this, combined with the off-center rotary motion, leads to the alternative name: eccentric screw pump. Different rotor shapes and rotor/stator pitch ratios exist, but are specialized in that they don't generally allow complete sealing, so reducing low speed pressure and flow rate linearity, but improving actual flow rates, for a given pump size, and/or the pump's solids handling ability

Specific designs involve the rotor of the pump being made of a steel, coated with a smooth hard surface, normally chromium, with the body (the stator) made of a molded elastomer inside a metal tube body. The elastomer core of the stator forms the required complex cavities. The rotor is held against the inside surface of the stator by angled link arms, bearings (immersed in the fluid) allowing it to roll around the inner surface (un-driven).

### **Elastomer**

Elastomer is used for the stator to simplify the creation of the complex internal shape, created by means of casting, which also improves the quality and longevity of the seals by progressively swelling due to absorption of water and/or other common constituents of pumped fluids. Elastomer/pumped fluid compatibility will thus need to be taken into account. Two common designs of stator are the "equal-walled" and the "unequal-walled". The latter, having greater elastomer wall thickness at the peaks allows larger-sized solids to pass through because of its increased ability to distort under pressure.

The former have a constant elastomer wall thickness and therefore exceed in most other aspects such as pressure per stage, precision, heat transfer, wear and weight. They are more expensive due to the complex shape of the outer tube.

Cavities are created by the geometry of the rotor and stator where the stator has one more lobe than the rotor. The cavities are moved axially along the pump by the rotating motion of the rotor. The motion of the rotor is a combination of a clockwise rotation of the rotor along its own axis and a counterclockwise rotation of the rotor eccentrically about the axis of the stator. Because the volume of each cavity remains constant throughout the process, the pump delivers a uniform non-pulsating flow. The total pressure capability of the pump is determined by the maximum pressure that can be generated within each cavity times the total number of cavities.

PC pumps are manufactured with a variety of stator/rotor tooth combinations. Typically, artificial lift applications use a two-tooth stator and a single tooth rotor pump referred to as single-lobe pump. Higher stator/rotor tooth combinations, such as 3/2, are used to achieve higher volumetric and lift capacity although with higher torque requirements.

## **Understanding Pump NPSH**

NPSH is an initialism for Net Positive Suction Head. In any cross-section of a generic hydraulic circuit, the NPSH parameter shows the difference between the actual pressure of a liquid in a pipeline and the liquid's vapor pressure at a given temperature. NPSH is an important parameter to take into account when designing a circuit: whenever the liquid pressure drops below the vapor pressure, liquid boiling occurs, and the final effect will be cavitation: vapor bubbles may reduce or stop the liquid flow, as well as damage the system.

Centrifugal pumps are particularly vulnerable especially when pumping heated solution near the vapor pressure, whereas positive displacement pumps are less affected by cavitation, as they are better able to pump two-phase flow (the mixture of gas and liquid), however, the resultant flow rate of the pump will be diminished because of the gas volumetrically displacing a disproportion of liquid. Careful design is required to pump high temperature liquids with a centrifugal pump when the liquid is near its boiling point.

The violent collapse of the cavitation bubble creates a shock wave that can literally carve material from internal pump components (usually the leading edge of the impeller) and creates noise often described as "pumping gravel". Additionally, the inevitable increase in vibration can cause other mechanical faults in the pump and associated equipment.

### **A somewhat simpler informal way to understand NPSH...**

Fluid can be pushed down a pipe with a great deal of force. The only limit is the ability of the pipe to withstand the pressure. However, a liquid cannot be pulled up a pipe with much force because bubbles are created as the liquid evaporates into a gas. The greater the vacuum created, the larger the bubble, so no more liquid will flow into the pump.

Rather than thinking in terms of the pump's ability to pull the fluid, the flow is limited by the ability of gravity and air pressure to push the fluid into the pump. The atmosphere pushes down on the fluid, and if the pump is below the tank, the weight of the fluid from gravity above the pump inlet also helps. Until the fluid reaches the pump, those are the only two forces providing the push. Friction loss and vapor pressure must also be considered.

Friction loss limits the ability of gravity and air pressure to push the water toward the pump at high speed. Vapor pressure refers to the point at which bubbles form in the liquid. NPSH is a measure of how much spare pull you have before the bubbles form.

Some helpful information regarding atmospheric pressure; Atmospheric pressure is always naturally occurring and is always around us. At sea level, it equates to 101.325 kPa or approximately 14 Psi OR 10 meters of liquid pressure head. As we move higher up mountains, the air gets thinner and the atmospheric pressure reduces.

This should be taken into account when designing pumping systems. The reason there is atmospheric pressure is simply due to earth's gravity and its position in our solar system. It is a natural phenomenon and we are very lucky to have it as water wells and bores with shallow aquifers allow us to use this atmospheric pressure to our advantage.

We all know that pressure gauges exist on pumping systems and other machines to give us an indication of what performances are being achieved. We also use known pressures versus known performance in order to create a reference for system designs.

An example would be an experienced pump technician or plumber knowing that a pressure of between 300 kPa and 500 kPa will provide adequate and comfortable pressure for household use.

A typical pressure gauge reads what is known as 'Gauge Pressure,' or pressure relative to atmospheric pressure. An 'Absolute Pressure' gauge displays atmospheric pressure (typically 100 kPa or 14 psi or 10 meters of liquid pressure head) before any system had been connected. Manufacturers set typical gage pressure gauges to read ZERO at sea level as a standard, assuming designers will make allowances for the atmospheric pressure calculations themselves. Knowing this simple fact can make NPSH easier to understand.

If we now know that there is 100 kPa or 10 meters of head pressure, plus or minus whatever the gage pressure gauge shows, then we can safely see that this gives us an instant advantage of 10 meters of head pressure at sea level.

This means we can borrow against this and drop a maximum of 10 meters into or under the ground (or below sea level) reducing the gauge to zero and still get natural 'push' into our pump. Great for wells and bores with shallow aquifers within this depth! It is important to note that to get to exactly 10 meters may be difficult, but with the correct pipework and system design, it is possible to get very close.

Once NPSH is fully understood, sizing and controlling pumps and pumping machines is a much simpler task.

NPSH is the liquid suction force at the intake of a pump. In other words, the force of a liquid naturally "pushing" into a pump from gravity pressure plus liquid head pressure only - into a single pump intake.

***This means;***

NPSH = the net (left over) positive pressure of suction force into a pump intake after friction loss has occurred. Liquid head height or liquid head pressure + gravity pressure, minus friction loss, leaves a net head pressure of force into the pump. If we want to pump some amount of liquid, we have to ensure that this liquid can reach the center line of the suction point of the pump. NPSH represents the head (pressure and gravity head) of liquid in the suction line of the pump that will overcome the friction along the suction line.

NPSHR is the amount of liquid pressure required at the intake port of a pre-designed and manufactured pump. This is known as NPSHR (Net Positive Suction Head Required). The pump manufacturer will usually clearly have a NPSH curve to assist you in the correct installation.

NPSHA is the amount (A = available) to the pump intake after pipe friction losses and head pressures have been taken into account.

**The Reason for This Requirement?**

When the pump is receiving liquid at intake port and the impeller is pushing the liquid out the discharge port, they are effectively trying to tear each other apart because the pump is changing the liquid movement by a pressure increase at the impeller vanes, (general pump installations). Insufficient NPSHR will cause a low or near-vacuum pressure (negative NPSHA) to exist at the pump intake.



This will cause the liquid to boil and cause cavitation, and the pump will not receive the liquid fast enough because it will be attempting to pump vapor. Cavitation will lower pump performance and damage pump internals. At low temperatures the liquid can "hold together" (remain fluid) relatively easily, hence a lower NPSH requirement. However, at higher temperatures, the higher vapor pressure starts the boiling process much quicker, hence a high NPSH requirement.

- ✓ Water will boil at lower temperatures under lower pressures. Conversely its boiling point is higher at higher pressures.
- ✓ Water boils at 100 degrees Celsius at sea level and an atmospheric pressure of 1 bar.
- ✓ Vapor Pressure is the pressure of a gas in equilibrium with its liquid phase at a given temperature. If the vapor pressure at a given temperature is greater than the pressure of the atmosphere above the liquid, then the liquid will boil. (This is why water boils at a lower temperature high in the mountains).
- ✓ At normal atmospheric pressure minus 5 psi (or -0.35 bar) water will boil at 89 degrees Celsius.
- ✓ At normal atmospheric pressure minus 10 psi (or -0.7 bar) water will boil at 69 degrees Celsius.
- ✓ At a positive pressure of +12 psi or +0.82 bar above atmospheric, water will boil at 118 degrees Celsius.
- ✓ Liquid temperature greatly affects NPSH and must be taken into account when expensive installations are being designed.
- ✓ A pump designed with a NPSHR suitable for cold water may cavitate when pumping hot water

**Hyperlink to the Glossary and Appendix**

<http://www.abctlc.com/downloads/PDF/PumpGlossary.pdf>



## Reciprocating Pump Sub-Section

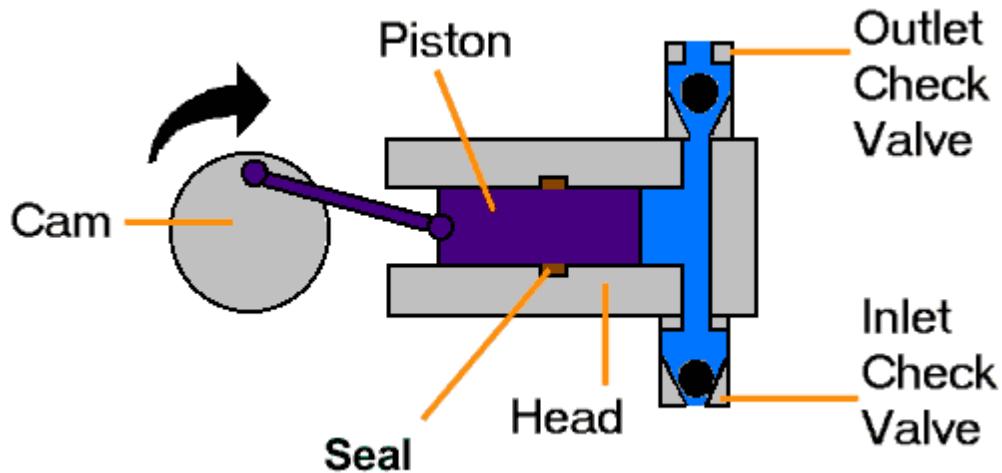

### Typical reciprocating pumps are

- Plunger pumps
- Diaphragm pumps

A plunger pump consists of a cylinder with a reciprocating plunger in it. The suction and discharge valves are mounted in the head of the cylinder. In the suction stroke the plunger retracts and the suction valves open causing suction of fluid into the cylinder. In the forward stroke the plunger pushes the liquid out of the discharge valve.

With only one cylinder the fluid flow varies between maximum flow when the plunger moves through the middle positions and zero flow when the plunger is at the end positions. A lot of energy is wasted when the fluid is accelerated in the piping system. Vibration and "water hammer" may be a serious problem. In general, the problems are compensated for by using two or more cylinders not working in phase with each other.

In diaphragm pumps, the plunger pressurizes hydraulic oil which is used to flex a diaphragm in the pumping cylinder. Diaphragm valves are used to pump hazardous and toxic fluids. An example of the piston displacement pump is the common hand soap pump.

### Gear Pump

This uses two meshed gears rotating in a closely fitted casing. Fluid is pumped around the outer periphery by being trapped in the tooth spaces. It does not travel back on the meshed part, since the teeth mesh closely in the center. Widely used on car engine oil pumps. It is also used in various hydraulic power packs.

### Progressing Cavity Pump

Widely used for pumping difficult materials such as sewage sludge contaminated with large particles, this pump consists of a helical shaped rotor, about ten times as long as its width. This can be visualized as a central core of diameter  $x$ , with typically a curved spiral wound around of thickness half  $x$ , although of course in reality it is made from one casting. This shaft fits inside a heavy duty rubber sleeve, of wall thickness typically  $x$  also. As the shaft rotates, fluid is gradually forced up the rubber sleeve. Such pumps can develop very high pressure at quite low volumes.

## Diaphragm Pumps

A diaphragm pump is a positive displacement pump that uses a combination of the reciprocating action of a rubber, thermoplastic or Teflon diaphragm and suitable non-return check valves to pump a fluid. Sometimes this type of pump is also called a membrane pump. Diaphragm Pumps are used extensively in many industries and can handle a very wide variety of liquids.

Diaphragm Pumps are in the category of "positive displacement" pumps because their flowrates do not vary much with the discharge "head" (or pressure) the pump is working against (for a given pump speed).

Diaphragm pumps can transfer liquids with low, medium or high viscosities and also liquids with a large solids content. They can also handle many aggressive chemicals such as acids because they can be constructed with a wide variety of body materials and diaphragms.

### There are three main types of diaphragm pumps:

- ✓ Those in which the diaphragm is sealed with one side in the fluid to be pumped, and the other in air or hydraulic fluid. The diaphragm is flexed, causing the volume of the pump chamber to increase and decrease. A pair of non-return check valves prevent reverse flow of the fluid.
- ✓ Those employing volumetric positive displacement where the prime mover of the diaphragm is electro-mechanical, working through a crank or geared motor drive. This method flexes the diaphragm through simple mechanical action, and one side of the diaphragm is open to air.
- ✓ Those employing one or more unsealed diaphragms with the fluid to be pumped on both sides. The diaphragm(s) again are flexed, causing the volume to change.



When the volume of a chamber of either type of pump is increased (the diaphragm moving up), the pressure decreases, and fluid is drawn into the chamber. When the chamber pressure later increases from decreased volume (the diaphragm moving down), the fluid previously drawn in is forced out. Finally, the diaphragm moving up once again draws fluid into the chamber, completing the cycle. This action is similar to that of the cylinder in an internal combustion engine. The most popular type of diaphragm pump is the Air-Operated Diaphragm Pump.

These pumps use compressed air as their power supply. They also include two chambers with a diaphragm, inlet check valve and outlet check valve in each chamber.

The air supply is shifted from one chamber to another with an air spool valve that is built into the pump. This continual shifting of air from one chamber to another (to the backside of the diaphragm) forces liquid out of one chamber and into the discharge piping while the other chamber is being filled with liquid.

There is some pulsation of discharge flow in Air-Operated Diaphragm Pumps. This pulsating flow can be reduced somewhat by using pulsation dampeners in the discharge piping.

## **Characteristics Diaphragm Pumps**

- ✓ have good suction lift characteristics, some are low pressure pumps with low flow rates; others are capable of higher flow rates, dependent on the effective working diameter of the diaphragm and its stroke length. They can handle sludges and slurries with a relatively high amount of grit and solid content.
- ✓ suitable for discharge pressure up to 1,200 bar.
- ✓ have good dry running characteristics.
- ✓ can be used to make artificial hearts.
- ✓ are used to make air pumps for the filters on small fish tanks.
- ✓ can be up to 97% efficient.
- ✓ have good self-priming capabilities.
- ✓ can handle highly viscous liquids.
- ✓ are available for industrial, chemical and hygienic applications.
- ✓ cause a pulsating flow that may cause water hammer.



## Vapor Pressure and Cavitation Sub-Section

Cavitation is the formation and then immediate implosion of cavities in a liquid – i.e. small liquid-free zones ("bubbles") – that are the consequence of forces acting upon the liquid. It usually occurs when a liquid is subjected to rapid changes of pressure that cause the formation of cavities where the pressure is relatively low.

Cavitation is a significant cause of wear in some engineering contexts. When entering high pressure areas, cavitation bubbles that implode on a metal surface cause cyclic stress. These results in surface fatigue of the metal causing a type of wear also called "cavitation". The most common examples of this kind of wear are pump impellers and bends when a sudden change in the direction of liquid occurs. Cavitation is usually divided into two classes of behavior: inertial (or transient) cavitation and non-inertial cavitation.

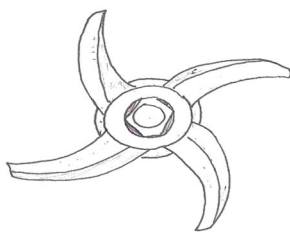

**OPEN**

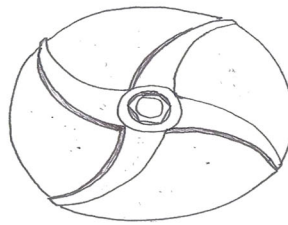

**SEMI-OPEN**

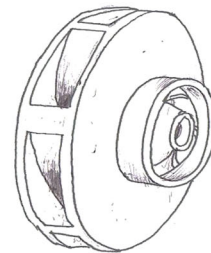

**CLOSED**

### COMMONLY FOUND IMPELLER TYPES

#### **Inertial Cavitation**

Inertial cavitation is the process where a void or bubble in a liquid rapidly collapses, producing a shock wave. Inertial cavitation occurs in nature in the strikes of mantis shrimps and pistol shrimps, as well as in the vascular tissues of plants. In man-made objects, it can occur in control valves, pumps, propellers and impellers.

#### **Non-Inertial Cavitation**

Non-inertial cavitation is the process in which a bubble in a fluid is forced to oscillate in size or shape due to some form of energy input, such as an acoustic field. Such cavitation is often employed in ultrasonic cleaning baths and can also be observed in pumps, propellers, etc. Since the shock waves formed by cavitation are strong enough to significantly damage moving parts, cavitation is usually an undesirable phenomenon. It is specifically avoided in the design of machines such as turbines or propellers, and eliminating cavitation is a major field in the study of fluid dynamics.

To understand Cavitation, you must first understand vapor pressure. Vapor pressure is the pressure required to boil a liquid at a given temperature. Soda water is a good example of a high vapor pressure liquid. Even at room temperature the carbon dioxide entrained in the soda is released. In a closed container, the soda is pressurized, keeping the vapor entrained.

### **Temperature Affects Vapor Pressure**

Temperature affects vapor pressure as well, raises the water's temperature to 212°F and the vapors are released because at that increased temperature the vapor pressure is greater than the atmospheric pressure.

Pump cavitation occurs when the pressure in the pump inlet drops below the vapor pressure of the liquid. Vapor bubbles form at the inlet of the pump and are moved to the discharge of the pump where they collapse, often taking small pieces of the pump with them. Cavitation is often characterized by:

- ✓ Loud noise often described as a grinding or "marbles" in the pump.
- ✓ Loss of capacity (bubbles are now taking up space where liquid should be).
- ✓ Pitting damage to parts as material is removed by the collapsing bubbles.

Noise is a nuisance and lower flows will slow your process, but pitting damage will ultimately decrease the life of the pump.

### **In general, cavitation performance is related to some "critical" value:**

$NPSHA (=available) > NPSHc$  or  $NPSHR (=critical \text{ or } required)$

Typical "critical" characteristics identified for centrifugal pumps:

- Incipient cavitation ( $NPSHi$ )
- Developed cavitation causing 3% head drop ( $NPSH3\%$ )
- Developed cavitation causing complete head breakdown (vapor lock).

### **Choice of $NPSHR$ is rather arbitrary, but usually $NPSHR=NPSH3\%$**

#### **Alternative choices:**

- $NPSHR=NPSH1\%$  or  $NPSHR=NPSH5\%$
- $NPSHR=NPSHi$  (cavitation free operation)

#### **Cavitation causes or may cause:**

- Performance loss (head drop)
- Material damage (cavitation erosion)
- Vibrations
- Noise
- Vapor lock (if suction pressure drops below break-off value)

**The definition of  $NPSHA$  is simple: Static head + surface pressure head - the vapor pressure of your product - the friction losses in the piping, valves and fittings.**

#### **But to really understand it, you first have to understand a couple of other concepts:**

- ✓ Cavitation is what net positive suction head ( $NPSH$ ) is all about, so you need to know a little about cavitation.
- ✓ Vapor Pressure is another term we will be using. The product's vapor pressure varies with the fluid's temperature.
- ✓ Specific gravity plays an important part in all calculations involving liquid. You have to be familiar with the term.
- ✓ You have to be able to read a pump curve to learn the N.P.S.H. required for your pump.
- ✓ You need to understand how the liquid's velocity affects its pressure or head.
- ✓ It is important to understand why we use the term Head instead of Pressure when we make our calculations.
- ✓ Head loss is an awkward term, but you will need to understand it.



**You will have to be able to calculate the head loss through piping, valves and fittings.**

- ✓ You must know the difference between gage pressure and absolute pressure.
- ✓ Vacuum is often a part of the calculations, so you are going to have to be familiar with the terms we use to describe vacuum.

**Let's look at each of these concepts in a little more detail**

- ✓ Cavitation means cavities or holes in liquid. Another name for a hole in a liquid is a bubble, so cavitation is all about bubbles forming and collapsing.
- ✓ Bubbles take up space so the capacity of our pump drops.
- ✓ Collapsing bubbles can damage the impeller and volute. This makes cavitation a problem for both the pump and the mechanical seal.
- ✓ Vapor pressure is about liquids boiling. If I asked you, "at what temperature does water boil?" You could say 212° F. or 100° C., but that is only true at atmospheric pressure. Every product will boil (make bubbles) at some combination of pressure and temperature. If you know the temperature of your product you need to know its vapor pressure to prevent boiling and the formation of bubbles. In the charts section of this web site you will find a vapor pressure chart for several common liquids.
- ✓ Specific gravity is about the weight of the fluid. Using 4°C (39° F) as our temperature standard we assign fresh water a value of one. If the fluid floats on this fresh water it has a specific gravity is less than one. If the fluid sinks in this water the specific gravity of the fluid is greater than one.
- ✓ Look at any pump curve and make sure you can locate the values for head, capacity, best efficiency point (B.E.P.), efficiency, net positive suction head (NPSH), and horse power required. If you cannot do this, have someone show you where they are located.
- ✓ Liquid velocity is another important concept. As a liquid's velocity increases, its pressure (90° to the flow) decreases. If the velocity decreases the pressure increases. The rule is: velocity times pressure must remain a constant.
- ✓ "Head" is the term we use instead of pressure. The pump will pump any liquid to a given height or head depending upon the diameter and speed of the impeller. The amount of pressure you get depends upon the weight (specific gravity) of the liquid. The pump manufacturer does not know what liquid the pump will be pumping so he gives you only the head that the pump will generate. You have to figure out the pressure using a formula described later on in this paper.
- ✓ Head (feet) is a convenient term because when combined with capacity (gallons or pounds per minute) you come up with the conversion for horsepower (foot pounds per minute).
- ✓ "Head loss through the piping, valves and fittings" is another term we will be using. Pressure drop is a more comfortable term for most people, but the term "pressure" is not used in most pump calculations so you could substitute the term "head drop" or "loss of head" in the system. To calculate this loss, you will need to be able to read charts like those you will find in the "charts you can use" section in the home page of this web site. They are labeled Friction loss for water and Resistance coefficients for valves and fittings.
- ✓ Gage and absolute pressure. Add atmospheric pressure to the gage pressure and you get absolute pressure.
- ✓ Vacuum is a pressure less than atmospheric. At sea level atmospheric pressure is 14.7 psi. (760 mm of Mercury). Vacuum gages are normally calibrated in inches or millimeters of mercury.

**To calculate the net positive suction head (NPSH) of your pump and determine if you are going to have a cavitation problem, you will need access to several additional pieces of information:**

- ✓ The curve for your pump. This pump curve is supplied by the pump manufacturer. Someone in your plant should have a copy. The curve is going to show you the Net Positive Suction Head (NPSH) required for your pump at a given capacity. Each pump is different so make sure you have the correct pump curve and use the numbers for the impeller diameter on your pump. Keep in mind that this NPSH required was for cold, fresh water.
- ✓ A chart or some type of publication that will give you the vapor pressure of the fluid you are pumping.
- ✓ If you would like to be a little more exact, you can use a chart to show the possible reduction in NPSH required if you are pumping hot water or light hydrocarbons.
- ✓ You need to know the specific gravity of your fluid. Keep in mind that the number is temperature sensitive. You can get this number from a published chart, ask some knowledgeable person at your plant, or take a reading on the fluid using a hydrometer.
- ✓ Charts showing the head loss through the size of piping you are using between the source and the suction eye of your pump. You will also need charts to calculate the loss in any fittings, valves, or other hardware that might have been installed in the suction piping.
- ✓ Is the tank you are pumping from at atmospheric pressure or is it pressurized in some manner? Maybe it is under a vacuum?
- ✓ You need to know the atmospheric pressure at the time you are making your calculation. We all know atmospheric pressure changes throughout the day, but you have to start somewhere.

**The formulas for converting pressure to head and head back to pressure in the imperial system are as follows:**

- o sg. = specific gravity
- o pressure = pounds per square inch
- o head = feet

You also need to know the formulas that show you how to convert vacuum readings to feet of head. Here are a few of them:

**To convert surface pressure to feet of liquid; use one of the following formulas:**

- ✓ Inches of mercury x 1.133 / specific gravity = feet of liquid
- ✓ Pounds per square inch x 2.31 / specific gravity = feet of liquid
- ✓ Millimeters of mercury / (22.4 x specific gravity) = feet of liquid

**There are different ways to think about net positive suction head (NPSH) but they all have two terms in common.**

- ✓ NPSHA (net positive suction head available)
- ✓ NPSHR (net positive suction head required)

## Submersible Pump Sub-Section

Submersible pumps are in essence very similar to turbine pumps. They both use impellers rotated by a shaft within the bowls to pump water. However, the pump portion is directly connected to the motor.

The pump shaft has a keyway in which the splined motor end shaft inserts. The water-tight motor is bolted to the pump housing. The pump's intake is located between the motor and the pump and is normally screened to prevent sediment from entering the pump and damaging the impellers.

The efficient cooling of submersible motors is very important, so these types of pumps are often installed such that flow through the well screen can occur upwards past the motor and into the intake. If the motor end is inserted below the screened interval or below all productive portions of the aquifer, it will not be cooled, resulting in premature motor failure.

Some pumps may have *pump shrouds* installed on them to force all the water to move past the motor to prevent overheating.

The shroud is a piece of pipe that attaches to the pump housing with an open end below the motor. As with turbine pumps, the size of the bowls and impellers, number of stages, and horsepower of the motor are adjusted to achieve the desired production rate within the limitations of the pumping head.



Insertion of motor spline into the pump keyway.

Cut away of a small submersible (turbine) pump without a motor.

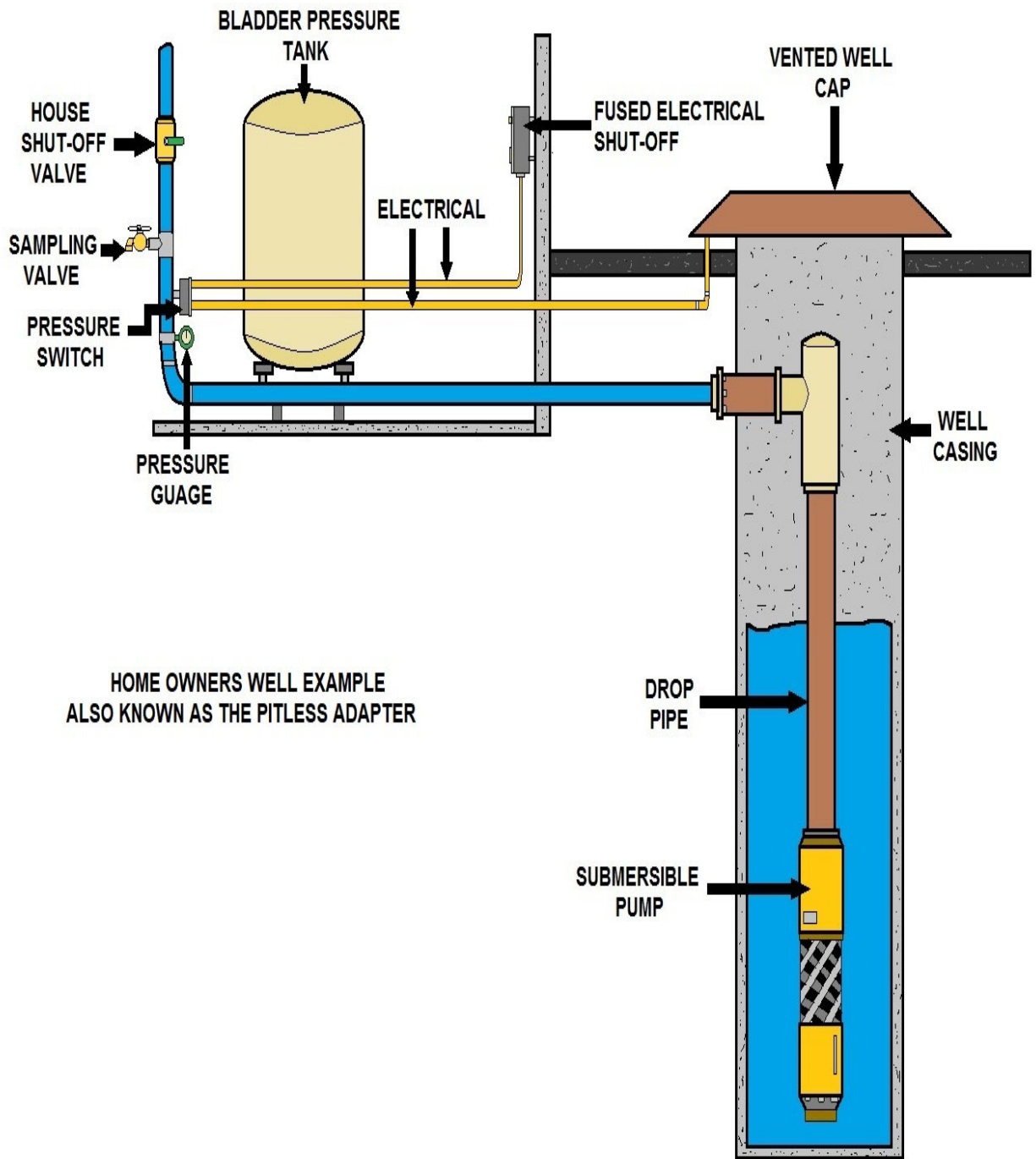

## Pulling a Small Submersible Well Pump



Well cap removed, looking at pvc pipe and electrical wire



Attachment that screws into well pipe to be pulled. Metal disk supports couplings on wellhead while being pulled.



Each pipe section is 20 feet long. Here the attachment that screws into the pipe is being disconnected from the well rig.



While pulling the PVC, care is taken not to damage electrical wiring. Next to the casing is conduit that runs from the electrical panel to the well.



The wire gauge used is determined by volts, amps and the run. Care is taken not to tangle the wire while pulling the well and re-installing.



Small well assemblies will use industrial tape to secure the wiring to the pump shaft and the centering device keeps the pump assembly centered in the casing.



The submersible pump is about to be pulled out. Above, is the discharge side of the pump.



This pump has 16 stages and a 4 inch impeller. Rule of thumb, if you take the diameter of the impeller squared ( 4 x 4 ) and times it by the stages you will get the lift in feet. For example  $4 \times 4 \times 16 = 256$  ft of lift.





The PVC pipe is threaded into the pump assembly. The PVC is special pre-threaded pipe.



Looking at the discharge side of the pump where the pipe is screwed in and you can see the foot valve on the inside.



Pump and motor connection.



It is recommended to install a check valve every 100 feet of piping. Sometimes the valve becomes defective and causes pumping issues. When installing the the check valve, the correct direction of the check valve is important.



Installing new submersible pump, securing wire and connecting pump wiring.



Checking to make sure new pump is working properly.



The discharge side of the pipe has a tee that seats on a saddle down below ground to prevent freezing.

## Submersible Pump Troubleshooting

A submersible pump (or electric submersible pump (ESP)) is a device which has a hermetically sealed motor close-coupled to the pump body. The whole assembly is submerged in the fluid to be pumped. The main advantage of this type of pump is that it prevents pump cavitation, a problem associated with a high elevation difference between pump and the fluid surface. Submersible pumps push fluid to the surface as opposed to jet pumps having to pull fluids. Submersibles are more efficient than jet pumps.

The submersible pumps used in ESP installations are multistage centrifugal pumps operating in a vertical position. Although their constructional and operational features underwent a continuous evolution over the years, their basic operational principle remained the same. Produced liquids, after being subjected to great centrifugal forces caused by the high rotational speed of the impeller, lose their kinetic energy in the diffuser where a conversion of kinetic to pressure energy takes place. This is the main operational mechanism of radial and mixed flow pumps.

The pump shaft is connected to the gas separator or the protector by a mechanical coupling at the bottom of the pump. Well fluids enter the pump through an intake screen and are lifted by the pump stages. Other parts include the radial bearings (bushings) distributed along the length of the shaft providing radial support to the pump shaft turning at high rotational speeds. An optional thrust bearing takes up part of the axial forces arising in the pump but most of those forces are absorbed by the protector's thrust bearing.

### Understanding the Operation of a Vertical Turbine Pump

The basic components of the pump are the driver, discharge head assembly, column assembly (when used) and bowl assembly. The driver, coupling strainer (when used) are generally shipped unassembled to prevent damage.

### Installation Check List

The following checks should be made before starting actual installation to assure proper installation and prevent delays:

1. With motor driven units, be sure the voltage and frequency on the motor nameplate agree with the service available. Also make sure the horsepower and voltage rating of the control box or starter agrees with the horsepower and voltage rating of the motor
2. Check the depth of the sump or caisson against the pump length to be sure there will be no interference.
3. Check the proposed liquid level in the sump against the pump length - the bottom stage of the pump must be submerged at all times.
4. Clean the sump and piping system before installing the pump.
5. Check the installation equipment to be sure it will safely handle the equipment.
6. Check all pump connections (bolts, nuts, etc.) for tightness. These have been properly tightened before leaving the factory, however, some connections may have worked loose in transit.
7. Check the coupling on the driver to make sure the shaft will fit properly.
8. Proper installation is necessary to provide maximum service from the pump. To insure proper alignment three items are very important during installation.
  - A. All machined mating surfaces (such as the mating flanges of the pump and motor) must be clean and free of burrs and nicks. These surfaces should be cleaned thoroughly with a scraper, wire brush and emery cloth if necessary and any nicks or burrs removed with a fine file.

B. Exterior strain must not be transmitted to the pump. The most common cause of trouble in this respect is forcing the piping to mate with the pump. It is recommended that flexible connectors be installed in the piping adjacent to the pump.

C. All threads should be checked for damage and repaired if necessary. If filing is necessary, remove the part from the pump if possible, or arrange a rag to catch all the filings so they do not fall into other parts of the pump. Clean all threads with a wire brush and cleaning solvent. Ends of the shafts must be cleaned and any burrs removed since alignment depends on the shaft ends butting squarely. Lubricate all screwed connections with a suitable thread lubricant (an anti-galling compound such as "Anti-Seize" should be used on stainless mating threads). The end faces of the pump shafts must be centered in the coupling and aligned with the relief hole drilled into the side of the coupling. To verify that the end of the shaft is centered in the coupling and aligned with the relief hole, insert a small wire (a paper clip works well) into the hole to feel where the shaft ends. Remove the wire before tightening the coupling and shafts. Excess thread lubricant will purge out of the relief hole when properly aligned.

## **Foundation**

The foundation may consist of any materials that will afford permanent, rigid support to the discharge head and will absorb expected stresses that may be encountered in service. Verify the foundation is flat and level.

## **Installation Process**

### **Equipment and Tools**

No installation should be attempted without equipment adequate for the job. The following list covers the principal items required for an installation.

1. Mobile crane capable of hoisting and lowering the entire weight of the pump and motor.
2. (2) Two steel clamps or elevators with bails or cable.
3. (2) Two sets of chain tongs.
4. Cable sling for attaching to the pump and motor lifting eyes.
5. Steel pipe clamp for lifting bowl assembly and column pipe.
6. Approximately 15 feet of 3/4" rope for tying shaft during installation.
7. Ordinary hand tools - pipe wrenches, end wrenches, socket set, screw drivers, Allen wrenches, etc.
8. Wire brush, scraper, fine file, and fine emery cloth.
9. Thread compound designed for type of connection and light machinery oil.

## **Assembling and Installing Pump**

**1. Position adequate lifting equipment so it will center over the foundation opening.**

### **2. Bowl Assembly**

A. Check and measure for axial clearance or end play. While bowls are in a horizontal position you should be able to push or pull the pump shaft indicating axial clearance. Check all bolts for tightness. Do not lift or handle the bowl assembly by the pump shaft.

B. Carefully lift the bowl assembly and suction with a bail or clamp.

When installing a very long 6" or 8" bowl assembly, leave the bowl securely fastened to the wooden skid that is attached for shipping until the bowl assembly is raised to a vertical position. This will help prevent breaking the bowls or bending the shaft.

C. If a strainer is to be used, attach to the bowl assembly using the fasteners provided. If a threaded strainer is to be used, attach to the bowl assembly by threading them together.

D. Lower the bowl assembly into the well or sump. Set the clamp or holding device that is attached to the bowls on a flat surface. This is to stabilize the bowl assembly and reduce possibility of cross threading shaft.

### **3. Column Assembly**

A. Plan the assembly by process before proceeding to assure proper placement of pump components. Match each lineshaft, line shaft sleeve, bearing/retainer assembly and bolting set to the appropriate column pipe.

B. Slide the shaft into the column pipe being careful not to damage any threads or to get dirt into the column pipe.

C. Thread shaft coupling onto bottom end of shaft (left hand threads). Shaft coupling must be centered so the air relief hole is located at the end of the shaft. The end faces of the pump shafts must be centered in the coupling and aligned with the relief hole drilled into the side of the coupling. To verify that the end of the shaft is centered in the coupling and aligned with the relief hole, insert a small wire (a paper clip works well) into the hole to feel where the shaft ends. Remove the wire before tightening the coupling and shafts. Excess thread lubricant will purge out of the relief hole when properly aligned.

D. Attach hoist to the first section of column pipe. Using rope, tie the shaft and column pipe together so that the shaft does not slip out of the column pipe. Raise the column and shaft to a vertical position over the bowl assembly.

Do not allow the shaft to drag or bump while it is being raised. When handling the shaft horizontally, always support in at least three places - never two.

E. Make sure the shafting faces, threads and couplings are clean. Holding lineshaft with pipe wrench, lower lineshaft. Align lineshaft with pump shaft to prevent cross threading and thread shaft into coupling (left hand threads). All shaft faces must butt inside coupling or damage will result on start-up.

F. Lower the column pipe to engage with the fit circle or threads (right hand threads) on bowl assembly. If flanged, tighten the column pipe bolts attaching the upper part of the bowl assembly to column pipe. If threaded with pipe thongs, thread the column pipe onto the bowl so the end of the pipe butts to the bowl.

G. Lift to allow removal of clamp holding bowl assembly in place. Carefully lower this section into well or sump so that it rests on upper clamp.

H. Slide the bearing retainer with bushing over the shaft and insert into column coupling. Make certain the bearing retainer ring is butted against the top end of the column pipe.

I. If threaded construction, thread the top column flange to the top column. No bearing retainer, bearing or sleeve is included on this connection.

J. Bolt the top column flange with an O-ring or gasket to the bottom of the discharge head.

K. Repeat this procedure for each column section. Add lineshaft bearings and retainer at each pipe joint. If the pump is equipped with shaft sleeves, orient the shaft sleeve with the drive hub and set screws on top. Slide the sleeve down the pump shaft until the shaft sleeve is centered along the length of the bearing. Remove the set screws and apply thread locking compound such as Loctite. Tighten the set screws securely against the shaft.

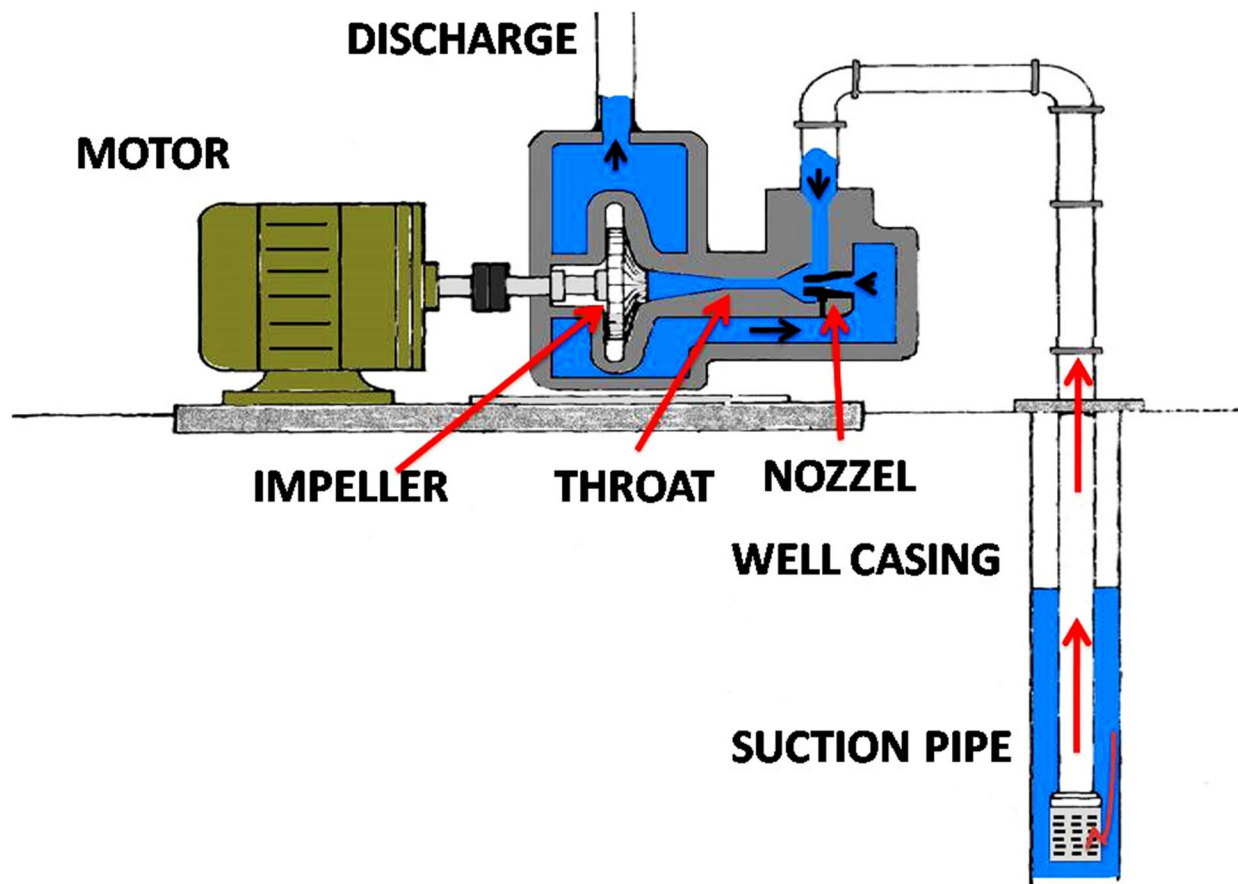

**SUBMERSIBLE PUMP WITH BOOSTER DIAGRAM #2**



# Vertical Turbine Pump Sub-Section

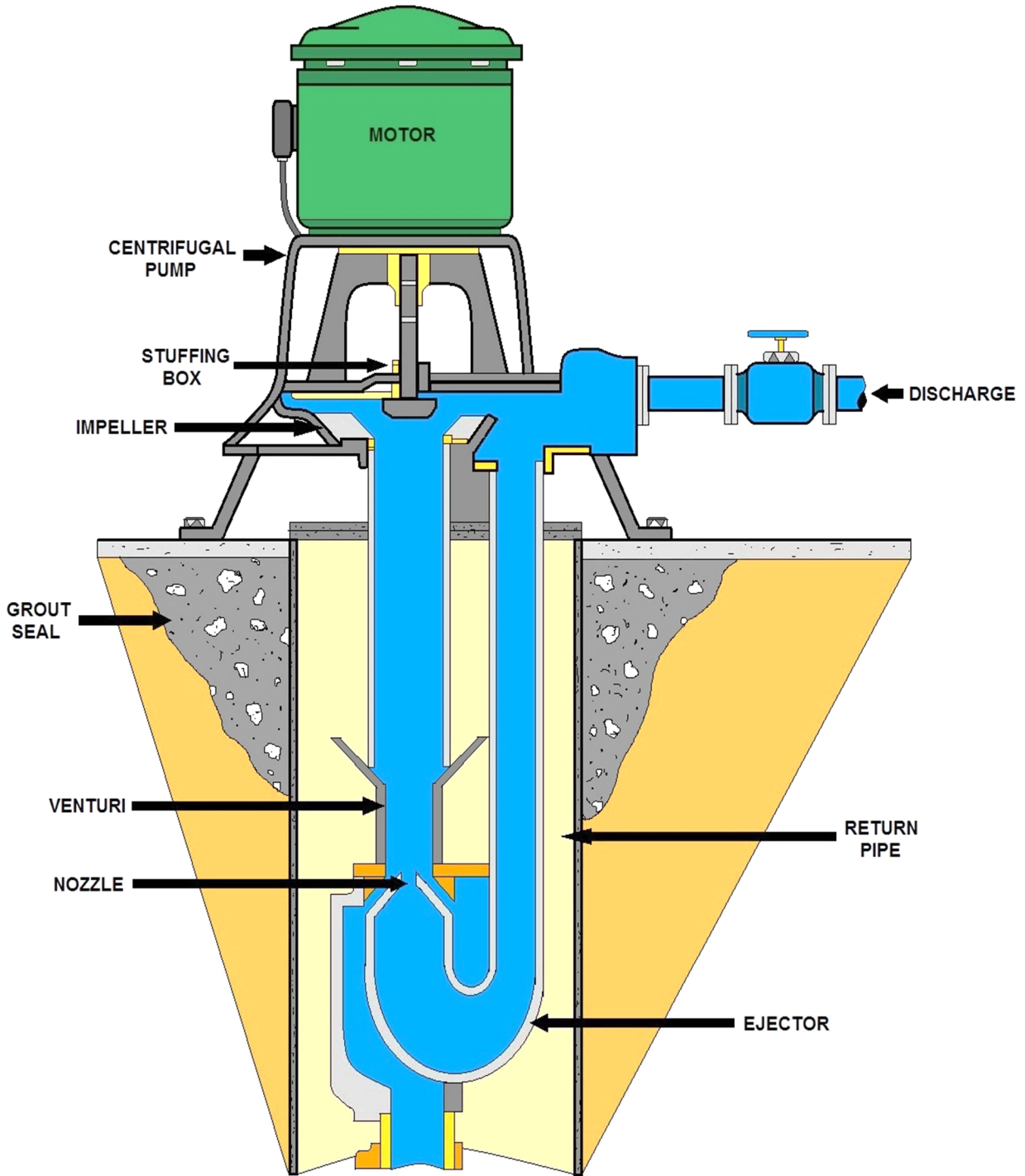

**VERTICAL TURBINE INSTALLATION DIAGRAM  
AKA JET PUMP**

Vertical turbine pumps are available in deep well, shallow well, or canned configurations. VHS or VSS motors will be provided to fulfill environmental requirements. Submersible motors are also available. These pumps are also suitable industrial, municipal, commercial and agricultural applications.

Deep well turbine pumps are adapted for use in cased wells or where the water surface is below the practical limits of a centrifugal pump. Turbine pumps are also used with surface water systems. Since the intake for the turbine pump is continuously under water, priming is not a concern. Turbine pump efficiencies are comparable to or greater than most centrifugal pumps. They are usually more expensive than centrifugal pumps and more difficult to inspect and repair.

The turbine pump has three main parts: (1) the head assembly, (2) the shaft and column assembly and (3) the pump bowl assembly. The head is normally cast iron and designed to be installed on a foundation. It supports the column, shaft, and bowl assemblies, and provides a discharge for the water. It also will support either an electric motor, a right angle gear drive or a belt drive.

### **Bowl Assembly**

The bowl assembly is the heart of the vertical turbine pump. The impeller and diffuser type casing is designed to deliver the head and capacity that the system requires in the most efficient way. Vertical turbine pumps can be multi-staged, allowing maximum flexibility both in the initial pump selection and in the event that future system modifications require a change in the pump rating. The submerged impellers allow the pump to be started without priming.

The discharge head changes the direction of flow from vertical to horizontal, and couples the pump to the system piping, in addition to supporting and aligning the driver.

### **Drivers**

A variety of drivers may be used; however, electric motors are most common. For the purposes of this manual, all types of drivers can be grouped into two categories:

1. Hollow shaft drivers where the pump shaft extends through a tube in the center of the rotor and is connected to the driver by a clutch assembly at the top of the driver.
2. Solid shaft drivers where the rotor shaft is solid and projects below the driver mounting base. This type of driver requires an adjustable flanged coupling for connecting to the pump.

### **Discharge Head Assembly**

The discharge head supports the driver and bowl assembly as well as supplying a discharge connection (the "NUF" type discharge connection which will be located on one of the column pipe sections below the discharge head). A shaft sealing arrangement is located in the discharge head to seal the shaft where it leaves the liquid chamber. The shaft seal will usually be either a mechanical seal assembly or stuffing box.

### **Column Assembly**

The shaft and column assembly provides a connection between the head and pump bowls. The line shaft transfers the power from the motor to the impellers and the column carries the water to the surface. The line shaft on a turbine pump may be either water lubricated or oil lubricated. The oil-lubricated pump has an enclosed shaft into which oil drips, lubricating the bearings.

The water-lubricated pump has an open shaft. The bearings are lubricated by the pumped water. If there is a possibility of fine sand being pumped, select the oil lubricated pump because it will keep the sand out of the bearings. If the water is for domestic or livestock use, it must be free of oil and a water-lubricated pump must be used. Line shaft bearings are commonly placed on 10-foot centers for water-lubricated pumps operating at speeds under 2,200 RPM and at 5-foot centers for pumps operating at higher speeds. Oil-lubricated bearings are commonly placed on 5-foot centers.

A pump bowl encloses the impeller. Due to its limited diameter, each impeller develops a relatively low head. In most deep well turbine installations, several bowls are stacked in series one above the other. This is called staging. A four-stage bowl assembly contains four impellers; all attached to a common shaft and will operate at four times the discharge head of a single-stage pump.

Impellers used in turbine pumps may be either semi-open or enclosed. The vanes on semi-open impellers are open on the bottom and they rotate with a close tolerance to the bottom of the pump bowl. The tolerance is critical and must be adjusted when the pump is new. During the initial break-in period the line shaft couplings will tighten, therefore, after about 100 hours of operation, the impeller adjustments should be checked. After break-in, the tolerance must be checked and adjusted every three to five years or more often if pumping sand.

**Column assembly is of two basic types, either of which may be used:**

1. Open lineshaft construction utilizes the fluid being pumped to lubricate the lineshaft bearings.
2. Enclosed lineshaft construction has an enclosing tube around the lineshaft and utilizes oil, grease, or injected liquid (usually clean water) to lubricate the lineshaft bearings.

**Column assembly will consist of:**

- 1) column pipe, which connects the bowl assembly to the discharge head,
- 2) shaft, connecting the bowl shaft to the driver and,
- 3) may contain bearings, if required, for the particular unit. Column pipe may be either threaded or flanged.

**Note: Some units will not require column assembly, having the bowl assembly connected directly to the discharge head instead.**

**Bowl Assemblies- The bowl consists of:**

- 1) impellers rigidly mounted on the bowl shaft, which rotate and impart energy to the fluid,
- 2) bowls to contain the increased pressure and direct the fluid,
- 3) suction bell or case which directs the fluid into the first impeller, and
- 4) bearings located in the suction bell (or case) and in each bowl.

Both types of impellers may cause inefficient pump operation if they are not properly adjusted. Mechanical damage will result if the semi-open impellers are set too low and the vanes rub against the bottom of the bowls. The adjustment of enclosed impellers is not as critical; however, they must still be checked and adjusted. Impeller adjustments are made by tightening or loosening a nut on the top of the head assembly. Impeller adjustments are normally made by lowering the impellers to the bottom of the bowls and adjusting them upward.

The amount of upward adjustment is determined by how much the line shaft will stretch during pumping. The adjustment must be made based on the lowest possible pumping level in the well. The proper adjustment procedure is often provided by the pump manufacturer.

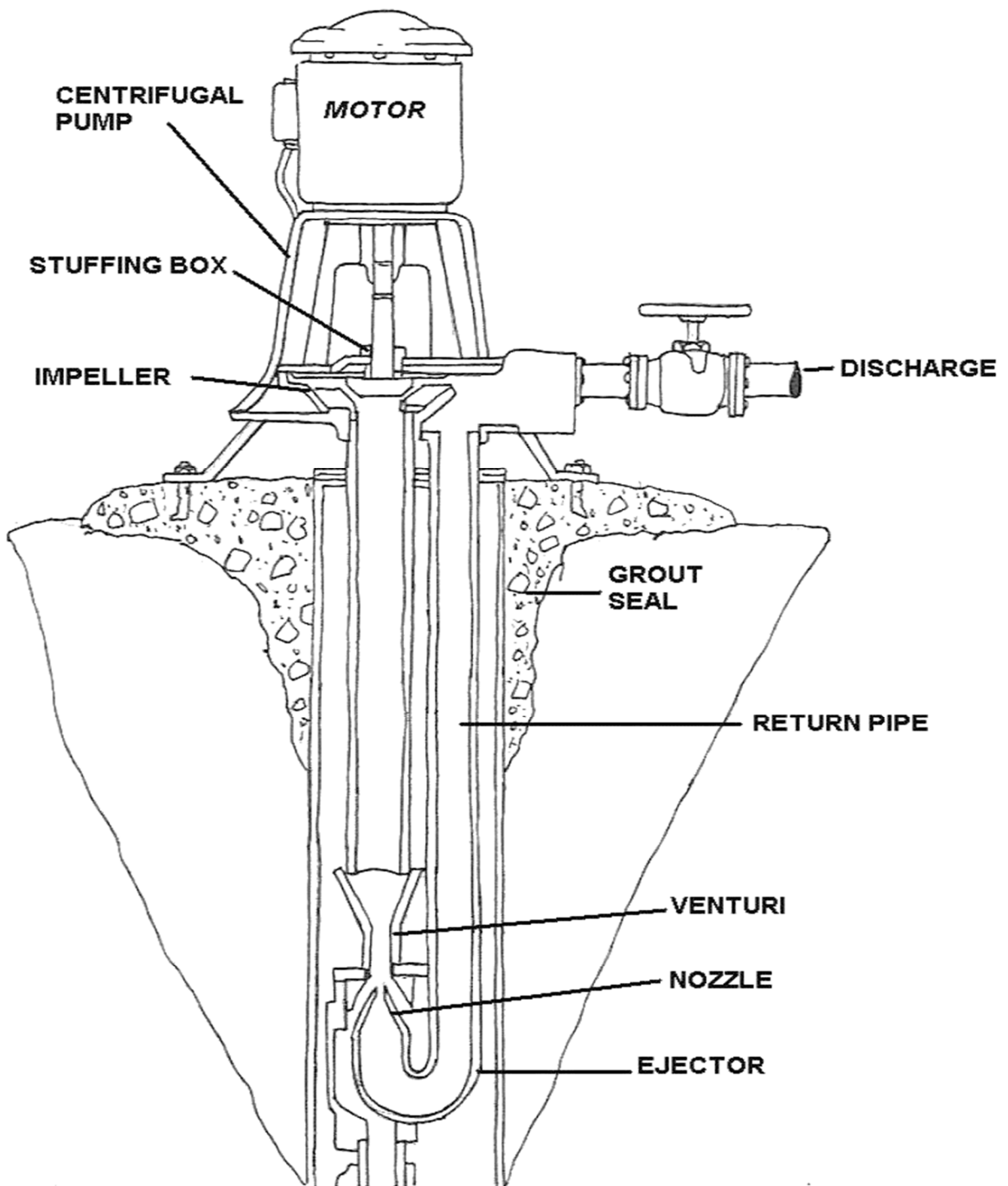

**VERTICAL TURBINE PUMP DIAGRAM #2**

## Basic Operation of a Vertical Turbine

### Pre-start

Before starting the pump, the following checks should be made:

1. Rotate the pump shaft by hand to make sure the pump is free and the impellers are correctly positioned.
2. Is the head shaft adjusting nut properly locked into position?
3. Has the driver been properly lubricated in accordance with the instructions furnished with the driver?
4. Has the driver been checked for proper rotation? If not, the pump must be disconnected from the driver before checking. The driver must rotate COUNTER CLOCKWISE when looking down at the top of the driver.
5. Check all connections to the driver and control equipment.
6. Check that all piping connections are tight.
7. Check all anchor bolts for tightness.
8. Check all bolting and tubing connections for tightness (driver mounting bolts, flanged coupling bolts, glad plate bolts, seal piping, etc.).
9. On pumps equipped with stuffing box, make sure the gland nuts are only finger tight — DO NOT TIGHTEN packing gland before starting.
10. On pumps equipped with mechanical seals, clean fluid should be put into the seal chamber. With pumps under suction pressure this can be accomplished by bleeding all air and vapor out of the seal chamber and allowing the fluid to enter. With pumps not under suction pressure, the seal chamber should be flushed liberally with clean fluid to provide initial lubrication. Make sure the mechanical seal is properly adjusted and locked into place.

**NOTE: After initial start-up, pre-lubrication of the mechanical seal will usually not be required, as enough liquid will remain in the seal chamber for subsequent start-up lubrication.**

11. On pumps equipped with enclosed lineshaft, lubricating liquid must be available and should be allowed to run into the enclosing tube in sufficient quantity to thoroughly lubricate all lineshaft bearings.

### Initial Start-Up

1. If the discharge line has a valve in it, it should be partially open for initial starting — Min. 10%.
2. Start lubrication liquid flow on enclosed lineshaft units.
3. Start the pump and observe the operation. If there is any difficulty, excess noise or vibration, stop the pump immediately.
4. Open the discharge valve as desired.
5. Check complete pump and driver for leaks, loose connections, or improper operation.
6. If possible, the pump should be left running for approximately ½ hour on the initial start-up. This will allow the bearings, packing or seals, and other parts to “run-in” and reduce the possibility of trouble on future starts.

**NOTE:** If abrasives or debris are present upon startup, the pump should be allowed to run until the pumpage is clean. Stopping the pump when handling large amounts of abrasives (as sometimes present on initial starting) may lock the pump and cause more damage than if the pump is allowed to continue operation.

**CAUTION:** Every effort should be made to keep abrasives out of lines, sumps, etc. so that abrasives will not enter the pump.

### **Stuffing Box Adjustment**

On the initial starting it is very important that the packing gland not be tightened too much. New packing must be “run in” properly to prevent damage to the shaft and shortening of the packing life. The stuffing box must be allowed to leak for proper operation. The proper amount of leakage can be determined by checking the temperature of the leakage; this should be cool or just lukewarm — NOT HOT. When adjusting the packing gland, bring both nuts down evenly and in small steps until the leakage is reduced as required. The nuts should only be tightened about ½ turn at a time at 20 to 30 minute intervals to allow the packing to “run in”. Under proper operation, a set of packing will last a long time. Occasionally a new ring of packing will need to be added to keep the box full. After adding two or three rings of packing, or when proper adjustment cannot be achieved, the stuffing box should be cleaned completely of all old packing and re-packed.

### **Lineshaft Lubrication**

Open lineshaft bearings are lubricated by the pumped fluid and on close coupled units (less than 30' long), will usually not require pre or post lubrication. Enclosed lineshaft bearings are lubricated by extraneous liquid (usually oil or clean water), which is fed to the tension nut by either a gravity flow system or pressure injection system. The gravity flow system utilizing oil is the most common arrangement. The oil reservoir must be kept filled with a good quality light turbine oil (about 150 SSU at operating temperature) and adjusted to feed 10 to 12 drops per minute plus one (1) drop per 100' of setting. Injection systems are designed for each installation — injection pressure and quantity of lubricating liquid will vary. Refer to packing slip or separate instruction sheet for requirements when unit is designed for injection lubrication.

### **General Maintenance Section**

A periodic inspection is recommended as the best means of preventing breakdown and keeping maintenance costs to a minimum. Maintenance personnel should look over the whole installation with a critical eye each time the pump is inspected — a change in noise level, amplitude or vibration, or performance can be an indication of impending trouble. Any deviation in performance or operation from what is expected can be traced to some specific cause.

Determination of the cause of any misperformance or improper operation is essential to the correction of the trouble — whether the correction is done by the user, the dealer or reported back to the factory. Variances from initial performance will indicate changing system conditions or wear or impending breakdown of unit. Deep well turbine pumps must have correct alignment between the pump and the power unit. Correct alignment is made easy by using a head assembly that matches the motor and column/pump assembly. It is very important that the well is straight and plumb. The pump column assembly must be vertically aligned so that no part touches the well casing.

Spacers are usually attached to the pump column to prevent the pump assembly from touching the well casing. If the pump column does touch the well casing, vibration will wear holes in the casing. A pump column out of vertical alignment may also cause excessive bearing wear.

The head assembly must be mounted on a good foundation at least 12 inches above the ground surface. A foundation of concrete provides a permanent and trouble-free installation. The foundation must be large enough to allow the head assembly to be securely fastened. The foundation should have at least 12 inches of bearing surface on all sides of the well. In the case of a gravel-packed well, the 12-inch clearance is measured from the outside edge of the gravel packing.

## Common Elements of Vertical Turbines

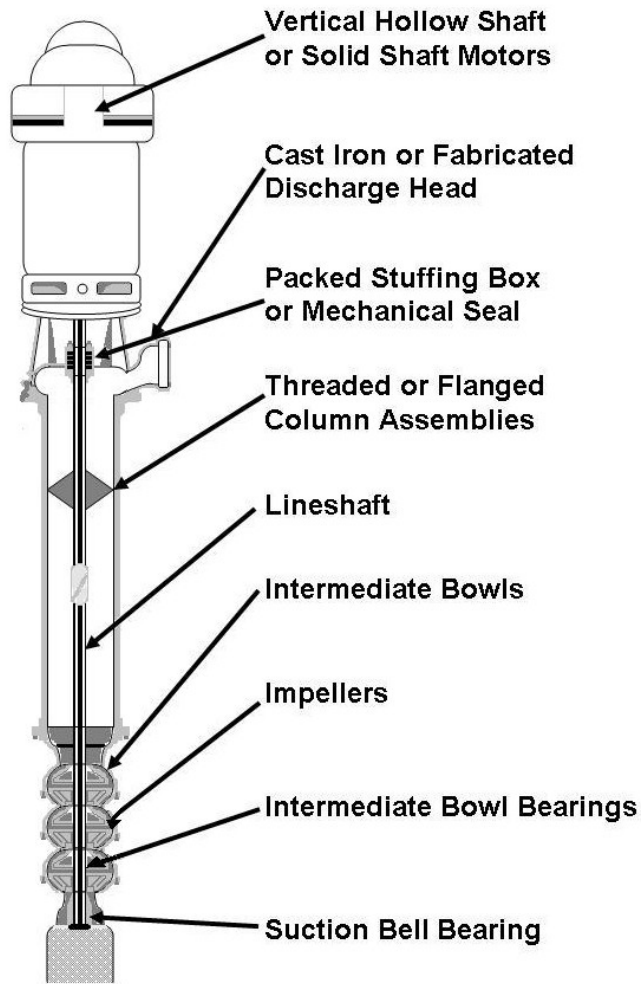

Above, Vertical Turbine Pump Being Removed (notice line shaft)



Closed Pump Impeller

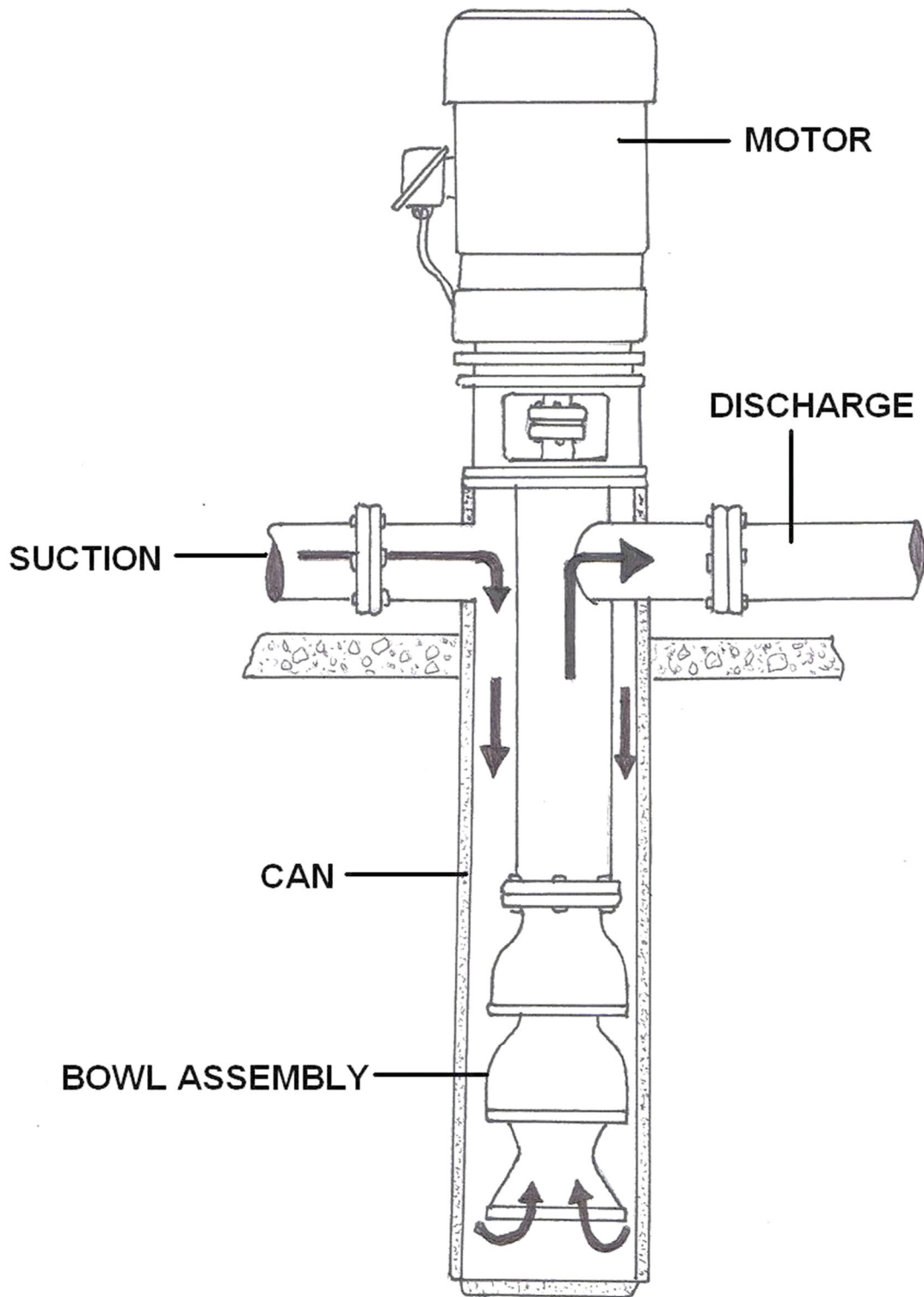

**VERTICAL TURBINE PUMP DIAGRAM #3**



# Maintenance of a Vertical Turbine Pump

## Periodic Inspection

A periodic inspection is recommended as the best means of preventing breakdown and keeping maintenance costs to a minimum. Maintenance personnel should look over the whole installation with a critical eye each time the pump is inspected -- a change in noise level, amplitude of vibration, or performance can be an indication of impending trouble. Any deviation in performance or operation from what is expected can be traced to some specific cause. Determination of the cause of any misperformance or improper operation is essential to the correction of the trouble - whether the correction is done by the user, the dealer or reported back to the factory. Variances from initial performance will indicate changing system conditions or wear impending breakdown of the unit.

## Monthly Inspection

A periodic monthly inspection is suggested for all units. During this inspection the pump and driver should be checked for performance, change in noise or vibration level, loose bolts or piping, dirt and corrosion. Clean and re-paint all areas that are rusted or corroded.

## Impeller Re-Adjustment

Ordinarily impellers will not require readjustment if properly set at initial installation. Almost no change in performance can be obtained by minor adjustment of enclosed impellers. All adjustments of the impellers will change the mechanical seal setting. It is recommended that the seal be loosened from the shaft until the adjustment is complete and then reset.

## Pump Lubrication

Other than the stuffing box lubrication, mechanical seal, and/or lineshaft lubrication, the pump will not require further periodic lubrication. On water pumps and sumps, the suction bearing on the bowl assembly should be repacked when repairs are made, however, no attempt should be made to repack until repairs to the bowl assembly are necessary. Pumps that pump hydrocarbons or have carbon or rubber bearings do not have the suction bearing packed.

## Driver Lubrication

Drivers will require periodic attention. Refer to the Driver Instruction Manual for recommendations.

## General Maintenance

Maintenance of the stuffing box will consist of greasing the box when required, tightening the packing gland occasionally as the leakage becomes excessive, and installing new packing rings or sets as required.

## Replacing Packing

Remove gland and all old packing. If the box contains a lantern ring remove this and all packing below it using two long threaded machine screws. Inspect shaft or sleeve for score marks or rough spots. Be sure by-pass holes (if supplied) are not plugged. Repair or replace badly worn shaft or sleeve. If wear is minor, dress down until smooth and concentric. Clean box bore. Oil inside and outside or replacement rings lightly and install in box, staggering joints 90 degrees.

Be sure to replace lantern ring in proper position when used. Replace gland and tighten nuts finger tight. The packing gland must never be tightened to the point where leakage from the packing is stopped. A small amount of leakage is required for packing lubrication.

### **Start-Up Procedures with New Packing**

Check to see that the by-pass line (if used) is connected and the packing gland is loose. Start pump and allow to run for 20 to 30 minutes. Do not tighten the gland during this “run-in” period even if leakage is excessive. If the leakage continues to be more than normal. Should the new packing cause excess heating during “run-in” flush the shaft and packing box area with cold water or shut the pump down and allow to cool if necessary.

### **Components of a Vertical Turbine Pump Drivers**

A variety of drivers may be used; however, electric motors are most common. For the purposes of this manual all types of drivers supplied will be hollow shaft. On a hollow shaft driver, the headshaft extends through a tube in the center of the rotor and is connected to the driver by a coupling assembly at the top of the driver.

### **Head Assembly**

The discharge head supports the driver, column and bowl assembly as well as supplying a discharge connection. A shaft sealing arrangement is located in the discharge head to seal the shaft where it leaves the liquid chamber. The shaft seal will usually be a mechanical seal assembly. However, some applications require rope packing.

### **Column Assembly**

Column assembly is of open lineshaft construction. It utilizes the fluid being pumped to lubricate the lineshaft bearings. The column assembly will consist of a column pipe, which connects the bowl assembly to the discharge head and carries the pumped fluid to the discharge head; shaft, connecting the pump shaft driver; and may contain bearings if required for the particular unit.

### **Bowl Assemblies**

The suction strainer, when supplied, is attached to the suction bell. It is used to prevent large objects from entering the pump. The bowl assembly consists of a discharge case, impellers, a shaft, intermediate bowls, suction bell, and bearings. The suction bell directs the flow of liquid into the first stage impeller. The impellers are rigidly mounted to the shaft with tapered collets or keys with lock rings. Bearings are located in the suction bell, intermediate bowls and discharge case to support the shaft. The discharge case connects the pump to the bottom of the column pipe.

### **Understanding Pump Bowl Assembly**

The suction strainer, when supplied, is attached to the suction bell. It is used to prevent large objects from entering the pump. The bowl assembly consists of a discharge case, impellers, a shaft, intermediate bowls, suction bell, and bearings. The suction bell directs the flow of liquid into the first stage impeller. The impellers are rigidly mounted to the shaft with tapered collets or keys with lock rings. Bearings are located in the suction bell, intermediate bowls and discharge case to support the shaft. The discharge case connects the pump to the bottom of the column pipe.

### **Understanding Pump Drivers**

A variety of drivers may be used; however, electric motors are most common. For the purposes of this manual all types of drivers supplied will be hollow shaft. On a hollow shaft driver, the headshaft extends through a tube in the center of the rotor and is connected to the driver by a coupling assembly at the top of the driver.

**The parts in the driver section can consist of the following:**

- Motor (Driver)
- Coupling
- Motor adapter
- Belts
- Gears

The driver section need not contain all of the items listed above. As a minimum, a driver (usually a motor) is required. The coupling, belts and gears are power transmission devices that may or may not be required with the pump.

A coupling is a power transmission device that is used to connect the motor (driver) shaft to the power end shaft of the pump. The primary purpose of a coupling is to transmit rotary motion and torque from the motor to the pump.

Couplings often are required to perform other secondary functions as well. These other functions include accommodating misalignment between shafts, transmitting axial thrust loads from one machine to another, permitting adjustment of shafts to compensate for wear and maintaining precise alignment between connected shafts.

Many times pumps use couplings installed with a spacer. A spacer coupling allows the pump to be disassembled without moving piping, the pump casing or motor.

**Understanding Discharge Head Assembly  
Head Assembly**

The discharge head supports the driver, column and bowl assembly as well as supplying a discharge connection. A shaft sealing arrangement is located in the discharge head to seal the shaft where it leaves the liquid chamber. The shaft seal will usually be a mechanical seal assembly. However, some applications require rope packing.

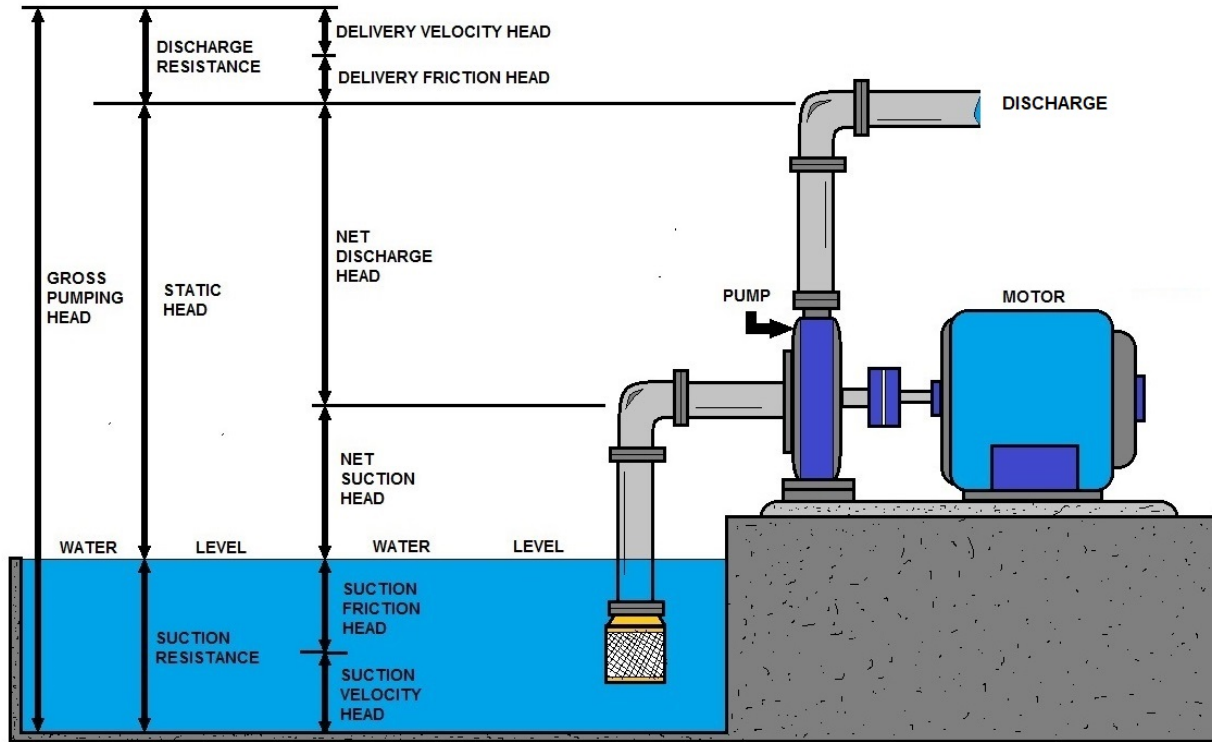

**FACTORS IN DETERMINING A TYPICAL PUMP INSTALLATION**

## General Pumping Review/Troubleshooting Section

The speed at which the magnetic field rotates is called the motor's synchronous speed. It is expressed in revolutions per minute. For a motor that operates on an electric power system having a frequency of 60Hz, the maximum synchronous speed is 3,600 rpm, or 60 revolutions per second. In other words, because the electric current changes its flow direction 60 times a second, the rotor can rotate 60 times per second. This speed is achieved by a two-pole motor.

Backsiphonage is a condition in which the pressure in the distribution system is less than atmospheric pressure. In other words, something is "sucked" into the system because the main is under a vacuum.

When a pump operates under suction, the impeller inlet is actually operating in a vacuum. Air will enter the water stream along the shaft if the packing does not provide an effective seal. It may be impossible to tighten the packing sufficiently to prevent air from entering without causing excessive heat and wear on the packing and shaft or shaft sleeve. To solve this problem, a Lantern Ring can be placed in the Stuffing Box.

If the pump must operate under high suction head, the suction pressure itself will compress the packing rings regardless of the operator's care. Packing will then require frequent replacement. Most manufactures recommend using mechanical seals for low-suction head conditions as well.

In general, any Centrifugal pump can be designed with a multistage configuration. Each stage requires an additional Impeller and casing chamber in order to develop increased pressure, which adds to the pressure developed by the preceding stage.

The axial-flow pump is often referred to as a Propeller Pump. In all centrifugal pumps, there must be a flow restriction between the Impeller discharge and Suction areas that will prevent excessive circulation of water between the two parts.

Altitude-Control Valve is designed to, 1. Prevent overflows from the storage tank or reservoir, or 2. Maintain a constant water level as long as water pressure in the distribution system is adequate. Float mechanisms, diaphragm elements, bubbler tubes, and direct electronic sensors are common types of level sensors.

The mechanical seal is designed so that it can be hydraulically balanced. The result is that the wearing force between the machined surfaces does not vary regardless of the suction head. Most seals have an operating life of 5,000 to 20,000 hours.

A chlorine demand test from a well water sample produces a result of 1.2 mg/L. The water supplier would like to maintain a free chlorine residual of 0.2 mg/L throughout the system. The chlorine dose should be 1.4 in mg/L from either a chlorinator or a hypochlorinator. The vacuum created by a chlorine ejector moves through this device. Check valve assembly prevents water from back feeding or entering the vacuum-regulator portion of the chlorinator.

A water storage facility should be able to provide water for the Fire and Peak demands. Surge tanks are used to control Water Hammer.

A couple of limitations of hydro-pneumatic tanks is; do not provide much storage to meet peak demands during power outages and you have a small or very limited time to do repairs on equipment.

Peak demand is defined as the maximum momentary load placed on a water treatment plant, pumping station or distribution system.

Concerning a single phase motor: If it is a split-phase motor, the motor will not have windings. A repulsion-induction motor is very simple and less expensive than other single phase motors. On most kilowatt meters, the current kilowatt load is indicated by Disk revolutions on the meter.

A foot valve is a check valve is located at the bottom end of the suction on a pump. This valve opens when the pump operates to allow water to enter the suction pipe but closes when the pump shuts off to prevent water from flowing out of the suction pipe.

Distribution system water quality can be adversely affected by improperly constructed or poorly located blowoffs of vacuum/air relief valves. Air relief valves in the distribution system lines must be placed in locations that cannot be flooded. This is to prevent water contamination. Milky water is a common customer complaint is sometimes solved by the installation of air relief valves.

A Centrifugal pump is consisting of an impeller fixed on a rotating shaft that is enclosed in a casing, and having an inlet and discharge connection? As the rotating impeller spins the liquid around, force builds up enough pressure to force the water through the discharge outlet. A pump engineer will normally design a system that would use multiple pumps for a parallel operation to provide for a fluctuating demand.

When the superintendent is inspecting the plans for a new ground water storage tank, the superintendent should pay attention to the inlet and outlet of this tank. The outlet and inlet should be on opposite sides of the tank.

Water quality in a storage facility could degrade due to excessive water age caused by low demands for water and short-circuiting within the distribution storage reservoir. The following are not other reasons for water quality degradation: Poor design, Inadequate maintenance and/or Improperly applied coating and linings.

Older transmitting equipment requires installation where temperature will not exceed 130 F. A diaphragm element being used as a level sensor would be used in conjunction with Pressure Sensor. Inspection of magnetic flow meter instrumentation should include checking for corrosion or insulation deterioration.

The most frequent problem that affects a liquid pressure-sensing device is air accumulation at the sensor. The following are common pressure sensing devices: Helical Sensor, Bourdon Tube and Bellows Sensor.

## Common Pump and Troubleshooting Questions

**1. Cavitation:** Cavitation is defined as the phenomenon of formation of vapor bubbles of a flowing liquid in a region where the pressure of the liquid falls below its vapor pressure. One of the most serious problems an operator will encounter is cavitation. It can be identified by a noise that sounds like marbles or rocks are being pumped. The pump may also vibrate and shake, to the point that piping is damaged, in some severe cases. Cavitation occurs when the pump starts discharging water at a rate faster than it can be drawn into the pump. This situation is normally caused by the loss of discharge head pressure or an obstruction in the suction line. When this happens, a partial vacuum is created in the impeller causing the flow to become very erratic. These vacuum-created cavities are formed on the backside of the impeller vanes. When cavitation occurs, immediate action must be taken to prevent the impeller, pump and motor bearings, and piping from being damaged. Cavitation can be temporarily corrected by throttling the discharge valve. This action prevents damage to the pump until the cause can be found and corrected. Remember that the discharge gate valve is there to isolate the pump, not control its flow. If it is left in a throttled position the valve face may become worn to the point that it won't seal when the pump must be isolated for maintenance. Butterfly valves can be throttled, but it is still not a good idea to throttle a pump with an isolation valve.

### **2. What purpose do air and/or vacuum release valves serve on well casings?**

**Air and/or vacuum release valves** are used to release trapped air or vacuums created in water pipelines. This unique structure allows the dynamic valves to discharge air from the water system in a controlled and gradual manner, preventing slam and local up-surges. When vacuum occurs, the valves fast reaction will draw in large volumes of air into the water system, impeding down-surges and, consequently, all pressure surges in the line. The valves are normally closed when the line is not operating, thus preventing the infiltration of foreign particles and insects into the water system.

### **3. What is a sanitary seal and what purpose does it serve on a wellhead?**

**Sanitary seal:** A device placed into the topmost part of a well casing which, by means of an expanding gasket, excludes foreign material from entering the well and may be provided with a means for introducing disinfecting agents directly into the well, or a device producing an equivalent effect. Such device shall be watertight to prevent the entrance of surface water and other contaminants into the well.

### **4. What are the functions of a well casing and well casing perforations?**

**Well Casing** is used to maintain an open access in the earth while not allowing any entrance or leakage into the well from the surrounding formations. The most popular materials used for casing are black steel, galvanized steel, PVC pipe and concrete pipe.

**5. Well Casing Perforations:** Is the process of creating holes in production casing to establish communication between the well and formation. Perforation holes are used to recover water from the ground.

**6. Which condition might cause a positive displacement diaphragm pump to cycle improperly?** Plugged exhaust port

**7. How can ball bearing failure in a pump shaft bearing generally be first detected?** Perform vibration monitoring to detect failures or wait for excessive noise or heat. There are three types of bearings commonly used: ball bearings, roller bearings, and sleeve bearings.

Regardless of the particular type of bearings used within a system--whether it is ball bearings, a sleeve bearing, or a roller bearing--the bearings are designed to carry the loads imposed on the shaft. Bearings must be lubricated. Without proper lubrication, bearings will overheat and seize. Proper lubrication means using the correct type and the correct amount of lubrication. Similar to motor bearings, shaft bearings can be lubricated either by oil or by grease.

**8. What is the purpose of the curved diffuser vanes on the inside of a pump volute?**

**Generation of Centrifugal Force:** The process liquid enters the suction nozzle and then into eye (center) of a revolving device known as an impeller. When the impeller rotates, it spins the liquid sitting in the cavities between the vanes outward and provides centrifugal acceleration. As liquid leaves the eye of the impeller a low-pressure area is created causing more liquid to flow toward the inlet. Because the impeller blades are curved, the fluid is pushed in a tangential and radial direction by the centrifugal force. This force acting inside the pump is the same one that keeps water inside a bucket that is rotating at the end of a string.

**9. What would be the advantage of starting and stopping a centrifugal pump against a closed discharge valve?** Keeping the prime in the pipe and not allowing air to fill the pump.

**10. What precautions should be taken when opening and closing the discharge valve?**

Turbulent flows caused by pump discharges, elbows and swedges upstream of a valve will also cause the discs to flutter excessively. Be careful not to create a water hammer.

**11. What effect could over-lubrication of grease-packed bearings have on a pump shaft?**

Excessive friction and heat!

**12. What are the three different designs of impellers in relation to shrouds that are used on centrifugal pumps?**

Semi-Closed also called Free passage (Vortex), Open and Closed.

**13. What is the proper procedure for starting a pump?**

Fill the pump with liquid, crack open the discharge valve and start the motor. But, as you would guess, it is a little more complicated than that.

We'll begin by making sure the pump is filled with liquid. There are several ways to do that:

- Install a foot valve in the suction piping to insure the liquid will not drain from the pump casing and suction piping. Keep in mind that these valves have a nasty habit of leaking.
- Or you could evacuate the air in the piping system with a positive displacement priming pump operating between the pump and a closed discharge valve. Be sure the priming pump stuffing box is sealed with a mechanical seal and not conventional packing because packing will let air into the priming pump suction side. A balanced, O-ring seal would be a good choice for the priming pump stuffing box.
- Convert the application to a self-priming pump that maintains a reservoir of liquid at its suction.
- Fill the pump with liquid from an outside source prior to starting it.



Here is the proper way to vent a centrifugal pump after it has been initially installed, or the system has been opened. Assuming the pump is empty of liquid and both the suction and discharge valves are shut.

- Open the suction valve. The pump fills part way.
- Close the suction valve.
- Open the discharge valve part way. Once the pressure equalizes the air will rise in the discharge piping.
- Open the suction valve.
- Start the pump.
- When the pump hits its operating speed open the discharge valve to its proper setting to operate close to the BEP. (Best efficiency point)

**14. What precautions should be taken before starting a water-lubricated pump?**

The pump casing and suction piping must be filled with water. Bearings and stuffing boxes should be watched closely to make sure they do not overheat or require adjusting.

**15. What factors would determine the size of well casing to use on a well?**

Pump type, pump size and pumping depth. Well casings are installed in wells to prevent the collapse of the walls of the borehole, to exclude pollutants (either surface or subsurface) from entering the water source, and to provide a column of stored water to the well pump.

**16. What is the main concern when using a coupling on a horizontal pump?**

Proper alignment of the pump to the driver.

**17. Why should accurate records be kept on pump operations?**

For a record of the past and a database for planning future pumping.

**18. What are the two most common speeds of a centrifugal pump?**

High speed (critical) and slower speed (variable).

**19. What is a close-coupled pump and what purpose do the motor bearings serve?**

Close-coupled pump has the motor and pump together without a shaft between the two. The motor bearings will also support the impeller.

**20. What should the operating pressure of seal water be in relation to the suction pressure of a pump?** An independent supply of water is needed for the seal water and its pressure should be higher than the pump's suction.

**21. What is the main purpose of a finished water storage reservoir?**

To provide sufficient amount of water to an average or equalize the daily demands on the public water supply system. Also meeting the needs for average and peak demands and adequate pressures throughout the system. Meeting the needs for fire protection, industrial requirements and reserve storage.

**22. What is the primary operation of drinking water storage tanks?**

Fill tanks at night or during periods of low demand. Operated to design engineer's and manufacturer's instructions. Normally storage tanks are designed to provide or supply water during periods of high demand. And to maintain minimum pressures at critical points in the distribution system.

**23. Standpipe:** A method of storing water and equalizing water pressure to minimize the pulsations of water flowing in the mains, used prior to modern pumping methods, consisting of a large vertical pipe in which a column of water rises and falls; often built inside towers.

**24. What is water hammer, how is it caused, and how can it be prevented?**

A large pressure surge that damages pipes and equipment. It is caused by rapid rising or falling of water pressures or opening and shutting of valves. A hydropneumatic tank and careful opening of valves can limit water hammer damage.

**25. Hydropneumatic tank:** A method of storing water prior to distribution in a water supply system, whereby the water system pressure is maintained between a specified pressure range and is also called pressure tanks.

**26. What is a hydro pneumatic tank and how does it operate?**

These tanks store water prior to distribution in a water supply system, working with the pumps to maintain a stable water system pressure. The system pressure is controlled by a pressure switch set for minimum and maximum pressures – giving you a cut-in and a cut-out pressure for the pumps. When the pumps cut-out or stop running, water demand is met by the water volume in the piping and the tank. As water is drawn down, the system pressure starts to drop. When it reaches the minimum system pressure, the pump cuts back in and runs until the system pressure reaches the normal maximum pressure.

## Pump Not Delivering Water

If your pump isn't delivering water, verify that the pump shaft is turning in the direction of the arrow on the pump casing. As viewed from the motor end, the rotation is usually clockwise, but check the startup instructions that came with the pump.

On three-phase motors, swap any two power leads to change rotation. It is recommended that a qualified electrician perform this task.

If the pump doesn't prime, check for air leaks on discharge valves. Many all-metal gate-type valves won't seal properly to create a vacuum. Sand or other debris lodged between the rubber flap and the valve seat will prevent check valves from sealing and forming a tight joint. See if the rubber face is cracked or chipped and not seating. Replace the gate valve or check valve. Check connections between pump and primer. On a hand primer, if grass or other debris is lodged in the check valve, air is pulled back into the pump at every stroke and the pump won't prime. After proper priming, fill the system slowly.

### Pump Maintenance Tasks

#### Twice a year:

- Thoroughly clean suction and discharge piping and connections, removing moss and debris.
- Tighten all drain and fill plugs in the pump volute case to avoid air and water leaks. Use a pipe thread compound on all pipe threads.
- Check for cracks or holes in the pump case.
- Clean trash screening device and screens on the suction pipe.

### Servicing Impeller and Wear Rings

If you suspect that your pump impeller is clogged or damaged, or that the wear rings are worn, you can dismantle the pump. This will take some work and is best done in the shop. Or have a qualified pump repair shop undertake this procedure.

Always follow the directions in the manufacturer's manual, if available, instead of the following simplified directions.

- Remove suction cover or volute case.
- Remove debris from impeller and volute. Remove pebbles lodged between vanes.
- Check wear at the impeller eye and vanes. If worn, repair or replace the impeller.
- Re-machine or replace wear ring if clearance is greater than 1/32 inch per side.
- Replace suction cover or volute. Use a new gasket.

### On the Suction Side of Pump:

- A well designed and screened sump that keeps trash away.
- Suction line joints that are airtight under a vacuum.
- No high spots where air can collect.
- A suction line water velocity of five feet per second (fps) or less; two to three fps is best.
- A suction entrance at least two pipe bell diameters from sump inlet.
- A suction lift (vertical distance from water surface to pump impeller) less than 15 to 20 feet.
- An eccentric reducer to keep air from becoming trapped in the reducer fitting.
- A vacuum gauge to indicate whether the primer is pulling a vacuum or just moving air through the pump.

### **On the Discharge Side of Pump:**

- A valve size that is the same diameter as the mainline.
- A non-slam check valve to prevent back spin when shutting off the pump.
- An air relief device when a buried mainline is used.
- A discharge line water velocity of less than seven fps. Five fps is best.
- An energy efficient 1800 rpm motor with a 15 percent safety factor.
- A simple shade over the motor.

### **Turbine Pump Installation**

The properly constructed well should also:

- Be at least six inches in diameter larger than the outside diameter of the well casing when a gravel pack is required.
- Have horizontal well screen slots that continue below the pumping water level. The openings should hold back at least 85 percent of the surrounding material.

### **Control Panel for Electric Motors**

The importance of a properly installed control panel cannot be overemphasized for personal safety and for protecting your investment in your pump and motor. Your control panel should:

- Have a shade over it to keep thermal breakers cool.
- Be mounted on secure poles or foundation.
- Have any missing knockout plugs and other holes in the starting switch box replaced and screened or puttied against rodents, insects, and dirt.
- Have a small hole (3/16-inch diameter) in the bottom of the panel to allow moisture to drain.

Your control panel should include the following controls at a minimum:

- Circuit breaker(s) for overload currents.
- Lightning arrester.
- Surge protector.
- Phase failure relay, to protect the motor from phase reversal or failure and from low voltage.
- A pressure switch to shut off the motor if pumping pressure drops to undesirable levels.

### **Casing**

Casing is the tubular structure that is placed in the drilled well to maintain the well opening. Along with grout, the casing also confines the ground water to its zone underground and prevents contaminants from mixing with the water. Some states or local governing agencies have laws that require minimum lengths for casing.

The most common materials for well casing are carbon steel, plastic (most commonly, but not exclusively, PVC), and stainless steel. Different geologic formations dictate what type of casing can be used. For example, parts of the country where hard rock lies underground are known strictly as “steel states.”

Residents in some areas have a choice between steel and PVC, both of which have advantages. PVC is lightweight, resistant to corrosion, and relatively easy for contractors to install. However, it is not as strong and not as resistant to heat as steel.

Steel, though, is susceptible to corrosion, can have scale build-up, and can cost more than PVC.

Some contractors also use concrete, fiberglass, and asbestos cement casing.

## **Caps**

On the top of the casing should be an approved well cap. It should fit snugly so debris, insects, or small animals can't find their way into the well system.

Well caps are usually aluminum or a thermoplastic, and include a vented screen so that the pressure difference between the inside and outside of the well casing may be equalized when water is pumped from the well.

The casing and cap should extend at least 6 to 8 inches above the ground. If the well is near a river or stream, it should extend at least past the flood level to prevent overflows from contaminating the ground water.

## **Well Screens**

Well screens are filtering devices used to prevent excess sediment from entering the well. They attach to the bottom of the casing, allowing water to move through the well, while keeping out most gravel and sand. The most popular screens are continuous slot, slotted pipe, and perforated pipe.

Perforated pipe is a length of casing that has holes or slots drilled into the pipe. It is not efficient for aquifers that feature a lot of sand and gravel because it has wide openings.

There is less open area in the other two types of screens. Continuous slot screens are made of wire or plastic wrapped around a series of vertical rods. Slotted pipe screens, which have the least amount of open area, feature machine-cut slots into steel or plastic casing at set distances.

## **Pitless Adapters**

Pitless adapters provide wells with a sanitary — and frost-proof — seal between the well casing and the water line running to the well system owner's house.

After a frost line is determined for the area where the well is being installed, the adapter is connected to the well casing below the frost line. Water from the well is then diverted horizontally at the adapter to prevent it from freezing.

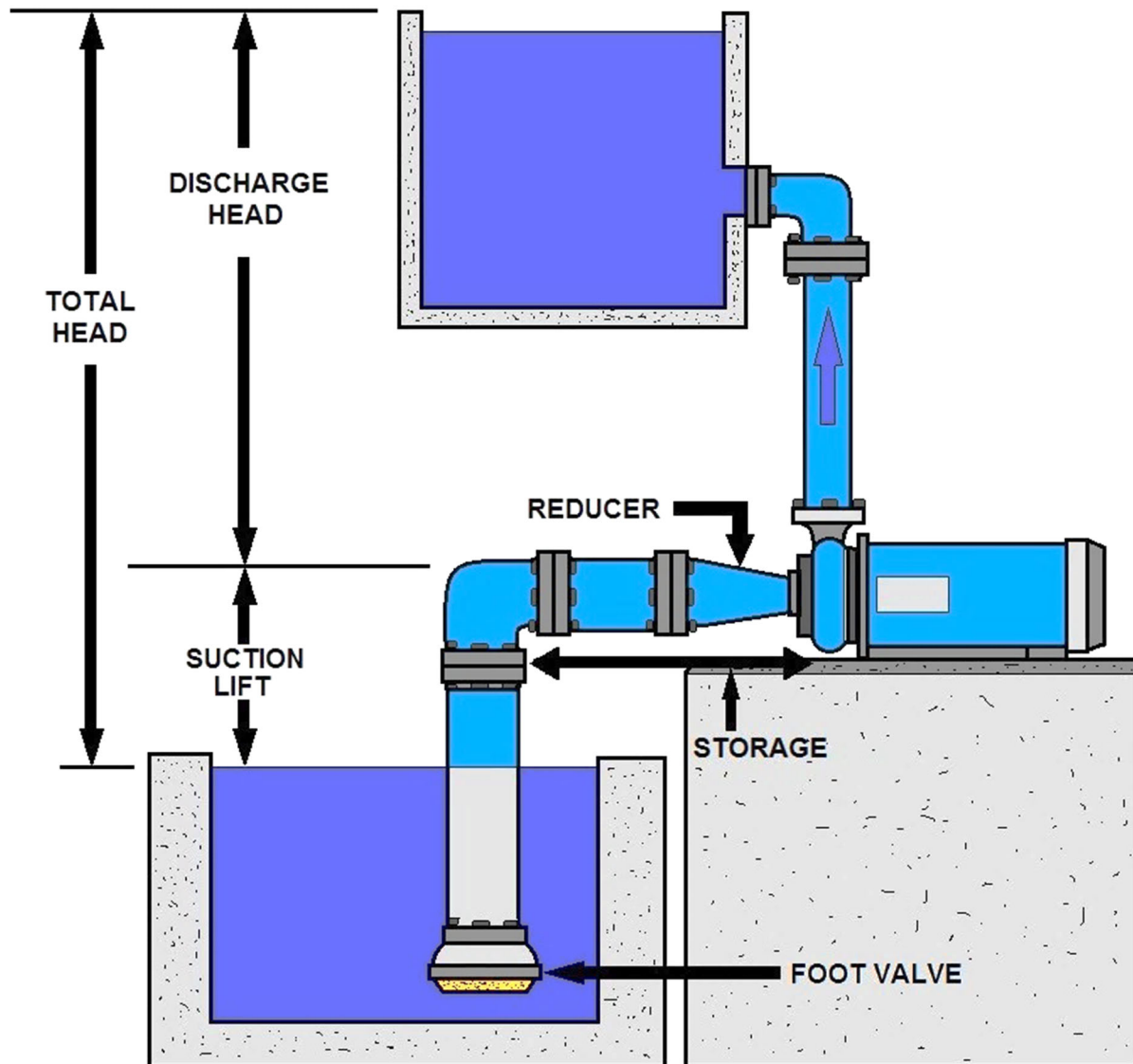

**PUMPING PRINCIPAL FACTOR DIAGRAM #1**

## Control Systems

There is no single control strategy that is optimal for all pumping systems. In one case, on/off control is clearly preferred while in another, pump speed control is the obvious choice.

However, there are many systems for which the choice is not so clear or in which two or more different control schemes would work equally well. And there are some systems that merit a combination of controls, such as multiple parallel pumps with adjustable speed drives for each pump.

Each system must be evaluated on its own terms. The nature of the system curve, the performance characteristics of the installed pumps, the nature of the load variability, and other factors influence the decision process. It is important to note that all of these best practices are likelihoods, not necessarily guarantees.

The following best practices will be discussed in the context of control strategies:

- ✓ Understand the fundamental nature of the system head requirements.
- ✓ Understand the variability of the required flow rate and head.
- ✓ Systems with essentially constant requirements and/or large storage inventories.
- ✓ Systems with continuously varying requirements (and lacking stored inventory).
- ✓ Systems that operate in two or three principal operating zones.
- ✓ Minimize the use of throttling valves or bypass operation for flow regulation.
- ✓ Demand charge minimization.

The most commonly selected control strategies for regulation of pumping systems are:

- ✓ Control valve throttling
- ✓ Bypass (pump recirculation) valve operation
- ✓ Multiple parallel pump operation
- ✓ On/off control
- ✓ Pump speed control
- ✓ Combinations of the above
- ✓ No control – the pumps just run

Systems in which neither the flow rate nor head need to be regulated (under normal, steady-state conditions) are prime candidates for on/off control. This is a general rule of thumb and does not apply to all systems.

An excellent example of this type of system is the municipal water system, where filtered and treated water is pumped from the clear well of a chemical plant to elevated storage tanks.

Although customer demands vary with the time of day and weather conditions, the system storage in most municipal operations provides a sufficient buffer to meet these demand fluctuations. The elevated tanks, of course, also provide a relative constant source of pressure.

## Multiple Flow Regime (Parallel Pump) Controls

Systems with varying flow requirements that operate in discrete regimes can generally be well served by a parallel pump operation, where pumps are properly sized and selected for the individual flow regimes. In the case of the static-dominated system, two options would merit consideration. Two pumps could be chosen to operate solo under the two flow regimes. Or, one pump could be used for the lower flow regime (1000 gpm) and a second pump turned on to run in parallel with the smaller pump to meet the 5000 gpm requirement.

One important note regarding distinct regime operation: In some cases, the intervals for these flow regimes are long and in others, they're short. The parallel pump operation is most readily applied to the longer intervals (such as once per shift). Where the cycles occur in relatively quick fashion (minutes), special care is needed. Frequent direct across-the-line motor starting is hard on switchgear, motors, pumps, and systems. If frequent starting is needed, the use of electronic soft starters or other alternatives (such as adjustable speed drives) should definitely be considered.

### Best Practice —Parallel Pump Control

If there are multiple obvious flow regimes noticed from the system, investigate the option of parallel pumps to handle the different regimes.

## Minimize the Use of Throttling Valves or Bypass Operation

One generic best practice is to minimize the use of valve throttling and bypass losses in system control. Throttled valves convert hydraulic energy that the pump has imparted to the fluid into frictional heat, thus wasting a portion of the pump's energy. Bypass control simply routes some of the fluid that the pump has energized right back where it came from (dissipating the energy into heat in the process). Even this best practice, which is about as close as one can get to simplistic rules of thumb in pumping systems, has its exceptions.

## General Centrifugal Pump Maintenance Procedures

### Centrifugal Pump Start-up- (Beginning of Season)

#### *Maintenance Tasks*

- Using new gaskets and pipe-dope, reconnect to the pump any piping removed during shutdown.
- Re-install the primer and priming valve if they were removed during shutdown.
- Check that the pump shaft turns freely and is free of foreign objects. Applying power could break the impeller if it's rusted to the case.
- Check the pump for leaks caused by drying gaskets.
- Check intake and discharge piping for proper support and make sure the pump is securely bolted to the platform.
- Clean the drain hole on the underside of the pump.

#### **General**

To avoid water leaks, make sure that all gaskets are the correct ones for the coupling or flange. Eliminate air leaks in your pump's suction line by coating threaded connections with pipe cement or white lead and drawing them tight. Also examine suction line welds for cracks, which will allow air leaks.



## Complicated Pumps Post Quiz

1. \_\_\_\_\_ is defined as the phenomenon of formation of vapor bubbles of a flowing liquid in a region where the pressure of the liquid falls below its vapor pressure.
2. Cavitation can be temporarily corrected by throttling the \_\_\_\_\_.
3. \_\_\_\_\_ are used to release trapped air or vacuums created in water pipelines.
4. \_\_\_\_\_ is used to maintain an open access in the earth while not allowing any entrance or leakage into the well from the surrounding formations.
5. Turbulent flows caused by pump discharges, elbows and swedges upstream of a valve will also cause the discs to flutter excessively. Be careful not to create a \_\_\_\_\_.
6. Proper procedure for starting a pump. Fill the pump with liquid, crack open the \_\_\_\_\_ and start the motor.
7. Install a \_\_\_\_\_ in the suction piping to insure the liquid will not drain from the pump casing and suction piping. Keep in mind that these valves have a nasty habit of leaking.
8. Convert the application to a \_\_\_\_\_ that maintains a reservoir of liquid at its suction.
9. Questions 9-14 – in order- Here is the proper way to vent a centrifugal pump after it has been initially installed, or the system has been opened. Assuming the pump is empty of liquid and both the suction and discharge valves are shut. Open the suction valve. The pump fills part way.  
A. True      B. False
10. Open the suction valve.  
A. True      B. False
11. Open the discharge valve part way. Once the pressure equalizes the air will rise in the discharge piping.  
A. True      B. False
12. Close the suction valve.  
A. True      B. False
13. Shut off the pump.  
A. True      B. False

14. When the pump hits its operating speed open the discharge valve to its proper setting to operate close to the BEP. (Best efficiency point)

A. True      B. False

15. Close-coupled pump has the motor and pump together without a shaft between the two. The \_\_\_\_\_ will also support the impeller.

16. An independent supply of water is needed for the \_\_\_\_\_ and its pressure should be higher than the pump's suction.

17. The system pressure is controlled by a pressure switch set for minimum and maximum pressures – giving you a cut-in and a cut-out pressure for the pumps.

A. True      B. False

18. When the pumps cut-out or stop running, water demand is met by the water volume in the piping and the tank. As water is drawn down, the system pressure starts to drop. When it reaches the minimum system pressure, the pump cuts back in and runs until the system pressure reaches the normal maximum pressure.

A. True      B. False

**Answers:** 1. Cavitation, 2. Discharge valve, 3. Air and/or vacuum release valves, 4. Well Casing, 5. Water hammer, 6. Discharge valve, 7. Foot valve, 8. Self-priming pump, 9. True, 10. False, 11. True, 12. False, 13. False, 14. True, 15. Motor bearings, 16. Seal water, 17. True, 18. True

## Complicated Pumps Section References

"Advantages of an Air Operated Double Diaphragm Pump".

"Definitive Guide: Pumps Used in Pressure Washers". The Pressure Washer Review.

"Drilling Pumps". Gardner Denver.

"How do self-priming pumps work?". Pump Sales Direct Blog. 2018-05-11. Retrieved 2018-05-11.

"Online Dictionary – Parish Pump".

"Positive Displacement Pumps - LobePro Rotary Pumps". [www.lobepro.com](http://www.lobepro.com).

"Preventing Suction System Problems Using Reciprocating Pumps". Triangle Pump Components, Inc.

"Radial, mixed and axial flow pumps" (PDF). Institution of Diploma Marine Engineers, Bangladesh. June 2003. Retrieved 2017-08-18.

"Sprayer Pump Types, Costs, and Specifications". Sprayer Supplies. 2018-10-13.

"Stimulation and Fracturing pumps: Reciprocating, Quintuplex Stimulation and Fracturing Pump" Archived at the Wayback Machine. Gardner Denver.

"The Volumetric Efficiency of Rotary Positive Displacement Pumps". [www.pumpsandsystems.com](http://www.pumpsandsystems.com).

"Understanding positive displacement pumps | PumpScout".

"When to use Progressive Cavity Pumps". [www.libertyprocess.com](http://www.libertyprocess.com).

Baha Abulnaga (2004). Pumping Oilsand Froth (PDF). 21st International Pump Users Symposium, Baltimore, Maryland. Published by Texas A&M University, Texas, USA.

C.M. Schumacher, M. Loepfe, R.Fuhrer, R.N. Grass, and W.J. Stark, "3D printed lost-wax casted soft silicone monoblocks enable heart-inspired pumping by internal combustion," RSC Advances, Vol. 4, pp. 16039–16042, 2014.

Demirbas, Ayhan (2008-11-14). Biofuels: Securing the Planet's Future Energy Needs. Springer Science & Business Media. ISBN 9781848820111.

Gulich, Johann Friedrich (2010). Centrifugal Pumps (2nd ed.). ISBN 978-3-642-12823-3.

Hill, Donald Routledge (1996). A History of Engineering in Classical and Medieval Times. London: Routledge. p. 143. ISBN 0-415-15291-7.

Improving Pumping System Performance: A Sourcebook for Industry, Second Edition, May 2006.

John Crane Seal Sentinel – John Crane Increases Production Capabilities with Machine that Streamlines Four Machining Functions into One

Larry Bachus, Angle Custodio (2003). Know and understand centrifugal pumps. Elsevier Ltd. ISBN 1856174093.

Moniz, Paresh Girdhar, Octo (2004). Practical centrifugal pumps design, operation and maintenance (1. publ. ed.). Oxford: Newnes. p. 13. ISBN 0750662735.

Pump classifications. Fao.org.

Pump Handbook: third edition

Pump Statistics Should Shape Strategies. Mt-online.com

Reti, Ladislao; Di Giorgio Martini, Francesco (Summer 1963). "Francesco di Giorgio (Armani) Martini's Treatise on Engineering and Its Plagiarists". Technology and Culture. 4 (3): 287–298 (290). doi:10.2307/3100858.

Sealing Multiphase Pumping Applications | Seals. Pump-zone.com.

Shepard, Dennis G. (1956). Principles of Turbomachinery. Macmillan. ISBN 0-471-85546-4. LCCN 56002849.

Submersible slurry pumps in high demand. Engineeringnews.co.za.

Tanzania water blog – example of grass roots researcher telling about his study and work with the rope pump in Africa.

Triangle Pump Components. "What Is Volumetric Efficiency?".

Vacuum pump new on SA market. Engineeringnews.co.za.

Wasser, Goodenberger, Jim and Bob (November 1993). "Extended Life, Zero Emissions Seal for Process Pumps". John Crane Technical Report. Routledge. TRP 28017.

Welcome to the Hydraulic Institute. Pumps.org.

## Section 8- Pump Operation & Performance

**Section Focus:** You will learn the basics of pump operation. At the end of this section, you will be able to describe principles required to pump water. There is a post quiz at the end of this section to review your comprehension and a final examination in the Assignment for your contact hours.

**Scope/Background:** You also need to be aware of a pump's requirements i.e. various pumping head, net positive suction head, etc.

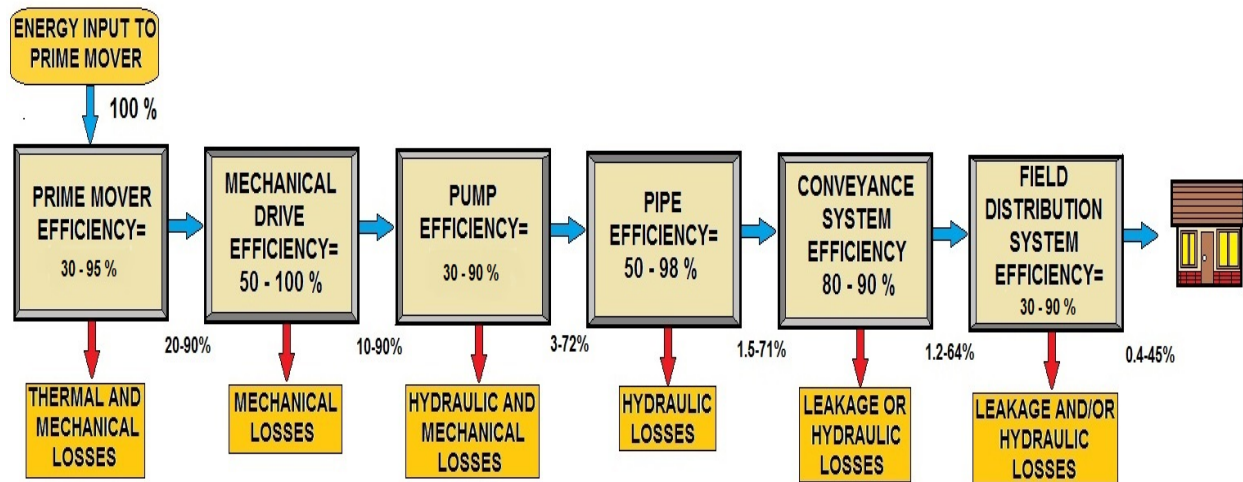

SYSTEM ENERGY EFFICIENCY LOSSES DIAGRAM

Pumps transfer liquids from one point to another by converting mechanical energy from a rotating impeller into pressure energy (head).

The pressure applied to the liquid forces the fluid to flow at the required rate and to overcome friction (or head) losses in piping, valves, fittings, and process equipment.

The pumping system designer must consider fluid properties, determine end use requirements, and understand environmental conditions.

Pumping applications include constant or variable flow rate requirements, serving single or networked loads, and consisting of open loops (non-return or liquid delivery) or closed loops (return systems).

Depending on the industry or plant that you work in, you will probably work on or around a certain type of pump or manufacturer or both.

Pump manufacturers are normally a very good source of information for final pump selection and you should always consult with them, do your own selection first and confirm it with the manufacturer.

They can help you select the right type, model, and speed if you have all the operating conditions and if not they will rarely be able to help you. Most websites will help you gather all the information pertinent to operation and selection of your pump.

Aside from the normal end suction pump, vertical turbine and submersible pumps, there is a wide variety of specialized pumps- that you should consider for your application if you have unusual conditions.

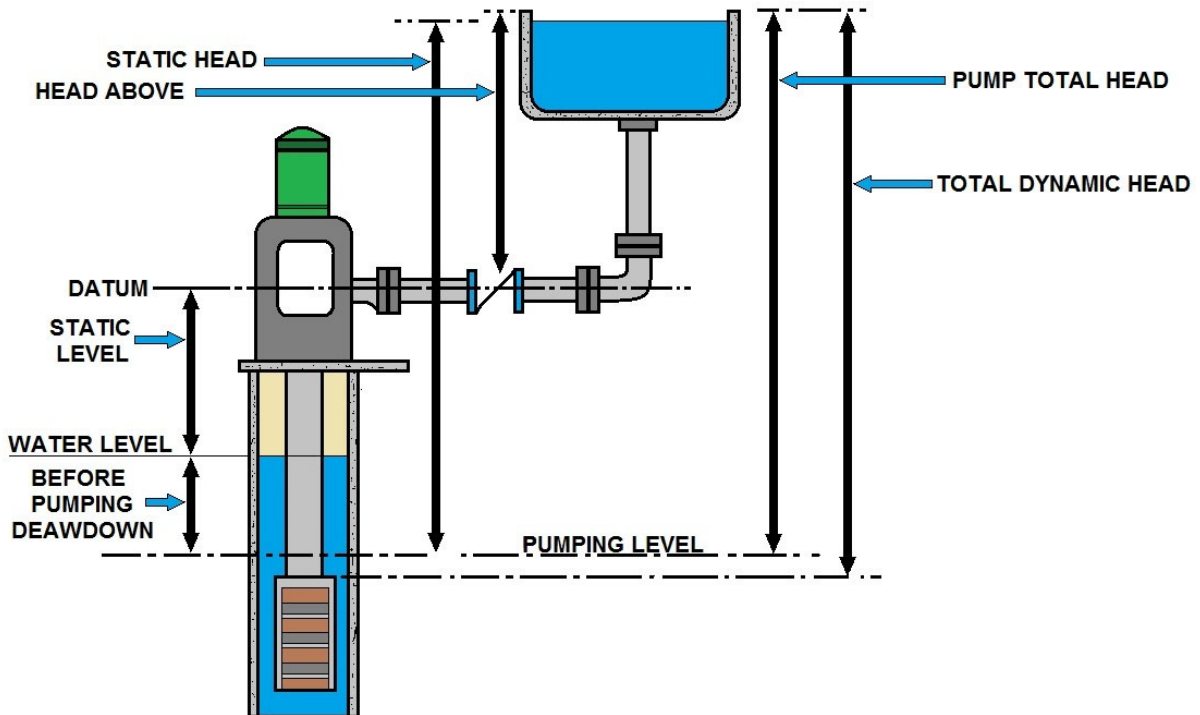

**PUMPING HEAD DIAGRAM #1**

# Pump Operation and Performance Key Terms

## Hyperlink to the Glossary and Appendix

<http://www.abctlc.com/downloads/PDF/PumpGlossary.pdf>

### Best Efficiency Point (BEP)

The rate of flow and total head at which the pump efficiency is maximum at a given speed and impeller diameter.

### Casing

The portion of the pump that includes the impeller chamber and volute diffuser.

### Diffuser

A piece, adjacent to the impeller exit, which has multiple passages of increasing area for converting velocity to pressure.

### Displacement (D)

For a positive displacement pump, it is the theoretical volume per revolution of the pump shaft. Calculation methods and terminology may differ between different types of positive displacement pumps.

### Friction Loss

The amount of pressure / head required to 'force' liquid through pipe and fittings.

### Head (h) [H]

Head is the expression of the energy content of a liquid in reference to an arbitrary datum. It is expressed in units of energy per unit weight of liquid. The measuring unit for head is meters (feet) of liquid.

### Head, Friction

The head required to overcome the friction at the interior surface of a conductor and between fluid particles in motion. It varies with flow, size, type, and conditions of conductors and fittings, and the fluid characteristics.

### Head, Static

The height of a column or body of fluid above a given point.

### Head, Total (H) [H<sub>tx</sub>]

This is the measure of energy increase, per unit weight of liquid, imparted to the liquid by the pump, and is the difference between total discharge head and total suction head. This is the head normally specified for pumping applications because the complete characteristics of a system determine the total head required.

### Hydraulics

Engineering science pertaining to liquid pressure and flow.

### Hydrokinetics

Engineering science pertaining to the energy of liquid flow and pressure.

**Inducer**

A single-stage axial flow helix installed in the suction eye of an impeller to lower the NPSHR.

**Impeller**

The bladed member of a rotating assembly of the pump which imparts the principal force to the liquid pumped.

**NPSH**

Net positive suction head - related to how much suction lift a pump can achieve by creating a partial vacuum. Atmospheric pressure then pushes liquid into the pump. A method of calculating if the pump will work or not in a given application.

**Net Positive Suction Head Available (NPSHA)**

NPSHA is determined by the conditions of the installation and is the total suction head of liquid absolute, determined at the first-stage impeller datum minus the absolute vapor pressure in meters (feet) of the liquid at a specific rate of flow expressed in meters (feet) of liquid. Note that for positive displacement pumps the term Net Positive Inlet Pressure Available (NPIPA) is used and is expressed in pressure absolute kPa (psi).

**Net Positive Suction Head Required (NPSHR)**

NPSHR is the minimum NPSH given by the manufacturer/supplier for a pump achieving a specified performance at the specified capacity, speed, and pumped liquid. Note that occurrence of visible cavitation, increase of noise and vibration due to cavitation, beginning of head or efficiency drop, and cavitation erosion can occur when margin above NPSHR is present. Note that for positive displacement pumps the term Net Positive Inlet Pressure Required (NPIPR) is expressed in pressure absolute kPa (psi).

**Net Positive Suction Head 3% (NPSH3)**

For rotodynamic pumps NPSH3 is defined as the value of NPSHR at which the first-stage total head drops by 3% due to cavitation. This is determined by the vendor by testing with water as outlined in. ANSI/HI 14.6 Rotodynamic Pumps for Hydraulic Performance Acceptance Tests

**Pascal's Law**

A pressure applied to a confined fluid at rest is transmitted with equal intensity throughout the fluid.

**Pressure**

The application of continuous force by one body upon another that it is touching; compression. Force per unit area, usually expressed in pounds per square inch (Pascal or bar).

**Pressure, Absolute**

The pressure above zero absolute, i.e. the sum of atmospheric and gauge pressure. In vacuum related work it is usually expressed in millimeters of mercury. (mmHg).

**Pressure, Atmospheric**

Pressure exerted by the atmosphere at any specific location. (Sea level pressure is approximately 14.7 pounds per square inch absolute, 1 bar = 14.5psi.)

**Pressure, Gauge**

Pressure differential above or below ambient atmospheric pressure.



**Pressure, Static**

The pressure in a fluid at rest.

**Rate of Flow [Q]**

The rate of flow of a pump is the total volume throughput per unit of time at suction conditions. The term capacity is also used.

**Specific Gravity S.G.**

The weight of liquid in comparison to water at approx. 20 degrees C (SG = 1).

**Specific Speed**

A number which is the function of pump flow, head, efficiency etc. Not used in day to day pump selection, but very useful, as pumps with similar specific speed will have similar shaped curves, similar efficiency / NPSH / solids handling characteristics.

**Suction Specific Speed (S)**

Suction specific speed is an index of pump suction operating characteristics. It is determined at the BEP rate of flow with the maximum diameter impeller. Suction specific speed is an indicator of the net positive suction head required [NPSH<sub>3</sub>] for given values of capacity and also provides an assessment of a pump's susceptibility to internal recirculation. Suction specific speed is expressed by the following equation: Suction Specific Speed

**Vapor Pressure**

If the vapor pressure of a liquid is greater than the surrounding air pressure, the liquid will boil.

**Viscosity**

A measure of a liquid's resistance to flow. i.e.: how thick it is. The viscosity determines the type of pump used, the speed it can run at, and with gear pumps, the internal clearances required.

**Volute**

The pump casing for a centrifugal type of pump, typically spiral or circular in shape.

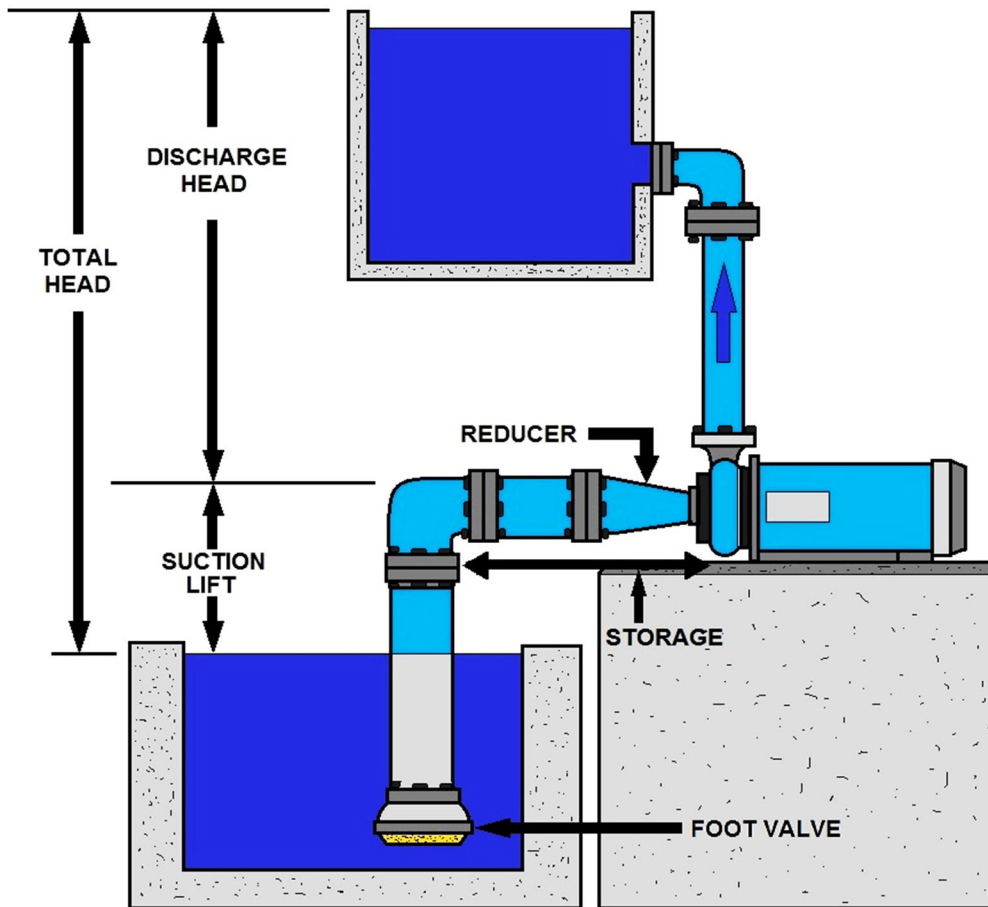

**PUMPING FACTORS**

## Pump Requirements/Operation Introduction

### Understanding Your Pumping System Requirements

Pumps transfer liquids from one point to another by converting mechanical energy from a rotating impeller into pressure energy (head). The pressure applied to the liquid forces the fluid to flow at the required rate and to overcome friction (or head) losses in piping, valves, fittings, and process equipment.

The pumping system designer must consider fluid properties, determine end use requirements, and understand environmental conditions. Pumping applications include constant or variable flow rate requirements, serving single or networked loads, and consisting of open loops (non-return or liquid delivery) or closed loops (return systems).

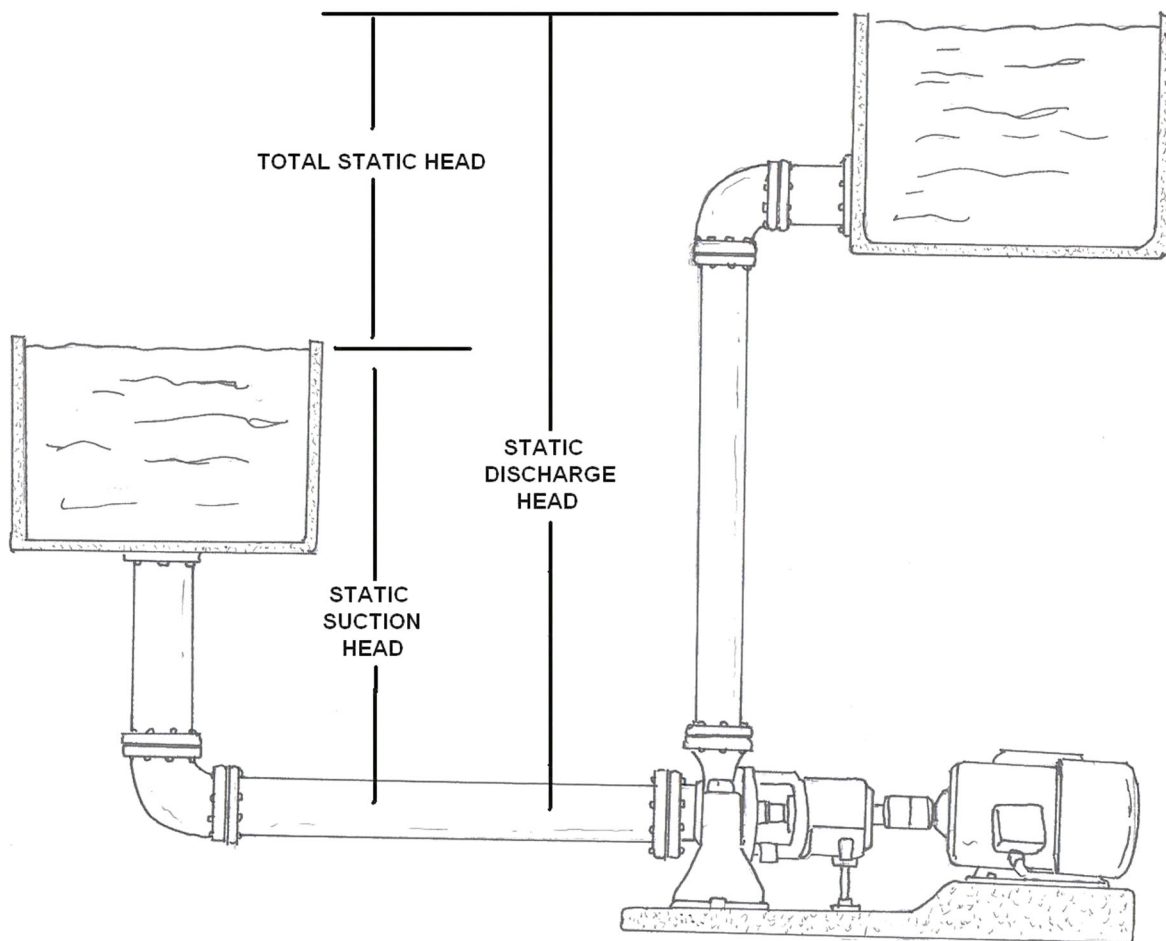

### End Use Requirements—System Flow Rate and Head

The design pump capacity, or desired pump discharge in gallons per minute (gpm) is needed to accurately size the piping system, determine friction head losses, construct a system curve, and select a pump and drive motor.

Process requirements may be met by providing a constant flow rate (with on/off control and storage used to satisfy variable flow rate requirements), or by using a throttling valve or variable speed drive to supply continuously variable flow rates.

The total system head has three components: static head, elevation (potential energy), and velocity (or dynamic) head. Static head is the pressure of the fluid in the system, and is the quantity measured by conventional pressure gauges.

The height of the fluid level can have a substantial impact on system head.

The dynamic head is the pressure required by the system to overcome head losses caused by flow rate resistance in pipes, valves, fittings, and mechanical equipment.

Dynamic head losses are approximately proportional to the square of the fluid flow velocity, or flow rate.

If the flow rate doubles, dynamic losses increased fourfold.

For many pumping systems, total system head requirements vary.

For example, in wet well or reservoir applications, suction and static lift requirements may vary as the water surface elevations fluctuate.

For return systems such as HVAC circulating water pumps, the values for the static and elevation heads equal zero.

You also need to be aware of a pump's net positive suction head requirements.

Centrifugal pumps require a certain amount of fluid pressure at the inlet to avoid cavitation.

A rule of thumb is to ensure that the suction head available exceeds that required by the pump by at least 25% over the range of expected flow rates.

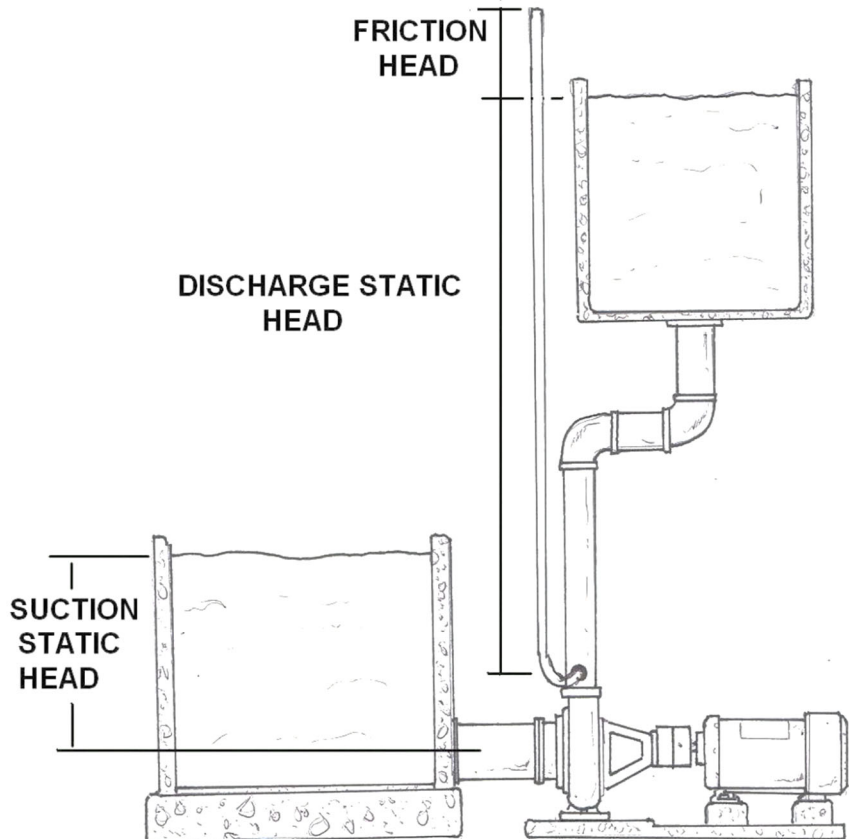

## PUMPING FUNDAMENTALS

Diagrams - Pumping Dynamics

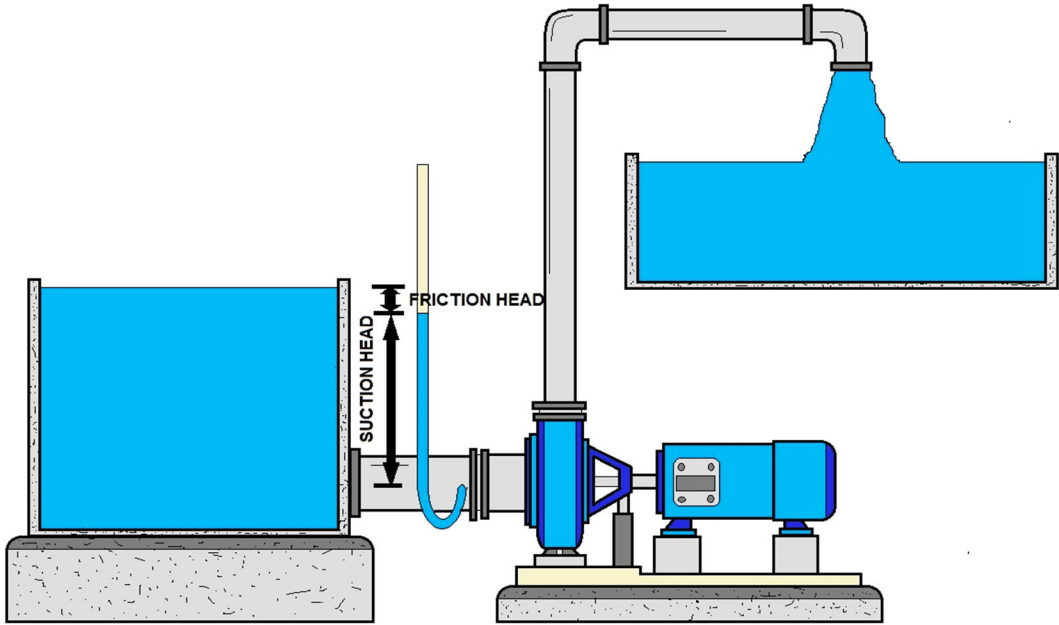

SUCTION HEAD (Suction Lift)

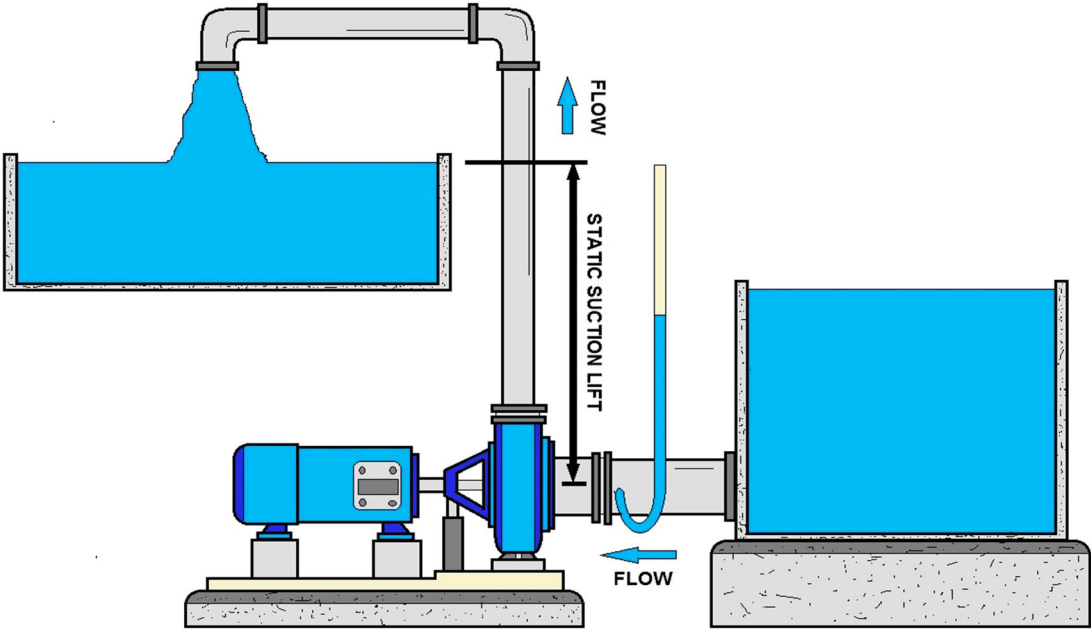

STATIC SUCTION LIFT

$$\text{BHP} = \frac{Q \times H}{3960 \times n} \times \text{s.g.}$$

**BHP= Brake Horsepower**

**Q= Flow**

**H= Head**

**n= Efficiency**

**s.g.= Specific Gravity (always constant)**

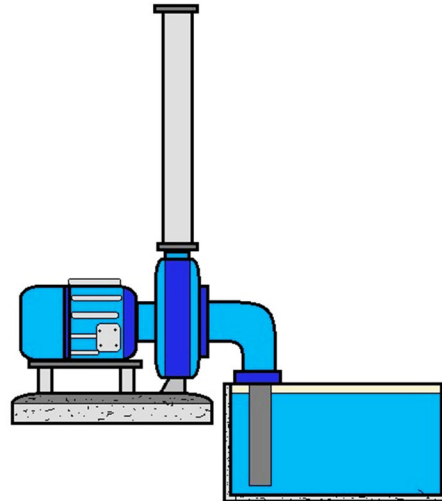

### **BRAKE HORSEPOWER**

(The available power of a motor assessed by measuring the force needed to brake motor)

$$\text{WHP} = \frac{Q \times H}{3960}$$

**Q= FLUID FLOW RATE (gal/min)**

**H= TOTAL DYNAMIC HEAD (feet)**

**3960= FACTOR THAT CONVERTS HORSEPOWER INTO PUMPING TERMS**

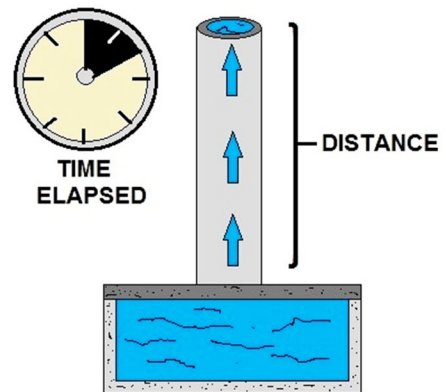

### **WATER HORSEPOWER**

(THE ENERGY ADDED TO THE WATER BY THE PUMP ITSELF)

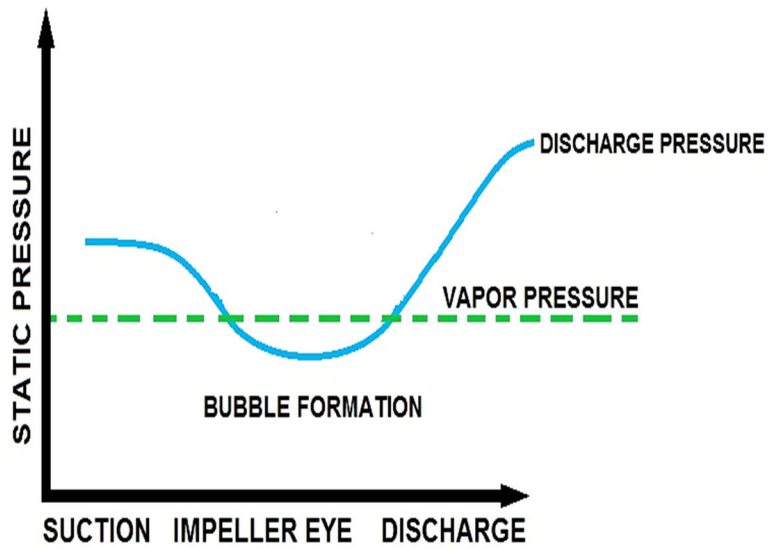
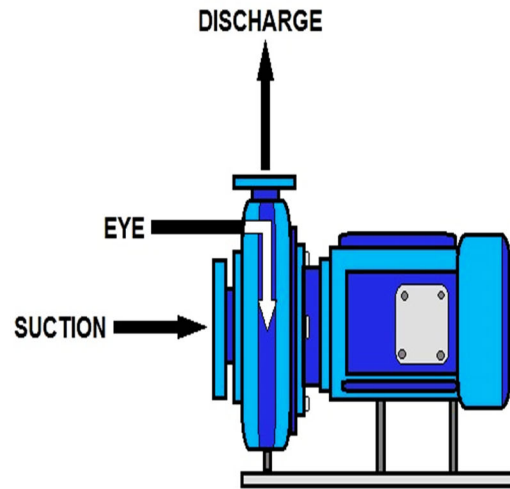
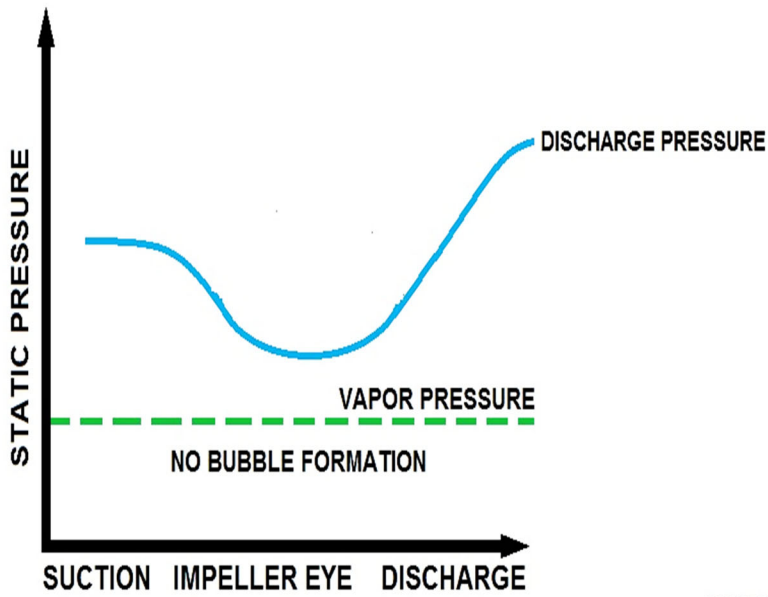

\*NO BUBBLE FORMATION UNDER NORMAL OPERATING CONDITIONS

\*LOW SUCTION PRESSURE CAN CAUSE FLUID TO START BOILING

\*BOILING STARTS WHEN PRESSURE IN LIQUID IS REDUCED TO VAPOR PRESSURE OF THE FLUID AT ACTUAL TEMPERATURE

\*CAUSES:  
 REDUCED PUMP EFFICIENCY  
 CAVITATION IN PUMP  
 PUMP DAMAGE

## NET POSITIVE SUCTION HEAD

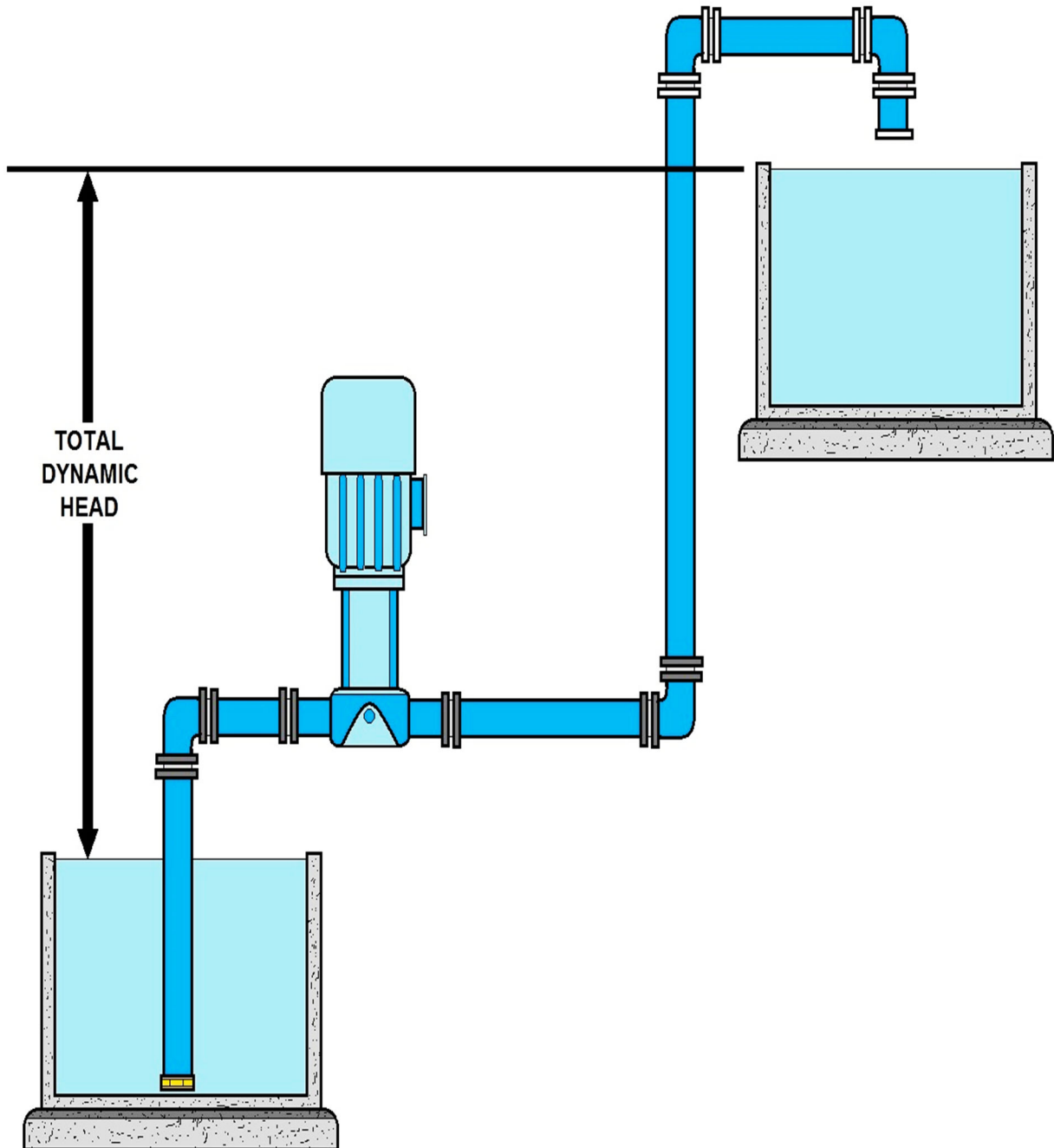

**EXAMPLE OF TOTAL DYNAMIC HEAD**  
(The total equivalent height that fluid is to be pumped)



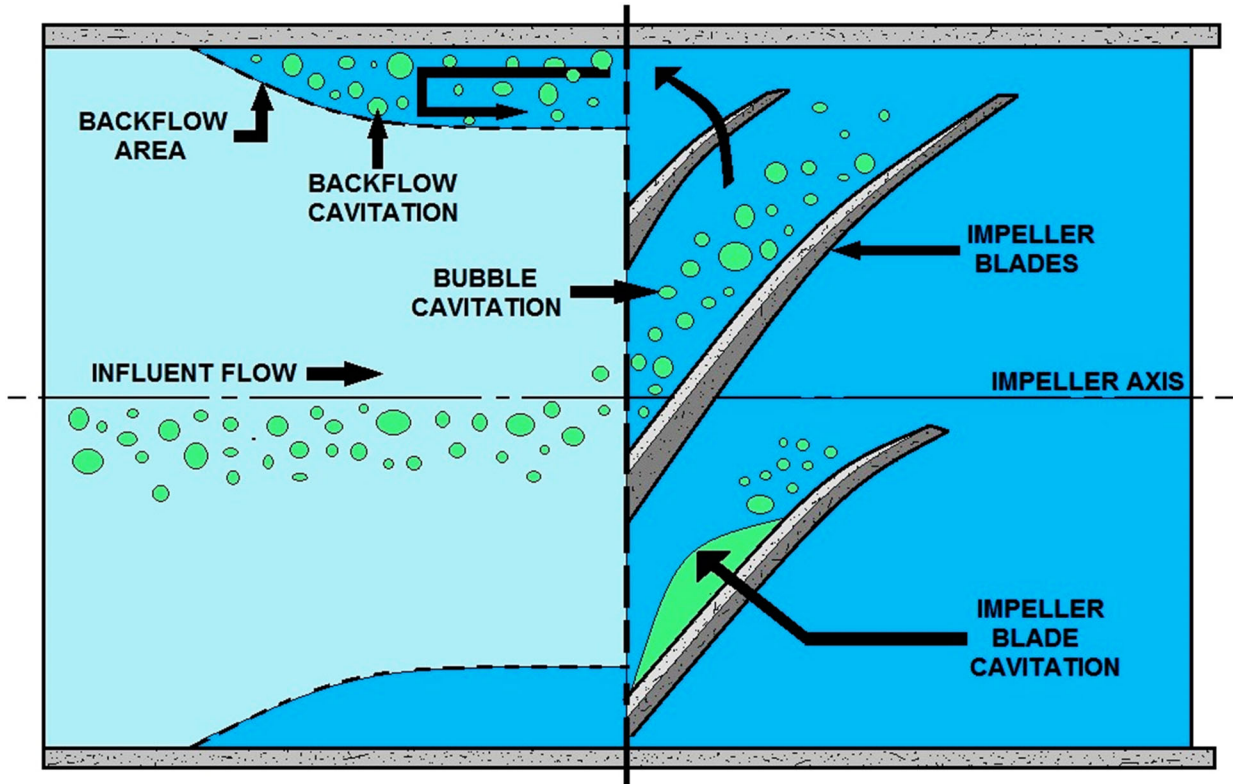

**PUMP CAVITATION**

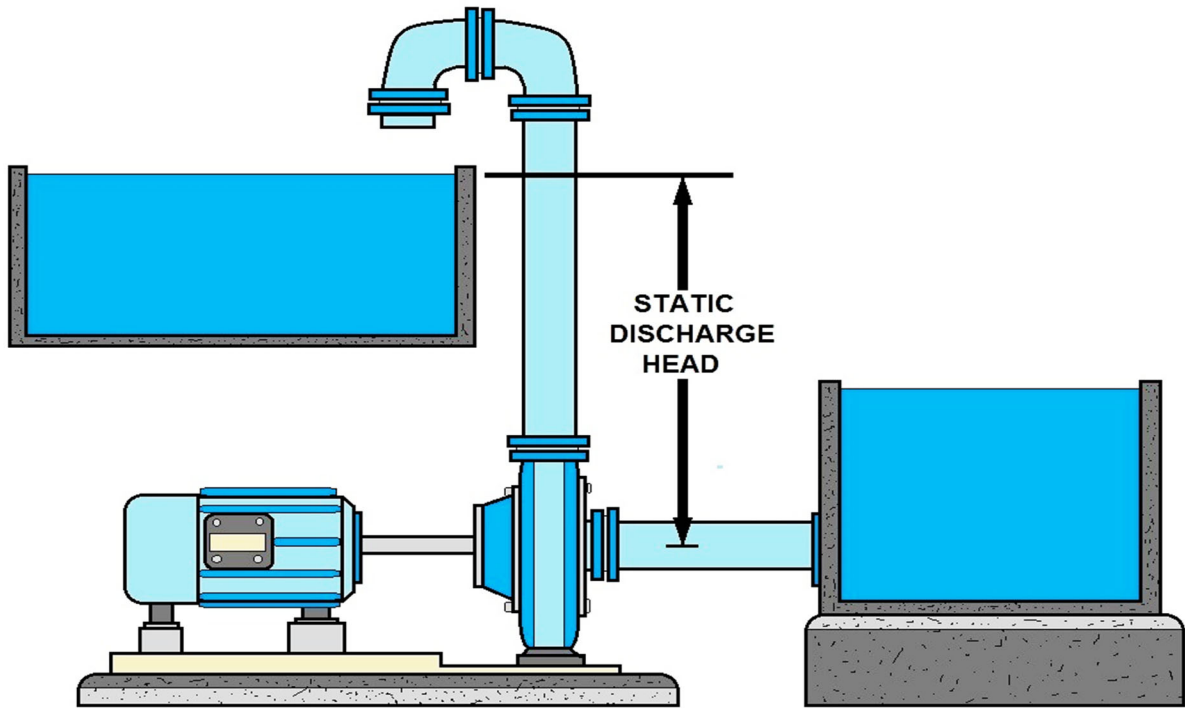

**EXAMPLE OF STATIC DISCHARGE HEAD**  
(The vertical distance from discharge outlet to point of discharge)

## Pump Specifications

Pumps are commonly rated by horsepower, flow rate, outlet pressure in meters (or feet) of head, inlet suction in suction feet (or meters) of head. The head can be simplified as the number of feet or meters the pump can raise or lower a column of water at atmospheric pressure. From an initial design point of view, engineers often use a quantity termed the specific speed to identify the most suitable pump type for a particular combination of flow rate and head.

### Pump Construction Material

The pump material can be Stainless steel (SS 316 or SS 304), cast iron etc. It depends on the application of the pump. In the water industry and for pharma applications SS 316 is normally used, as stainless steel gives better results at high temperatures.

### Pumping Power

The power imparted into a fluid will increase the energy of the fluid per unit volume. Thus the power relationship is between the conversion of the mechanical energy of the pump mechanism and the fluid elements within the pump. In general, this is governed by a series of simultaneous differential equations, known as the Navier-Stokes equations. A simpler equation relating to the different energies in the fluid is known as Bernoulli's equation.

Hence the power,  $P$ , required by the pump:

$$P = \frac{\Delta P Q}{\eta}$$

where  $\Delta P$  is the change in total pressure between the inlet and outlet (in Pa), and  $Q$ , the fluid flowrate is given in  $\text{m}^3/\text{s}$ . The total pressure may have gravitational, static pressure and kinetic energy components; i.e. energy is distributed between change in the fluid's gravitational potential energy (going up or down hill), change in velocity, or change in static pressure.  $\eta$  is the pump efficiency, and may be given by the manufacturer's information, such as in the form of a pump curve, and is typically derived from either fluid dynamics simulation (i.e. solutions to the Navier-stokes for the particular pump geometry), or by testing. The efficiency of the pump will depend upon the pump's configuration and operating conditions (such as rotational speed, fluid density and viscosity etc.)

$$\Delta P = \frac{(v_2^2 - v_1^2)}{2} + \Delta z g + \frac{\Delta p_{\text{static}}}{\rho}$$

For a typical "pumping" configuration, the work is imparted

## Suction Lift Chart

The vertical distance that a pump may be placed above the water level (and be able to draw water) is determined by pump design and limits dictated by altitude. The chart below shows the absolute limits. The closer the pump is to the water level, the easier and quicker it will be to prime.

Suction Lift at Various Elevations

Altitude:	Suction Lift In Feet
Sea Level	25.0
2,000 ft.	22.0
4,000 ft.	19.5
6,000 ft.	17.3
8,000 ft.	15.5
10,000 ft.	14.3

Centrifugal pumps are particularly vulnerable especially when pumping heated solution near the vapor pressure, whereas positive displacement pumps are less affected by cavitation, as they are better able to pump two-phase flow (the mixture of gas and liquid), however, the resultant flow rate of the pump will be diminished because of the gas volumetrically displacing a disproportion of liquid. Careful design is required to pump high temperature liquids with a centrifugal pump when the liquid is near its boiling point.

The violent collapse of the cavitation bubble creates a shock wave that can literally carve material from internal pump components (usually the leading edge of the impeller) and creates noise often described as "pumping gravel".

Additionally, the inevitable increase in vibration can cause other mechanical faults in the pump and associated equipment.

For a typical "pumping" configuration, the work is imparted on the fluid, and is thus positive. For the fluid imparting the work on the pump (i.e. a turbine), the work is negative power required to drive the pump is determined by dividing the output power by the pump efficiency. Furthermore, this definition encompasses pumps with no moving parts, such as a siphon.

When asked how a pump operates, most reply that it "sucks." While not a false statement, it's easy to see why so many pump operators still struggle with pump problems. Fluid flows from areas of high pressure to areas of low pressure.

Pumps operate by creating low pressure at the inlet which allows the liquid to be pushed into the pump by atmospheric or head pressure (pressure due to the liquid's surface being above the centerline of the pump). Consider placing a pump at the top of the mercury barometer above:

Even with a perfect vacuum at the pump inlet, atmospheric pressure limits how high the pump can lift the liquid. With liquids lighter than mercury, this lift height can increase, but there's still a physical limit to pump operation based on pressure external to the pump. This limit is the key consideration for Net Positive Suction Head.

*Reference Centrifugal/Vertical NPSH Margin (ANSI/HI 9.6.1-1998), www.pumps.org, Hydraulic Institute, 1998.*

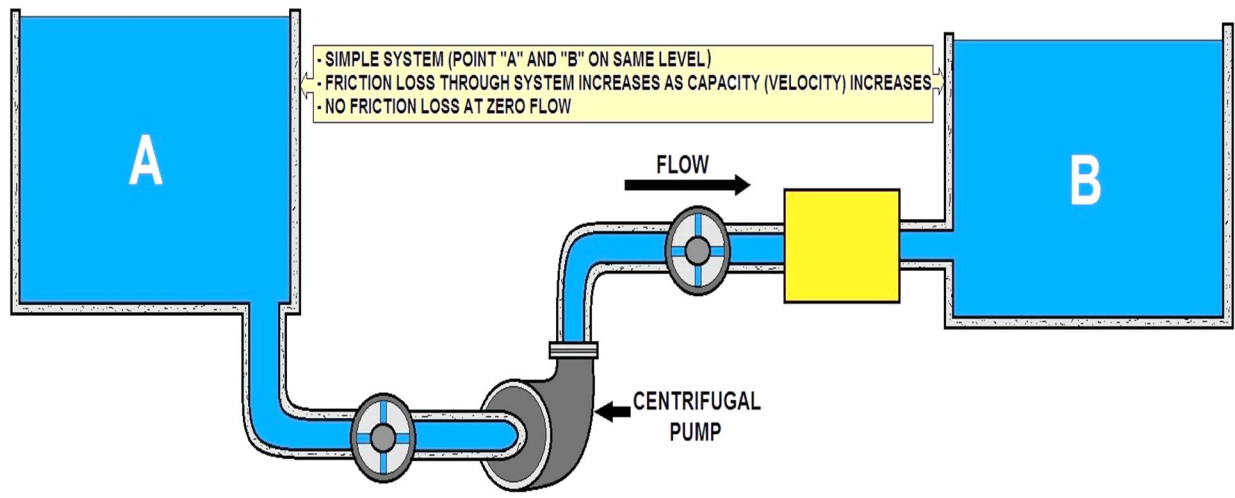
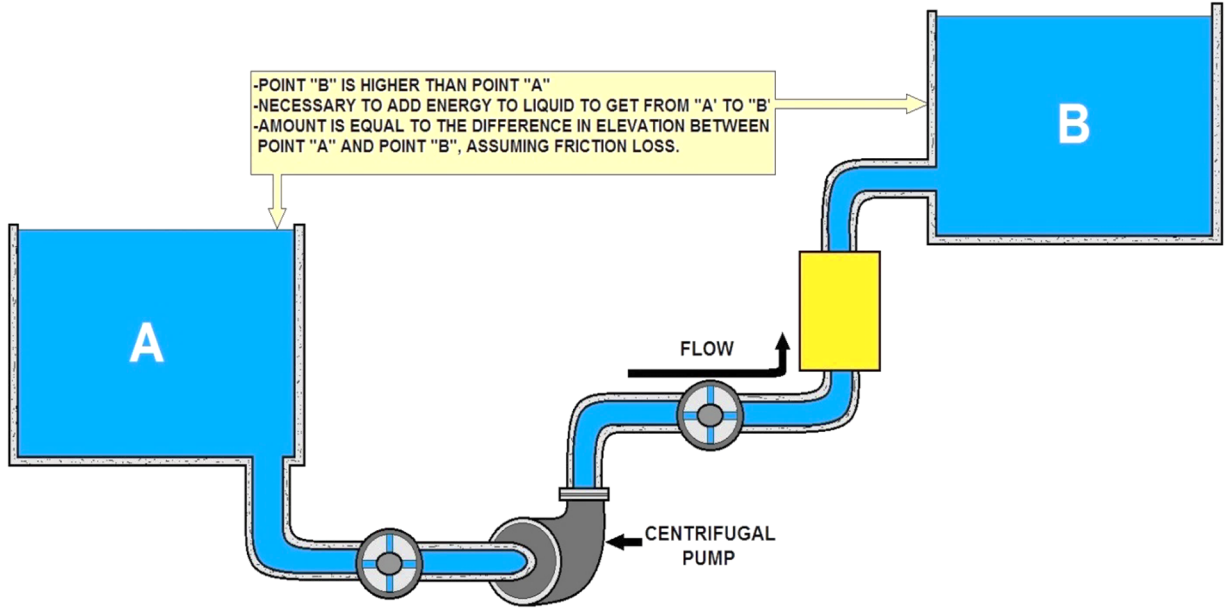

**CENTRIFUGAL PUMP CURVE CHARACTERISTICS**

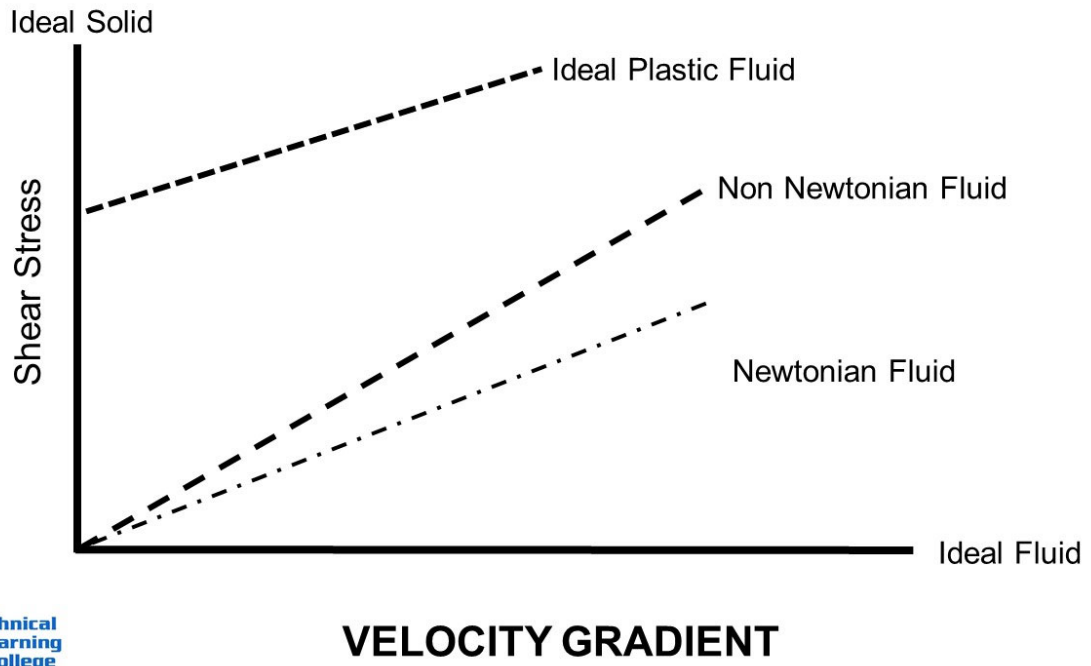

## Pump Efficiency

Pump efficiency is defined as the ratio of the power imparted on the fluid by the pump in relation to the power supplied to drive the pump. Its value is not fixed for a given pump; efficiency is a function of the discharge and therefore also operating head. For centrifugal pumps, the efficiency tends to increase with flow rate up to a point midway through the operating range (peak efficiency) and then declines as flow rates rise further.

Pump performance data such as this is usually supplied by the manufacturer before pump selection. Pump efficiencies tend to decline over time due to wear (e.g. increasing clearances as impellers reduce in size).

When a system design includes a centrifugal pump, an important issue in its design is matching the head loss-flow characteristic with the pump so that it operates at or close to the point of its maximum efficiency.

Pump efficiency is an important aspect and pumps should be regularly tested. Thermodynamic pump testing is one method.

Depending on how the measurement is taken suction lift and head may also be referred to as static or dynamic.

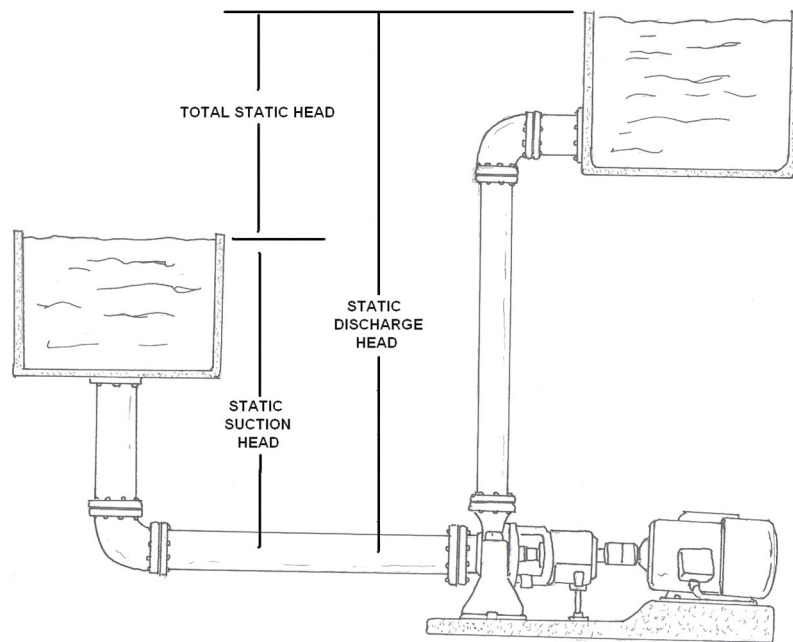

Static indicates the measurement does not take into account the friction caused by water moving through the hose or pipes. Dynamic indicates that losses due to friction are factored into the performance. The following terms are usually used when referring to lift or head.

**Static Suction Lift** - The vertical distance from the water line to the centerline of the impeller.

**Static Discharge Head** - The vertical distance from the discharge outlet to the point of discharge or liquid level when discharging into the bottom of a water tank.

**Dynamic Suction Head** - The Static Suction Lift plus the friction in the suction line. Also referred to as a Total Suction Head.

**Dynamic Discharge Head** - The Static Discharge Head plus the friction in the discharge line. Also referred to as Total Discharge Head.

**Total Dynamic Head** - The Dynamic Suction Head plus the Dynamic Discharge Head. Also referred to as Total Head.

## Net Positive Suction Head (NPSH)

NPSH can be defined as two parts:

NPSH Available (NPSHA): The absolute pressure at the suction port of the pump.

AND

NPSH Required (NPSHR): The minimum pressure required at the suction port of the pump to keep the pump from cavitating.

NPSHA is a function of your system and must be calculated, whereas NPSHR is a function of the pump and must be provided by the pump manufacturer. NPSHA MUST be greater than NPSHR for the pump system to operate without cavitating. Put another way, you must have more suction side pressure available than the pump requires.

### Specific Gravity

The term specific gravity compares the density of some substance to the density of water. Since specific gravity is the ratio of those densities, the units of measure cancel themselves, and we end up with a dimensionless number that is the same for all systems of measure. Therefore, the specific gravity of water is 1—regardless of the measurement system. Specific gravity is important when sizing a centrifugal pump because it is indicative of the weight of the fluid and its weight will have a direct effect on the amount of work performed by the pump. One of the beauties of the centrifugal pump is that the head (in feet) and flow it produces has nothing to do with the weight of the liquid. It is all about the velocity that is added by the impeller. The simplest way to prove the validity of this statement is to use the falling body equation:

$$v^2 = 2gh$$

Where:

v = Velocity

g = The universal gravitational constant

h = height.

This equation will predict the final velocity some object will attain when falling from some height (ignoring friction of course). When rearranged, it takes the form of  $h = v^2/2g$  and predicts the maximum height an object can attain based on its initial velocity. The final velocity attained by a falling object is actually the same as the initial velocity required for it to rise to the same height from which it fell. When this equation is applied to a centrifugal pump, h becomes the maximum theoretical head that it can produce. As the equation illustrates, that head depends upon the exit velocity of the liquid from the impeller vanes and the effect of gravity; it has absolutely nothing to do with the weight of the liquid.

The weight of the liquid does affect the amount of work done by a pump and, therefore, the HP required. A good way to understand the impact of liquid weight is to convert flow in GPM and head in feet into units of work. The equation below performs this conversion.

$$(\text{gpm} \times 8.34 \text{ lb/gal} \times h) = w$$



Here the flow is multiplied by the weight of a gallon of water and then multiplied by the head in feet. The result is the work performed in ft-lb/minute. The equation shows us that the amount of work done by a centrifugal pump is directly proportional to the weight of the pumped liquid.

If you divide  $w$  by 33,000, the result is the HP required at that particular point of flow and head. The downward sloping curve in the upper portion of the graph is the H/Q curve and the red, blue and green curves are the horsepower curves for three different liquids. The scale of the Y axis is both head and horsepower. The blue curve shows the HP required for water (SG=1). The red and green curves show the HP required to pump sugar syrup (SG=1.29) and gasoline (SG=0.71). If you analyze the three HP curves at each flow point, you will see that the increase or decrease is directly proportional to the SG of that particular liquid.

As long as the viscosity of a liquid is similar to that of water, its specific gravity will have no effect on pump performance. It will, however, directly affect the input power required to pump that particular liquid.

The equation below can be used to compute the horsepower required to pump liquids of varying specific gravities (where BHP is brake horsepower, Q is flow in GPM, H is head in feet, SG is specific gravity and Eff is the hydraulic efficiency of the pump). It assumes a viscosity similar to that of water.

$$\mathbf{BHP = (Q \times H \times SG) / (3960 \times Eff)}$$

SG can also have an effect on the onset of cavitation in a particular pump. Heavier liquids cause a proportional increase in a pump's suction energy and those with a high suction energy level are more likely to experience cavitation damage. Next month we will review the effect of viscosity on centrifugal pump performance.

### **Pump Testing**

To minimize energy use, and to ensure that pumps are correctly matched to the duty expected pumps, and pumping stations should be regularly tested. In water supply applications, which are usually fitted with centrifugal pumps, individual large pumps should be 70 - 80% efficient. They should be individually tested to ensure they are in the appropriate range, and replaced or prepared as appropriate.

Pumping stations should also be tested collectively, because where pumps can run in combination to meet a given demand, it is often possible for very inefficient combination of pumps to occur. For example: it is perfectly possible to have a large and a small pump operating in parallel, with the smaller pump not delivering any water, but merely consuming energy. Pumps are readily tested by fitting a flow meter, measuring the pressure difference between inlet and outlet, and measuring the power consumed.

Another method is thermodynamic pump testing where only the temperature rises and power consumed need be measured. Depending on how the measurement is taken suction lift and head may also be referred to as static or dynamic. Static indicates the measurement does not take into account the friction caused by water moving through the hose or pipes.

Dynamic indicates that losses due to friction are factored into the performance. The following terms are usually used when referring to lift or head.

**Static Suction Lift** - The vertical distance from the water line to the centerline of the impeller.

**Static Discharge Head** - The vertical distance from the discharge outlet to the point of discharge or liquid level when discharging into the bottom of a water tank.

**Dynamic Suction Head** - The Static Suction Lift plus the friction in the suction line. Also referred to as a Total Suction Head.

**Dynamic Discharge Head** - The Static Discharge Head plus the friction in the discharge line. Also referred to as Total Discharge Head.

**Total Dynamic Head** - The Dynamic Suction Head plus the Dynamic Discharge Head. Also referred to as Total Head.

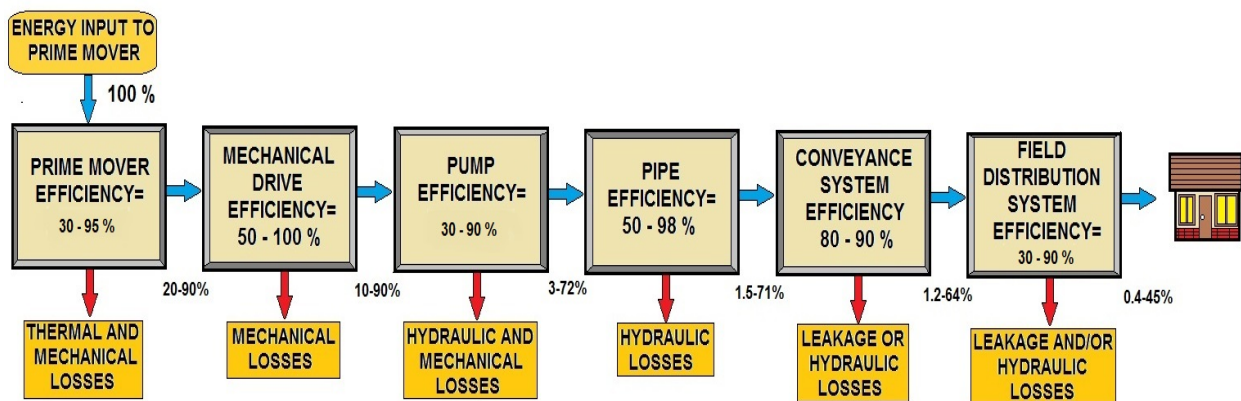

SYSTEM ENERGY EFFICIENCY LOSSES DIAGRAM

**Hyperlink to the Glossary and Appendix**

<http://www.abctlc.com/downloads/PDF/PumpGlossary.pdf>

## Understanding Pump Viscosity

When to use a centrifugal or a Positive Displacement pump (“PD Pump”) is not always a clear choice. To make a good choice between these pump types it is important to understand that these two types of pumps behave very differently.

First, let’s examine the density of the substance to be pumped. The density of a substance is defined as its mass per unit volume, but here on the earth’s surface, we can substitute weight for mass. At 39-deg F (4-deg C), water has a density of 8.34 pounds per gallon or 62.43 pounds per cubic foot. In the metric system, its density is one gram per cubic centimeter, or 1,000-kg per cubic meter.

### Understanding Pump Friction Loss

To optimize a fluid piping system, it is important to have a clear understanding of how the various system items interact. Regardless of the methods used to gain a thorough picture of piping system operations, a variety of calculations must be performed. Among the formulas are the Bernoulli equation to calculate the pressure in the system, and the Darcy-Weisbach equation, which is commonly used to calculate head loss in a pipe run. The Bernoulli Equation is a way of expressing the total energy of fluid as it flows through a pipe run

### The Piping System

A piping system is configured of individual pipe runs connected in series and parallel combinations with pumps, control valves, flowmeters and components. It is essential to recognize how these unique elements interact and work together as a system. There are both graphical and analytical methods that provide an understanding of how the various items interact as a total system.

The head loss is calculated using the graphical method for a variety of flow rates for each pipe run. The results can be read off the graph after the information is plotted. Using the analytical method, the results are calculated directly, which eliminates the need for further graphics.

In fluid dynamics, the Darcy–Weisbach equation is a phenomenological equation, which relates the head loss — or pressure loss — due to friction along a given length of pipe to the average velocity of the fluid flow. The equation is named after Henry Darcy and Julius Weisbach.

The Darcy–Weisbach equation contains a dimensionless friction factor, known as the Darcy friction factor. This is also called the Darcy–Weisbach friction factor or Moody friction factor. The Darcy friction factor is four times the Fanning friction factor, with which it should not be confused.

### Head Loss Formula

Head loss can be calculated with

$$h_f = f_D \cdot \frac{L}{D} \cdot \frac{V^2}{2g}$$

where

- $h_f$  is the head loss due to friction (SI units: m);
- $L$  is the length of the pipe (m);

- $D$  is the hydraulic diameter of the pipe (for a pipe of circular section, this equals the internal diameter of the pipe) (m);
- $V$  is the average velocity of the fluid flow, equal to the volumetric flow rate per unit cross-sectional wetted area (m/s);
- $g$  is the local acceleration due to gravity ( $m/s^2$ );
- $fD$  is a dimensionless coefficient called the Darcy friction factor. It can be found from a Moody diagram or more precisely by solving the Colebrook equation. Do not confuse this with the Fanning Friction factor,  $f$ .

However, the establishment of the friction factors was still an unresolved issue which needed further work.

# Darcy-Weisbach Formula

## Flow of fluid through a pipe

The flow of liquid through a pipe is resisted by viscous shear stresses within the liquid and the turbulence that occurs along the internal walls of the pipe, created by the roughness of the pipe material. This resistance is usually known as pipe friction and is measured in feet or meters head of the fluid, thus the term head loss is also used to express the resistance to flow.

Many factors affect the head loss in pipes, the viscosity of the fluid being handled, the size of the pipes, the roughness of the internal surface of the pipes, the changes in elevations within the system and the length of travel of the fluid. The resistance through various valves and fittings will also contribute to the overall head loss. A method to model the resistances for valves and fittings is described elsewhere.

In a well-designed system the resistance through valves and fittings will be of minor significance to the overall head loss, many designers choose to ignore the head loss for valves and fittings at least in the initial stages of a design.

Much research has been carried out over many years and various formulas to calculate head loss have been developed based on experimental data. Among these is the Chézy formula which dealt with water flow in open channels. Using the concept of 'wetted perimeter' and the internal diameter of a pipe the Chézy formula could be adapted to estimate the head loss in a pipe, although the constant 'C' had to be determined experimentally.

## The Darcy-Weisbach Equation

Weisbach first proposed the equation we now know as the Darcy-Weisbach formula or Darcy-Weisbach equation:

$$h_f = f (L/D) \times (v^2/2g)$$

where:

$h_f$  = head loss (m)

$f$  = friction factor

$L$  = length of pipe work (m)

$d$  = inner diameter of pipe work (m)

$v$  = velocity of fluid (m/s)

$g$  = acceleration due to gravity (m/s<sup>2</sup>)

or:

$h_f$  = head loss (ft)

$f$  = friction factor

$L$  = length of pipe work (ft)

$d$  = inner diameter of pipe work (ft)

$v$  = velocity of fluid (ft/s)

$g$  = acceleration due to gravity (ft/s<sup>2</sup>)



## The Moody Chart

In 1944 LF Moody plotted the data from the Colebrook equation and this chart which is now known as 'The Moody Chart' or sometimes the Friction Factor Chart, enables a user to plot the Reynolds number and the Relative Roughness of the pipe and to establish a reasonably accurate value of the friction factor for turbulent flow conditions.

The Moody Chart encouraged the use of the Darcy-Weisbach friction factor and this quickly became the method of choice for hydraulic engineers. Many forms of head loss calculator were developed to assist with the calculations, amongst these a round slide rule offered calculations for flow in pipes on one side and flow in open channels on the reverse side.

The development of the personal computer from the 1980's onwards reduced the time needed to perform the friction factor and head loss calculations, which in turn has widened the use of the Darcy-Weisbach formula to the point that all other formula are now largely unused.

This dimensionless chart is used to work out pressure drop,  $\Delta P$  (Pa) (or head loss,  $h_f$  (m)) and flow rate through pipes. Head loss can be calculated using the Darcy-Weisbach equation:

$$h_f = f \frac{l V^2}{d 2 g};$$

not to be confused with the Fanning equation and the Fanning friction factor:

$$h_f = 4f \frac{l V^2}{d 2 g},$$

which uses a friction-factor equal to one fourth the Darcy-Weisbach friction factor. Pressure drop can then be evaluated as:

$$\Delta P = \rho g h_f \text{ or directly from } \Delta P = f \frac{\rho V^2 l}{2 d},$$

where  $\rho$  is the density of the fluid,  $V$  is the average velocity in the pipe,  $f$  is the friction factor from the Moody chart,  $l$  is the length of the pipe and  $d$  is the pipe diameter.

The basic chart plots Darcy-Weisbach friction factor against Reynolds number for a variety of relative roughnesses and flow regimes. The relative roughness being the ratio of the mean

$$\frac{\epsilon}{d}$$

height of roughness of the pipe to the pipe diameter or

The Moody chart can be divided into two regimes of flow: laminar and turbulent. For the laminar flow regime, the Darcy-Weisbach friction factor was determined analytically by

$$\frac{64}{Re}$$

Poiseuille and  $Re$  is used. In this regime roughness has no discernible effect. For the turbulent flow regime, the relationship between the friction factor and the Reynolds number is more complex and is governed by the Colebrook equation which is implicit in  $f$ :

$$\frac{1}{\sqrt{f}} = -2.0 \log_{10} \left( \frac{\epsilon}{3.7d} + \frac{2.51}{Re\sqrt{f}} \right), \text{ turbulent flow.}$$

In 1944, Lewis Ferry Moody plotted the Darcy–Weisbach friction factor into what is now known as the Moody chart.

The Fanning friction factor is 1/4 the Darcy–Weisbach one and the equation for pressure drop has a compensating factor of four.

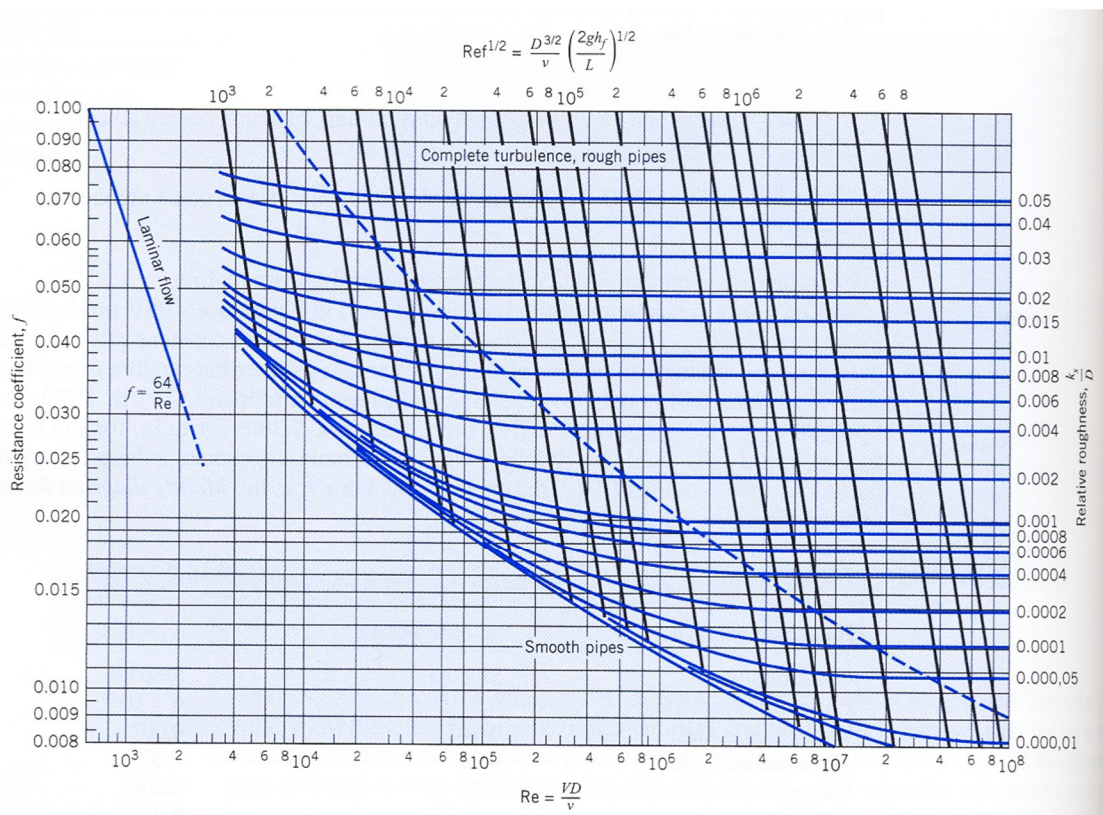



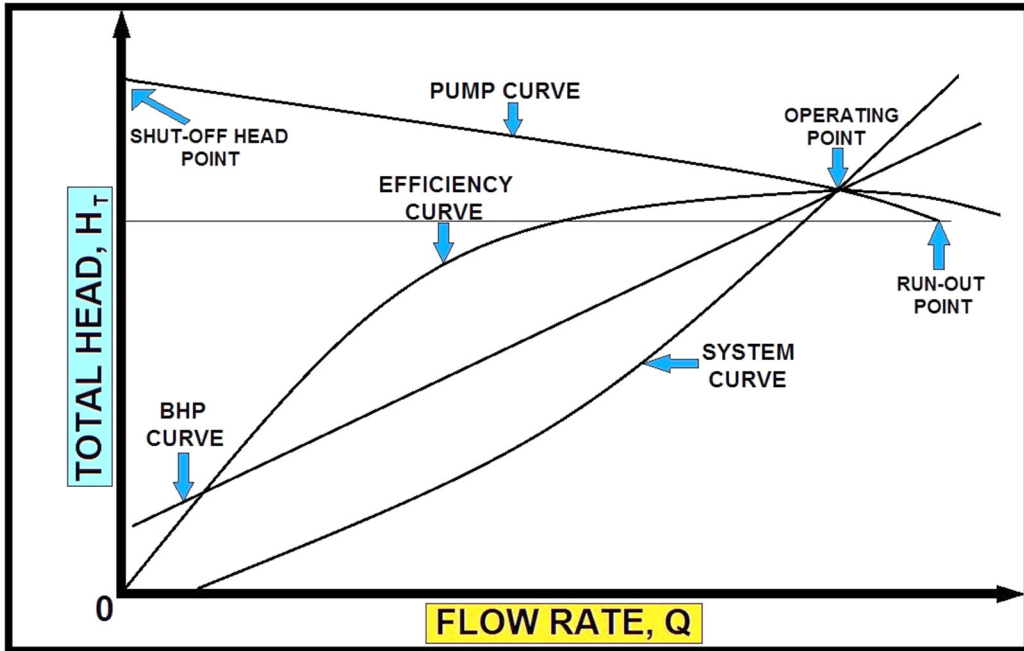

**PUMP PERFORMANCE CURVE (CENTRIFUGAL PUMP)**

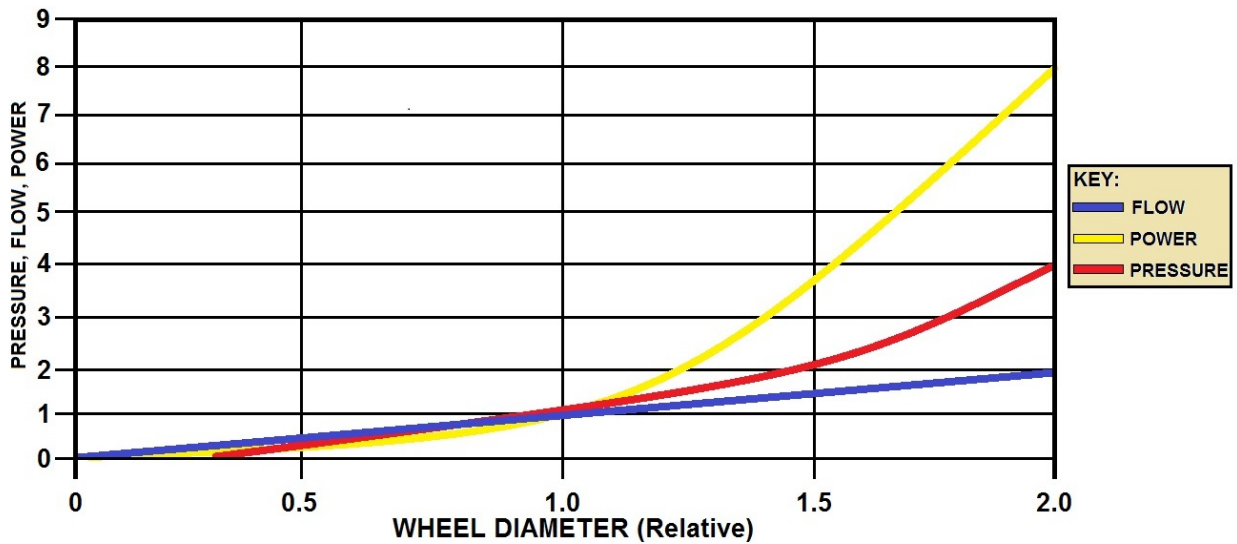

**PUMP AFFINITY LAWS**

(PUMP AFFINITY INDICATES THE INFLUENCE ON VOLUME CAPACITY, HEAD PRESSURE, AND POWER CONSUMPTION OF A PUMP DUE TO CHANGE IN SPEED OF WHEEL (RPM) AND CHANGE IN IMPELLER DIAMETER)

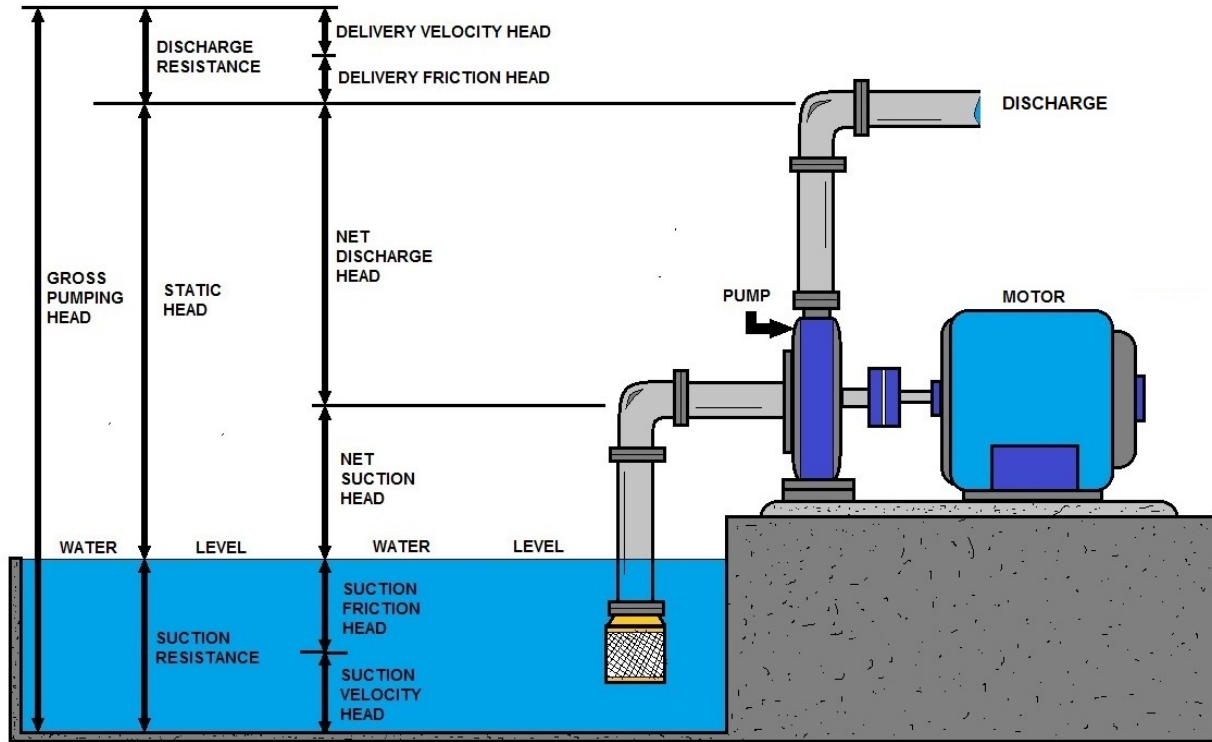

**FACTORS IN DETERMINING A TYPICAL PUMP INSTALLATION**

## Understanding Suction Lift

Suction lift deals with the maximum distance to the intake of a pump. Fire pumps and others may lift about 5' to 10' of suction. You must lower the pump continually towards the water to keep them pumping. This creates a water risk, and when they put it back in, it pumps for a while, and if it quits again, then the same process must be repeated until it is pumping properly. Pumps operating at a negative minimum inlet pressure are capable of creating a suction lift (non-self-priming). The suction capacity is approximately equal to the level of the negative minimum inlet pressure minus a 3 foot safety factor.

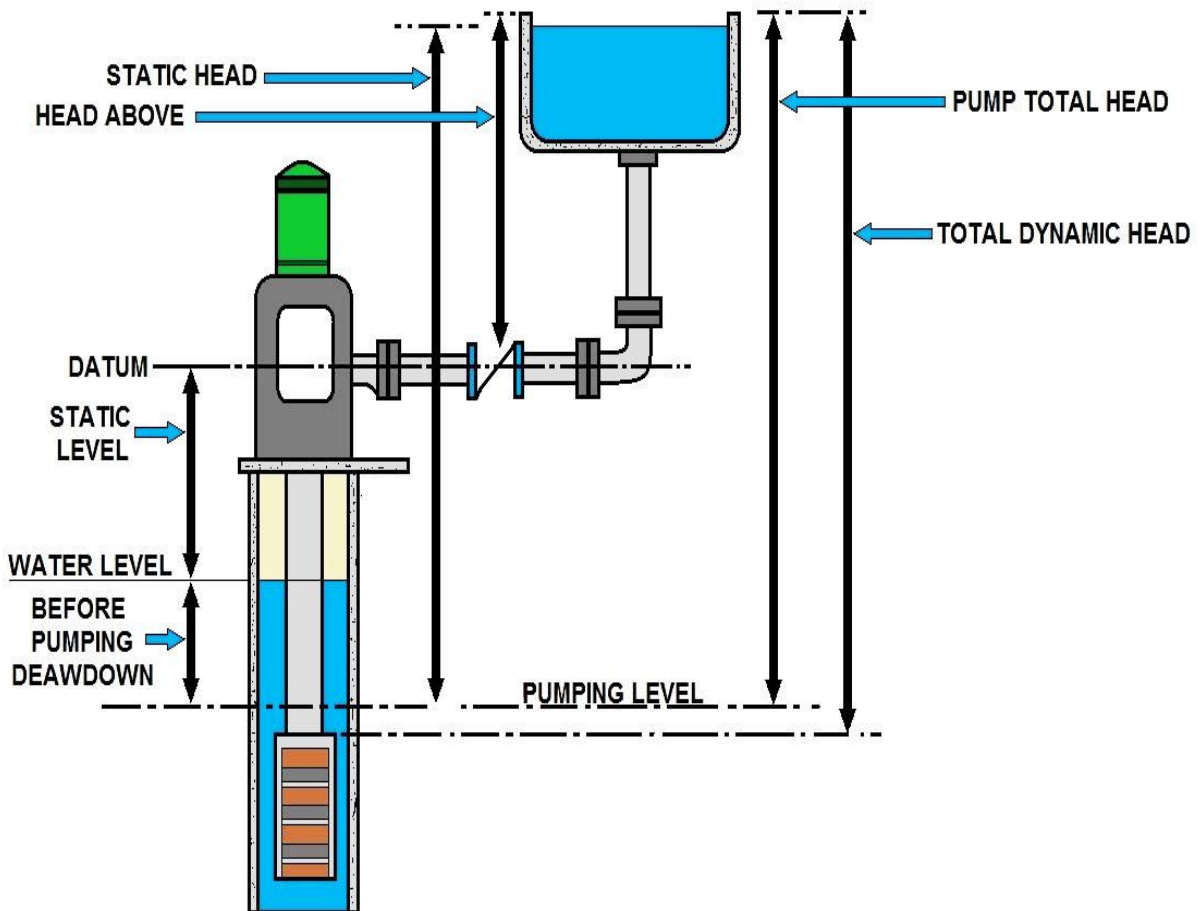

**PUMPING HEAD DIAGRAM**

NPSH is initialism for Net Positive Suction Head. In any cross-section of a generic hydraulic circuit, the NPSH parameter shows the difference between the actual pressure of a liquid in a pipeline and the liquid's vapor pressure at a given temperature.

NPSH is an important parameter to take into account when designing a circuit: whenever the liquid pressure drops below the vapor pressure, liquid boiling occurs, and the final effect will be cavitation: vapor bubbles may reduce or stop the liquid flow, as well as damage the system.

Centrifugal pumps are particularly vulnerable especially when pumping heated solution near the vapor pressure, whereas positive displacement pumps are less affected by cavitation, as they are better able to pump two-phase flow (the mixture of gas and liquid), however, the resultant flow rate of the pump will be diminished because of the gas volumetrically displacing a disproportion of liquid. Careful design is required to pump high temperature liquids with a centrifugal pump when the liquid is near its boiling point.

The violent collapse of the cavitation bubble creates a shock wave that can literally carve material from internal pump components (usually the leading edge of the impeller) and creates noise often described as "pumping gravel". Additionally, the inevitable increase in vibration can cause other mechanical faults in the pump and associated equipment.

$$NPSH = \frac{p_0 - p_v}{\rho g} + \Delta z - h_L$$

where  $h_L$  is the head loss between 0 and 1,  $p_0$  is the pressure at the water surface,  $p_v$  is the vapor pressure (saturation pressure) for the fluid at the temperature  $T_1$  at 1,  $\Delta z$  is the difference in height  $z_1 - z_0$  from the water surface to the location 1, and  $\rho$  is the fluid density, assumed constant, and  $g$  is gravitational acceleration.

where  $h_L$  is the head loss between 0 and 1,  $p_0$  is the pressure at the water surface,  $p_v$  is the vapor pressure (saturation pressure) for the fluid at the temperature at 1,  $\Delta z$  is the difference in height (shown as H on the diagram) from the water surface to the location 1, and  $\rho$  is the fluid density, assumed constant, and  $g$  is gravitational acceleration.

### Suction Limitations

Regardless of the extent of the vacuum, water can only be "lifted" a set distance or height due to its' vaporization pressure.

As the pressure above the water is reduced, the water will tend to rise as a result of the atmospheric pressure, which is tending to push the water into the pump suction piping. The theoretical maximum suction lift for water is 33.9 feet.

From a practical standpoint, in consideration of the friction loss of the piping, the altitude of the station, etc., the normal maximum lift for any pump is approximately 25 ft. However, it must be remembered that cavitation of the impeller increases as the suction lift increases, and therefore, the pump, where possible, should be located so that the suction line is submerged at all times.

Pumps lift water with the help of atmospheric pressure, then pressurize and discharge the water from the casing. The practical suction lift, at sea level is 25 feet.

Most pump manufacturers will list this as the maximum suction lift. Static suction lift is the maximum distance from the water level, to the centerline of the impeller. The main type of pump used for suction lift is a vertical shaft turbine pump.

Suction lift exists when a liquid is taken from an open tank to an atmospheric tank where the liquid level is below the centerline of the pump suction.

## The Following Relationships May help to Better Understand Suction Lift

**Total Dynamic Head** = Total discharge head + Total Suction Lift

**Total Suction Lift** = static + friction

Depending on how the measurement is taken suction lift and head may also be referred to as static or dynamic. Static indicates the measurement does not take into account the friction caused by water moving through the hose or pipes. Dynamic indicates that losses due to friction are factored into the performance. The following terms are usually used when referring to lift or head.

**Static Suction Lift** - The vertical distance from the water line to the centerline of the impeller.

**Static Discharge Head** - The vertical distance from the discharge outlet to the point of discharge or liquid level when discharging into the bottom of a water tank.

**Dynamic Suction Head** - The Static Suction Lift plus the friction in the suction line. Also referred to as a Total Suction Head.

**Dynamic Discharge Head** - The Static Discharge Head plus the friction in the discharge line. Also referred to as Total Discharge Head.

**Total Dynamic Head** - The Dynamic Suction Head plus the Dynamic Discharge Head. Also referred to as Total Head.

### Suction Lift Chart

The vertical distance that a pump may be placed above the water level (and be able to draw water) is determined by pump design and limits dictated by altitude.

The chart below shows the absolute limits. The closer the pump is to the water level, the easier and quicker it will be to prime.

<b>Altitude:</b>	<b>Suction Lift In Feet</b>
Sea Level	25.0
2,000 ft.	22.0
4,000 ft.	19.5
6,000 ft.	17.3
8,000 ft.	15.5
10,000 ft.	14.3

## Understanding Pump Performance

The formula for calculating NPSHA:

NPSHA

$$\text{Term} = H_A \pm H_Z - H_F + H_V - H_{VP}$$

The formula for calculating NPSHA:

NPSHA		
Term	Definition	Notes
$H_A$ $\pm H_Z - H_F$ $+ H_V - H_{VP}$		
$H_A$	The absolute pressure on the surface of the liquid in the supply tank	Typically, atmospheric pressure (vented supply tank), but can be different for closed tanks. Don't forget that altitude affects atmospheric pressure ( $H_A$ in Denver, CO will be lower than in Miami, FL). <u>Always</u> positive (may be low, but even vacuum vessels are at a positive <u>absolute</u> pressure)
$H_Z$	The vertical distance between the surface of the liquid in the supply tank and the centerline of the pump	Can be positive when liquid level is above the centerline of the pump (called static head) Can be negative when liquid level is below the centerline of the pump (called suction lift) Always be sure to use the lowest liquid level allowed in the tank.
$H_F$	Friction losses in the suction piping	Piping and fittings act as a restriction, working against liquid as it flows towards the pump inlet.
$H_V$	Velocity head at the pump suction port	Often not included as it's normally quite small.
$H_{VP}$	Absolute vapor pressure of the liquid at the pumping temperature	Must be subtracted in the end to make sure that the inlet pressure stays above the vapor pressure. Remember, as temperature goes up, so does the vapor pressure.

## Understanding Affinity Laws

### The Affinity Laws

The affinity laws are used in hydraulics and HVAC to express the relationship between variables involved in pump or fan performance (such as head, volumetric flow rate, shaft speed) and power. They apply to pumps, fans, and hydraulic turbines. In these rotary implements, the affinity laws apply both to centrifugal and axial flows.

The affinity laws are useful as they allow prediction of the head discharge characteristic of a pump or fan from a known characteristic measured at a different speed or impeller diameter. The only requirement is that the two pumps or fans are dynamically similar, that is the ratios of the fluid forced are the same.

These laws assume that the pump/fan efficiency remains constant i.e. When applied to pumps the laws work well for constant diameter variable speed case (Law 1) but are less accurate for constant speed variable impeller diameter case (Law 2).

Law 1a. Flow is proportional to shaft speed:

$$\frac{Q_1}{Q_2} = \left( \frac{N_1}{N_2} \right)$$

Law 1b. Pressure or Head is proportional to the square of shaft speed:

$$\frac{H_1}{H_2} = \left( \frac{N_1}{N_2} \right)^2$$

Law 1c. Power is proportional to the cube of shaft speed:

$$\frac{P_1}{P_2} = \left( \frac{N_1}{N_2} \right)^3$$

### Law 2. With shaft speed (N) held constant:

Law 2a. Flow is proportional to impeller diameter:

$$\frac{Q_1}{Q_2} = \left( \frac{D_1}{D_2} \right)^3$$

Law 2b. Pressure or Head is proportional to the square of impeller diameter:

$$\frac{H_1}{H_2} = \left( \frac{D_1}{D_2} \right)^2$$

Law 2c. Power is proportional to the cube of impeller diameter:

$$\frac{P_1}{P_2} = \left( \frac{D_1}{D_2} \right)^5$$

where

- $Q$  is the volumetric flow rate (e.g. CFM, GPM or L/s),
- $D$  is the impeller diameter (e.g. in or mm),
- $N$  is the shaft rotational speed (e.g. rpm),
- $H$  is the pressure or head developed by the fan/pump (e.g. ft. or m), and
- $P$  is the shaft power (e.g. W).

These laws assume that the pump/fan efficiency remains constant i.e.  $\eta_1 = \eta_2$ .

When applied to pumps the laws work well for constant diameter variable speed case (Law 1) but are less accurate for constant speed variable impeller diameter case (Law 2).

**Hyperlink to the Glossary and Appendix**

<http://www.abctlc.com/downloads/PDF/PumpGlossary.pdf>



## NPSH - Net Positive Suction Head

A pump creates a partial vacuum and atmospheric pressure forces water into the suction of the pump, and NPSH describes the concept. NPSH(r) is the Net Positive Suction Head Required by the pump, which is read from the pump performance curve. (Think of NPSH(r) as friction loss caused by the entry to the pump suction.)

NPSH (a) is the Net Positive Suction Head Available, which is calculated as follows:

$$\text{NPSH (a)} = p + s - v - f$$

Where:

'p'= atmospheric pressure,

's'= static suction (If liquid is below pump, it is shown as a negative value)

'v'= liquid vapor pressure

'f'= friction loss

NPSH (a) must exceed NPSH(r) to allow pump operation without cavitation. (It is advisable to allow approximately 1 meter difference for most installations.) The other important fact to remember is that water will boil at much less than 100 deg C<sup>o</sup> if the pressure acting on it is less than its vapor pressure, i.e. water at 95 deg C is just hot water at sea level, but at 1500m above sea level it is boiling water and vapor.

The vapor pressure of water at 95 degrees C is 84.53 kPa, there was enough atmospheric pressure at sea level to contain the vapor, but once the atmospheric pressure is dropped at a higher elevation, the vapor is able to escape. This is why vapor pressure is always considered in NPSH calculations when temperatures exceed 30 to 40 degrees C.

## Suction Lift

Suction conditions are some of the most important factors affecting centrifugal pump operation. If they are ignored during the design or installation stages of an application, they will probably come back to haunt you.

A pump cannot pull or "suck" a liquid up its suction pipe because liquids do not exhibit tensile strength. Therefore, they cannot transmit tension or be pulled. When a pump creates a suction, it is simply reducing local pressure by creating a partial vacuum. Atmospheric or some other external pressure acting on the surface of the liquid pushes the liquid up the suction pipe into the pump.

Atmospheric pressure at sea level is called absolute pressure (PSIA) because it is a measurement using absolute zero (a perfect vacuum) as a base. If pressure is measured using atmospheric pressure as a base it is called gauge pressure (PSIG or simply PSI).

Atmospheric pressure, as measured at sea level, is 14.7 PSIA. In feet of head it is:

$$\text{Head} = \text{PSI} \times 2.31 / \text{Specific Gravity}$$

**For Water it is:**

$$\text{Head} = 14.7 \times 2.31 / 1.0 = 34 \text{ Ft}$$

Thus, 34 feet is the theoretical maximum suction lift for a pump pumping cold water at sea level. No pump can attain a suction lift of 34 ft; however, well designed ones can reach 25 ft quite easily.

You will note, from the equation above, that specific gravity can have a major effect on suction lift. For example, the theoretical maximum lift for brine (Specific Gravity = 1.2) at sea level is 28 ft. The realistic maximum is around 20ft. Remember to always factor in specific gravity if the liquid being pumped is anything but clear, cold (68 degrees F) water.

In addition to pump design and suction piping, there are two physical properties of the liquid being pumped that affect suction lift:

**1) Maximum suction lift** is dependent upon the pressure applied to the surface of the liquid at the suction source. Maximum suction lift decreases as pressure decreases.

**2) Maximum suction lift** is dependent upon the vapor pressure of the liquid being pumped. The vapor pressure of a liquid is the pressure necessary to keep the liquid from vaporizing (boiling) at a given temperature. Vapor pressure increases as liquid temperature increases. Maximum suction lift decreases as vapor pressure rises.

It follows then, that the maximum suction lift of a centrifugal pump varies inversely with altitude. Conversely, maximum suction lift will increase as the external pressure on its source increases (for example: a closed pressure vessel).

## **Cavitation - Two Main Causes:**

A. NPSH (r) EXCEEDS NPSH (a)

Due to low pressure the water vaporizes (boils), and higher pressure implodes into the vapor bubbles as they pass through the pump, causing reduced performance and potentially major damage.

B. Suction or discharge recirculation. The pump is designed for a certain flow range, if there is not enough or too much flow going through the pump, the resulting turbulence and vortexes can reduce performance and damage the pump.

## **Affinity Laws**

The Centrifugal Pump is a very capable and flexible machine. Because of this it is unnecessary to design a separate pump for each job. The performance of a centrifugal pump can be varied by changing the impeller diameter or its rotational speed. Either change produces approximately the same results. Reducing impeller diameter is probably the most common change and is usually the most economical. The speed can be altered by changing pulley diameters or by changing the speed of the driver. In some cases both speed and impeller diameter are changed to obtain the desired results.

When the driven speed or impeller diameter of a centrifugal pump changes, operation of the pump changes in accordance with three fundamental laws. These laws are known as the "Laws of Affinity". They state that:

- 1) Capacity varies directly as the change in speed
- 2) Head varies as the square of the change in speed
- 3) Brake horsepower varies as the cube of the change in speed

**If, for example, the pump speed were doubled:**

- 1) Capacity will double
- 2) Head will increase by a factor of 4 (2 to the second power)
- 3) Brake horsepower will increase by a factor of 8 (2 to the third power)

These principles apply regardless of the direction (up or down) of the speed or change in diameter.

Consider the following example.

A pump operating at 1750 RPM, delivers 210 GPM at 75' TDH, and requires 5.2 brake horsepower. What will happen if the speed is increased to 2000 RPM?

First we find the speed ratio.

$$\text{Speed Ratio} = 2000/1750 = 1.14$$

**From the Laws of Affinity:**

1) Capacity varies directly or:  
 $1.14 \times 210 \text{ GPM} = 240 \text{ GPM}$

2) Head varies as the square or:  
 $1.14 \times 1.14 \times 75 = 97.5' \text{ TDH}$

3) BHP varies as the cube or:  
 $1.14 \times 1.14 \times 1.14 \times 5.2 = 7.72 \text{ BHP}$

Theoretically the efficiency is the same for both conditions. By calculating several points a new curve can be drawn.

Whether it be a speed change or change in impeller diameter, the Laws of Affinity give results that are approximate.

The discrepancy between the calculated values and the actual values obtained in test are due to hydraulic efficiency changes that result from the modification.

The Laws of Affinity give reasonably close results when the changes are not more than 50% of the original speed or 15% of the original diameter.

## Affinity Laws - Centrifugal Pumps

If the speed or impeller diameter of a pump changes, we can calculate the resulting performance change using:

### Affinity laws

- The flow changes proportionally to speed  
i.e.: double the speed / double the flow
- The pressure changes by the square of the difference  
i.e.: double the speed / multiply the pressure by 4
- The power changes by the cube of the difference  
i.e.: double the speed / multiply the power by 8

## Pump Performance and Curves

Let's look at the big picture. Before you make that purchase of the pump and motor you need to know the basics such as:

- Total dynamic head, the travel distance
- Capacity, how much water you need to provide
- Efficiency, help determine the impeller size
- HP, how many squirrels you need
- RPM, how fast the squirrels run

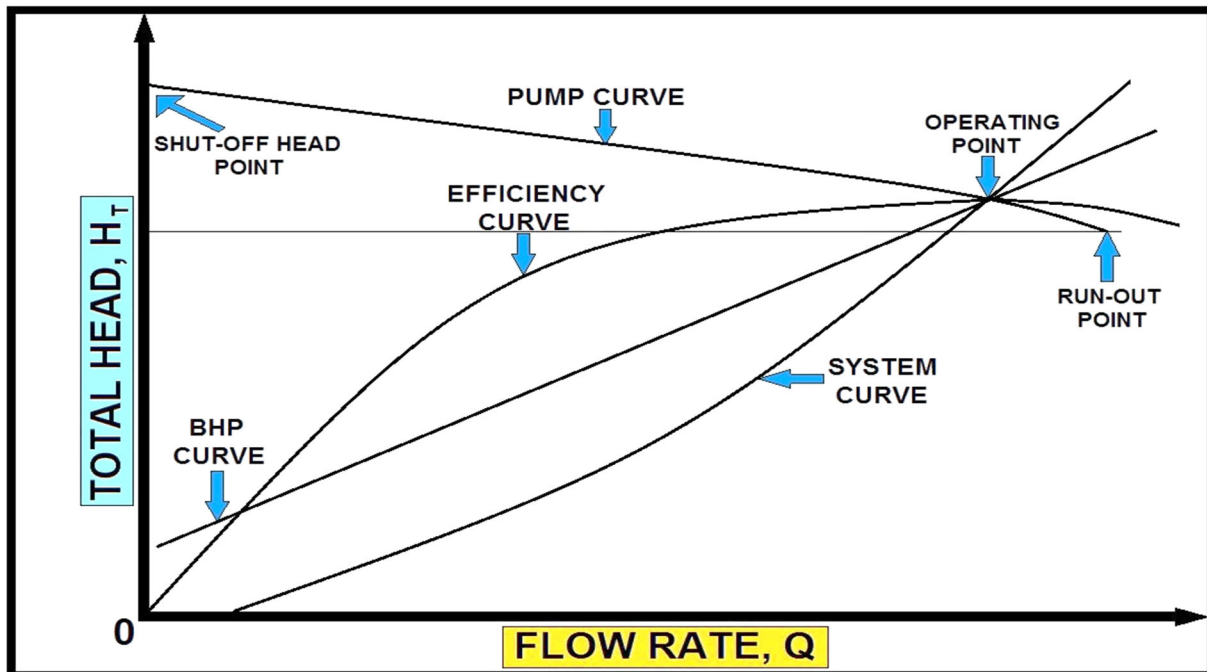

**PUMP PERFORMANCE CURVE (CENTRIFUGAL PUMP)**

## Motor and Pump Calculations Defined

### Discharge head defined.

It is the vertical distance between the intake level of a water pump and the level at which it discharges water freely to the atmosphere. The energy per unit weight of fluid on the discharge side of a pump.

The centrifugal pump pumps the difference between the suction and the discharge heads. There are three kinds of discharge head:

- **Static head.** The height we are pumping to, or the height to the discharge piping outlet that is filling the tank from the top. Note: that if you are filling the tank from the bottom, the static head will be constantly changing.
- **Pressure head.** If we are pumping to a pressurized vessel - like a boiler- we must convert the pressure units (psi. or Kg.) to head units (feet or meters).
- **System or dynamic head.** Caused by friction in the pipes, fittings, and system components. We get this number by making the calculations from published charts.

### Suction head is measured the same way.

- If the liquid level is above the pump center line, that level is a positive suction head. If the pump is lifting a liquid level from below its center line, it is a negative suction head.
- If the pump is pumping liquid from a pressurized vessel, you must convert this pressure to a positive suction head. A vacuum in the tank would be converted to a negative suction head.
- Friction in the pipes, fittings, and associated hardware is a negative suction head.
- Negative suction heads are added to the pump discharge head; positive suction heads are subtracted from the pump discharge head.

**Total Dynamic Head (TDH)** is the total height that a fluid is to be pumped, taking into account friction losses in the pipe.

$$\text{TDH} = \text{Static Lift} + \text{Static Height} + \text{Friction Loss}$$

where:

*Static Lift* is the height the water will rise before arriving at the pump (also known as the 'suction head').

*Static Height* is the maximum height reached by the pipe after the pump (also known as the 'discharge head').

*Friction Loss* is the head equivalent to the energy losses due to viscous drag of fluid flowing in the pipe (both on the suction and discharge sides of the pump). It is calculated via a formula or a chart, taking into account the pipe diameter and roughness and the fluid flow rate, density, and viscosity.

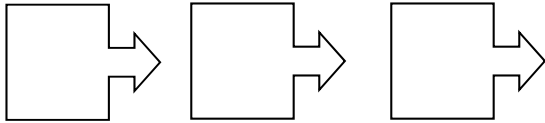

**Motor hp**

**Brake hp**

**Water hp**

### **Horsepower**

Horsepower (hp) is a unit of measurement of power (the rate at which work is done). There are many different standards and types of horsepower. The term was adopted in the late 18th century by Scottish engineer James Watt to compare the output of steam engines with the power of draft horses.

Work involves the operation of force over a specific distance. The rate of doing work is called power. The rate in which a horse could work was determined to be about 550 ft-lbs/sec or 33,000 ft-lbs/min.

1 hp = 33,000 ft-lbs/min

### **Motor Horsepower (mhp)**

1 hp = 746 watts or .746 Kilowatts

MHP refers to the horsepower supplied in the form of electrical current. The efficiency of most motors range from 80-95%. (Manufactures will list efficiency %)

### **Brake Horsepower (bhp)**

$$\text{Brake hp} = \frac{\text{Water hp}}{\text{Pump Efficiency}}$$

BHP refers to the horsepower supplied to the pump from the motor. As the power moves through the pump, additional horsepower is lost, resulting from slippage and friction of the shaft and other factors. Brake refers to the device which was used to load an engine and hold it at a desired rotational speed. During testing, the output torque and rotational speed were measured to determine the brake horsepower. Horsepower was originally measured and calculated by use of the "indicator diagram" (a James Watt invention of the late 18th century), and later by means of a Prony brake connected to the engine's output shaft. Lately, an electrical brake dynamometer is used instead of a Prony brake. Although the output delivered to the drive wheels is less than that obtainable at the engine's crankshaft, use of a chassis dynamometer gives an indication of an engine's "real world" horsepower after losses in the drive train and gearbox

## Water Horsepower

$$\text{Water hp} = \frac{(\text{flow gpm})(\text{total hd})}{3960}$$

Water horsepower refers to the actual horse power available to pump the water.

## Horsepower and Specific Gravity

The specific gravity of a liquid is an indication of its density or weight compared to water. The difference in specific gravity, include it when calculating ft-lbs/min pumping requirements.

$$\frac{(\text{ft})(\text{lbs/min})(\text{sp.gr.})}{33,000 \text{ ft-lbs/min/hp}} = \text{whp}$$

## MHP and Kilowatt Requirements

$$1 \text{ hp} = 0.746 \text{ kW} \text{ or } \frac{(\text{hp}) (746 \text{ watts/hp})}{1000 \text{ watts/kW}}$$

## Hyperlink to the Glossary and Appendix

<http://www.abctlc.com/downloads/PDF/PumpGlossary.pdf>

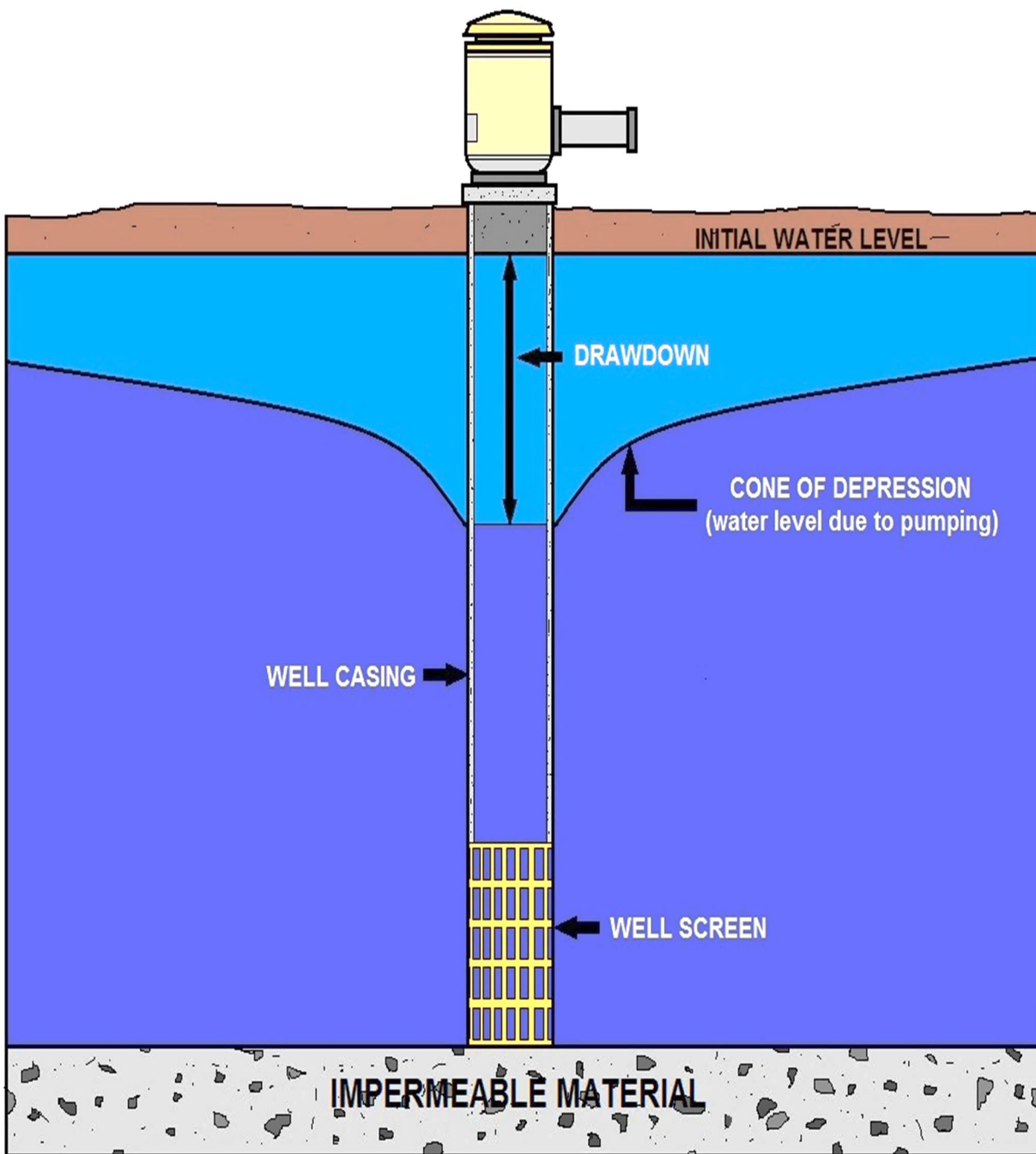

**CONE OF DEPRESSION CAUSED BY WATER PUMPING DIAGRAM**



# Well Calculations

## 1. Well drawdown

Drawdown ft = Pumping water level, ft - Static water level, ft

## 2. Well yield

Well yield, gpm =  $\frac{\text{Flow, gallons}}{\text{Duration of test, min}}$

## 3. Specific yield

Specific yield, gpm/ft =  $\frac{\text{Well yield, gpm}}{\text{Drawdown, ft}}$

## 4. Deep well turbine pump calculations.

Discharge head, ft = (pressure measured) (2.31 ft/psi)

Field head, ft = pumping water + discharge head, ft

Bowl head, ft = field head + column friction

1 psi = 2.31 feet of head

1 foot of head = .433 psi

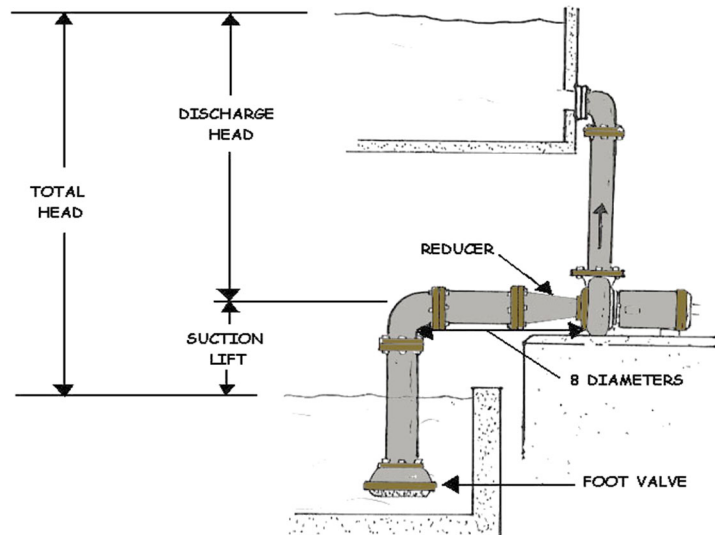

### Example 1

A centrifugal pump is located at an elevation of 722 ft. This pump is used to move water from reservoir **A** to reservoir **B**. The water level in reservoir **A** is 742 ft and the water level in reservoir **B** is 927 ft. Based on these conditions answer the following questions:

- 1. If the pump is not running and pressure gauges are installed on the suction and discharge lines, what pressures would the gauges read?**

Suction side:

Discharge side:

- 2. How can you tell if this is a suction head condition?**

- 3. Calculate the following head measurements:**

SSH:

SDH:

TSH:

- 4. Convert the pressure gauge readings to feet:**

6 psi:

48 psi:

110 psi:

- 5. Calculate the following head in feet to psi:**

20 ft:

205 ft:

185 ft:

## Pump Operation and Performance Post Quiz

1. What term is used to express the rate of flow of a pump is the total volume throughput per unit of time at suction conditions?
2. What term is used to express the pressure above zero absolute, i.e. the sum of atmospheric and gauge pressure. In vacuum related work it is usually expressed in millimeters of mercury?
3. What term is used to express how much suction lift a pump can achieve by creating a partial vacuum?
4. What term is used to express the amount of pressure / head required to 'force' liquid through pipe and fittings?
5. What term is used to express the energy content of a liquid in reference to an arbitrary datum?
6. What term is used to express the head required to overcome the friction at the interior surface of a conductor and between fluid particles in motion?
7. What term is used to express the height of a column or body of fluid above a given point?
8. What term is used to express the single-stage axial flow helix installed in the suction eye of an impeller to lower the NPSHR?
9. What term is used to express the bladed member of a rotating assembly of the pump which imparts the principal force to the liquid pumped?
10. What term is used to express the pressure applied to a confined fluid at rest is transmitted with equal intensity throughout the fluid?

**Answers** 1. Rate of Flow [Q], 2. Pressure, Absolute, 3. NPSH, 4. Friction Loss, 5. Head (h) [H]  
6. Head, Friction, 7. Head, Static, 8. Inducer, 9. Impeller, 10. Pascal's Law

## Pump Operation and Performance References

- "A High-Quality Digital X-Y Plotter Designed for Reliability, Flexibility and Low Cost". Hewlett-Packard Journal. <http://www.hpl.hp.com/hpjournal/pdfs/IssuePDFs/1979-02.pdf>.
- "A.O.Smith: The AC's and DC's of Electric Motors" (PDF).  
<http://www.aosmithmotors.com/uploadedFiles/AC-DC%20manual.pdf>.
- "Certified Power - SAE J1349 Certified Power SAE International". Sae.org.
- "Cobham plc :: Aerospace and Security, Aerospace Communications, Annemasse". Cobham.com. 2011-02-13. <http://www.cobham.com/about-cobham/aerospace-and-security/about-us/aerospace-communications/annemasse.aspx>.
- "Council Directive 71/354/EEC: On the approximation of the laws of the Member States relating to units of measurement". The Council of the European Communities. 18 October 1971.
- "Die gesetzlichen Einheiten in Deutschland" [List of units of measure in Germany] (PDF) (in German). Physikalisch-Technische Bundesanstalt (PTB). p. 6.
- "Directive 2009/3/EC of the European Parliament and of the Council of 11 March 2009", Official Journal of the European Union.
- "Encyclopædia Britannica, "Galileo Ferraris"".  
<http://www.britannica.com/EBchecked/topic/204963/Galileo-Ferraris>.
- "Frequently Asked Slip Ring Questions". Moog.com.  
<http://www.moog.com/products/slip-rings/slip-rings-faq-s/>.
- "Galileo Ferraris". <http://profiles.incredible-people.com/galileo-ferraris/>.
- "Horsepower", Encyclopædia Britannica Online.
- "how slip rings work". Uea-inc.com. <http://www.uea-inc.com/products/slip-rings/how-they-work.aspx>.
- "Hydraulic Horsepower". Oilfield Glossary. Schlumberger.
- "International System of Units" (SI), Encyclopædia Britannica Online.
- "Math Words — horsepower". pballew.net.
- "Measurements, Units of Measurement, Weights and Measures". numericana.com.
- "Scientists model "extraordinary" performance of Bolt". Institute of Physics.
- "Slip Ring Connector - SenRing Electronics". Senring.com. <http://www.senring.com/hnr67.html>.
- "The miner's friend". Rochester history department website
- ^ Heywood, J.B. "Internal Combustion Engine Fundamentals", ISBN 0-07-100499-8, page 54
- ^ Robert McCain Johnston Elements of Applied Thermodynamics, Naval Institute Press, 1992 ISBN 1557502269, p. 503.
- Alan Hendrickson, Colin Buckhurst Mechanical design for the stage Focal Press, 2008 ISBN 0-240-80631-X, page 379 with an illustration of pancake and drum-type slip rings.
- B. R. Pelly, "Thyristor Phase-Controlled Converters and Cycloconverters: Operation, Control, and Performance" (New York: John Wiley, 1971).
- Bakshi U.A. and Bakshi V.U. Basics of Electrical Engineering. Technical Publications Pune. 2008.
- Bakshi U.A., Godse and Bakshi M.V. Electrical Machines and Electronics. Technical Publications Pune, 2009.
- Bedford, B. D.; Hoft, R. G. et al. (1964). Principles of Inverter Circuits. New York: John Wiley & Sons, Inc.. ISBN 0-471-06134-4. (Inverter circuits are used for variable-frequency motor speed control)
- Bishop, Robert H., Ed. The Mechatronics Handbook, ISA—The Instrumentation, Systems and Automation Society, CRC Press, 2002.
- Breen, Jim (2003-03-22). "Farmers Journal: Tractor and machine comparison: what's the 'true' measure - 22 March 2003". Farmersjournal.ie.

Briere D. and Traverse, P. (1993) "Airbus A320/A330/A340 Electrical Flight Controls: A Family of Fault-Tolerant Systems" Proc. FTCS, pp. 616–623.

Brown, David K (1990), *Before the ironclad*, Conway, p. 188, ISBN 0851775322

Brumbach Michael E. *Industrial Electricity*. Thomson Delmar Learning

Collins, EV; Caine, AB (1926). "Testing Draft Horses". *Iowa Agricultural Experiment Station Bulletin*. 240: 193–223.

Coon, Brett A. Handley, David M. Marshall, Craig (2012). *Principles of engineering*. Clifton Park, N.Y.: Delmar Cengage Learning. p. 202. ISBN 978-1-435-42836-2.

Cyril W. Lander, *Power Electronics 3rd Edition*, McGraw Hill International UK Limited, London 1993 ISBN 0-07-707714-8 Chapter 9–8 Slip Ring Induction Motor Control

Deshpande, M.V. *Electric Motors: Application and Control*. PHI Learning Private Ltd., 2010.

Donald G. Fink and H. Wayne Beatty, *Standard Handbook for Electrical Engineers*, Eleventh Edition, McGraw-Hill, New York, 1978, ISBN 0-07-020974-X.

Ebert, TR (Dec 2006). "Power output during a professional men's road-cycling tour". *International Journal of Sports Physiology and Performance*: 324–325. PMID 19124890.

ECE Regulation 24, Revision 2, Annex 10

Edwin J. Houston and Arthur Kennelly, *Recent Types of Dynamo-Electric Machinery*, copyright American Technical Book Company 1897, published by P.F. Collier and Sons New York, 1902

Electric motors use 60% of china's electric energy, for example

Electricity and magnetism, translated from the French of Amédée Guillemin. Rev. and ed. by Silvanus P. Thompson. London, MacMillan, 1891

Eugene A. Avallone et. al, (ed), *Marks' Standard Handbook for Mechanical Engineers 11th Edition*, Mc-Graw Hill, New York 2007 ISBN 0-07-142867-4 page 9-4

Faraday, Michael (1844). *Experimental Researches in Electricity*. 2. See plate 4.

Fitzgerald/Kingsley/Kusko (Fitzgerald/Kingsley/Umans in later years), *Electric Machinery*, classic text for junior and senior electrical engineering students. Originally published in 1952, 6th edition published in 2002.

Ganot's *Physics*, 14th Edition, N.Y., 1893 translated by Atkinson, pp. 907 and 908. (Section 899, and Figure 888).

Garrison, Ervan G., "A history of engineering and technology". CRC Press, 1998. ISBN 0-8493-9810-X, 9780849398100. Retrieved May 7, 2009.

Gee, William (2004). "Sturgeon, William (1783–1850)". *Oxford Dictionary of National Biography*. Oxford, England: Oxford University Press. doi:10.1093/ref:odnb/26748.

Gill, Paul. *Electrical Power Equipment Maintenance and Testing*. CRC Press: Taylor & Francis Group, 2009.

H. Wayne Beatty, *Handbook of Electric Power Calculations Third Edition*, McGraw Hill 2001, ISBN 0-07-136298-3, page 6-14

Hart-Davis, Adam, *Engineers*, pub Dorling Kindersley, 2012, p121.

Herman, Stephen L. *Electric Motor Control*. 6<sup>th</sup> and 9<sup>th</sup> ed. Delmar Cengage Learning, 2010.

Hodgson, Richard. "The RAC HP (horsepower) Rating - Was there any technical basis?". [wolfhound.org.uk](http://wolfhound.org.uk).

[http://books.google.it/books?id=CxQdC6xPFSwC&pg=PA45&lpg=PA45&dq=GALILEO+FERRARIS+AC+MOTOR+INVENTION&source=web&ots=jjeS-hcv2T&sig=cYbNfNNeVwvMIhR-JCP8uReedRU&hl=it&sa=X&oi=book\\_result&resnum=1&ct=result#v=onepage&q&f=false](http://books.google.it/books?id=CxQdC6xPFSwC&pg=PA45&lpg=PA45&dq=GALILEO+FERRARIS+AC+MOTOR+INVENTION&source=web&ots=jjeS-hcv2T&sig=cYbNfNNeVwvMIhR-JCP8uReedRU&hl=it&sa=X&oi=book_result&resnum=1&ct=result#v=onepage&q&f=false).

<http://www.circuitcellar.com/> Motor Comparison, *Circuit Cellar Magazine*, July 2008, Issue 216, Bachiochi, p.78

<http://www.daytronic.com/products/trans/t-magpickup.htm>

<http://www.electronicweekly.com/Articles/2010/08/13/46377/dyson-vacuums-104000rpm-brushless-dc-technology.htm>

<http://www.frankfurt.matav.hu/angol/magyatud.htm>

<http://www.mpoweruk.com/history.htm>  
<http://www.mpoweruk.com/timeline.htm>  
<http://www.physics.umd.edu/lecdem/services/demos/demosk4/k4-21.gif>  
<http://www.traveltohungary.com/english/articles/article.php?id=135>  
 Hughes, Austin. *Electric Motors and Drives: fundamentals, types and applications*. 3rd ed. Linacre House, 2006.  
 Irwin, David J., Ed. *The Industrial Electronics Handbook*. CRC Press: IEEE Press, 1997.  
 Jeff Plungis, *Asians Oversell Horsepower*, Detroit News  
 Jiles, David. *Introduction to Magnetism and Magnetic Materials*. CRC Press: Taylor Francis Group, 1998.  
 John N. Chiasson, *Modeling and High Performance Control of Electric Machines*, Wiley-IEEE Press, New York, 2005, ISBN 0-471-68449-X.  
 Kirby, Richard Shelton (August 1, 1990). "Engineering in History". Dover Publications: 171. ISBN 0-486-26412-2.  
 Kuphaldt, Tony R. (2000–2006). "Chapter 13 AC MOTORS". *Lessons In Electric Circuits—Volume II*. [http://www.ibiblio.org/obp/electricCircuits/AC/AC\\_13.html](http://www.ibiblio.org/obp/electricCircuits/AC/AC_13.html). Retrieved 2006-04-11.  
 Laughton M.A. and Warne, D.F., Eds. *Electrical Engineer's Reference Book*. 16th ed. Elsevier Science, 2003.  
 linear Electric Machines- A Personal View - Eric R. Laithwaite, *Proceedings of the IEEE*, Vol. 63, No. 2, February 1975 page 250  
 Lucchesi, Domenico (2004). *Corso di tecnica automobilistica*, vol. 1°—Il motore (in Italian) (6th ed.). Ulrico Hoepli Editore S.p.A. p. 550. ISBN 88-203-1493-2.  
 Marshall, Brian. "How Horsepower Works".  
 Miller, Rex and Mark R. Miller, *Industrial Electricity and Motor Controls*. McGraw Hill, 2008.  
 Mooney, Dan. "The XK engine by Roger Bywater". *Classicjaguar.com*. Archived from the original on 2010-02-23.  
 Nature 53. (printed in 1896) page: 516  
 Neidhöfer, Gerhard. [<http://www.ieee.org/organizations/pes/public/2007/sep/peshistory.html> "Early Three-Phase Power Winner in the development of polyphase ac"].  
<http://www.ieee.org/organizations/pes/public/2007/sep/peshistory.html>.  
 North, David. (2000) "Finding Common Ground in Envelope Protection Systems". *Aviation Week & Space Technology*, Aug 28, pp. 66–68.  
 Oxford Dictionary. Retrieved 2016-12-06. *Dictionary.com Unabridged*, Random House Inc.  
 Pansini, Anthony, J (1989). *Basic of Electric Motors*. Pennwell Publishing Company. p. 45. ISBN 0-13-060070-9.  
 Patrick, Dale R. and Fardo, Stephen W. *Electrical Distribution Systems*. 2nd ed. The Fairmont Press, 2009.  
 Patrick, Dale R. and Stephen W. Fardo. *Rotating Electrical Machines and Power Systems*. 2nd ed. The Fairmont Press, 1997.  
 Patrick, Dale R; Fardo, Stephen W., *Rotating Electrical Machines and Power Systems* (2nd Edition)1997 Fairmont Press, Inc. ISBN 978-0-88173-239-9 chapter 11  
 Peter W. Fortescue, John Stark, Graham Swinerd *Spacecraft systems engineering* John Wiley and Sons, 2003 ISBN 0-470-85102-3  
 Popular Mechanics. September 1912, page 394  
 Rajput R.K. *Basic Electrical and Electronics Engineering*. Laxmi Publications Ltd., 2007.  
 Resenblat & Frienman *DC and AC machinery*  
 Schoenherr, Steven F. (2001), "Loudspeaker History". *Recording Technology History*. Retrieved 2010-03-13.  
  
 Shanefield D. J., *Industrial Electronics for Engineers, Chemists, and Technicians*, William Andrew Publishing, Norwich, NY, 2001.

Singh, Yaduvir Dr. and Verma M. Fundamentals of Electrical Engineering. University Science Press, 2010.

Sivanagaraju S., Reddy and Prasad. Power Semiconductor Drives. PHI Learning Private Ltd., 2009.

Slow Speed Torque Drive Units

Stevenson, R. D.; Wassersug, R. J. (1993). "Horsepower from a horse". Nature. 364 (6434): 195. Bibcode:1993Natur.364..195S. doi:10.1038/364195a0.

Subrahmanyam, V., Electric Drives: Concepts and Applications. 2nd ed. Tata McGraw Hill, 2011.

The "Goodness" of Small Contemporary Permanent Magnet Electric Machines - D J Patterson, C W Brice, R A Dougal, D Kovuri

Tokai University Unveils 100W DC Motor with 96% Efficiency  
[http://techon.nikkeibp.co.jp/english/NEWS\\_EN/20090403/168295/](http://techon.nikkeibp.co.jp/english/NEWS_EN/20090403/168295/)

Toliyat, Hamid A. and Kliman G.B. Handbook of Electric Motors. Marcel Dekker, Inc., 2004.

Tully, Jim (September 2002). "Philadelphia Chapter Newsletter". American Society of Mechanical Engineers. Archived from the original on 2007-08-13. Retrieved 2007-08-11.

US Department of Energy indicates over half US electricity generation is used by electric motors

Wayne Saslow. Electricity, Magnetism and Light. Thomson Learning Inc., 2002.

White, William Henry (1882), A Manual of Naval Architecture (2 ed.), John Murray, p. 520



## Section 9 - Motor-Pump Coupling Section

**Section Focus:** You will learn the basics of motor to pump coupling. At the end of this section, you will be able to describe various pump/motor connections and troubleshooting procedures. There is a post quiz at the end of this section to review your comprehension and a final examination in the Assignment for your contact hours.

**Scope/Background:** All motors and pumps have various and difficult methods or devices of connection and abilities to transfer electro-mechanical power. Motor-Pump alignment is the process of aligning shaft centerlines between a motor and a pump. The motor is the prime mover, transferring power to the pump by the use of a coupling.

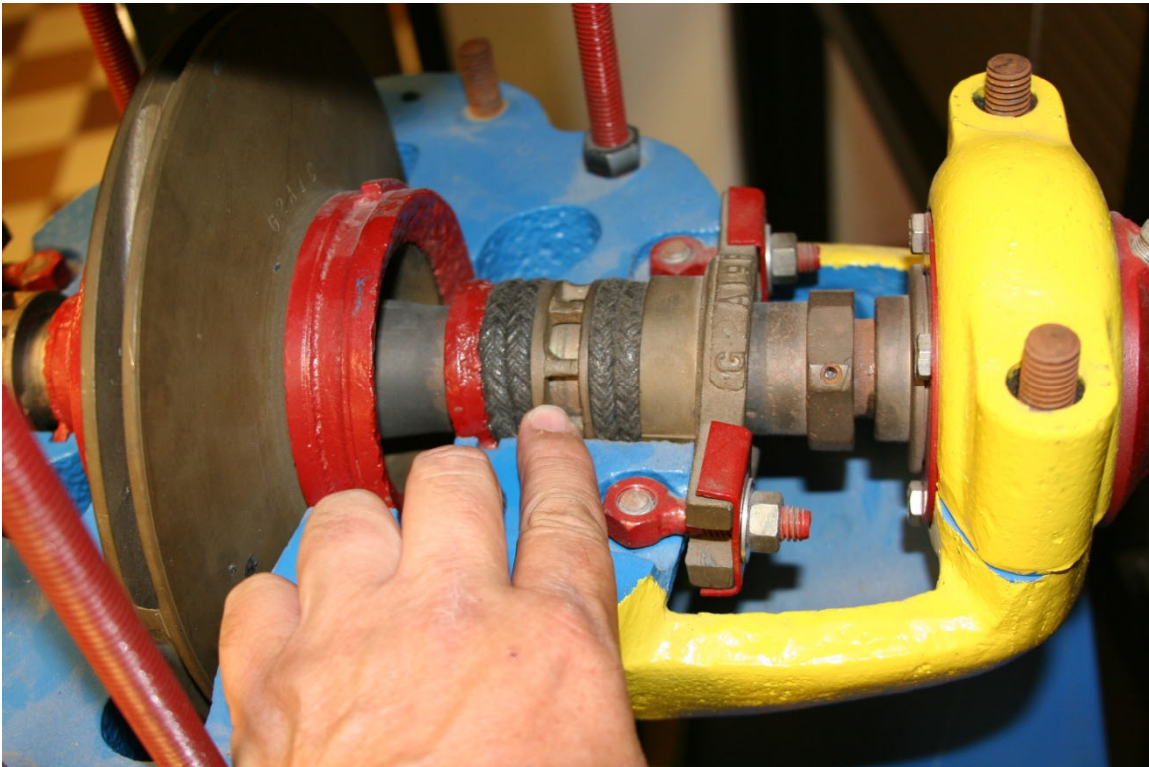

Finger is shown pointing to a Lantern Ring. Notice the packing on both sides of the ring. The packing joints need to be staggered and the purpose of this device is to allow air to the Stuffing Box.

Motor-Pump alignment should be an important part of any maintenance program. Most pump distress events or failures) have their root cause in the misalignment of the pump to motor. Misaligned pumps can even consume up to 15% more energy input than well-aligned pumps.

Even small pumps can generate big losses when shaft misalignment imposes reaction forces on shafts, even if the flexible coupling suffers no immediate damage. The inevitable result is premature failure of shaft seals and bearings.

Performing precise alignment, therefore, pays back through preventing the costly consequences of poor alignment. Indeed, using precise alignment methods is one of the principal attributes of a reliability focused organization.

Good alignment has been demonstrated to lead to:

- Lower energy losses due to friction and vibration
- Increased productivity through time savings and repair avoidance
- Reduced parts expense and lower inventory requirements

Further, in order to insure good alignment, the alignment must be checked and correctly set when:

- A pump and drive unit are initially installed (before grouting the baseplate, after grouting the baseplate, after connecting the piping, and after the first run).
- After a unit has been serviced.
- The process operating temperature of the unit has changed.
- Changes have been made to the piping system.
- Periodically, as a preventive maintenance check of the alignment, following the plant operating procedures for scheduled checks or maintenance.

Proper shaft alignment is achieved by moving the motor. The motor is shimmed vertically to achieve the proper elevation to align it to the pump, both parallel (offset) and angular. The motor is then moved horizontally to achieve proper horizontal placement for aligning the shaft centerlines, both parallel and angular. The motor is moved horizontally by the use of jacking bolts, or by the use of pry bars, hammers, or other tools.

Motors are normally easier to move, since the motor is not piped into a process system. A short run of flexible conduit is most often used to run the electrical wiring from a local disconnect, or a rigid conduit, to the motor termination box. This allows for ease of movement of the motor.

Motor-Pump alignment is critical for these reasons:

- It minimizes the forces of misalignment acting upon the bearings and seals of both components.
- It minimizes wear of the coupling.
- It can help reduce energy costs.
- It maximizes the life of the machine components by minimizing wear, increasing time between failures, and reducing vibration.

## Motor-Pump Coupling Sub-Section - Introduction

The pump coupling serves two main purposes:

- It couples or joins the two shafts together to transfer the rotation from motor to impeller.
- It compensates for small amounts of misalignment between the pump and the motor.

Remember that any coupling is a device in motion. If you have a 4-inch diameter coupling rotating at 1800 rpm, its outer surface is traveling about 20 mph. With that in mind, can you think of safety considerations?

There are three commonly used types of couplings: **Rigid, Flexible and V-belts**.

### Rigid Coupling

Rigid couplings are most commonly used on vertically mounted pumps. The rigid coupling is usually specially keyed or constructed for joining the coupling to the motor shaft and the pump shaft. There are two types of rigid couplings: the flanged coupling, and the split coupling.

### Flexible Coupling

The flexible coupling provides the ability to compensate for small shaft misalignments. Shafts should be aligned as close as possible, regardless. The greater the misalignment, the shorter the life of the coupling. Bearing wear and life are also affected by misalignment.

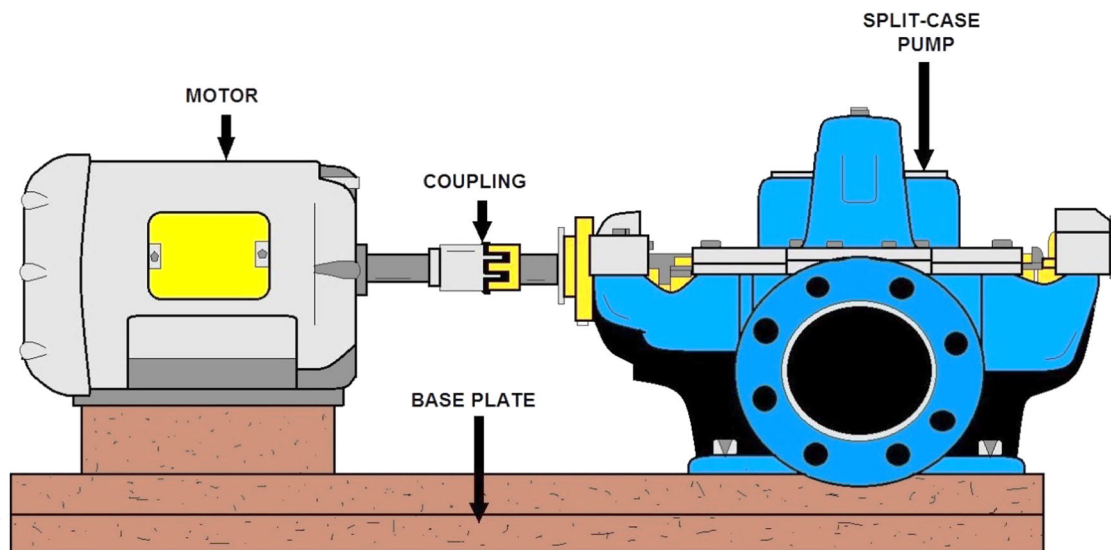

**FLEXIBLE COUPLED PUMP AND MOTOR DIAGRAM**

## Alignment of Flexible and Rigid Couplings

Both flexible and rigid couplings must be carefully aligned before they are connected. Misalignment will cause excessive heat and vibration, as well as bearing wear. Usually, the noise from the coupling will warn you of shaft misalignment problems.

**Three types of shaft alignment problems are shown in the pictures below:**



ANGULAR MISALIGNMENT



ANGULAR AND PARALLEL

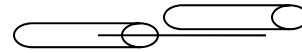

PARALLEL MISALIGNMENT

Different couplings will require different alignment procedures. We will look at the general procedures for aligning shafts.

1. Place the coupling on each shaft.
2. Arrange the units so they appear to be aligned. (Place shims under the legs of one of the units to raise it.)
3. Check the run-out, or difference between the driver and driven unit, by rotating the shafts by hand.
4. Turn both units so that the maximum run-out is on top.

Now you can check the units for both parallel and angular alignment. Many techniques are used, such as: straight edge, needle deflection (dial indicators), calipers, tapered wedges, and laser alignment.

### V-Belt Drive Couplings

V-belt drives connect the pump to the motor. A pulley is mounted on the pump and motor shaft. One or more belts are used to connect the two pulleys. Sometimes a separately mounted third pulley is used. This idler pulley is located off centerline between the two pulleys, just enough to allow tensioning of the belts by moving the idler pulley. An advantage of driving a pump with belts is that various speed ratios can be achieved between the motor and the pump. Alignment is still important, but less critical using v-belts.

### Shaft Bearings

There are three types of bearings commonly used: ball bearings, roller bearings, and sleeve bearings. Regardless of the particular type of bearings used within a system--whether it is ball bearings, a sleeve bearing, or a roller bearing--the bearings are designed to carry the loads imposed on the shaft.

Bearings must be lubricated. Without proper lubrication, bearings will overheat and seize.

Proper lubrication means using the correct type and the correct amount of lubrication. Similar to motor bearings, shaft bearings can be lubricated either by oil or by grease.

## Packing Seals

### How can we prevent the water from leaking along the pump shaft?

A special seal is used to prevent liquid leaking out along the shaft. There are two types of seals commonly used:

- Packing seal
- Mechanical seal

### Packing Seal Leakage

During pump operation, a certain amount of leakage around the shafts and casings normally takes place.

This leakage must be controlled for two reasons:

- (1) to prevent excessive fluid loss from the pump, and
- (2) to prevent air from entering the area where the pump suction pressure is below atmospheric pressure.



The amount of leakage that can occur without limiting pump efficiency determines the type of shaft sealing selected. Shaft sealing systems are found in every pump. They can vary from simple packing to complicated sealing systems.

Packing is the most common and oldest method of sealing. Leakage is checked by the compression of packing rings that causes the rings to deform and seal around the pump shaft and casing.

The packing is lubricated by liquid moving through a lantern ring in the center of the packing. The sealing slows down the rate of leakage. It does not stop it completely, since a certain amount of leakage is necessary during operation.

Mechanical seals are rapidly replacing conventional packing on centrifugal pumps.

### ***Some of the reasons for the use of mechanical seals are as follows:***

- 1. Leaking causes bearing failure by contaminating the oil with water. This is a major problem in engine-mounted water pumps.*
2. Properly installed mechanical seals eliminate leakoff on idle (vertical) pumps. This design prevents the leak (water) from bypassing the water flinger and entering the lower bearings. Leakoff causes two types of seal leakage:
  - a. Water contamination of the engine lubrication oil.
  - b. Loss of treated fresh water that causes scale buildup in the cooling system.

Centrifugal pumps are versatile and have many uses. This type of pump is commonly used to pump all types of water and wastewater flows, including thin sludge.

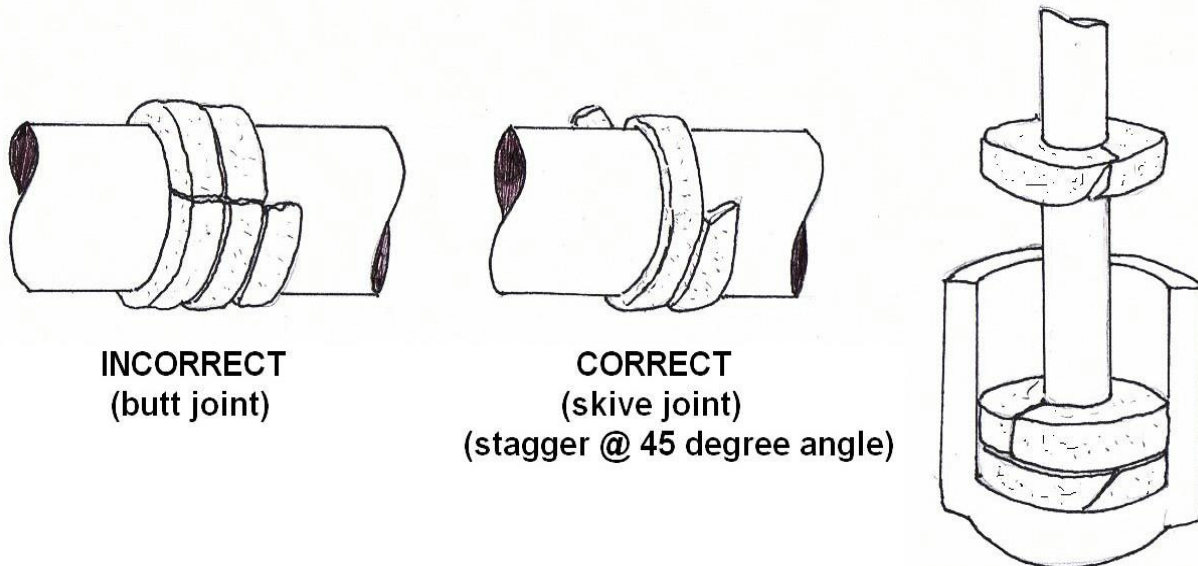

**Skive Packing Procedure**

**Install one ring at a time:** Make sure it is clean, and has not picked up any dirt in handling. If desired, lubricate the shaft inside of the stuffing box. Seat rings firmly (except PTFE filament and Graphite yarn packing, which should be snugged up very gently, then tightened gradually after the pump is on stream). Joints of successive rings should be staggered and kept at least 90° apart. Each individual ring should be firmly seated with a tamping tool. When enough rings have been individually seated so that the nose of the gland will reach them, individual tamping should be supplemented by the gland.

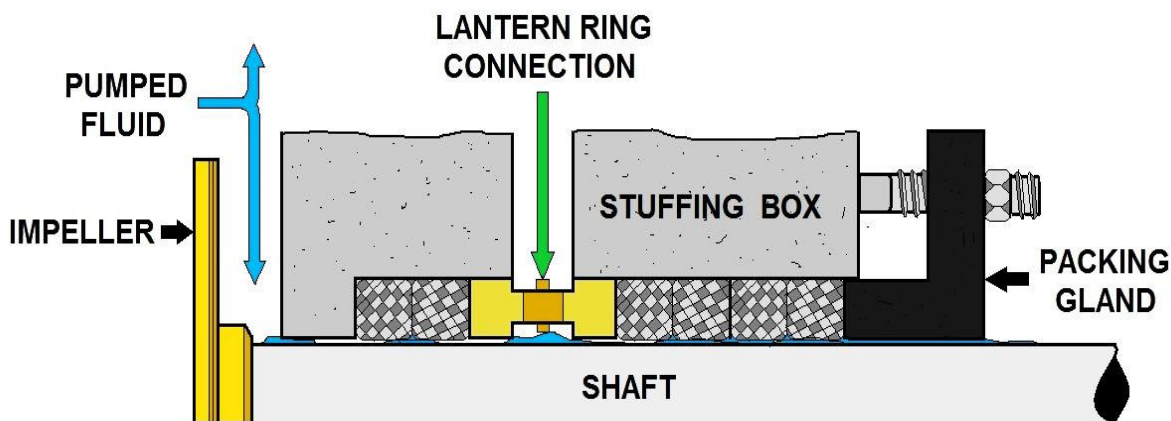

**LANTERN RING BETWEEN PACKING FOR COOL / CLEAN FLUID BARRIER**



Finger is shown pointing to a Lantern Ring. This old school method of sealing a pump is still out there. Notice the packing on both sides of the ring. The packing joints need to be staggered and the purpose of this device is to allow pressurized cooling water to the Stuffing Box.

### **Lantern Rings**

Lantern rings are used to supply clean water along the shaft. This helps to prevent grit and air from reaching the area. Another component is the slinger ring. The slinger ring is an important part of the pump because it is used to protect the bearings. Other materials can be used to prevent this burier.





## Mechanical Seals

Mechanical seals are commonly used to reduce leakage around the pump shaft. There are many types of mechanical seals. The photograph below illustrates the basic components of a mechanical seal. Similar to the packing seal, clean water is fed at a pressure greater than that of the liquid being pumped. There is little or no leakage through the mechanical seal. The wearing surface must be kept extremely clean. Even fingerprints on the wearing surface can introduce enough dirt to cause problems.



**What care should be taken when storing mechanical seals?**



Mechanical Seals

## Wear Rings

Not all pumps have wear rings. However, when they are included, they are usually replaceable. Wear rings can be located on the suction side and head side of the volute. Wear rings could be made of the same metal but of different alloys. The wear ring on the head side is usually a harder alloy.

It's called a "**WEAR RING**" and what would be the purpose?

## Mechanical Seals- Detailed

Mechanical seals are rapidly replacing conventional packing as the means of controlling leakage on rotary and positive-displacement pumps.

Mechanical seals eliminate the problem of excessive stuffing box leakage, which causes failure of pump and motor bearings and motor windings.

Mechanical seals are ideal for pumps that operate in closed systems (such as fuel service and air-conditioning, chilled-water, and various cooling systems). They not only conserve the fluid being pumped, but also improve system operation.

The type of material used for the seal faces will depend upon the service of the pump. Most water service pumps use a carbon material for one of the seal faces and ceramic (tungsten carbide) for the other. When the seals wear out, they are simply replaced.

You should replace a mechanical seal whenever the seal is removed from the shaft for any reason, or whenever leakage causes undesirable effects on equipment or surrounding spaces. Do not touch a new seal on the sealing face because body acid and grease or dirt will cause the seal to pit prematurely and leak.

Mechanical shaft seals are positioned on the shaft by stub or step sleeves. Shaft sleeves are chamfered (beveled) on the outboard ends for easy mechanical seal mounting. Mechanical shaft seals serve to ensure that position liquid pressure is supplied to the seal faces under all conditions of operation. They also ensure adequate circulation of the liquid at the seal faces to minimize the deposit of foreign matter on the seal parts.

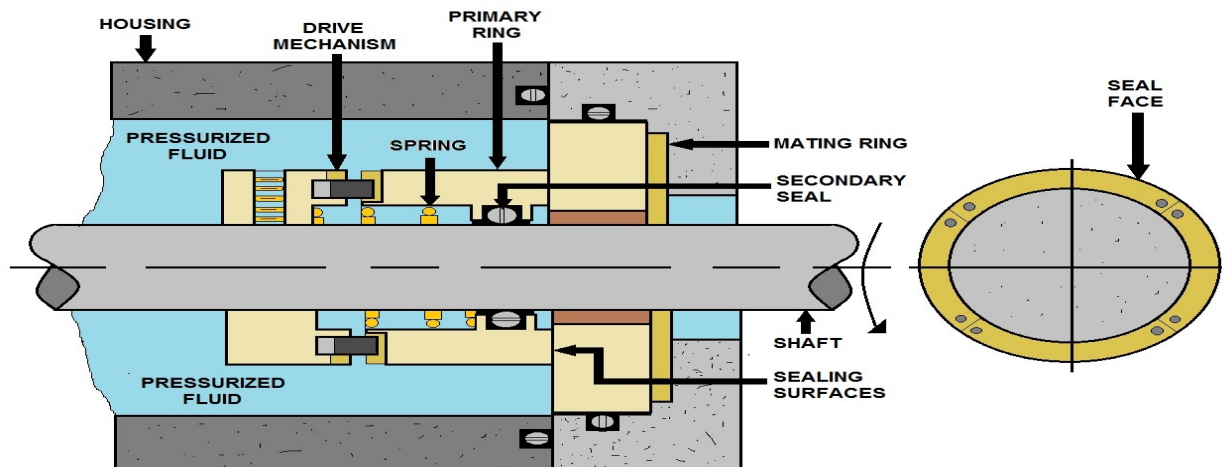

**MECHANICAL SEAL DIAGRAM**

## Pump Operating Problems

If a centrifugal pump **DOES NOT DELIVER ANY LIQUID**, the trouble may be caused by (1) insufficient priming; (2) insufficient speed of the pump; (3) excessive discharge pressure, such as might be caused by a partially closed valve or some other obstruction in the discharge line; (4) excessive suction lift; (5) clogged impeller passages; (6) the wrong direction of rotation (this may occur after motor overhaul); (7) clogged suction screen (if used); (8) ruptured suction line; or (9) loss of suction pressure.

If a centrifugal pump delivers some liquid but operates at **INSUFFICIENT CAPACITY**, the trouble may be caused by (1) air leakage into the suction line; (2) air leakage into the stuffing boxes in pumps operating at less than atmospheric pressure; (3) insufficient pump speed; (4) excessive suction lift; (5) insufficient liquid on the suction side; (6) clogged impeller passages; (7) excessive discharge pressure; or (8) mechanical defects, such as worn wearing rings, impellers, stuffing box packing, or sleeves.

If a pump **DOES NOT DEVELOP DESIGN DISCHARGE PRESSURE**, the trouble may be caused by (1) insufficient pump speed; (2) air or gas in the liquid being pumped; (3) mechanical defects, such as worn wearing rings, impellers, stuffing box packing, or sleeves; or (4) reversed rotation of the impeller (3-phase electric motor-driven pumps).

If a pump **WORKS FOR A WHILE AND THEN FAILS TO DELIVER LIQUID**, the trouble may be caused by (1) air leakage into the suction line; (2) air leakage in the stuffing boxes; (3) clogged water seal passages; (4) insufficient liquid on the suction side; or (5) excessive heat in the liquid being pumped.

If a motor-driven centrifugal pump **DRAWS TOO MUCH POWER**, the trouble will probably be indicated by overheating of the motor. The basic causes may be (1) operation of the pump to excess capacity and insufficient discharge pressure; (2) too high viscosity or specific gravity of the liquid being pumped; or (3) misalignment, a bent shaft, excessively tight stuffing box packing, worn wearing rings, or other mechanical defects.

**VIBRATION** of a centrifugal pump is often caused by (1) misalignment; (2) a bent shaft; (3) a clogged, eroded, or otherwise unbalanced impeller; or (4) lack of rigidity in the foundation. Insufficient suction pressure may also cause vibration and cavitation, as well as noisy operation and fluctuating discharge pressure, particularly in pumps that handle hot or volatile liquids. If the pump fails to build up pressure when the discharge valve is opened and the pump comes up to normal operating speed, proceed as follows:

1. Shut the pump discharge valve.
2. Secure the pump.
3. Open all valves in the pump suction line.
4. Prime the pump (**fill casing with the liquid being pumped**) and be sure that all air is expelled through the air cocks on the pump casing.
5. Restart the pump. If the pump is electrically driven, be sure the pump is rotating in the correct direction.
6. Open the discharge valve to “load” the pump. If the discharge pressure is not normal when the pump is up to its proper speed, the suction line may be clogged, or an impeller may be broken. It is also possible that air is being drawn into the suction line or into the casing. If any of these conditions exist, stop the pump and continue troubleshooting according to the technical manual for that unit.



Some of the operating problems you may encounter with centrifugal pumps as an Operator, together with the probable causes, are discussed in the following pages

## Maintenance of Centrifugal Pumps

When properly installed, maintained and operated, centrifugal pumps are usually trouble-free. Some of the most common preventative and corrective maintenance actions that you may be required to perform are discussed in the following sections.

### Repacking

Lubrication of the pump packing is extremely important. The quickest way to wear out the packing is to forget to open the water piping to the seals or stuffing boxes. If the packing is allowed to dry out, it will score the shaft. When operating a centrifugal pump, be sure there is always a slight trickle of water coming out of the stuffing box or seal. How often the packing in a centrifugal pump should be renewed depends on several factors, such as the type of pump, condition of the shaft sleeve, and hours in use.

To ensure the longest possible service from pump packing, make certain the shaft or sleeve is smooth when the packing is removed from a gland. Rapid wear of the packing will be caused by roughness of the shaft sleeve (or shaft where no sleeve is installed). If the shaft is rough, it should be sent to the machine shop for a finishing cut to smooth the surface. If it is very rough, or has deep ridges in it, it will have to be renewed.

It is absolutely necessary to use the correct packing. When replacing packing, be sure the packing fits uniformly around the stuffing box. If you have to flatten the packing with a hammer to make it fit, **YOU ARE NOT USING THE RIGHT SIZE**. Pack the box loosely, and set up the packing gland lightly. Allow a liberal leak-off for stuffing boxes that operate above atmospheric pressure.

Next, start the pump. Let it operate for about 30 minutes before you adjust the packing gland for the desired amount of leak-off. This gives the packing time to run-in and swell. You may then begin to adjust the packing gland. Tighten the adjusting nuts one flat at a time. Wait about 30 minutes between adjustments. Be sure to tighten the same amount on both adjusting nuts. If you pull up the packing gland unevenly (or cocked), it will cause the packing to overheat and score the shaft sleeves. Once you have the desired leak-off, check it regularly to make certain that sufficient flow is maintained.

### Mechanical Seals

Mechanical seals are rapidly replacing conventional packing as the means of controlling leakage on rotary and positive-displacement pumps. Mechanical seals eliminate the problem of excessive stuffing box leakage, which can cause failures of pump and motor bearings and motor windings. Mechanical seals are ideal for pumps that operate in closed systems (such as fuel service and air-conditioning, chilled-water, and various cooling systems). They not only conserve the fluid being pumped, but also improve system operation.

The type of material used for the seal faces will depend upon the service of the pump. Most water service pumps use a carbon material for one of the seal faces and ceramic (tungsten carbide) for the other. When the seals wear out, they are simply replaced.

You should replace a mechanical seal whenever the seal is removed from the shaft for any reason, or whenever leakage causes undesirable effects on equipment or surrounding spaces.



Do not touch a new seal on the sealing face because body acid and grease or dirt will cause the seal to pit prematurely and leak.

Mechanical shaft seals are positioned on the shaft by stub or step sleeves. Mechanical shaft seals must not be positioned by setscrews. Shaft sleeves are chamfered (beveled) on outboard ends for easy mechanical seal mounting.

Mechanical shaft seals serve to ensure that liquid pressure is supplied to the seal faces under all conditions of operation. They also ensure adequate circulation of the liquid at the seal faces to minimize the deposit of foreign matter on the seal parts.

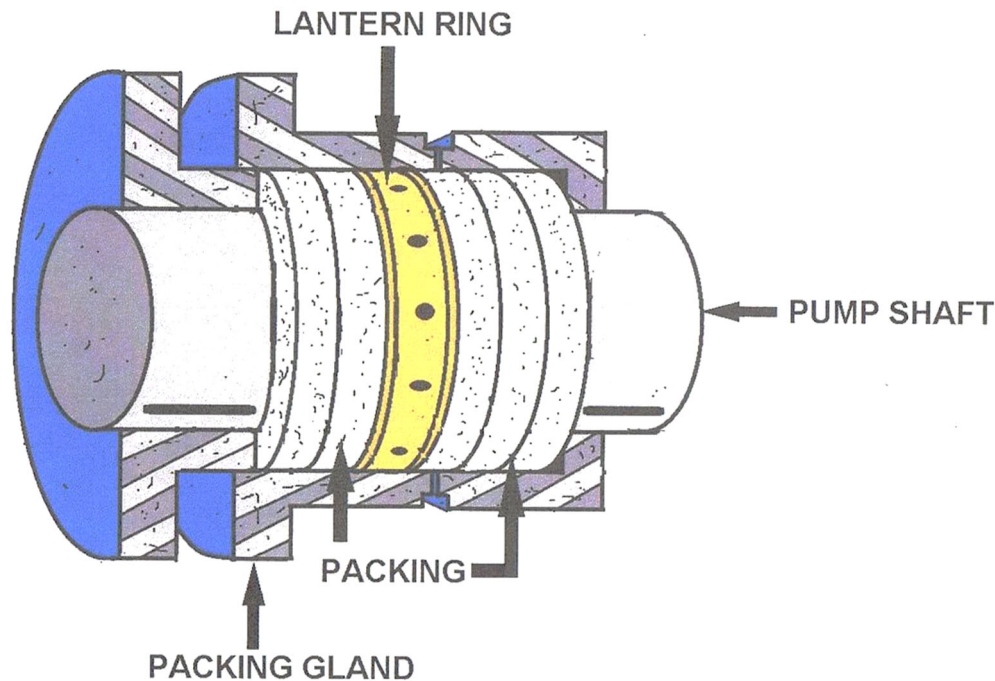

## Choosing Coupling Gaskets

Using a gasket in a coupling that it was not made for is a common cause of leaky gaskets. Get the right gasket and the right kind of gasket for the fitting.

**Flat Gaskets:** Most are made of neoprene and are used on flanged, bolt-together fittings. They are usually not expensive. They normally fail by "creeping" out of their fitting. Look for new neoprene gaskets that contain a cotton backing sandwiched in the gasket to reduce the creeping action.

**Shaped Gaskets:** The three most common materials are styrene-butadiene (SBR), ethylene-propylene (EPDM), and polyethylene (poly). SBR and EPDM have much better resistance to cracking, abrasion, ozone, and weathering resistance than poly gaskets. They are more expensive than poly but will last longer. When buying shaped gaskets look for gaskets that are dull; this indicates that little or no plasticizer has been added to the gasket. Plasticizers significantly reduce gasket life.

## Troubleshooting Table for Well/Pump Problems

1. Well pump will not start.
2. Well pump will not shut off.
3. Well pump starts and stops too frequently (excessive cycle rate).
4. Sand sediment is present in the water.
5. Well pump operates with reduced flow.
6. Well house flooded without recent precipitation.
7. Red or black water complaints.
8. Raw water appears **turbid** or a light tan color following rainfall.
9. **Coliform** tests are positive.

### Possible Causes

- 1A. Circuit breaker or overload relay tripped.
- 1B. Fuse(s) burned out.
- 1C. No power to switch box.
- 1D. Short, broken or loose wire.
- 1E. Low voltage.
- 1F. Defective motor.
- 1G. Defective pressure switch.
- 2A. Defective pressure switch.
- 2B. Cut-off pressure setting too high.
- 2C. Float switch or pressure transducer not functioning.
- 3A. Pressure switch settings too close.
- 3B. Pump foot valve leaking.
- 3C. Hydropneumatic tank has insufficient air paddling (Water-logged).
- 4A. Problems with well screen or gravel envelope.
- 5A. Valve on discharge partially closed or line clogged.
- 5B. Well is over-pumped.
- 5C. Well screen clogged.
- 6A. **Check valve** not operating properly.
- 6B. Leakage occurring in discharge piping or valves.
- 7A. Water contains excessive **iron** (red brown) and/or **manganese** (black water).
- 7B. Complainant's hot water needs maintenance.
- 8A. Surface water entering or **influencing** well.
- 9A. Sample is invalid.
- 9B. **Sanitary protection** of well has been **breached**.

### Possible Solutions

- 1A. Reset breaker or manual overload relay.
- 1B. Check for cause and correct, replace fuse(s).
- 1C. Check incoming power supply. Contact power company.
- 1D. Check for shorts and correct, tighten terminals, replace broken wires.
- 1E. Check incoming line voltage. Contact power company if low.
- 1F. Contact electrical contractor.
- 1G. Check voltage of incoming electric supply with pressure switch closed. Contact power company if voltage low. Perform maintenance on switch if voltage normal.
- 2A. Check switch for proper operation. Replace switch.

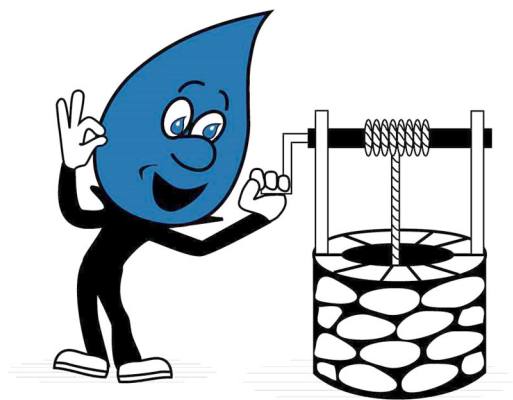

- 2B. Adjust setting.
- 2C. Check and replace components or cable as needed.
- 3A. Adjust settings.
- 3B. Check for **backflow**. Contact well contractor.
- 3C. Check air volume. Add air if needed. If persistent, check air compressor, relief valve, air lines and connections, and repair if needed.
- 4A. Contact well contractor.
- 5A. Open valve, unclog discharge line.
- 5B. Check **static water level** and compare to past readings. If significantly lower, notify well contractor.
- 5C. Contact well contractor.
- 6A. Repair or replace check valve.
- 6B. Inspect and repair/replace as necessary.
- 7A. Test for iron and manganese at well. If levels exceed 0.3 mg/L iron or 0.005mg/L manganese, contact regulatory agency, TA provider or water treatment contractor.
- 7B. Check hot water heater and flush if needed.
- 8A. Check well for openings that allow surface water to enter. Check area for **sinkholes, fractures**, or other physical evidence of surface water **intrusion**. Check water **turbidity**. Notify regulatory agency if >0.5 **NTU**. Check raw water for coliform **bacteria**. Notify regulatory agency immediately if positive.
- 9A. Check sampling technique, sampling container, and sampling location and tap.
- 9B. Notify regulatory agency immediately and re-sample for re-testing.



This type of brush is used to dislodge debris inside well casing.



## Installation of Standard Stuffing Boxes

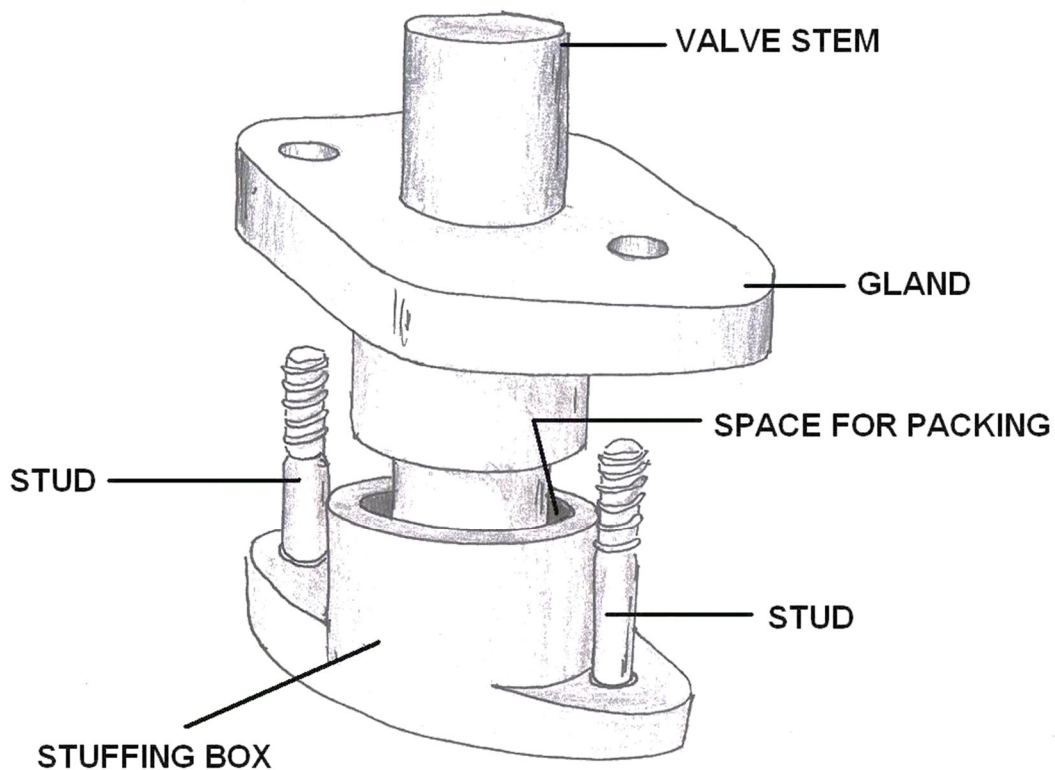

### 1. Stuffing Box

A. Slide the stuffing box over the shaft and fit into place (be sure to include the O-ring or gasket below the stuffing box flange). Bolt securely in place using the studs and nuts provided.

### 2. Packing

A. Insert four packing rings, fitting ends together so they contact face to face on the cut end. Turn each cut piece 90° from the previous piece. Be sure each piece is set against the piece below it.

### CAUTION

Do not tamp packing tight in the stuffing box. Excessive tamping will stop the flow of fluid through the packing. This will result in the destruction of the shaft area.

### 3. Packing Gland

A. Thread the two studs in the threaded holes on top of the stuffing box. Insert the packing gland on top of the packing and pull snug (not tight). The packing gland nuts should be tightened together to keep equal pressure on the packing.

### 4. Slinger

A. Attach slinger above packing gland.

## CAUTION

The stuffing box must be allowed to leak for proper operation. The proper amount of leakage can be determined by checking the temperature of the leakage. This should be cool or just lukewarm, not hot. Shutting off leakage flow from the packing will result in burned packing and a scored shaft.

## Installation of Optional Stuffing Boxes

### A. Stuffing Box

A. Slide the stuffing box over the shaft and fit into place (be sure to include the O-ring or gasket on the bottom

side of the stuffing box in the groove provided. Bolt securely in place using the studs and nuts.

### B. Packing

a. Insert the lower lantern ring (threaded holes up) in bottom of box.

b. Insert three packing rings, fitting ends together so they contact face to face on an angle. Turn each cut piece 90° from the previous piece. Be sure each piece is set against the piece below it.

c. Insert the second lantern ring (threaded holes up) on top of the packing. The lantern ring should be aligned with the grease port.

d. Insert three more packing rings on top of the lantern ring, as before.

e. Thread two studs into the holes on top of the stuffing box.

f. Insert the packing gland on top of packing, press down snug. The packing gland nuts should be tightened together to keep equal pressure on the packing.

The packing must be allowed to leak for proper operation. The proper amount of leakage can be determined by checking the temperature of the leakage. This should be cool or just lukewarm, not hot.

g. Insert the grease zerk and grease with a high quality grease.

C. If high pressure bypass is necessary, remove bypass plug. Install bypass line back to suction side of pump or drain.

D. Attach a slinger above packing gland.

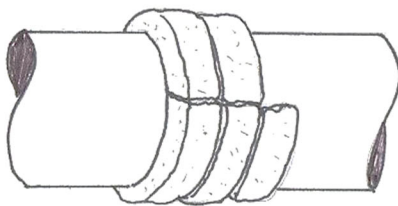

**INCORRECT**  
(butt joint)

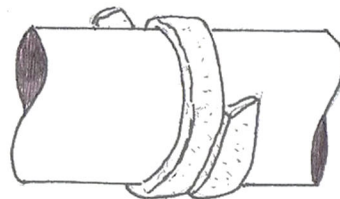

**CORRECT**  
(skive joint)  
(stagger @ 45 degree angle)

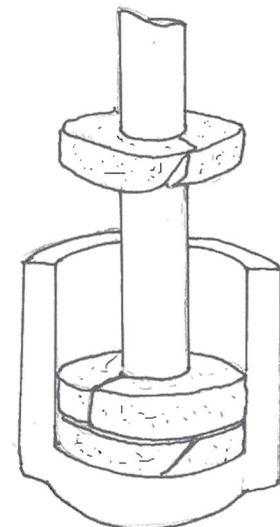

# Installation of Mechanical Seals

1. General Information
  - A. Study all instructions before installing.
2. Equipment Preparation
  - A. Assembled Pumps
    - a. The throttle bushing housing is shipped assembled on the pump but without the seal installed.
    - b. All faces of the mechanical seal housing and the throttle bushing housing must be free from dirt and rust.
  - B. Unassembled Pumps
    - a. The mechanical seal and throttle bushing housing are packaged in the box of small parts.
    - b. All faces of the mechanical seal housing, throttle bushing and head must be free from dirt and rust.
    - c. Install the O-ring or gasket in the throttle bushing housing, slide throttle bushing housing over shaft and seat it against the discharge head. Bolt securely in place using the studs & nuts provided.
2. Seal Installation
  - A. Before installation of Vertical Solid Shaft Motor (VSS) or Head Shaft in Vertical Hollow Shaft (VHS) Motor Installation.
  - B. Assure that shaft & seal housing are clean and free of machining and handling burrs
  - C. Set seal in place over pump shaft. Apply teflon tape to shaft treads and lubricate to ease seal into place.
  - D. Using fasteners provided, secure seal gland to seal housing
  - E. In the case of VSS Motor Installation
    1. Install pump shaft key and coupling half
    2. Install coupling spacer and run down to full shaft thread length
    3. Affix key and Motor coupling half to VSS Motor
      - F. Set VSS or VHS Motor in place and bolt to Discharge Head
      - G. In the case of VSS Motor
        1. Rotate coupling spacer in reverse direction to installation in order to elevate coupling spacer to the appropriate impeller adjustment if contact with motor coupling half.
        2. Rotate motor to align motor half coupling holes with the holes in the pump coupling half.
        3. Install and tighten coupling bolts (at which point pump shaft will be elevated to the appropriate impeller adjustment.
          - H. In the case of VHS Motor
            1. Thread shaft coupling onto pump shaft.
            2. Install motor (head) shaft through opening (quill) of motor (be careful not to impact coupling threads).
            3. Hold shaft coupling and thread motor shaft into coupling.
            4. Rotate motor by cooling fins until the female key slot is in alignment with the motor (Head) shaft.
            5. Install Gibb Key into slot presented by the motor (head) shaft and the motor coupling on the top end of the motor.
            6. Install adjusting nut in top end of motor (Head) shaft.
            7. Tighten adjusting nut until shaft and string is elevated to appropriate impeller adjustment.
            8. Rotate adjustment nut until one of the 1/4" - 20unc holes and the motor coupling on the top end of the motor, and one of the 5/16" holes in the adjustment nut are in alignment. (Note: Rotate the adjustment in the direction that assures minimum vertical shaft movement.)
            9. Install and tighten the 1/4" - 20unc bolt provided into the aligned bolt hole.

- I. Tighten the 1/4" - 20unc Allen (grub) screws located on the mechanical seal, onto the top shaft.
  - J. Remove the 1/4" - 20unc beveled head machine screws and aluminum spacer clips and store these parts in a secure place for use upon removal of the mechanical seal.
3. Seal Removal  
Reverse the above process.

## **Installation of Hollow Shaft Drivers**

1. Clean driver mounting flange on discharge head and check for burrs or nicks on the register and mounting face. Oil lightly.
2. Remove driver clutch.
3. See No. 10 regarding the installation of motor guide bushing, if required.
4. Lift driver and clean mounting flange, checking for burrs and nicks.
5. Center motor over pump and rotate to align mounting holes.
6. Lower carefully into place making certain that the female register on the driver mates over the male register on the pump.
7. Bolt driver to discharge head.
8. Check driver manufacturer's instruction manual for special instructions including lubrication instructions and follow all "start-up" directions.
9. Electric motors should be checked for rotation at this time. Make certain the driver clutch has been removed. Make electrical connections to the job motor and momentarily check rotation. **DRIVER MUST ROTATE COUNTER CLOCKWISE** when looking down at the top end of the motor. To change the direction of rotation on a three phase motor, interchange any two line leads. To change direction of rotation on a two phase motor, interchange the leads of either phase.
10. Some electric motors will be supplied with a "lower guide bushing" which is installed at the bottom of the motor to stabilize the shaft at this point. Some motor manufacturers mount this guide bushing before shipping while others will ship the guide bushing with instructions for field mounting. Check the packing slip to see if a guide bushing is required, if so, determine if the bushing is already mounted or not and proceed accordingly. Refer to the Motor Instruction Manual.
11. Install coupling on driver being careful that it fits properly.
12. At this point, if the pump is supplied with a two-piece head shaft construction, attach the headshaft to the top shaft with a coupling and tighten the shafts (left hand threads).
13. Clean threads on top of headshaft and headshaft nut. Lubricate male threads lightly.
14. Install Gibb Key in coupling and shaft. This must be a sliding fit and may require filling and dressing. Do not force.
15. Thread adjusting nut down on shaft until it bears against coupling. (Threads on 1-11/16" and larger head shaft adjusting nuts are left-handed, all other are right-handed). Do not thread nut further at this time. See impeller adjusting instructions.

## Impeller Adjustment with Hollow Shaft Drivers

Proper impeller adjustment positions the impeller inside the bowl assembly for maximum performance. The impellers must be raised slightly to prevent dragging on the bowls. The impellers must be down against the bowl seat when starting the impeller adjustment. When pumps are subjected to suction pressure acting against the shaft tends to raise it. Make sure the shaft is down when starting to adjust the impellers.

When using hollow shaft drivers, impeller adjustment is accomplished at the top of the driver by the following procedure:

### **The canopy will have to be removed before beginning.**

1. Install head shaft if not already in place. Refer to Installing Hollow Shaft Driver.
2. Install driver coupling in accordance with driver instruction manual and bolt into place.
3. Check shaft position lower shaft until there is a definite feel of metal contact. This indicates the impellers are “on bottom” and in the correct starting position for impeller adjustment.
4. Thread headshaft nut down (RIGHT-HAND threads except 1-11/16” and larger sizes which are LEFT-HAND threads) until impellers are just raised off their seat and the shaft will rotate freely.

### **Initial Pump Pre-Check Start-Up Procedures**

#### **Before starting the pump, the following checks should be made:**

1. Rotate the pump shaft by hand to make sure the pump is free and the impellers are correctly positioned.
2. Check that the headshaft adjusting nut is properly locked into position.
3. Check that the driver has been properly lubricated in accordance with the instructions furnished with the driver.
4. Check the driver for proper rotation. The pump must be disconnected from the driver before checking. The driver must rotate COUNTER CLOCKWISE when looking down at the top of the driver.
5. Check all connections to the driver and control equipment.
6. Check that all piping connections are tight.
7. Check that all anchor bolts are tight.
8. Check that all bolting and tubing connections are tight (driver mounting bolts, flanged, coupling bolts, gland plate bolts, seal piping, etc.)
9. On pumps equipped with a stuffing box make sure the gland nuts are only finger tight -- DO NOT tighten packing gland before starting.
10. On pumps equipped with mechanical seals, clean fluid should be put into the seal chamber. With pumps under suction pressure this can be accomplished by bleeding all air and vapor out of the seal chamber and allowing the fluid to enter. With pumps not under suction pressure the seal chamber should be flushed liberally with clean fluid to provide initial lubrication. Make sure the mechanical seal is properly adjusted and locked into place.

### **OPERATION WARNING**

An OSHA screen guard is furnished with all pumps having a driver stand. This screen must be secured in place prior to pump start-up to prevent possible contact with rotating parts.

**NOTICE**

After initial start-up, pre-lubrication of the mechanical seal will usually not be required as enough liquid will remain in the seal chamber for subsequent start-up lubrication.

**Stuffing Box Adjustment**

On the initial starting it is very important that the packing not be tightened too much. New packing must be "run-in" properly to prevent damage to the shaft and shortening of the packing life.

The stuffing box must be allowed to leak for proper operation. The proper amount of leakage can be determined by checking the temperature of the leakage, this should be cool or lukewarm -- NOT HOT -- usually 40 to 60 drops per minute will be adequate.

When adjusting the packing gland bring both nuts down evenly and in small steps until the leakage is reduced as required. The nuts should only be tightened about one half turn at a time at 20 to 30 minute intervals to allow the packing to "run-in". Under proper operation a set of packing will last a long time. Occasionally a new ring of packing will need to be added to keep the box fill. After adding two or three rings of packing, or when proper adjustment cannot be achieved, the stuffing box should be cleaned completely of all old packing and repacked.

**Stuffing Box Adjustment**

Open lineshaft bearings that are lubricated by the pumped fluid on short coupled units (less than 50' long) will usually not require pre-or-post-lubrication. All open lineshaft pumps where the static water level is more than 50' below the discharge head should be adequately pre-lubricated before starting the pump. These units should have a non-reverse ratchet on the driver to prevent backspin when turning off the pump. If there is no N.R.R., post-lubrication is also necessary.

**Initial Starting**

1. If the discharge line has a valve in it, it should be partially open for initial starting.
2. Start the pump and observe the operation. If there is any difficulty, excess noise or vibration, stop the pump immediately and refer to the Troubleshooting Chart for probable cause.
3. Open the discharge valve as desired.
4. Check complete pump and driver for leaks, loose connections or improper operation.
5. If possible, the pump should be left running for approximately one half hour on the initial start-up, this will allow the bearings, packing or seals, and other parts to "run-in" and reduce the possibility of trouble on future starts.

**NOTICE**

If abrasives or debris are present upon start-up the pump should be allowed to run until the pumpage is clean. Stopping the pump when handling large amounts of abrasives (as sometimes present on initial starting) may lock the pump and cause more damage than if the pump is allowed to continue operating.

**CAUTION**

Every effort should be made to keep abrasives out of lines, sump, etc. so that abrasives will not enter the pump.

## Motor-Pump Coupling Section – Post Quiz

1. \_\_\_\_\_are rapidly replacing conventional packing as the means of controlling leakage on rotary and positive-displacement pumps.
2. Mechanical seals eliminate the problem of excessive \_\_\_\_\_leakage, which causes failure of pump and motor bearings and motor windings.
3. Mechanical seals are ideal for pumps that operate in\_\_\_\_\_. They not only conserve the fluid being pumped, but also improve system operation.
4. Most water service pumps use a carbon material for one of the \_\_\_\_\_and ceramic (tungsten carbide) for the other. When the seals wear out, they are simply replaced.
5. You should replace a \_\_\_\_\_whenever the seal is removed from the shaft for any reason, or whenever leakage causes undesirable effects on equipment or surrounding spaces.
6. \_\_\_\_\_ a new seal on the sealing face because body acid and grease or dirt will cause the seal to pit prematurely and leak.
7. Mechanical shaft seals are positioned on the shaft by stub or step sleeves. Mechanical shaft seals must not be positioned by\_\_\_\_\_.
8. \_\_\_\_\_are chamfered (beveled) on outboard ends for easy mechanical seal mounting.
9. Mechanical shaft seals serve to ensure that \_\_\_\_\_is supplied to the seal faces under all conditions of operation. They also ensure adequate circulation of the liquid at the seal faces to minimize the deposit of foreign matter on the seal parts.
10. If the packing is allowed to dry out, it will score\_\_\_\_\_.
11. When operating a centrifugal pump, be sure there is always a slight trickle of water coming out of the\_\_\_\_\_.
12. How often the \_\_\_\_\_in a centrifugal pump should be renewed depends on several factors, such as the type of pump, condition of the shaft sleeve, and hours in use.

13. To ensure the longest possible service from pump packing, make certain the shaft or sleeve is smooth when the packing is removed from \_\_\_\_\_.

14. Rapid wear of the packing will be caused by \_\_\_\_\_(or shaft where no sleeve is installed).

15. When replacing packing, be sure the packing fits uniformly around\_\_\_\_\_.

**Answers:** 1. Mechanical seals, 2. Stuffing box, 3. Closed systems, 4. Seal faces, 5. Mechanical seal, 6. Do not touch, 7. Setscrews, 8. Shaft sleeves, 9. Liquid pressure, 10. The shaft, 11. Stuffing box or seal, 12. Packing, 13. A gland, 14. Roughness of the shaft sleeve, 15. The stuffing box



## Section 10- Groundwater Production System

**Section Focus:** You will learn the basics of the groundwater production system. At the end of this section, you will be able to describe how groundwater is pumped and delivered to the customer. There is a post quiz at the end of this section to review your comprehension and a final examination in the Assignment for your contact hours.

**Scope/Background:** Most water facilities and many wastewater facilities will either mine groundwater from a well, or pump treated effluent back in to a well for groundwater re-charging. Both methods require a mastery of fluid mechanics and pumping principles.

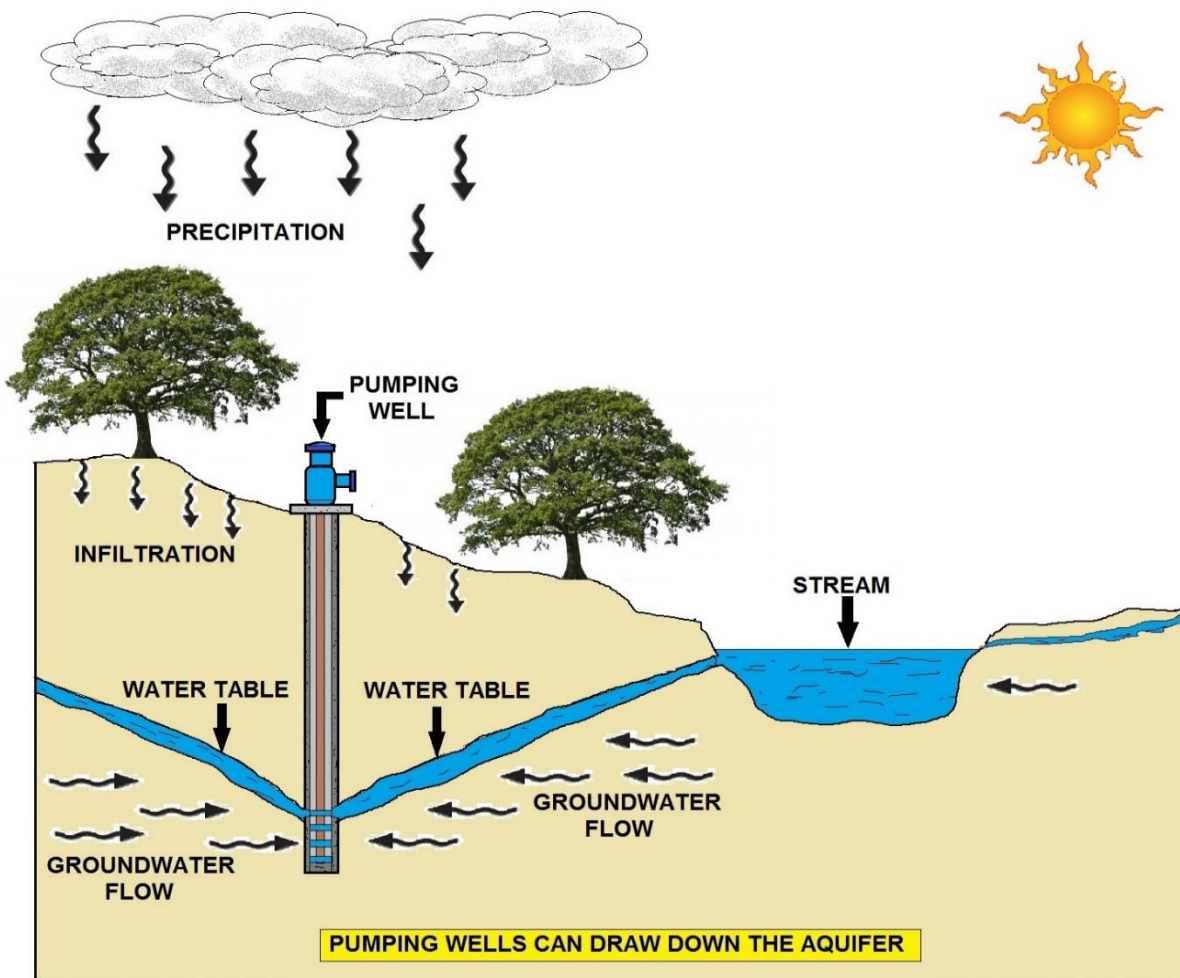

**Groundwater mining or production** is the removal, or withdraw, of water in the natural ground over a period of time that exceeds the recharge rate of the supply aquifer. It is also called "overdraft" or "mining the aquifer."

## Contaminated Wells Introduction

Contaminated wells used for drinking water are especially dangerous. Wells can be tested to see what chemicals may be in the well and if they are present in dangerous quantities.

Groundwater is withdrawn from wells to provide water for everything from drinking water for the home and business to water to irrigate crops to industrial processing water.

When water is pumped from the ground, the dynamics of groundwater flow change in response to this withdrawal. Groundwater flows slowly through water-bearing formations (aquifers) at different rates. In some places, where groundwater has dissolved limestone to form caverns and large openings, its rate of flow can be relatively fast but this is exceptional.



Well with a mineral oil sealed vertical turbine pump

### Groundwater and Wells

A well can be easily contaminated if it is not properly constructed or if toxic materials are released into the well. Toxic material spilled or dumped near a well can leach into the aquifer and contaminate the groundwater drawn from that well.

## Groundwater Introduction

Half of all Americans and more than 95 percent of rural Americans get their household water supplies from underground sources of water, or ground water. Groundwater also is used for about half of the nation's agricultural irrigation and nearly one-third of the industrial water needs. This makes ground water a vitally important national resource.

Over the last 10 years, however, public attention has been drawn to incidents of groundwater contamination. This has led to the development of groundwater protection programs at federal, state, and local levels. Because groundwater supplies and conditions vary from one area to another, the responsibility for protecting a community's groundwater supplies rests substantially with the local community.

If your community relies on ground water to supply any portion of its fresh water needs, you, the citizen, will be directly affected by the success or failure of a groundwater protection program.

Equally important, you, the citizen, can directly affect the success or failure of your community's groundwater protection efforts.

This course is intended to help you take an active and positive role in protecting your community's groundwater supplies. It will introduce you to the natural cycle that supplies the earth with ground water, briefly explain how ground water can become contaminated, examine ways to protect our vulnerable groundwater supplies, and, most important of all, describe the roles you and your community can play in protecting valuable groundwater supplies.

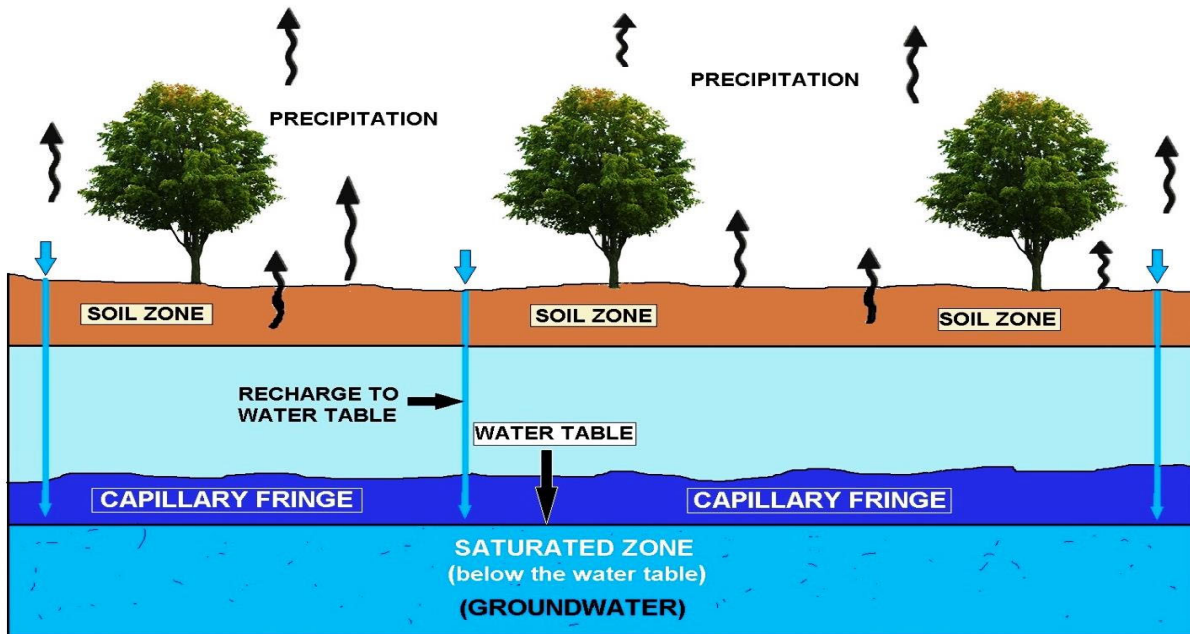

### CAPILLARY FRINGE

(Material above water table that may contain water by capillary pressure in small voids)

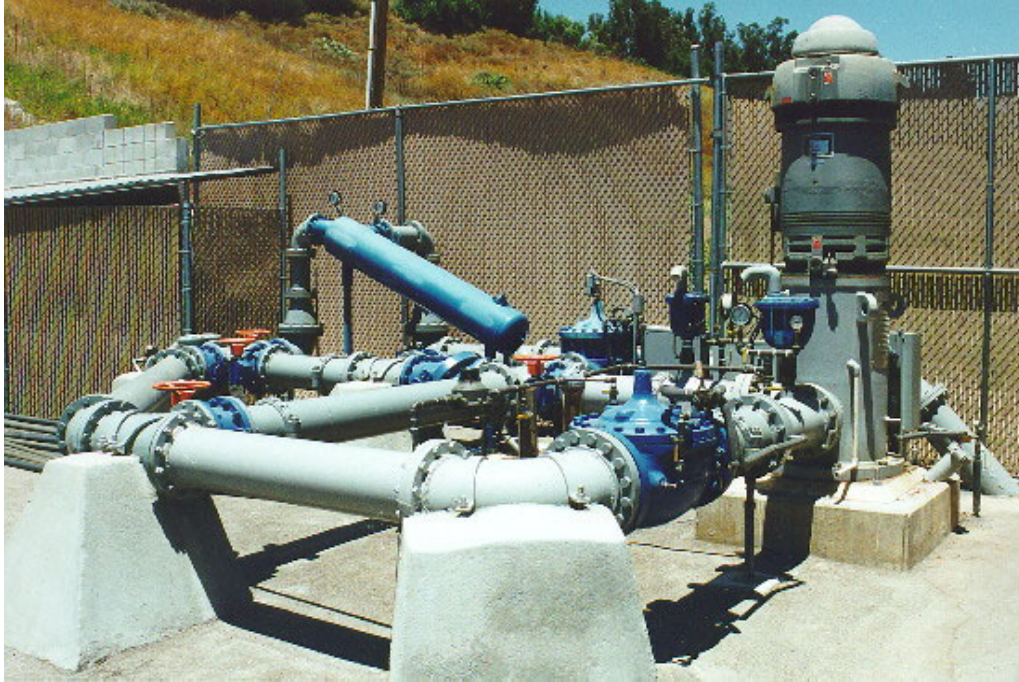

Vertical Turbine Well

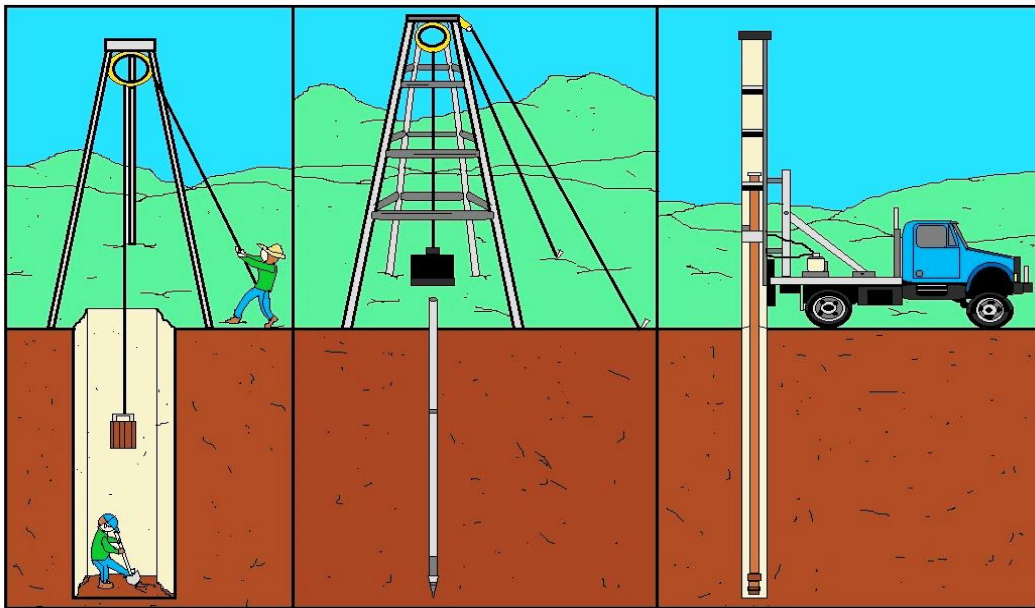

DUG

DRIVEN

BORED / DRILLED

## TYPES OF WATER WELLS

## Aquifer Introduction

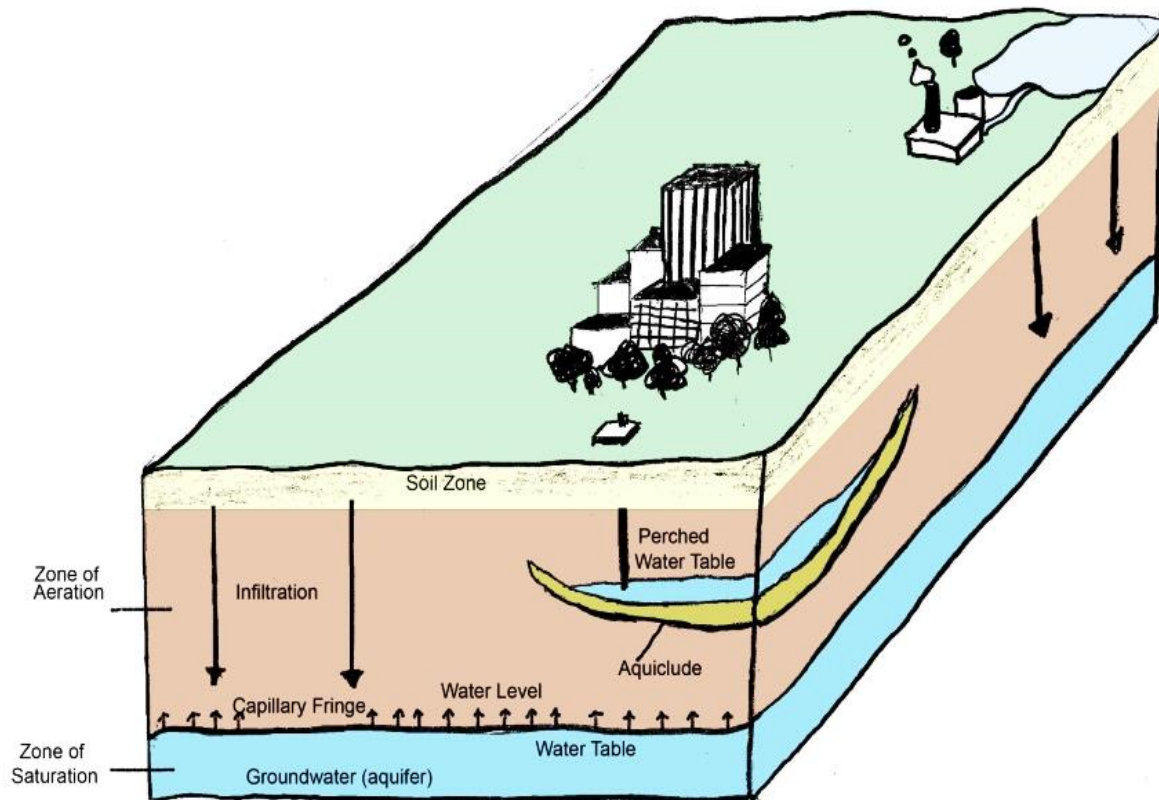

Many terms are used to describe the nature and extent of the groundwater resource. The level below which all the spaces are filled with water is called the *water table*. Above the water table lies the *unsaturated zone*. Here the spaces in the rock and soil contain both air and water. Water in this zone is called *soil moisture*. The entire region below the water table is called the *saturated zone* and water in this saturated zone is called *groundwater*.

*Fractured aquifers* are cracks, joints, or fractures in solid rock, through which groundwater moves. Examples of fractured aquifers include granite and basalt. Limestones are often fractured aquifers, but here the cracks and fractures may be enlarged by solution, forming large channels or even caverns. Limestone terrain where solution has been very active is termed *karst*.

Porous media such as sandstone may become so highly cemented or recrystallized that all of the original space is filled. In this case, the rock is no longer a porous medium. However, if it contains cracks it can still act as a fractured aquifer.

Most of the aquifers of importance to us are unconsolidated porous media such as sand and gravel. Some very porous materials are not permeable. Clay, for instance, has many spaces between its grains, but the spaces are not large enough to permit free movement of water.

Groundwater usually flows downhill with the slope of the water table. Like surface water, groundwater flows toward, and eventually drains into, streams, rivers, lakes and the oceans.

Groundwater flow in the aquifers underlying springs or surface drainage basins, however, does not always mirror the flow of water on the surface.

Therefore, groundwater may move in different directions below the ground than the water flowing on the surface.

*Unconfined aquifers* are those that are bounded by the water table. Some aquifers, however, lie beneath layers of impermeable materials.

These are called *confined aquifers*, or some-times *artesian aquifers*. A well in such an aquifer is called an *artesian well*. The water in these wells rises higher than the top of the aquifer because of confining pressure. If the water level rises above the ground surface a *flowing artesian well* occurs.

The *piezometric surface* is the level to which the water in an artesian aquifer will rise.

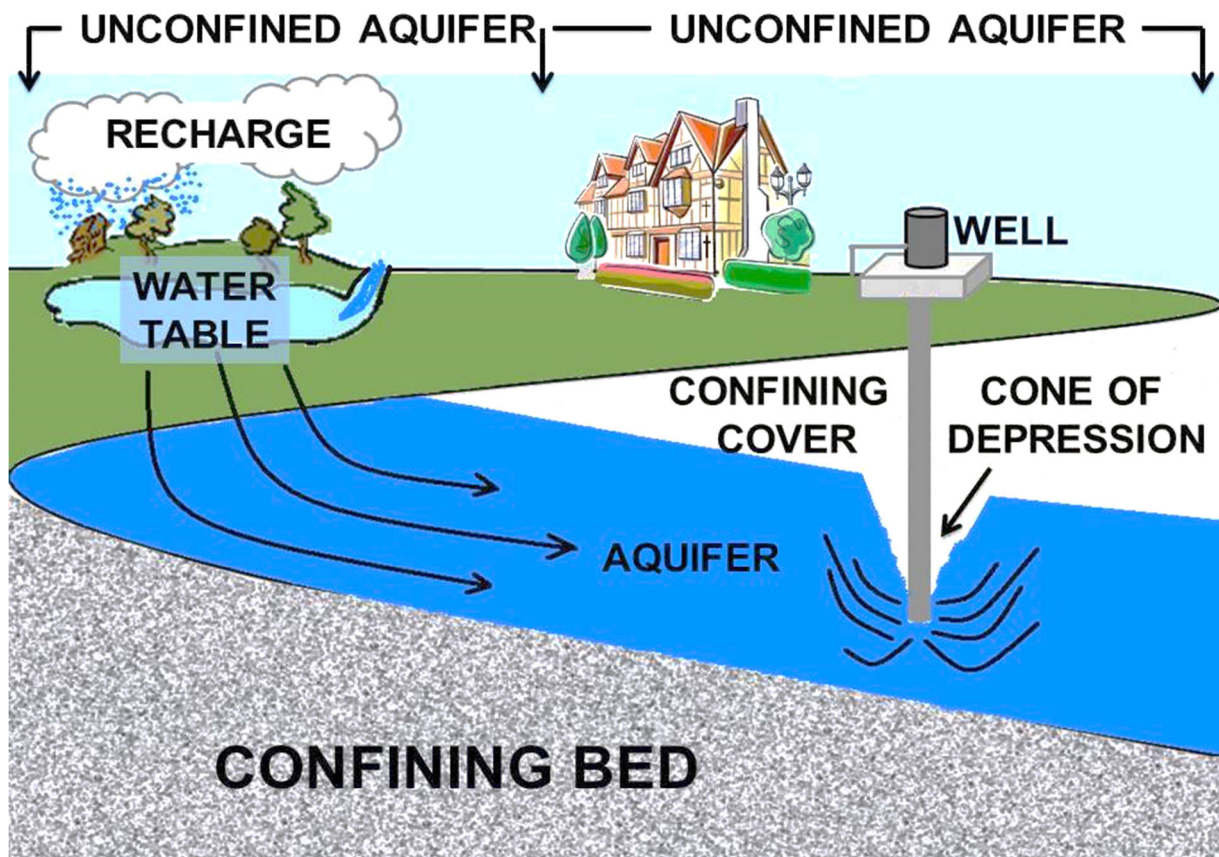

## Cone of Depression

When pumping begins, water begins to flow towards the well in contrast to the natural direction of groundwater movement. The water level in the well falls below the water table in the surrounding aquifer.

As a result, water begins to move from the aquifer into the well. As pumping continues, the water level in the well continues to increase until the rate of flow into the well equals the rate of withdrawal from pumping. The movement of water from an aquifer into a well results in the formation of a cone of depression.

The cone of depression describes a three-dimensional inverted cone surrounding the well that represents the volume of water removed as a result of pumping. Drawdown is the vertical drop in the height between the water level in the well prior to pumping and the water level in the well during pumping.

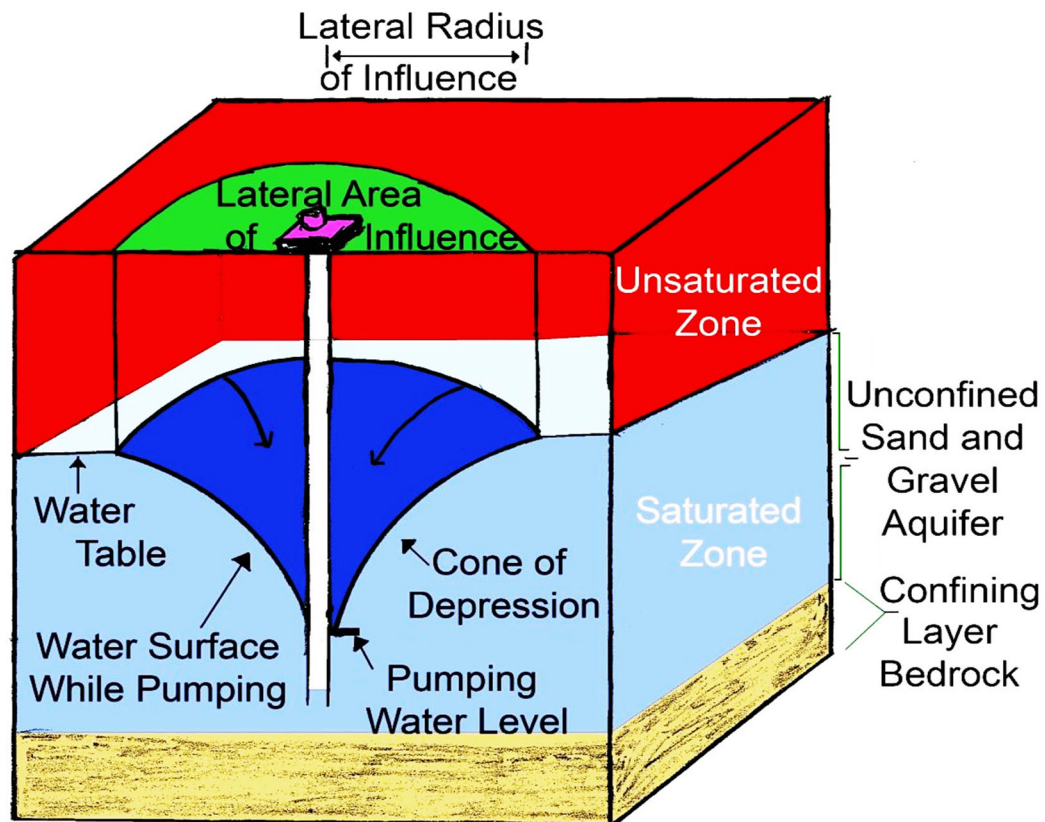

When a well is installed in an unconfined aquifer, water moves from the aquifer into the well through small holes or slits in the well casing or, in some types of wells, through the open bottom of the well. The level of the water in the well is the same as the water level in the aquifer.

Groundwater continues to flow through and around the well in one direction in response to gravity.

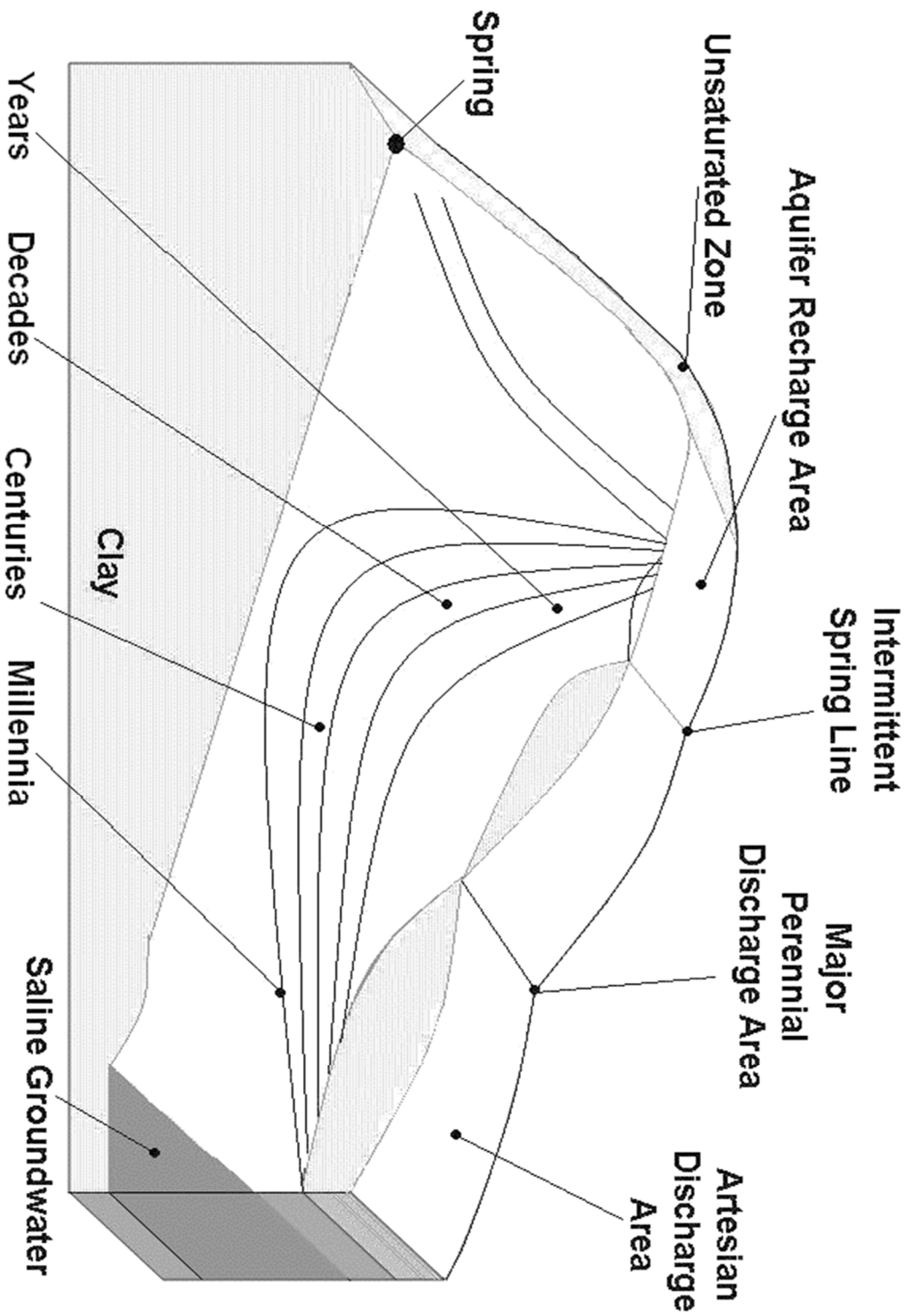



## Where Is Ground Water Stored?

Areas where ground water exists in sufficient quantities to supply wells or springs are called aquifers, that literally means “*water bearer*.”

*Aquifer(s)* stores water in the spaces between particles of sand, gravel, soil, and rock as well as cracks, pores, and channels in relatively solid rocks?

*An aquifer's storage capacity* is regulated largely by its porosity, or the relative amount of open space present to hold water.

If the aquifer is sandwiched between layers of comparatively impermeable materials, it is called a Confined Aquifer.

Confined aquifers are frequently found at greater depths than unconfined aquifers?

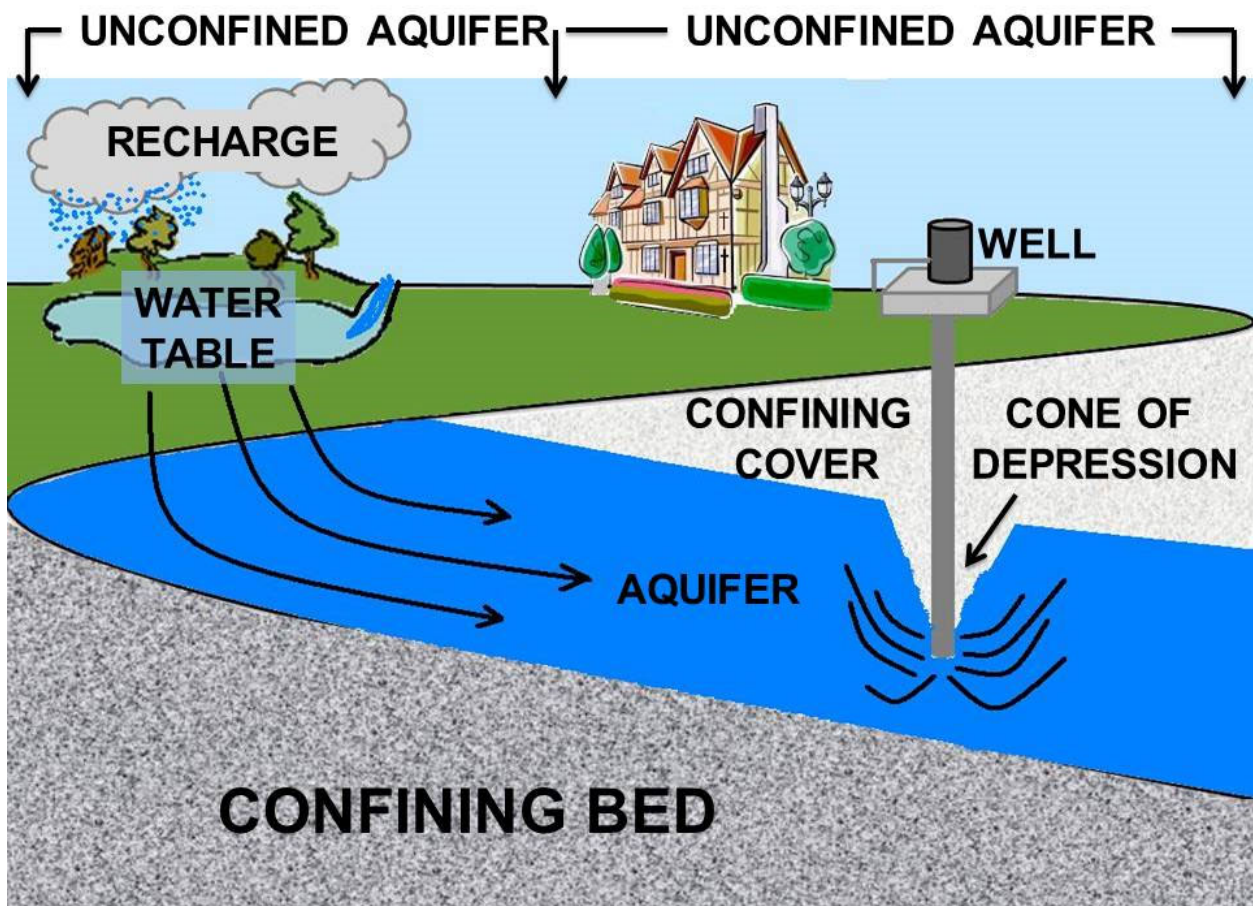

### Does Groundwater Move?

Groundwater can move sideways as well as up or down. This movement is in response to gravity, differences in elevation, and differences in pressure.

Groundwater can move even more quickly in karst aquifers, which are areas in water soluble limestone and similar rocks where fractures or cracks have been widened by the action of the ground water to form sinkholes, tunnels, or even caves.

### Groundwater Quality

The layers of soil and particles of sand, gravel, crushed rocks, and larger rocks were thought to act as filters, trapping contaminants before they could reach the ground water.

It is known that some contaminants can pass through all of these filtering layers into saturated zone to contaminate ground water.

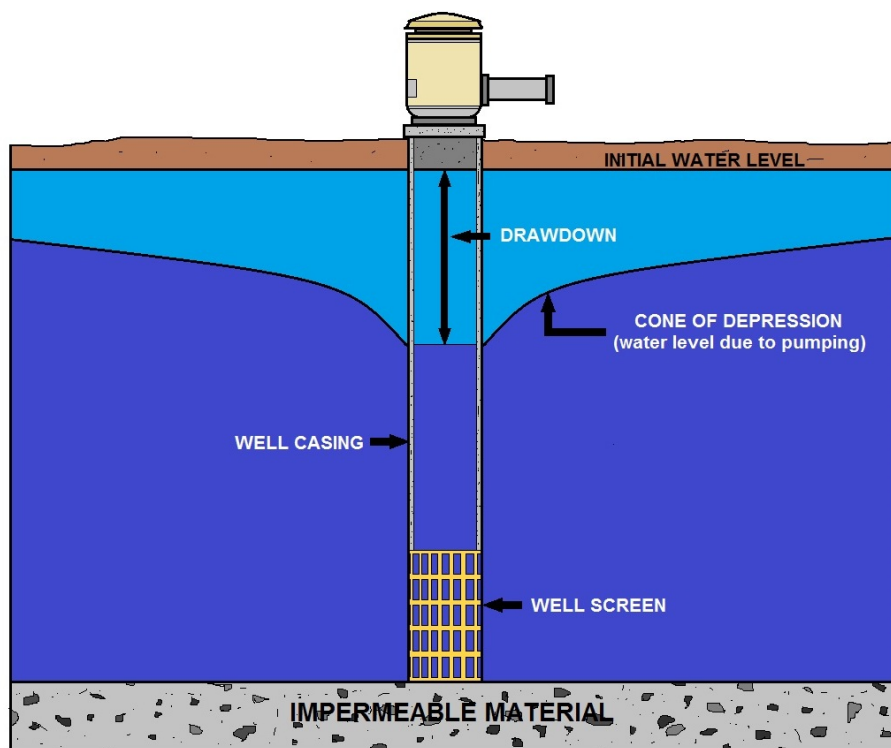

**CONE OF DEPRESSION CAUSED BY PUMPING**

### How Does Ground Water Become Contaminated?

Groundwater contamination can begin on the surface of the ground, in the ground above the water table, or in the ground below the water table

If the contaminant is introduced straight into the area below *the water table*, the primary process that can affect the impact of the contaminant is dilution by the surrounding ground water.

## Water Well Reports and Hydrogeology Introduction

*Filling in the blanks doesn't just satisfy some agency's requirements. Good well reports also provide hydrogeologists from the public and private sector with valuable information regarding local ground water systems. By Dennis Nelson*

**HYDROGEOLOGISTS ARE OFTEN CALLED UPON TO** evaluate an aspect of a ground water system—for example, the direction of ground water flow, the potential impact of a given land use on ground water, the potential impact of a well on another well or nearby stream, or the “*capture zone*” for a given well.

In order to conduct such an evaluation, the hydrogeologist must have actual or reasonable estimates of the physical and hydraulic properties of the geologic material through which the ground water is moving.



In some cases, data may be available in the form of geologic maps, aquifer tests, monitoring wells, or written reports. In many cases, however, the only information available is in the form of well reports (well logs), filed by well constructors at the time of drilling.

The importance of water well reports in hydrogeological investigations cannot be overstated. The information collected by well constructors during and after the drilling of a well is often the only information available to the hydrogeologist. In many cases, it is our only “*window*” into the aquifer.

The purpose of this document is to describe the type of ground water information needed to conduct typical hydrogeological assessments, and how the data collected by well constructors is used to obtain this information.

### Hydrogeologic Data

For hydrogeologists to make reliable assessments about the current and future status of ground water, they need to know where ground water occurs in the subsurface, what the properties are of the various geologic units below the surface, and how fast and in what direction ground water is moving. Obtaining the data necessary for these studies can be time consuming and expensive.

Well reports, however, can provide information that can be used to determine if further data is needed, and if so, what data and from where. In this document, important hydrogeologic parameters that are used will be discussed first, followed by several general examples of how they are used. Finally, how a typical well report can be used to acquire this data will be described.

### Depth to the Aquifer

It is necessary to identify which geologic unit is the aquifer; i.e., the porous and permeable rock or sediment that contains ground water and the depth at which it occurs. It is often also important to know the type of geologic materials that occur from the surface down to the top of the aquifer.

### Nature of the Aquifer

The nature of the aquifer can be described as either unconfined or confined. An unconfined aquifer has the water table as its upper surface; there are no significant low-permeability layers between the water table and the surface; and the aquifer is recharged locally, (in the immediate vicinity of the well). The top of the aquifer, the water table, can rise or fall depending on water use and amount of recharge to the aquifer.

A confined aquifer has a low-permeability geologic formation (a confining layer) as its upper boundary; the ground water in the aquifer is under pressure; the aquifer is separated from the surface by the confining layer and generally is recharged at some distance from the well, e.g., in nearby or distant areas of higher topography.

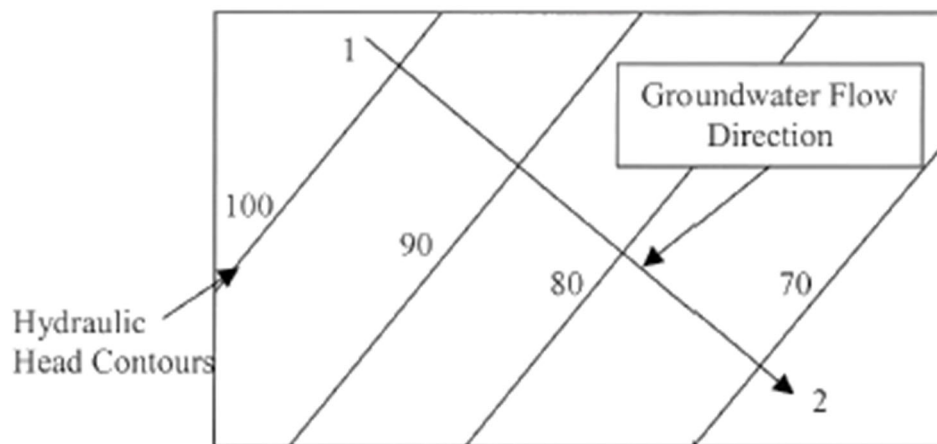

Figure 1.

### Hydraulic Head (h)

The hydraulic head is a measure of the energy that the water at a certain depth possesses because of its elevation and the pressure exerted through the weight of the water above it. Hydraulic head has units of feet, and generally corresponds to the elevation of water in the well.

Hydraulic head is the driving force for ground water movement either in a horizontal or vertical direction. Ground water moves from where the head is higher to where the head is lower. If we have enough hydraulic head data for an aquifer over a given area, we can contour the head elevation just like the ground elevation is contoured on a topographic map. Ground water will move from high head areas to low head areas and will generally flow in a direction that crosses the contours at a 90° angle (see Figure 1).

The change in hydraulic head ( $h_1 - h_2$ ) over the distance from point 1 to point 2 ( $D_{1,2}$ ) is the gradient ( $I$ ), calculated as

$$I = (h_1 - h_2)/D_{1,2}$$

In Figure 1, assuming points 1 and 2 represent individual wells, the gradient would be the difference in head between well 1 (~102 feet) and well 2 (~68 feet) divided by the horizontal (map) distance between the two wells.

### Thickness of the Aquifer ( $b$ ) and Water-Bearing Zones

To evaluate the amount of ground water moving through the aquifer or its ability to supply ground water to wells, it is necessary to know the thickness of the aquifer. It is also important to be able to identify whether the aquifer is uniform throughout its thickness or consists of one or more discrete water-bearing zones.

### Aquifer Porosity ( $n$ )

The volume of open space relative to the total volume of the aquifer (porosity) and the degree to which these pore spaces are interconnected (effective porosity) controls the volume of water in the aquifer and the amount of water that can be reasonably withdrawn from the aquifer. For a given gradient, the effective porosity strongly influences the velocity in which the ground water is moving.

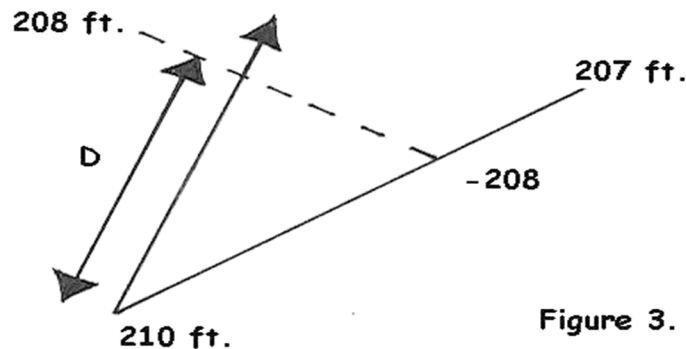
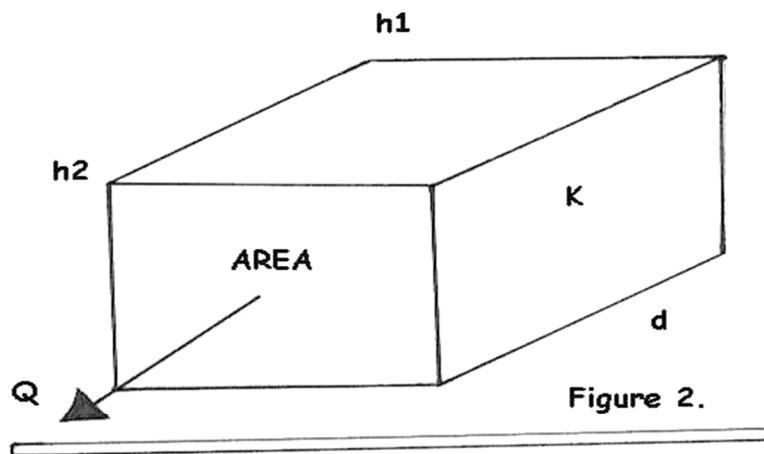

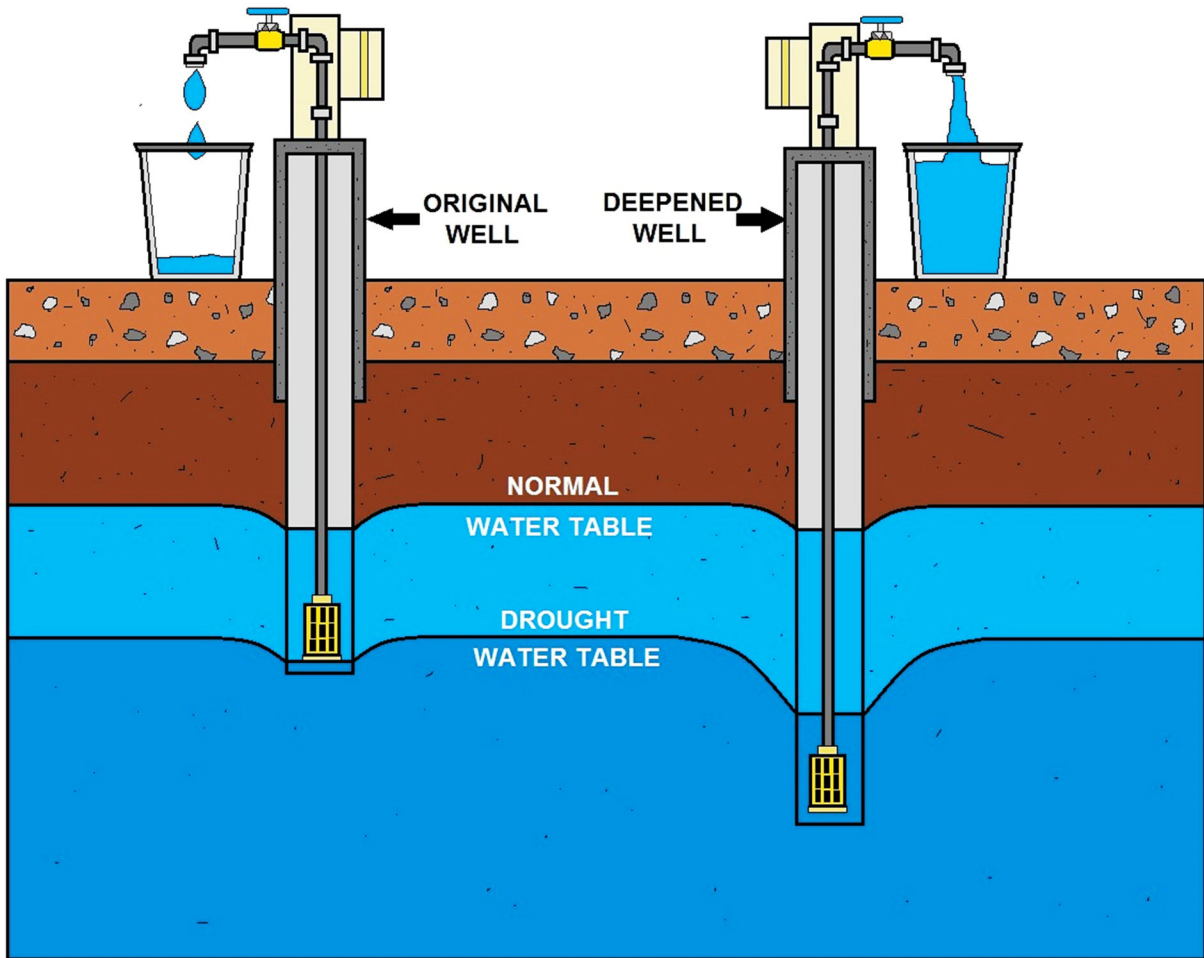

**AVOID WATER SHORTAGE DURING DROUGHT BY DEEPEMED WELL**

## Permeability of the Aquifer (K)

The permeability, or hydraulic conductivity, of the aquifer is a measure of how fast ground water can move through the aquifer. Hydraulic conductivity has units of distance/time, e.g., feet/day, although it does not represent an actual speed.

### Examples of the Use of Hydrogeological Parameters--Is the Aquifer Unconfined or Confined?

As indicated previously, whether an aquifer is confined or unconfined has important implications for its vulnerability to pollution. The most direct method of determining this characteristic is to compare the hydraulic head to the elevation of the top of the aquifer. Unconfined aquifers have the water table as their upper boundary. The water table is at atmospheric pressure and therefore, when the aquifer is drilled into, the water level in the well remains at the same elevation as the water table. Confined aquifers contain water that is under pressure.

When the aquifer is drilled into, the water level in the well will rise to a higher elevation than that of the top of the aquifer (remember that water seeks its own level).

### Volume Rate of Ground Water Moving Through an Aquifer

If we wanted to know how much ground water was traveling through an aquifer, we can apply Darcy's law, which states that the rate (Q) is equal to the hydraulic conductivity (K), times the cross-sectional area of the aquifer (A), times the hydraulic gradient (I):

$$Q \text{ (ft}^3\text{/day)} = K \text{ (ft/day)} \times A \text{ (ft}^2\text{)} \\ \times I \text{ (ft/ft),}$$

where  $I = (h_1 - h_2)/d$  in Figure 2.

Consider a gravel quarry that intersects an aquifer through a thickness of 50 feet and a width of 500 feet. If the aquifer had a hydraulic conductivity of 50 feet/day with a gradient of a 1-foot drop for every 1000 feet of horizontal distance ( $I = 0.001$ ), what volume of ground water would have to be pumped out of the quarry each day in order to keep it dry?

$$Q \text{ (ft}^3\text{/day)} = 50 \text{ ft/day} \times (50 \text{ feet} \times 500 \text{ feet}) \times 0.001 \text{ (ft/ft)}$$

$$Q \text{ (ft}^3\text{/day)} = 1250 \text{ ft}^3\text{/day or approximately 9300 gallons per day}$$

It is common to combine the hydraulic conductivity and aquifer thickness to yield a number referred to as the transmissivity ( $T = Kb$ ), a parameter that is more directly related to the volume of ground water flow. Using the transmissivity term, Darcy's law becomes;

$$Q \text{ (ft}^3\text{/day)} = T \text{ (ft}^2\text{/day)} \times w \text{ (ft)} \times I \text{ (ft/ft)}$$

### **In What Direction Is Groundwater Flowing?**

The direction of ground water flow is from higher to lower hydraulic head. Consequently, if we have wells that produce from the same aquifer, we can estimate the direction of ground water flow. The hydraulic head can be measured by lowering a probe through the observation port of a number of wells, all within the same relative time period, i.e., within a few days of each other.

A minimum of three wells is required to estimate the direction of flow. We can also determine the gradient from these wells. Three wells from the same aquifer have hydraulic heads (elevation of the water table) of 207, 208, and 210 feet.

### **What is the direction ground water is flowing and what is the gradient?**

We begin by drawing a line from the lowest (207 feet) to highest (210 feet) value of head. We note that somewhere along that line, the elevation of 208 feet, the intermediate value, must fall. If we assume that the water table has a constant slope, an elevation of 208 feet will occur one-third of the way from 207 to 210 ( $([208-207]/[210-207])$ ).

Once we have determined where the 208 feet elevation occurs along the line, we can draw a line from that point to the well with the 208 feet hydraulic head. This line represents the 208 feet contour on the water table.

As mentioned before, ground water tends to flow directly across, i.e., perpendicular to, the contours from higher head to lower head.

The arrow, then, represents the direction of flow. The gradient can be calculated by measuring D, the distance along the perpendicular from the well, with the 210-foot head to the 208-foot contour using the equation:

$$I = (h_2 - h_1)/D = (210 - 208)/D$$

Note that the three-point solution works best on wells that are relatively close to one another.

### **How Fast Is Ground Water Moving?**

The speed of ground water movement in the down gradient direction can be calculated using a modified version of Darcy's law:

$$V \text{ (ft/day)} = KI$$

This equation assumes that ground water is moving across the entire area of the aquifer, but in the real world, ground water does not flow that way. Ground water is moving only through the pore spaces (actual openings in that area). As a result, we have to include the porosity (n) in this equation:  $V = KI/n$

Using the gravel quarry example given before ( $K = 50 \text{ ft/day}$ ;  $I = 0.001$ ;  $n = 0.25$ ), the velocity of ground water through the aquifer can be determined as follows:

$$V = (50 \text{ ft/day} \times 0.001)/0.25 = 0.2 \text{ foot/day}$$



### **What Is the Drawdown Associated with Pumping of a Well?**

Often we would like to know how the pumping of one well might affect the water level in another. There is a relation between the pumping rate of the well, the transmissivity of the aquifer, the distance between wells, the storage coefficient of the aquifer, and the duration of the pumping event.



The storage coefficient of an aquifer is related to how much water is released from the aquifer as the hydraulic head of the ground water drops. The storage coefficient is slightly less than porosity for an unconfined aquifer (from 0.10 to 0.25) and is significantly less than porosity in a confined aquifer (from 0.01 to 0.000001 or less).

For unconfined aquifers, using the porosity is a reasonable approximation in most cases. No simple expression is available to determine drawdown as a function of distance for a given set of conditions; however, there are a number of computer programs that can perform this calculation with input of the previously mentioned parameters.

### **Using the Well Report**

Although most of the proposed questions can best be addressed through more detailed hydrogeologic investigations, we can often make reasonable estimates from available well reports if they have been carefully filled out (see The Well Guy, "Lithology," May 2002, Water Well Journal).

Well report forms vary from state to state, but most contain data that is relevant to a hydrogeologic investigation. Using typical entries from a well report form, let's examine where we can obtain the data we need.

### **Well Location**

For most hydrogeologic studies, the precise location of the well is very important. In many cases, wells are located only to the nearest section or perhaps in a quarter-section. In the latter case, we still only know the location to the nearest 40 acres. Over the last few years, well constructors have been using tax lot information to locate wells. This is an improvement, but depending on lot size, there still may be significant uncertainty.

We hope that more and more well constructors will take advantage of low-cost global positioning system (GPS) technology and begin reporting well location as latitude and longitude.

There are 24 satellites positioned above the earth's surface and at any given time off-the shelf GPS units are capable of linking to three or more of these and determining locations within 100 feet or less. Such high precision locations greatly enhance our ability to use the well report data to determine direction of ground water flow, ground water gradients, variation of aquifer properties throughout an area, and so on.

## Well Tests

Most well reports require the well constructor to perform some level of pump test to evaluate the capacity of the well. If the well constructor has carefully monitored the rate of water production (Q) and drawdown (s) associated with that production over the period of the test (t), the hydrogeologist can often derive useful information regarding the permeability or hydraulic conductivity (K) of the aquifer. The specific capacity (SC) of the aquifer at the well site is defined as the ratio of the discharge of the well to the total drawdown:

$$SC = Q \text{ (gpm)}/s \text{ (ft.)}$$

The transmissivity of the aquifer can be estimated from the specific capacity through the following relationship:

$$T \text{ (ft}^2\text{/day)} = AC \times SC \text{ (gpm/ft.)}$$

Where AC is a number varying in value depending on the aquifer characteristics.

If the hydrogeologist can determine the aquifer thickness from elsewhere in the well report, the hydraulic conductivity can be derived from this transmissivity value. It must be stressed that the specific capacity data can in no way replace the time-drawdown information acquired from a well-designed constant rate aquifer test. However, it does provide an approximation, and if enough specific capacity data can be found for an area, reasonable estimates can be made.

For information on conducting aquifer tests, see [www.ohd.hr.state.or.us/](http://www.ohd.hr.state.or.us/) and click on "**How to prepare for an aquifer test.**"

So what is a hydrogeologist looking for in specific capacity data? Ideally, the SC test will have been accomplished using a pump over a period of at least four hours. Why four hours? Let's consider a 50 gpm test of 25-foot-thick sand and gravel aquifer. If this test lasts for only an hour, all the water will be derived from within 4.5 feet of the well.

This small volume will not be very representative of the aquifer in general. If the test is run over a longer time period, a larger volume of aquifer can be "**sampled**" and the resulting hydraulic conductivity estimate will be more representative of the aquifer.

## Depth to First Water-Bearing Zone

There seems to be two ways that well constructors interpret this parameter. Some report the depth at which water is first encountered in the drill hole; while others report the depth where enough water to supply the well is encountered. From the hydrogeologist perspective, the first interpretation is preferred because it tells us where the top of the aquifer is.

It is common to find that an aquifer, i.e., a water-saturated geologic unit, varies in permeability in the vertical sense. For example, consider a 50-foot-thick sand aquifer that occurs at a depth of 30 feet and contains silt in the top 5 feet.

The entire 50 feet of aquifer is saturated; however, useful quantities of water can be produced from only the lower 45 feet. First, recognizable water would be encountered at 30 feet, while producible water would not be encountered until 35 feet.

From the hydrogeologist's view, the top of the aquifer is at 30 feet. Why is this so important? In order to determine whether the aquifer is confined or is unconfined, we must compare the elevation of the static water level to elevation of the top of the aquifer. In the case just given, the static water level in a well in this aquifer would be at 30 feet. If we had mistakenly thought that the top of the aquifer was at 35 feet, we may have considered it to be confined when actually it is unconfined.

## **Static Water Level**

The driving force for ground water movement is the hydraulic head, and the static water level (SWL) is a measure of that force (head = ground elevation- SWL). If we want to determine the ground water flow direction and the gradient, we may be able to gather that information from well reports. Care must be taken in using SWLs from wells drilled at different times of the year or over a period of years. Careful SWL measurements greatly enhance our understanding of the nature of ground water movement.

Well report forms generally provide space for SWL reporting as a function of depth in a given well. Multiple aquifers exist in most areas and these aquifers may be encountered as one drills deeper into the ground. Identifying where one aquifer ends and another begins is key to identifying the source of ground water to individual wells.

Although this often can be determined by careful review of the lithologic log provided by the well constructor, the transition from one aquifer to the next can be indicated by a marked change in the SWL.

A change in SWL is a better indicator that a different aquifer has been encountered than the lithologic description.

A progressive change in the static water level with depth can indicate to the hydrogeologist that the area represents a recharge zone (decreasing head with depth) or a discharge zone (increasing head with depth). Identification of recharge and discharge zones may have important implications in ground water protection and identifying the relation between area ground water and local streams.

## **Water-Bearing Zones**

A well report that does not indicate where within the 200 feet of open hole the water is actually coming from does not provide enough information to describe how water moves to the well. In some cases, the screened or perforated portions of cased wells provide a clue, but all too often, the screened interval is either significantly greater or less than the actual thickness of the water-bearing zone(s).

Arriving at accurate estimates of aquifer parameters or calculating ground water velocity requires us to know the thickness of the water-bearing zone(s). On well reports, if well constructors can identify the depth(s) where ground water is found and estimate the yield from each zone, the hydrogeologist can increase his or her understanding of the ground water system significantly.

### **Lithologic Log**

The well log portion of the well report describes what the driller encountered in the subsurface. Clear descriptions of the material drilled through, e.g., the relative proportions of silt/clay in the sand units, the locations of weak (fractured) zones in bedrock, whether a clay unit contains lenses or layers of sand, etc., allow the hydrogeologist to better estimate the potential permeability of these zones.

This information also allows the hydrogeologist to better estimate the recharge amount, vulnerability from contaminants from the surface, degree of hydraulic connection to surface water, and so on.

Of course, it is not necessary that well constructors be trained geologists. But it is important that their observations, coupled with their experience on a rig, be recorded. Once a hydrogeologist has examined a number of well reports from a given driller, he or she can begin to attach geologic terms to the descriptions provided. Consistency in reporting lithologic character and distribution with depth is very important.

### **Contributions of Well Constructors to Hydrogeology**

This document stresses the importance of data that is recorded on well reports and how that data influences hydrogeologic investigations. Filling in those blanks doesn't just satisfy some agency's requirements; it also provides hydrogeologists from the public and private sector valuable information regarding local ground water systems.

Well constructors can provide important contributions to the science by making careful observations and measurements when recording that data on the well report.

Dennis O. Nelson is a registered geologist and the ground water coordinator at the Drinking Water Program, Oregon Department of Human Services (442 A Street, Springfield, OR 97477; 541-726-2587; fax 541-726-2596; donelson@oregonvos.net).

His current work focuses on the hydrogeologic identification of the source of ground water-based public water systems (drinking water protection areas), determining the sensitivity of aquifers to contamination, and assisting public water systems and communities in developing drinking water protection plans.

Reprinted with permission of the *Water Well Journal*. Copyright 2003 by the National Ground Water Association ([www.ngwa.org](http://www.ngwa.org)). All rights reserved.



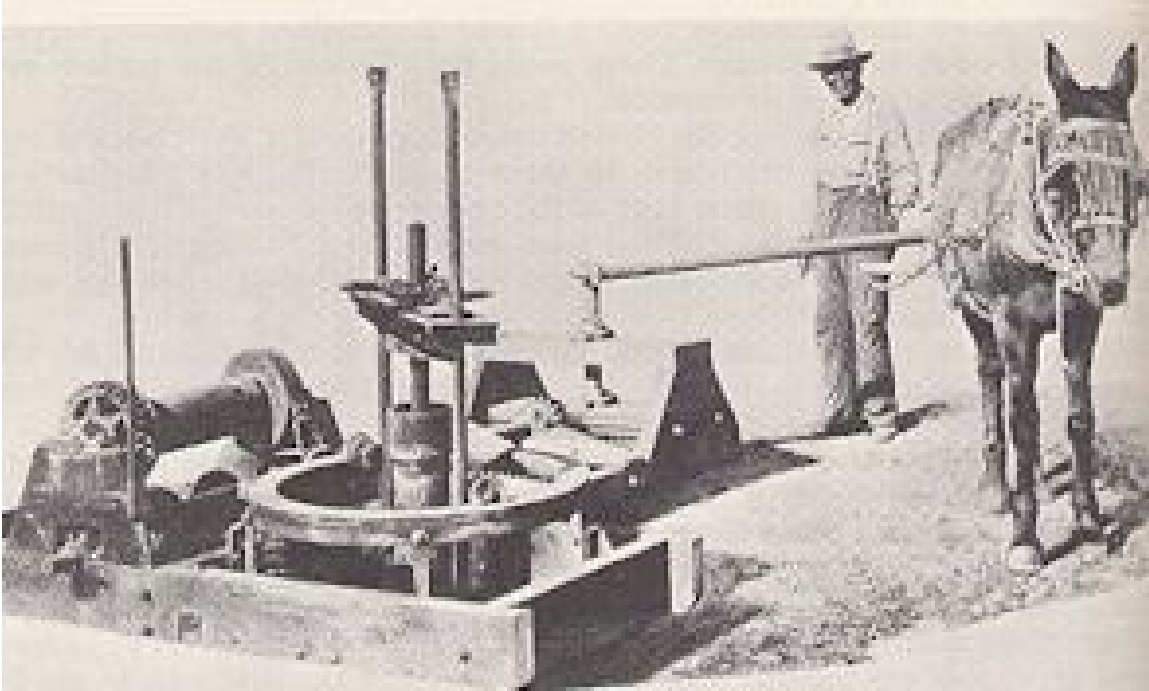

Up until 1940, mules were used as the horsepower to drill wells.

## Wells Drilling

Man has been digging holes into the ground to obtain water for thousands of years. Early on, these wells were dug by hand and sometimes using animals. This work could be dangerous and slow requiring many years to complete. In these modern times, wells can be drilled much faster and safer using numerous technologically advanced methods.

Some examples of today's more common well drilling methods include **rotary, auger, and cable tool** with many variations of each.

**Drilling fluids** are often used during drilling in order to keep the borehole open while drilling is done.

Drilling fluids **stabilize** the hole and aid in the removal of **cuttings**. Typical drilling fluids may be **water, mud, air, chemical or natural additives, or combinations of each**.

Although each drilling technique may be utilized in different types of geology, each one is better suited for particular types of material. For example, **air rotary with downhole hammer** is particularly suited for **hard rock** drilling, while **mud rotary** is better suited for drilling in **sediment**.

No matter what type of rig or method is being used, a highly trained and skilled **driller** is required to operate it successfully.



Drill String



Top Drive



Drill Pipe



Floating Sub Assembly



## Basic Rotary Drilling Methods

**Rotary drilling** utilizes a **drilling rig** with a rotating bit and circulating drilling fluid to penetrate into the aquifer. It is the most common type of drilling method used today. Common variations of this method include: **direct and reverse mud rotary, direct air rotary, and drill through casing driver methods.**

### The Rotary Drill String

Rotary drilling methods use a **drill string**, which typically consists of a bit, collar, drill pipe and a kelly (if table driven). A **kelly** is a section of heavy walled pipe that can be hexagonal, square, or rounded with grooves. The kelly is several feet longer than the drill pipe being used and fits into the table drive much like the splines on an automobile's drive shaft fit into a transmission.

The **table drive** turns the kelly and the rest of the drill string connected below as it slips down through the table. Some rotary rigs use a **top drive** to turn the drill string and are like a drill press, but larger. A top drive is free to move up and down the **mast** of the rig while rotating the drill string.

**Drill pipe** makes up a majority of the overall length of a drill string and is used in various diameters and wall thicknesses for added strength. Drill pipe can be used in various lengths but are typically 20-foot sections and may be connected to the **drive unit** with a **sub**.

A sub is a length of pipe used to connect pipes and/or act as shock absorber (**floating sub**) between the drill pipes and drive unit. At the end of the drill pipe is the drill collar.

The **drill collar or stabilizer** is typically very heavy and is often **gauged** close to the diameter of the bit being used. There are many types of drill collars that are often custom made by the driller by adding metal ribs to heavy drill pipe. The drill collar aids in maintaining a consistent borehole diameter and primarily helps to prevent **borehole deviation**.

At the end of the collar is the rotary **bit**. Several types of bits may be used; such as drag bits or roller bits.

**Drag bits** are typically used in unconsolidated to semi-consolidated sand, silt, and clay-rich formations.

Drag bits come in many shapes and sizes and cut with a shearing action aided by the jetting of drilling fluids from nozzles or jets in the bit. Roller bits, such as the common **tri-cone bit**, typically utilize interlocking teeth or buttons on individual rotating cones to cut, crush, or chip through the formation.

**Roller bits** are also aided by the jetting of drilling fluids from nozzles or jets in the bit. These bits can be used in consolidated formations and even hard rock applications if equipped with **carbide buttons**. These types of bits are often referred to as **roller button bits**.

Often an initial borehole needs to be **reamed** or made larger. **Reamers** are bits that can be used to enlarge, straighten, or clean an existing borehole. Occasionally, **under reamers** are used to enlarge deeper sections of an existing borehole without requiring the enlargement of the entire upper well bore.

**Under reaming** involves the projection of cutting blades beneath permanently installed casing in loosely consolidated sediments. This can allow for the cost effective installation of well screen and gravel pack within deeper loosely consolidated aquifers.



Table Drive (Notice notches for Kelly)



RIBBED STRAIGHT STABILIZER



RIBBED SPIRALED STABILIZER



OVER THE HAMMER STABILIZER



Tricone Roller Bits

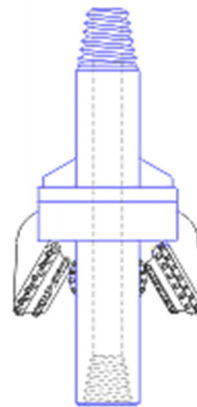

Roller Reamer



Drag Bit

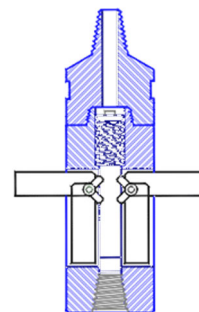

Drag Type Under-reamer

## Direct Rotary Method

Direct rotary drilling methods utilize a rotating bit at the end of a **drilling string** with **drilling fluid** that is **circulated** from the rig through the drill pipe and jets in the bit. Down-force exerted by the drilling rig and/or the weight of the drill string itself is used along with rotating action to force the bit downwards, cutting through the sediment or rock. The drilling fluid that is pumped by the rig's **mud pump** and/or **air compressor** is jetted out of ports in the bit.

These ports are called **jets**. The drilling fluid carries **cuttings** up the **annular space** between the drill pipe and **formation** and into **mud pits** or **containment recirculating systems** on the surface.

The drilling fluid pressurizes the **borehole** and helps to keep the hole open while removing cuttings. If this pressure is lost due to **washouts**, **voids**, **caverns**, or any number of other causes, circulation will not be maintained and drilling will likely have to be stopped.

Large drill rigs may utilize the cutting's containment systems that separate the cuttings from the drilling fluid before a pickup pump recirculates the drilling fluid back down the borehole, where the process is then repeated.

Also, one or more temporary mud pits may be dug into the ground adjacent to the rig in order to contain and settle out cuttings from the drilling fluid before recirculating.

## Direct Mud Rotary Method

Direct Mud rotary drilling rigs use various types of mud or drilling fluid to drill into the ground. Mud is circulated down the drill string and through the bit at the bottom of the borehole. The mud then carries the cuttings generated by the bit up to the surface and into the mud **recirculating system**.

Soil or formation samples may be collected from the recirculating system as drilling proceeds. A vibrating screen or set of screens called a **shaker** may be used in part of the recirculating system on larger rigs. It separates out cuttings from drilling fluid and provides an ideal **sampling location**.

The mud not only removes cuttings but also adheres to and pushes against the borehole walls, minimizes fluid loss, and cools the bit.

The process of building up a film of mud on the borehole walls is important to mud rotary drilling and is called **mud caking**. Sometimes specially trained personnel are needed to manage the physical properties of the mud to ensure that a proper **mud cake** thickness is maintained and that a proper density or weight of mud is used to efficiently drill the well.

The **mud engineer** will often use bentonite clay and water to make the mud drilling fluid. Sometimes chemical additives such as drilling polymers or gels may be used.

Mud engineers play an important role in ensuring that a mud rotary drilled well can be drilled to the proper depths successfully and ultimately developed for use. Sometimes the loss of mud drilling fluids to cavities in the earth cannot be stopped with a mud cake alone, however. In these instances, **casing** or **grout** may be installed to permit drilling beyond such zones.



Mud Pump



Well Drilling Components and Products



Typical Rotary Rig



Small Self-Contained Mud System



Constructed Mud Pits

## Reverse Mud Rotary Method

Reverse mud rotary drilling rigs utilize the same process as direct mud rotary with the exception that the mud drilling fluid injection process is reversed. Reverse rotary methods pump the drilling fluid down the borehole to the bit where the cuttings are forced up the drill string and into the containment or recirculating system.

The reverse method is utilized in situations where borehole stability problems are particularly difficult and would otherwise prevent conventional drilling of the well to the total **target depth**.

This method is particularly applicable to hard rock aquifers in zones where highly fractured or **weathered** rock may prevent the efficient flow of drilling fluids up the borehole walls to the surface. Also, fluid losses may be minimized with this method.

Samples are collected in the same way as mud rotary.

## Air Rotary Method

**Air rotary** methods utilize compressed air and derived drill cuttings and groundwater as the drilling fluid. Air is forced through the drill string and out the bit where it then mixes with and lifts cuttings and any derived groundwater to the surface.

Once at the surface, the cuttings and groundwater are typically contained in subsurface pits, much like the mud rotary method.

Soil or formation samples may be collected in a bucket or shovel placed beneath the **table** of the rig as drilling proceeds, resulting in representative samples. The borehole is kept in a pressured condition while drilling, in order to maintain the circulation of drilling fluid to the surface.

Biodegradable foam or **surfactant** (soap) is often added while drilling with air in order to maintain sufficient hole pressurization so that cuttings may be lifted to the surface efficiently while maintaining hole stability.

As in drilling with mud, if this pressure is lost due to washouts, voids, caverns, or any number of causes, circulation cannot be maintained and drilling may not continue.

The air rotary method is particularly suitable to hard rock drilling with a **down hole air hammer**. The air hammer utilizes compressed air to drive a piston up and down which makes the **hammer bit** move up and down while the drill string rotates.

The combined rotating and hammering action generates great rock breaking force and is very valuable for drilling through solid rock or consolidated formations.

Conventional air rotary drilling methods utilize roller bits in the same way as those used for mud rotary drilling.

In hard rock or consolidated formations, a roller **button bit** may be used when **drilling pressures** are too high or borehole sizes are too large for the efficient operation of an air hammer.



Air Rotary Containment Pit  
(Notice Foam and Water Truck)



Hammer & Bit



First Pit (heavy with cuttings)



Last Pit (small amount of fines)

Several containment pits installed in series can help cuttings to settle out.

## Drill through Casing Driver Method

The drill through casing driver method drives casing into the borehole as the drill string advances. A **casing driver** is a pneumatic device designed to push or pull casing that is typically attached to a top head drive air rotary rig. Heavy gauge steel casing is used with a **cutting shoe** installed on the down hole side.

The cutting shoe is a specially designed hardened steel ring that is installed on the casing end. It helps the casing cut its way through the formation as it is forced downward by the casing driver. The drill string is inserted into the casing and the casing is attached to the casing driver. As the drill string penetrates into the **overburden** or formation, the casing driver hammers the casing down, following the drill string.

The drill string may employ a hammer or roller bit. The driller pays close attention to the distance between the cutting shoe and the bit and adjusts as is necessary. Cuttings rise to the surface with the injected air through the casing and exit through the casing driver.

The cuttings are then collected near the rig. As the borehole is drilled, the casing advances and isolates the material being drilled from the remaining borehole. As a result, very accurate soil or cuttings samples may be collected as drilling proceeds with this method.

The addition of casing and drill string can continue until **competent** formation is encountered. Once the well has been drilled to competent formation, conventional drilling methods may be utilized to continue. The casing driver method is often used to install temporary casing in order to permit the installation of a well in unstable aquifers.

In this instance, the casing driver may be used as a puller to remove the temporary casing following well construction. This method is most useful when accurate formation or soil samples are needed and when drilling in troublesome unconsolidated overburden or formations with numerous cobbles or boulders.

### Cutting Shoe



The Cutting Shoe is welded to the bottom of casing before installation.



A Casing Driver attached to a top drive air rig.





## Auger Boring Methods

Auger boring methods make use of a rotating blade or **spiral flange**, which may be attached to a **pilot bit** and **cutter head**. Down-force applied by the rig along with the rotating action of the blade and cutting action of the pilot and/or cutter bits facilitates the boring process.

Soil samples may be collected as cuttings rise or are brought to the surface, or they may be collected with **split spoon** type samplers.

Augers are capable of boring large diameter holes in excess of four feet in diameter. They are typically used in shallow applications (less than 200 feet) and where stable silt and clay soils or soft materials are dominant.

These boring methods are commonly used to construct large diameter boreholes for the construction of **surface seals** around wells through thin and stable overburden sediments which overlie the aquifer below.

One of the methods is commonly used in environmental applications for the collection of soil samples. There are three primary types of auger boring methods: **solid stem, bucket, and hollow stem**.

## Solid Stem Auger Method

The solid stem auger boring method uses a spiral flanged drill pipe driven by either a kelly or rotary drive head, like those used on rotary rigs. The drill pipe may be continuously flanged or just the initial section is flanged. Flanged sections of drill pipe are referred to as **flighting**. The lower portion of flighting, having the cutter bit attached, makes the initial cuts into the formation, providing the path for the remaining flighting to follow.

Larger diameter augers typically employ a single flight and can be used in stable formations to depths of approximately 60 feet. Deeper borings are typically installed with continuous flighting and only in stable formations.

Occasionally, the lower flight is removed from the borehole so that cuttings, which accumulate at the bottom of the borehole, may be removed and/or sampled. When boring with continuous flighting, cuttings are brought to the surface by the spiral action of the flighting. Samples may be collected from these cuttings or the flighting may be brought to the surface and samples collected from the **cutting head**. This method is not suited for applications below the water table and may provide limited soil sample data. However, it may be used to aid in quickly constructing the larger diameter upper sections for larger wells.

**Auger Flighting:  
Cutting Head**

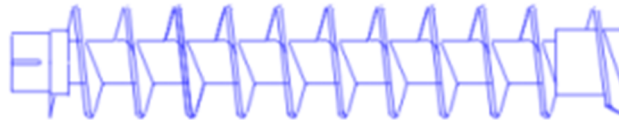

## Bucket Auger Method

The bucket auger method essentially combines the rotary and auger techniques. The bucket auger method employs a single, typically large in diameter, bucket auger to drill or bore into the ground. The **bucket auger** is a cylinder constructed with auger like blades at its bottom edge. These blades may be armored with various forms of cutting teeth or blades to provide strength and “**bite**”. The bucket auger is rotated via a kelly and table drive much like those of rotary rigs. However, bucket auger rigs utilize a **telescoping kelly**.

A telescoping kelly consists of two or more sections of square piping that telescope into each other. This type of kelly allows the rig to drill to depths of 40 feet or more without requiring the addition and removal of drill pipe.

When the bucket is filled with cuttings it is closed and brought to the surface where it is swung out to the side of the rig by a specially designed **swing arm or dumping arm**. At this point the bucket is opened and cuttings are dumped. Soil samples may then be collected and can be considered representative of the section bored.

Bucket auger methods typically cannot be used in material containing cobbles and boulders, but is used most often in more stable **semi consolidated** silty or clay rich deposits. Large diameter wells up to 4 feet in diameter may be constructed with the bucket auger method, with smaller diameters approaching 200 feet in depth. Occasionally, drilling fluids such as **bentonite mud** may be used in order to maintain borehole stability when drilling in questionable materials.

## Hollow Stem Auger Method

The hollow stem auger method has been used in the *geotechnical* field for many years for its usefulness in obtaining soil samples. Continuous *hollow stem flights* are used with a **pilot** and **cutter head**.

The lowermost flight contains a **plug** that is connected to drill pipe that passes through the center of the flights and is ultimately connected to a top drive. The plug prevents soil from entering the auger and is connected to the pilot bit that helps to guide the auger downward during boring.

When the plug is removed, accurate soil samples may be obtained while the flighting remains to keep the borehole open. Samples are typically collected with a **split spoon sampler** or core barrel sampler driven into the soil a few feet ahead of the flighting.

The use of larger diameter continuous flights can also permit the installation of well screen and filter media in otherwise relatively unstable formations by its acting as temporary casing. Wells constructed with this method are normally less than 200 feet deep. This method is also limited to relatively soft ground applications with few boulders or cobbles.



### What is a Significant Deficiency?

Significant deficiencies cause, or have the potential to cause, the introduction of contamination into water delivered to customers. This could include defects in design, operation, or maintenance of the source, treatment or distribution systems. They could also be represented by the failure or malfunction of those systems. The rule requires each state to define and describe at least one type of specific significant deficiency for each of the eight sanitary survey elements.

An example of a source-related significant deficiency could be a well located near a source of fecal contamination (e.g., failing septic systems or a leaking sewer line) or in a flood zone.



Using a video camera to see inside a groundwater well.





Large Bullnose Bailer

Fills from the bottom up great for removing water from the casing.



### Well Brushing

A homemade well casing cleaning brush, great for cleaning and redeveloping the well. This is a 12-inch casing.

## Cable Tool or Percussion Method

The cable tool or percussion method is one of the oldest and most reliable forms of well drilling still used today. This method is adaptable to virtually every kind of drilling environment. As a result, numerous variations in both rig types and methods have evolved over its history. However, it is often used as a method of last resort when time is an issue, due to its typically slow process. Still, the cable tool method can surely succeed where any of the other methods fail.

Cable tool or percussion drilling methods utilize a system of cables and reels to lift and drop a very heavy drilling string as downward progress is made. The weight and force of the bits' impact breaks up the ground and permits a typically slow, but steady, downward movement.

Water is used as the primary drilling fluid. As drilling proceeds, cuttings and water mix, forming slurry. This slurry is allowed to pass back and forth through a watercourse or opening within the drill string.

The drill string is occasionally removed from the borehole through the use of a specially designed **bailer**. A bailer is a section of pipe constructed with a check valve located at the bottom of the pipe. As the bailer is lowered, it fills with the drilling fluid and cuttings.

When the bailer is raised up, the valve at the bottom of the pipe closes, trapping the slurry inside. The slurry can then be lifted to the surface and the contents dumped into a containment system, where samples may then be collected.

The cable tool drill string is comprised of a **cable, swivel socket, drilling jars, drill stem, and drill bit**. The primary cable is used to lift and drop the drill string, while the swivel socket provides a rotating mechanism.

The rotation allowed by the swivel socket ensures that fresh cuts are made with each strike of the bit. The drilling jars are used only for additional upward shock to remove the bit, should it become stuck in the borehole.

The drill stem provides the majority of the weight of the drill string and also helps to maintain a straight borehole. It serves the same purpose as the drill collar used in rotary methods. Cable tool bits are normally a wedge shape, although numerous variations may be used for different formations, including carbide button and armored bits for consolidated formations.

The borehole may remain open or casing may be advanced while drilling, in order to keep the borehole open in **unstable** formations.

Casing is advanced by either pushing it hydraulically, like a large press, or by **driving** it down with the drill string or a **drive block**.

The drive block is a heavy collar type device that attaches over the drill pipe and is lifted up and allowed to fall, striking the casing and forcing it down. An accessory reel called a **cathead** is used to lift and drop the drive block with a heavy rope.

Also, a **drive clamp** may be attached to the top of the drill stem and serves as a striking surface.

A cutting shoe is attached to the bottom edge of the casing to add strength and provide cutting ability. Drilling, casing advancement, and bailing alternate as the borehole gets progressively deeper.

If the casing becomes too difficult to advance further and the required drill depth has yet to be achieved, a smaller borehole and casing may be used inside of the outer casing in order to continue. This is called **telescoping**.



Typical Cable Tool Rig



Sand Bailer

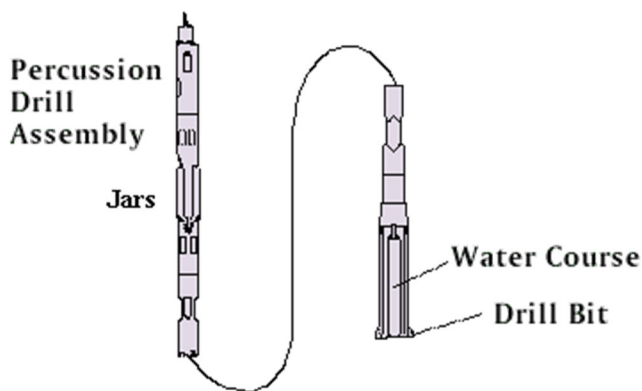

Percussion Bits





## Selecting an Appropriate Well Site

Before a well can be drilled a permit is normally required. The permit helps to ensure that an appropriate location of the well is selected which reduces the possibility of **contamination**. The ideal well location has good drainage and is higher than the surrounding ground surface.

All possible sources of contamination should be at a lower elevation than the well, and the distances to those contamination sources must be in accordance with the State or Local Water Well Construction Codes.

Surface drainages should not allow surface water to accumulate within a 15-foot radius of the well. A well must also never be located closer than 20 feet to sewers, 100 feet to septic tanks, or 100 feet to sewage seepage fields. **(The “code” refers to the requirements of the well permit process enforced by the State or Local regulating agency.)**

## Well Construction

Following the drilling of a well, it must be constructed to meet strict standards set by the **governing agency**. Each State has well construction design criteria for water supply wells. Before a well is drilled, a well drilling permit is normally required to be in hand. The purpose of the well **drilling permit** is to ensure that a qualified driller is being used to drill and complete the well to a standard set by the governing agency.

The drilling permit also ensures that the **regulating agency** is aware of the location and proposed use of wells and that they are not constructed within close proximity to any activities that may put the water supply at risk, such as a septic tanks or chemical storage areas.

A permit application fee is normally charged. The permit will normally require information about the proposed well's location, depth, diameter, anticipated production rate, sanitary seal, and proposed construction at a minimum.

**Permitting requirements and well construction standards can vary by state and location. As such, well construction specifications presented in this document are general in nature and should not be considered legal in your state.**

**One should become familiar with his state's particular regulations regarding well drilling and construction.**

## WELL PROTECTION

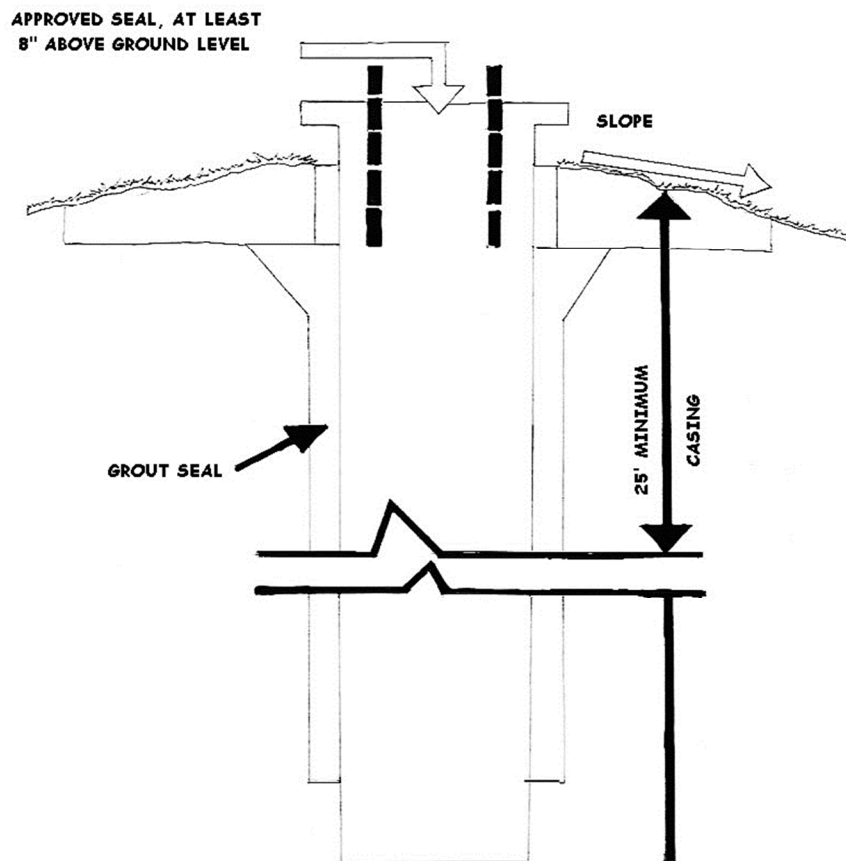

**(EXAMPLE ONLY – CHECK STATE OR LOCAL REQUIREMENTS)**

## Common Well Construction Specifications

Water wells should always be located and constructed in such a manner that they **yield** safe water at all times and under all conditions. Contamination of a water supply typically occurs when leachate from sewage systems or surface waters enter a well. Surface water may enter the well through an opening in the top or by seeping through the shallow borehole walls.

Tests have shown that bacterial contamination is usually eliminated after filtering through 10 feet of normal soil. Therefore, construction of the well must ensure that the top and uppermost 20 feet of the well bore are sealed and watertight. This is the primary reason why surface casing and surface seals are so important.

All wells must be constructed with a **surface seal** to prevent the infiltration of surface water and/or surface contaminants into the well bore and aquifer. This seal is installed in the upper portions of the well bore between the **annulus** and **surface casing** and will normally extend to the ground surface around the well.

The seal is constructed by pouring or pumping neat **cement grout** and/or **bentonite** between the surface casing and the well bore. The installation of the cement or grout between the annulus and surface casing effectively seals off the upper borehole from the surface.

The surface casing used is a solid piece of permanently installed casing, usually steel, that should be of sufficient size to allow the **completion** of the well within it. In addition to the surface seal, a **well seal** or **cap** is always installed with the pumping equipment to ensure no surface water or debris enters the well.

When the well is drilled into the aquifer, the depths of water (**productive intervals**) and **estimated well yield** are normally **logged** by the **driller** or **geologist**. Sometimes the aquifer's productive intervals may not be known, due to drilling method limitations or a lack of regional **hydrogeological** data.

In these instances, specialized **borehole geophysical logging equipment** may be used to isolate the areas of optimum production capability and aid in determining the ultimate well design.

In addition, preliminary **pumping tests** are normally conducted to ensure the well is as productive as originally estimated and to obtain preliminary **aquifer parameters**.

Following the installation of the well's surface seal, the well is then reamed (if necessary) to accept additional **blank casing, well screen, and filter or gravel pack**. Once the well has been reamed large enough in diameter for the anticipated flow rate, the appropriate casing can be installed.

The well casing ensures that the borehole remains open and that debris from the formation(s) does not enter the well, thereby protecting the pump equipment and the well itself. Blank casing is normally installed to the depth of the main **producing zone**.

At this point, **well screen** is used and may extend to the total depth of the well or may be used intermittently to total depth with blank casing used through unstable or non-productive areas.

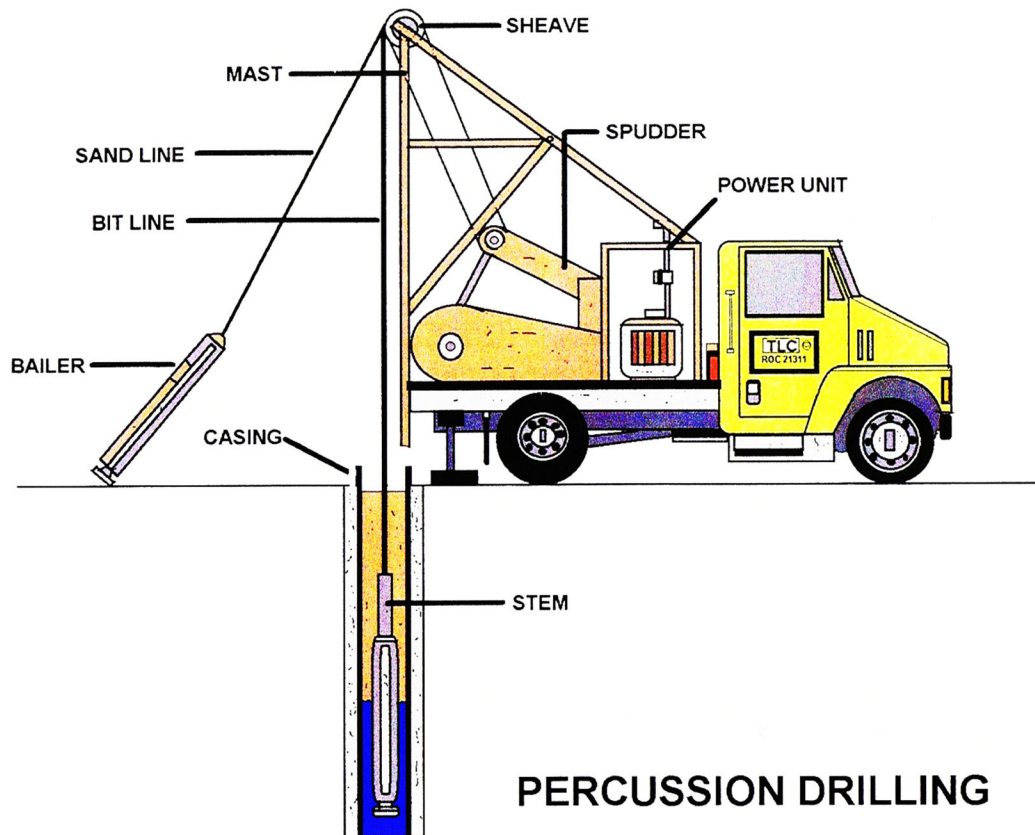

## PERCUSSION DRILLING

Percussion drilling is a commonly found groundwater production drilling technique in which a drill bit attached to rope or cable is repeatedly raised and lowered, impacting soil and rock and making the hole deeper. Frequently used to drill wells or during mineral prospecting activities, percussion drilling has been used for thousands of years and is adaptable to whatever technology is available.

Percussion drills may be simple apparatuses consisting of a heavy drill bit and a rope, and operated by hand. Modern percussion drilling may also be called cable drilling and uses an engine and cable to drill holes that may be hundreds of feet deep.

One use of percussion drilling is in third-world countries as a cheap and reliable way to drill water wells. Equipment is easy to build, transport, and simple to use. Percussion drills introduce less contamination than conventional hand drilling methods. This technique can drill a narrower and deeper hole than hand drilling through many different types of soil and rock.

If the substance being drilled through is sturdy enough, drilling can continue until water is reached. If drilling occurs in loose soil or sand, a pipe may need to be inserted to keep walls from collapsing. After the well is deep enough, permanent casing is installed, too.

## Choice of Casing

The choice of casing is as important as its placement. There are numerous types of casing designed for specific applications. The type of well casing needed is related to the type of aquifer, well depth, water quality, well use, and regulatory requirements. *Stainless steel* casing and screen may be required for one situation, while *PVC* or *low carbon steel* may be acceptable in another. As such, *please check with your regulating agency and well driller to ensure the installation of the appropriate type of casing for your application.*

As with casing, the choice of well screen is as important as its placement. The size of the openings in the casing (*screen slot or perforated opening size*) are dependent on the *grain size* of the filter or gravel pack used. The same applies to applications where a well is *naturally developed* or *naturally packed* (no filter pack is used).

As a rule, coarse grained sediment or fractured hard rock aquifers may be naturally developed, while fine-grained sediment aquifers typically require a filter pack. The selection of screen slot size is normally made based on samples collected from the aquifer during drilling and consideration of the filter or gravel pack grain-size. A *sieve analyses* is often conducted in order to select the optimum size of slot for the application. During a sieve analyses for well screen, determination samples are screened through various sizes of sieves. The *sieve size that retains 40% of total aquifer sample is normally used to select the well screen and associated filter pack material.*

The sieve analyses results will indicate in decimal inches what size slot may be used.

For Example: A sieve analyses indicates that a 40% share of a sample from an aquifer is retained in a .050 sieve. This suggests that the well screen slot size should be .050 inches wide and that a filter pack of .050 or larger may be used within that portion of the aquifer.

However, unless the entire aquifer is uniform in composition, it is always possible that the ideal slot size for one interval may not be ideal in another. This is why the collection of samples during drilling is so important. It is not unusual to have a single well-constructed with several different slot sizes over variable intervals.

It is still possible though to identify a single slot size that may be effective throughout the screened interval by varying the filter pack size and adjusting the slot size to the smallest observed 40% retention sieve analyses result. Not only are there numerous types of casing and slot sizes, but there are also many different types of well screen.

A few of the more common types of well screen are: *wire wrapped, continuous screen, slotted, louvered, and perforated screens.*



All except wire wrapped are available in various types of metal or PVC composition. Again, the appropriate selection depends on local regulations, use, type of aquifer, depth, water quality, location and possibly much more. Therefore, *please refer to your driller and regulatory agency for the proper selection or recommended well screen.*

As a rule, wire wrapped screen or continuous screen is normally used in municipal applications where a *high yield* is obtained from *unconsolidated* to *semi-consolidated* formations.

Slotted and perforated screens are stronger and less expensive than wire wrapped screens and are best suited to deep applications, where borehole stability is a concern, and in domestic applications. Louvered screen is used in high yield production wells but particularly in filter packed wells and may help where *cascading water* is a problem.

### **Louvers**

The louvers deflect groundwater above *pumping levels* back into the annulus or filter pack so that *air entrainment* and corrosion within the well are minimized. Air entrainment occurs when cascading water drops into the pumping water level creating turbulence and making bubbles. These bubbles may get drawn into a *vortex* created by the pump and then included in the water pumped from the well.

Once the casing and screen specifications are determined, they may be installed into the well. Due to weight, casing is often installed with a drill rig. If a well is *telescoped*, the driller will install the largest diameter portions first.

Gravel or filter packs can then be installed. A bentonite or *cement plug* is often installed in the bottom of the borehole before the filter pack is installed, effectively sealing the bottom of the casing and borehole.

If certain intervals of the well need to be isolated from others, *inflatable packers* and bentonite or cement grout may be used. The inflatable packer is used to seal off a portion of the annulus to prevent the mixing of the seal material and the filter pack.

These types of seals are commonly used for wells constructed within confined aquifers so that they may be isolated to prevent cross connection with other aquifers or formations. Well *centralizers* are normally installed on the screen and casing before installation. The centralizers are a type of banding or metal offset that, when installed, ensures the casing and screen do not rest up against the borehole walls.

The centralizers will minimize the potential of *bridging* during the installation of filter media and grout. When complete, the well casing is *capped* and normally must terminate at least 12 inches above ground level. Once the well construction is completed it may be developed.

## Specialized Well Construction Information

*(Please check with your regulating agency and well driller to ensure your well is properly constructed)*

### Fractured Formations

Wells obtaining water from fractured formations such as limestone or granite are susceptible to contamination. Contaminated water can move rapidly through these types of formations. Therefore, proper well location and construction are very important when drilling wells in these types of formations. When the **overburden** overlying the upper bedrock formation is less than 30 feet thick, the well casing should extend to a depth of at least 40 feet below ground level.

The annular space between the well bore and the casing should also be pressure grouted. Where the well is drilled to obtain water from a formation located below a fractured formation, the casing should extend at least through the fractured formation and be seated in firm rock or clay. Where the overburden overlying the upper bedrock formation is greater than 30 feet thick, the casing should be fitted with a drive shoe and driven to a firm seat in the bedrock. The annular space around the casing can then be sealed with Bentonite grout or neat cement grout.

### Auger Drilled Wells

As opposed to smaller diameter drilled wells, auger wells are generally constructed at locations where aquifers (water bearing geologic formations) are both shallow and low yielding. An aquifer that yields only 1 gallon per minute will provide 1,440 gallons per day. Auger wells range in depth from 30 to 100 feet.

To compensate for low-yielding aquifers, large diameter auger wells serve as storage reservoirs to provide water during periods of high demand. An auger well with a diameter of 3 feet, a total depth of 50 feet and a water depth of 30 feet, contains approximately 1,600 gallons of water.

***There are two recommended methods for the construction of auger wells.***

#### 1) Auger (bored) Well with Buried Slab Construction

Auger wells are usually constructed utilizing the buried slab method. With this method, the upper well casing shall extend to a depth of 10 feet or more below ground surface and be firmly imbedded in a uniformly tapered hole that is formed when the reinforced concrete buried slab is manufactured, or shall be connected to a pipe cast in the concrete slab.

The upper well casing should be at least 4 inches in diameter and extend from the concrete slab to at least 8 inches above the finished ground surface.

A bentonite seal that is a minimum of 12 inches in thickness shall be installed over the buried slab the entire diameter of the borehole. The earth fill on top of the buried slab and around the upper well casing should be well compacted and mounded to drain away from the well.

Sand or gravel cannot be used as fill on top of the buried slab. The lower concrete casing is normally constructed using pre-cast concrete sections ranging in diameter from 2 to 3 feet.

The diameter of the well bore hole below the buried slab must be at least 4 inches greater than the outer diameter of the well casing, and the annular space (opening between concrete casing and well bore) must be filled with pea gravel to the well bottom.

The discharge pipe exits the well below grade through an approved *pitless* well adapter. A pitless well adapter is a mechanical device attached to the well casing pipe, usually below frost level, that permits water to pass through the wall of the casing and provides protection to the well and water from contamination. An approved vented well cap or seal should be properly installed on top of the well casing. As an alternative, the discharge pipe can exit at the top of the well casing through an approved well seal. If the pump is located away from the well, the buried pipe leading to the pump from the well must be encased in a pressure discharge line at system pressure.

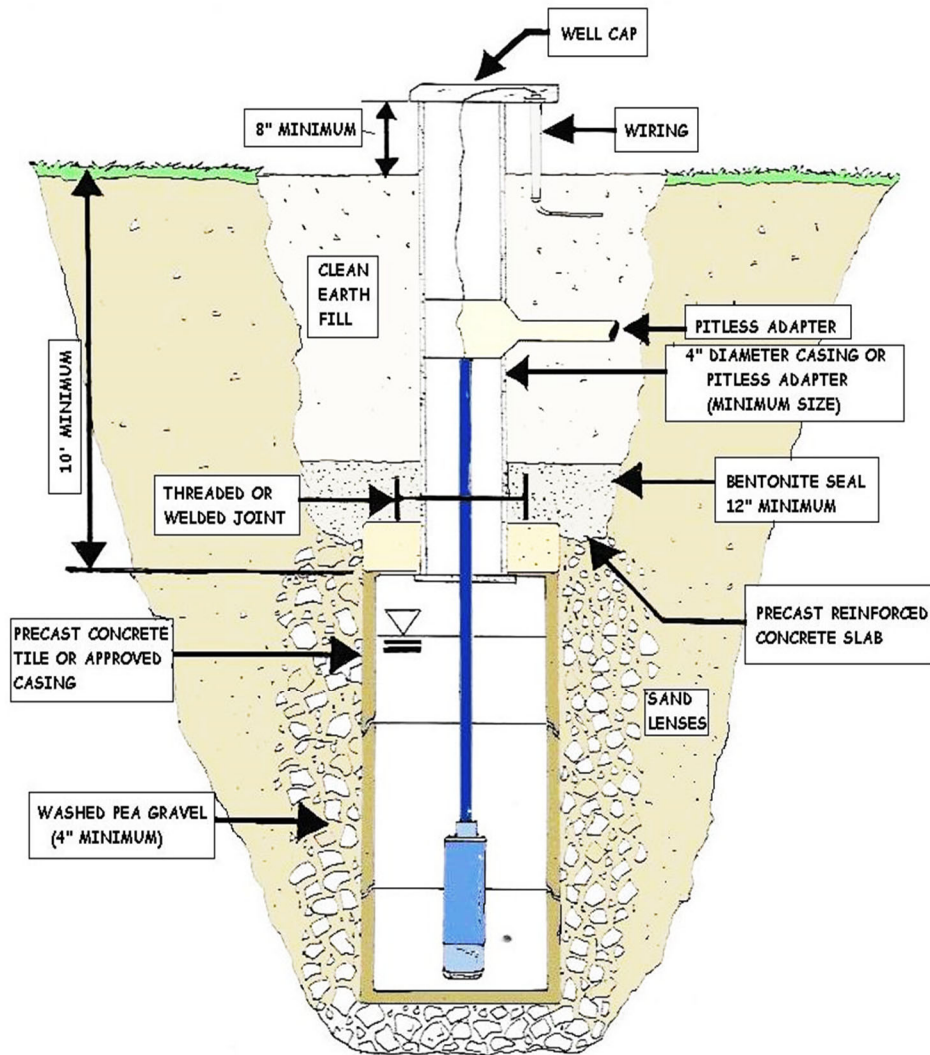

**(EXAMPLE ONLY – CHECK STATE OR LOCAL REQUIRMENTS)**



## Auger (Bored) Well with Concrete Collar

For auger wells not finished with a buried slab, the concrete casing also ranges in diameter from 2 to 3 feet. The annular space between the excavation and the installed casing should be grouted with concrete that is at least 6 inches thick and poured without construction joints from a minimum of 10-20 feet below ground level to the ground surface. The diameter of the well bore hole below the grouting must be at least 4 inches greater than the outside diameter of the well casing and the annular space should be filled with pea gravel to the well bottom.

The casing should extend at least 8-12 inches above the finished ground surface. The cover slab must be at least 4 inches thick, without joints, adequately reinforced and with a diameter sufficient to extend to the outer edge of the casing.

Adequate sized pipe sleeve(s) should be cast in place in the slab to accommodate the type of pump or pump piping proposed for the well.

A watertight joint must be made where the slab rests on the well casing. If a manhole is installed, it should consist of a curb cast in the slab and extend 4 inches above the slab. A watertight cover must be provided over the manhole and should overhang the curb at least 2 inches. The discharge pipe must exit the well in a watertight manner at the top of the well casing through an approved well seal.

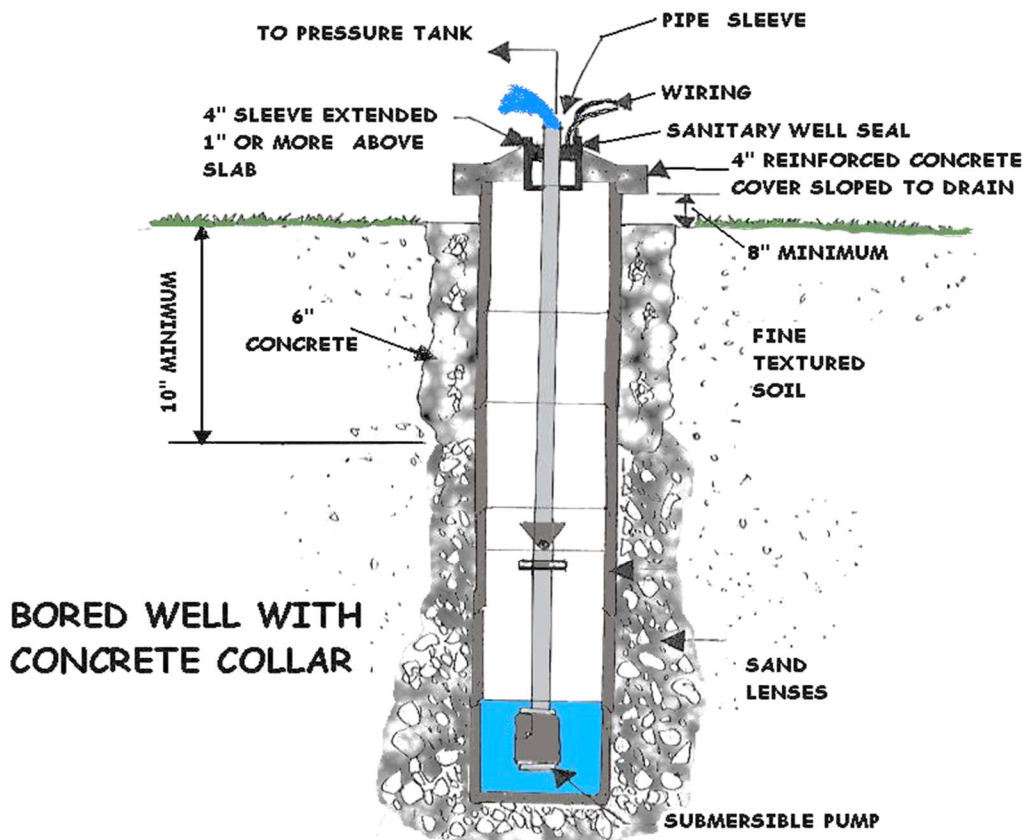

### **Why is EPA taking a risk-based approach to protect drinking water provided by ground water systems?**

An evaluation of data on outbreaks and the occurrence of waterborne viral and bacterial pathogens and indicators of fecal contamination in ground water supplying public water system (PWS) wells indicate that there is a subset of ground water systems (GWS) that are susceptible to fecal contamination. Therefore, in 1996, Congress amended the Safe Drinking Water Act (SDWA) to require that EPA take a targeted risk-based approach to require GWSs that are identified as being at the greatest risk of contamination to take action to protect public health. Previously, the 1986 Amendments to the SDWA had included a provision that would have required all PWSs using ground water to disinfect. This would have posed a great implementation challenge for approximately 147,000 GWSs and states.

### **What types of pathogens can be found in water provided by ground water systems?**

Ground water that is susceptible to fecal contamination may contain harmful viruses or bacteria. Viral pathogens found in GWSs may include enteric viruses such as Echovirus, Hepatitis A and E, Rotavirus and Noroviruses (i.e., Norwalk-like viruses) and enteric bacterial pathogens such as Escherichia coli (including E. coli O157:H7), Salmonella species, Shigella species, and Vibrio cholerae. Ingestion of these pathogens can cause gastroenteritis or, in certain rare cases, serious illnesses such as meningitis, hepatitis, or myocarditis. Health implications in sensitive subpopulations may be severe (e.g., hemolytic uremic syndrome) and may cause death.

### **What causes contamination of groundwater?**

Viral and bacterial pathogens are present in human and animal feces, which can, in turn, contaminate drinking water. Fecal contamination can reach ground water sources, including drinking water wells, from failed septic systems, leaking sewer lines, and by passing through the soil and large cracks in the ground. Fecal contamination from the surface may also get into a drinking water well along its casing or through cracks if the well is not properly constructed, protected, or maintained.

### **Does this rule address private wells? If not, how does EPA help protect them?**

This rule does not address private wells because they are not under the jurisdiction of the Safe Drinking Water Act and are therefore not subject to EPA regulation. EPA has provided outreach material to states and homeowners to help them understand how to manage individual wells. EPA recommends that well owners periodically test their water for microbial and chemical contaminants and properly maintain their well. Information is available on EPA's Private Wells Web site.

### **What are the basic requirements of the rule?**

The risk-targeting strategy incorporated into the rule provides for: regular sanitary surveys of public water systems to look for significant deficiencies in key operational areas; triggered source water monitoring when a system that does not sufficiently disinfect drinking water identifies a positive sample during its Total Coliform Rule monitoring and assessment monitoring (at the option of the state) targeted at high-risk systems; implementation of corrective actions by ground water systems with a significant deficiency or evidence of source water fecal contamination to reduce the risk of contamination; and compliance monitoring for systems that are sufficiently disinfecting drinking water to ensure that the treatment is effective at removing pathogens.



## Well Development Sub-Section

Once well construction is complete, the well is *developed*. The purpose of well development is to *purge* the well and bore of all drilling mud and or fluid, fine grained sediment, and loose aquifer matter.

The well development process also helps to settle the gravel or filter pack and/or rearrange particles within the well and nearby aquifer to allow for the most efficient operation of the well. Not surprisingly, the drilling procedure often damages the aquifer around the well.

Well development can significantly improve a well's performance by essentially repairing as much of this damage as possible by improving the transition from the aquifer to the well. The screened and productive portions of the well can be subjected to various development techniques.

All methods of well development essentially involve the flushing of water back and forth between the well and aquifer.

If you think of the aquifer as one great big *natural media filter*, the development process to a well is much the same as the backwashing process for a water treatment system. So what about hard rock wells?

Wells constructed in hard rock aquifers are not composed of unconsolidated sediments. Still, they can and should be developed because fine cuttings, drilling mud, and clay within the *fractures* and *pore spaces* near the well can obstruct flow from otherwise productive zones.

Well development procedures can remove such sediments from hard rock wells also. Several common methods of well development include, surge-block, jetting, airlift, and pump surging.

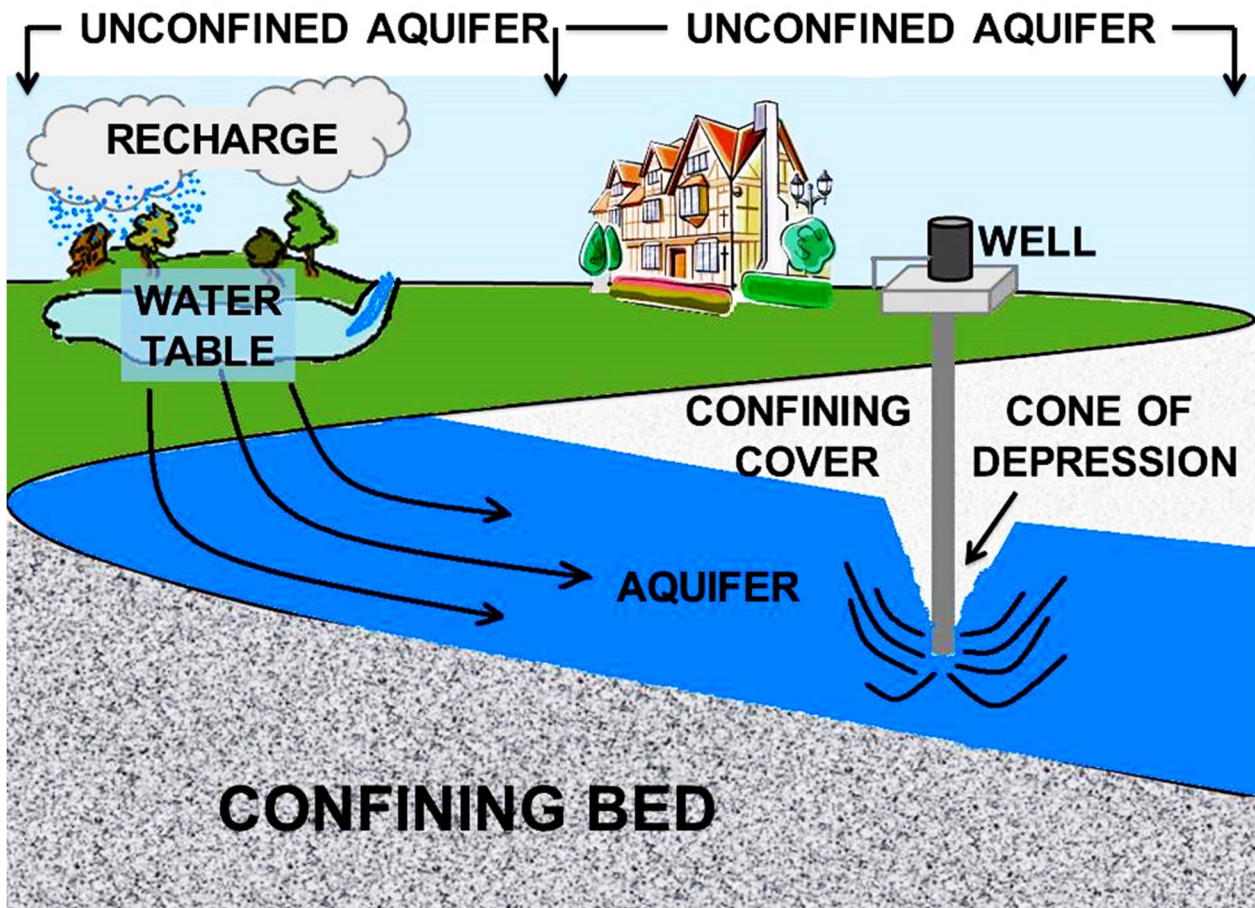

## Well Surging or Backwashing

**Pump surging** (sometimes called **Rawhiding**) involves the repeated pumping and resting of the well for well development purposes. A column of water that is withdrawn through a pump is allowed to surge back into the well by turning the pump on and off repeatedly. However, sufficient time for the pump motor to stop reverse rotation must be allowed, such that pump damage can be avoided.

Occasionally, water is pumped to waste until it is clear of sediment before again shutting the pump off. This is done to permanently remove the sediments that are being developed by the backwashing action. The process continues until sufficient quantities of water produced are consistently clean.

**Surge-blocks, swabs, or plungers** are disc shaped devices made to fit tightly within the well. Their edges are usually fitted with rubber or leather rings to make a tight seal against the well casing. Pipe sections are then attached to the surge-block to lower it into the well, above the well screen, and about 15 feet below the water level. The assembly is then repeatedly lifted up and down. The up and down action of the surge-block creates suction, and compression strokes that force water in and out of the well through the screened interval, gravel pack, and aquifer. It works like a plunger in the way that it removes small obstructions and sediments from the well. The surge-block is slowly lowered each time resistance begins to decrease.

Once the top of the screen is reached, the assembly may be removed and accumulated sediment either bailed or airlifted out of the well. Surging within known problem areas of the screened interval may be conducted also. The cycle of swabbing and removing sediment should be continued until resistance to the action of the swab or block is significantly lower than at the start of development. The development is complete when the amount of sediment removed is both significantly and consistently less than when surging began.

**Airlifting** (or **Air surging**) involves the introduction of large short blasts of air within the well that lifts the column of water to the surface and then drop it back down again. Continuous airlifting or **air pumping** from the bottom of the well is then used occasionally to lift sediments out of the well. Airlift development is most often used following initial pump surging, and is employed to confirm that the well is productive, since the injection of air into a plugged well may result in casing or screen failure.

Air lifting development is most often done with a rotary drilling rig through the drill string. Sometimes special air diffusers or jets are used to direct the bursts of air into preferred directions (see jetting). Piping is inserted into the well and intermittent blasts of air are introduced as the piping is slowly lowered into the well. Sometimes surfactant or drill foam is added to aid in the efficiency of sediment removal and cleaning of the well.

Air surging development is much the same as drilling the well with air rotary; only the well has already been constructed. Specialized air development units are available independent of a drilling rig, which may be used as well. The great thing about air rotary drilled wells is that they are essentially developed while drilling, particularly in hard rock formations, when greater than 100 gallons per minute is being lifted to the surface. The development of a filter pack (if used) in such wells is still recommended.

**Jetting** is a type of well development technique in which water and/or air is *jetted* or sprayed horizontally into the well screen. This method is especially suited for application in *stratified* and *unconsolidated* formations. The water or air is forced through *nozzles* in a specially designed *jetting tool* (or simply drilled pipe and fittings) at high velocities.

Normally, air lifting or pumping is used in conjunction with jetting methods in order to minimize potential damage to the well bore. Jetting with water alone can be so powerful that the sediment, which is supposed to be removed, can be forced into the formation causing clogging problems.

This is why pumping or airlifting while jetting with water is so important. Jetting is normally conducted from the bottom of the well screen upwards.

### Rotary Rig

A rotary rig is often used to provide the fluid or air with sustained pressure while the tool is slowly raised up through the screen. As jetting proceeds, sediment is occasionally removed from the bottom of the well bore thru the use of a bailer or airlifting. Several passes should be made over the length of screen until sediment generation drops off.

Air is normally used for jetting in shallow aquifers (less than 300 feet of submergence) due to limited supply pressures. Jetting in PVC constructed wells is not recommended since the high velocities of fluid and sediment can erode and possibly cut through the plastic well screen.

In addition, wells constructed with louvered or slotted screen limit the effectiveness of jetting. In these types of wells, surging may be more effective.

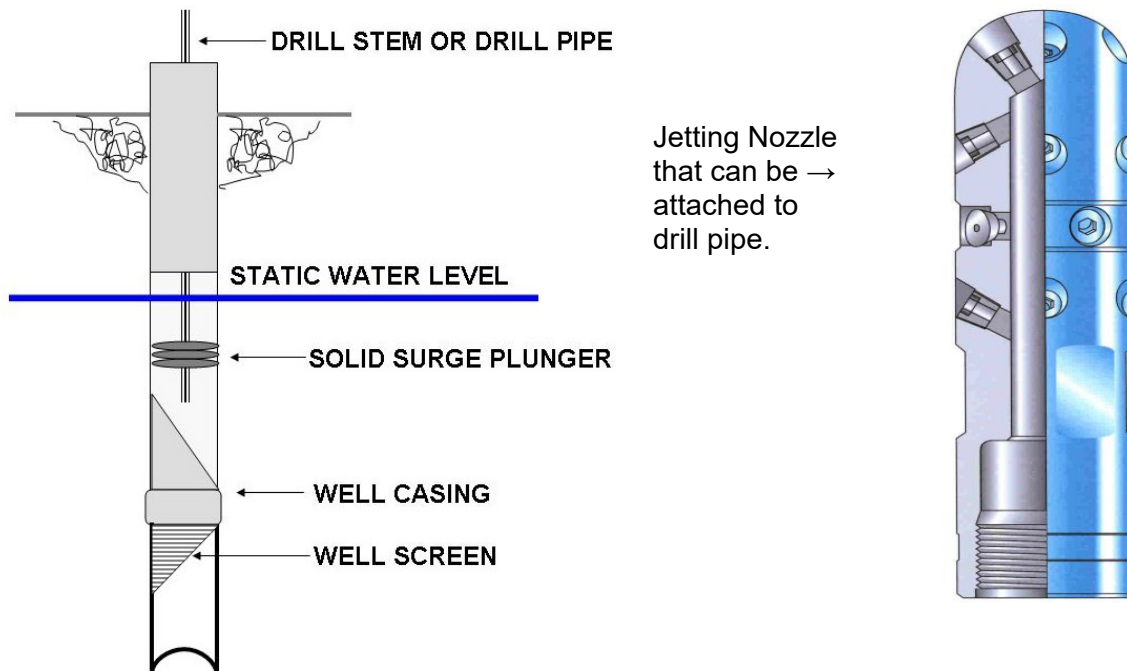

In the best of situations, a combination of methods can be used to ensure the efficient development and operation of a well.

## Selecting an Optimum Pumping Rate

Before a well can be completed with the necessary pumping equipment, it should be tested for capacity and proper operation. When the well was drilled, the driller and geologist kept close watch of the amount of water production that had been obtained.

The development techniques used can also be useful in estimating a well's production rate. However, the driller will normally know what to expect based on his experience, and the geologist or *hydrologist* will also obtain information on other nearby wells to bracket the expected production rate. If the well was drilled with air rotary, the *airlift* at the time of drilling also can serve as a baseline to estimate the well's production rate. Either way, the well is normally pump tested following well development.

A *pumping test* is normally conducted for at least eight hours in order to estimate a well's maximum production rate. Ideally, a twenty-four-hour step test is conducted. A step test is a *variable rate* pumping test, typically conducted for 24 hours at up to six different pumping rates. Typically, the well will be pumped at the lower estimated maximum pumping rate for the first four hours.

The pumping rate is then adjusted upwards in equal amounts every four hours until 24 hours of pumping have been completed. The personnel conducting the test keep track of the water levels in the well to ensure that the steps are not too large and not too small.

In the end, the optimum pumping rate is selected following a careful review and comparison of the water level data for each rate. The well's *specific capacity* ( $Sc$ ) is then determined. Specific capacity is the gallons per minute the well can produce per foot of drawdown. Specific capacities for each of the pumping steps are compared. The highest  $Sc$  observed is normally associated with the optimum pumping rate. That rate should also have resulted in *stabilized* pumping levels or *drawdown*.



Well pumping test being conducted in photograph above. (Notice the portable electric generator for powering the pump. The Hydrogeologist is using a depth probe to measure the drop in the static water level.)

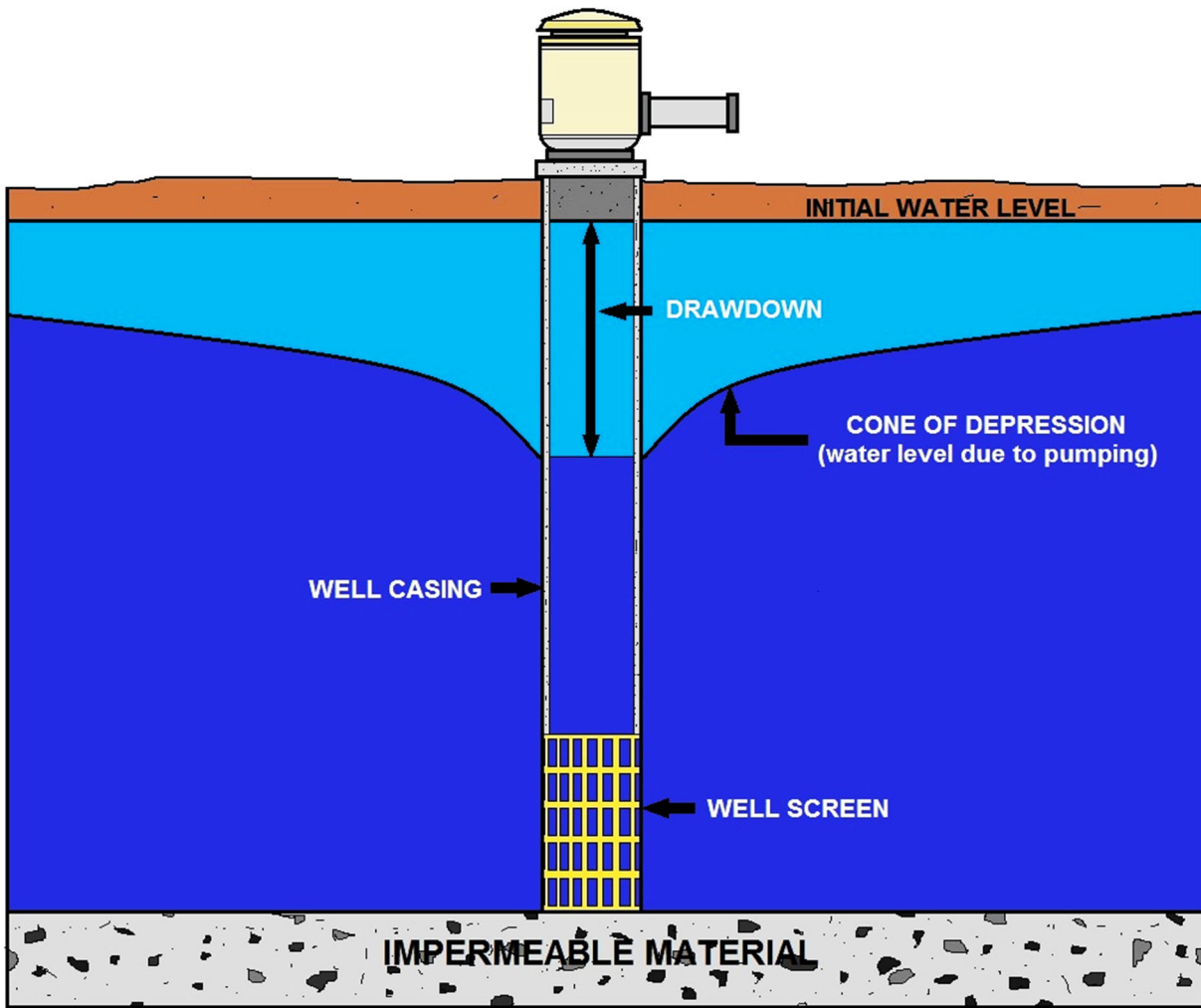

**CONE OF DEPRESSION CAUSED BY PUMPING**



## Well Pump Selection Sub-Section



A drill rig in the snow.

Basically, a well is a hole drilled into an aquifer. A pipe and a pump are used to pull water out of the ground, and a screen filters out unwanted particles that could clog the pipe. Wells come in different shapes and sizes, depending on the type of material the well is drilled into and how much water is being pumped out.

### Three Basic Types of Wells

**Bored** or **shallow wells** are usually bored into an unconfined water source, generally found at depths of 100 feet or less.

**Consolidated** or **rock wells** are drilled into a formation consisting entirely of a natural rock formation that contains no soil and does not collapse. Their average depth is about 250 feet.

**Unconsolidated** or **sand wells** are drilled into a formation consisting of soil, sand, gravel, or clay material that collapses upon itself.

## Selection of Pumping Equipment

The proper selection of pumping equipment for a well is of great importance. The primary factors that must be considered before selecting the well pump are: flow rate, line pressure, pumping lift (total dynamic head), power requirements (and limitations), and size of piping. Each of these components must be considered together when selecting well pumps.

### Pumping Lift and Total Dynamic or Discharge Head

The most important components in selecting the correct pump for your application are: *total pumping lift* and *total dynamic or discharge head*. Total dynamic head refers to the total equivalent feet of lift that the pump must overcome in order to deliver water to its destination, including frictional losses in the delivery system.

### Basic Pump Operating Characteristics

"Head" is a term commonly used with pumps. Head refers to the height of a vertical column of water. Pressure and head are interchangeable concepts in irrigation, because a column of water 2.31 feet high is equivalent to 1 pound per square inch (PSI) of pressure. The total head of a pump is composed of several types of head that help define the pump's operating characteristics.

### Total Dynamic Head

The total dynamic head of a pump is the sum of the total static head, the pressure head, the friction head, and the velocity head.

**The Total Dynamic Head (TDH) is the sum of the total static head, the total friction head and the pressure head.**

### Total Static Head

The total static head is the total vertical distance the pump must lift the water. When pumping from a well, it would be the distance from the pumping water level in the well to the ground surface plus the vertical distance the water is lifted from the ground surface to the discharge point. When pumping from an open water surface, it would be the total vertical distance from the water surface to the discharge point.

### Pressure Head

The pressure head at any point where a pressure gauge is located can be converted from pounds per square inch (PSI) to feet of head by multiplying by 2.31. For example, 20 PSI is equal to 20 times 2.31 or 46.2 feet of head. Most city water systems operate at 50 to 60 PSI, which, as illustrated in Table 1, explains why the centers of most city water towers are about 130 feet above the ground.

**Table 1. Pounds per square inch (PSI) and equivalent head in feet of water.**

<b>PSI</b>	<b>Head (feet)</b>
0	0
5	11.5
10	23.1
15	34.6
20	46.2
25	57.7
30	69.3
35	80.8
40	92.4
45	104
50	115
55	127
60	138
65	150
70	162
75	173
80	185
85	196
90	208
95	219
100	231

### **Friction Head**

Friction head is the energy loss or pressure decrease due to friction when water flows through pipe networks. The velocity of the water has a significant effect on friction loss. Loss of head due to friction occurs when water flows through straight pipe sections, fittings, valves, around corners, and where pipes increase or decrease in size.

Values for these losses can be calculated or obtained from friction loss tables. The friction head for a piping system is the sum of all the friction losses.

### **Velocity Head**

Velocity head is the energy of the water due to its velocity. This is a very small amount of energy and is usually negligible when computing losses in an irrigation system.

### **Suction Head**

A pump operating above a water surface is working with a suction head. The suction head includes not only the vertical suction lift, but also the friction losses through the pipe, elbows, foot valves, and other fittings on the suction side of the pump. There is an allowable limit to the suction head on a pump and the net positive suction head (NPSH) of a pump sets that limit.

The theoretical maximum height that water can be lifted using suction is 33 feet. Through controlled laboratory tests, manufacturers determine the NPSH curve for their pumps. The NPSH curve will increase with increasing flow rate through the pump. At a certain flow rate, the NPSH is subtracted from 33 feet to determine the maximum suction head at which that pump will operate.

For example, if a pump requires a minimum NPSH of 20 feet the pump would have a maximum suction head of 13 feet.

Due to suction pipeline friction losses, a pump rated for a maximum suction head of 13 feet may effectively lift water only 10 feet. To minimize the suction pipeline friction losses, the suction pipe should have a larger diameter than the discharge pipe.

Operating a pump with suction lift greater than it was designed for, or under conditions with excessive vacuum at some point in the impeller, may cause cavitation. Cavitation is the implosion of bubbles of air and water vapor and makes a very distinct noise like gravel in the pump. The implosion of numerous bubbles will eat away at an impeller and it eventually will be filled with holes.

### **Pump Power Requirements**

The power added to water as it moves through a pump can be calculated with the following formula:

$$\text{WHP} = \frac{Q \times \text{TDH}}{3960} \quad (1)$$

where:

- WHP = Water Horse Power
- Q = Flow rate in gallons per minute (GPM)
- TDH = Total Dynamic Head (feet)

However, the actual power required to run a pump will be higher than this because pumps and drives are not 100 percent efficient. The horsepower required at the pump shaft to pump a specified flow rate against a specified TDH is the **Brake Horsepower** (BHP) which is calculated with the following formula:

$$\text{BHP} = \frac{\text{WHP}}{\text{Pump Eff.} \times \text{Drive Eff.}} \quad (2)$$

**BHP** -- Brake Horsepower (continuous horsepower rating of the power unit).

**Pump Eff.** -- Efficiency of the pump usually read from a pump curve and having a value between 0 and 1.

**Drive Eff.** -- Efficiency of the drive unit between the power source and the pump. For direct connection this value is 1, for right angle drives the value is 0.95 and for belt drives it can vary from 0.7 to 0.85.

### Effect of Speed Change on Pump Performance

The performance of a pump varies with the speed at which the impeller rotates. **Theoretically**, varying the pump speed will result in changes in flow rate, TDH and BHP according to the following formulas:

$$\frac{\text{RPM}_2}{\text{RPM}_1} \times \text{GPM}_1 = \text{GPM}_2 \quad (3)$$

$$\left(\frac{\text{RPM}_2}{\text{RPM}_1}\right)^2 \times \text{TDH}_1 = \text{TDH}_2 \quad (4)$$

$$\left(\frac{\text{RPM}_2}{\text{RPM}_1}\right)^3 \times \text{BHP}_1 = \text{BHP}_2 \quad (5)$$

where:

RPM<sub>1</sub> = Initial revolutions per minute setting

RPM<sub>2</sub> = New revolutions per minute setting

GPM = Gallons per Minute  
(subscripts same as for RPM)

TDH = Total Dynamic Head  
(subscripts same as for RPM)

BHP = Brake Horsepower  
(subscripts same as for RPM)

As an example, if the RPM are increased by 50 percent, the flow rate will increase by 50 percent, the TDH will increase 2.25 times, and the required BHP will increase 3.38 times that required at the lower speed. It is easy to see that with a speed increase the BHP requirements of a pump will increase at a **faster rate** than the head and flow rate changes.

### Pump Efficiency

Manufacturers determine by tests the operating characteristics of their pumps and publish the results in pump performance charts commonly called "**pump curves**."

**A typical pump curve for a horizontal centrifugal pump. NPSH is the Net Positive Suction Head required by the pump and TDSL is the Total Dynamic Suction Lift available (both at sea level).**

All pump curves are plotted with the flow rate on the horizontal axis and the TDH on the vertical axis. The curves in a pump curve are for a centrifugal pump tested at different RPM. Each curve indicates the GPM versus TDH relationship at the tested RPM.

In addition, pump efficiency lines have been added and wherever the efficiency line crosses the pump curve lines **that** number is what the efficiency is at that point. Brake horsepower (BHP) curves have also been added; they slant down from left to right. The BHP curves are calculated using the values from the efficiency lines. At the top of the chart is an NPSH curve with its scale on the right side of the chart.

### Reading a Pump Curve

When the desired flow rate and TDH are known, these curves are used to select a pump. The pump curve shows that a pump will operate over a wide range of conditions. However, it will operate at peak efficiency only in a narrow range of flow rate and TDH.

As an example of how a pump characteristic curve is used, let's use the pump curve to determine the horsepower and efficiency of this pump at a discharge of 900 gallons per minute (**GPM**) and 120 feet of TDH.

**Solution:** Follow the dashed vertical line from 900 GPM until it crosses the dashed horizontal line from the 120 feet of TDH. At this point the pump is running at a peak efficiency just below 72 percent, at a speed of 1600 RPM.

If you look at the BHP curves, this pump requires just less than 40 BHP on the input shaft.

A more accurate estimate of BHP can be calculated with equations 1 and 2. Using equation 1, the WHP would be  $[900 \times 120] / 3960$  or 27.3, and from equation 2 the BHP would be  $27.3 / 0.72$  or 37.9, assuming the drive efficiency is 100 percent.

The NPSH curve was used to calculate the Total Dynamic Suction Lift (TDSL) markers at the bottom of the chart. Notice that the TDSL at 1400 GPM is 10 feet, but at 900 GPM the TDSL is over 25 feet.

## Changing Pump Speed

In addition, suppose this pump is connected to a diesel engine. By varying the RPM of the engine we can vary the flow rate, the TDH and the BHP requirements of this pump. As an example, let's change the speed of the engine from 1600 RPM to 1700 RPM. What effect does this have on the GPM, TDH and BHP of the pump?

**Solution:** We will use equations 3, 4 and 5 to calculate the change. Using equation 3, the change in GPM would be  $(1700/1600) \times 900$ , which equals 956 GPM. Using equation 4, the change in TDH would be  $(1700/1600)^2 \times 120$ , which equals 135.5 feet of TDH. Using equation 5, the change in BHP would be  $(1700/1600)^3 \times 37.9$ , which equals 45.5 BHP. Note that the new operating point is up and to the right of the old point and that the efficiency of the pump has remained the same.

When a pump has been selected for installation, a copy of the pump curve should be provided by the installer. In addition, if the impeller(s) was trimmed, this information should also be provided. This information will be valuable in the future, especially if repairs have to be made.

### Determining Friction Losses

A well system installer and/or engineer can help in determining the friction losses in the distribution system. There are numerous friction loss tables with values of equivalent feet of head for given flow rates and types and diameters of pipe available. However, unless great distances or small diameter pipes are used, friction loss is almost negligible. The lift requirements for the pump primarily include the height to which the pump must deliver the water from the wellhead, plus the distance from the pumping level to the land surface.

**For example:** A municipal supply well has been tested and determined to yield 500gpm. The well was constructed with 10-inch casing that has been perforated from 200 to 500 feet below the ground surface within an unconfined aquifer. The static water level has been measured at 100 feet while the drawdown at 500gpm has been estimated at 80 feet. The full level of the storage tank for the well exerts about 87psi at the wellhead and is connected to the well via a 12-inch distribution main. Three-phase power is available and 4-inch column pipe is to be used down the hole. The pump intake is to be set at 180 feet.

Before we can select an appropriate pump, we first need to determine what the total dynamic head is. After referring to a friction loss table for flow in 4 inch and 12-inch pipe; we determine that the friction losses in the 4-inch pipe will be about 24 feet per 100 foot, while losses in the 12 inch main are negligible.

This leads us to determine that there will be about 43 feet of friction loss through the 4-inch pipe. We also know that the total lift is equal to the drawdown, plus the distance to the land surface from the static water level, plus the vertical distance to the full level of the storage tank.

We know from physics that for every foot of water there is .433psi of pressure or 2.31ft of head for every 1 psi. The line pressure at the well head is equal to the height of the column of water above the well head, which gives us a line pressure at the well head of 87psi or 200 feet of water.

The total lift from the pump to the wellhead 180 feet and equivalent to 78psi. So the total dynamic head is equivalent to a lift of 380 feet or an equivalent pressure of about 165psi at the pump, plus about 43 feet of friction loss.

Therefore, in order to pump 500gpm under these circumstances, the pump that is selected should have its most efficient operating range in the neighborhood of 423 feet total lift. We then look at *performance curves* from the various pump manufacturers to determine the best pump and power combination for the application.

Because this is a municipal supply well that is pumping directly into the distribution system, we will choose a submersible turbine for the job rather than a line shaft turbine, which must be lubricated. Upon looking at the *curves* for this application, one will find that a 75HP, 8in, 5 stage, submersible pump will do the job most efficiently without risking the over-pumping of the well.

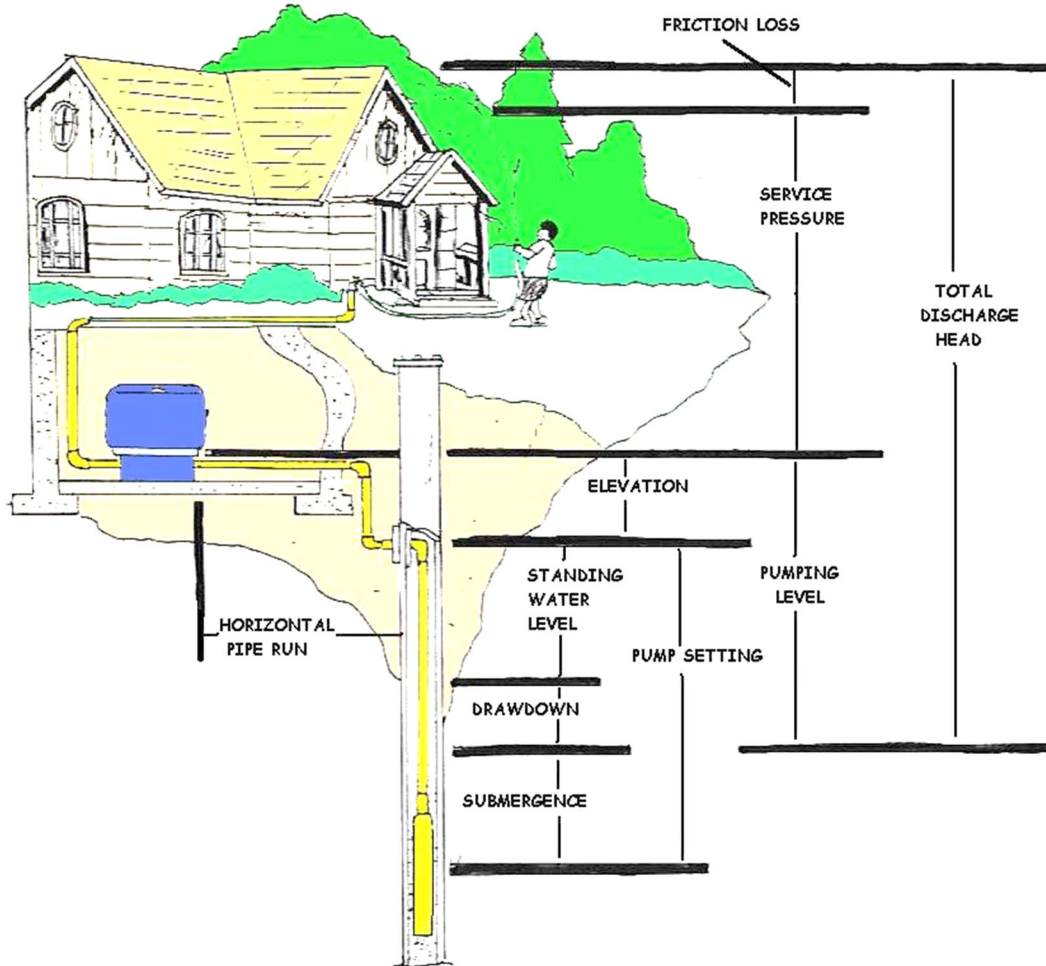

Elements of Total Dynamic Head for the proper selection of pumping equipment.





A new 8-inch submersible pump and motor with 6-inch column pipe about to be installed in a high capacity municipal supply well.

## The Well Head Assembly

An approved well cap or seal is to be installed at the *wellhead* to prevent any contamination from entering the well through the top once construction is complete. When the well is completed with pumping equipment a well vent is also required.

The well *vent pipe* should be at least  $\frac{1}{2}$  inch in diameter, 8 inches above the finished grade, and be turned down, with the opening screened with a minimum 24-mesh durable screen to prevent entry of insects. Only approved well casing material meeting the requirements of the Code may be utilized.

In addition, frost protection should be provided by use of insulation or pump house. Turbine and submersible pumps are normally used. Any pressure, vent, and electric lines to and from the pump should enter the casing only through a watertight seal.

Pumps and pressure tanks may be located in basements and enclosures. However, wells should not be located within vaults or pits, except with a *variance permit*.

If the pump discharge line passes through the well casing underground, an approved *pitless adapter* should be installed.

The *well manifold* should include an air relief valve, flow meter, sample port, isolation valve, and a check valve. If the well should need rehabilitation, additional construction, or repair, it must be done in compliance with the State or Local Water Well Construction Codes.



## Groundwater Production System Post Quiz

1. Toxic material spilled or dumped near a well can leach into \_\_\_\_\_ and contaminate the groundwater drawn from that well.
2. Many terms are used to describe the nature and extent of the groundwater resource, the level below which all the spaces are filled with water is called the?
3. Above the water table lies the?
4. \_\_\_\_\_ may move in different directions below the ground than the water flowing on the surface.
5. Unconfined aquifers are those that are bounded by the water table. Some aquifers lie beneath layers of impermeable materials.  
A. True                      B. False
6. Clay has many spaces between its grains, but the spaces are not large enough to permit free movement of water.  
A. True                      B. False
7. \_\_\_\_\_ usually flows downhill with the slope of the water table.

### Cone of Depression

8. When pumping begins, water begins to flow towards the well in contrast to the natural direction of groundwater movement.  
A. True                      B. False
9. \_\_\_\_\_ describes a three-dimensional inverted cone surrounding the well that represents the volume of water removed as a result of pumping.
10. \_\_\_\_\_ is the vertical drop in the height between the water level in the well prior to pumping and the water level in the well during pumping.
11. When a well is installed in \_\_\_\_\_, water moves from the aquifer into the well through small holes or slits in the well casing or, in some types of wells, through the open bottom of the well.

### **Where Is Ground Water Stored?**

12. Areas where ground water exists in sufficient quantities to supply wells or springs are called aquifers, a term that literally means?

13. If the aquifer is sandwiched between layers of relatively impermeable materials, it is called?

14. Confined aquifers are not sandwiched between layers of relatively impermeable materials, and their upper boundaries are generally closer to the surface of the land.

A. True      B. False

### **Groundwater Quality**

15. The layers of soil and particles of sand, gravel, crushed rocks, and larger rocks were thought to act as filters, trapping contaminants before they could reach the ground water.

A. True      B. False

### **Water Use or Demand**

16. Water system demand comes from a number of sources including residential, commercial, industrial and public consumers as well as waste and some?

17. The combination of storage reservoirs and distribution lines must be capable of meeting consumers' needs for pressure at all times.

A. True      B. False

18. The quantity of water used in any community varies from 100 to 200 gallons per person per day.

A. True      B. False

**Answers** 1. Aquifer, 2. Water table, 3. Unsaturated zone, 4. Groundwater, 5. True, 6. True, 7. Groundwater, 8. True, 9. Cone of depression, 10. Drawdown, 11. An unconfined aquifer, 12. Water bearer, 13. Confined aquifer, 14. False, 15. True, 16. Unavoidable loss, 17. False, 18. False

## Section 11- Electrical Motors

**Section Focus:** You will learn the basics of an electric motor. At the end of this section, you will be able to describe commonly found electrical motors used in water production. There is a post quiz at the end of this section to review your comprehension and a final examination in the Assignment for your contact hours.

**Scope/Background:** Electrical motors are common throughout the water/wastewater field. These motors require repair work from highly trained and skilled technicians.



An **electric motor** is an electrical machine that converts electrical energy into mechanical energy. Most electric motors operate through the interaction between the motor's magnetic field and electric current in a wire winding to generate force in the form of rotation of a shaft.

Electric motors can be powered by direct current (DC) sources, such as from batteries, motor vehicles or rectifiers, or by alternating current (AC) sources, such as a power grid, inverters or electrical generators.

An electric generator is mechanically identical to an electric motor, but operates in the reverse direction, converting mechanical energy into electrical energy.

Electric motors may be classified by considerations such as power source type, internal construction, application and type of motion output. In addition to AC versus DC types, motors may be brushed or brushless, may be of various phase (see single-phase, two-phase, or three-phase), and may be either air-cooled or liquid-cooled.

General-purpose motors with standard dimensions and characteristics provide convenient mechanical power for industrial use. The largest electric motors are used for ship propulsion, pipeline compression and pumped-storage applications with ratings reaching 100 megawatts.

Electric motors are found in industrial fans, blowers and pumps, machine tools, household appliances, power tools and disk drives. Small motors may be found in electric watches.

Electric motors produce linear or rotary force (torque) and can be distinguished from devices such as magnetic solenoids and loudspeakers that convert electricity into motion but do not generate usable mechanical force, which are respectively referred to as actuators and transducers.

## Electrical Motor Section - Introduction

The power source of the pump is usually an electric motor. The motor is connected by a coupling to the pump shaft. The purpose of the bearings is to hold the shaft firmly in place, yet allow it to rotate. The bearing house supports the bearings and provides a reservoir for the lubricant. An impeller is connected to the shaft. The pump assembly can be a vertical or horizontal set-up; the components for both are basically the same.

### Motors

The purpose of this discussion on pump motors is to identify and describe the main types of motors, starters, enclosures and motor controls, as well as to provide you with some basic maintenance and troubleshooting information. Although pumps may be driven by diesel or gasoline engines, pumps driven by electric motors are commonly used in our industry.

**There are two general categories of electric motors:**

- D-C motors, or direct current
- A-C motors, or alternating current

You can expect most motors at facilities to be A-C type.

### D-C Motors

The important characteristic of the D-C motor is that its speed will vary with the amount of voltage used. There are many different kinds of D-C motors, depending on how they are wound and their speed/torque characteristics.



### A-C Motors

There are a number of different types of alternating current motors, such as Synchronous, Induction, wound rotor, and squirrel cage. The synchronous type of A-C motor requires complex control equipment, since they use a combination of A-C and D-C. This also means that the synchronous type of A-C motor is used in large horsepower sizes, usually above 250 HP. The induction type motor uses only alternating current. The squirrel cage motor provides a relatively constant speed. The wound rotor type could be used as a variable speed motor.

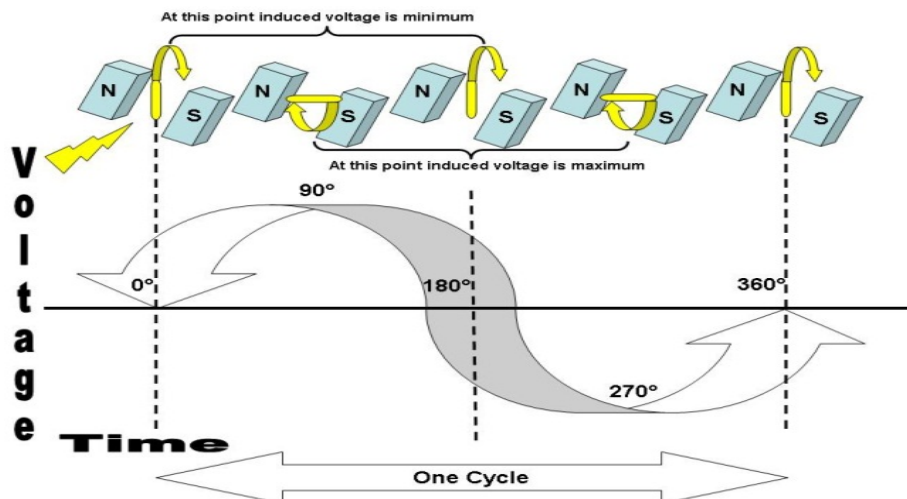

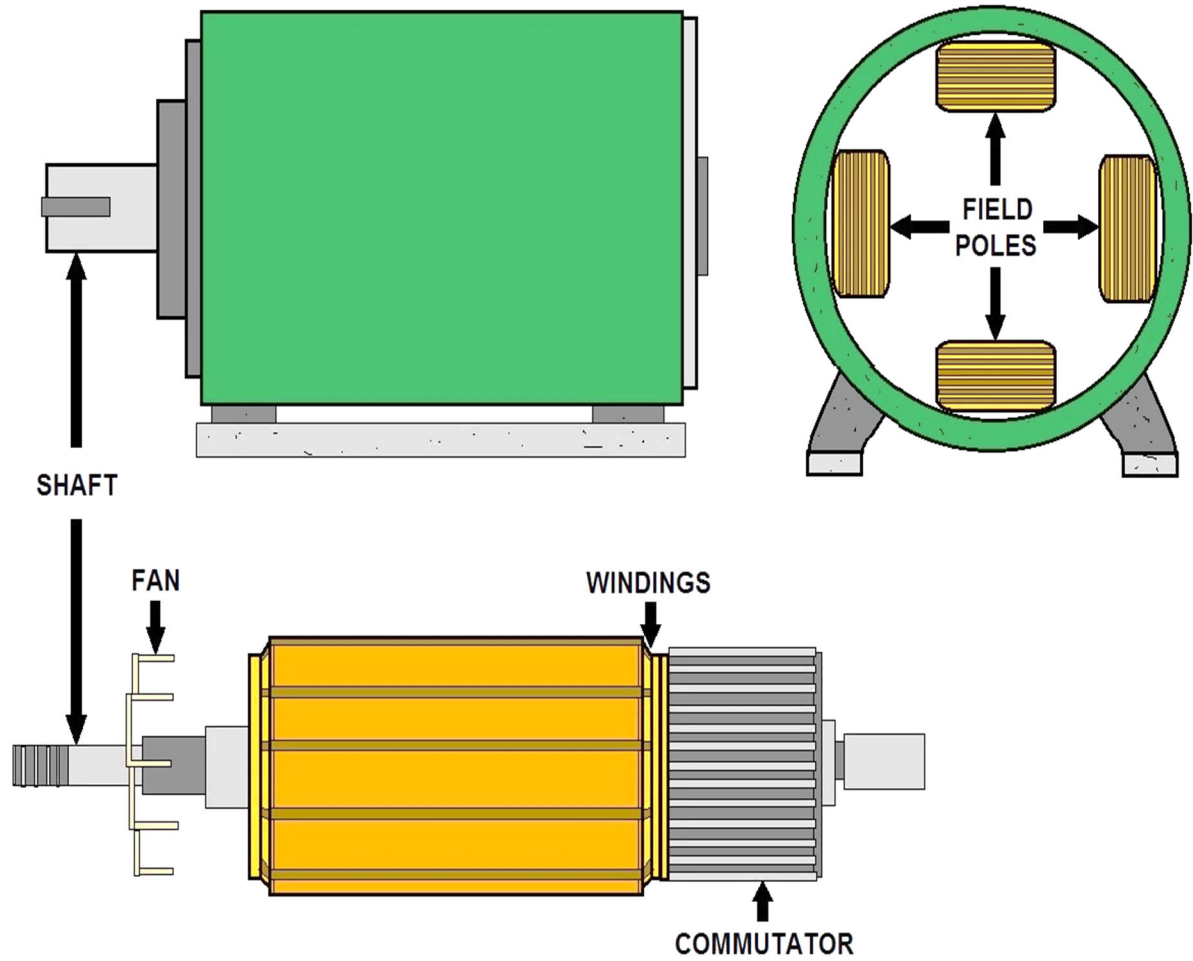

**DC ELECTRIC MOTOR DIAGRAM EXAMPLE**

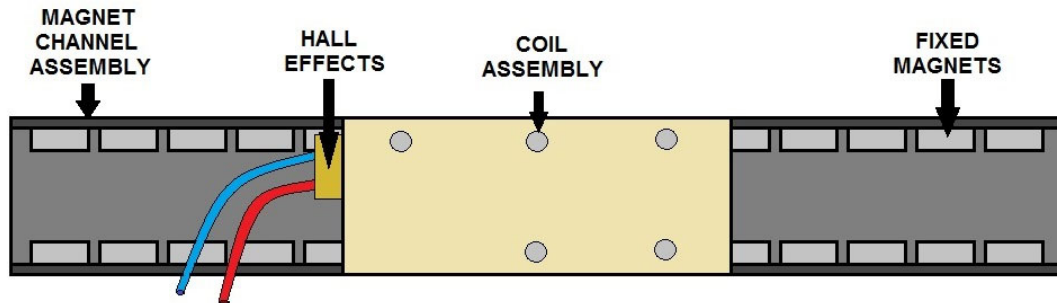

**LINEAR MOTOR**

Electric Induction Motor that produces Straight-Line motion by means of a Linear Stator and Rotor placed in Parallel



**Define the Following Terms:**

Voltage:

EMF:

Power:

Current:

Resistance:

Conductor:

Phase:

Single Phase:

Three Phase:

Hertz:

**Motor Starters**

All electric motors, except very small ones such as chemical feed pumps, are equipped with starters, either full voltage or reduced voltage. This is because motors draw a much higher current when they are starting and gaining speed. The purpose of the reduced voltage starter is to prevent the load from coming on until the amperage is low enough.

**Motor Enclosures**

Depending on the application, motors may need special protection. Some motors are referred to as open motors. They allow air to pass through to remove heat generated when current passes through the windings. Other motors use specific enclosures for special environments or safety protection.

Can you think of any locations within your facility that requires special enclosures?



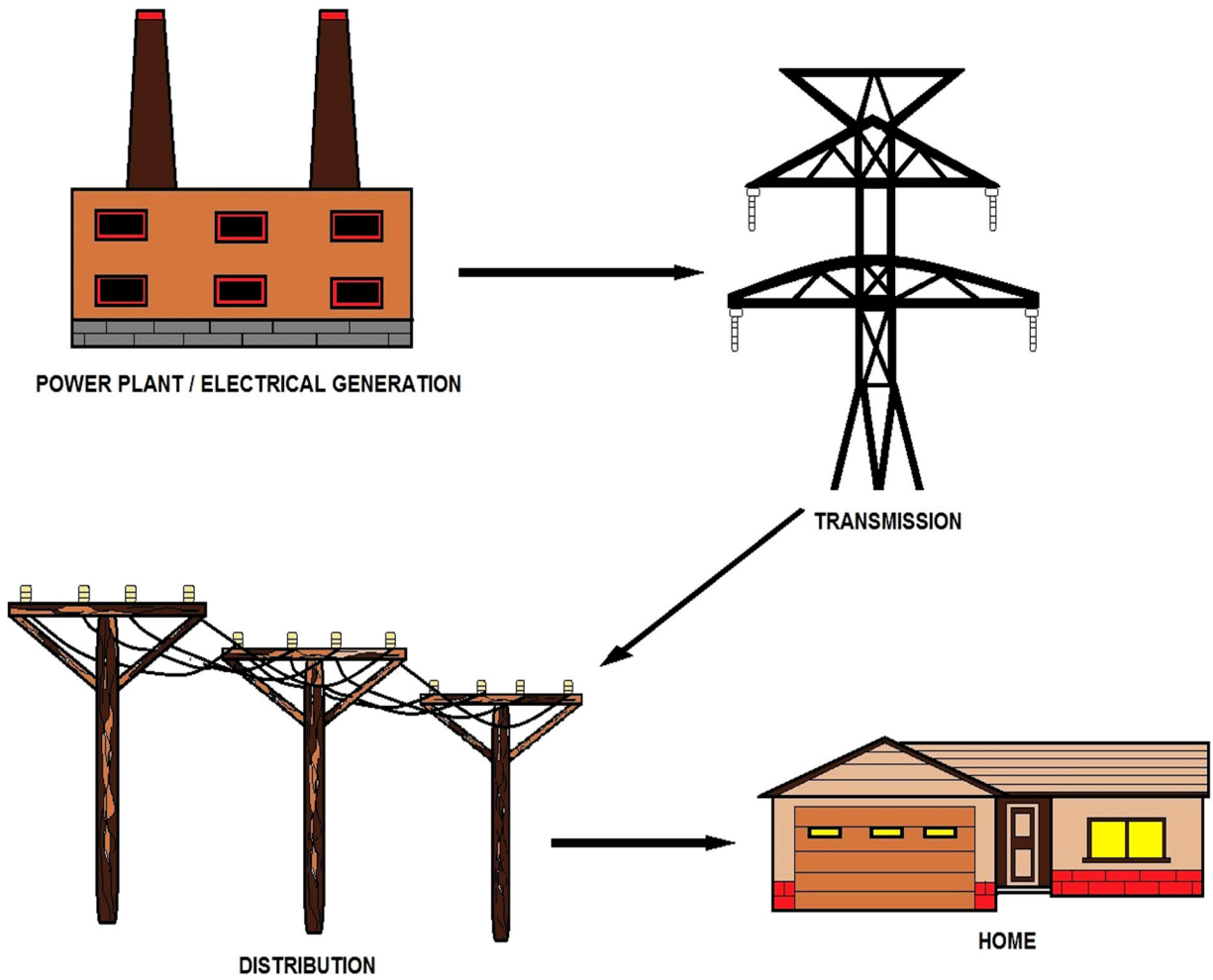

## HOW ELECTRICITY GETS TO CONSUMERS (USERS)

## Two Types of Totally Enclosed Motors Commonly Used

- ☞ **TENV**, or totally enclosed non-ventilated motor
- ☞ **TEFC**, or totally enclosed fan cooled motor

Totally enclosed motors include dust-proof, water-proof and explosion-proof motors. An explosion proof enclosure must be provided on any motor where dangerous gases might accumulate.

### Motor Controls

All pump motors are provided with some method of control, typically a combination of manual and automatic. Manual pump controls can be located at the central control panel, at the pump, or at the suction or discharge points of the liquid being pumped.

There are a number of ways in which automatic control of a pump motor can be regulated:

- ☞ Pressure and vacuum sensors
- ☞ Preset time intervals
- ☞ Flow sensors
- ☞ Level sensors

Two typical level sensors are the float sensor and the bubbler regulator. The float sensor is pear-shaped and hangs in the wet well.

As the height increases, the float tilts, and the mercury in the glass tube flows toward the end of the tube that has two wires attached to it. When the mercury covers the wires, it closes the circuit.



For a bubbler level sensor, a low pressure air supply is allowed to escape from a bubbler pipe in the wet well. The back-pressure on the air supply will vary with the liquid level over the pipe. Sensitive air pressure switches will detect this change and use this information to control pump operation.

### Motor Maintenance

Motors should be kept clean, free of moisture, and lubricated properly. Dirt, dust, and grime will plug the ventilating spaces and can actually form an insulating layer over the metal surface of the motor.

***What condition would occur if the ventilation becomes blocked?***



## Moisture

Moisture harms the insulation on the windings to the point where they may no longer provide the required insulation for the voltage applied to the motor. In addition, moisture on windings tend to absorb acid and alkali fumes, causing damage to both insulation and metals. To reduce problems caused by moisture, the most suitable motor enclosure for the existing environment will normally be used. It is recommended to run stand by motors to dry up any condensation which accumulates in the motor.

## Motor Lubrication

Friction will cause wear in all moving parts, and lubrication is needed to reduce this friction. It is very important that all your manufacturer's recommended lubrication procedures are strictly followed. You have to be careful not to add too much grease or oil, as this could cause more friction and generate heat.

### **To grease the motor bearings, this is the usual approach:**

1. Remove the protective plugs and caps from the grease inlet and relief holes.
2. Pump grease in until fresh starts coming from the relief hole.

If fresh grease does not come out of the relief hole, this could mean that the grease has been pumped into the motor windings. The motor must then be taken apart and cleaned by a qualified service representative.

### **To change the oil in an oil lubricated motor, this is the usual approach:**

1. Remove all plugs and let the oil drain.
2. Check for metal shearing (pieces of metal in the oil.)
3. Replace the oil drain.
4. Add new oil until it is up to the oil level plug.
5. Replace the oil level and filter plug.

Never mix oils, since the additives of different oils when combined can cause breakdown of the oil.

## Type of Motor Commutation

Self-Commutated			Externally Commutated	
Mechanical-Commutator Motors		Electronic-Commutator (EC) Motors	Asynchronous Machines	Synchronous Machines
AC	DC	AC	AC	
<ul style="list-style-type: none"> <li>• Universal motor (AC commutator series motor or AC/DC motor)</li> <li>• Repulsion motor</li> </ul>	<p>Electrically excited DC motor:</p> <ul style="list-style-type: none"> <li>• Separately excited</li> <li>• Series</li> <li>• Shunt</li> <li>• Compound</li> </ul> <p>PM DC motor</p>	<p>With PM rotor:</p> <ul style="list-style-type: none"> <li>• BLDC motor</li> </ul> <p>With ferromagnetic rotor:</p> <ul style="list-style-type: none"> <li>• SRM</li> </ul>	<p>Three-phase motors:</p> <ul style="list-style-type: none"> <li>• SCIM</li> <li>• WRIM</li> </ul> <p>AC motors:</p> <ul style="list-style-type: none"> <li>• Capacitor</li> <li>• Resistance</li> <li>• Split</li> <li>• Shaded-pole</li> </ul>	<p>Three-phase motors:</p> <ul style="list-style-type: none"> <li>• WRSM</li> <li>• PMSM or BLAC motor               <ul style="list-style-type: none"> <li>○ IPMSM</li> <li>○ SPMSM</li> </ul> </li> <li>• Hybrid</li> </ul> <p>AC motors:</p> <ul style="list-style-type: none"> <li>• Permanent-split capacitor</li> <li>• Hysteresis</li> <li>• Stepper</li> <li>• SyRM</li> <li>• SyRM-PM hybrid</li> </ul>
Simple electronics	Rectifier, linear transistor(s) or DC chopper	More elaborate electronics	Most elaborate electronics (VFD), when provided	

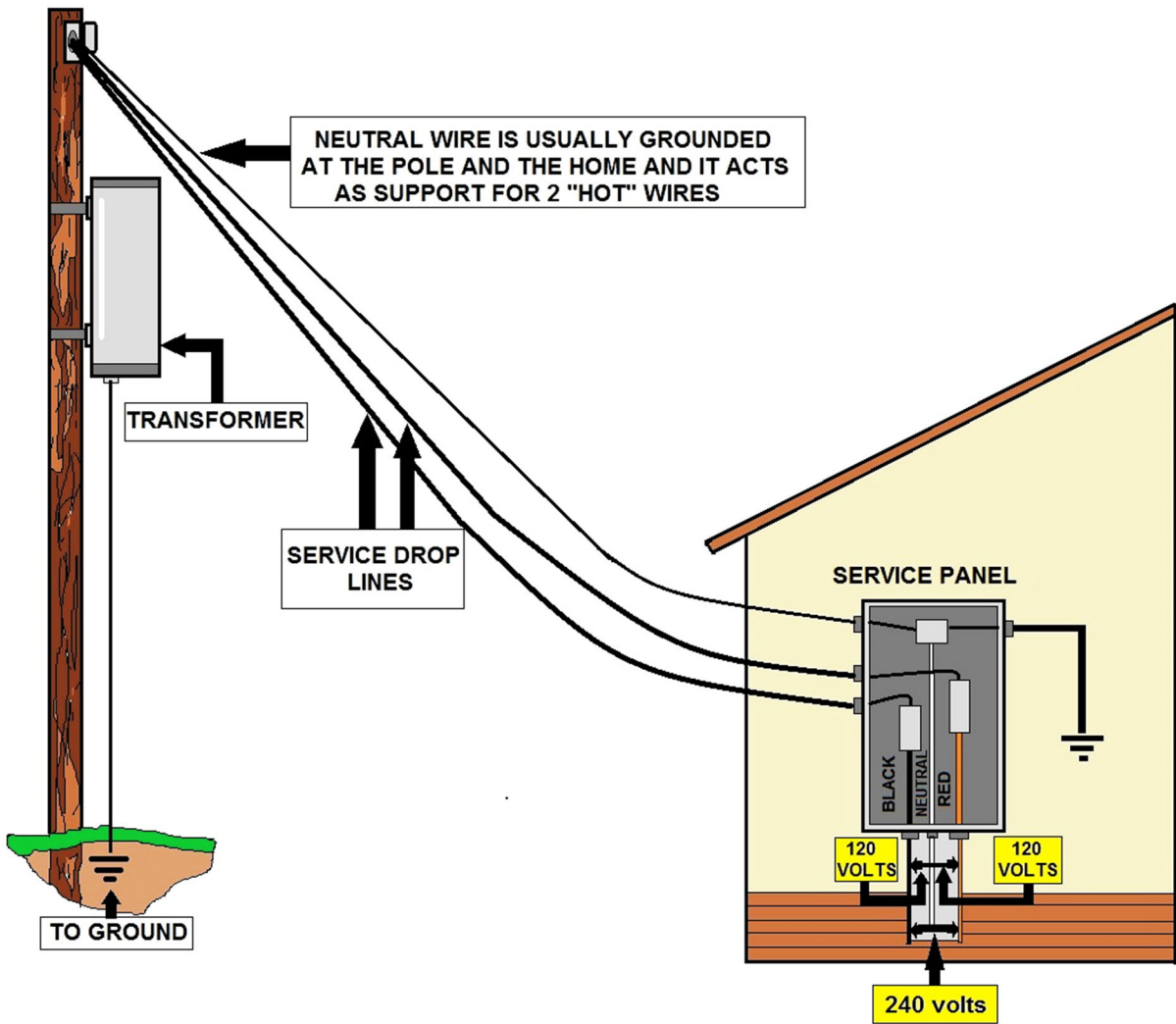

**BASIC HOME ELECTRICITY  
(120/240 VOLTS)**

## Understanding Motors

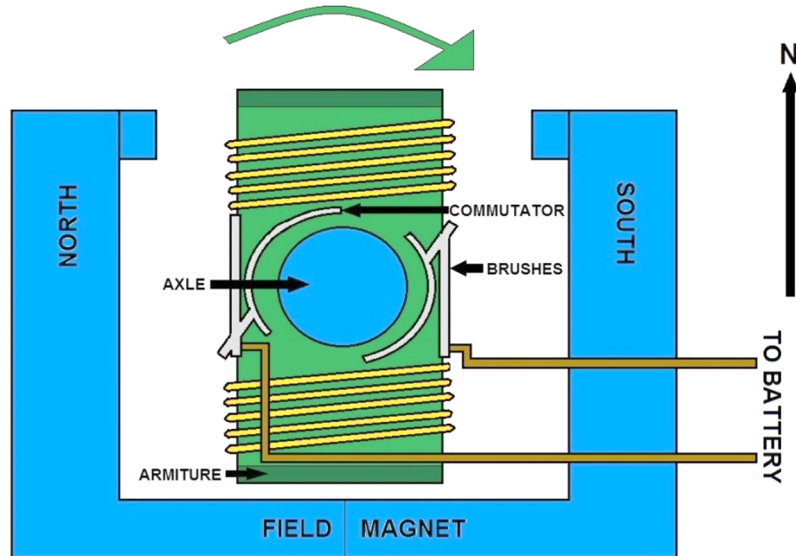

The classic division of electric motors has been that of Direct Current (DC) types vs. Alternating Current (AC) types. This is more a de facto convention, rather than a rigid distinction. For example, many classic DC motors run happily on AC power.

The ongoing trend toward electronic control further muddles the distinction; as modern drivers have moved the commutator out of the motor shell. For this new breed of motor, driver circuits are relied upon to generate sinusoidal AC drive currents, or some approximation of. The two best examples are: the brushless DC motor and the stepping motor, both being polyphase AC motors requiring external electronic control.

There is a clearer distinction between a synchronous motor and asynchronous types. In the synchronous types, the rotor rotates in synchrony with the oscillating field or current (e.g. permanent magnet motors). In contrast, an asynchronous motor is designed to slip; the most ubiquitous example being the common AC induction motor which must slip in order to generate torque.

A DC motor is designed to run on DC electric power. Two examples of pure DC designs are Michael Faraday's homopolar motor (which is uncommon), and the ball bearing motor, which is (so far) a novelty. By far the most common DC motor types are the brushed and brushless types, which use internal and external commutation respectively to create an oscillating AC current from the DC source -- so they are not purely DC machines in a strict sense.

### Brushed DC motors

The classic DC motor design generates an oscillating current in a wound rotor with a split ring commutator, and either a wound or permanent magnet stator. A rotor consists of a coil wound around a rotor which is then powered by any type of battery. Many of the limitations of the classic commutator DC motor are due to the need for brushes to press against the commutator. This creates friction.

At higher speeds, brushes have increasing difficulty in maintaining contact. Brushes may bounce off the irregularities in the commutator surface, creating sparks. This limits the maximum speed of the machine.

The current density per unit area of the brushes limits the output of the motor. The imperfect electric contact also causes electrical noise. Brushes eventually wear out and require replacement, and the commutator itself is subject to wear and maintenance. The commutator assembly on a large machine is a costly element, requiring precision assembly of many parts.

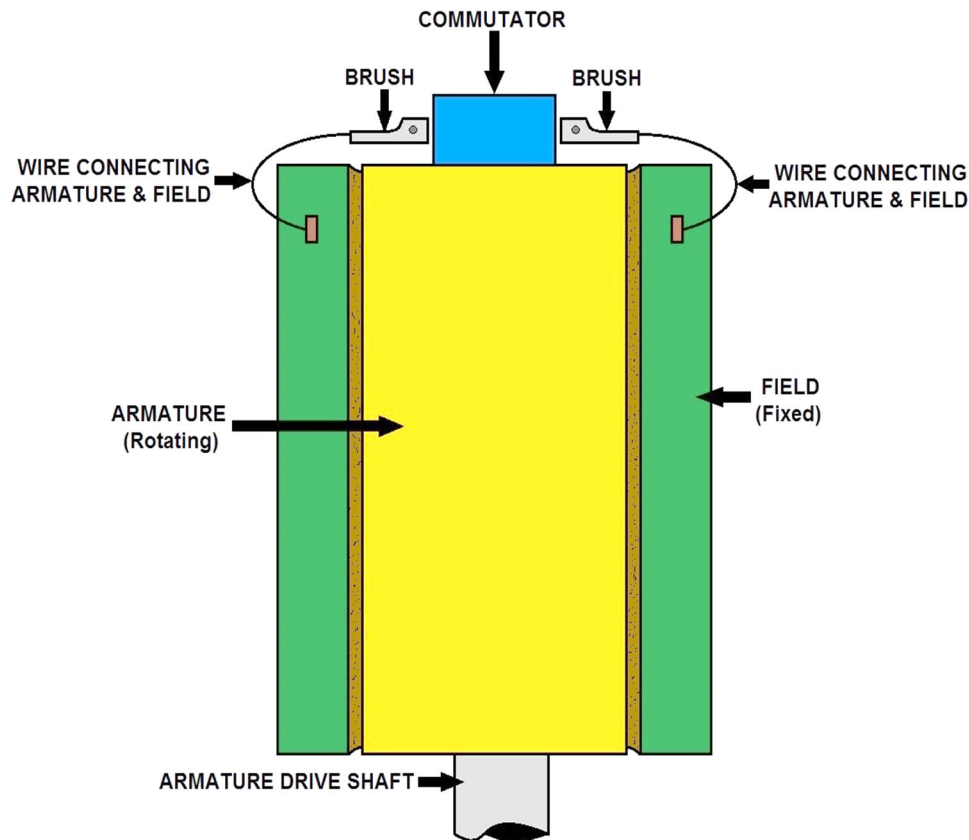

**DIAGRAM SHOWING MECHANICAL CONSTRUCTION  
OF A DC SERIES WOUND MOTOR**

### **Brushless DC Motors**

Some of the problems of the brushed DC motor are eliminated in the brushless design. In this motor, the mechanical "rotating switch" or commutator/brush gear assembly is replaced by an external electronic switch synchronized to the rotor's position. Brushless motors are typically 85-90% efficient, whereas DC motors with brush gear are typically 75-80% efficient.

Midway between ordinary DC motors and stepper motors lies the realm of the brushless DC motor. Built in a fashion very similar to stepper motors, these often use a permanent magnet external rotor, three phases of driving coils, one or more Hall Effect sensors to sense the position of the rotor, and the associated drive electronics.



The coils are activated one phase after the other by the drive electronics, as cued by the signals from the Hall effect sensors. In effect, they act as three-phase synchronous motors containing their own variable-frequency drive electronics. Brushless DC motors are commonly used where precise speed control is necessary, as in computer disk drives or in video cassette recorders, the spindles within CD, CD-ROM (etc.) drives, and mechanisms within office products such as fans, laser printers, and photocopiers.

**They have several advantages over conventional motors:**

\* Compared to AC fans using shaded-pole motors, they are very efficient, running much cooler than the equivalent AC motors. This cool operation leads to much-improved life of the fan's bearings.

\* Without a commutator to wear out, the life of a DC brushless motor can be significantly longer compared to a DC motor using brushes and a commutator. Commutation also tends to cause a great deal of electrical and RF noise; without a commutator or brushes, a brushless motor may be used in electrically sensitive devices like audio equipment or computers.

\* The same Hall Effect sensors that provide the commutation can also provide a convenient tachometer signal for closed-loop control (servo-controlled) applications. In fans, the tachometer signal can be used to derive a "fan OK" signal.

\* The motor can be easily synchronized to an internal or external clock, leading to precise speed control.

\* Brushless motors have no chance of sparking, unlike brushed motors, making them better suited to environments with volatile chemicals and fuels.

\* Brushless motors are usually used in small equipment such as computers, and are generally used to get rid of unwanted heat.

\* They are also very quiet motors, which is an advantage if being used in equipment that is affected by vibrations.

Modern DC brushless motors range in power from a fraction of a watt to many kilowatts. Larger brushless motors up to about 100 kW rating are used in electric vehicles. They also find significant use in high-performance electric model aircraft.

**Coreless DC Motors**

Nothing in the design of any of the motors described above requires that the iron (steel) portions of the rotor actually rotate; torque is exerted only on the windings of the electromagnets. Taking advantage of this fact is the coreless DC motor, a specialized form of a brush or brushless DC motor. Optimized for rapid acceleration, these motors have a rotor that is constructed without any iron core. The rotor can take the form of a winding-filled cylinder inside the stator magnets, a basket surrounding the stator magnets, or a flat pancake (possibly formed on a printed wiring board) running between upper and lower stator magnets.

The windings are typically stabilized by being impregnated with electrical epoxy potting systems. Filled epoxies that have moderate mixed viscosity and a long gel time. These systems are highlighted by low shrinkage and low exotherm.

Because the rotor is much lighter in weight (mass) than a conventional rotor formed from copper windings on steel laminations, the rotor can accelerate much more rapidly, often achieving a mechanical time constant under 1 ms. This is especially true if the windings use aluminum rather than the heavier copper. But because there is no metal mass in the rotor to act as a heat sink, even small coreless motors must often be cooled by forced air.

These motors were commonly used to drive the capstan(s) of magnetic tape drives and are still widely used in high-performance servo-controlled systems, like radio-controlled vehicles/aircraft, humanoid robotic systems, industrial automation, medical devices, etc.

### **Universal Motors**

A variant of the wound field DC motor is the universal motor. The name derives from the fact that it may use AC or DC supply current, although in practice they are nearly always used with AC supplies.

The principle is that in a wound field DC motor the current in both the field and the armature (and hence the resultant magnetic fields) will alternate (reverse polarity) at the same time, and hence the mechanical force generated is always in the same direction. In practice, the motor must be specially designed to cope with the AC current (impedance must be taken into account, as must the pulsating force), and the resultant motor is generally less efficient than an equivalent pure DC motor.

Operating at normal power line frequencies, the maximum output of universal motors is limited and motors exceeding one kilowatt are rare. But universal motors also form the basis of the traditional railway traction motor in electric railways. In this application, to keep their electrical efficiency high, they were operated from very low frequency AC supplies, with 25 Hz and 16 2/3 hertz operation being common. Because they are universal motors, locomotives using this design were also commonly capable of operating from a third rail powered by DC.

The advantage of the universal motor is that AC supplies may be used on motors which have the typical characteristics of DC motors, specifically high starting torque and very compact design if high running speeds are used. The negative aspect is the maintenance and short life problems caused by the commutator. As a result, such motors are usually used in AC devices such as food mixers and power tools which are used only intermittently.

Continuous speed control of a universal motor running on AC is very easily accomplished using a thyristor circuit, while stepped speed control can be accomplished using multiple taps on the field coil. Household blenders that advertise many speeds frequently combine a field coil with several taps and a diode that can be inserted in series with the motor (causing the motor to run on half-wave rectified AC).

## AC Motor Sub-Section

In 1882, Nicola Tesla identified the rotating magnetic field principle, and pioneered the use of a rotary field of force to operate machines. He exploited the principle to design a unique two-phase induction motor in 1883. In 1885, Galileo Ferraris independently researched the concept. In 1888, Ferraris published his research in a paper to the Royal Academy of Sciences in Turin.

Introduction of Tesla's motor from 1888 onwards initiated what is sometimes referred to as the Second Industrial Revolution, making possible the efficient generation and long distance distribution of electrical energy using the alternating current transmission system, also of Tesla's invention (1888). Before the invention of the rotating magnetic field, motors operated by continually passing a conductor through a stationary magnetic field (as in homopolar motors). Tesla had suggested that the commutators from a machine could be removed and the device could operate on a rotary field of force. Professor Poeschel, his teacher, stated that would be akin to building a perpetual motion machine.

### Components

**A typical AC motor consists of two parts:**

1. An outside stationary stator having coils supplied with AC current to produce a rotating magnetic field, and;
2. An inside rotor attached to the output shaft that is given a torque by the rotating field.

### Torque motors

A torque motor is a specialized form of induction motor which is capable of operating indefinitely at stall (with the rotor blocked from turning) without damage. In this mode, the motor will apply a steady stall torque to the load (hence the name).

A common application of a torque motor would be the supply- and take-up reel motors in a tape drive. In this application, driven from a low voltage, the characteristics of these motors allow a relatively-constant light tension to be applied to the tape whether or not the capstan is feeding tape past the tape heads.

Driven from a higher voltage, (and so delivering a higher torque), the torque motors can also achieve fast-forward and rewind operation without requiring any additional mechanics such as gears or clutches. In the computer world, torque motors are used with force feedback steering wheels.

### Slip Ring

The slip ring or wound rotor motor is an induction machine where the rotor comprises a set of coils that are terminated in slip rings to which external impedances can be connected. The stator is the same as is used with a standard squirrel cage motor. By changing the impedance connected to the rotor circuit, the speed/current and speed/torque curves can be altered.

The slip ring motor is used primarily to start a high inertia load or a load that requires a very high starting torque across the full speed range. By correctly selecting the resistors used in the secondary resistance or slip ring starter, the motor is able to produce maximum torque at a relatively low current from zero speed to full speed. A secondary use of the slip ring motor is to provide a means of speed control.

Because the torque curve of the motor is effectively modified by the resistance connected to the rotor circuit, the speed of the motor can be altered. Increasing the value of resistance on the rotor circuit will move the speed of maximum torque down.

If the resistance connected to the rotor is increased beyond the point where the maximum torque occurs at zero speed, the torque will be further reduced. When used with a load that has a torque curve that increases with speed, the motor will operate at the speed where the torque developed by the motor is equal to the load torque.

Reducing the load will cause the motor to speed up, and increasing the load will cause the motor to slow down until the load and motor torque are equal. Operated in this manner, the slip losses are dissipated in the secondary resistors and can be very significant. The speed regulation is also very poor.

### **Stepper Motors**

Closely related in design to three-phase AC synchronous motors are stepper motors, where an internal rotor containing permanent magnets or a large iron core with salient poles is controlled by a set of external magnets that are switched electronically.

A stepper motor may also be thought of as a cross between a DC electric motor and a solenoid. As each coil is energized in turn, the rotor aligns itself with the magnetic field produced by the energized field winding.

Unlike a synchronous motor, in its application, the motor may not rotate continuously; instead, it "steps" from one position to the next as field windings are energized and de-energized in sequence. Depending on the sequence, the rotor may turn forwards or backwards.

Simple stepper motor drivers entirely energize or entirely de-energize the field windings, leading the rotor to "cog" to a limited number of positions; more sophisticated drivers can proportionally control the power to the field windings, allowing the rotors to position between the cog points and thereby rotate extremely smoothly.

Computer controlled stepper motors are one of the most versatile forms of positioning systems, particularly when part of a digital servo-controlled system.

Stepper motors can be rotated to a specific angle with ease, and hence stepper motors are used in pre-gigabyte era computer disk drives, where the precision they offered was adequate for the correct positioning of the read/write head of a hard disk drive. As drive density increased, the precision limitations of stepper motors made them obsolete for hard drives, thus newer hard disk drives use read/write head control systems based on voice coils. Stepper motors were upscaled to be used in electric vehicles under the term SRM (switched reluctance machine).

# Motor Review

## Reviewing D-C Motors

DC motors have been available for nearly 100 years. In fact, the first electric motors were designed and built for operation from direct current power. AC motors are the basic prime movers for the fixed speed requirements of industry. Their basic simplicity, dependability and ruggedness make AC motors the natural choice for the vast majority of industrial drive applications.

An electric motor can be configured as a solenoid, a stepper motor or a rotational machine. This article covers the DC rotational machine. In all DC rotational machines, there are six components that comprise the electric motor: axle, rotor or armature, stator, commutator, field magnets and brushes.

In order to understand how a direct current (DC) electric motor operates, a few basic principles must be understood. Just as in Faraday's experiment, the DC motor works with magnetic fields and electrical current. Centuries ago it was discovered that a stone found in Asia, referred to as a lodestone, and had an unusual property that would transfer an invisible force to an iron object when the stone was rubbed against it. These lodestones were found to align with the earth's north-south axis when freely hanging on a string or floated on water, and this property aided early explorers in navigating around the earth.

It was understood later that this stone was a permanent magnet with a field that had two poles of opposite effect, referred to as north and south. The magnetic fields, just like electric charges, have forces that are opposite in their effects.

Electric charges are either positive or negative, whereas magnetic fields have a north-south orientation. When magnetic fields are aligned at opposite or dissimilar poles, they'll exert considerable forces of attraction with one another, and when aligned at like or similar poles, they'll strongly repel one another.

The magnetic field will pull or put a force upon a ferrous (magnetic) material. If iron particles are sprinkled on a paper sheet over a permanent magnet, the alignment of the iron particles maps the magnetic field, which shows that this field leaves one pole and enters the other pole with the force field being unbroken. As with any kind of field (electric, magnetic or gravitational), the total quantity, or effect, of the field is referred to as the flux, while the push causing the flux to form in space is called a force. This magnetic force field is comprised of many lines of flux, all starting at one pole and returning to the other pole.

## Modern Theory of Magnetism

The modern theory of magnetism states that a magnetic field is produced by an electric charge in motion. When an electric charge is in motion, the electrons orbiting the atom are forced to align and uniformly spin in the same direction. The more atoms uniformly spinning in the same direction, the stronger the force of the magnetic field. When billions of atoms have orbits spinning in the same direction and the material is capable of holding the atoms' orbits, a permanent magnet is created.

When two powerful permanent magnets are moved in close proximity to one another, it's evident that a very real force is exerted that can provide the potential for work to be done. For work to be accomplished, the relationship between the magnetic fields must be controlled properly.

The trick here is to control the magnetic fields by a means other than just using the permanent magnet. This can be accomplished by producing a magnetic field with an electrical conductor that has current flowing through it.

Nearly all electric motors exploit the use of a current-carrying conductor to create mechanical work. When current is flowing through a conductor and the electric charge is in motion, the electrons orbiting the atoms are forced to align and uniformly spin in the same direction. This creates a magnetic field that forms around the conductor. The larger the current flowing through the conductor, the more atoms are forced to align and rotate in a uniform direction.

This rotational alignment of the atoms increases the strength of the magnetic field. However, if one were to place a conductor with current flowing through it near a permanent magnet, he would be disappointed by how feeble this force is. What's needed is a way to amplify the magnetic force field. This is accomplished by taking the conductor wire and making many turns or wraps to produce a winding. Converting the conductor from a single, isolated straight wire to one that contains many turns forming a winding amplifies the magnetic force many times. The amount of magnetic field amplification is based on the number of turns in the winding and the amount of current flowing through the conductor.

In this configuration, the magnetic flux is moving through air, which is a poor conductor of magnetic energy, thus allowing the magnetic flux to spread out over a very wide area. Therefore, the reluctance from the magnetic field when moving through air is quite high. Reluctance is a measure of how difficult it is for the magnetic flux to complete its circuit—that is, to leave one pole and enter the opposite pole. If the magnetic flux is kept close to the magnet, it has less resistance or opposition to flow.

### **Magnetic Principles and Motor Theory**

All machine designs involving rotating equipment ultimately rely on theory to guide the engineer's application choices. Hence, a very brief review of magnetic principles and motor theory is always a convenient starting point for any discussion of DC motor applications. The laws of physics have blessed the world of machine design with the existence of magnetism, which is the foundation of motor theory. In essence, magnets, permanent or electromagnetic, produce fields of magnetic flux. These magnetic fields can produce an induced EMF through a coil of wire when relative movement between the field and a current carrying conductor occurs; and if this movement is reversed, so is the direction of the magnetic field, according to Faraday's Law. Thus, in theory, motor action or torque is produced when electrical energy is applied to conductor in a changing magnetic field, causing current flow in the conductor, generating both an induced EMF and a CEMF (Lenz's Law) resulting in rotational or mechanical energy.

### **DC Motors: Physical and Functional Descriptions**

DC motors are commonly used in industrial machinery because of their inherent advantages—good speed control, high starting torque, reliable control methodology—which generally outweigh the increased maintenance costs associated with them.

### **Construction**

The generic DC motor is constructed with armature and field windings, interpoles, a frame or stator, a segmented commutator, a brush assembly and end bells. The rotating armature winding is wound on a laminated core, mounted on a steel shaft, supported by shaft bearings, and is

connected to the segmented commutator that receives external DC power through the brush assembly.

Brushes conduct the current from external DC power circuit to the commutator and finally to the armature windings. The frame or stator supports the field windings and interpoles. The end bells encase all the parts of the motor into one unit.

### **Operation**

DC motors produce torque and mechanical motion due to the interaction of the magnetic fields of the rotating armature coil and the stationary field coil mounted on the frame. The changing magnetic field of the armature is possible through the use of electrically conductive carbon brushes, which ride on the segmented, commutator ring; external DC power is applied to the brushes through the commutator to the armature windings. As current flows through the armature coil, a magnetic field results. The field windings mounted on the frame, also set up a magnetic field. After the rotating armature passes through half of a complete rotation, the commutator switches the direction of the current flow, thereby changing the direction of the magnetic field in the armature winding. This change produces opposing magnetic fields and sustains torque and rotation through the next half cycle of rotation until the commutator changes the direction of current flow and the magnetic field again.

### **Types**

The field and armature windings of DC motors can be connected in series, shunt (parallel) or series-shunt to achieve different kinds of speed-torque characteristics. Hence, the three general categories of wound field DC motors are shunt-wound, series-wound and compound-wound. In series-wound motors, the armature is connected in series with the field to provide high starting torque; however, they do not operate at no-load: when speed decreases, torque increases, which can create a possibly unsafe runaway condition. In shunt wound motors, the armature and field are connected in parallel. This wiring arrangement produces an inverse speed-torque relationship: as speed increases, torque decreases. The compound-wound is a combination of a series- and shunt-wound motor by placing the field winding in series with the armature in addition to a shunt field. This type offers a combination of good starting torque and speed control.

Brushless motors are a hybrid type of DC motor that does not use a commutator. Rather, it is constructed with a permanent magnet rotor, optical shaft encoder that gives positional feedback information, a DC controller that excites the phase of stator windings required to develop torque based upon the encoder's feedback. Brushless motors characteristically have high maximum operating speeds, high torque to weight ratios and are compact in design (fractional horsepower). They are typically used in robotic arm applications.

### **Associated Solid State Controls**

In order to supply the answer, it is necessary to examine some of the basic characteristics obtainable from DC motors and their associated solid state controls.

1. Wide speed range.
2. Good speed regulation.
3. Compact size and light weight (relative to mechanical variable speed).
4. Ease of control.
5. Low maintenance.
6. Low cost.

In order to realize how a DC drive has the capability to provide the above characteristics, the DC drive has to be analyzed as two elements that make up the package. These two elements are of course the motor and the control. (The "control" is more accurately called the "regulator").

Basic DC motors as used on nearly all packaged drives have a very simple performance characteristic the shaft turns at a speed almost directly proportional to the voltage applied to the armature.

### **External Adjustment**

In addition to the normal external adjustment such as the speed potentiometer, there are a number of common internal adjustments that are used on simple small analog type SCR Drives (Silicon Controlled Rectifier Drive). Some of these adjustments are as follows:

- ✓ Minimum Speed
- ✓ Maximum Speed
- ✓ Current Limit (Torque Limit) . IR Compensation
- ✓ Acceleration Time . Deceleration Time

The following is a description of the function that these individual adjustments serve and their typical use.

### **Minimum Speed**

In most cases when the control is initially installed the speed potentiometer can be turned down to its lowest point and the output voltage from the control will go to zero causing the motor to stop. There are many situations where this is not desirable. For example, there are some machines that want to be kept running at a minimum speed and accelerated up to operating speed as necessary. There is also a possibility that an operator may use the speed potentiometer to stop the motor to work on the machine. This can be a dangerous situation since the motor has only been brought to a stop by zeroing the input signal voltage. A more desirable situation is when the motor is stopped by opening the circuit to the motor or power to the control using the on/off switch. By adjusting the minimum speed up to some point where the motor continues to run even with the speed potentiometer set to its lowest point, the operator must shut the control off to stop the motor. This adds a little safety into the system. The typical minimum speed adjustment is from 0 to 30% of motor base speed.

### **Maximum Speed**

The maximum speed adjustment sets the maximum speed attainable either by raising the input signal to its maximum point or turning the potentiometer to the maximum point. For example, on a typical DC motor the rated speed of the motor might 1750 RPM but the control might be capable of running it up to 1850 or 1900 RPM. In some cases, it's desirable to limit the motor (and machine speed) to something less than would be available at this maximum setting. The maximum adjustment allows this to be done. By turning the internal potentiometer to a lower point the maximum output voltage from the control is limited. This limits the maximum speed available from the motor. In typical controls such as our BC140 the range of adjustment on the maximum speed is from 50 to 110% of motor base speed.



### **Current Limit**

One very nice feature of electronic speed controls is that the current going to the motor is constantly monitored by the control. As mentioned previously, the current drawn by the armature of the DC motor is related to the torque that is required by the load.

Since this monitoring and control is available an adjustment is provided in the control that limits the output current to a maximum value.

This function can be used to set a threshold point that will cause the motor to stall rather than putting out an excessive amount of torque. This capability gives the motor/control combination the ability to prevent damage that might otherwise occur if higher values of torque were available. This is handy on machines that might become jammed or otherwise stalled. It can also be used where the control is operating a device such as the center winder where the important thing becomes torque rather than the speed. In this case the current limit is set and the speed goes up or down to hold the tension of the material being wound. The current limit is normally factory set at 150% of the motor's rated current. This allows the motor to produce enough torque to start and accelerate the load and yet will not let the current (and torque) exceed 150% of its rated value when running. The range of adjustment is typically from 0 to 200% of the motor rated current.

### **IR Compensation**

IR compensation is a method used to adjust for the droop in a motor's speed due to armature resistance. As mentioned previously, IR compensation is positive feedback that causes the control output voltage to rise slightly with increasing output current. This will help stabilize the motor's speed from a no load to full load condition. If the motor happens to be driving a load where the torque is constant or nearly so, then this adjustment is usually unnecessary. However, if the motor is driving a load with a widely fluctuating torque requirement, and speed regulation is critical, then IR compensation can be adjusted to stabilize the speed from the light load to full load condition. One caution is that when IR compensation is adjusted too high it results in an increasing speed characteristic. This means that as the load is applied the motor is actually going to be forced to run faster. When this happens it increases the voltage and current to the motor which in turn increases the motor speed further. If this adjustment is set too high an unstable "hunting" or oscillating condition occurs that is undesirable.

### **Acceleration Time Adjustment**

The Acceleration Time adjustment performs the function that is indicated by its name. It will extend or shorten the amount of time for the motor to go from zero speed up to the set speed. It also regulates the time it takes to change speeds from one setting (say 50%) to another setting (perhaps 100%). So this setting has the ability to moderate the acceleration rate on the drive.

A couple notes are important: if an acceleration time that is too rapid is called for "acceleration time" will be overridden by the current limit. Acceleration will only occur at a rate that is allowed by the amount of current the control passes through to the motor. Also important to note is that on most small controls the acceleration time is not linear. What this means is that a change of 50 RPM may occur more rapidly when the motor is at low speed than it does when the motor is approaching the set point speed. This is important to know but usually not critical on simple applications where these drives are used.

### Deceleration Time

This is an adjustment that allows loads to be slowed over an extended period of time. For example, if power is removed from the motor and the load stops in 3 seconds, then the decel time adjustment would allow you "to increase that time and "power down" the load over a period of 4, 5, 6 or more seconds. Note: On a conventional simple DC drive it will not allow for the shortening of the time below the "coast to rest" time.

### Adjustment Summary

The ability to adjust these six adjustments gives great flexibility to the typical inexpensive DC drive. In most cases the factory preset settings are adequate and need not be changed, but on other applications it may be desirable to tailor the characteristics of the control to the specific application. Many of these adjustments are available in other types of controls, such as variable frequency drives.

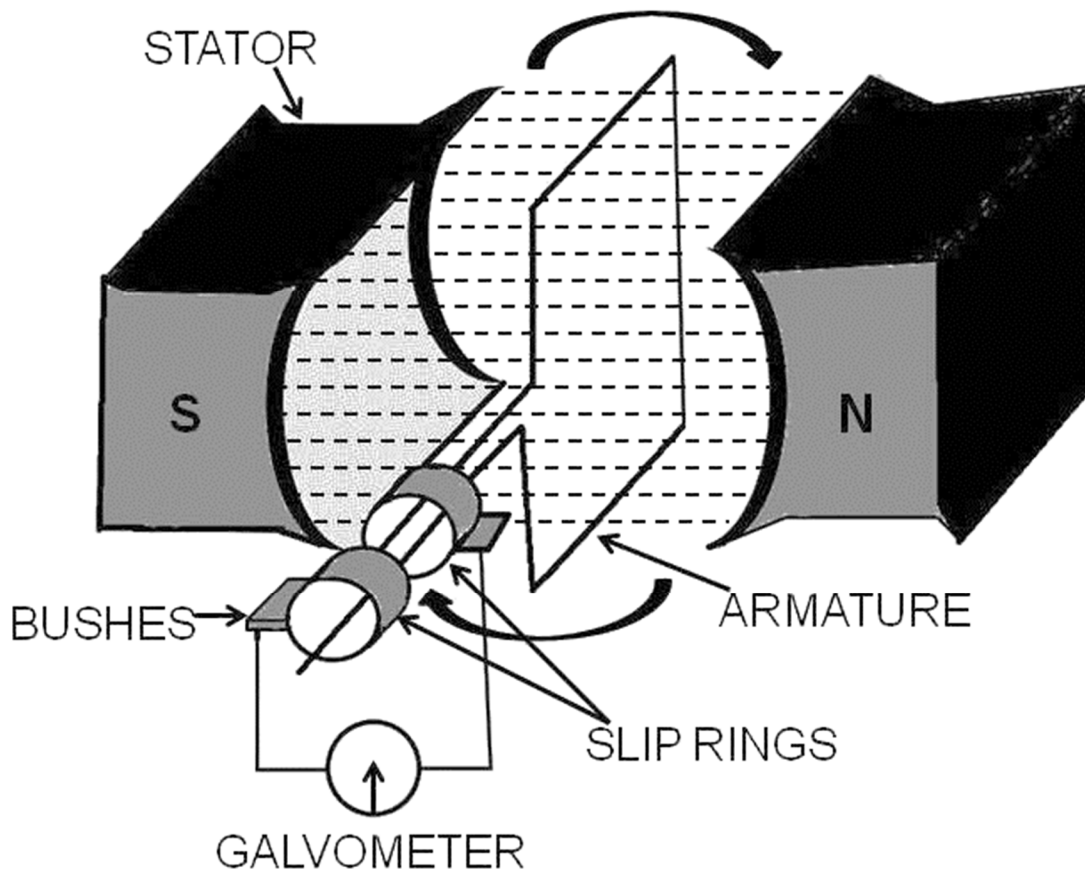

**PRODUCTION OF AC CURRENT DIAGRAM**

## Reviewing A-C Motors

### AC Motor History

In 1882, Nikola Tesla discovered the rotating magnetic field, and pioneered the use of a rotary field of force to operate machines. He exploited the principle to design a unique two-phase induction motor in 1883. In 1885, Galileo Ferraris independently researched the concept. In 1888, Ferraris published his research in a paper to the Royal Academy of Sciences in Turin. Tesla had suggested that the commutators from a machine could be removed and the device could operate on a rotary field of force. Professor Poeschel, his teacher, stated that would be akin to building a perpetual motion machine.

Michail Osipovich Dolivo-Dobrovolsky later developed a three-phase "cage-rotor" in 1890. This type of motor is now used for the vast majority of commercial applications.

An AC motor has two parts: a stationary stator having coils supplied with alternating current to produce a rotating magnetic field, and a rotor attached to the output shaft that is given a torque by the rotating field.

### AC Motor with Sliding Rotor

A conical-rotor brake motor incorporates the brake as an integral part of the conical sliding rotor. When the motor is at rest, a spring acts on the sliding rotor and forces the brake ring against the brake cap in the motor, holding the rotor stationary. When the motor is energized, its magnetic field generates both an axial and a radial component. The axial component overcomes the spring force, releasing the brake; while the radial component causes the rotor to turn. There is no additional brake control required.

### Synchronous Electric Motor

A synchronous electric motor is an AC motor distinguished by a rotor spinning with coils passing magnets at the same rate as the alternating current and resulting magnetic field which drives it. Another way of saying this is that it has zero slip under usual operating conditions. Contrast this with an induction motor, which must slip to produce torque. One type of synchronous motor is like an induction motor except the rotor is excited by a DC field. Slip rings and brushes are used to conduct current to the rotor. The rotor poles connect to each other and move at the same speed hence the name synchronous motor.

Another type, for low load torque, has flats ground onto a conventional squirrel-cage rotor to create discrete poles. Yet another, such as made by Hammond for its pre-World War II clocks, and in the older Hammond organs, has no rotor windings and discrete poles. It is not self-starting. The clock requires manual starting by a small knob on the back, while the older Hammond organs had an auxiliary starting motor connected by a spring-loaded manually operated switch.

Finally, hysteresis synchronous motors typically are (essentially) two-phase motors with a phase-shifting capacitor for one phase. They start like induction motors, but when slip rate decreases sufficiently, the rotor (a smooth cylinder) becomes temporarily magnetized.

Its distributed poles make it act like a permanent-magnet-rotor synchronous motor. The rotor material, like that of a common nail, will stay magnetized, but can also be demagnetized with little difficulty. Once running, the rotor poles stay in place; they do not drift.

Low-power synchronous timing motors (such as those for traditional electric clocks) may have multi-pole permanent-magnet external cup rotors, and use shading coils to provide starting torque. Telechron clock motors have shaded poles for starting torque, and a two-spoke ring rotor that performs like a discrete two-pole rotor.

### **Induction Motor**

An induction motor is an asynchronous AC motor where power is transferred to the rotor by electromagnetic induction, much like transformer action. An induction motor resembles a rotating transformer, because the stator (stationary part) is essentially the primary side of the transformer and the rotor (rotating part) is the secondary side. Polyphase induction motors are widely used in industry.

Induction motors may be further divided into squirrel-cage motors and wound-rotor motors. Squirrel-cage motors have a heavy winding made up of solid bars, usually aluminum or copper, joined by rings at the ends of the rotor. When one considers only the bars and rings as a whole, they are much like an animal's rotating exercise cage, hence the name.

Currents induced into this winding provide the rotor magnetic field. The shape of the rotor bars determines the speed-torque characteristics. At low speeds, the current induced in the squirrel cage is nearly at line frequency and tends to be in the outer parts of the rotor cage. As the motor accelerates, the slip frequency becomes lower, and more current is in the interior of the winding. By shaping the bars to change the resistance of the winding portions in the interior and outer parts of the cage, effectively a variable resistance is inserted in the rotor circuit. However, the majority of such motors have uniform bars.

In a wound-rotor motor, the rotor winding is made of many turns of insulated wire and is connected to slip rings on the motor shaft. An external resistor or other control devices can be connected in the rotor circuit. Resistors allow control of the motor speed, although significant power is dissipated in the external resistance. A converter can be fed from the rotor circuit and return the slip-frequency power that would otherwise be wasted back into the power system through an inverter or separate motor-generator.

The wound-rotor induction motor is used primarily to start a high inertia load or a load that requires a very high starting torque across the full speed range. By correctly selecting the resistors used in the secondary resistance or slip ring starter, the motor is able to produce maximum torque at a relatively low supply current from zero speed to full speed. This type of motor also offers controllable speed.

Motor speed can be changed because the torque curve of the motor is effectively modified by the amount of resistance connected to the rotor circuit. Increasing the value of resistance will move the speed of maximum torque down. If the resistance connected to the rotor is increased beyond the point where the maximum torque occurs at zero speed, the torque will be further reduced.

When used with a load that has a torque curve that increases with speed, the motor will operate at the speed where the torque developed by the motor is equal to the load torque. Reducing the load will cause the motor to speed up, and increasing the load will cause the motor to slow down until the load and motor torque are equal. Operated in this manner, the slip losses are dissipated in the secondary resistors and can be very significant.

The speed regulation and net efficiency is also very poor. Various regulatory authorities in many countries have introduced and implemented legislation to encourage the manufacture and use of higher efficiency electric motors.

### **Doubly Fed Electric Motor**

Doubly fed electric motors have two independent multiphase winding sets, which contribute active (i.e., working) power to the energy conversion process, with at least one of the winding sets electronically controlled for variable speed operation. Two independent multiphase winding sets (i.e., dual armature) are the maximum provided in a single package without topology duplication. Doubly fed electric motors are machines with an effective constant torque speed range that is twice synchronous speed for a given frequency of excitation. This is twice the constant torque speed range as singly fed electric machines, which have only one active winding set.

A doubly fed motor allows for a smaller electronic converter but the cost of the rotor winding and slip rings may offset the saving in the power electronics components. Difficulties with controlling speed near synchronous speed limit applications.

### **Singly Fed Electric Motor**

Most AC motors are singly fed. Singly fed electric motors have a single multiphase winding set that is connected to a power supply. Singly fed electric machines may be either induction or synchronous. The active winding set can be electronically controlled. Singly fed electric machines have an effective constant torque speed range up to synchronous speed for a given excitation frequency.

### **Torque Motors**

A torque motor (also known as a limited torque motor) is a specialized form of induction motor which is capable of operating indefinitely while stalled, that is, with the rotor blocked from turning, without incurring damage. In this mode of operation, the motor will apply a steady torque to the load (hence the name).

A common application of a torque motor would be the supply- and take-up reel motors in a tape drive. In this application, driven from a low voltage, the characteristics of these motors allow a relatively constant light tension to be applied to the tape whether or not the capstan is feeding tape past the tape heads. Driven from a higher voltage, (and so delivering a higher torque), the torque motors can also achieve fast-forward and rewind operation without requiring any additional mechanics such as gears or clutches. In the computer gaming world, torque motors are used in force feedback steering wheels.

Another common application is the control of the throttle of an internal combustion engine in conjunction with an electronic governor. In this usage, the motor works against a return spring to move the throttle in accordance with the output of the governor. The latter monitors engine speed by counting electrical pulses from the ignition system or from a magnetic pickup and, depending on the speed, makes small adjustments to the amount of current applied to the motor.

If the engine starts to slow down relative to the desired speed, the current will be increased, the motor will develop more torque, pulling against the return spring and opening the throttle. Should the engine run too fast, the governor will reduce the current being applied to the motor, causing the return spring to pull back and close the throttle.

## Stepper Motors

Closely related in design to three-phase AC synchronous motors are stepper motors, where an internal rotor containing permanent magnets or a magnetically soft rotor with salient poles is controlled by a set of external magnets that are switched electronically. A stepper motor may also be thought of as a cross between a DC electric motor and a rotary solenoid. As each coil is energized in turn, the rotor aligns itself with the magnetic field produced by the energized field winding. Unlike a synchronous motor, in its application, the stepper motor may not rotate continuously; instead, it "steps"—starts and then quickly stops again—from one position to the next as field windings are energized and de-energized in sequence. Depending on the sequence, the rotor may turn forwards or backwards, and it may change direction, stop, speed up or slow down arbitrarily at any time.

Simple stepper motor drivers entirely energize or entirely de-energize the field windings, leading the rotor to "cog" to a limited number of positions; more sophisticated drivers can proportionally control the power to the field windings, allowing the rotors to position between the cog points and thereby rotate extremely smoothly. This mode of operation is often called microstepping. Computer controlled stepper motors are one of the most versatile forms of positioning systems, particularly when part of a digital servo-controlled system.

Stepper motors can be rotated to a specific angle in discrete steps with ease, and hence stepper motors are used for read/write head positioning in computer floppy diskette drives. They were used for the same purpose in pre-gigabyte era computer disk drives, where the precision and speed they offered was adequate for the correct positioning of the read/write head of a hard disk drive.

As drive density increased, the precision and speed limitations of stepper motors made them obsolete for hard drives—the precision limitation made them unusable, and the speed limitation made them uncompetitive—thus newer hard disk drives use voice coil-based head actuator systems. (The term "voice coil" in this connection is historic; it refers to the structure in a typical (cone type) loudspeaker. This structure was used for a while to position the heads. Modern drives have a pivoted coil mount; the coil swings back and forth, something like a blade of a rotating fan. Nevertheless, like a voice coil, modern actuator coil conductors (the magnet wire) move perpendicular to the magnetic lines of force.)

Stepper motors were and still are often used in computer printers, optical scanners, and digital photocopiers to move the optical scanning element, the print head carriage (of dot matrix and inkjet printers), and the platen or feed rollers. Likewise, many computer plotters (which since the early 1990s have been replaced with large-format inkjet and laser printers) used rotary stepper motors for pen and platen movement; the typical alternatives here were either linear stepper motors or servomotors with closed-loop analog control systems.

So-called quartz analog wristwatches contain the smallest commonplace stepping motors; they have one coil, draw very little power, and have a permanent-magnet rotor. The same kind of motor drives battery-powered quartz clocks. Some of these watches, such as chronographs, contain more than one stepping motor.

## Rotary Motor

Uses include rotating machines such as fans, turbines, drills, the wheels on electric cars, locomotives and conveyor belts. Also, in many vibrating or oscillating machines, an electric motor spins an unbalanced mass, causing the motor (and its mounting structure) to vibrate. A familiar application is cell phone vibrating alerts used when the acoustic "ringer" is disabled by the user.

Electric motors are also popular in robotics. They turn the wheels of vehicular robots, and servo motors operate arms in industrial robots; they also move arms and legs in humanoid robots. In flying robots, along with helicopters, a motor rotates a propeller, or aerodynamic rotor blades to create controllable amounts of lift. Electric motors are replacing hydraulic cylinders in airplanes and military equipment.

In industrial and manufacturing businesses, electric motors rotate saws and blades in cutting and slicing processes; they rotate parts being turned in lathes and other machine tools, and spin grinding wheels. Fast, precise servo motors position tools and work in modern CNC machine tools. Motor-driven mixers are very common in food manufacturing. Linear motors are often used to push products into containers horizontally.

Many kitchen appliances also use electric motors. Food processors and grinders spin blades to chop and break up foods. Blenders use electric motors to mix liquids, and microwave ovens use motors to turn the tray that food sits on. Toaster ovens also use electric motors to turn a conveyor to move food over heating elements.

### Servo Motor

A servomotor is a motor, very often sold as a complete module, which is used within a position-control or speed-control feedback control system mainly control valves, such as motor operated control valves. Servomotors are used in applications such as machine tools, pen plotters, and other process systems. Motors intended for use in a servomechanism must have well-documented characteristics for speed, torque, and power. The speed vs. torque curve is quite important and is high ratio for a servo motor.

Dynamic response characteristics such as winding inductance and rotor inertia are also important; these factors limit the overall performance of the servomechanism loop. Large, powerful, but slow-responding servo loops may use conventional AC or DC motors and drive systems with position or speed feedback on the motor. As dynamic response requirements increase, more specialized motor designs such as coreless motors are used.

A servo system differs from some stepper motor applications in that the position feedback is continuous while the motor is running; a stepper system relies on the motor not to "miss steps" for short term accuracy, although a stepper system may include a "home" switch or other element to provide long-term stability of control. For instance, when a typical dot matrix computer printer starts up, its controller makes the print head stepper motor drive to its left-hand limit, where a position sensor defines home position and stops stepping. As long as power is on, a bidirectional counter in the printer's microprocessor keeps track of print-head position.

## Linear Motor

A linear motor is essentially any electric motor that has been "unrolled" so that, instead of producing a torque (rotation), it produces a straight-line force along its length. Linear motors are most commonly induction motors or stepper motors. Linear motors are commonly found in many roller-coasters where the rapid motion of the motorless railcar is controlled by the rail. They are also used in maglev trains, where the train "flies" over the ground. On a smaller scale, the HP 7225A pen plotter, released in 1978, used two linear stepper motors to move the pen along the X and Y axes.

### Torque Capability of Motor Types

When optimally designed within a given core saturation constraint and for a given active current (i.e., torque current), voltage, pole-pair number, excitation frequency (i.e., synchronous speed), and air-gap flux density, all categories of electric motors or generators will exhibit virtually the same maximum continuous shaft torque (i.e., operating torque) within a given air-gap area with winding slots and back-iron depth, which determines the physical size of electromagnetic core. Some applications require bursts of torque beyond the maximum operating torque, such as short bursts of torque to accelerate an electric vehicle from standstill. Always limited by magnetic core saturation or safe operating temperature rise and voltage, the capacity for torque bursts beyond the maximum operating torque differs significantly between categories of electric motors or generators.

Capacity for bursts of torque should not be confused with field weakening capability inherent in fully electromagnetic electric machines (Permanent Magnet (PM) electric machine are excluded). Field weakening, which is not available with PM electric machines, allows an electric machine to operate beyond the designed frequency of excitation.

Electric machines without a transformer circuit topology, such as Field-Wound (i.e., electromagnet) or Permanent Magnet (PM) Synchronous electric machines cannot realize bursts of torque higher than the maximum designed torque without saturating the magnetic core and rendering any increase in current as useless. Furthermore, the permanent magnet assembly of PM synchronous electric machines can be irreparably damaged, if bursts of torque exceeding the maximum operating torque rating are attempted.

Electric machines with a transformer circuit topology, such as Induction (i.e., asynchronous) electric machines, Induction Doubly Fed electric machines, and Induction or Synchronous Wound-Rotor Doubly Fed (WRDF) electric machines, exhibit very high bursts of torque because the active current (i.e., Magneto-Motive-Force or the product of current and winding-turns) induced on either side of the transformer oppose each other and as a result, the active current contributes nothing to the transformer coupled magnetic core flux density, which would otherwise lead to core saturation.

Electric machines that rely on Induction or Asynchronous principles short-circuit one port of the transformer circuit and as a result, the reactive impedance of the transformer circuit becomes dominant as slip increases, which limits the magnitude of active (i.e., real) current. Still, bursts of torque that are two to three times higher than the maximum design torque are realizable.



The Synchronous WRDF electric machine is the only electric machine with a truly dual ported transformer circuit topology (i.e., both ports independently excited with no short-circuited port). The dual ported transformer circuit topology is known to be unstable and requires a multiphase slip-ring-brush assembly to propagate limited power to the rotor winding set. If a precision means were available to instantaneously control torque angle and slip for synchronous operation during motoring or generating while simultaneously providing brushless power to the rotor winding set (see Brushless wound-rotor doubly fed electric machine), the active current of the Synchronous WRDF electric machine would be independent of the reactive impedance of the transformer circuit and bursts of torque significantly higher than the maximum operating torque and far beyond the practical capability of any other type of electric machine would be realizable. Torque bursts greater than eight times operating torque have been calculated.

### Continuous Torque Density

The continuous torque density of conventional electric machines is determined by the size of the air-gap area and the back-iron depth, which are determined by the power rating of the armature winding set, the speed of the machine, and the achievable air-gap flux density before core saturation. Despite the high coercivity of neodymium or samarium-cobalt permanent magnets, continuous torque density is virtually the same amongst electric machines with optimally designed armature winding sets.

Continuous torque density should never be confused with peak torque density, which comes with the manufacturer's chosen method of cooling, which is available to all, or period of operation before destruction by overheating of windings or even permanent magnet damage.

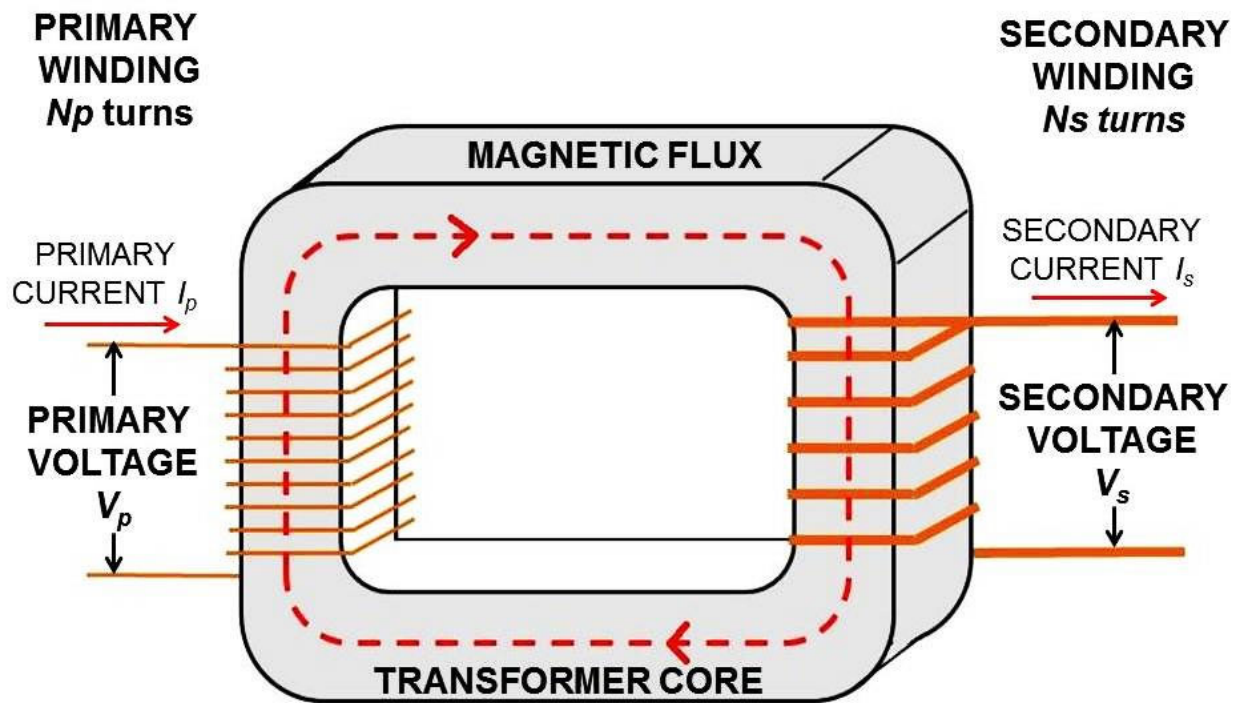

**TRANSFORMER DIAGRAM**

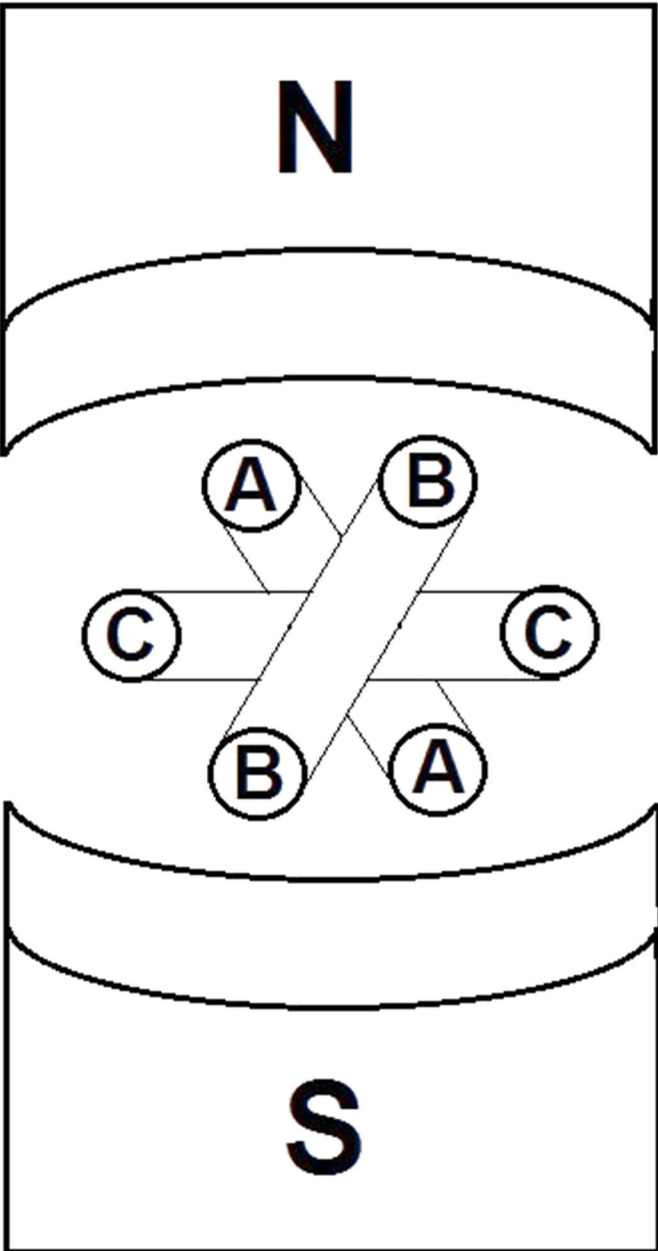

**THREE PHASE WIRING DIAGRAM**

## Electric Motor Maintenance Sub-Section

### General

Make a habit of checking that the motor is securely bolted to its platform. Mounting bolts can vibrate loose. Check to see that rotating parts aren't rubbing on stationary parts of the motor, causing damage to the motor.

Remember that an electric motor is an air-cooled piece of equipment and needs all the ventilation it can get. Excessive heat is a main cause of reduced motor life.

Motors also like to be dry. Keep motor windings dry by keeping pump packing in good condition. Even if windings are protected from moisture, minerals in the pumped water can attach to the windings and cause early failure. Motors that operate at 3600 rpm experience twice as much wear as motors operating at 1800 rpm. Regular maintenance is especially critical for 3600 rpm motors and pumps.

### Maintenance Tasks

#### At season startup:

- Remove tape on all openings and clean out rodents, insects, or debris.
- Locate the motor drain hole on the base or support for the base, and clean it out so water won't be trapped and held directly under the air intake.
- Change oil in reduced voltage starters, using an oil recommended by the manufacturer. Be sure to clean the oil pan before refilling.
- Use vacuum suction or air pressure to remove dust and debris from moving parts of the motor. (Don't exceed 50 psi of air pressure.)

#### Periodically:

- Clean grass or debris from air ventilation openings on the motor and from around the motor to allow a full flow of cooling air.
- Check screens on motor ventilation openings. Replace with machine cloth (¼-inch mesh) as necessary.

#### At end of season shutdown:

- Cover the motor with a breathable water-resistant tarp.

### Motor Electrical System

Wide temperature fluctuations during the year can cause electrical connections (especially in aluminum wire) to expand and contract, loosening connectors. Loose electrical connections cause heat buildup and arcing at electrical terminals. The voltage drop across loose connections will cause the motor to operate at less than its rated voltage, increasing internal motor temperature. Increased heat will break down motor winding insulation, resulting in electrical shorts and motor failures. A loose or broken connection can also unbalance the phases of three-phase power and damage the motor windings.

**Caution:** Before conducting these tasks, be sure power is off at the utility disconnect switch. It may be necessary to have the utility company shut the power off.

### Maintenance Tasks

#### At season startup:

- Inspect insulation of motor windings. If the windings are excessively grease-covered, consult your motor repair shop for direction.

- Check all safety switches according to the manufacturer's directions.

**Twice a year:**

- Check electrical connections from meter loop to motor for corrosion and clean if necessary.
- Coat the wiring (especially aluminum) and connectors with an antioxidant that meets electrical code requirements.
- Check electrical connections from the meter loop to the motor for tightness.
- Tighten and re-tape if necessary.
- Replace overheated connections or wires with new material. Overheated connections will show heat damage such as burnt insulation on wires.

**Motor Bearings**

Lubricate the motor according to the manufacturer's instructions. Intervals between lubrication will vary with motor speed, power draw, load, ambient temperatures, exposure to moisture, and seasonal or continuous operation. Electric motors should not be greased daily. Bearings can be ruined by either over- or under-greasing.

Fill a grease gun with electric motor bearing grease and label it so it won't be confused with other types of lubricating grease.

**Maintenance Tasks**

Change the grease at recommended intervals to remove any accumulated moisture:

- Remove the bottom relief plug and clean hardened grease out of passageway.
- Using a grease gun, fill the housing with approved high temperature electric motor bearing grease (refer to the manufacturer's manual for API number of grease) until old grease is expelled.

**Caution:** If old grease is not expelled as the new grease is pumped in, stop adding grease and have your motor checked by a qualified repair person. Adding new grease without old grease being removed could blow the seals and push grease into the motor windings, causing the motor to overheat and reducing its service life. Do not over-grease your motor.

- Run motor until all surplus grease is thrown out through the bottom grease port (may require 5 to 10 minutes).
- Shut off the motor and use a screwdriver or similar device to remove a small amount of grease from the grease port to allow for grease expansion during full load operation.
- Replace grease plug.

**Control Panel Maintenance****Control Panel Safety Precautions**

Never use the main disconnect to start or stop your motor. It is not intended for this purpose. Using the main disconnect to start and stop the motor will cause excessive wear of the contacts and arcing can occur. Use the start and stop button.

If the overhead lines to your control panel's service are obstructed by tree branches or other items, have the utility company clear the lines.

**Have an electrician inspect your panel to ensure that:**

- Control circuits are protected with the correct size and type of fuse.
- Lightning arresters are properly installed on the meter and motor side of the buss and breaker. They should also be mounted in a secure box to protect you if they blow up.

- The service panel is properly grounded, independently of the pumping plant.
- Service head grommets are in place and in good condition.

### **General Maintenance**

Have your electrician or pump maintenance person do a Megger check on the control panel, motor, conduits, and other electrical connections. The Megger device applies a small amount of voltage to an electrical component and measures the electrical resistance. A Megger test can also detect potentially harmful moisture in windings.

Any time the main disconnect switch has been left open or off, operate it several times before leaving it closed or on. Copper oxide can form in a few hours and result in poor contact and overheating. Any type of corrosion can cause poor contact, poor grounding, and direct or high-resistance shorts.

**Caution:** After opening the control panel but before touching the controls inside, use a voltmeter to be sure that the incoming power is disconnected or turned off. If necessary, have your utility disconnect the power. If you have any doubts about the safety of your control panel, WALK AWAY AND CALL A QUALIFIED ELECTRICIAN.

Even a current of 15 milliamps (one milliamp is one one-thousandth of an amp) can cause serious injury or death. Always play it safe!



## Electrical Understanding Sub-Section

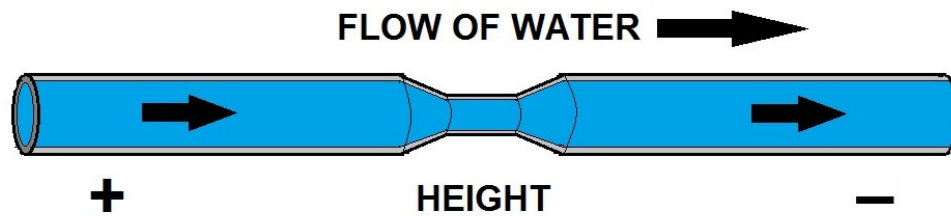

**Electricity flow can be compared to flow of water:**

- When pressure is applied at one end of a pipe (or wire) then, water (or electricity) will come out the other end.

**(Flow of electrons (electricity) along a wire)**

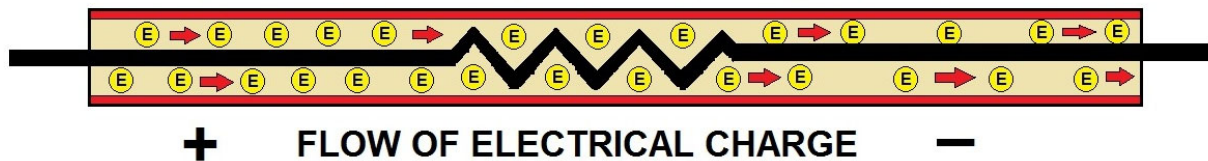

### BASIC ELECTRICITY FLOW CONCEPT

#### Understanding Voltage

**Voltage, electrical potential difference, electric tension or electric pressure** (denoted  $\Delta V$ ) and measured in units of electric potential: volts, or joules per coulomb is the electric potential difference between two points, or the difference in electric potential energy of a unit charge transported between two points.

Voltage is equal to the work done per unit charge against a static electric field to move the charge between two points. A voltage may represent either a source of energy (electromotive force), or lost, used, or stored energy (potential drop). A voltmeter can be used to measure the voltage (or potential difference) between two points in a system; usually a common reference potential such as the ground of the system is used as one of the points. Voltage can be caused by static electric fields, by electric current through a magnetic field, by time-varying magnetic fields, or some combination of these three.

Given two points in the space, called A and B, voltage is the difference of electric potentials between those two points. From the definition of electric potential, it follows that:

$$\begin{aligned}\Delta V_{BA} &= V_B - V_A = - \int_{r_0}^B \vec{E} \cdot d\vec{l} - \left( - \int_{r_0}^A \vec{E} \cdot d\vec{l} \right) \\ &= \int_B^{r_0} \vec{E} \cdot d\vec{l} + \int_{r_0}^A \vec{E} \cdot d\vec{l} = \int_B^A \vec{E} \cdot d\vec{l}\end{aligned}$$

Voltage is electric potential energy per unit charge, measured in joules per coulomb (= volts). It is often referred to as "electric potential", which then must be distinguished from electric potential energy by noting that the "potential" is a "per-unit-charge" quantity.

Like mechanical potential energy, the zero of potential can be chosen at any point, so the difference in voltage is the quantity which is physically meaningful. The difference in voltage measured when moving from point A to point B is equal to the work which would have to be done, per unit charge, against the electric field to move the charge from A to B. The voltage between the two ends of a path is the total energy required to move a small electric charge along that path, divided by the magnitude of the charge.

Mathematically this is expressed as the line integral of the electric field and the time rate of change of magnetic field along that path. In the general case, both a static (unchanging) electric field and a dynamic (time-varying) electromagnetic field must be included in determining the voltage between two points.

Historically this quantity has also been called "tension" and "pressure". Pressure is now obsolete but tension is still used, for example within the phrase "high tension" (HT) which is commonly used in thermionic valve (vacuum tube) based electronics.

Voltage is defined so that negatively charged objects are pulled towards higher voltages, while positively charged objects are pulled towards lower voltages. Therefore, the conventional current in a wire or resistor always flows from higher voltage to lower voltage.

Current can flow from lower voltage to higher voltage, but only when a source of energy is present to "push" it against the opposing electric field. For example, inside a battery, chemical reactions provide the energy needed for current to flow from the negative to the positive terminal.

Technically, in a material the electric field is not the only factor determining charge flow, and different materials naturally develop electric potential differences at equilibrium (Galvani potentials). The electric potential of a material is not even a well-defined quantity, since it varies on the subatomic scale.

A more convenient definition of 'voltage' can be found instead in the concept of Fermi level. In this case the voltage between two bodies is the thermodynamic work required to move a unit of charge between them. This definition is practical since a real voltmeter actually measures this work, not differences in electric potential.



## Understanding Three-Phase Power

Three-phase electric power is a common method of alternating-current electric power generation, transmission, and distribution. It is a type of polyphase system and is the most common method used by electrical grids worldwide to transfer power. It is also used to power large motors and other heavy loads. A three-phase system is generally more economical than others because it uses less conductor material to transmit electric power than equivalent single-phase or two-phase systems at the same voltage. The three-phase system was introduced and patented by Nikola Tesla in 1887 and 1888.

In a three-phase system, three circuit conductors carry three alternating currents (of the same frequency) which reach their instantaneous peak values at different times. Taking one conductor as the reference, the other two currents are delayed in time by one-third and two-thirds of one cycle of the electric current. This delay between phases has the effect of giving constant power transfer over each cycle of the current and also makes it possible to produce a rotating magnetic field in an electric motor.

Three-phase systems may have a neutral wire. A neutral wire allows the three-phase system to use a higher voltage while still supporting lower-voltage single-phase appliances. In high-voltage distribution situations, it is common not to have a neutral wire as the loads can simply be connected between phases (phase-phase connection).

### **Three-phase has properties that make it very desirable in electric power systems:**

- ✓ The phase currents tend to cancel out one another, summing to zero in the case of a linear balanced load. This makes it possible to eliminate or reduce the size of the neutral conductor; all the phase conductors carry the same current and so can be the same size, for a balanced load.
- ✓ Power transfer into a linear balanced load is constant, which helps to reduce generator and motor vibrations.
- ✓ Three-phase systems can produce a magnetic field that rotates in a specified direction, which simplifies the design of electric motors.
- ✓ Three is the lowest phase order to exhibit all of these properties.

Most household loads are single-phase. In North America and a few other places, three-phase power generally does not enter homes. Even in areas where it does, it is typically split out at the main distribution board and the individual loads are fed from a single phase. Sometimes it is used to power electric stoves and electric clothes dryers.

### **3 Or 4 Wire**

Three-phase circuits occur in two varieties: three-wire and four-wire. Both types have three energized ("hot" or "live") wires, but the 4-wire circuit also has neutral wire. The three-wire system is used when the loads on the 3 live wires will be balanced, for example in motors or heating elements with 3 identical coils.

The neutral wire is used when there is a chance that the loads are not balanced. A common example of this is local distribution in Europe, where each house will be connected to just one of the live wires, but all connected to the same neutral.

The neutral carries the "imbalance" between the power carried on the 3 live wires. Hence electrical engineers work hard to make sure that the power is shared around equally, so the neutral wire carries as little power as possible and can therefore be made much smaller than the other 3.

The '3-wire' and '4-wire' designations do not count the ground wire used on many transmission lines, as this is solely for fault and lightning protection and does not serve to deliver electrical power.

The most important class of three-phase load is the electric motor. A three-phase induction motor has a simple design, inherently high starting torque and high efficiency. Such motors are applied in industry for pumps, fans, blowers, compressors, conveyor drives, electric vehicles and many other kinds of motor-driven equipment.

A three-phase motor is more compact and less costly than a single-phase motor of the same voltage class and rating and single-phase AC motors above 10 HP (7.5 kW) are uncommon. Three-phase motors also vibrate less and hence last longer than single-phase motors of the same power used under the same conditions.

Resistance heating loads such as electric boilers or space heating may be connected to three-phase systems. Electric lighting may also be similarly connected. These types of loads do not require the revolving magnetic field characteristic of three-phase motors but take advantage of the higher voltage and power level usually associated with three-phase distribution. Legacy single-phase fluorescent lighting systems also benefit from reduced flicker in a room if adjacent fixtures are powered from different phases.

Large rectifier systems may have three-phase inputs; the resulting DC is easier to filter (smooth) than the output of a single-phase rectifier. Such rectifiers may be used for battery charging, electrolysis processes such as aluminum production or for operation of DC motors.

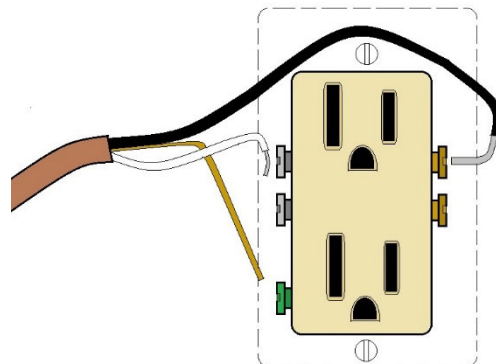

**TYPICAL COLOR CODING  
FOR 120 VOLT WIRING**

## Electromagnet Induction

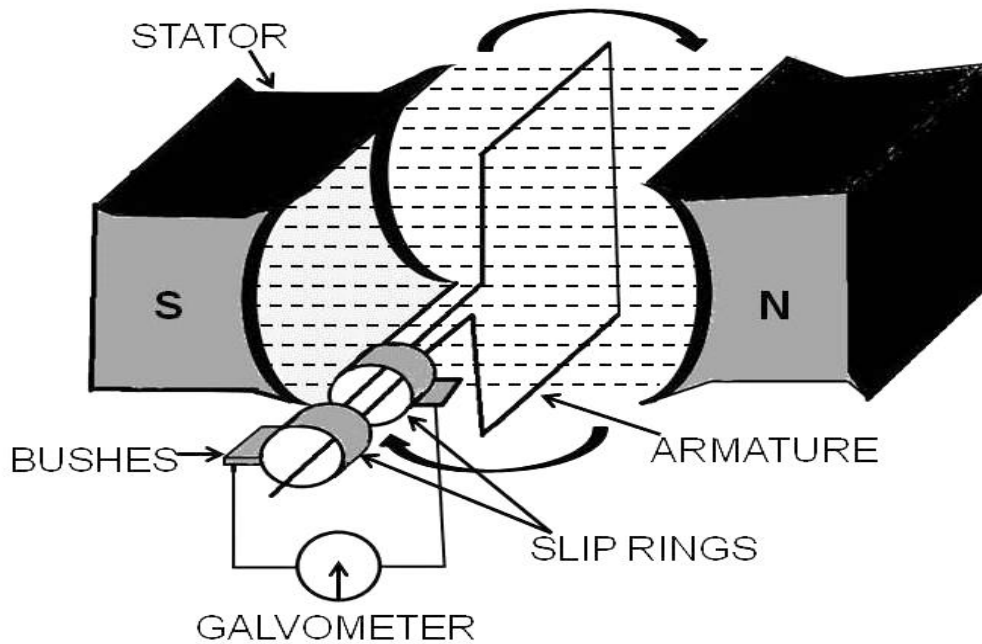

## PRODUCTION OF AC CURRENT

Alternating current is generated through an electrical effect called Electromagnet Induction.

Electromagnetic Induction is the ability of a magnetic field to generate a voltage or current in a conductor without physical contact.

When the conductor becomes part of a circuit, current flows in the circuit.

Generators convert rotational motion into current flow. As the coils are turned through a rotational magnetic, voltage is generated.

AC motors also depend upon electromagnetic induction. They convert current flow into rotational motion.

The conductor and the magnetic field are not physically connected, yet a voltage is induced in the conductor when the conductor moves through the magnetic field, or when the magnetic field moves through the conductor.

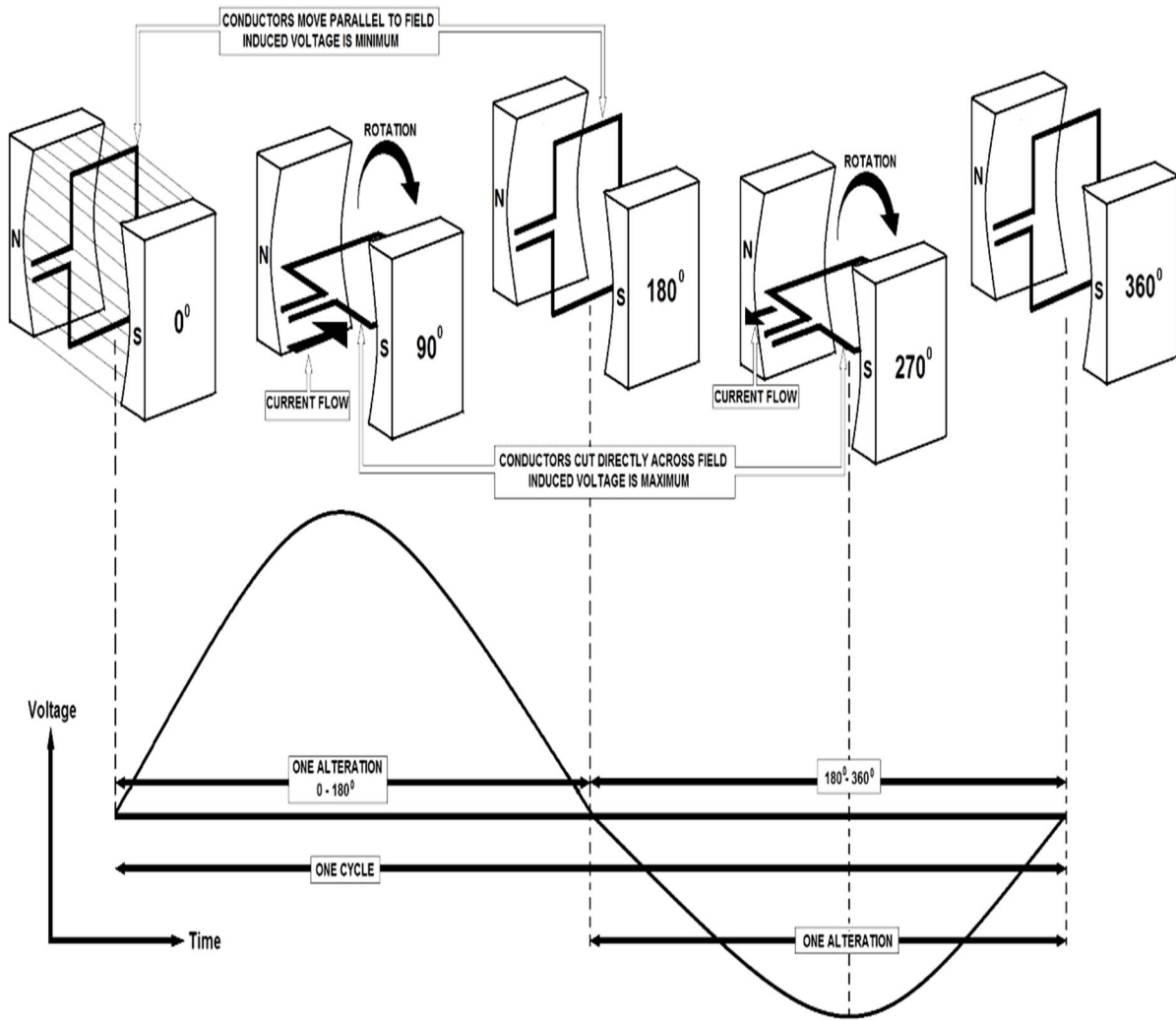

## Sine Wave for AC

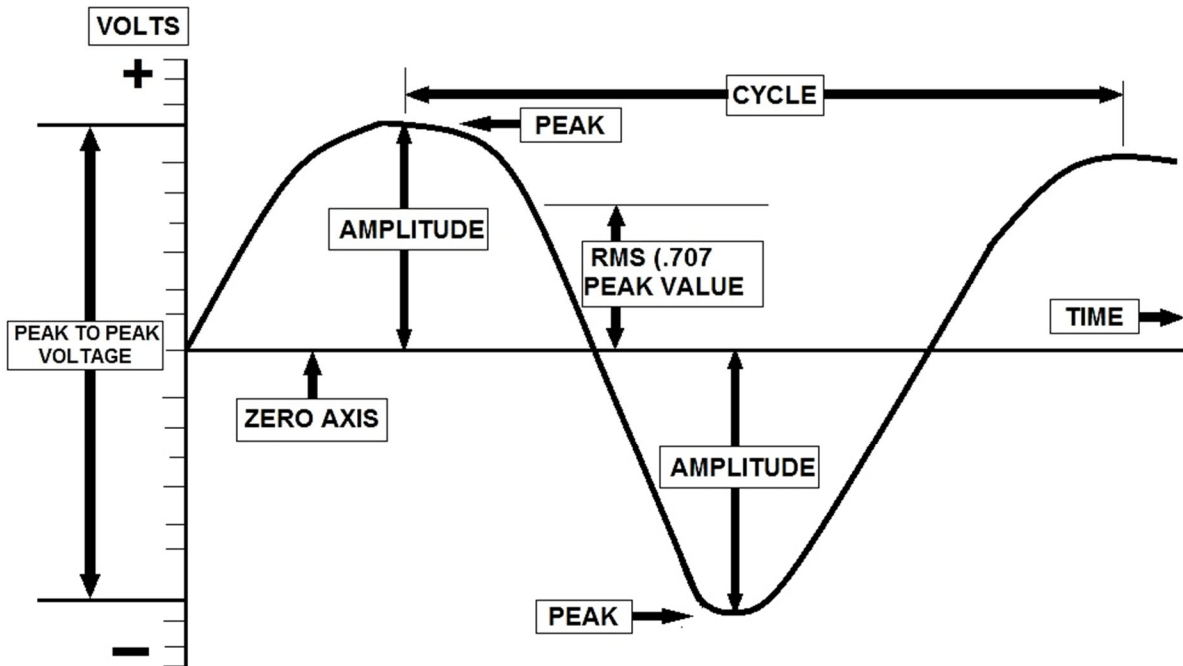

Alternating voltage and current generated by rotary motion take the form of a sine wave. It is the most common form of alternating current and voltage.

As the conductor turns through the magnetic field, it cuts through the magnetic lines of force at a varying rate. As a result, voltage varies in a regular, repetitive pattern.

## Sine Waves Are Measured and Compared by Certain Features

1. The AMPLITUDE of the sine wave tells you the maximum value of current or voltage; it can be either positive or negative.

2. A CYCLE is one complete repetition of the wave form. It is produced by one complete revolution- $360^{\circ}$  -of the conductor through the magnetic field. In each cycle, there are two reversals and two maximums.

The sine wave peaks in the positive direction at  $90^{\circ}$  , crosses the zero axis at  $180^{\circ}$  , peaks in the negative direction at  $270^{\circ}$  , then reaches zero again at  $360^{\circ}$  .

3. FREQUENCY is the number of cycles per second. The higher the number of cycles per second, the higher the frequency. The higher the frequency the less amount of time for one cycle. Most AC is generated at 60 cycles or 50 cycles per second.

**Note:** Amplitude and frequency are independent. Two waves can have the same amplitude and frequency, the same amplitude but different frequency, different amplitude but the same frequency, and different amplitude and different frequency.

4. HERTZ is the term used for cycles per (second. 60 Hertz = 60 cycles per second.

5. PEAK to PEAK voltage is the voltage measured between the maximum positive and maximum negative points on the sine wave. It is twice the amplitude.

6. RMS (root mean square) voltage or current is a standard means of measuring alternating current or voltage.  $RMS = .707 \times \text{peak value}$  (the amplitude of the sine wave).

7. A horizontal line through the center of the sine wave is the ZERO AXIS.

a. All values above the zero axis are POSITIVE values; all values below the zero axis are NEGATIVE values.

b. NEGATIVE current and voltage do just as much work as positive voltage and current. The only difference is that the polarity of the voltage is opposite and current flow is in the opposite direction. They produce exactly the same amount of power as positive current and voltage.

### Practice Exercise

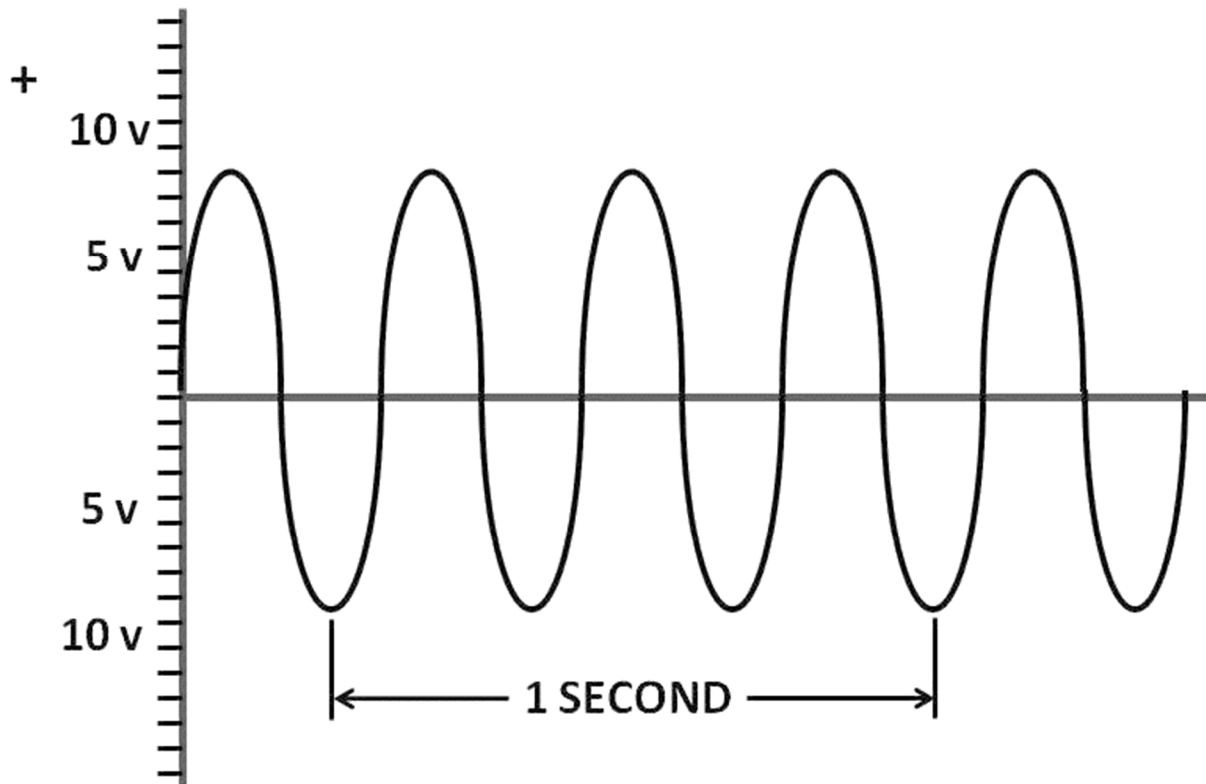

From the above sine wave graph, determine:

- A. the frequency of the AC. \_\_\_\_\_
- B. the peak voltage. \_\_\_\_\_
- C. the RMS value of the voltage. \_\_\_\_\_
- D. how long it takes the voltage to complete one cycle. \_\_\_\_\_

**Practice Exercise**

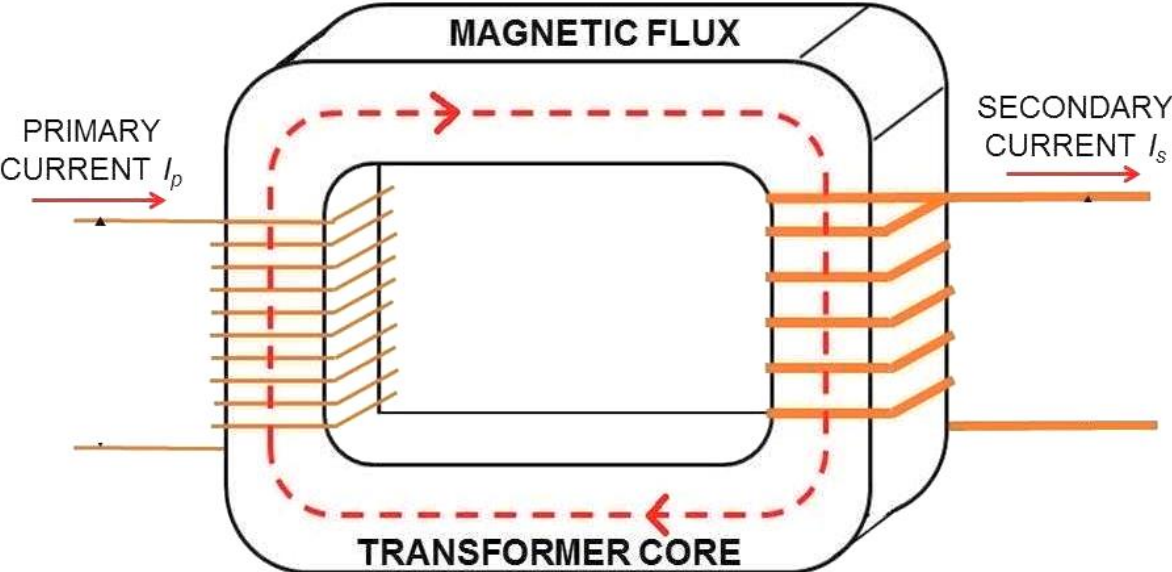



## Transformer Sub-Section

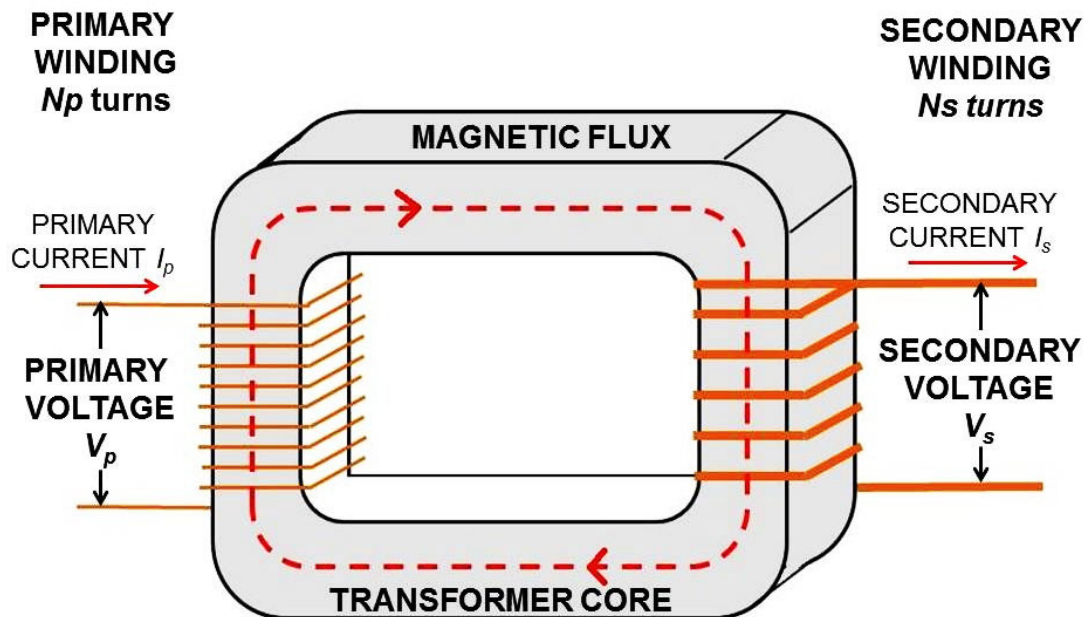

## TRANSFORMER

A **transformer** is an electrical device that transfers energy between two circuits through electromagnetic induction. Transformers may be used in voltage conversion to transform an AC voltage from one voltage level on the input of the device to another level at the output terminals, to provide for different requirements of current level as an alternating current source, or it may be used for impedance matching between mismatched electrical circuits to effect maximum power transfer between the circuits.

Transformers are used to increase voltage before transmitting electrical energy over long distances through wires. Wires have resistance which loses energy through joule heating at a rate corresponding to square of the current. By transforming power to a higher voltage transformers enable economical transmission of power and distribution. Consequently, transformers have shaped the electricity supply industry, permitting generation to be located remotely from points of demand. All but a tiny fraction of the world's electrical power has passed through a series of transformers by the time it reaches the consumer.

Transformers are also used extensively in electronic products to step-down the supply voltage to a level suitable for the low voltage circuits they contain. The transformer also electrically isolates the end user from contact with the supply voltage.

Signal and audio transformers are used to couple stages of amplifiers and to match devices such as microphones and record players to the input of amplifiers. Audio transformers allowed telephone circuits to carry on a two-way conversation over a single pair of wires.

A balun transformer converts a signal that is referenced to ground to a signal that has balanced voltages to ground, such as between external cables and internal circuits.

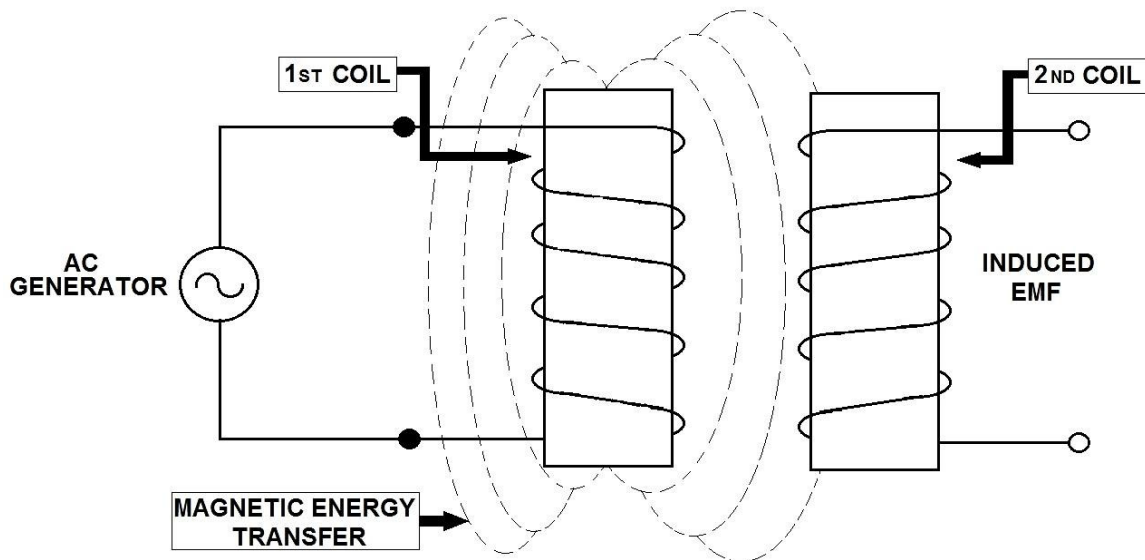

## TRANSFORMER

A transformer most commonly consists of two windings of wire wound around a common core to effect tight electromagnetic coupling between the windings. The core material is often a laminated iron core. The coil that receives the electrical input energy is referred to as the primary winding, while the output coil is called the secondary winding.

An alternating electric current flowing through the primary winding (coil) of a transformer generates an electromagnetic field in its surroundings and a varying magnetic flux in the core of the transformer.

By electromagnetic induction this magnetic flux generates a varying electromotive force in the secondary winding, resulting in a voltage across the output terminals.

If a load impedance is connected across the secondary winding, a current flows through the secondary winding drawing power from the primary winding and its power source.

A transformer cannot operate with direct current, but produces a short output pulse as the voltage rises when connected to the DC source.

## Transformer Classification Parameters

Transformers can be classified in many ways, such as the following:

- *Power capacity*: From a fraction of a volt-ampere (VA) to over a thousand MVA.
- *Duty of a transformer*: Continuous, short-time, intermittent, periodic, varying.
- *Frequency range*: Power-frequency, audio-frequency, or radio-frequency.
- *Voltage class*: From a few volts to hundreds of kilovolts.
- *Cooling type*: Dry and liquid-immersed - self-cooled, forced air-cooled; liquid-immersed - forced oil-cooled, water-cooled.
- *Circuit application*: Such as power supply, impedance matching, output voltage and current stabilizer or circuit isolation.
- *Utilization*: Pulse, power, distribution, rectifier, arc furnace, amplifier output, etc.
- *Basic magnetic form*: Core form, shell form.
- *Constant-potential transformer descriptor*: Step-up, step-down, isolation.
- *General winding configuration*: By EIC vector group - various possible two-winding combinations of the phase designations delta, wye or star, and zigzag or interconnected star; other - autotransformer, Scott-T, zigzag grounding transformer winding.
- *Rectifier phase-shift winding configuration*: 2-winding, 6-pulse; 3-winding, 12-pulse; . . . n-winding,  $[n-1]*6$ -pulse; polygon; etc..

## Transformer Types

Various specific electrical application designs require a variety of transformer types. Although they all share the basic characteristic transformer principles, they are customized in construction or electrical properties for certain installation requirements or circuit conditions.

- *Autotransformer*: Transformer in which part of the winding is common to both primary and secondary circuits.
- *Capacitor voltage transformer*: Transformer in which capacitor divider is used to reduce high voltage before application to the primary winding.
- *Distribution transformer, power transformer*: International standards make a distinction in terms of distribution transformers being used to distribute energy from transmission lines and networks for local consumption and power transformers being used to transfer electric energy between the generator and distribution primary circuits.
- *Phase angle regulating transformer*: A specialized transformer used to control the flow of real power on three-phase electricity transmission networks.
- *Scott-T transformer*: Transformer used for phase transformation from three-phase to two-phase and vice versa.
- *Polyphase transformer*: Any transformer with more than one phase.
- *Grounding transformer*: Transformer used for grounding three-phase circuits to create a neutral in a three wire system, using a wye-delta transformer, or more commonly, a zigzag grounding winding.
- *Leakage transformer*: Transformer that has loosely coupled windings.
- *Resonant transformer*: Transformer that uses resonance to generate a high secondary voltage.
- *Audio transformer*: Transformer used in audio equipment.
- *Output transformer*: Transformer used to match the output of a valve amplifier to its load.
- *Instrument transformer*: Potential or current transformer used to accurately and safely represent voltage, current or phase position of high voltage or high power circuits.

## Transformer Applications

Transformers perform voltage conversion; isolation protection; and impedance matching. In terms of voltage conversion, transformers can step-up voltage/step-down current from generators to high-voltage transmission lines, and step-down voltage/step-up current to local distribution circuits or industrial customers.

The step-up transformer is used to increase the secondary voltage relative to the primary voltage, whereas the step-down transformer is used to decrease the secondary voltage relative to the primary voltage.

Transformers range in size from thumbnail-sized used in microphones to units weighing hundreds of tons interconnecting the power grid. A broad range of transformer designs are used in electronic and electric power applications, including miniature, audio, isolation, high-frequency, power conversion transformers, etc.

### Transformer Basic Principles

The functioning of a transformer is based on two principles of the laws of electromagnetic induction: An electric current through a conductor, such as a wire, produces a magnetic field surrounding the wire, and a changing magnetic field in the vicinity of a wire induces a voltage across the ends of that wire.

The magnetic field excited in the primary coil gives rise to self-induction as well as mutual induction between coils.

This self-induction counters the excited field to such a degree that the resulting current through the primary winding is very small when no load draws power from the secondary winding.

The physical principles of the inductive behavior of the transformer are most readily understood and formalized when making some assumptions to construct a simple model which is called the *ideal transformer*.

This model differs from *real transformers* by assuming that the transformer is perfectly constructed and by neglecting that electrical or magnetic losses occur in the materials used to construct the device.

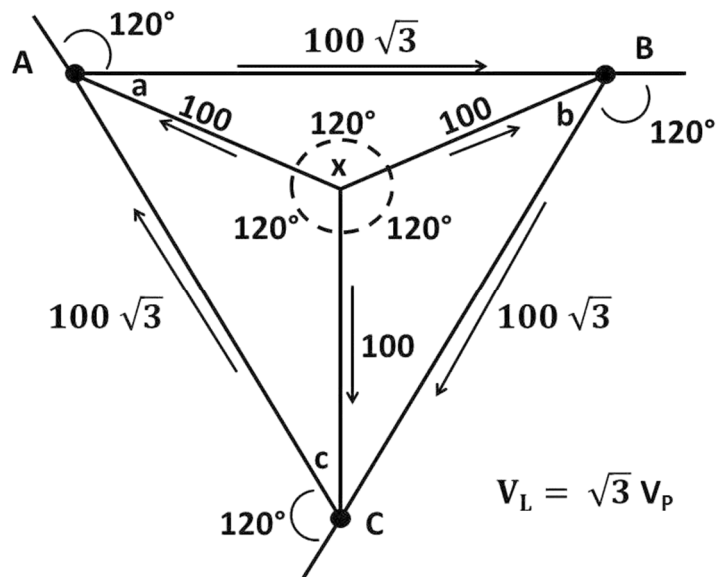

## Transformers

- Make AC power transmission and distribution possible.
- Transform values of voltage and current.
- Operate on the principle of electromagnetic induction.
- Usually transfer AC voltages from one circuit to another.

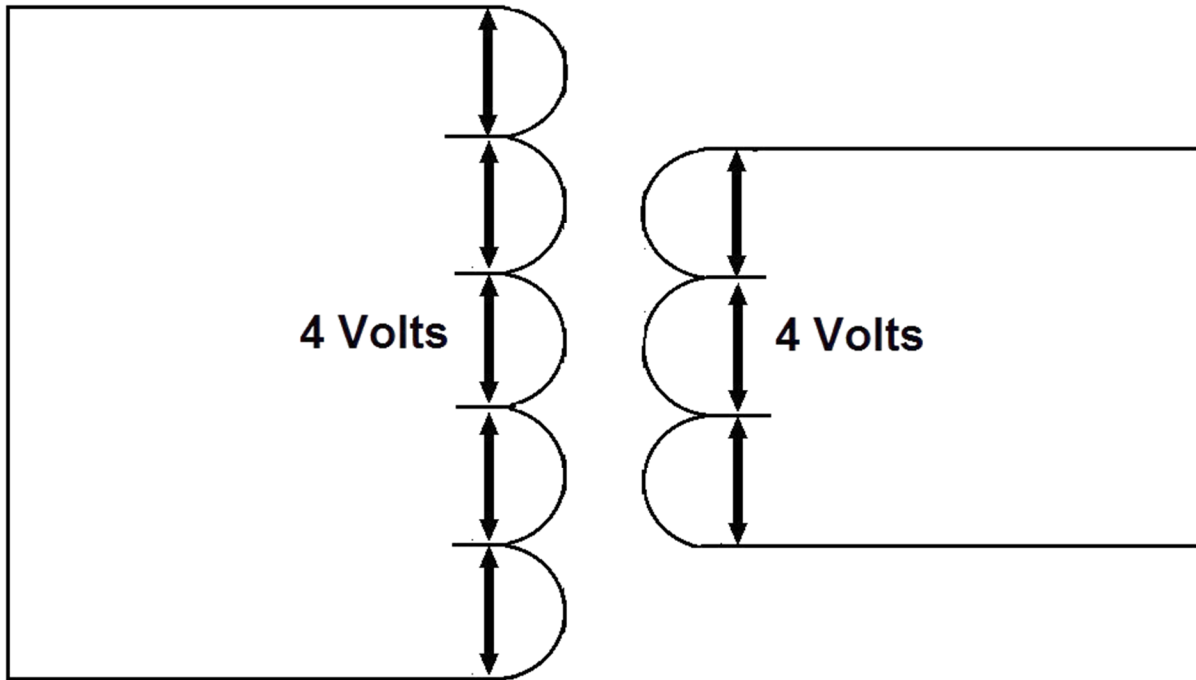

Most transformers are designed either to step voltage up or to step it down, although some are used only to isolate one voltage from another.

Transformers work because electric current generates a magnetic field around its conductor. If the current flow is steady, as in DC, the magnetic field is constant. But in AC, as the current changes direction the magnetic field keeps expanding and collapsing.

Transformers consist of a primary winding or coil connected to the source circuit and a secondary winding connected to the load circuit. When AC flows through the primary, its collapsing and expanding magnetic field induces a voltage and current in the secondary as the lines of force keep cutting through the secondary coil windings.

Each turn of wire in the, primary coil has an equal share at the primary voltage across it.

The same voltage is induced in each turn of the secondary coil. So if each turn in the primary coil has 4 volts across it, each turn in the secondary will also have 4 volts across it.

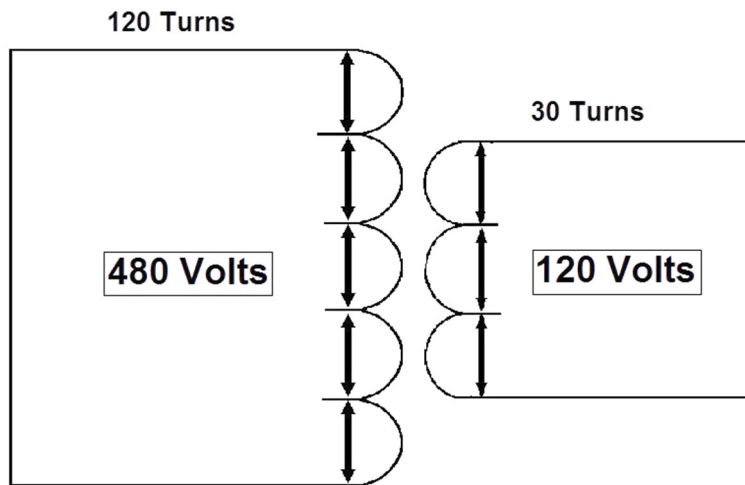

**Step-Down Transformers**

If there are fewer turns in the secondary, the secondary voltage will be lower than the primary.

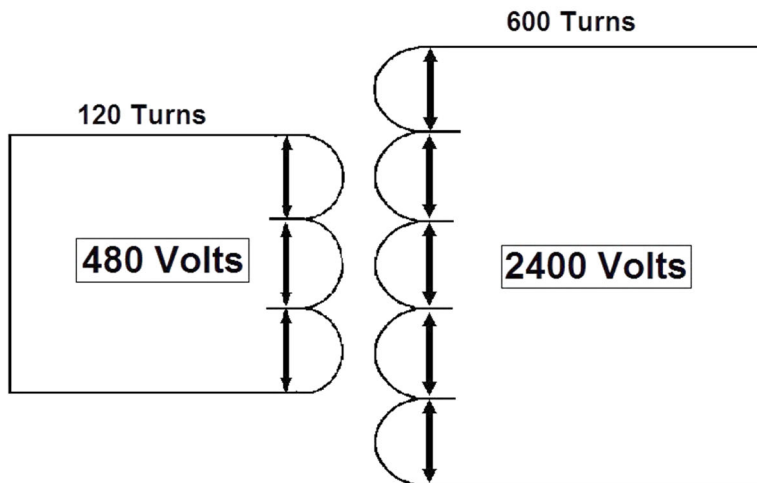

**Step-Up Transformers**

If there are more turns in the secondary coil than in the primary, voltage will be higher on the secondary circuit.

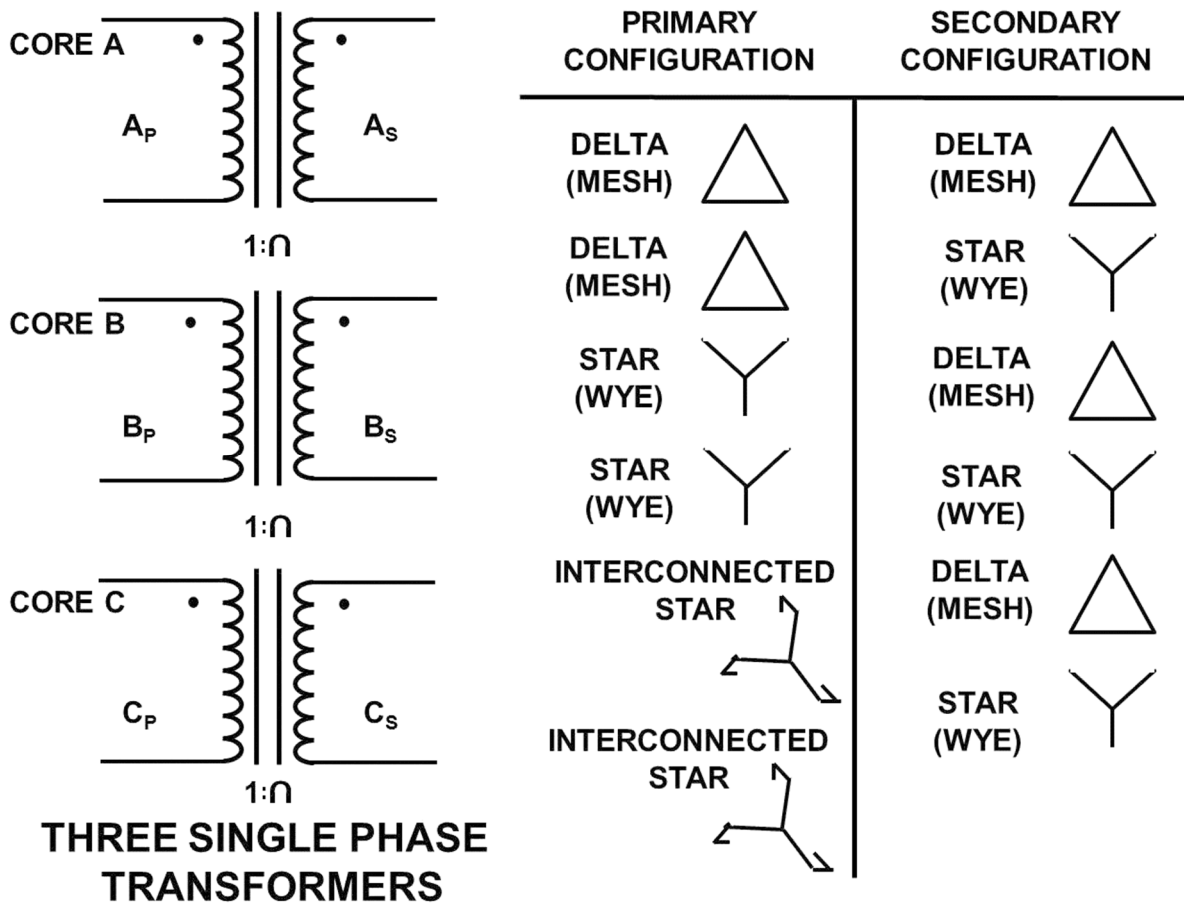

The primary and secondary windings of a transformer can be connected in different configuration as shown to meet practically any requirement. In the case of *three phase transformer* windings, three forms of connection are possible: “star” (wye), “delta” (mesh) and “interconnected-star” (zig-zag).

The combinations of the three windings may be with the primary delta-connected and the secondary star-connected, or star-delta, star-star or delta-delta, depending on the transformers use.

When transformers are used to provide three or more phases they are generally referred to as a **Polyphase Transformer**.

## Transformer Efficiency Triangle

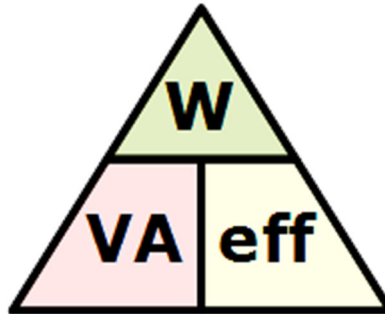

Transposing the above triangle quantities gives us the following combinations of the same equation:

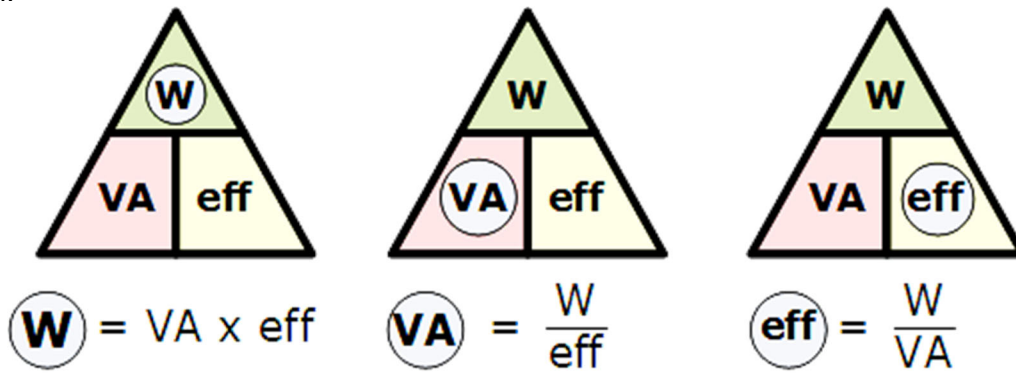

Then, to find Watts (output) = VA x eff., or to find VA (input) = W/eff., or to find Efficiency, eff. = W/VA, etc.



## Calculating Voltage

The relationship between the number of turns in the secondary and primary is called the turns ratio. This formula lets you calculate secondary voltage when you know primary voltage and the turns ratio.

$$V_s = V_p \times \frac{\text{secondary turns}}{\text{primary turns}}$$

For our step-up transformer

$$V_s = 480v \times \frac{600}{120} \text{ or simplify } \frac{5}{1}$$

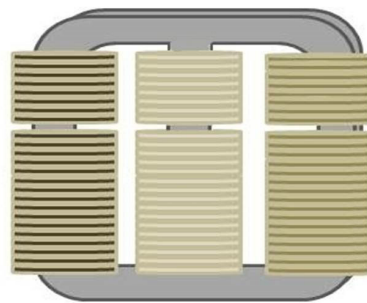

$$V_s = 480v \times 5$$

$$V_s = 2400 v$$

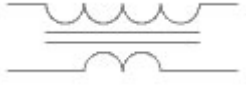
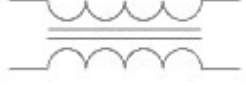

THREE PHASE TRANSFORMER

## Circuit Symbols

	<p>Two windings and an iron core, step-up or step-down as windings are different ratios.</p>
	<p>Transformer with two windings and an iron core.</p>
	<p>Transformer with three windings, two secondary windings.</p>
	<p>Transformer with an earth screen.</p>

## Three Phase Circuit Symbols

The three primary windings are connected together and the three secondary windings at together. This is also sometimes referred to as a polyphase transformer.

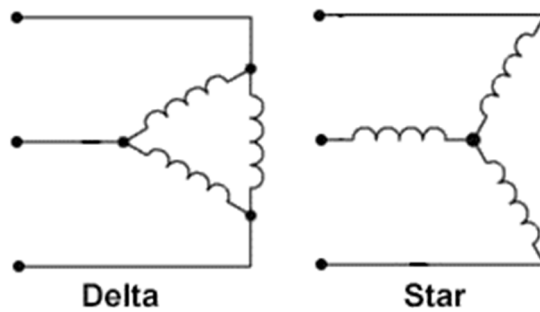

The most common connections are Y-A, A-Y, A-A and Y-Y.

There are many possible configurations that may involve more or fewer than six windings and various tap connections

Connecting transformers requires knowing how to calculate voltage, current, and power.

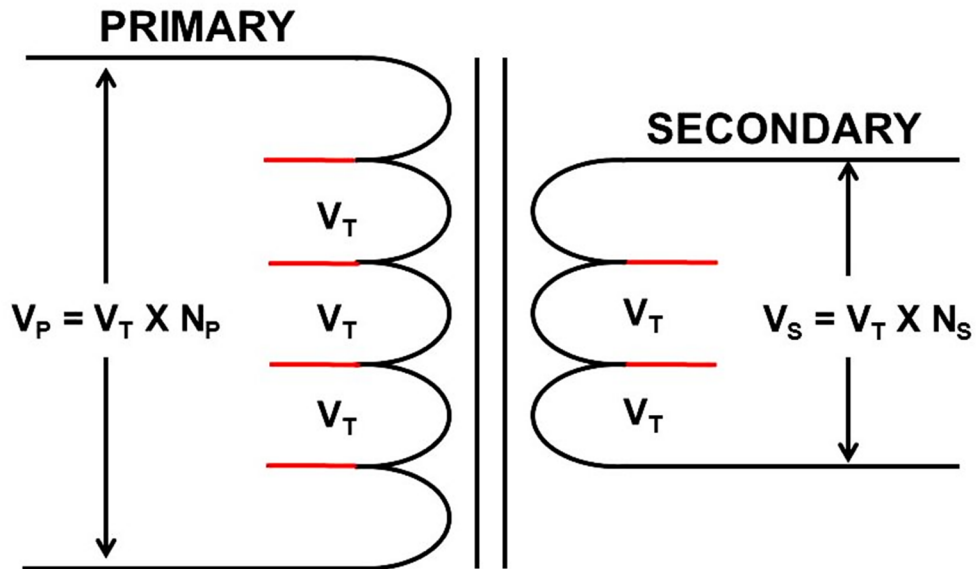

**N = number of turns in winding**

The voltage across the primary will be the voltage on each turn times the number of turns. The voltage across the secondary will be the voltage on each turn times the number of turns in the secondary.

The ratio of the voltage across one winding to the voltage across the other winding is the same as the ratio of turns between windings:

The turns ratio of a transformer is often specified as the number of turns in the secondary divided by the number of turns in the primary.

$$\frac{V_S}{V_L} = \frac{T_S}{T_P} = \text{TURNS RATIO}$$

- 1) If the turns ratio and the primary voltage are known, the secondary voltage is simply the primary voltage times the turns ratio.
- 2) Secondary current, however, is primary current divided by the turns ratio.
- 3) Transformers are usually rated in KVA (Kilovolt amperes). Current times voltage delivered to a load is very nearly equal to current times voltage into the primary, although there is some loss as heat.

When load current changes, primary current will also change. If a short develops across the load, it is almost as if the terminals of the primary winding had been shorted. A fuse or breaker on the primary side will open.

If the secondary circuit opens so that no current is being drawn, primary current will be very small.

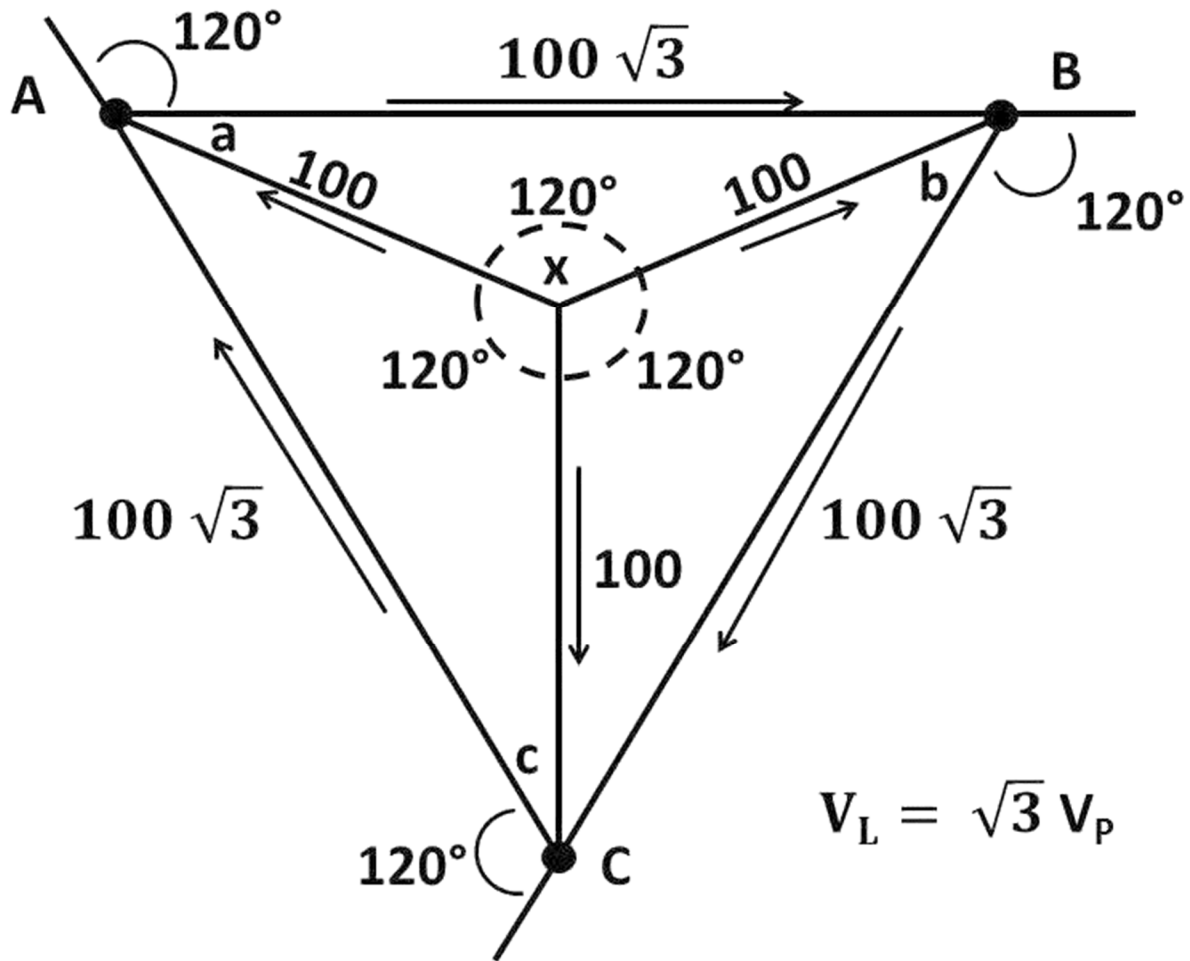

## Wye

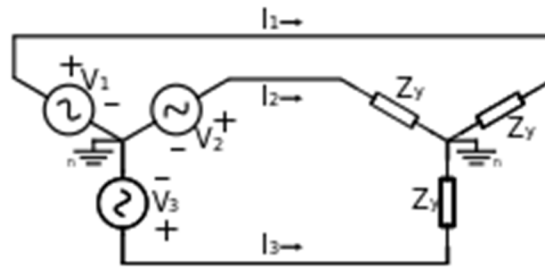

Three phase AC generator connected as a wye source to a wye connected load.

For the wye case, all loads see their respective line voltages, and so:

$$I_1 = \frac{V_1}{|Z_{total}|} \angle(-\theta)$$

$$I_2 = \frac{V_2}{|Z_{total}|} \angle(-120^\circ - \theta)$$

$$I_3 = \frac{V_3}{|Z_{total}|} \angle(120^\circ - \theta)$$

where  $Z_{total}$  is the sum of line and load impedances ( $Z_{total} = Z_{LN} + Z_Y$ ), and  $\theta$  is the phase of the total impedance ( $Z_{total}$ ).

The phase angle difference between voltage and current of each phase is not necessarily 0 and is dependent on the type of load impedance,  $Z_Y$ . Inductive and capacitive loads will cause current to either lag or lead the voltage. However, the relative phase angle between each pair of lines (1 to 2, 2 to 3, and 3 to 1) will still be  $-120$  degrees.

By performing Kirchhoff's Current Law (KCL) on the neutral node, the three phase currents sum up to the total current in the neutral line.

In the balanced case:

$$I_1 + I_2 + I_3 = I_n = 0$$

## Delta

In the delta circuit loads are connected across the lines and so loads see line-to-line voltages:

$$\begin{aligned}V_{12} &= V_1 - V_2 = (V_{LN}\angle 0^\circ) - (V_{LN}\angle -120^\circ) \\ &= \sqrt{3}V_{LN}\angle 30^\circ = \sqrt{3}V_1\angle(\text{phase}_{V_1} + 30^\circ)\end{aligned}$$

$$\begin{aligned}V_{23} &= V_2 - V_3 = (V_{LN}\angle -120^\circ) - (V_{LN}\angle 120^\circ) \\ &= \sqrt{3}V_{LN}\angle -90^\circ = \sqrt{3}V_2\angle(\text{phase}_{V_2} + 30^\circ)\end{aligned}$$

$$\begin{aligned}V_{31} &= V_3 - V_1 = (V_{LN}\angle 120^\circ) - (V_{LN}\angle 0^\circ) \\ &= \sqrt{3}V_{LN}\angle 150^\circ = \sqrt{3}V_3\angle(\text{phase}_{V_3} + 30^\circ)\end{aligned}$$

Further:

$$\begin{aligned}I_{12} &= \frac{V_{12}}{|Z_\Delta|}\angle(30^\circ - \theta) \\ I_{23} &= \frac{V_{23}}{|Z_\Delta|}\angle(-90^\circ - \theta) \\ I_{31} &= \frac{V_{31}}{|Z_\Delta|}\angle(150^\circ - \theta)\end{aligned}$$

where  $\theta$  is the phase of delta impedance ( $Z_\Delta$ ).

Relative angles are preserved, so  $I_{31}$  lags  $I_{23}$  lags  $I_{12}$  by 120 degrees. Calculating line currents by using KCL at each delta node gives:

$$\begin{aligned}I_1 &= I_{12} - I_{31} = I_{12} - I_{12}\angle 120^\circ \\ &= \sqrt{3}I_{12}\angle(\text{phase}_{I_{12}} - 30^\circ) = \sqrt{3}I_{12}\angle(-\theta)\end{aligned}$$

And similarly for each other line:

$$\begin{aligned}I_2 &= \sqrt{3}I_{23}\angle(\text{phase}_{I_{23}} - 30^\circ) = \sqrt{3}I_{23}\angle(-120^\circ - \theta) \\ I_3 &= \sqrt{3}I_{31}\angle(\text{phase}_{I_{31}} - 30^\circ) = \sqrt{3}I_{31}\angle(120^\circ - \theta)\end{aligned}$$

again,  $\theta$  is the phase of delta impedance ( $Z_\Delta$ ).

## Three Phase Wyes and Deltas

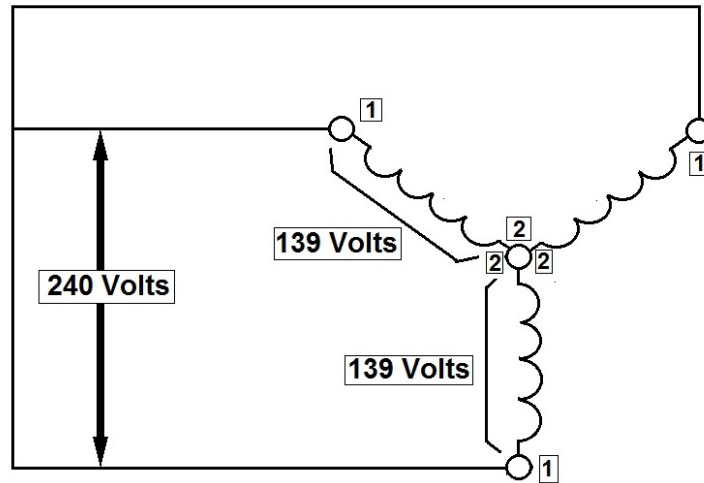

Three phase voltages can be generated and transformed as either a Wye or a Delta. Wye and Delta refer to the connections between the single phase windings which connect to create three phase voltages. Notice the polarity of each winding at the connection points. In a Wye all the ends or 2's are connected together while the beginnings or 1's are connected to the three phase power source, L1, L2, and L3. In a Delta the end (2) of one winding is connected to the beginning (1) of another winding. Three phase power is connected to each of these 1,2 junction points.

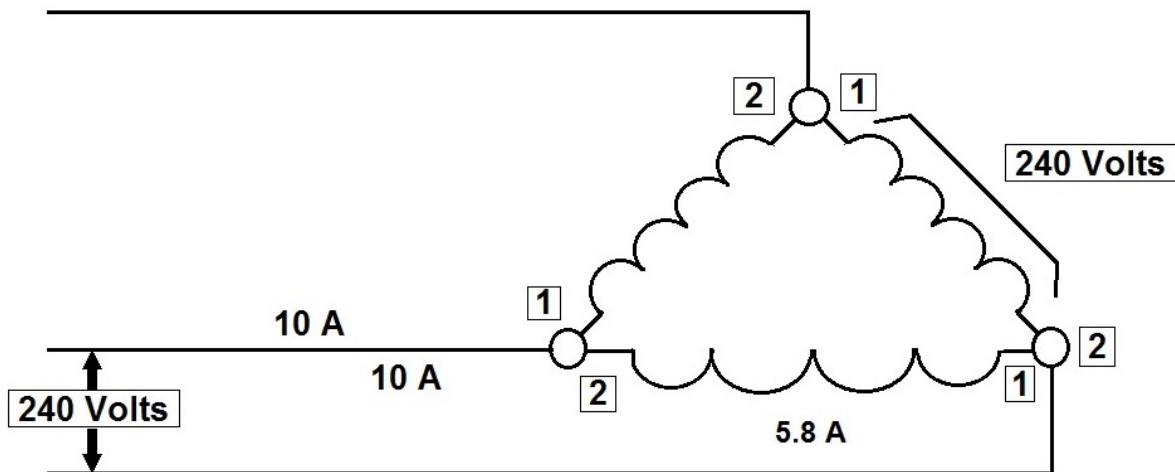

Each system, Wye and Delta, has a useful purpose. Voltage flow affects each system differently due to polarity and the physical relationship of each winding to another.

In a Wye system voltage phase to phase is 1.73 times greater than the phase-to-ground voltage. The 1.73 is derived from the square root of three. This accounts for the relationship of the three different single phase voltages. In a Delta system the phase-to-phase current is 1.73 times greater than the current in each individual phase or winding.

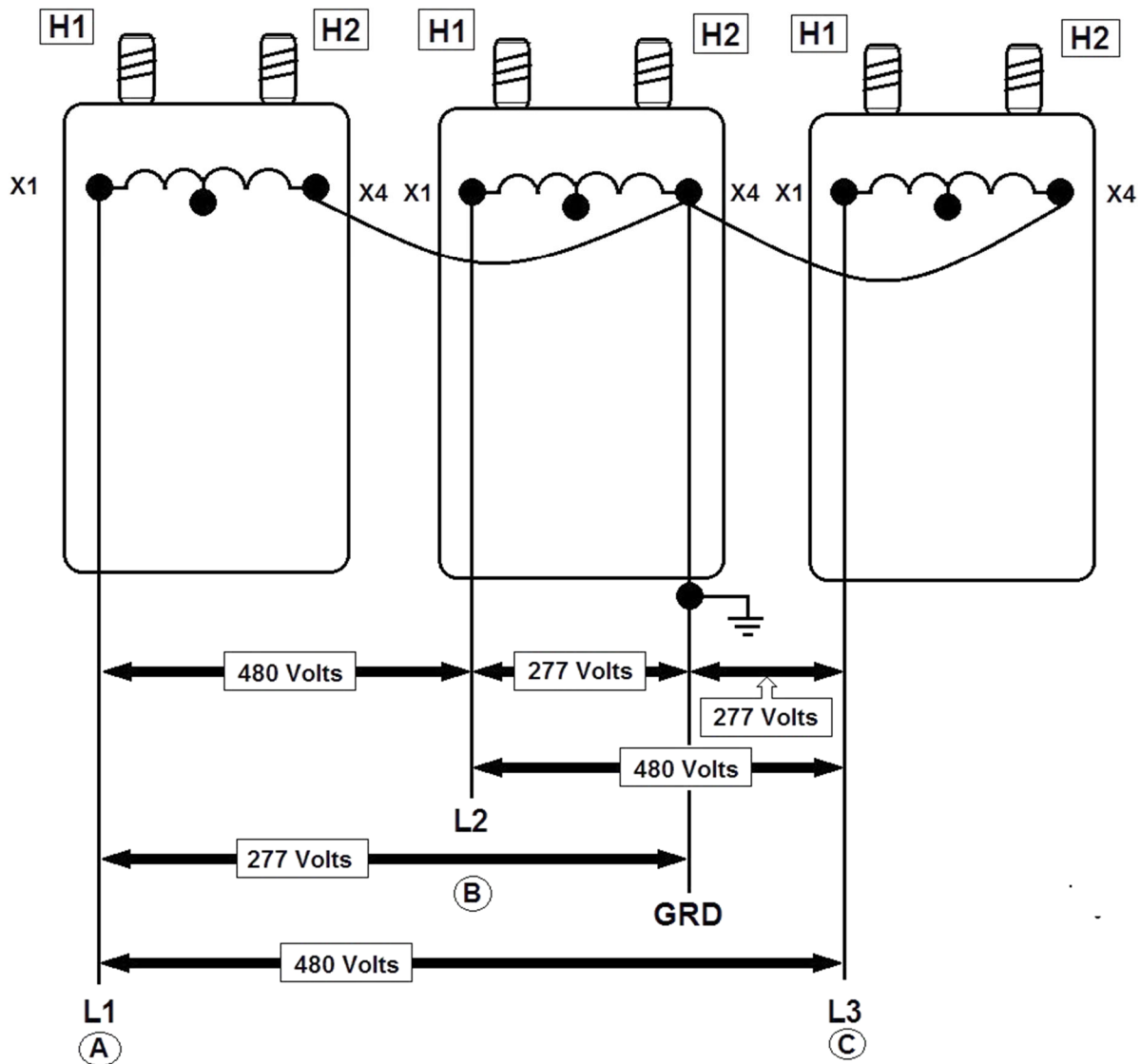

The Wye system is quite popular for newer and larger commercial and industrial buildings.

Wye systems must always be grounded to stabilize the voltage levels. 480 Volts is one of the best voltages to operate three phase motors. 277 Volts is one of the best voltages to operate High Intensity Discharge lighting. A Wye system can deliver both of these voltages. Phase-to-phase the voltage is 480. Phase-to-ground the voltage is 277.

For any three phase system to operate efficiently the single phase loads must be balanced.

The current delivered on Phase A should equal the current delivered on Phase B.

The current delivered on Phase B should equal the current delivered on Phase C.

Of course no system will be perfectly balanced due to varying single phase loads. However, the goal is to balance the loads as close as possible.



## Polyphase System

A **polyphase system** is a means of distributing alternating-current electrical power. Polyphase systems have three or more energized electrical conductors carrying alternating currents with a definite time offset between the voltage waves in each conductor. Polyphase systems are particularly useful for transmitting power to electric motors.

The most common example is the three-phase power system used for industrial applications and for power transmission. The most obvious advantage of three-phase power transmission using three wires, as compared to single-phase power transmission over two wires, is that the power transmitted in the three-phase system is the voltage multiplied by the current in each wire times the square root of three (approximately 1.73). The power transmitted by the single-phase system is simply the voltage multiplied by the current. Thus the three-phase system transmits 73% more power but uses only 50% more wire.

### Phases

In the very early days of commercial electric power, some installations used two-phase four-wire systems for motors. The chief advantage of these was that the winding configuration was the same as for a single-phase capacitor-start motor and, by using a four-wire system, conceptually the phases were independent and easy to analyze with mathematical tools available at the time.

Two-phase systems can also be implemented using three wires (two "hot" plus a common neutral). However, this introduces asymmetry; the voltage drop in the neutral makes the phases not exactly 90 degrees apart.

Two-phase systems have been replaced with three-phase systems. A two-phase supply with 90 degrees between phases can be derived from a three-phase system using a Scott-connected transformer.

A polyphase system must provide a defined direction of phase rotation, so mirror image voltages do not count towards the phase order. A 3-wire system with two phase conductors 180 degrees apart is still only single phase. Such systems are sometimes described as split-phase.

### Motors

Polyphase power is particularly useful in AC motors, such as the induction motor, where it generates a rotating magnetic field. When a three-or-more-phase supply completes one full cycle, the magnetic field of a two-poles-per-phase motor has rotated through 360° in physical space; motors with more than two poles per phase require more power supply cycles to complete one physical revolution of the magnetic field and so these motors run slower. Induction motors using a rotating magnetic field were independently invented by Galileo Ferraris and Nikola Tesla (1885 - 1887) and developed in a three-phase form by Mikhail Dolivo-Dobrovolsky in 1889.

Previously all commercial motors were DC, with expensive commutators, high-maintenance brushes and characteristics unsuitable for operation on an alternating current network. Polyphase motors are simple to construct, are self-starting and have little vibration compared with single-phase motors.

## Practice Exercise

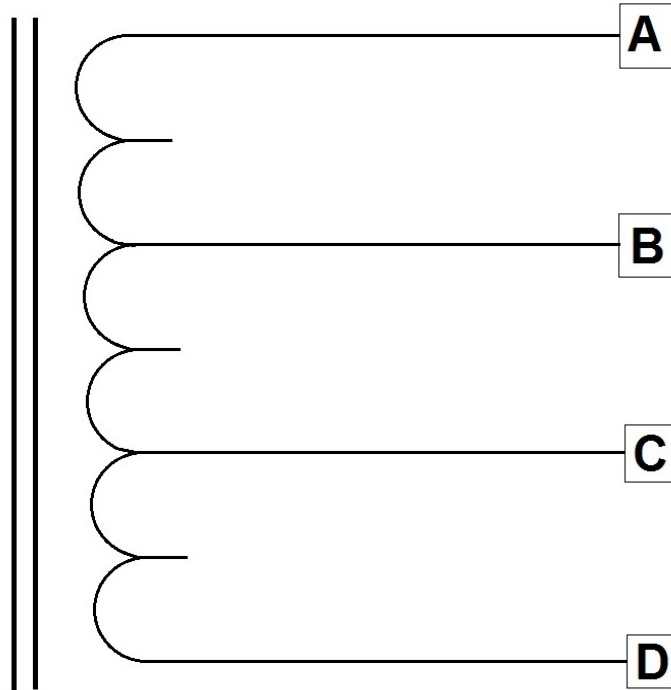

The autotransformer shown above has two taps, equally spaced on the winding. At which points should the primary and secondary connections be made to:

	Primary	Secondary
1. step 240 volts up to 480 volts.	_____	_____
2. step 240 volts down to 160 volts.	_____	_____
3. provide 30 amperes out with 10 amperes in.	_____	_____

### 3-Phase Power

Most power is distributed in the form of 3-phase AC. Basically, instead of just one coil turning in a generator, there are three coils, spaced 120 degrees apart.

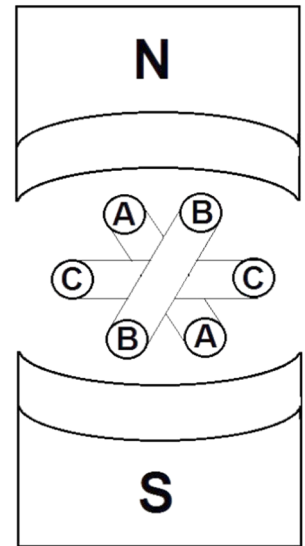
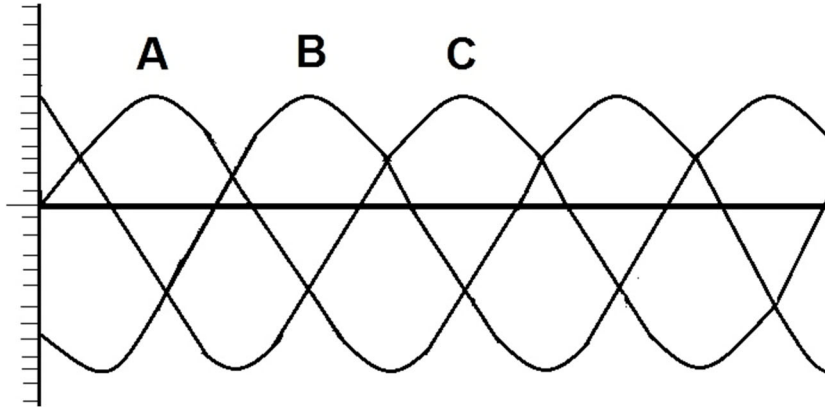

As the coils turn through the magnetic field, power is sent out on three lines. Three current and voltage sine waves are generated, 120 degrees out of phase with each other. Each sine wave represents the current or voltage on one of the phases.

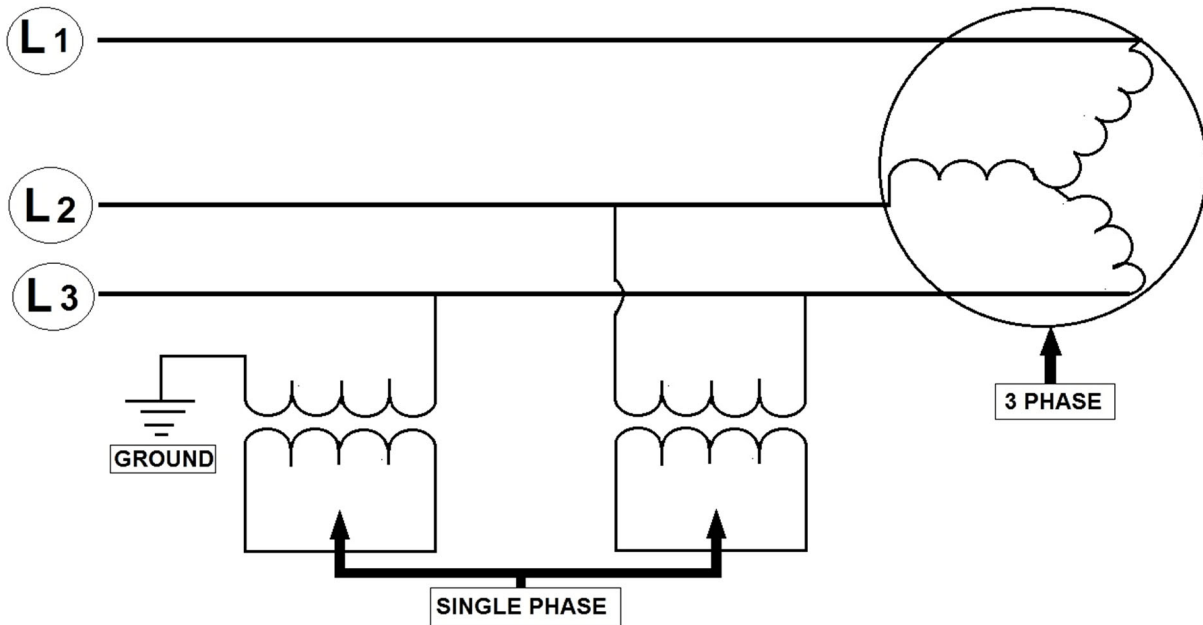

Three-phase electricity powers large industrial loads more efficiently than single phase electricity. When- single-phase electricity is needed, it is available between any two phases, or, in some systems, between one of the phases and ground.

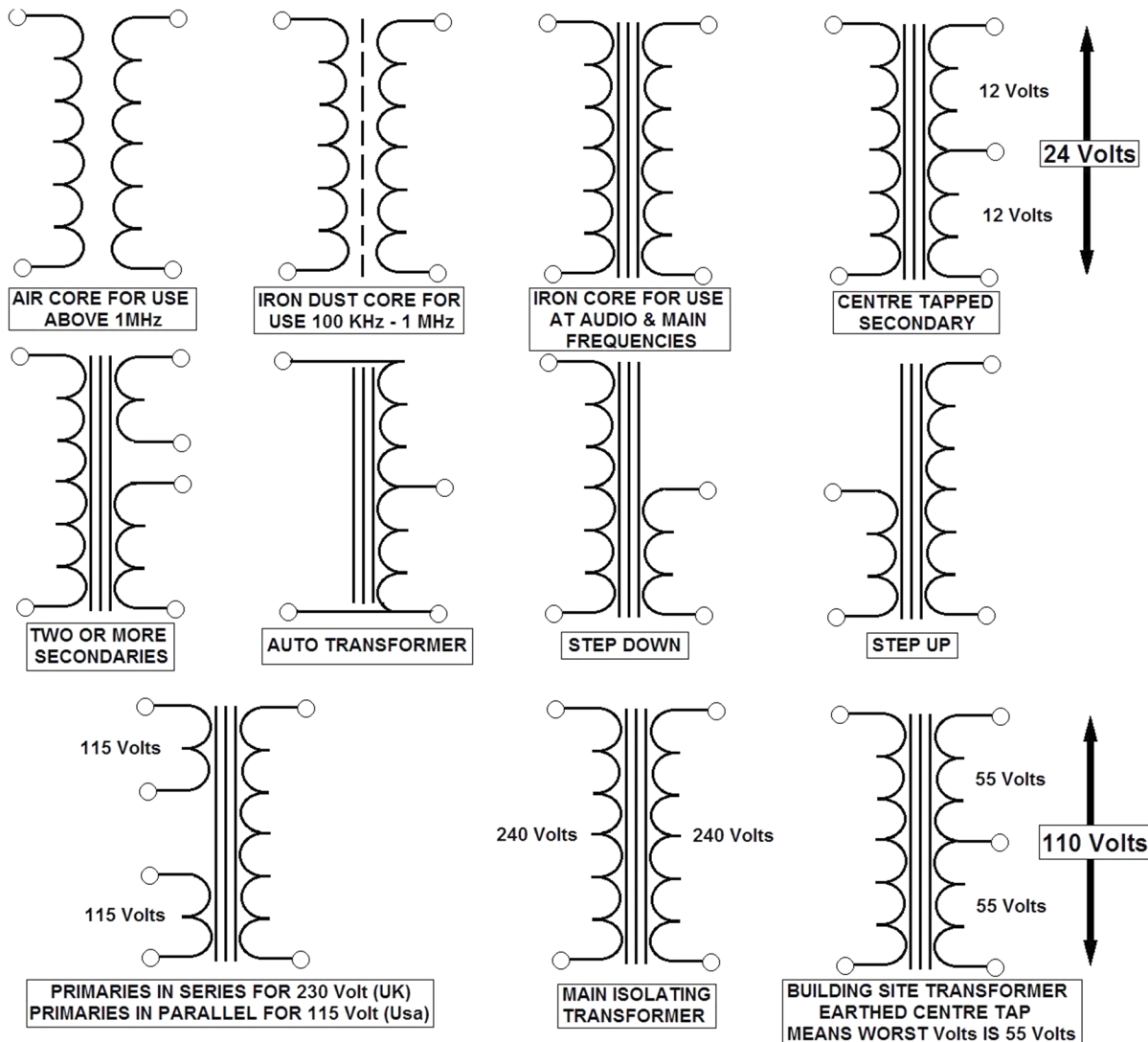

## TYPES OF TRANSFORMERS

### Higher Phase Order

Higher phase numbers than three have been used. A common practice for rectifier installations and in HVDC converters is to provide six phases, with 60-degree phase spacing, to reduce harmonic generation in the AC supply system and to provide smoother direct current.

Experimental high-phase-order transmission lines have been built with up to 12 phases. These allow application of Extra High Voltage (EHV) design rules at lower voltages and would permit increased power transfer in the same transmission line corridor width.

# Electrical Glossary

## Basic Electrical Terms

**AC and DC:** Abbreviations for alternating current and direct current respectively.

**Current** - A movement of electricity analogous to the flow of a stream of water.

**Direct Current** - An electric current flowing in one direction only (i.e. current produced using a battery).

**Alternating Current** - a periodic electric current that reverses its direction at regular intervals.

**Accessible:** Three common uses of accessible: (Wiring methods) - Capable of being removed or exposed without damaging the building structure or finish, or not permanently enclosed by such. Wires in concealed raceways are not considered accessible. (Equipment) -Admitting close approach; not guarded by locked doors or other effective means.

**Readily Accessible** - Capable of being reached quickly for operation, renewal, or inspections without the requirement of climbing over or removing obstacles or use of portable ladders, chairs, etc.

**Amp** or Ampere: The unit of intensity of electrical current (the measure of electrical flow), is abbreviated a or A.

**Box:** An enclosure designed to provide access to the electrical wiring system. Uses include but are not limited to provide device and lighting outlets and wiring system junction points. Specially designed boxes are required for the support of listed ceiling fans weighing less than 35 lb (15. kg). Fans exceeding this weight limit must be supported independently of the outlet box.

**Circuit Breaker:** A device designed to open and close a circuit by non-automatic means and to open the circuit automatically on a predetermined over current without damaging itself when operated according to its rating.

**Circuit:** A complete path from the energy source through conducting bodies and back to the energy source.

**Conductor:** a substance or body capable of transmitting electricity. Bare - A conductor having no covering or electrical insulation whatsoever.

**Covered** - A conductor encased within material of composition or thickness that is not recognized by the NEC as electrical insulation.

**Insulated** - A conductor encased within material of composition or thickness that is recognized by the NEC as electrical insulation.

**Device:** A unit of an electrical system that is intended to carry but not utilize electricity.

**Equipment:** A general term including material, fittings, devices, alliances, fixtures, apparatus, and similar items used as a part of, or in connection with, an electrical installation.

**Fuse:** An over current protective device with a circuit opening part that is heated and broken by the passage of an over current through it.

**GFCI** (Ground Fault Circuit Interrupter): A device intended for the protection of personnel that de-energizes a circuit or portion of a circuit when the current to ground exceeds a preset value. "*Ground Fault*" is the name applied to this undesired circuit condition. In dwelling units (e.g. houses, apartments), GFCI protection is currently required in bathrooms, garages, outdoors, unfinished basements, kitchens and wet bar sinks. Other specific installations and/or areas may also necessitate the need for protection

**Ground:** A conducting connection, intentional or accidental, between an electrical circuit or equipment and the earth, or some conducting body that serves in place of the earth. Other associated terms are: Grounded conductor - A system or circuit conductor that is intentionally connected to ground. This conductor has also been referred to as the *neutral* or common conductor. Grounding conductor - a conductor used to connect equipment or the grounded circuit of a wiring system to the grounding electrode (s). Ungrounded conductor - A current carrying conductor not connected to ground.

**Kilowatt-hour:** Work done at the steady rate equivalent to 1000 watts in one hour. Power utility companies' base their billing upon the number of kilowatt-hours (KWH) consumed.

**Labeled:** Equipment or materials that a label or other identifying mark of a listing organization has been attached.

**Lamp:** A general term for various devices for artificially producing light.

**Listed:** Equipment and/or materials included in a list published by an organization concerned with product evaluation and production of listed items. The listing states whether the item meets designated standards or is suitable for use in a specified manner. Listing organizations acceptable to jurisdiction authorities include Underwriters' Laboratories (UL) and CSA.

**NEC** (National Electrical Code): a document produced by the National Fire Protection Association for the purpose of the practical safeguarding of persons and property from hazards arising from the use of electricity. Authorities having legal jurisdiction over electrical installations adopt the code for mandatory application (i.e. incorporate the code into law).

**Ohm:** The unit of electrical resistance and impedance, abbreviated with the symbol omega,  $W$ . Resistance is the opposition offered by a substance to the passage of electrical current. Impedance is the apparent resistance in a circuit to the flow of alternating current.

**Ohm's Law:** A statement of the relationship, discovered by the German scientist G. S. Ohm, between the voltage, amperage and resistance of a circuit. It states the voltage of a circuit in volts is equal to the product of the amperage in amperes and the resistance in ohms.  **$E=IR$**

**Over current:** Any current in excess of the rated current or ampacity. It may result from overload, short circuit or ground fault.

**Overload:** Operation in excess of normal full-load rating or rated ampacity which could cause damage or dangerous overheating if continued for a sufficient time. A fault, such as a short circuit or ground fault, is not an overload. See "Over Current".

**Phase:** the point or stage in the period to which the rotation, oscillation, or variation has advanced relative to a standard position or starting point. *electrically*, one of the voltage sources of an alternating current electrical system whose voltage state is measured relative to a standard point.

**Raceway:** An enclosed channel of metallic or nonmetallic materials designed expressly for holding wires, cables, or bussbars. Examples are electrical metallic tubing (EMT), flexible

**Receptacle:** a device installed for the connection of a single contact device. Receptacles provide a means of connecting apparatus that utilize electricity to the wiring system.

**Service:** the conductors and equipment for delivering electrical energy from the supply system (e.g. the electric power utility) to the wiring system of the premises served.

**Single Phase:** a system of alternating current power where the phase relationship between ungrounded conductors is either 0 or 180 degrees.

**Three Phase:** a system of alternating current power where the phase relationship between ungrounded conductors is either 0 or 120 degrees.

**Transformer:** An apparatus for converting an alternating electrical current from a high to a low potential (voltage) or vice versa. Uses of transformers include but are not limited to the conversion of utility transmission voltage to the voltage of the premises wiring system and conversion of voltage for use with chimes, alarm systems and *low-voltage* lighting. Transformers can also be used to compensate for minor variations equipment voltage requirements. Transformers only change voltage and amperage.

**Volt:** the unit of electromotive force, the measure of electrical pressure, is abbreviated v or V, and voltage is represented by I. The voltage (of a circuit) is the effective (greatest root-mean-square) difference of potential between any two conductors of the circuit concerned. *Some systems, such as 3-phase 4-wire and single-phase 3-wire may have multiple circuits of differing voltages.* The **Nominal Voltage** is the value assigned to a circuit to conveniently designate its voltage class (e.g. 120 volts, 240 volts, 480 volts). The *actual* voltage of the circuit can vary.

**Watt:** the unit of power or rate of work represented by a current of one ampere under a pressure of one volt (abbreviated w or W). The English horsepower is approximately equal to 746 watts. Wattage ratings of lamps actually measure the power consumption not the illuminating capability.

### **Credits**

*Many of the definitions used are based on information contained in the National Electrical Code published by the National Fire Protection Association and Webster's New World Dictionary.*





## Electrical Motors Section Post Quiz

1. An AC motor has two parts: a stationary stator having coils supplied with alternating current to produce a \_\_\_\_\_, and a rotor attached to the output shaft that is given a torque by the rotating field.
2. A synchronous electric motor is an AC motor distinguished by a rotor spinning with coils passing magnets at the same rate as the alternating current and resulting \_\_\_\_\_ which drives it.
3. Slip rings and brushes are used to conduct current to the rotor. The rotor poles connect to each other and move at the same speed hence the name-\_\_\_\_\_.
4. Low-power synchronous timing motors (such as those for traditional electric clocks) may have multi-pole permanent-magnet external cup rotors, and use shading coils to provide starting\_\_\_\_\_.
5. \_\_\_\_\_ is an asynchronous AC motor where power is transferred to the rotor by electromagnetic induction, much like transformer action.
6. An induction motor resembles a \_\_\_\_\_, because the stator (stationary part) is essentially the primary side of the transformer and the rotor (rotating part) is the secondary side.
7. Induction motors may be further divided into \_\_\_\_\_ and wound-rotor motors.
8. Squirrel-cage motors have a heavy winding made up of solid bars, usually aluminum or copper, joined by rings at the \_\_\_\_\_. When one considers only the bars and rings as a whole, they are much like an animal's rotating exercise cage, hence the name.
9. Currents induced into this winding provide the rotor magnetic field. The shape of the rotor bars determines the \_\_\_\_\_ characteristics.
10. At low speeds, the current induced in the squirrel cage is nearly at line frequency and tends to be in the outer parts of \_\_\_\_\_.
11. As the motor accelerates, the slip frequency becomes lower, and more current is in the interior of the winding.  
A. True      B. False

12. In a wound-rotor motor, the rotor winding is made of many turns of insulated wire and is connected to slip rings on the motor shaft.  
A. True      B. False

13. An external resistor or other control devices can be connected in the rotor circuit. Resistors allow control of the motor speed, although significant power is dissipated in the external resistance.  
A. True      B. False

14. A transformer can be fed from the rotor circuit and return the slip-frequency power that would otherwise be wasted back into the power system through an inverter or separate motor-generator.  
A. True      B. False

15. \_\_\_\_\_ can be changed because the torque curve of the motor is effectively modified by the amount of resistance connected to the rotor circuit. Increasing the value of resistance will move the speed of maximum torque down.

16. \_\_\_\_\_ have two independent multiphase winding sets, which contribute active (i.e., working) power to the energy conversion process, with at least one of the winding sets electronically controlled for variable speed operation.

17. Two independent multiphase winding sets (i.e., dual armature) are the minimum provided in a single package without topology duplication.  
A. True      B. False

18. A torque motor (also known as a limited torque motor) is a specialized form of induction motor which is capable of operating indefinitely while stalled, that is, with the rotor blocked from turning, without incurring damage. In this mode of operation, the motor will apply a steady torque to the load (hence the name).  
A. True      B. False

**Answers:** 1. Rotating magnetic field, 2. Magnetic field, 3. Synchronous motor, 4. Torque, 5. An induction motor, 6. Rotating transformer, 7. Squirrel-cage motors, 8. Ends of the rotor, 9. Speed-torque 10. The rotor cage, 11. True, 12. True, 13. True, 14. False, 15. Motor speed, 16. Doubly fed electric motors, 17. False, 18. True

## Section 12 – SCADA Introduction

**Section Focus:** You will learn the basics of the SCADA (or supervisory control and data acquisition) system. The student will be able to describe the purpose of SCADA and the basic operation of SCADA systems. There is a post quiz at the end of this section to review your comprehension and a final examination in the Assignment for your contact hours.

**Scope/Background:** Industrial organizations and companies in the public and private sectors to control and maintain efficiency, distribute data for smarter decisions, and communicate system issues to help mitigate downtime use SCADA systems.

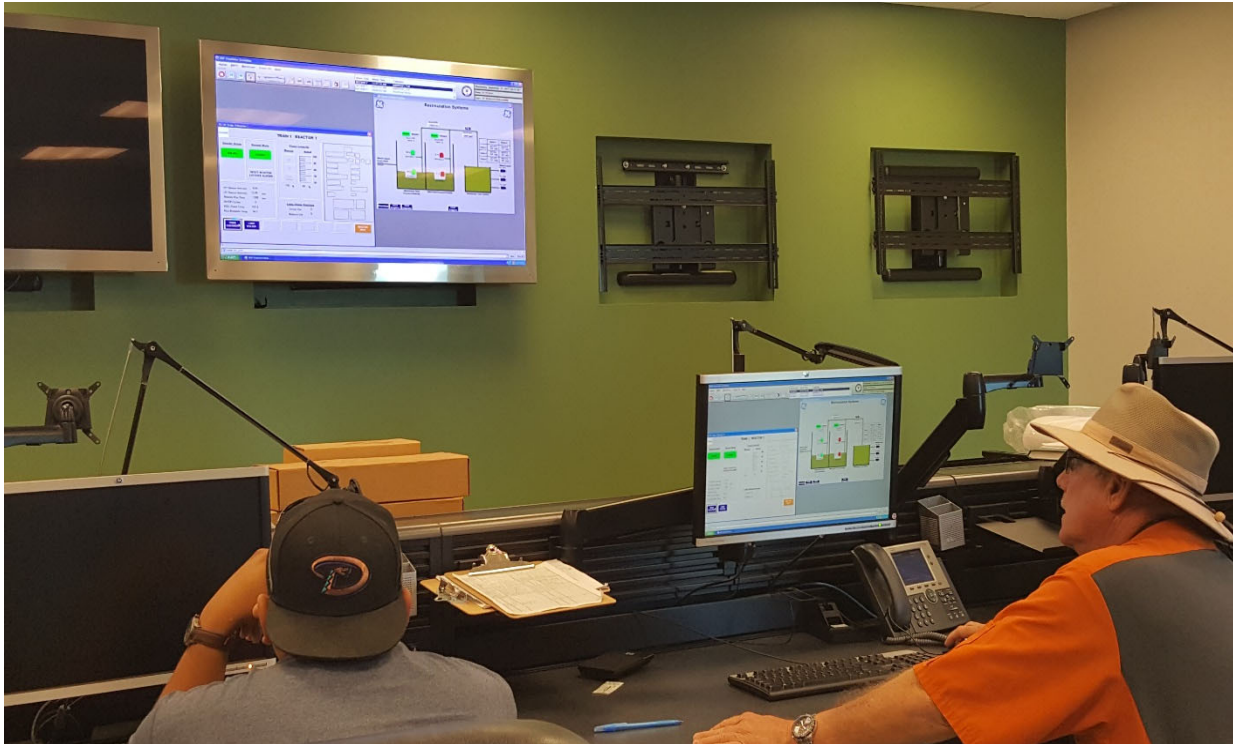

### What is SCADA and Who Uses It?

Supervisory control and data acquisition (SCADA) is a system of software and hardware elements that allows industrial organizations to:

- Control industrial processes locally or at remote locations
- Monitor, gather, and process real-time data
- Directly interact with devices such as sensors, valves, pumps, motors, and more through human-machine interface (HMI) software
- Record events into a log file

SCADA systems are crucial for industrial organizations since they help to maintain efficiency, process data for smarter decisions, and communicate system issues to help mitigate downtime.

The basic SCADA architecture begins with programmable logic controllers (PLCs) or remote terminal units (RTUs). PLCs and RTUs are microcomputers that communicate with an array of objects such as factory machines, HMIs, sensors, and end devices, and then route the information from those objects to computers with SCADA software. The SCADA software processes, distributes, and displays the data, helping operators and other employees analyze the data and make important decisions.

For example, the SCADA system quickly notifies an operator that a batch of product is showing a high incidence of errors. The operator pauses the operation and views the SCADA system data via an HMI to determine the cause of the issue. The operator reviews the data and discovers that Machine 4 was malfunctioning. The SCADA system's ability to notify the operator of an issue helps him to resolve it and prevent further loss of product.

SCADA systems are used by industrial organizations and companies in the public and private sectors to control and maintain efficiency, distribute data for smarter decisions, and communicate system issues to help mitigate downtime.

SCADA systems work well in many different types of enterprises because they can range from simple configurations to large, complex installations. SCADA systems are the backbone of many modern industries, including:

- Energy
- Food and beverage
- Manufacturing
- Oil and gas
- Power
- Recycling
- Transportation
- Water and wastewater
- And many more

Virtually anywhere you look in today's world, there is some type of SCADA system running behind the scenes: maintaining the refrigeration systems at the local supermarket, ensuring production and safety at a refinery, achieving quality standards at a waste water treatment plant, or even tracking your energy use at home, to give a few examples.

Effective SCADA systems can result in significant savings of time and money. Numerous case studies have been published highlighting the benefits and savings of using a modern SCADA software solution such as Ignition.

## SCADA Simply Explained



Supervisory control and data acquisition – SCADA refers to ICS (industrial control systems) used to control infrastructure processes (water treatment, wastewater treatment, gas pipelines, wind farms, etc.), facility-based processes (airports, space stations, ships, etc.), or industrial processes (production, manufacturing, refining, power generation, etc.).

Supervisory Control and Data Acquisition (SCADA) is a control system architecture that uses computers, networked data communications and graphical user interfaces for high-level process supervisory management, but uses other peripheral devices such as programmable logic controller (PLC) and discrete PID controllers to interface with the process plant or machinery. The use of SCADA has been also considered for management and operations of project-driven-process in construction.

### **The following subsystems are usually present in SCADA systems:**

- The apparatus used by a human operator; all the processed data are presented to the operator
- A supervisory system that gathers all the required data about the process
- Remote Terminal Units (RTUs) connected to the sensors of the process, which helps to convert the sensor signals to the digital data and send the data to supervisory stream.
- Programmable Logic Controller (PLCs) used as field devices
- Communication infrastructure connects the Remote Terminal Units to supervisory system.

Generally, a SCADA system does not control the processes in real time – it usually refers to the system that coordinates the processes in real time.

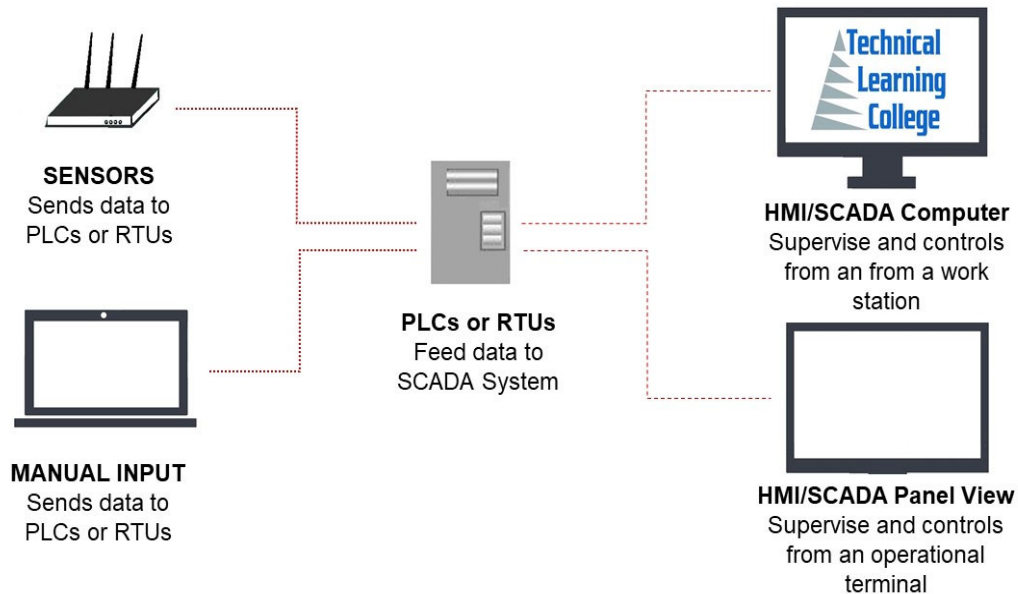

## BASIC SCADA DIAGRAM

### Remote Operation

SCADA is a real time control tool. It is not supposed to be a tool for detailed analysis of past performance but you the operator are able to research past performance to be able to react to current conditions. Thus, some form of trending is included with SCADA. The trending function is as close to analysis as most SCADA software get.

Let us say a water treatment operator wants to examine chemical usage in GAC filters and determine how each filter behaved over the past six weeks. In this case, SCADA is your tool of choice.

Some SCADA let you look at these three filters and compare their performance with some time period in the past.

## SCADA Systems Concepts

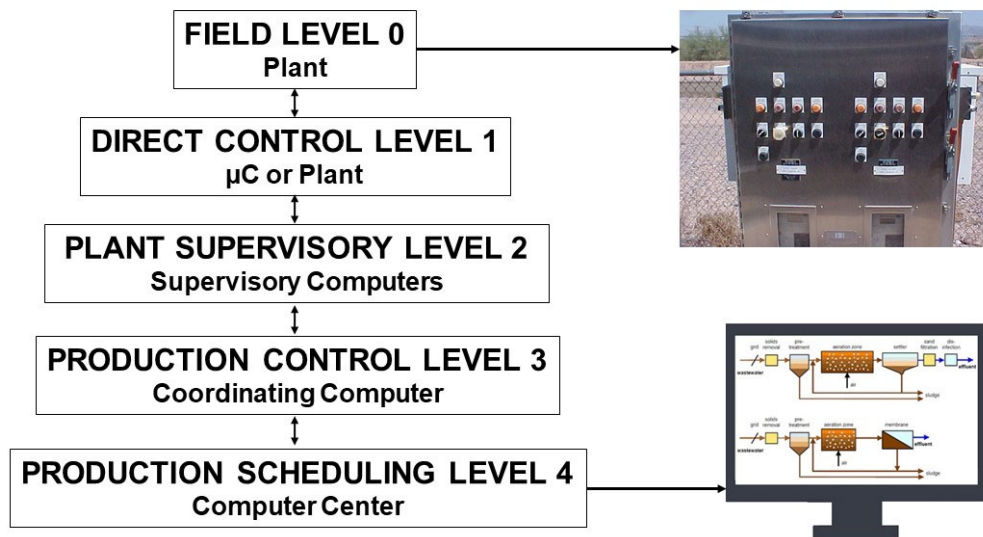

### FUNCTION LEVELS OF CONTROL OPERATION

SCADA refers to the centralized systems that control and monitor the entire sites, or they are the complex systems spread out over large areas. Nearly all the control actions are automatically performed by the remote terminal units (RTUs) or by the programmable logic controllers (PLCs). The restrictions to the host control functions are supervisory level intervention or basic overriding.

For example, the PLC (in an industrial process) controls the flow of cooling water, the SCADA system allows any changes related to the alarm conditions and set points for the flow (such as high temperature, loss of flow, etc.) to be recorded and displayed.

Data acquisition starts at the PLC or RTU level, which includes the equipment status reports, and meter readings. Data is then formatted in such way that the operator of the control room can make the supervisory decisions to override or adjust normal PLC (RTU) controls, by using the HMI.

SCADA systems mostly implement the distributed databases known as tag databases, containing data elements called points or tags. A point is a single output or input value controlled or monitored by the system. Points are either 'soft' or 'hard'.

The actual output or input of a system is represented by a hard point, whereas the soft point is a result of different math and logic operations applied to other points. These points are usually stored as timestamp-value pairs.

Series of the timestamp-value pairs gives history of the particular point. Storing additional metadata with the tags is common (these additional data can include comments on the design time, alarm information, path to the field device or the PLC register).

The key attribute of a SCADA system is its ability to perform a supervisory operation over a variety of other proprietary devices.

The accompanying diagram is a general model which shows functional manufacturing levels using computerised control.

SCADA systems typically use a tag database, which contains data elements called tags or points, which relate to specific instrumentation or actuators within the process system according to such as the Piping and instrumentation diagram.

Data is accumulated against these unique process control equipment tag references.

**Referring to the diagram,**

**Level 0** contains the field devices such as flow and temperature sensors, and final control elements, such as control valves.

**Level 1** contains the industrialised input/output (I/O) modules, and their associated distributed electronic processors.

**Level 2** contains the supervisory computers, which collate information from processor nodes on the system, and provide the operator control screens.

**Level 3** is the production control level, which does not directly control the process, but is concerned with monitoring production and targets.

**Level 4** is the production scheduling level.

Level 1 contains the programmable logic controllers (PLCs) or remote terminal units (RTUs).

Level 2 contains the SCADA software and computing platform. The SCADA software exists only at this supervisory level as control actions are performed automatically by RTUs or PLCs. SCADA control functions are usually restricted to basic overriding or supervisory level intervention.

For example, a PLC may control the flow of cooling water through part of an industrial process to a set point level, but the SCADA system software will allow operators to change the set points for the flow.

The SCADA also enables alarm conditions, such as loss of flow or high temperature, to be displayed and recorded. A feedback control loop is directly controlled by the RTU or PLC, but the SCADA software monitors the overall performance of the loop.

Levels 3 and 4 are not strictly process control in the traditional sense, but are where production control and scheduling takes place.

Data acquisition begins at the RTU or PLC level and includes instrumentation readings and equipment status reports that are communicated to level 2 SCADA as required.

Data is then compiled and formatted in such a way that a control room operator using the HMI (Human Machine Interface) can make supervisory decisions to adjust or override normal RTU (PLC) controls. Data may also be fed to a historian, often built on a commodity database management system, to allow trending and other analytical auditing.



## Considerations of SCADA System

Typical considerations when putting a SCADA system together are:

- Overall control requirements
- Sequence logic
- Analog loop control
- Ratio and number of analog to digital points
- Speed of control and data acquisition
- Master/operator control stations
- Type of displays required
- Historical archiving requirements
- System consideration
- Reliability/availability
- Speed of communications/update time/system scan rates
- System redundancy
- Expansion capability
- Application software and modeling

## Benefits of a SCADA System

Obviously, a SCADA system's initial cost has to be justified.

A few typical reasons for implementing a SCADA system are:

1. Improved operation of the plant or process resulting in savings due to optimization of the system
2. Increased productivity of the personnel
3. Improved safety of the system due to better information and improved control
4. Protection of the plant equipment
5. Safeguarding the environment from a failure of the system
6. Improved energy savings due to optimization of the plant
7. Improved and quicker receipt of data so that clients can be invoiced more quickly and accurately
8. Government regulations for safety and metering of gas (for royalties etc.)

## Human Machine Interface Introduction

The HMI, or Human Machine Interface, is an apparatus that gives the processed data to the human operator. A human operator uses HMI to control processes.

The HMI is linked to the SCADA system's databases, to provide the diagnostic data, management information and trending information such as logistic information, detailed schematics for a certain machine or sensor, maintenance procedures and troubleshooting guides.

The information provided by the HMI to the operating personnel is graphical, in the form of mimic diagrams. This means the schematic representation of the plant that is being controlled is available to the operator.

For example, a photograph of the pump that is connected to the pipe shows that this pump is running and it also shows the amount of fluid pumping through the pipe at the particular moment. The pump can then be switched off by the operator.

The software of the HMI shows the decrease in the flow rate of fluid in the pipe in the real time. Mimic diagrams either consist of digital photographs of process equipment with animated symbols, or schematic symbols and line graphics that represent various process elements.

HMI package of the SCADA systems consist of a drawing program used by the system maintenance personnel or operators to change the representation of these points in the interface.

These representations can be as simple as on-screen traffic light that represents the state of the actual traffic light in the area, or complex, like the multi-projector display that represents the position of all the trains on railway or elevators in skyscraper.

SCADA systems are commonly used in alarm systems. The alarm has only two digital status points with values ALARM or NORMAL.

When the requirements of the Alarm are met, the activation will start. For example, when the fuel tank of a car is empty, the alarm is activated and the light signal is on. To alert the SCADA operators and managers, text messages and emails are sent along with alarm activation.

## **Supervisory Station Introduction**

A 'supervisory Station' refers to the software and servers responsible for communication with the field equipment (PLCs, RTUs etc.), and after that, to HMI software running on the workstations in the control room, or somewhere else.

A master station can be composed of only one PC (in small SCADA systems). Master station can have multiple servers, disaster recovery sites and distributed software applications in larger SCADA systems. For increasing the system integrity, multiple servers are occasionally configured in hot standby or dual-redundant formation, providing monitoring and continuous control during server failures.

## **SCADA Hardware**

SCADA system may have the components of the Distributed Control System. Execution of easy logic processes without involving the master computer is possible because 'smart' PLCs or RTUs. IEC61131-3(Ladder Logic) is used, (this is a functional block programming language, commonly used in creating programs running on PLCs and RTUs.) IEC 61131-3 has very few training requirements, unlike procedural languages like FORTRAN and C programming language.

The SCADA system engineers can perform implementation and design of programs being executed on PLC or RTU. The compact controller, Programmable automation controller (PAC), combines the capabilities and features of a PC-based control system with a typical PLC.

'Distributed RTUs', in various electrical substation SCADA applications, use station computers or information processors for communicating with PACs, protective relays, and other I/O devices. Almost all big PLC manufacturers offer integrated HMI/SCADA systems, since 1998. Many of them are using non-proprietary and open communication protocols.

Many skilled third party HMI/SCADA packages have stepped into the market, offering in-built compatibility with several major PLCs, which allows electrical engineers, mechanical engineers or technicians to configure HMIs on their own, without requiring software-developer-written custom-made program.

## **Remote Terminal Unit (RTU)**

The RTU is connected to the physical equipment. Often, the RTU converts all electrical signals coming from the equipment into digital values like the status- open/closed – from a valve or switch, or the measurements like flow, pressure, current or voltage. By converting and sending the electrical signals to the equipment, RTU may control the equipment, like closing or opening a valve or a switch, or setting the speed of the pump.

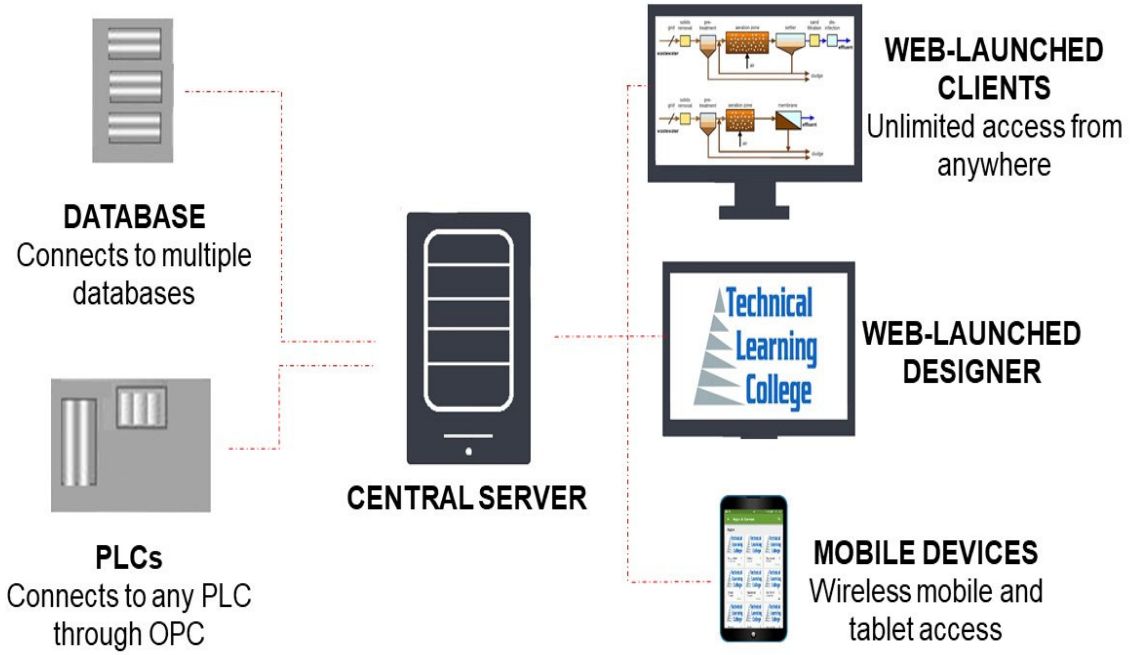

## MODERN SCADA DIAGRAM

## SCADA Operational Philosophy

The costs resulting from control system failures are very high. Even lives may be lost. For a few SCADA systems, hardware is ruggedized, to withstand temperature, voltage and vibration extremes, and reliability is increased, in many critical installations, by including communications channels and redundant hardware. A part which is failing can be identified and the functionality taken over automatically through backup hardware. It can be replaced without any interruption of the process.

### Communication Methods and Infrastructure

SCADA systems initially used modem connections or combinations of direct and radio serial to meet communication requirements, even though IP and Ethernet over SONET/SDH can also be used at larger sites like power stations and railways. The monitoring function or remote management of the SCADA system is called telemetry.

SCADA protocols have been designed to be extremely compact and to send information to the master station only when the RTU is polled by the master station. Typically, the legacy of SCADA protocols consists of Conitel, Profibus, Modbus RTU and RP-570. These protocols of communication are specifically SCADA-vendor. Standard protocols are IEC 61850, DNP3 and IEC 60870-5-101 or 104. These protocols are recognized and standardized by all big SCADA vendors. Several of these protocols have extensions for operating through the TCP/IP.

The development of many automatic controller devices and RTUs had started before the advent of industry standards for the interoperability.

For better communication between different software and hardware, PLE for Process Control is a widely accepted solution that allows communication between the devices that originally weren't intended to be part of the industrial network.

### Alarm Management Introduction

An important part of most SCADA implementations is alarm handling. The system monitors whether certain alarm conditions are satisfied, to determine when an alarm event has occurred. Once an alarm event has been detected, one or more actions are taken (such as the activation of one or more alarm indicators, and perhaps the generation of email or text messages so that management or remote SCADA operators are informed).

In many cases, a SCADA operator may have to acknowledge the alarm event; this may deactivate some alarm indicators, whereas other indicators remain active until the alarm conditions are cleared.

Alarm conditions can be explicit—for example, an alarm point is a digital status point that has either the value NORMAL or ALARM that is calculated by a formula based on the values in other analogue and digital points—or implicit: the SCADA system might automatically monitor whether the value in an analogue point lies outside high and low- limit values associated with that point.

Examples of alarm indicators include a siren, a pop-up box on a screen, or a colored or flashing area on a screen (that might act in a similar way to the "fuel tank empty" light in a car); in each case, the role of the alarm indicator is to draw the operator's attention to the part of the system 'in alarm' so that appropriate action can be taken.

### **PLC/RTU Programming**

"Smart" RTUs, or standard PLCs, are capable of autonomously executing simple logic processes without involving the supervisory computer. They employ standardized control programming languages such as under, IEC 61131-3 (a suite of 5 programming languages including function block, ladder, structured text, sequence function charts and instruction list), is frequently used to create programs which run on these RTUs and PLCs.

Unlike a procedural language such as the C programming language or FORTRAN, IEC 61131-3 has minimal training requirements by virtue of resembling historic physical control arrays. This allows SCADA system engineers to perform both the design and implementation of a program to be executed on an RTU or PLC.

A programmable automation controller (PAC) is a compact controller that combines the features and capabilities of a PC-based control system with that of a typical PLC. PACs are deployed in SCADA systems to provide RTU and PLC functions.

In many electrical substation SCADA applications, "distributed RTUs" use information processors or station computers to communicate with digital protective relays, PACs, and other devices for I/O, and communicate with the SCADA master in lieu of a traditional RTU.

### **PLC Commercial Integration**

Since about 1998, virtually all major PLC manufacturers have offered integrated HMI/SCADA systems, many of them using open and non-proprietary communications protocols.

Numerous specialized third-party HMI/SCADA packages, offering built-in compatibility with most major PLCs, have also entered the market, allowing mechanical engineers, electrical engineers and technicians to configure HMIs themselves, without the need for a custom-made program written by a software programmer.

The Remote Terminal Unit (RTU) connects to physical equipment. Typically, an RTU converts the electrical signals from the equipment to digital values such as the open/closed status from a switch or a valve, or measurements such as pressure, flow, voltage or current. By converting and sending these electrical signals out to equipment the RTU can control equipment, such as opening or closing a switch or a valve, or setting the speed of a pump.

# SCADA Architectures

## Monolithic: The First Generation

In the first generation, mainframe systems were used for computing. At the time SCADA was developed, networks did not exist. Therefore, the SCADA systems did not have any connectivity to other systems, meaning they were independent systems. Later on, RTU vendors designed the Wide Area Networks that helped in communication with RTU. The usage of communication protocols at that time was proprietary. If the mainframe system failed, there was a back-up mainframe, connected at the bus level.

## Distributed: The Second Generation

The information between multiple stations was shared in real time through LAN and the processing was distributed between various multiple stations. The cost and size of the stations were reduced in comparison to the ones used in the first generation. The protocols used for the networks were still proprietary, which caused many security issues for SCADA systems. Due to the proprietary nature of the protocols, very few people actually knew how secure the SCADA installation was.

## Networked: The Third Generation

The SCADA system used today belong to this generation. The communication between the system and the master station is done through the WAN protocols like the Internet Protocols (IP). Since the standard protocols used and the networked SCADA systems can be accessed through the internet, the vulnerability of the system is increased. However, the usage of security techniques and standard protocols means that security improvements can be applied in SCADA systems.

## The Evolution of SCADA

The first iteration of SCADA started off with mainframe computers. Networks as we know them today were not available and each SCADA system stood on its own. These systems were what would now be referred to as monolithic SCADA systems.

In the 80s and 90s, SCADA continued to evolve thanks to smaller computer systems, Local Area Networking (LAN) technology, and PC-based HMI software. SCADA systems soon were able to be connected to other similar systems. Many of the LAN protocols used in these systems were proprietary, which gave vendors control of how to optimize data transfer. Unfortunately, these systems were incapable of communicating with systems from other vendors. These systems were called distributed SCADA systems.

In the 1990s and early 2000s, building upon the distributed system model, SCADA adopted an incremental change by embracing an open system architecture and communications protocols that were not vendor-specific. This iteration of SCADA, called a networked SCADA system, took advantage of communications technologies such as Ethernet. Networked SCADA systems allowed systems from other vendors to communicate with each other, alleviating the limitations imposed by older SCADA systems, and allowed organizations to connect more devices to the network.

While SCADA systems have undergone substantial evolutionary changes, many industrial organizations continued to struggle with industrial data access from the enterprise level.

By the late 1990s to the early 2000s, a technological boom occurred and personal computing and IT technologies accelerated in development. Structured query language (SQL) databases

became the standard for IT databases but were not adopted by SCADA developers. This resulted in a rift between the fields of controls and IT, and SCADA technology became antiquated over time.

Traditional SCADA systems still use proprietary technology to handle data. Whether it is a data historian, a data connector, or other means of data transfer, the solution is messy and incredibly expensive. Modern SCADA systems aim to solve this problem by leveraging the best of controls and IT technology.

### **Communication Infrastructure and Methods**

SCADA systems have traditionally used combinations of radio and direct wired connections, although SONET/SDH is also frequently used for large systems such as railways and power stations. The remote management or monitoring function of a SCADA system is often referred to as telemetry. Some users want SCADA data to travel over their pre-established corporate networks or to share the network with other applications. The legacy of the early low-bandwidth protocols remains, though.

SCADA protocols are designed to be very compact. Many are designed to send information only when the master station polls the RTU. Typical legacy SCADA protocols include Modbus RTU, RP-570, Profibus and Conitel. These communication protocols, with the exception of Modbus (Modbus has been made open by Schneider Electric), are all SCADA-vendor specific but are widely adopted and used. Standard protocols are IEC 60870-5-101 or 104, IEC 61850 and DNP3. These communication protocols are standardized and recognized by all major SCADA vendors. Many of these protocols now contain extensions to operate over TCP/IP. Although the use of conventional networking specifications, such as TCP/IP, blurs the line between traditional and industrial networking, they each fulfill fundamentally differing requirements. Network simulation can be used in conjunction with SCADA simulators to perform various 'what-if' analyses.

With increasing security demands (such as North American Electric Reliability Corporation (NERC) and critical infrastructure protection (CIP) in the US), there is increasing use of satellite-based communication. This has the key advantages that the infrastructure can be self-contained (not using circuits from the public telephone system), can have built-in encryption, and can be engineered to the availability and reliability required by the SCADA system operator. Earlier experiences using consumer-grade VSAT were poor. Modern carrier-class systems provide the quality of service required for SCADA.

RTUs and other automatic controller devices were developed before the advent of industry wide standards for interoperability. The result is that developers and their management created a multitude of control protocols. Among the larger vendors, there was also the incentive to create their own protocol to "lock in" their customer base. A list of automation protocols is compiled here.

OLE for process control (OPC) can connect different hardware and software, allowing communication even between devices originally not intended to be part of an industrial network. Standardisation in the field of mySCADA protocols resulted into the vendor independent protocol called OPC UA (Unified Architecture). OPC UA is starting to be widely adopted among multiple SCADA vendors.



## **SCADA Trends**

In the late 1990s instead of using the RS-485, manufacturers used open message structures like Modbus ASCII and Modbus RTU (both developed by Modicon). By 2000, almost all I/O makers offered fully open interfacing like Modbus TCP instead of the IP and Ethernet.

SCADA systems are now in line with the standard networking technologies. The old proprietary standards are being replaced by the TCP/IP and Ethernet protocols. However, due to certain characteristics of frame-based network communication technology, Ethernet networks have been accepted by the majority of markets for HMI SCADA.

The 'Next Generation' protocols using XML web services and other modern web technologies, make themselves more IT supportable. A few examples of these protocols include Wonderware's SuiteLink, GE Fanuc's Proficy, I Gear's Data Transport Utility, Rockwell Automation's FactoryTalk and OPC-UA.

Some vendors have started offering application-specific SCADA systems that are hosted on remote platforms all over the Internet. Hence, there is no need to install systems at the user-end facility. Major concerns are related to the Internet connection reliability, security and latency. The SCADA systems are becoming omnipresent day by day. However, there are still some security issues.

## **SCADA Security Issues**

Security of SCADA-based systems is being questioned, as they are potential targets to cyberterrorism/cyberwarfare attacks.

There is an erroneous belief that SCADA networks are safe enough because they are secured physically. It is also wrongly believed that SCADA networks are safe enough because they are disconnected from the Internet.

SCADA systems also are used for monitoring and controlling physical processes, like distribution of water, traffic lights, electricity transmissions, gas transportation and oil pipelines and other systems used in the modern society. Security is extremely important because destruction of the systems would have very bad consequences.

There are two major threats. The first one is unauthorized access to software, be it human access or intentionally induced changes, virus infections or other problems that can affect the control host machine. The second threat is related to the packet access to network segments that host SCADA devices. In numerous cases, there remains less or no security on actual packet control protocol; therefore, any person sending packets to SCADA device is in position to control it. Often, SCADA users infer that VPN is sufficient protection, and remain oblivious to the fact that physical access to network switches and jacks related to SCADA provides the capacity to bypass the security on control software and control SCADA networks.

SCADA vendors are addressing these risks by developing specialized industrial VPN and firewall solutions for SCADA networks that are based on TCP/IP. In addition, white-listing solutions have been implemented due to their ability to prevent unauthorized application changes.

SCADA systems that tie together decentralized facilities such as power, oil, gas pipelines, water distribution and wastewater collection systems were designed to be open, robust, and easily operated and repaired, but not necessarily secure.

The move from proprietary technologies to more standardized and open solutions together with the increased number of connections between SCADA systems, office networks and the Internet has made them more vulnerable to types of network attacks that are relatively common in computer security. For example, United States Computer Emergency Readiness Team (US-CERT) released a vulnerability advisory warning that unauthenticated users could download sensitive configuration information including password hashes from an Inductive Automation Ignition system utilizing a standard attack type leveraging access to the Tomcat Embedded Web server. Security researcher Jerry Brown submitted a similar advisory regarding a buffer overflow vulnerability in a Wonderware InBatchClient ActiveX control. Both vendors made updates available prior to public vulnerability release. Mitigation recommendations were standard patching practices and requiring VPN access for secure connectivity. Consequently, the security of some SCADA-based systems has come into question as they are seen as potentially vulnerable to cyber attacks.

**In particular, security researchers are concerned about**

- the lack of concern about security and authentication in the design, deployment and operation of some existing SCADA networks
- the belief that SCADA systems have the benefit of security through obscurity through the use of specialized protocols and proprietary interfaces
- the belief that SCADA networks are secure because they are physically secured
- the belief that SCADA networks are secure because they are disconnected from the Internet

SCADA systems are used to control and monitor physical processes, examples of which are transmission of electricity, transportation of gas and oil in pipelines, water distribution, traffic lights, and other systems used as the basis of modern society. The security of these SCADA systems is important because compromise or destruction of these systems would impact multiple areas of society far removed from the original compromise. For example, a blackout caused by a compromised electrical SCADA system would cause financial losses to all the customers that received electricity from that source. How security will affect legacy SCADA and new deployments remains to be seen.

There are many threat vectors to a modern SCADA system. One is the threat of unauthorized access to the control software, whether it is human access or changes induced intentionally or accidentally by virus infections and other software threats residing on the control host machine. Another is the threat of packet access to the network segments hosting SCADA devices. In many cases, the control protocol lacks any form of cryptographic security, allowing an attacker to control a SCADA device by sending commands over a network.

In many cases, SCADA users have assumed that having a VPN offered sufficient protection, unaware that security can be trivially bypassed with physical access to SCADA-related network jacks and switches. Industrial control vendors suggest approaching SCADA security like Information Security with a defense in depth strategy that leverages common IT practices

The reliable function of SCADA systems in our modern infrastructure may be crucial to public health and safety. As such, attacks on these systems may directly or indirectly threaten public health and safety. Such an attack has already occurred, carried out on Maroochy Shire Council's sewage control system in Queensland, Australia. Shortly after a contractor installed a SCADA

system in January 2000, system components began to function erratically. Pumps did not run when needed and alarms were not reported.

More critically, sewage flooded a nearby park and contaminated an open surface-water drainage ditch and flowed 500 meters to a tidal canal. The SCADA system was directing sewage valves to open when the design protocol should have kept them closed. Initially this was believed to be a system bug.

Monitoring of the system logs revealed the malfunctions were the result of cyber attacks. Investigators reported 46 separate instances of malicious outside interference before the culprit was identified. The attacks were made by a disgruntled ex-employee of the company that had installed the SCADA system. The ex-employee was hoping to be hired by the utility full-time to maintain the system.

In April 2008, the Commission to Assess the Threat to the United States from Electromagnetic Pulse (EMP) Attack issued a Critical Infrastructures Report which discussed the extreme vulnerability of SCADA systems to an electromagnetic pulse (EMP) event. After testing and analysis, the Commission concluded: "SCADA systems are vulnerable to an EMP event.

The large numbers and widespread reliance on such systems by all of the Nation's critical infrastructures represent a systemic threat to their continued operation following an EMP event. Additionally, the necessity to reboot, repair, or replace large numbers of geographically widely dispersed systems will considerably impede the Nation's recovery from such an assault."

## **Summary**

### **SCADA System**

A SCADA (or supervisory control and data acquisition) system means a system consisting of a number of remote terminal units (or RTUs) collecting field data connected back to a master station via a communications system.

The master station displays the acquired data and allows the operator to perform remote control tasks.

The accurate and timely data (normally real-time) allows for optimization of the operation of the plant and process. A further benefit is more efficient, reliable and most importantly, safer operations. This all results in a lower cost of operation compared to earlier non-automated systems.

There is a fair degree of confusion between the definition of SCADA systems and process control system. SCADA has the connotation of remote or distant operation.

## SCADA References

- Antunes, Ricardo; Poshdar, Mani (2018). "Envision of an integrated information system for project-driven production in construction". Proc. 26th Annual Conference of the International Group for Lean Construction (IGLC): 134–143. doi:10.24928/2018/0511. Retrieved 27 December 2018.
- Boys, Walt (18 August 2009). "Back to Basics: SCADA". Automation TV: Control Global - Control Design.
- "Cyberthreats, Vulnerabilities and Attacks on SCADA Networks" (PDF). Rosa Tang, berkeley.edu. Archived from the original (PDF) on 13 August 2012. Retrieved 1 August 2012.
- Boyer, Stuart A. (2010). SCADA Supervisory Control and Data Acquisition. USA: ISA - International Society of Automation. p. 179. ISBN 978-1-936007-09-7.
- Jeff Hieb (2008). Security Hardened Remote Terminal Units for SCADA Networks. University of Louisville.
- Aquino-Santos, Raul (30 November 2010). Emerging Technologies in Wireless Ad-hoc Networks: Applications and Future Development: Applications and Future Development. IGI Global. pp. 43–. ISBN 978-1-60960-029-7.
- "Introduction to Industrial Control Networks" (PDF). IEEE Communications Surveys and Tutorials. 2012.
- Bergan, Christian (August 2011). "Demystifying Satellite for the Smart Grid: Four Common Misconceptions". Electric Light & Powers. Utility Automation & Engineering T&D. Tulsa, OK: PennWell. 16 (8). Four. Retrieved 2 May 2012. satellite is a cost-effective and secure solution that can provide backup communications and easily support core smart grid applications like SCADA, telemetry, AMI backhaul and distribution automation
- OFFICE OF THE MANAGER NATIONAL COMMUNICATIONS SYSTEM October 2004.
- "Supervisory Control and Data Acquisition (SCADA) Systems" (PDF). NATIONAL COMMUNICATIONS SYSTEM.
- J. Russel. "A Brief History of SCADA/EMS (2015)". Archived from the original on 11 August 2015.
- Security Hardened Remote Terminal Units for SCADA Networks. ProQuest. 2008. pp. 12–. ISBN 978-0-549-54831-7.
- "SCADA as a service approach for interoperability of micro-grid platforms". Sustainable Energy, Grids and Network. 2016. doi:10.1016/j.segan.2016.08.001.
- "SCADA as a service approach for interoperability of micro-grid platforms", Sustainable Energy, Grids and Network, 2016, doi:10.1016/j.segan.2016.08.001
- "ICSA-11-231-01—INDUCTIVE AUTOMATION IGNITION INFORMATION DISCLOSURE VULNERABILITY" (PDF). 19 Aug 2011. Retrieved 21 Jan 2013.
- "ICSA-11-094-01—WONDERWARE INBATCH CLIENT ACTIVEX BUFFER OVERFLOW" (PDF). 13 Apr 2011. Retrieved 26 Mar 2013.
- D. Maynor and R. Graham (2006). "SCADA Security and Terrorism: We're Not Crying Wolf" (PDF).
- Robert Lemos (26 July 2006). "SCADA system makers pushed toward security". Security Focus. Retrieved 9 May 2007.
- "Industrial Security Best Practices" (PDF). Rockwell Automation. Retrieved 26 Mar 2013.
- Slay, J.; Miller, M. (November 2007). "Chpt 6: Lessons Learned from the Maroochy Water Breach". Critical infrastructure protection (Online-Ausg. ed.). Springer Boston. pp. 73–82. ISBN 978-0-387-75461-1. Retrieved 2 May 2012.
- [http://www.empcommission.org/docs/A2473-EMP\\_Commission-7MB.pdf](http://www.empcommission.org/docs/A2473-EMP_Commission-7MB.pdf)
- "Security for all". InTech. June 2008. Retrieved 2 May 2012.

## SCADA Post Quiz

### SCADA Acronyms and Abbreviations

Identify the following terms

1. FTP

2. HMI

3. ICS

4. LAN

### True or False

5. A "historian", is a software service within the HMI which accumulates time-stamped data, events, and alarms in a database which can be queried or used to populate graphic trends in the HMI. True or False

6. The historian is a client that controls PLCs from a data acquisition server.  
True or False

7. PLCs are often used in place of RTUs as field devices because they are more economical, versatile, flexible and configurable. True or False

8. SCADA systems are crucial for industrial organizations since they help to maintain efficiency, process data for smarter decisions, and communicate system issues to help mitigate downtime. True or False

### Fill-in-the Blank

9. The basic SCADA \_\_\_\_\_ begins with programmable logic controllers (PLCs) or remote terminal units (RTUs). PLCs and RTUs are microcomputers that communicate with an array of objects such as factory machines, HMIs, sensors, and end devices, and then route the information from those objects to computers with SCADA software.

10. What missing term starts at the PLC or RTU level, which includes the equipment status reports, and meter readings?
11. SCADA systems are commonly used in alarm systems. The alarm has only two digital status points with values\_\_\_\_\_.
12. To alert the SCADA operators and managers, text messages and emails are sent along with\_\_\_\_\_.
13. By converting and sending the electrical signals to the equipment, \_\_\_\_\_ may control the equipment, like closing or opening a valve or a switch, or setting the speed of the pump.
14. For increasing the system integrity, multiple servers are occasionally configured in\_\_\_\_\_, providing monitoring and continuous control during server failures.
15. "Smart" RTUs, or standard PLCs, are capable of autonomously executing simple logic processes without involving the\_\_\_\_\_.

**Answers** – 1. File Transfer Protocol, 2. Human-Machine Interface, 3. Industrial Control System, 4. Local Area Network, 5. True, 6. False, 7. True, 8. True, 9. Architecture, 10. Data acquisition, 11. ALARM or NORMAL, 12. Alarm activation, 13. RTU, 14. Hot standby or dual-redundant formation, 15. Supervisory computer

# Math Conversion Factors

1 PSI = 2.31 Feet of Water  
 1 Foot of Water = .433 PSI  
 1.13 Feet of Water = 1 Inch of Mercury  
 454 Grams = 1 Pound  
 2.54 CM = Inch  
 1 Gallon of Water = 8.34 Pounds  
 1 mg/L = 1 PPM  
 17.1 mg/L = 1 Grain/Gallon  
 1% = 10,000 mg/L  
 694 Gallons per Minute = MGD  
 1.55 Cubic Feet per Second = 1 MGD  
 60 Seconds = 1 Minute  
 1440 Minutes = 1 Day  
 .746 kW = 1 Horsepower

## LENGTH

12 Inches = 1 Foot  
 3 Feet = 1 Yard  
 5,280 Feet = 1 Mile

## AREA

144 Square Inches = 1 Square Foot  
 43,560 Square Feet = 1 Acre

## VOLUME

1000 Milliliters = 1 Liter  
 3.785 Liters = 1 Gallon  
 231 Cubic Inches = 1 Gallon  
 7.48 Gallons = 1 Cubic Foot of Water  
 62.38 Pounds = 1 Cubic Foot of Water

## Dimensions

**SQUARE:** Area (sq. ft) = Length X Width  
 Volume (cu.ft.) = Length (ft) X Width (ft) X Height (ft)

**CIRCLE:** Area (sq.ft.) = 3.14 X Radius (ft) X Radius (ft)

**CYLINDER:** Volume (Cu. ft) = 3.14 X Radius (ft) X Radius (ft) X Depth (ft)

**PIPE VOLUME:** .785 X Diameter <sup>2</sup> X Length = ? To obtain gallons multiply by 7.48

**SPHERE:**  $\frac{(3.14) (\text{Diameter})^3}{(6)}$  Circumference = 3.14 X Diameter

## General Conversions

Multiply	→	to get
to get	←	Divide
cc/min	1	mL/min
cfm (ft <sup>3</sup> /min)	28.31	L/min
cfm (ft <sup>3</sup> /min)	1.699	m <sup>3</sup> /hr
cfh (ft <sup>3</sup> /hr)	472	mL/min
cfh (ft <sup>3</sup> /hr)	0.125	GPM
GPH	63.1	mL/min
GPH	0.134	cfh
GPM	0.227	m <sup>3</sup> /hr
GPM	3.785	L/min
oz/min	29.57	mL/min

**POUNDS PER DAY** = Flow (MG) X Concentration (mg/L) X 8.34  
**AKA Solids Applied Formula** = Flow X Dose X 8.34

$$\text{PERCENT EFFICIENCY} = \frac{\text{In} - \text{Out}}{\text{In}} \times 100$$

$$\begin{aligned} \text{TEMPERATURE: } & \text{ } ^\circ\text{F} = (^\circ\text{C} \times 9/5) + 32 & 9/5 = 1.8 \\ & \text{ } ^\circ\text{C} = (^\circ\text{F} - 32) \times 5/9 & 5/9 = .555 \end{aligned}$$

$$\text{CONCENTRATION: Conc. (A) X Volume (A) = Conc. (B) X Volume (B)}$$

$$\text{FLOW RATE (Q): } Q = A \times V \text{ (Quantity = Area X Velocity)}$$

$$\text{FLOW RATE (gpm): Flow Rate (gpm) = } \frac{2.83 (\text{Diameter, in})^2 (\text{Distance, in})}{\text{Height, in}}$$

$$\% \text{ SLOPE} = \frac{\text{Rise (feet)}}{\text{Run (feet)}} \times 100$$

$$\text{ACTUAL LEAKAGE} = \frac{\text{Leak Rate (GPD)}}{\text{Length (mi.) X Diameter (in)}}$$

$$\text{VELOCITY} = \frac{\text{Distance (ft)}}{\text{Time (Sec)}}$$

**N** = Manning's Coefficient of Roughness

**R** = Hydraulic Radius (ft.)

**S** = Slope of Sewer (ft/ft.)

$$\text{HYDRAULIC RADIUS (ft)} = \frac{\text{Cross Sectional Area of Flow (ft)}}{\text{Wetted pipe Perimeter (ft)}}$$

$$\text{WATER HORSEPOWER} = \frac{\text{Flow (gpm) X Head (ft)}}{3960}$$

$$\text{BRAKE HORSEPOWER} = \frac{\text{Flow (gpm) X Head (ft)}}{3960 \times \text{Pump Efficiency}}$$

$$\text{MOTOR HORSEPOWER} = \frac{\text{Flow (gpm) X Head (ft)}}{3960 \times \text{Pump Eff.} \times \text{Motor Eff.}}$$

$$\text{MEAN OR AVERAGE} = \frac{\text{Sum of the Values}}{\text{Number of Values}}$$

$$\text{TOTAL HEAD (ft)} = \text{Suction Lift (ft)} \times \text{Discharge Head (ft)}$$

$$\text{SURFACE LOADING RATE} = \frac{\text{Flow Rate (gpm)}}{\text{Surface Area (sq. ft.)}}$$

$$\text{MIXTURE STRENGTH (\%)} = \frac{(\text{Volume 1, gal}) (\text{Strength 1, \%}) + (\text{Volume 2, gal}) (\text{Strength 2, \%})}{(\text{Volume 1, gal}) + (\text{Volume 2, gal})}$$

$$\text{DETENTION TIME (hrs.)} = \frac{\text{Volume of Basin (gals) X 24 hrs.}}{\text{Flow (GPD)}}$$



$$\text{SLOPE} = \frac{\text{Rise (ft)}}{\text{Run (ft)}}$$

$$\text{SLOPE (\%)} = \frac{\text{Rise (ft)} \times 100}{\text{Run (ft)}}$$

**POPULATION EQUIVALENT (PE):**

- 1 PE = .17 Pounds of BOD per Day
- 1 PE = .20 Pounds of Solids per Day
- 1 PE = 100 Gallons per Day

$$\text{LEAKAGE (GPD/inch)} = \frac{\text{Leakage of Water per Day (GPD)}}{\text{Sewer Diameter (inch)}}$$

$$\text{CHLORINE DEMAND (mg/L)} = \text{Chlorine Dose (mg/L)} - \text{Chlorine Residual (mg/L)}$$

**MANNING'S EQUATION**

$\tau Q$  = Allowable time for decrease in pressure from 3.5 PSU to 2.5 PSI

$\tau q$  = As below

$$\tau Q = (0.022) (d_1^2 L_1) / Q \quad \tau q = \frac{[0.085] [(d_1^2 L_1)]}{q}$$

Q = 2.0 cfm air loss

$\theta$  = .0030 cfm air loss per square foot of internal pipe surface

$\delta$  = Pipe diameter (inches)

L = Pipe Length (feet)

$$V = \frac{1.486 R^{2/3} S^{1/2}}{v}$$

V = Velocity (ft./sec.)

v = Pipe Roughness

R = Hydraulic Radius (ft)

S = Slope (ft/ft)

$$\text{HYDRAULIC RADIUS (ft)} = \frac{\text{Flow Area (ft. }^2\text{)}}{\text{Wetted Perimeter (ft.)}}$$

$$\text{WIDTH OF TRENCH (ft)} = \text{Base (ft)} + (2 \text{ Sides}) \times \frac{\text{Depth (ft }^2\text{)}}{\text{Slope}}$$



## Water Formula/Conversion Table

$$\text{Acid Feed Rate} = \frac{(\text{Waste Flow}) (\text{Waste Normality})}{\text{Acid Normality}}$$

$$\text{Alkalinity} = \frac{(\text{mL of Titrant}) (\text{Acid Normality}) (50,000)}{\text{mL of Sample}}$$

$$\text{Amperage} = \text{Voltage} \div \text{Ohms}$$

$$\text{Area of Circle} = (0.785)(\text{Diameter}^2) \text{ OR } (\pi)(\text{Radius}^2)$$

$$\text{Area of Rectangle} = (\text{Length})(\text{Width})$$

$$\text{Area of Triangle} = \frac{(\text{Base}) (\text{Height})}{2}$$

$$\text{C Factor Slope} = \text{Energy loss, ft.} \div \text{Distance, ft.}$$

$$\text{C Factor Calculation} = \text{Flow, GPM} \div [193.75 (\text{Diameter, ft.})^{2.63} (\text{Slope})^{0.54}]$$

$$\text{Chemical Feed Pump Setting, \% Stroke} = \frac{(\text{Desired Flow}) (100\%)}{\text{Maximum Flow}}$$

$$\text{Chemical Feed Pump Setting, mL/min} = \frac{(\text{Flow, MGD}) (\text{Dose, mg/L}) (3.785\text{L/gal}) (1,000,000 \text{ gal/MG})}{(\text{Liquid, mg/mL}) (24 \text{ hr / day}) (60 \text{ min/hr})}$$

$$\text{Chlorine Demand (mg/L)} = \text{Chlorine dose (mg/L)} - \text{Chlorine residual (mg/L)}$$

$$\text{Circumference of Circle} = (3.141)(\text{Diameter})$$

$$\text{Composite Sample Single Portion} = \frac{(\text{Instantaneous Flow}) (\text{Total Sample Volume})}{(\text{Number of Portions}) (\text{Average Flow})}$$

$$\text{Detention Time} = \frac{\text{Volume}}{\text{Flow}}$$

$$\text{Digested Sludge Remaining, \%} = \frac{(\text{Raw Dry Solids}) (\text{Ash Solids}) (100\%)}{(\text{Digested Dry Solids}) (\text{Digested Ash Solids})}$$

$$\text{Discharge} = \frac{\text{Volume}}{\text{Time}}$$

$$\text{Dosage, lbs/day} = (\text{mg/L})(8.34)(\text{MGD})$$

$$\text{Dry Polymer (lbs.)} = (\text{gal. of solution})(8.34 \text{ lbs/gal})(\% \text{ polymer solution})$$

$$\text{Efficiency, \%} = \frac{(\text{In} - \text{Out}) (100\%)}{\text{In}}$$

$$\text{Feed rate, lbs/day} = \frac{(\text{Dosage, mg/L}) (\text{Capacity, MGD}) (8.34 \text{ lbs/gals})}{(\text{Available fluoride ion}) (\text{Purity})}$$

$$\text{Feed rate, gal/min (Saturator)} = \frac{(\text{Plant capacity, gal/min.}) (\text{Dosage, mg /L})}{18,000 \text{ mg/L}}$$

$$\text{Filter Backwash Rate} = \frac{\text{Flow}}{\text{Filter Area}}$$

$$\text{Filter Yield, lbs/hr/sq. ft} = \frac{(\text{Solids Loading, lbs/day}) (\text{Recovery, \%} / 100\%)}{(\text{Filter operation, hr/day}) (\text{Area, ft}^2)}$$

$$\text{Flow, cu. ft./sec.} = (\text{Area, Sq. Ft.})(\text{Velocity, ft./sec.})$$

$$\text{Food/Microorganism Ratio} = \frac{\text{BOD, lbs / day}}{\text{MLVSS, lbs}}$$

$$\text{Gallons/Capita/Day} = \frac{\text{Gallons / day}}{\text{Population}}$$

$$\text{Hardness} = \frac{(\text{mL of Titrant}) (1,000)}{\text{mL of Sample}}$$

$$\text{Horsepower (brake)} = \frac{(\text{Flow, gpm}) (\text{Head, ft})}{(3,960) (\text{Efficiency})}$$

$$\text{Horsepower (motor)} = \frac{(\text{Flow, gpm}) (\text{Head, ft})}{(3960) (\text{Pump, Eff.}) (\text{Motor, Eff.})}$$

$$\text{Horsepower (water)} = \frac{(\text{Flow, gpm}) (\text{Head, ft})}{(3960)}$$

$$\text{Hydraulic Loading Rate} = \frac{\text{Flow}}{\text{Area}}$$

$$\text{Leakage (actual)} = \text{Leak rate (GPD)} \div [\text{Length (mi.)} \times \text{Diameter (in.)}]$$

$$\text{Mean} = \text{Sum of values} \div \text{total number of values}$$

$$\text{Mean Cell Residence Time (MCRT)} = \frac{\text{Suspended Solids in Aeration System, lbs}}{\text{SS Wasted, lbs / day} + \text{SS lost, lbs / day}}$$

$$\text{Organic Loading Rate} = \frac{\text{Organic Load, lbs BOD / day}}{\text{Volume}}$$

$$\text{Oxygen Uptake} = \frac{\text{Oxygen Usage}}{\text{Time}}$$

$$\text{Percent efficiency} = [(\text{In} - \text{Out}) \div \text{In}] \times 100$$

$$\text{Pounds per day} = (\text{Flow, MGD}) (\text{Dose, mg/L}) (8.34)$$

$$\text{Population Equivalent} = \frac{(\text{Flow MGD}) (\text{BOD, mg/L}) (8.34 \text{ lbs / gal})}{\text{Lbs BOD / day / person}}$$

$$\text{RAS Suspended Solids, mg/l} = \frac{1,000,000}{\text{SVI}}$$

$$\text{RAS Flow, MGD} = \frac{(\text{Infl. Flow, MGD}) (\text{MLSS, mg/l})}{\text{RAS Susp. Sol., mg/l} - \text{MLSS, mg/l}}$$

$$\text{RAS Flow \%} = \frac{(\text{RAS Flow, MGD}) (100 \%)}{\text{Infl. Flow, MGD}}$$

$$\text{Reduction in Flow, \%} = \frac{(\text{Original Flow} - \text{Reduced Flow}) (100\%)}{\text{Original Flow}}$$

$$\text{Slope} = \frac{\text{Drop or Rise}}{\text{Run or Distance}}$$

$$\text{Sludge Age} = \frac{\text{Mixed Liquor Solids, lbs}}{\text{Primary Effluent Solids, lbs / day}}$$

$$\text{Sludge Index} = \frac{\% \text{ Settleable Solids}}{\% \text{ Suspended Solids}}$$

$$\text{Sludge Volume Index} = \frac{(\text{Settleable Solids, \%}) (10,000)}{\text{MLSS, mg/L}}$$

$$\text{Solids, mg/L} = \frac{(\text{Dry Solids, grams}) (1,000,000)}{\text{mL of Sample}}$$

$$\text{Solids Applied, lbs/day} = (\text{Flow, MGD})(\text{Concentration, mg/L})(8.34 \text{ lbs/gal})$$

$$\text{Solids Concentration} = \frac{\text{Weight}}{\text{Volume}}$$

$$\text{Solids Loading, lbs/day/sq. ft} = \frac{\text{Solids Applied, lbs / day}}{\text{Surface Area, sq. ft}}$$

$$\text{Surface Loading Rate} = \frac{\text{Flow}}{\text{Rate}}$$

**Total suspended solids (TSS), mg/L =**  
(Dry weight, mg)(1,000 mL/L) ÷ (Sample vol., mL)

**Velocity =**  $\frac{\text{Flow}}{\text{Area}}$     **O R**     $\frac{\text{Distance}}{\text{Time}}$

**Volatile Solids, % =**  $\frac{(\text{Dry Solids} - \text{Ash Solids}) (100\%)}{\text{Dry Solids}}$

**Volume of Cone =**  $(1/3)(0.785)(\text{Diameter}^2)(\text{Height})$

**Volume of Cylinder =**  $(0.785)(\text{Diameter}^2)(\text{Height})$  OR  $(\pi)(r^2)(h)$

**Volume of Rectangle =**  $(\text{Length})(\text{Width})(\text{Height})$

**Volume of Sphere =**  $[(\pi)(\text{diameter}^3)] \div 6$

**Waste Milliequivalent =** (mL) (Normality)

**Waste Normality =**  $\frac{(\text{Titrant Volume}) (\text{Titrant Normality})}{\text{Sample Volume}}$

**Weir Overflow Rate =**  $\frac{\text{Flow}}{\text{Weir Length}}$

## Conversion Factors

1 acre = 43,560 square feet  
1 cubic foot = 7.48 gallons  
1 foot = 0.305 meters  
1 gallon = 3.79 liters  
1 gallon = 8.34 pounds  
1 grain per gallon = 17.1 mg/L  
1 horsepower = 0.746 kilowatts  
1 million gallons per day = 694.45 gallons per minute  
1 pound = 0.454 kilograms  
1 pound per square inch = 2.31 feet of water  
1% = 10,000 mg/L  
Degrees Celsius =  $(\text{Degrees Fahrenheit} - 32) (5/9)$   
Degrees Fahrenheit =  $(\text{Degrees Celsius} * 9/5) + 32$   
64.7 grains = 1 cubic foot  
1,000 meters = 1 kilometer  
1,000 grams = 1 kilogram  
1,000 milliliters = 1 liter  
144 square inches = 1 square foot  
1.55 cubic feet per second = 1 MGD  
1 meter = 3.28 feet  
 $\pi = 3.141$

## Math Review Section-Practice Exam

Math Problems with Complete Solution can be found at the rear of this section.  
Please try to work the problems without looking at the solution.

### Cube Formula

$$V = (L) (W) (D)$$

$$\text{Volume} = \text{Length} \times \text{Width} \times \text{Depth}$$

### Cylinder Formula

$$V = (.785) (D^2) (d)$$

### *Build it, Fill it and Dose it.*

1. Convert 10 cubic feet to gallons of water.

There is 7.48 gallons in one cubic foot.

2. The liquid in a tank weighs 800 pounds, how many gallons are in the tank?

3. Convert a flow rate of 953 gallons per minute to million gallons per day.  
There is 1440 minutes in a day.

4. Convert a flow rate of 610 gallons per minute to millions of gallons per day.

5. Convert a flow of 550 gallons per minute to gallons per second?

6. Now, convert this number to liters per second.

7. A tank is 6' X 15' x 7' and can hold a maximum of \_\_\_\_\_ gallons of water.  
 $V = (L) (W) (D) \times 7.48 =$

8. A tank is 25' X 75' X 10' what is the volume of water in gallons?  
 $V = (L) (W) (D) \times 7.48 =$

9. In Liters?

$$V = (L)(W)(D) \times 7.48 = \underline{\hspace{2cm}} \times 3.785$$

10. A tank holds 67,320 gallons of water. The length is 60' and the width is 15'. How deep is the tank?

$$\text{Gallons } \underline{\hspace{2cm}} \div 7.48 = \underline{\hspace{2cm}} \quad 60 \times 15 =$$

11. The diameter of a tank is 60' and the depth is 25'. How many gallons does it hold?

Cylinder Formula

$$V = (.785)(D^2)(d)$$

$$.785 \times 60' \times 60' \times 25' \times 7.48 =$$

**Math Problems with Complete Solution can be found at the rear of this section. Please try to work the problems without looking at the solution.**

### **Cubic Feet Information**

There is no universally agreed symbol but the following are used:

cubic feet, cubic foot, cubic ft

cu ft, cu feet, cu foot

ft<sup>3</sup>, feet<sup>3</sup>, foot<sup>3</sup>

feet<sup>3</sup>, foot<sup>3</sup>, ft<sup>3</sup>

feet/-3, foot/-3, ft/-3



## Water Treatment Production Math Numbering System

In water treatment, we express our production numbers in Million Gallon numbers. Example 2,000,000 or 2 million gallons would be expressed as 2 MG or 2 MGD.

Hints. A million has six zeros, you can always divide your final number by 1,000,000 or move the decimal point to the left six places. Example 528,462 would be expressed .56 MGD.

12. The diameter of a tank is 15 Centimeters or cm and the depth is 25 cm, what is the volume in liters?

2.54cm = 1 inch, 12 inches = 1 foot

15 cm ÷ 2.54 cm ÷ 12 inches = .492 feet

.785 X .492' X .492' X \_\_\_\_\_ ' = \_\_\_\_\_ X 7.48 = \_\_\_\_\_ X 3.785 L =

## Percentage and Fractions

Let's look again at the sequence of numbers 1000, 100, 10, 1, and continue the pattern to get new terms by dividing previous terms by 10:

$$\begin{aligned}.1 &= 1/10 \\ .01 &= 1/100 \\ .001 &= 1/1000\end{aligned}$$

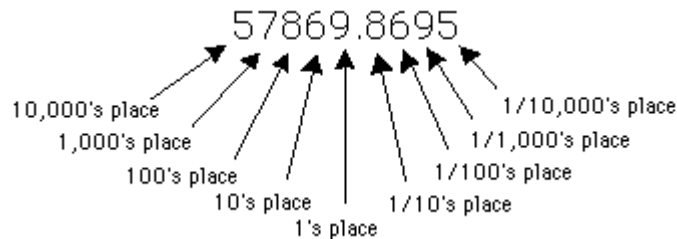

So just as the digits to the left of the decimal represent 1's, 10's, 100's, and so forth, digits to the right of the decimal point represent 1/10's, 1/100's, 1/1000's, and so forth.

Let's express 5% as a decimal.  $5 \div 100 = 0.05$  or you can move the decimal point to the left two places.

### Changing a fraction to a decimal:

**Divide the numerator by the denominator**

**A.**  $5/10$  (five tenths) = five divided by ten:

$$\begin{array}{r} .5 \\ \text{-----} \\ 10 \overline{) 5.0} \\ \underline{50} \\ \text{----} \end{array}$$

So  $5/10$  (five tenths) =  $.5$  (five tenths).

**B.** How about  $1/2$  (one half) or 1 divided by 2 ?

$$\begin{array}{r} .5 \\ \text{-----} \\ 2 \overline{) 1.0} \\ \underline{10} \\ \text{----} \end{array}$$

So  $1/2$  (one half) =  $.5$  (five tenths)

*Notice that equivalent fractions convert to the same decimal representation.*

$8/12$  is a good example.  $8 \div 12 = .66666666$  or rounded off to  $.667$

How about  $6/12$  or 6 inches?  $.5$  or half a foot

## Flow and Velocity

This depends on measuring the average velocity of flow and the cross-sectional area of the channel and calculating the flow from:

$$Q(\text{m}^3/\text{s}) = A(\text{m}^2) \times V(\text{m}/\text{s})$$

Or

$$Q = A \times V$$

**Q CFM = Cubic Ft, Inches, Yards of time, Sec, Min, Hrs, Days**

**A = Area, squared Length X Width**

**V f/m = Inch, Ft, Yards, Per Time, Sec, Min, Ft or Speed**

13. A channel is 3 feet wide and has water flowing to a depth of 2.5 feet. If the velocity through the channel is 2 fps or feet per second, what is the cfs flow rate through the channel?

$$Q = A \times V$$

$Q = 7.5 \text{ sq. ft.} \times 2 \text{ fps}$  What is Q?

$$A = 3' \times 2.5' = 7.5$$

$$V = 2 \text{ fps}$$

14. A channel is 40 inches wide and has water flowing to a depth of 1.5 ft. If the velocity of the water is 2.3 fps, what is the cfs flow in the channel? **Q = A X V**

**First we must convert 40 inches to feet.**

$$40 \div 12'' = 3.333 \text{ feet}$$

$$A = 3.333' \times 1.5' = 4.999 \text{ or round up to 5}$$

$$V = 2.3 \text{ fps}$$

We can round this answer up.

15. A channel is 3 feet wide and has a water flow at a velocity of 1.5 fps. If the flow through the channel is 8.1 cfs, what is the depth of the water?

$$Q = 8.1 \text{ cfs}$$

$$V = 1.5 \text{ fps}$$

$$A = ?$$

$$8.1 \div 1.5 = \underline{\hspace{2cm}} \text{ Total Area}$$

16. The flow through a 6 inch diameter pipe is moving at a velocity of 3 ft/sec. What is the cfs flow rate through the pipeline?

$$Q =$$

$$A = .785 \times .5' \times .5' =$$

$$V = 3 \text{ fps}$$

17. An 8 inch diameter pipe has water flowing at a velocity of 3.4 fps. What is the gpm flow rate through the pipe?

$$Q = \underline{\hspace{2cm}} \text{ cfs} \times 60 \text{ sec/min} \times 7.48 = \underline{\hspace{2cm}} \text{ gpm}$$

$$A = .785 \times .667' \times .667'$$

$$V = 3.4 \text{ fps}$$

18. A 6 inch diameter pipe delivers 280 gpm. What is the velocity of flow in the pipe in ft/sec?

$$\text{Take the water out of the pipe. } 280 \text{ gpm} \div 7.48 \div 60 \text{ sec/min} = \underline{\hspace{2cm}} \text{ cfs}$$

$$Q =$$

$$A = .785 \times .5' \times .5' =$$

$$V =$$

19. A new section of 12 inch diameter pipe is to be disinfected before it is placed in service. If the length is 2000 feet, how many gallons of 5% NaOCl will be need for a dosage of 200 mg/L?

### Cylinder Formula

$$V = (.785) (D^2) (d)$$

$$.785 \times 1' \times 1' \times 2000' = \underline{\hspace{2cm}} \text{ cu.ft.} \times 7.48 = \underline{\hspace{2cm}} \div 1,000,000 = \underline{\hspace{2cm}} \text{ MG}$$

**Pounds per day formula = Flow (MGD) X Dose (mg/L) X 8.34 lbs/gal if 100% concentrate. If not, divide the lbs/day by the given %**

$$0.0117436 \text{ MG} \times 200 \text{ mg/L} \times 8.34 = \underline{\hspace{2cm}} \text{ lbs/day} \div .05 =$$

20. A section of 6 inch diameter pipe is to be filled with water. The length of the pipe is 1320 feet long. How many kilograms of chlorine will be needed for a chlorine dose of 3 mg/L?

$$.785 \times .5' \times .5' \times 1320' \times 7.48 = \underline{\hspace{2cm}} \text{ Make it MGD}$$

**Pounds per day formula = Flow X Dose X 8.34 X .454 Grams per pound**

21. Determine the chlorinator setting in pounds per 24 hour period to treat a flow of 3.4 MGD with a chlorine dose of 3.35 mg/L?

**Pounds per day formula = Flow (MGD) X Dose (mg/L) X 8.34 lbs/gal**

22. To correct an odor problem, you use chlorine continuously at a dosage of 15 mg/L and a flow rate of 85 GPM. Approximately how much will odor control cost annually if chlorine is \$0.17 per pound?

$$85 \text{ gpm} \times 1440 \text{ min/day} = \underline{\hspace{2cm}} \text{ gpd} \div 1,000,000 = \underline{\hspace{2cm}} \text{ MGD}$$

$$\underline{\hspace{2cm}} \text{ MGD} \times 15 \text{ mg/L} \times 8.34 \text{ lbs/gal} \times \$0.17 \text{ per pound} \times 365 \text{ days/year} =$$

23. A wet well measures 8 feet by 10 feet and 3 feet in depth between the high and low levels. A pump empties the wet well between the high and low levels 9 times per hour, 24 hours a day. Neglecting inflow during the pumping cycle, calculate the flow into the pump station in millions of gallons per day (MGD).

Build it, fill it and do what it says, hint:  $X 9 X 24$

**Math problems with complete solution can be found at the rear of this section. Please try to work the problems without looking at the solution.**

***This is not your final assignment...please download the assignment off the website.***

24. A sewage treatment plant has a flow of 0.7 MGD and a BOD of 225 mg/L. On the basis of a national average of 0.2 lbs BOD per capita per day, what is the approximate population equivalent of the plant?

25. What is the detention time of a clarifier with a 250,000 gallon capacity if it receives a flow of 3.0 MGD?

**DT= Volume in Gallons X 24 Divided by MGD**

**.25 MG X 24 hrs. ÷ 3.0 MGD = \_\_\_\_\_ Hours of DT**

Always convert gallons to MG

## Metric Math Section

The metric system is known for its simplicity. All units of measurement in the metric system are based on decimals—that is, units that increase or decrease by multiples of ten. A series of Greek decimal prefixes is used to express units of ten or greater; a similar series of Latin decimal prefixes is used to express fractions. For example, *deca* equals ten, *hecto* equals one hundred, *kilo* equals one thousand, *mega* equals one million, *giga* equals one billion, and *tera* equals one trillion. For units below one, *deci* equals one-tenth, *centi* equals one-hundredth, *milli* equals one-thousandth, *micro* equals one-millionth, *nano* equals one-billionth, and *pico* equals one-trillionth.

26. How many grams equal 4,500 mg?

Just simply divide by 1,000.

**Math Problems with Complete Solution can be found at the rear of this section. Please try to work the problems without looking at the solution.**

***This is not your final assignment...please download the assignment off the website.***





## Temperature

There are two main temperature scales. The **Fahrenheit Scale** (used in the US), and the **Celsius Scale** (part of the Metric System, used in most other Countries)

They both measure the same thing (temperature!), just using different numbers.

- If you freeze water, it measures 0° in Celsius, but 32° in Fahrenheit
- If you boil water, it measures 100° in Celsius, but 212° in Fahrenheit
- The difference between freezing and boiling is 100° in Celsius, but 180° in Fahrenheit.

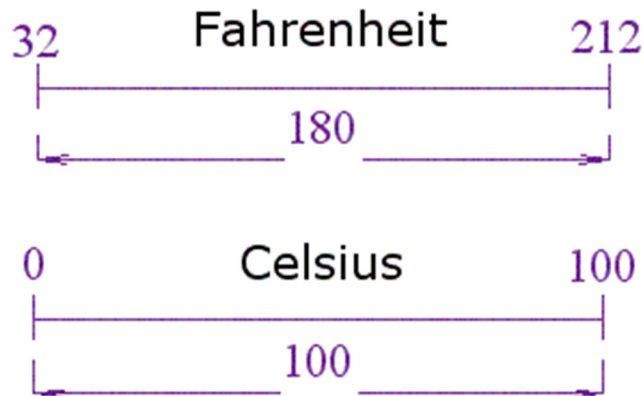

### Conversion Method

Looking at the diagram, notice:

- The scales start at a different number (32 vs. 0), so we will need to add or subtract 32
- The scales rise at a different rate (180 vs. 100), so we will also need to multiply

And this is how it works out:

To convert from Celsius to Fahrenheit, first multiply by 180/100, then add 32

To convert from Fahrenheit to Celsius, first subtract 32, then multiply by 100/180

Note: 180/100 can be simplified to **9/5**, and likewise 100/180=**5/9**.

$$^{\circ}\text{F} = (^{\circ}\text{C} \times 9/5) + 32 \quad 9/5 = 1.8$$

$$^{\circ}\text{C} = (^{\circ}\text{F} - 32) \times 5/9 \quad 5/9 = .555$$

27. Convert 20 degrees Celsius to degrees Fahrenheit.

$$20^{\circ} \times 1.8 + 32 = \text{F}$$

28. Convert 4 degrees Celsius to degrees Fahrenheit.

$$4^{\circ} \times 1.8 + 32 = \text{F}$$

## Water Treatment Filters

29. A 19 foot wide by 31 foot long rapid sand filter treats a flow of 2,050 gallons per minute. Calculate the filtration rate in gallons per minute per square foot of filter area.

**GPM ÷ Square Feet**

30. A 26 foot wide by 36 foot wide long rapid sand filter treats a flow of 2,500 gallons per minute. Calculate the filtration rate in gallons per minute per square foot of filter area.

## Chemical Dose

31. A pond has a surface area of 51,500 square feet and the desired dose of a chemical is 6.5 lbs per acre. How many pounds of the chemical will be needed?

43,560 Square feet in an acre

$$51,500 \div 43,560 = \underline{\hspace{2cm}} \times 6.5 =$$

32. A pond having a volume of 6.85 acre feet equals how many millions of gallons?

33. Alum is added in a treatment plant process at a concentration of 10.5 mg/L. What should the setting on the feeder be in pounds per day if the plant is treating 3.5 MGD?

**Pounds per day formula = Flow (MGD) X Dose (mg/L) X 8.34 lbs/gal**

## Q=AV Review

34. An 8 inch diameter pipe has water flowing at a velocity of 3.4 fps. What is the GPM flow rate through the pipe?

$$Q = 1.18 \text{ CFS} \times 60 \text{ Seconds} \times 7.48 \text{ GAL/CU.FT} = 532 \text{ GPM}$$

$$A = .785 \times .667 \times .667 \times 1 = .349 \text{ Sq. Ft.}$$

$$V = 3.4 \text{ Feet per second}$$

35. A 6 inch diameter pipe delivers 280 GPM. What is the velocity of flow in the pipe in Ft/Sec?  
280 GPM ÷ 60 seconds in a minute ÷ 7.48 gallons in a cu.ft. = .623 CFS

$$Q = .623$$

$$A = .785 \times .5 \times .5 = .196 \text{ Sq. Ft.}$$

$$V = 3.17 \text{ Ft/Second}$$



## Collections

36. A 24-inch sewer carries an average daily flow of 5 MGD. If the average daily flow per person from the area served is 110 GPCD (gallons per capita per day), approximately how many people discharge into the wastewater collection system?

5,000,000 divided by 110 =

37. Using a dose rate of 5 mg/L, how many pounds of chlorine per day should be used if the flow rate is 1.2 MGD?

**Pounds per day formula = Flow (MGD) X Dose (mg/L) X 8.34 lbs/gal**

38. What capacity blower will be required to ventilate a manhole which is 3.5 feet in diameter and 17 feet deep? The air exchange rate is 16 air changes per hour.

$.785 \times 3.5' \times 3.5' \times 17' \times 16 =$  \_\_\_\_\_ CFH

39. Approximately how many feet of drop are in 455 feet of 8-inch sewer with a 0.0475 ft/ft. slope?

**SLOPE =  $\frac{\text{Rise (ft)}}{\text{Run (ft)}}$**

**SLOPE (%) =  $\frac{\text{Rise (ft)} \times 100}{\text{Run (ft)}}$**

455' X 0.0475 =

40. How much brake horsepower is required to meet the following conditions: 250 gpm, total head = 110 feet? The submersible pump that is being specified is a combined 64% efficient?

$(250 \times 110) \div (3960 \times .64)$

41. How wide is a trench at ground surface if a sewer trench is 2 feet wide at the bottom, 10 feet deep and the sides have been sloped at a 4/5 horizontal to 1 vertical (3/4:1) ratio?

(3/4:1) or  $3 \div 4 = .75$  X every foot of depth

42. A float arrives in a manhole 550 feet down stream three minutes and thirty seconds from its release point. What is the velocity in ft/sec.?

**Velocity ft/sec = distance ÷ time**

550' ÷ 3 min stop convert min to sec.  $3 \times 60 = 180 + 30 = 210 \text{ sec}$

550' ÷ 210 sec = \_\_\_\_\_ fps

43. A new sewer line plan calls out a 0.6% slope of the line. An elevation reading of 108.8 feet at the manhole discharge and an elevation of 106.2 feet at a distance of 200 feet from the manhole are recorded. What is the existing slope of the line that has been installed?

$$\text{SLOPE} = \frac{\text{Rise (ft)}}{\text{Run (ft)}}$$

$$\text{SLOPE (\%)} = \frac{\text{Rise (ft)} \times 100}{\text{Run (ft)}}$$

44. A triangular pile of spoil is 12 feet high and 12 feet wide at the base. The pile is 60' long. If the dump truck hauls 9 cubic yards of dirt, how many truck loads will it take to remove all of the spoil?

Given the base and the height of a triangle, we can find the area. Given the area and either the base or the height of a triangle, we can find the other dimension. The formula for area of a triangle is:

$$A = \frac{1}{2} \cdot b \cdot h \quad \text{Or} \quad A = \frac{b \cdot h}{2} \quad \text{where } b \text{ is the base, } h \text{ is the height.}$$

12' X 12' ÷ 2 X 60' = \_\_\_\_\_ cu.ft. (27cu.ft./cu.yrd.)

45. A red dye is poured into an upstream manhole connected to a 12 inch sewer. The dye first appears in a manhole 400 feet downstream 3 minutes later. After 3 minutes and 40 seconds the dye disappears. Estimate the flow velocity in feet per second?

**Velocity ft/sec = distance ÷ time**

**Make sure and convert time and average it.**

**Math problems with complete solution can be found at the rear of this section.  
Please try to work the problems without looking at the solution.  
*This is not your final assignment...please download the assignment off the website.***

46. Calculate the total dosage in pounds of a chemical. Assume the sewer is completely filled with the concentration. Pipe diameter: 18 inches, Pipe length: 420 feet, Dose: 120 mg/L.

Figure out the volume first.

$.785 \times 1.5' \times 1.5' \times 420' \times 7.48 =$  \_\_\_\_\_ convert to MG

**Pounds per day formula = Flow (MGD) X Dose (mg/L) X 8.34 lbs/gal**

**Math problems with complete solution can be found at the rear of this section.  
Please try to work the problems without looking at the solution.**

## Short Answers

1.  $7.48 \times 10 = 74.8$
2.  $800 \div 8.34 = 95.92$  gallons
3. 1372320 or 1.3 MGD
4.  $610 \times 1441 = 878400$  or 0.87 MGD
5.  $550 \div 60 = 9.167$  gpm
6.  $9.167 \times 3.785 = 34.697$  Liters
7. 630 Area 4712 gallons
8.  $18,750 \text{ cu. ft.} \times 7.48 = 140250$  gallons
9.  $140250 \times 3.785 = 530846$  Liters
10. 10 feet deep
11. 528462 or .5 MG
12.  $1.166 \text{ Gallons} \times 3.785 = 4.412$  Liters
13. 15 cfs
14. 11.49 cfs
15. 1.8'
16. .58875 cfs
17. 533 gpm
18. 3.2 ft/sec
19. 46.9 gal
20. .02 kg
21. 94.9 lbs/day
22. \$950.12
23. .388 or .39 MGD
24. 6567.75
25. 2 hrs.
26. 4.5 grams
27. 68° F
28. 39°F
29. 3.48 gpm/sq.ft.
30. 2.67 gpm/sq.ft.
31. 7.68 lbs
32. 2.231 MG
33. 306.495
34. 532 gpm
35. 3.2 fps
36. 45454.5 people
37. 50.04 lbs
38. 2615.6 cfh
39. 21.61 ft
40. 10.85 bhp
41. 17 ft
42. 2.62 fps
43. .013 or 1.3%
44. 17.7 or 18 trucks
45. 2 fps
46. 5.55 lbs





## Math Problems with Complete Solution

### Volume in Cubic Feet

#### Cube Formula

$$V = (L) (W) (D)$$

$$\text{Volume} = \text{Length} \times \text{Width} \times \text{Depth}$$

#### Cylinder Formula

$$V = (.785) (D^2) (d)$$

#### *Build it, Fill it and Dose it.*

1. Convert 10 cubic feet to gallons of water.

There is 7.48 gallons in one cubic foot.

$$\frac{7.48}{1} \div \frac{X}{10} = 74.8 \text{ gallons}$$

Or simply 10 times 7.48 = 74.8 gallons

2. The liquid in a tank weighs 800 pounds, how many gallons are in the tank?

$$800 \text{ lbs} \div 8.34 \text{ lbs/gal} = 95.92 \text{ gallons of water}$$

3. Convert a flow rate of 953 gallons per minute to million gallons per day.  
There is 1440 minutes in a day.

$$953 \text{ Gal/Min} \times 1440 \text{ Min/Day} = 1,372,320 \text{ gal/day}$$

$$1,372,320 \div 1,000,000 = 1.37 \text{ MGD}$$

4. Convert a flow rate of 610 gallons per minute to millions of gallons per day.

$$610 \text{ gal/min} \times 1440 \text{ min/day} = 878,400 \text{ gal/day}$$

$$878,400 \div 1,000,000 = .878 \text{ MGD}$$

5. Convert a flow of 550 gallons per minute to gallons per second?

$$550 \text{ gal/min} \div 60 \text{ sec/min} = 9.17 \text{ gal/sec or } 9.167 \text{ gal/sec.}$$

6. Now, convert this number to liters per second.

9.17 gal/sec X 3.79 Liters/gal + 34.75 Liter/sec or 34.697

7. A tank is 6' X 15' x 7' and can hold a maximum of \_\_\_\_\_ gallons of water.

$$V = (L) (W) (D) \times 7.48 =$$

$$(6 \times 15 \times 7) \times 7.48 = 4,712 \text{ gallons}$$

8. A tank is 25' X 75' X 10' what is the volume of water in gallons?

$$V = (L) (W) (D) \times 7.48 =$$

$$(25 \times 75 \times 10) \times 7.48 = 140,250 \text{ gallons}$$

9. In Liters?

$$V = (L) (W) (D) \times 7.48 = \text{_____} \times 3.785$$

$$(25 \times 75 \times 10) \times 7.48 = 140,250 \text{ gallons} \times 3.785 = 530,846 \text{ Liters}$$

10. A tank holds 67,320 gallons of water. The length is 60' and the width is 15'. How deep is the tank?

$$\text{Gallons } \text{_____} \div 7.48 = \text{_____} \quad 60 \times 15 =$$

$$\frac{67,320 \text{ gal}}{7.48 \text{ gal/cu.ft.}} = 9000 \text{ cu.ft.} = (60 \times 15) = 900 \quad \frac{9000}{900} = 10$$

11. The diameter of a tank is 60' and the depth is 25'. How many gallons does it hold?

Cylinder Formula

$$V = (.785) (D^2) (d)$$

$$.785 \times 60' \times 60' \times 25' \times 7.48 =$$

Or

$$.785 \times (60 \times 60) \times 25 \times 7.48 = 528,462 \text{ gallons}$$

## Math Problems with Complete Solution

### Water Treatment Production Math Numbering System

In water treatment, we express our production numbers in Million Gallon numbers. Example 2,000,000 or 2 million gallons would be expressed as 2 MG or 2 MGD.

Hints. A million has six zeros, you can always divide your final number by 1,000,000 or move the decimal point to the left six places. Example 528,462 would be expressed .56 MGD.

12. The diameter of a tank is 15 Centimeters or cm and the depth is 25 cm, what is the volume in liters?

2.54cm = 1 inch, 12 inches = 1 foot

15 cm ÷ 2.54 cm ÷ 12 inches = .492 feet

$$.785 \times .492 \times .492 \times \underline{\quad} = \underline{\quad} \times 7.48 = \underline{\quad} \times 3.785 \text{ L} =$$

$$.785 \times .492 \times .492 \times 0.82 = .1558165 \times 7.48 = 1.1655074 \times 3.785 \text{ L} = 4.4114455$$

13. A channel is 3 feet wide and has water flowing to a depth of 2.5 feet. If the velocity through the channel is 2 fps or feet per second, what is the cfs flow rate through the channel?

$$Q = A \times V$$

$$Q = 15$$

$$A = 3' \times 2.5' = 7.5$$

$$V = 2 \text{ fps}$$

Or

Area is 7.5 cubic feet

Velocity is 2 fps

Area X Velocity = Quantity

14. A channel is 40 inches wide and has water flowing to a depth of 1.5 ft. If the velocity of the water is 2.3 fps, what is the cfs flow in the channel?  $Q = A \times V$

**First we must convert 40 inches to feet.**

$$40 \div 12" = 3.333 \text{ feet}$$

$$A = 3.333' \times 1.5' = 4.999 \text{ or round up to } 5$$

$$V = 2.3 \text{ fps}$$

We can round this answer up.

Area X Velocity = Quantity

$$5 \times 2.3 = 11.5 \text{ or } 11.49$$

15. A channel is 3 feet wide and has a water flow at a velocity of 1.5 fps. If the flow through the channel is 8.1 cfs, what is the depth of the water?

$$Q = 8.1 \text{ cfs}$$
$$V = 1.5 \text{ fps}$$
$$A = ?$$

$$8.1 \div 1.5 = \text{_____ Total Area}$$
$$\text{Area} \div \text{Quantity} = \text{Velocity}$$
$$8.1 \div 1.5 = 5.4 \text{ cubic feet or Area}$$

16. The flow through a 6 inch diameter pipe is moving at a velocity of 3 ft/sec. What is the cfs flow rate through the pipeline?

$$Q =$$
$$A = .785 \times .5' \times .5' =$$
$$V = 3 \text{ fps}$$

$$\text{Area} \times \text{Velocity} = \text{Quantity}$$
$$0.19625 \times 3 = 0.58875 \text{ cfs}$$

17. An 8 inch diameter pipe has water flowing at a velocity of 3.4 fps. What is the gpm flow rate through the pipe?

$$Q = \text{_____ cfs} \times 60 \text{ sec/min} \times 7.48 = \text{_____ gpm}$$
$$A = .785 \times .667' \times .667'$$
$$V = 3.4 \text{ fps}$$

$$\text{Area} \div \text{Quantity} = \text{Velocity}$$
$$0.3492 \div 3.4 \text{ fps} = 1.1874 \text{ cfs} \times 60 \text{ sec/min} \times 7.48 = 532.85126 \text{ or } 533 \text{ gpm}$$

18. A 6 inch diameter pipe delivers 280 gpm. What is the velocity of flow in the pipe in ft/sec?

$$\text{Take the water out of the pipe. } 280 \text{ gpm} \div 7.48 \div 60 \text{ sec/min} = \text{_____ cfs}$$
$$Q =$$
$$A = .785 \times .5' \times .5' =$$
$$V =$$

$$\text{Quantity} \div \text{Area} = \text{Velocity}$$
$$\text{Quantity} = .624 \text{ CFS}$$
$$\text{Area} = 0.19625$$
$$\text{Velocity} = 3.17 \text{ or } 3.2 \text{ Feet per second}$$

19. A new section of 12 inch diameter pipe is to be disinfected before it is placed in service. If the length is 2000 feet, how many gallons of 5% NaOCl will be need for a dosage of 200 mg/L?

**Cylinder Formula**

**$V = (.785) (D^2) (d)$**

$.785 \times 1' \times 1' \times 2000' = \underline{\hspace{2cm}} \text{ cu.ft.} \times 7.48 = \underline{\hspace{2cm}} \div 1,000,000 = \underline{\hspace{2cm}} \text{ MG}$

**Pounds per day formula = Flow (MGD) X Dose (mg/L) X 8.34 lbs/gal if 100% concentrate.  
If not, divide the lbs/day by the given %**

$0.0117436 \text{ MG} \times 200 \text{ mg/L} \times 8.34 = \underline{\hspace{2cm}} \text{ lbs/day} \div .05 =$

$.785 \times 1' \times 1' \times 2000' = 1570 \text{ cu.ft.} \times 7.48 = 11744 \div 1,000,000 = 0.0117436 \text{ MG}$

**Pounds per day formula = Flow (MGD) X Dose (mg/L) X 8.34 lbs/gal if 100% concentrate.  
If not, divide the lbs/day by the given %**

$0.0117436 \text{ MG} \times 200 \text{ mg/L} \times 8.34 = 19.588 \text{ lbs/day} \div .05 \text{ or } 5\% = 391.76 \text{ lbs} \div 8.34 \text{ lb/gal} = 46.9 \text{ gallons}$

20. A section of 6 inch diameter pipe is to be filled with water. The length of the pipe is 1320 feet long. How many kilograms of chlorine will be needed for a chlorine dose of 3 mg/L?

$.785 \times .5' \times .5' \times 1320' \times 7.48 = \underline{\hspace{2cm}}$  Make it MGD

**Pounds per day formula = Flow X Dose X 8.34 X .454 Grams per pound**

$.785 \times .5' \times .5' \times 1320' \times 7.48 = 1937.69$  Make it MGD Divide by 1 million =  
 $0.00194 \times .454 =$

21. Determine the chlorinator setting in pounds per 24 hour period to treat a flow of 3.4 MGD with a chlorine dose of 3.35 mg/L?

**Pounds per day formula = Flow (MGD) X Dose (mg/L) X 8.34 lbs/gal**

$3.4 \text{ mgd} \times 3.35 \text{ mg/L} \times 8.34 \text{ Lbs/gal} = 94.99 \text{ lbs}$

22. To correct an odor problem, you use chlorine continuously at a dosage of 15 mg/L and a flow rate of 85 GPM. Approximately how much will odor control cost annually if chlorine is \$0.17 per pound?

$$85 \text{ gpm} \times 1440 \text{ min/day} = \text{_____} \text{ gpd} \div 1,000,000 = \text{_____} \text{ MGD}$$
$$\text{_____} \text{ MGD} \times 15 \text{ mg/L} \times 8.34 \text{ lbs/gal} \times \$0.17 \text{ per pound} \times 365 \text{ days/year} =$$

$$85 \text{ gpm} \times 1440 \text{ min/day} = 122,400 \text{ gpd} \div 1,000,000 = 0.1224 \text{ MGD}$$

$$.1224 \text{ MGD} \times 15 \text{ mg/L} \times 8.34 \text{ lbs/gal} \times \$0.17 \text{ per pound} \times 365 \text{ days/year} = \$950.12$$

23. A wet well measures 8 feet by 10 feet and 3 feet in depth between the high and low levels. A pump empties the wet well between the high and low levels 9 times per hour, 24 hours a day. Neglecting inflow during the pumping cycle, calculate the flow into the pump station in millions of gallons per day (MGD).

Build it, fill it and do what it says, hint:  $X \ 9 \ X \ 24$

$L \ X \ W \ X \ H$

$$(8 \ X \ 10 \ X \ 3) = 240 \text{ CF} \times 7.48 \text{ gal/cf} = 1795.2 \ X \ 9 \ X \ 24 = 387763 \text{ gallons/day or rounds to } .388 \text{ MGD}$$

24. A sewage treatment plant has a flow of 0.7 MGD and a BOD of 225 mg/L. On the basis of a national average of 0.2 lbs BOD per capita per day, what is the approximate population equivalent of the plant?

Population equivalent

$$\frac{(0.7 \text{ MGD}) (22.5 \text{ mg/L}) (8.34 \text{ Lbs/gal})}{0.2 \text{ Lbs BOD/Day/Person}} = 6,567.75 \text{ people}$$

25. What is the detention time of a clarifier with a 250,000 gallon capacity if it receives a flow of 3.0 MGD?

**DT= Volume in Gallons X 24 Divided by MGD**

$$.25 \text{ MG} \times 24 \text{ hrs.} \div 3.0 \text{ MGD} = \text{_____} \text{ Hours of DT}$$

Always convert gallons to MG

$$.25 \text{ MG} \times 24 \text{ hrs.} \div 3.0 \text{ MGD} = 2 \text{ Hours of DT}$$

26. How many grams equal 4,500 mg?

Just simply divide by 1,000.

$$4,500 \div 1,000 = 4.5 \text{ grams}$$

27. Convert 20 degrees Celsius to degrees Fahrenheit.

$$20^{\circ} \text{ C} \times 1.8 + 32 = 68 \text{ F}$$

28. Convert 4 degrees Celsius to degrees Fahrenheit.

$$4^{\circ} \text{ C} \times 1.8 + 32 = 39.2 \text{ or } 39 \text{ degrees}$$

## Math Problems with Complete Solution Water Treatment Filters

29. A 19 foot wide by 31 foot long rapid sand filter treats a flow of 2,050 gallons per minute. Calculate the filtration rate in gallons per minute per square foot of filter area.

**GPM ÷ Square Feet**

$$(19 \times 31) = 589 \text{ sq. ft}$$

$$2050 \text{ gal/min} \div 589 \text{ sq. ft} = 3.48 \text{ gpm/sq. ft.}$$

30. A 26 foot wide by 36 foot wide long rapid sand filter treats a flow of 2,500 gallons per minute. Calculate the filtration rate in gallons per minute per square foot of filter area.

$$(26 \times 36) = 936 \text{ Sq. Ft}$$

**GPM ÷ Square Feet**

$$2,500 \text{ gal/min} \div 936 \text{ sq. ft} = 2.678 \text{ gpm/sq. ft.}$$

## Chemical Dose

31. A pond has a surface area of 51,500 square feet and the desired dose of a chemical is 6.5 lbs per acre. How many pounds of the chemical will be needed?

43,560 Square feet in an acre

$$51,500 \div 43,560 = \underline{\hspace{2cm}} \times 6.5 =$$

$$51,500 \text{ sq.ft.} \div 43,560 = 1.18 \times 6.5 = 7.68 \text{ lbs}$$

32. A pond having a volume of 6.85 acre feet equals how many millions of gallons?

$$1 \text{ acre foot} = 325851 \times 6.85 = 2.231 \text{ MG}$$

33. Alum is added in a treatment plant process at a concentration of 10.5 mg/L. What should the setting on the feeder be in pounds per day if the plant is treating 3.5 MGD?

**Flow (MGD) X Dose (mg/L) X 8.34 lbs/gal = Pounds per day formula**

$$3.5 \text{ MGD} \times 10.5 \text{ Mg/L} \times 8.34 \text{ Lbs/gal} = 306.495 \text{ pounds}$$

**Q=AV Review**

34. An 8 inch diameter pipe has water flowing at a velocity of 3.4 fps. What is the GPM flow rate through the pipe?

$$Q = 1.18 \text{ CFS} \times 60 \text{ Seconds} \times 7.48 \text{ GAL/CU.FT} = 532 \text{ GPM}$$

$$A = .785 \times .667 \times .667 \times 1 = .349 \text{ Sq. Ft.}$$

$$V = 3.4 \text{ Feet per second}$$

$$V \times A = Q$$

$$\text{Velocity } 3.4 \text{ fps} \times .349 \text{ Sq.ft} = 1.1866 \text{ CFS} \times 60 \text{ seconds} \times 7.48 \text{ gal/Cu.ft} = 532.5 \text{ or } 533$$

35. A 6 inch diameter pipe delivers 280 GPM. What is the velocity of flow in the pipe in Ft/Sec?

$$280 \text{ GPM} \div 60 \text{ seconds in a minute} \div 7.48 \text{ gallons in a cu.ft.} = .623 \text{ CFS}$$

$$Q = .623$$

$$A = .785 \times .5 \times .5 = .196 \text{ Sq. Ft.}$$

$$V = 3.17 \text{ Ft/Second}$$

$$\text{Quantity} \div \text{Area} = \text{Velocity}$$

$$0.623 \text{ CFS} \div 0.196 \text{ SQ FT} = 3.18 \text{ or } 3.2 \text{ FPS}$$

## Collections

36. A 24-inch sewer carries an average daily flow of 5 MGD. If the average daily flow per person from the area served is 110 GPCD (gallons per capita per day), approximately how many people discharge into the wastewater collection system?

$$5,000,000 \text{ divided by } 110 = 45,454 \text{ people}$$

37. Using a dose rate of 5 mg/L, how many pounds of chlorine per day should be used if the flow rate is 1.2 MGD?

**Flow (MGD) X Dose (mg/L) X 8.34 lbs/gal = Pounds per day formula**

$$1.2 \times 1.2 \text{ mg/l} \times 8.34 = 50.04 \text{ lbs}$$

38. What capacity blower will be required to ventilate a manhole which is 3.5 feet in diameter and 17 feet deep? The air exchange rate is 16 air changes per hour.

$$.785 \times 3.5' \times 3.5' \times 17' \times 16 = \text{_____ CFH}$$

$$.785 \times 3.5' \times 3.5' \times 17' \times 16 = 2615.6 \text{ CFH}$$

$$Q = .785 (D^2) \times \text{Depth}$$



39. Approximately how many feet of drop are in 455 feet of 8-inch sewer with a 0.0475 ft/ft. slope?

$$\text{SLOPE} = \frac{\text{Rise (ft)}}{\text{Run (ft)}}$$

$$\text{SLOPE (\%)} = \frac{\text{Rise (ft)} \times 100}{\text{Run (ft)}}$$

$$455' \times 0.0475 = 21.6 \text{ feet}$$

40. How much brake horsepower is required to meet the following conditions: 250 gpm, total head = 110 feet? The submersible pump that is being specified is a combined 64% efficient?

$$(250 \times 110) \div (3960 \times .64)$$

or

$$\frac{(250 \times 110)}{(3960 \times .64)} = 10.85$$

$$\text{BRAKE HORSEPOWER} = \frac{\text{Flow (gpm)} \times \text{Head (ft)}}{3961 \times \text{Pump Efficiency}}$$

41. How wide is a trench at ground surface if a sewer trench is 2 feet wide at the bottom, 10 feet deep and the sides have been sloped at a 4/5 horizontal to 1 vertical (3/4:1) ratio?

$$(3/4:1) \text{ or } 3 \div 4 = .75 \times \text{every foot of depth}$$

$$0.75 \times 10 \text{ ft} = 7.5 \text{ feet} \times 2 \text{ sides} + 2 \text{ feet on the bottom.}$$

or

$$0.75 \times 10 \text{ ft} = 7.5 \times 2 \text{ sides} = 15 \text{ ft} + 2 \text{ feet} = 17 \text{ feet}$$

42. A float arrives in a manhole 550 feet down stream three minutes and thirty seconds from its release point. What is the velocity in ft/sec.?

$$\text{Velocity ft/sec} = \text{distance} \div \text{time}$$

$$550' \div 3 \text{ min stop convert min to sec. } 3 \times 60 = 180 + 30 = 210 \text{ sec}$$

$$550' \div 210 \text{ sec} = 2.62 \text{ fps}$$

Or

$$\frac{550 \text{ ft}}{210 \text{ sec}}$$

43. A new sewer line plan calls out a 0.6% slope of the line. An elevation reading of 108.8 feet at the manhole discharge and an elevation of 106.2 feet at a distance of 200 feet from the manhole are recorded. What is the existing slope of the line that has been installed?

$$\text{SLOPE} = \frac{\text{Rise (ft)}}{\text{Run (ft)}}$$

$$\text{SLOPE (\%)} = \frac{\text{Rise (ft)} \times 100}{\text{Run (ft)}}$$

$$108.8 - 106.2 = 2.6 \text{ feet of drop or rise}$$

$$2.6 \text{ rise} \div 200 \text{ feet of run} = 0.013 \text{ slope or } 1.3 \% \text{ slope}$$

44. A triangular pile of spoil is 12 feet high and 12 feet wide at the base. The pile is 60' long. If the dump truck hauls 9 cubic yards of dirt, how many truck loads will it take to remove all of the spoil?

Given the base and the height of a triangle, we can find the area. Given the area and either the base or the height of a triangle, we can find the other dimension. The formula for area of a triangle is:

$$A = \frac{1}{2} \cdot b \cdot h \quad \text{Or} \quad A = \frac{b \cdot h}{2} \quad \text{where } b \text{ is the base, } h \text{ is the height.}$$

$$12' \times 12' \times 60' \div 2 = 4320 \text{ cu.ft (27cuft/cu.yard)}$$

$$4320 \div 27 = 160 \text{ cubic yards}$$

$$160 \text{ cubic yards} \div 9 \text{ cubic yard dump trucks}$$

$$17.77777 \text{ dump trucks or } 18 \text{ dump trucks}$$

45. A red dye is poured into an upstream manhole connected to a 12 inch sewer. The dye first appears in a manhole 400 feet downstream 3 minutes later. After 3 minutes and 40 seconds the dye disappears. Estimate the flow velocity in feet per second?

**Velocity ft/sec = distance ÷ time**

**Make sure and convert time and average it.**

$$\begin{array}{l} 3 \text{ Minutes} = 180 \text{ Seconds} \\ + 3 \text{ Minutes} = 40 \text{ Seconds} = 220 \text{ Seconds} \\ \hline 400 \text{ Seconds} \div 2 = 200 \text{ Seconds Average} \end{array}$$

**distance ÷ time = Velocity ft/sec**

$$400 \div 200 = 2 \text{ fps}$$

46. Calculate the total dosage in pounds of a chemical. Assume the sewer is completely filled with the concentration. Pipe diameter: 18 inches, Pipe length: 420 feet, Dose: 120 mg/L.

Figure out the volume first.

$.785 \times 1.5' \times 1.5' \times 420' \times 7.48 = 5549$  convert to MG

**First  $.785 (1.5) (1.5) 420 \times 7.48 = 5549$  convert to MGD  $.005549$**

**Second**

**Flow (MGD) X Dose (mg/L) X 8.34 lbs/gal = Pounds per day formula =  
 $.005549 \times 120 \times 8.34 = 5.55$  lbs**



## Other References

- "A High-Quality Digital X-Y Plotter Designed for Reliability, Flexibility and Low Cost". Hewlett-Packard Journal. <http://www.hpl.hp.com/hpjournal/pdfs/IssuePDFs/1979-02.pdf>. Retrieved 9 February 2012.
- "A.O.Smith: The AC's and DC's of Electric Motors" (PDF). <http://www.aosmithmotors.com/uploadedFiles/AC-DC%20manual.pdf>. Retrieved 2009-12-07.
- "Cobham plc :: Aerospace and Security, Aerospace Communications, Annemasse". Cobham.com. 2011-02-13. <http://www.cobham.com/about-cobham/aerospace-and-security/about-us/aerospace-communications/annemasse.aspx>.
- "Encyclopædia Britannica, "Galileo Ferraris"".
- <http://www.britannica.com/EBchecked/topic/204963/Galileo-Ferraris>.
- "Frequently Asked Slip Ring Questions". Moog.com. 2009-06-23. <http://www.moog.com/products/slip-rings/slip-rings-faq-s/>. Retrieved 2011-09-02.
- "Galileo Ferraris". <http://profiles.incredible-people.com/galileo-ferraris/>.
- "how slip rings work". Uea-inc.com. <http://www.uea-inc.com/products/slip-rings/how-they-work.aspx>.
- "Slip Ring Connector - SenRing Electronics". Senring.com. <http://www.senring.com/hnr67.html>.
- Alan Hendrickson, Colin Buckhurst Mechanical design for the stage Focal Press, 2008 ISBN 0-240-80631-X, page 379 with an illustration of pancake and drum-type slip rings.
- B. R. Pelly, "Thyristor Phase-Controlled Converters and Cycloconverters: Operation, Control, and Performance" (New York: John Wiley, 1971).
- Bakshi U.A. and Bakshi V.U. Basics of Electrical Engineering. Technical Publications Pune. 2008.
- Bakshi U.A., Godse and Bakshi M.V. Electrical Machines and Electronics. Technical Publications Pune, 2009.
- Bedford, B. D.; Hoft, R. G. et al. (1964). Principles of Inverter Circuits. New York: John Wiley & Sons, Inc.. ISBN 0-471-06134-4. (Inverter circuits are used for variable-frequency motor speed control)
- Bishop, Robert H., Ed. The Mechatronics Handbook, ISA—The Instrumentation, Systems and Automation Society, CRC Press, 2002.
- Briere D. and Traverse, P. (1993) "Airbus A320/A330/A340 Electrical Flight Controls: A Family of Fault-Tolerant Systems" Proc. FTCS, pp. 616–623.
- Brumbach Michael E. Industrial Electricity. Thomason Delmar Learning, 2005.
- Cyril W. Lander, Power Electronics 3rd Edition, McGraw Hill International UK Limited, London 1993 ISBN 0-07-707714-8 Chapter 9–8 Slip Ring Induction Motor Control
- Deshpande, M.V. Electric Motors: Application and Control. PHI Learning Private Ltd., 2010.
- Deshpande, M.V. Electric Motors: Application and Control. PHI Learning Private Ltd., 2010.
- Donald G. Fink and H. Wayne Beaty, Standard Handbook for Electrical Engineers, Eleventh Edition, McGraw-Hill, New York, 1978, ISBN 0-07-020974-X.
- Edwin J. Houston and Arthur Kennelly, Recent Types of Dynamo-Electric Machinery, copyright American Technical Book Company 1897, published by P.F. Collier and Sons New York, 1902
- Electric motors use 60% of china's electric energy, for example
- Electricity and magnetism, translated from the French of Amédée Guillemin. Rev. and ed. by Silvanus P. Thompson. London, MacMillan, 1891
- Faraday, Michael (1844). Experimental Researches in Electricity. 2. See plate 4.
- Fitzgerald/Kingsley/Kusko (Fitzgerald/Kingsley/Umans in later years), Electric Machinery, classic text for junior and senior electrical engineering students. Originally published in 1952, 6th edition published in 2002.

Ganot's Physics, 14th Edition, N.Y., 1893 translated by Atkinson, pp. 907 and 908. (Section 899, and Figure 888).

Garrison, Ervan G., "A history of engineering and technology". CRC Press, 1998. ISBN 0-8493-9810-X, 9780849398100. Retrieved May 7, 2009.

Gee, William (2004). "Sturgeon, William (1783–1850)". Oxford Dictionary of National Biography. Oxford, England: Oxford University Press. doi:10.1093/ref:odnb/26748.

Gill, Paul. Electrical Power Equipment Maintenance and Testing. CRC Press: Taylor & Francis Group, 2009.

Herman, Stephen L. Electric Motor Control. 9th ed. Delmar Cengage Learning, 2010.

Herman, Stephen L. Industrial Motor Control. 6th ed. Delmar Cengage Learning, 2010.

[http://books.google.it/books?id=CxQdC6xPFSwC&pg=PA45&lpg=PA45&dq=GALILEO+FERRARIS+AC+MOTOR+INVENTION&source=web&ots=jjeS-hcv2T&sig=cYbNfNNeVwvMIhR-JCP8uReedRU&hl=it&sa=X&oi=book\\_result&resnum=1&ct=result#v=onepage&q&f=false](http://books.google.it/books?id=CxQdC6xPFSwC&pg=PA45&lpg=PA45&dq=GALILEO+FERRARIS+AC+MOTOR+INVENTION&source=web&ots=jjeS-hcv2T&sig=cYbNfNNeVwvMIhR-JCP8uReedRU&hl=it&sa=X&oi=book_result&resnum=1&ct=result#v=onepage&q&f=false).

<http://www.circuitcellar.com/> Motor Comparison, Circuit Cellar Magazine, July 2008, Issue 216, Bachiochi, p.78 (Table edited in Wikipedia, May 2011)

<http://www.daytronic.com/products/trans/t-magpickup.htm>

<http://www.electronicweekly.com/Articles/2010/08/13/46377/dyson-vacuums-104000rpm-brushless-dc-technology.htm>

<http://www.frankfurt.matav.hu/angol/magytud.htm>

<http://www.mpoweruk.com/history.htm>

<http://www.mpoweruk.com/timeline.htm>

<http://www.physics.umd.edu/lecdem/services/demos/demosk4/k4-21.gif>

<http://www.traveltohungary.com/english/articles/article.php?id=135>

Hughes, Austin. Electric Motors and Drives: fundamentals, types and applications. 3rd ed. Linacre House, 2006.

Irwin, David J., Ed. The Industrial Electronics Handbook. CRC Press: IEEE Press, 1997.

Jiles, David. Introduction to Magnetism and Magnetic Materials. CRC Press: Taylor Francis Group, 1998.

John N. Chiasson, Modeling and High Performance Control of Electric Machines, Wiley-IEEE Press, New York, 2005, ISBN 0-471-68449-X.

Kuphaldt, Tony R. (2000–2006). "Chapter 13 AC MOTORS". Lessons In Electric Circuits—Volume II. [http://www.ibiblio.org/obp/electricCircuits/AC/AC\\_13.html](http://www.ibiblio.org/obp/electricCircuits/AC/AC_13.html). Retrieved 2006-04-11.

Laughton M.A. and Warne, D.F., Eds. Electrical Engineer's Reference Book. 16th ed. Elsevier Science, 2003.

linear Electric Machines- A Personal View - Eric R. Laithwaite, Proceedings of the IEEE, Vol. 63, No. 2, February 1975 page 250

Miller, Rex and Mark R. Miller, Industrial Electricity and Motor Controls. McGraw Hill, 2008. Nature 53. (printed in 1896) page: 516

Neidhöfer, Gerhard. [<http://www.ieee.org/organizations/pes/public/2007/sep/peshistory.html>] "Early Three-Phase Power Winner in the development of polyphase ac". <http://www.ieee.org/organizations/pes/public/2007/sep/peshistory.html>.

North, David. (2000) "Finding Common Ground in Envelope Protection Systems". Aviation Week & Space Technology, Aug 28, pp. 66–68.

Pansini, Anthony, J (1989). Basic of Electric Motors. Pennwell Publishing Company. p. 45. ISBN 0-13-060070-9.

Patrick, Dale R. and Fardo, Stephen W. Electrical Distribution Systems. 2nd ed. The Fairmont Press, 2009.

Patrick, Dale R. and Stephen W. Fardo. Rotating Electrical Machines and Power Systems. 2nd ed. The Fairmont Press, 1997.

Patrick, Dale R; Fardo, Stephen W., Rotating Electrical Machines and Power Systems (2nd Edition) 1997 Fairmont Press, Inc. ISBN 978-0-88173-239-9 chapter 11

Peter W. Fortescue, John Stark, Graham Swinerd Spacecraft systems engineering John Wiley and Sons, 2003 ISBN 0-470-85102-3

Rajput R.K. Basic Electrical and Electronics Engineering. Laxmi Publications Ltd., 2007.

Resenblat & Fienman DC and AC machinery

Schoenherr, Steven F. (2001), "Loudspeaker History". Recording Technology History. Retrieved 2010-03-13.

Shanefield D. J., Industrial Electronics for Engineers, Chemists, and Technicians, William Andrew Publishing, Norwich, NY, 2001.

Singh, Yaduvir Dr. and Verma M. Fundamentals of Electrical Engineering. University Science Press, 2010.

Sivanagaraju S., Reddy and Prasad. Power Semiconductor Drives. PHI Learning Private Ltd., 2009.

Slow Speed Torque Drive Units

Subrahmanyam, V., Electric Drives: Concepts and Applications. 2nd ed. Tata McGraw Hill, 2011.

The "Goodness" of Small Contemporary Permanent Magnet Electric Machines - D J Patterson, C W Brice, R A Dougal, D Kovuri

Tokai University Unveils 100W DC Motor with 96% Efficiency  
[http://techon.nikkeibp.co.jp/english/NEWS\\_EN/20090403/168295/](http://techon.nikkeibp.co.jp/english/NEWS_EN/20090403/168295/)

Toliyat, Hamid A. and Kliman G.B. Handbook of Electric Motors. Marcel Dekker, Inc., 2004.

US Department of Energy indicates over half US electricity generation is used by electric motors

Wayne Saslow. Electricity, Magnetism and Light. Thomson Learning Inc., 2002.



We welcome you to complete the assignment in Microsoft Word. You can easily find the assignment at [www.abctlc.com](http://www.abctlc.com).

Once complete, just simply fax or e-mail the answer key along with the registration page to us and allow two weeks for grading. Once we grade it, we will e-mail a certificate of completion to you.

Call us if you need any help. If you need your certificate back within 48 hours, you may be asked to pay a rush service fee of \$50.00.

You can download the assignment in Microsoft Word from TLC's website under the Assignment Page. [www.abctlc.com](http://www.abctlc.com)

You will have 90 days in order to successfully complete this assignment with a score of 70% or better.

If you need any assistance, please contact TLC's Student Services. Once you are finished, please mail, e-mail or fax your answer sheet along with your registration form.