

# CHLORINATION 202

CONTINUING EDUCATION  
PROFESSIONAL DEVELOPMENT COURSE



 **Technical  
Learning  
College**



## Printing and Saving Instructions

TLC recommends that you download and save this pdf document and assignment to your computer desktop and open it with Adobe Acrobat DC reader.

Adobe Acrobat DC reader is a free computer software program and you can find it at Adobe Acrobat's website.

You can complete the course by viewing the course materials on your computer or you can print it out. Once you've purchased the program, we'll give you permission to print this document.

**Printing Instructions:** If you are going to print this document, this document is designed to be printed double-sided or duplexed but can be single-sided.

This course booklet does not have the assignment. Please visit our website and download the assignment also.

### ***Hyperlink to Assignment...***

*<http://www.abctlc.com/downloads/PDF/Chlorination202Ass.pdf>*

**State Approval Listing Link**, check to see if your State accepts or has pre-approved this course. Not all States are listed. Not all courses are listed. Do not solely trust our list for it may be outdated. It is your sole responsibility to ensure this course is accepted for credit. No refunds.

### **State Approval Listing URL...**

*<http://www.abctlc.com/downloads/PDF/CEU%20State%20Approvals.pdf>*

### **Hyperlink to the Glossary and Appendix**

*<http://www.abctlc.com/downloads/PDF/WTGlossary.pdf>*

*You can obtain a printed version from TLC for an additional \$189.95 plus shipping charges.*

**All downloads are electronically tracked and monitored for security purposes.**





**Some States and many employers require the final exam to be proctored.**

**Do not solely depend on TLC's Approval list for it may be outdated.**

**All downloads are electronically tracked and monitored for security purposes.**

### **Precept-Based Training Course**

This training course is based upon a form of induction training, made of topical and technical precepts. The training topics are made up of "micro-content" or "precepts"— or small chunks of information that can be easily digested. These bite-size pieces of technical information are considered to be one of the most effective ways of teaching people new information because it helps the mind retain knowledge easier.

Micro-learning or precept-based training doesn't rely on the student processing a large amount of information before breaking it down. Our method includes short modules with clearly defined learning goals for each section. This method allows a student to hone in on a particular skill, then given the opportunity to exhibit their knowledge in the final assessment.



## Copyright Notice

1999-2022 Technical Learning College (TLC) No part of this work may be reproduced or distributed in any form or by any means without TLC's prior written approval. Permission has been sought for all images and text where we believe copyright exists and where the copyright holder is traceable and contactable. Other materials including text and artwork are in the public domain or fair use (the state of belonging or being available to the public as a whole, and therefore not subject to copyright.) All material that is not credited or acknowledged or referenced in the rear of this course is the copyright of Technical Learning College. All other unacknowledged references are in the Water/Wastewater Sampling and Water Chemistry Courses. Most unaccredited photographs have been taken by TLC instructors or TLC students. All written, graphic, photographic or other material is provided for educational information only. We will be pleased to hear from any copyright holder and will make good on your work if any unintentional copyright infringements were made as soon as these issues are brought to the editor's attention. This educational training course and assignment is intended for educational purposes only. Every possible effort was made to ensure that all information provided in this course is accurate. Therefore, Technical Learning College accepts no responsibility or liability whatsoever for the application or misuse of any information included herein.

Requests for permission to make copies should be made to the following address:

TLC, P.O. Box 3060, Chino Valley, AZ 86323

Information in this document is subject to change without notice. TLC is not liable for errors or omissions appearing in this document.

**Library of Congress Card Number 6571433**  
**ISBN 978-0-9799559-2-1**

### Contributing Editors

**James L. Six** Received a Bachelor of Science Degree in Civil Engineering from the University of Akron in June of 1976, Registered Professional Engineer in the State of Ohio, Number 45031 (Retired), Class IV Water Supply Operator issued by Ohio EPA, Number WS4-1012914-08, Class II Wastewater Collection System Operator issued by Ohio EPA, Number WC2-1012914-94

**Joseph Camerata** has a BS in Management with honors (magna cum laude). He retired as a Chemist in 2006 having worked in the field of chemical, environmental, and industrial hygiene sampling and analysis for 40 years.

**James Bevan**, Water Quality Inspector S.M.E. Twenty years of experience in the environmental field dealing with all aspects of water regulations on the federal, state, and local levels. Teacher and Proctor in Charge for Backflow Certification Testing at the ASETT Center in Tucson for the past 15 years and possess an Arizona Community College, Special Teaching Certificate in Environmental Studies.

**Dr. Pete Greer** S.M.E., Retired biology instructor, chemistry and biological review.

**Jack White**, Environmental, Health, Safety expert, City of Phoenix. Art Credits.





## Important Information about this Manual

This manual has been prepared to educate students and operators in general safety awareness of dealing with the often-complex and various water disinfectants, including dangerous chemicals, Chlorine and other toxic materials. This CEU course will also cover chlorination and disinfection, methods, and applications.



This manual will cover general laws, regulations, required procedures and accepted policies relating to the use of disinfectants, DDBPs, Ozone, Ultraviolet Radiation, Respirator Protection Devices, Methods, and Applications. It should be noted, however, that the regulation of respirator protection devices and hazardous materials is an ongoing process and subject to change over time. For this reason, a list of resources is provided to assist in obtaining the most up-to-date information on various subjects.

This manual is not a guidance document for applicators or operators who are involved with pesticides or disinfection procedures. It is not designed to meet the requirements of the United States Environmental Protection Agency, Office of Health and Safety Administration (OSHA) or your local State environmental protection agency or health department.

This course manual will provide general respirator protection and safety awareness and should not be used as a basis for respirator protection method/device guidance. This document is not a detailed safety manual or a source or remedy for respirator protection or control.

Technical Learning College or Technical Learning Consultants, Inc. make no warranty, guarantee or representation as to the absolute correctness or appropriateness of the information in this manual and assumes no responsibility in connection with the implementation of this information. It cannot be assumed that this manual contains all measures and concepts required for specific conditions or circumstances.

This document should be used for educational purposes only and is not considered a legal document. Individuals who are responsible for respirator protection should obtain and comply with the most recent federal, state, and local regulations relevant to these sites and are urged to consult with OSHA, EPA and other appropriate federal, state and local agencies.



# Technical Learning College's Scope and Function

Welcome to the Program,

Technical Learning College (TLC) offers affordable continuing education for today's working professionals who need to maintain licenses or certifications. TLC holds several different governmental agency approvals for granting of continuing education credit.

TLC's delivery method of continuing education can include traditional types of classroom lectures and distance-based courses or independent study. TLC's distance based or independent study courses are offered in a print - based distance educational format. We will beat any other training competitor's price for the same CEU material or classroom training.

Our courses are designed to be flexible and for you to finish the material at your convenience. Students can also receive course materials through the mail. The CEU course or e-manual will contain all your lessons, activities and instruction to obtain the assignments. All of TLC's CEU courses allow students to submit assignments using e-mail or fax, or by postal mail. (See the course description for more information.)

Students have direct contact with their instructor—primarily by e-mail or telephone. TLC's CEU courses may use such technologies as the World Wide Web, e-mail, CD-ROMs, videotapes and hard copies. (See the course description.) Make sure you have access to the necessary equipment before enrolling; i.e., printer, Microsoft Word and/or Adobe Acrobat Reader. Some courses may require proctored closed-book exams, depending upon your state or employer requirements.

## **Flexible Learning**

At TLC, there are no scheduled online sessions or passwords you need contend with, nor are you required to participate in learning teams or groups designed for the "typical" younger campus based student. You will work at your own pace, completing assignments in time frames that work best for you. TLC's method of flexible individualized instruction is designed to provide each student the guidance and support needed for successful course completion.

## **Course Structure**

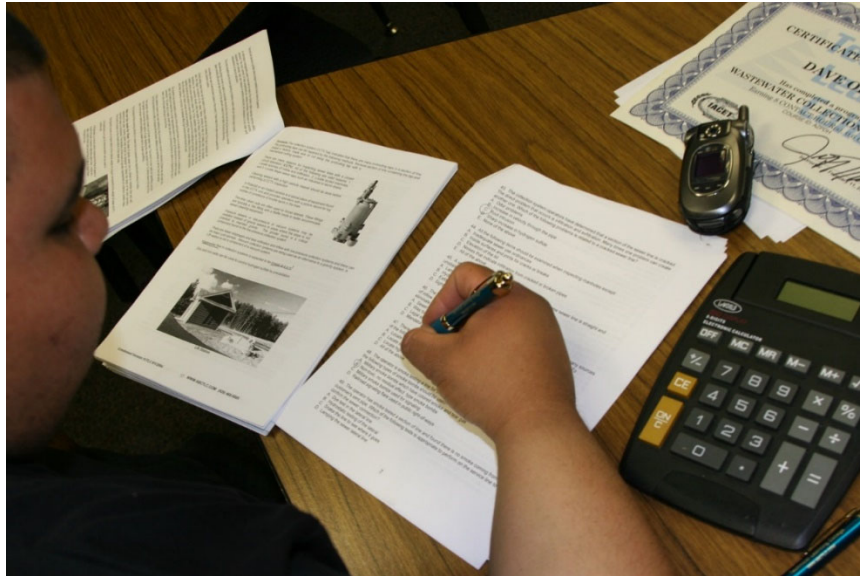
TLC's online courses combine the best of online delivery and traditional university textbooks. You can easily find the course syllabus, course content, assignments, and the post-exam (Assignment). This student-friendly course design allows you the most flexibility in choosing when and where you will study.

## **Classroom of One**

TLC offers you the best of both worlds. You learn on your own terms, on your own time, but you are never on your own. Once enrolled, you will be assigned a personal Student Service Representative who works with you on an individualized basis throughout your program of study. Course specific faculty members (S.M.E.) are assigned at the beginning of each course providing the academic support you need to successfully complete each course. Please call or email us for assistance.

### **Satisfaction Guaranteed**

We have many years of experience, dealing with thousands of students. We assure you, our customer satisfaction is second to none. This is one reason we have taught more than 20,000 students.



We welcome you to do the electronic version of the assignment and submit the answer key and registration to us either by fax or e-mail.

If you need this assignment graded and a certificate of completion within a 48-hour turn around, prepare to pay an additional rush charge of \$50.

**Contact Numbers**  
**Fax (928) 468-0675**  
**Email [Info@tlch2o.com](mailto:Info@tlch2o.com)**  
**Telephone (866) 557-1746**

# Chlorination 202 Training Course CEU Course Description

## Course Purpose

The main purpose of this course is to provide continuing education in understanding various chlorination methods for disinfecting water. Unlike some of the other disinfection methods like ozonation and ultraviolet radiation, conventional chlorination is able to provide a residual to reduce the chance of pathogen regrowth in water storage tanks or within the water distribution system.

At times, distribution systems can be a fair distance from the storage tanks and in dead end sections or where water is not used pathogens may re-grow if a proper (chlorine) residual is cannot be maintained in the treated water sent out for consumption. This results in poor water quality as well as slime and biofilms in the distribution systems that will end up contaminating the clean, treated water being distributed. We will also cover chlorination for wastewater treatment and general laboratory procedures.

## Target Audience

The target audience for this course includes water distribution workers, well drillers, pump installers, water treatment operators, and wastewater operators. Also included are people interested in working in a water treatment/wastewater treatment or distribution facility and/or wishing to maintain CEUs for a certification license or to learn how to perform their job safely and effectively, and/or to meet education needs for promotion. There are no prerequisites, and no other materials are needed for this course.

## Course Statement of Need

Chlorination has been proven to be very effective against bacteria and viruses. However, it cannot disinfect all waterborne pathogens. Certain pathogens, namely protozoan cysts, are resistant to the effects of chlorine.

This course will focus upon gaseous and liquid form of chlorine (Cl<sub>2</sub>) which is a water additive used by municipal water systems to control microbes. It is relatively inexpensive and has the lowest production and operating costs and longest history for large continuous disinfection operations. Chlorine is a powerful oxidant

## Final Examination for Credit

Opportunity to pass the final comprehensive examination is limited to three attempts per course enrollment.

**Prerequisites** None

## Course Procedures for Registration and Support

All of Technical Learning College correspondence courses have complete registration and support services offered. Delivery of services will include, e-mail, web site, telephone, fax and mail support. TLC will attempt immediate and prompt service.

## Instructions for Written Assignments

The Chlorination 202 CEU training course uses a multiple-choice style answer key. TLC would prefer that the answer key and registration, and survey sheet is faxed or e-mailed to, info@tlch2o.com.

## Feedback Mechanism (Examination Procedures)

Each student will receive a feedback form as part of their study packet. You will be able to find this form in the front of the course assignment or lesson.

## **Security and Integrity**

All students are required to do their own work. All lesson sheets and final exams are not returned to the student to discourage sharing of answers. Any fraud or deceit and the student will forfeit all fees and the appropriate agency will be notified.

## **Grading Criteria**

TLC will offer the student either pass/fail or a standard letter grading assignment. If TLC is not notified, you will only receive a pass/fail notice. (Certificate)

## **Recordkeeping and Reporting Practices**

TLC will keep all student records for a minimum of seven years. It is your responsibility to give the completion certificate to the appropriate agencies. We will send the required information to Indiana and Pennsylvania for your certificate renewals.

## **ADA Compliance**

TLC will make reasonable accommodations for persons with documented disabilities. Students should notify TLC and their instructors of any special needs. Course content may vary from this outline to meet the needs of this particular group.

## **Mission Statement**

Our only product is educational service. Our goal is to provide you with the best education service possible. TLC will attempt to make your learning experience an enjoyable educational *opportunity*.

## **Educational Mission**

The educational mission of TLC is:

*To provide TLC students with comprehensive and ongoing training in the theory and skills needed for the environmental education field,*

*To provide TLC students opportunities to apply and understand the theory and skills needed for operator certification,*

*To provide opportunities for TLC students to learn and practice environmental educational skills with members of the community for the purpose of sharing diverse perspectives and experience,*

*To provide a forum in which students can exchange experiences and ideas related to environmental education,*

*To provide a forum for the collection and dissemination of current information related to environmental education, and to maintain an environment that nurtures academic and personal growth.*

## Table of Contents

Topic Legend.....	19
Acronyms.....	21
Preface.....	23
<b>Chapter 1- Disinfection Rules .....</b>	<b>25</b>
Safe Drinking Water Act Introduction- WQ & CRAO .....	27
Disinfection Rule Stages 1&2- DIST & CRAO .....	31
Bromate - CRAO .....	39
DDBPs- WQ & CRAO .....	41
Summary.....	51
Post Quiz.....	53
<b>Chapter 2- Waterborne Pathogens.....</b>	<b>55</b>
Microbiological Contaminants– CRAO & WQ.....	61
Coliform Bacteria – M/O.....	63
TCR Provisions – CRAO & WQ .....	64
Related Microbes – CRAO & M/O .....	65
Bacteriological Monitoring – CRAO & M/O .....	69
Types of Samples – CRAO .....	71
Coliform Present – CRAO .....	73
Heterotrophic Plate Count – CRAO .....	77
Total Coliforms– CRAO .....	81
RTCR – CRAO & M/O.....	83
Pathogens – CRAO & M/O .....	89
Viral Diseases – CRAO.....	97
Cryptosporidiosis – CRAO& M/O.....	100
Sampling Procedures - CRAO& M/O.....	103
Chain of Custody– CRAO .....	104
Common Sample Questions– CRAO & WQ.....	107
Summary– CRAO & WQ .....	113
Post Quiz.....	115
<b>Chapter 3 – Water Chemistry.....</b>	<b>117</b>
Halogens - TECH .....	119
Periodic Table- TECH.....	134
Bonding- TECH .....	137
Energy- TECH .....	139
Reactions- TECH .....	141
Acidity and Basicity- TECH .....	143
pH- TECH & O&M.....	145
Alkalinity- TECH & O&M .....	155
Fluorine- TECH .....	161
Bromine- TECH .....	162
Iodine- TECH .....	163
Astatine- TECH .....	164

Hard Water- TECH.....	165
Post Quiz.....	171
<b>Chapter 4 - Chlorine .....</b>	<b>173</b>
Chlorine Timeline - TECH .....	175
Chlorine Diagrams # 1- TECH .....	177
Elemental Chlorine Introduction- TECH .....	181
Exposure Limits – DISN & SAFETY & O&M.....	184
Atomic Structure- TECH .....	184
Chlorine Disinfectant Qualities- TECH & O&M .....	185
Chlorine Gas Section- TECH & O&M .....	189
Pathophysiology – SAFETY.....	190
Chlorine Diagrams # 2- TECH & O&M.....	193
Chlorine’s Effectiveness- TECH & DISN & O&M.....	195
Benefits of Chlorine- TECH & DISN & O&M .....	199
Amperometric Titration- TECH & O&M .....	205
DPD Method- TECH & O&M .....	206
Chlorine Residual Section- TECH & DISN & O&M .....	209
Chlorine Diagrams # 3- TECH & DISN & O&M .....	213
Chemistry- TECH & DISN & O&M .....	229
Summary.....	233
Post Quiz.....	247
<b>Chapter 5 - Hypochlorites and Chloramines.....</b>	<b>249</b>
Chloramines- TECH & DISN & O&M .....	251
Chloramine Breakdown- TECH & DISN & O&M .....	252
Sodium Hypochlorite- TECH & DISN & O&M .....	255
Sodium Hypochlorite Solutions- TECH & DISN & O&M .....	259
Exposure- TECH & DISN & O&M .....	260
Troubleshooting- TECH & DISN & O&M .....	263
Well Maintenance- TECH & DISN & O&M.....	265
Calcium Hypochlorite- TECH & DISN & O&M .....	273
System Sizing- TECH & DISN & O&M .....	277
Chlorine Production- TECH & DISN & O&M .....	281
System Operation- TECH & DISN & O&M .....	285
Salt Addition- TECH & DISN & O&M .....	288
Summary- TECH & DISN & O&M .....	289
Post Quiz.....	291
<b>Chapter 6- Safety and Chlorination Equipment .....</b>	<b>293</b>
Chlorine Containment- TECH & SAFETY & O&M.....	294
Health Hazards- TECH & DISN & O&M.....	295
Respiratory Protection- TECH & DISN & O&M .....	297
ABC Reminder- TECH & DISN & O&M .....	299
Equipment Requirements- TECH & DISN & O&M .....	303
Chlorine Diagrams # 4- TECH & DISN & O&M .....	307
Chlorine Diagrams # 5- TECH & DISN & O&M .....	311
Chlorine Leak- TECH & DISN & O&M & SAFETY.....	315



Chlorine Cylinder Safety Procedure- TECH & DISN & O&M & SAFETY .....	317
Chlorine Storage- TECH & DISN & O&M .....	319
Spill Procedure- TECH & DISN & O&M & SAFETY.....	321
Leak Procedure- TECH & DISN & O&M & SAFETY .....	324
Emergency Response Plan- TECH & DISN & O&M & SAFETY .....	325
Summary- TECH & DISN & O&M & SAFETY .....	329
Post Quiz.....	331
<b>Chapter 7 -Alternative Disinfectants.....</b>	<b>333</b>
Chlorine Dioxide- TECH & DISN & O&M .....	341
Chlorine Dioxide Advantages- TECH & DISN & O&M .....	343
Phosphine- TECH & DISN & O&M .....	346
Chlorine Dioxide Testing Methods- TECH & DISN & O&M .....	347
Ultraviolet Radiation- TECH & DISN & O&M.....	349
Photoelectric Cell- TECH & DISN & O&M .....	352
Advantages and Disadvantages- TECH & DISN & O&M .....	353
Ozone- TECH & DISN & O&M .....	355
Advantages- TECH & DISN & O&M .....	356
Alternative Disinfectants Diagram #1- TECH & DISN & O&M .....	357
Alternatives Summary- TECH & DISN & O&M .....	359
Post Quiz.....	361
<b>Chapter 8- Respiratory Protection .....</b>	<b>363</b>
Introduction –TECH & SAFETY.....	365
Types of Respirators–TECH & SAFETY .....	366
Correct Fit–TECH & SAFETY .....	368
OSHA Overview–TECH & SAFETY.....	371
RP Responsibilities–TECH & SAFETY.....	373
Program Evaluation–TECH & SAFETY.....	375
RP Recordkeeping–TECH & SAFETY.....	376
Training Certificate–TECH & SAFETY.....	377
Fit Testing–TECH & SAFETY.....	379
Filter Identification–TECH & SAFETY.....	383
Program Checklist–TECH & SAFETY.....	384
Respiratory Protection Schedule–TECH & SAFETY.....	385
Medical Evaluation–TECH & SAFETY.....	387
Gas and Vapors–TECH & SAFETY.....	391
RP Cleaning–TECH & SAFETY.....	395
Respirator Storage–TECH & SAFETY.....	397
Personal Protective Equipment–TECH & SAFETY .....	399
Post Quiz.....	405

<b>Chapter 9- Lab Analyst Section .....</b>	<b>407</b>
Turbidity Testing - CRAO.....	409
Residual Chlorine- CRAO .....	415
Chlorine Residual Reagent- CRAO .....	417
DPD Titration Method- CRAO .....	421
Biological Procedure Introduction.....	425
Protozoan Pathogens- CRAO & M/O.....	429
Method 1623- CRAO & M/O .....	431
Method 1604- CRAO & M/O .....	475
Summary.....	487
Post Quiz.....	493
Common Water Chemicals.....	495
Post Quiz Answers.....	499
Math Conversion Factors.....	501
References.....	505

**Hyperlink to the Glossary and Appendix**

*<http://www.abctlc.com/downloads/PDF/WTGlossary.pdf>*

## Topic Legend

This CEU course covers several educational topics, functions, purposes, objectives, requirements and theories of conventional disinfection, including safety, bacteriological monitoring and regulatory compliance. The topics listed below are to assist in determining which educational objective or goal is covered for a specific topic area:

**CRAO:** The regulatory and compliance component. May be a requirement of the SDWA or CWA act or State Regulations, i.e. Compliance, non-compliance, process control related sampling or other drinking water related requirement. This EPA information is to satisfy the regulatory portion of your operator training. O&M or laboratory training requirement for many operators.

**DISINFECTION (DISN):** This area covers plant disinfection procedures. Part of O&M training for many operators. May include alternative disinfection procedures, i.e. Chloramines, Ozone and Ultraviolet.

**M/O:** The biological component. The microorganisms that are specifically found in drinking water. This section may be part of required sampling, i.e. Total Coliform Rule or other biological related sampling. O&M or laboratory training requirement for many operators.

**O&M:** This area is for normal operation and/or maintenance of the plant, i.e. chlorination equipment. Part of O&M training requirement for many operators.

**SAFETY:** This area is describing process safety procedures. O&M training requirement for many operators.

**TECHNICAL (TECH):** The mechanical or physical treatment process/component. The conventional or microfiltration process including processes/ applications/ engineering/ theories. Part of O&M training for many operators.

**WQ:** Having to do with water quality or pollutants, i.e., hard water to primary water standards. May be a requirement of the SDWA and/or water chemistry concerns. This along with the EPA information is to satisfy the regulatory portion of your operator training.



## Disinfection Acronyms

°C: degrees Celsius (a/k/a centigrade).

**Anthrax:** The disease caused by bacillus Anthracis.

**AOX:** Absorbable organic halogen.

**ART:** Average residence time

**AWWA:** American Water Works Association.

**BAT:** Best available technology

**CDC:** Centers for Disease Control.

**Chlorate ion (  $\text{ClO}_3^-$  ):** A product of the disproportionation of chlorine dioxide, for example by sunlight.

**Chlorine dioxide (  $\text{ClO}_2$  ):** A free radical; a powerful, selective oxidant.

**Chloride ion (  $\text{Cl}^-$  ):** The principal reduction product of chlorine.

**Chlorite ion (  $\text{ClO}_2^-$  ):** A product of the partial reduction of chlorine dioxide.

**CWS:** Community water system

**CxT value:** The product of the net residual [concentration] of a disinfectant and [time], used as a measure of the amount of disinfection applied to a system.

**DOT:** (United States) Department of Transportation.

**EPA:** (United States) Environmental Protection Agency.

°F: degrees Fahrenheit.

**DBP:** Disinfection byproducts

**DBPR:** Disinfectants and Disinfection Byproducts Rule

**DWSRF:** Drinking Water State Revolving Fund

**EPA:** United States Environmental Protection Agency

**FACA:** Federal Advisory Committee Act

**FDA:** (United States) Food & Drug Administration.

**FIFRA:** Federal Insecticide Fungicide & Rodenticide Act.

**HAA:** Haloacetic acid(s), by-products of chlorination of water containing organics which are suspected carcinogens.

**ICR:** Information Collection Rule.

**FR:** Federal Register

**GAC10:** Granular activated carbon with ten-minute empty bed contact time and 180-day reactivation frequency

**GAC20:** Granular activated carbon with twenty-minute empty bed contact time and 240-day reactivation frequency

**GWR:** Groundwater Rule

**GWUDI:** Ground water under the direct influence of surface water

**HAA5:** Haloacetic acids (five) (sum of monochloroacetic acid, dichloroacetic acid, trichloroacetic acid, monobromoacetic acid, and dibromoacetic acid)

**ICR:** Information Collection Rule

**IDSE:** Initial distribution system evaluation

**IESWTR:** Interim Enhanced Surface Water Treatment Rule

**L:** Liter.

**Legionella:** The microorganism that causes Legionnaire's disease.

**MCL:** Maximum Contaminant Level.

**MCLG:** Maximum Contaminant Level Goal.

**mg:** Milligram.

**LRAA:** Locational running annual average

**LT1ESWTR:** Long Term 1 Enhanced Surface Water Treatment Rule

**LT2ESWTR:** Long Term 2 Enhanced Surface Water Treatment Rule

**MCL:** Maximum contaminant level

**MCLG:** Maximum contaminant level goal  
**M-DBP:** Microbial and Disinfectants/Disinfection Byproducts  
**mg/L:** Milligrams per liter  
**MGD:** Millions of Gallons per Day  
**MRDL:** Maximum residual disinfectant level  
**MRDL:** Maximum Residual Disinfectant Level.  
**MRT:** Maximum residence time  
**NIH:** National Institutes of Health.  
**NOM:** Natural organic matter  
**NTNCWS:** Nontransient noncommunity water system  
**OSHA:** (United States) Occupational Safety and Health Administration.  
**Oxidation:** The net transfer of electrons from a source to an acceptor.  
**Pathogen:** A disease-causing organism.  
**ppb:** Parts-per-billion.  
**ppm:** parts-per-million; in water, equivalent to mg/L.  
**PWS:** Public water system  
**SBREFA:** Small Business Regulatory Enforcement Fairness Act  
**SDWA:** Safe Drinking Water Act, as amended in 1986 and 1996  
**SDWA:** Safe Drinking Water Act.  
**Sodium chlorate (NaClO<sub>3</sub>):** The sodium salt of chloric acid; a precursor for chlorine dioxide production, especially for pulp bleaching.  
**Sodium chlorite (NaClO<sub>2</sub>):** The sodium salt of chlorous acid, a precursor for chlorine dioxide production, especially for drinking water treatment.  
**Stachybotrys:** A particularly virulent type of toxic mold.  
**TLV:** Threshold Limit Value.  
**TOC:** Total Organic Carbon.  
**SWTR:** Surface Water Treatment Rule  
**TCR:** Total Coliform Rule  
**TOC:** Total organic carbon  
**TOX:** Total organic halogen.  
**Trihalomethanes:** (THM) by-products of chlorination of water containing organics which are suspected carcinogens.  
**USDA:** United States Department of Agriculture.  
**UV:** Ultraviolet light.  
**TTHM:** Total trihalomethanes  
**UV:** Ultraviolet light  
**VSS:** Very small system  
**WTP:** Water treatment plant

## Preface

Selecting the right disinfection agent requires understanding the factors governing the particular site and the water or wastewater to be treated. In general, the selection of an appropriate disinfection system should be evaluated against the following six criteria:

1. **Safety.** How does the disinfectant work and what types of precautions are needed to transport, store, use, and operate the disinfectant system and associated chemicals? If a system will require significant safety protection—such as use of breathing apparatus and protective clothing—as well as high levels of operator training, it may be advisable to explore other, less intensive systems. In addition, while the disinfectant may be relatively safe to use, consideration also has to be made for the effects of both intentional and unintentional releases to the environment.
2. **Effectiveness.** How effective is the disinfectant against the pathogens present in the water or wastewater? Since the intent is to reduce the levels of pathogens to acceptable standards, understanding how effective the proposed disinfectant system is in achieving those target levels, as well as the system's ability to reliably achieve the result, will be important to selecting the right system.
3. **Cost.** What are the costs associated with the disinfection system, both in terms of capital outlay and ongoing operations and maintenance? Operating costs can vary in terms of the time it takes to service the disinfectant system regularly, and the costs of supplies and components.
4. **Complexity of use.** How does the system operate and does it take specialized training to keep the system within tolerances? Since the outflow from the treatment facility may be subject to various standards and regulations, if the system is too complex it may require additional staff time to ensure that it operates within the desired parameters.
5. **Environmental/Adverse Effects.** What are some of the potential downsides to the operation of the system as it relates to the distribution system or watershed in which the treated effluent is discharged? While some systems may provide a net-positive environmental benefit through increased oxygenation of the receiving waters, other systems may need to have additional treatment of the disinfected effluent in order to render it benign when released.
6. **Flow and Water Characteristics.** Can the system handle fluctuations within the flow or with changing characteristics of the water or wastewater being processed? If a system has a narrow tolerance for the amount of water or wastewater flow, this could impact the effectiveness of the overall system. In addition, if the system cannot adjust for off-site concerns such as dry or wet weather flow rates of the receiving water body, this may also affect the system's appropriateness for your application.

With those criteria in mind, there are primarily four basic disinfection systems currently available—chlorination, ozone gas, ultraviolet radiation, and chemical treatment other than chlorine.

A variety of factors come into play in deciding which type of disinfectant system is right for your operation. The decision to install a system could be the result of local concerns and potential to mitigate health risks, as well as improved community relations.

In any event, the operator of an onsite water or wastewater treatment plant needs to consider some of the safeguards that need to be in place as well.

"Typical safeguards include operator training and instrumentation monitoring that will perform a shutdown function if something goes above a certain level," says Schilling. "If they detect [for example] an ozone leak, you can do an interconnect and do a plant shutdown.

UV has safeguards where you have monitors that tell you what your dosage is, and if you're over or under your dosage it will perform some kind of warning of whatever you want to do."

**State and Local Regulations**

State and local regulations vary considerably in their requirements to disinfect water and wastewater, so the decision of what type of system to use can be affected by the chemical and physical composition of the stream, the environment to which it will be discharged, and the concerns of the local health department. "It's all over the place," says Bach. "The chemical itself is a pesticide and is regulated by the US EPA.

The states will specify what sort of *E. coli* or *coliform* counts you're going to have on discharge, and the regulations vary all over the map in the states. You've got a lot of things like that throughout the country and it goes down to ultimately the views of local health departments and reflects the local topography, their local population density, and also their experience of whether or not people have gotten sick."

**Alternative Disinfectants** *More information in the Alternative Disinfectants Chapter*

**Unknown Factors Associated with Alternatives**

Scientific investigation of risk associated with alternative disinfectants and alternative disinfection by-products is limited. A decision by water facilities to switch from chlorination could be risky because scientists know so little about DBPs from processes other than chlorination.

**Drinking Water Disinfectants At a Glance**

Disinfectants	Residual Maintenance	State of Information on By-Product Chemistry	Color Removal	Removal of Common Odors
Chlorine	Good	Adequate	Good	Good
Chloramines	Good	Limited	Unacceptable	Poor
Chlorine dioxide	Unacceptable*	Adequate	Good	Good
Ozone	Unacceptable	Limited	Excellent	Excellent
Ultraviolet radiation	Unacceptable	Nil	N/A	N/A

\*In Europe, 50% of water distribution systems use chlorine dioxide as the residual disinfectant  
**Source:** Trussell, R., Control Strategy 1; Alternative Oxidants and Disinfectants, 1991



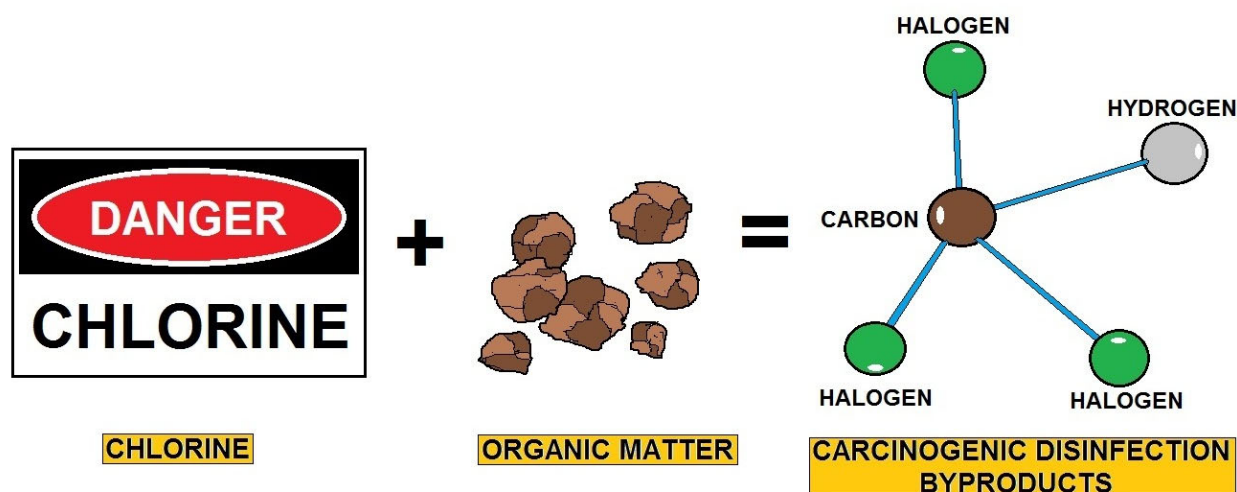
# Chapter 1- Disinfection Rules

**Section Focus:** You will learn the basics of water disinfection rules with an emphasis on Chlorine. At the end of this section, you will be able to describe disinfectant by-products and DBPRs regulations. There is a post quiz at the end of this section to review your comprehension and a final examination in the Assignment for your contact hours.

**Scope/Background:** Pathogens, such as *Giardia*, *Cryptosporidium*, and viruses, are often found in source water and can cause gastrointestinal illness. Illnesses include diarrhea, vomiting, cramps and other health risks. In many cases, water needs to be disinfected to inactivate (or kill) these microbial pathogens. However, disinfectants can react with naturally-occurring materials in the water to form byproducts including:

- Trihalomethanes (THM),
- Haloacetic acids (HAA),
- Chlorite, and
- Bromate.

EPA has developed the DBPRs to limit exposure to these disinfectant byproducts.



## DISINFECTION BYPRODUCT PRODUCTION DIAGRAM

The Stage 1 and Stage 2 Disinfectants and Disinfection Byproducts Rules (DBPRs) are part of the suite of Microbial and Disinfection Byproducts Rules (MDBPs). MDBPs are a series of interrelated regulations that address risks from microbial pathogens and disinfectants/disinfection byproducts. The Stage 2 DBPR improves on public health protection by limiting exposure to Disinfection Byproducts (DBPs), specifically:

- Total trihalomethanes (TTHM), and
- Five haloacetic acids (HAA5)

DBPs can form in water when disinfectants used to control microbial pathogens combine with naturally occurring materials found in source water. These Rules apply to all Community Water Systems (CWS) and Non-Transient Non-Community Water Systems (NTNCWS) that add/deliver a primary or residual disinfectant, and TNCWs that use chlorine dioxide. This Rule does not apply to water systems that use ultraviolet (UV) light.

DISINFECTION OF WATER	
DISINFECTANT	WHAT DISINFECTANT IS USED FOR
OZONE (O <sub>3</sub> )	USED IN DESTROYING BACTERIA, ODORS AND VIRUSES (Scrambles DNA in Viruses to prevent reproduction)
CHLORINE (Cl <sub>2</sub> )	USED TO KILL DISEASE-CAUSING PATHOGENS SUCH AS BACTERIA, VIRUSES AND PROTOZOANS
POTASSIUM PERMANGANATE (KMnO <sub>4</sub> )	USED TO REMOVE IRON AND HYDROGEN SULFIDE, AND ALSO USED IN TREATMENT PLANTS TO CONTROL ZEBRA MUSSEL FORMATIONS
COPPER SULFATE (CuSO <sub>4</sub> )	USED CONTROL PLANT AND ALGAE GROWTH
CALCIUM HYPOCHLORITE (Ca(ClO) <sub>2</sub> )	DESTROYS DISEASE-CAUSING ORGANISMS INCLUDING BACTERIA, YEAST, FUNGUS, SPORES AND VIRUSES
CALCIUM HYDROXIDE (Lime) (CaO)	USED FOR pH CONTROL IN WATER TREATMENT TO PREVENT CORROSION OF PIPING

### TYPES OF DISINFECTION FOR WATER TREATMENT

DISINFECTANTS AND DISINFECTION BYPRODUCTS RULE			
DISINFECTION RESIDUAL	MRDLG (mg/L)	MRDL (mg/L)	COMPLIANCE BASED ON:
CHLORINE	4 (as Cl <sub>2</sub> )	4.0 (as Cl <sub>2</sub> )	ANNUAL AVERAGE
CHLORAMINE	4 (as Cl <sub>2</sub> )	4.0 (as Cl <sub>2</sub> )	ANNUAL AVERAGE
CHLORINE DIOXIDE	0.8 (as ClO <sub>2</sub> )	0.8 (as ClO <sub>2</sub> )	ANNUAL AVERAGE
DISINFECTION BYPRODUCTS	MCLG (mg/L)	MCL (mg/L)	COMPLIANCE BASED ON:
TOTAL TRIHALOMETHANES (TTHM) <sup>1</sup>	N/A	0.080	ANNUAL AVERAGE
- CHLOROFORM	***		
- BROMODICHLOROMETHANE	0		
- DIBROMOCHLOROMETHANE	0.06		
- BROMOFORM	0		
HALOACETIC ACIDS (five) (HAA5) <sup>2</sup>	N/A	0.60	ANNUAL AVERAGE
- DICHLOROACETIC ACID	0		
- TRICHLOROACETIC ACID	0.3		
CHLORITE	0.8	1.0	MONTHLY AVERAGE
BROMATE	0	0.010	ANNUAL AVERAGE

### DISINFECTION BYPRODUCTS RULE PARAMETERS EXAMPLE



## Safe Drinking Water Act of 1974 Introduction

In 1974, Congress passed the Safe Drinking Water Act (SDWA) setting up a regulatory program among local, state, and federal agencies to help ensure the provision of safe drinking water in the U.S. The states are expected to administer and enforce these regulations for public water systems (systems that either have 15 or more service connections or regularly serve an average of 25 or more people daily for at least 60 days each year). Public water systems must provide water treatment, ensure proper drinking water quality through monitoring, and provide public notification of contamination problems.

### **(PL 93-523) as amended by:**

- The Safe Drinking Water Act Amendments of 1986
- National Primary Drinking Water Regulations, 40 CFR 141
- National Interim Primary Drinking Water Regulations Implementation, 40 CFR 142
- National Secondary Drinking Water Regulations, 40 CFR 143

This is the primary Federal legislation protecting drinking water supplied by public water systems (those serving more than 25 people). The Environmental Protection Agency (EPA) is the lead agency and is mandated to set standards for drinking water. The EPA establishes national standards of which the states are responsible for enforcing.

The act provides for the establishment of primary regulations for the protection of the public health and secondary regulations relating to the taste, odor, and appearance of drinking water. Primary drinking water regulations, by definition, include either a maximum contaminant level (MCL) or, when a MCL is not economically or technologically feasible, a prescribed treatment technique which would prevent adverse health effects to humans.

An MCL is the permissible level of a contaminant in water that is delivered to any user of a public water system. Primary and secondary drinking water regulations are stated in 40 CFR 141 and 143, respectively. As amended in 1986, the EPA is required to set maximum contaminant levels for 83 contaminants deemed harmful to humans (with specific deadlines). It also has authority over groundwater. Water agencies are required to monitor water to ensure it meets standards.

### **National Drinking Water Regulations**

The Act instructs the EPA on how to select contaminants for regulation and specifies how the EPA must establish national primary drinking water regulations once a contaminant has been selected (Section 1412). As of late 1996, the EPA had promulgated 84 drinking water regulations.

### **Contaminant Selection**

P.L. 104-182 establishes a new process for the EPA to select contaminants for regulatory consideration based on occurrence, health effects, and meaningful opportunity for health risk reduction. By February 1998 and every 5 years thereafter, the EPA must publish a list of contaminants that may warrant regulation. Every 5 years thereafter, the EPA must determine whether or not to regulate at least 5 of the listed contaminants.

The Act directs the EPA to evaluate contaminants that present the greatest health concern and to regulate contaminants that occur at concentration levels and frequencies of public health concern. The law also includes a schedule for the EPA to complete regulations for disinfectants and disinfection byproducts (D/DBPs) and *Cryptosporidium* (a waterborne pathogen).

## **Standard Setting**

Developing national drinking water regulations is a two-part process. For each contaminant that the EPA has determined merits regulation, the EPA must set a non-enforceable maximum contaminant level goal (MCLG) at a level at which no known or anticipated adverse health effects occur, and which allows an adequate margin of safety.

The EPA must then set an enforceable standard, a maximum contaminant level (MCL), as close to the MCLG as is "*feasible*" using the best technology, treatment techniques, or other means available (taking costs into consideration).

Standards are generally based on technologies that are affordable for large communities; however, under P.L. 104-182, each regulation establishing an MCL must list any technologies, treatment techniques, or other means that comply with the MCL and that are affordable for three categories of small public water systems.

The 1996 Amendments authorize the EPA to set a standard at other than the feasible level if the feasible level would lead to an increase in health risks by increasing the concentration of other contaminants or by interfering with the treatment processes used to comply with other SDWA regulations. In such cases, the standard or treatment techniques must minimize the overall health risk.

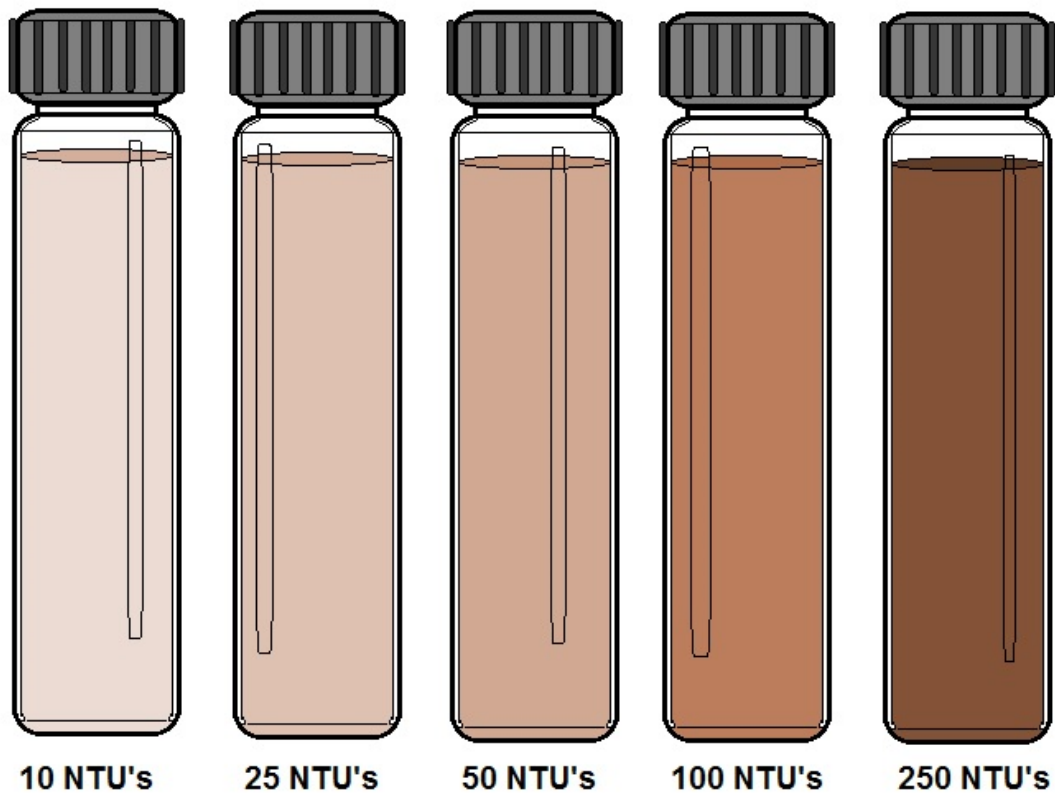
Also, when proposing a regulation, the EPA must now publish a determination as to whether or not the benefits of the standard justify the costs. If the EPA determines that the benefits do not justify the costs, the EPA may, with certain exceptions, promulgate a standard that maximizes health risk reduction benefits at a cost that is justified by the benefits.

### **Relating to prevention of waterborne disease, the SDWA required EPA to:**

- 1) set numerical standards, referred to as Maximum Contaminant Levels (MCLs — the highest allowable contaminant concentrations in drinking water) or treatment technique requirements for contaminants in public water supplies;
- 2) issue regulations requiring monitoring of all regulated and certain unregulated contaminants, depending on the number of people served by the system, the source of the water supply, and the contaminants likely to be found;
- 3) set criteria under which systems are obligated to filter water from surface water sources; it must also develop procedures for states to determine which systems have to filter;
- 4) develop disinfection rules for all public water supplies; and
- 5) require all states to develop Wellhead Protection Programs designed to protect from sources of contamination areas around wells that supply public drinking water systems.

Through the Surface Water Treatment Rule (SWTR), EPA has set treatment requirements to control microbiological contaminants in public water systems using surface water sources (and ground-water sources under the direct influence of surface water). These requirements include the following:

- 1) treatment must remove or inactivate at least 99.9% of *Giardia lamblia* cysts and 99.99% of viruses;
- 2) all systems must disinfect, and are required to filter if certain source water quality criteria and site-specific criteria are not met;
- 3) the regulations set criteria for determining if treatment, including turbidity (suspended particulate matter) removal and disinfection requirements, is adequate for filtered systems; and
- 4) all systems must be operated by qualified operators as determined by the states.



**TURBIDITY SAMPLES IN NTU's (Nephelometric Turbidity Unit)**

### **Turbidity Introduction**

One physical characteristic of water is turbidity. A measure of the cloudiness of water caused by suspended particles. The cloudy appearance of water caused by the presence of tiny particles. High levels of turbidity may interfere with proper water treatment and monitoring. If high quality raw water is low in turbidity, there will be a reduction in water treatment costs. Turbidity is undesirable because it causes health hazards.

The turbidity in natural surface waters is composed of a large number of sizes of particles. The sizes of particles can be changing constantly, depending on precipitation and manmade factors.

When heavy rains occur, runoff into streams, rivers, and reservoirs occurs, causing turbidity levels to increase. In most cases, the particle sizes are relatively large and settle relatively quickly in both the water treatment plant and the source of supply. However, in some instances, fine, colloidal material may be present in the supply, which may cause some difficulty in the coagulation process.

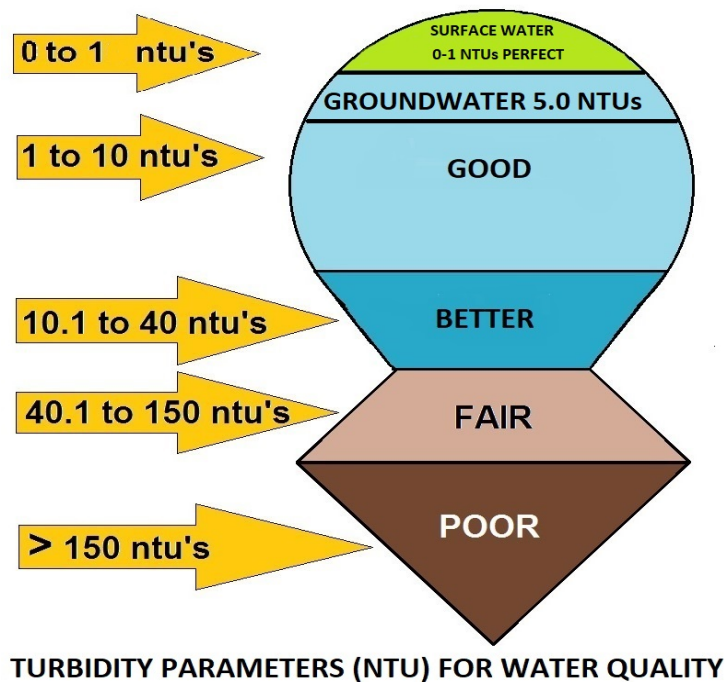
Generally, higher turbidity levels require higher coagulant dosages. However, seldom is the relationship between turbidity level and coagulant dosage linear. Usually, the additional coagulant required is relatively small when turbidities are much higher than normal due to higher collision probabilities of the colloids during high turbidities.

Conversely, low turbidity waters can be very difficult to coagulate due to the difficulty in inducing collision between the colloids.

In this instance, floc formation is poor, and much of the turbidity is carried directly to the filters. Organic colloids may be present in a water supply due to pollution, and these colloids can be difficult to remove in the coagulation process. In this situation, higher coagulant dosages are generally required.

### Turbidity MCL

An MCL for turbidity established by the EPA because turbidity interferes with disinfection. This characteristic of water changes the most rapidly after a heavy rainfall. The following conditions may cause an inaccurate measure of turbidity; the temperature variation of a sample, a scratched or unclean sample tube in the nephelometer and selecting an incorrect wavelength of a light path.



### Surface Water System Compliance Information (Depends on Systems and Rule)

- ▶ 0.34 NTU in 95% of samples, never to exceed 1.0 NTU spike
- ▶ Sample turbidity at each individual filter effluent
- ▶ Sample the combined filter turbidity at the clear well
- ▶ (Groundwater turbidity  $\leq$  5.0 NTU allowed)

### Turbidity Key

- ▶ Turbidity can also be measured in ppm (parts per million) and its size is measured in microns. Turbidity can be particles in the water consisting of finely divided solids, larger than molecules, but not visible by the naked eye; ranging in size from .001 to .150mm (1 to 150 microns).

0.34 NTU in 95% of surface water

## Disinfection Rules Stages 1 & 2 DBPR

*The following are EPA's federal rule requirements. Please be aware that each state implements drinking water regulations that may be more stringent than EPA's regulations. Check with your state environmental agency for more information.*

### Stage 2 DBPR

EPA finalized the Stage 2 Disinfectants and Disinfection Byproduct Rule (DBPR) to reduce potential health risks from DBPs. The Long Term 2 Enhanced Surface Water Treatment Rule (LT2ESWTR) is being finalized and implemented at the same time as the Stage 2 DBPR to ensure that drinking water is safe from both microbial pathogens and DBPs.

### General Requirements

To comply with the Stage 2 Disinfectants and Disinfection Byproducts Rule (Stage 2 DBPR), published on January 4, 2006 (71 FR 388) systems must do the following:

- **Conduct an Initial Distribution System Evaluation (IDSE)** to find locations in the distribution system that have high levels of TTHM and HAA5 and that can be used as compliance monitoring sites for the Stage 2 DBPR.
- **Use a locational running annual average (LRAA) calculation to determine compliance** with the Stage 2 DBPR maximum contaminant levels (MCLs) of:
  - 0.080 mg/L for total trihalomethanes (TTHM), and
  - 0.060 mg/L for five haloacetic acids (HAA5).

**Note:** The MCL values are the same as the Stage 1 MCLs; only the calculation method changes.

- **Monitor for Stage 2 compliance** at the required number of locations for each system's retail population
- **Identify when TTHM or HAA5 levels exceed the operational evaluation level** and, when this happens, look at source water, operational practices, and treatment to find ways to reduce TTHM and HAA5 concentrations in the distribution system. Each of these general requirements are covered in more detail in the rest of this guidance manual. The Stage 2 DBPR is an extension of the Stage 1 Disinfectants and Disinfection Byproducts Rule (Stage 1 DBPR). Systems must also continue to comply with the other requirements of the Stage 1 DBPR in addition to meeting the requirements of the Stage 2 DBPR. This includes compliance with the MCLs for bromate (for systems using ozone) and chlorite (for systems using chlorine dioxide), the MRDLs for chlorine or chloramine (depending on the residual disinfectant used), as well as TOC removal requirements.

### Compliance Timeline

Your compliance schedule for the Stage 2 DBPR are based on whether your system is part of a *combined distribution system*:

- If your system **is** part of a combined distribution system, you must comply with the revised MCLs by the same date as required for the largest system in your combined distribution system.

Example: if your system serves 8,000 people, but you purchase water from a system that serves 250,000 people, you must comply by the dates shown in Schedule 1.

- If your system **is not** part of a combined distribution system, compliance dates are based on the population served by your system.

If you are using this guidance manual, you likely serve fewer than 10,000 people and you must comply by the dates shown in Schedule 4.

**Your State (or EPA) should have sent you a letter telling you what schedule you are on. If you did not receive this letter or you have questions about your schedule, contact your State (contact information is listed in Appendix C).**

**Note:** You are on the same schedule for Stage 2 DBPR compliance as you were on for the IDSE. The timeline on the next page shows important dates for the Stage 2 DBPR as well as periods for *Cryptosporidium* and *E. coli* required under the LT2ESWTR.

**Note:** The figure shows the 2-year period after systems must begin compliance as a “possible extension.” States may give you up to an additional 2 years to comply if you need time to install capital improvements.

### **How Does this Rule Relate to Other Federal, State, and Local Requirements?**

As noted earlier, the Stage 2 DBPR is an extension of the Stage 1 Disinfectants and Disinfection Byproducts Rule (Stage 1 DBPR). The Stage 2 DBPR and the Long Term 2 Enhanced Surface Water Treatment Rule (LT2ESWTR) were published together to address the balance between protection from microbial pathogens and the potential health effects from disinfectants and their byproducts. You are still required to continue to meet all existing federal requirements. You may call the Safe Drinking Water Hotline at (800) 426-4791 (e-mail: [hotline-sdwa@epa.gov](mailto:hotline-sdwa@epa.gov)) for more information on other drinking water rules.

### **Where do DBPs come from?**

Chlorine and other chemical disinfectants have been widely used by public water systems (along with filtration) to protect the public from microbial pathogens in drinking water. DBPs are formed when certain disinfectants react with DBP precursors (organic and inorganic materials) in source waters. In most cases, natural organic matter (NOM) is an important factor that affects the levels of DBPs that form (NOM is usually measured as TOC). The levels of DBPs in drinking water can vary significantly from one point in a distribution system to another, as many continue to form in the distribution system. DBP levels are generally higher in surface water systems because surface water usually contains higher DBP precursor levels and requires stronger disinfection.

### **Ensuring Safe Drinking Water**

All drinking water systems want to provide water that is safe. One aspect of providing safe drinking water is limiting the levels of DBPs in it. Long-term exposure to DBPs has been linked to bladder cancer, and possibly colon and rectal cancers. More recent studies have shown that shorter-term exposure to high levels of DBPs may be associated with adverse reproductive and developmental health effects.

Limiting the levels of DBPs in your drinking water may require you to make some adjustments to your current operations, such as:

- Making operational improvements at the plant or in the distribution system
- Modifying current treatment operations to remove more DBP precursors or form lower levels of DBPs
- Upgrading or installing a new treatment technology



## What Does Compliance Monitoring Involve?

Monitoring requirements for TTHM and HAA5 are based on your source water type and the population your system serves. Note that this is different than the Stage 1 DBPR monitoring requirements that were based on the number of treatment plants in your system.

With population-based monitoring, there are five categories of small systems under the Stage 2 DBPR:

- Subpart H systems that serve fewer than 500 people.
- Subpart H systems that serve 500 to 3,300 people.
- Subpart H systems that serve 3,301 to 9,999 people.
- Ground water systems that serve fewer than 500 people.
- Ground water systems that serve 500 to 9,999 people.

If you do not know what type of system you are, you should contact your State to confirm this information.

## Older Stage 1 DBPR Information

### Disinfection Byproduct Regulations

In December 1998, the EPA established the Stage 1 Disinfectants/Disinfection Byproducts Rule that requires public water systems to use treatment measures to reduce the formation of disinfection byproducts and to meet the following specific standards:

<b>Total Trihalomethanes (TTHM)</b>	80 parts per billion (ppb)
<b>Haloacetic Acids (HAA5)</b>	60 ppb
<b>Bromate</b>	10 ppb
<b>Chlorite</b>	1.0 parts per million (ppm)

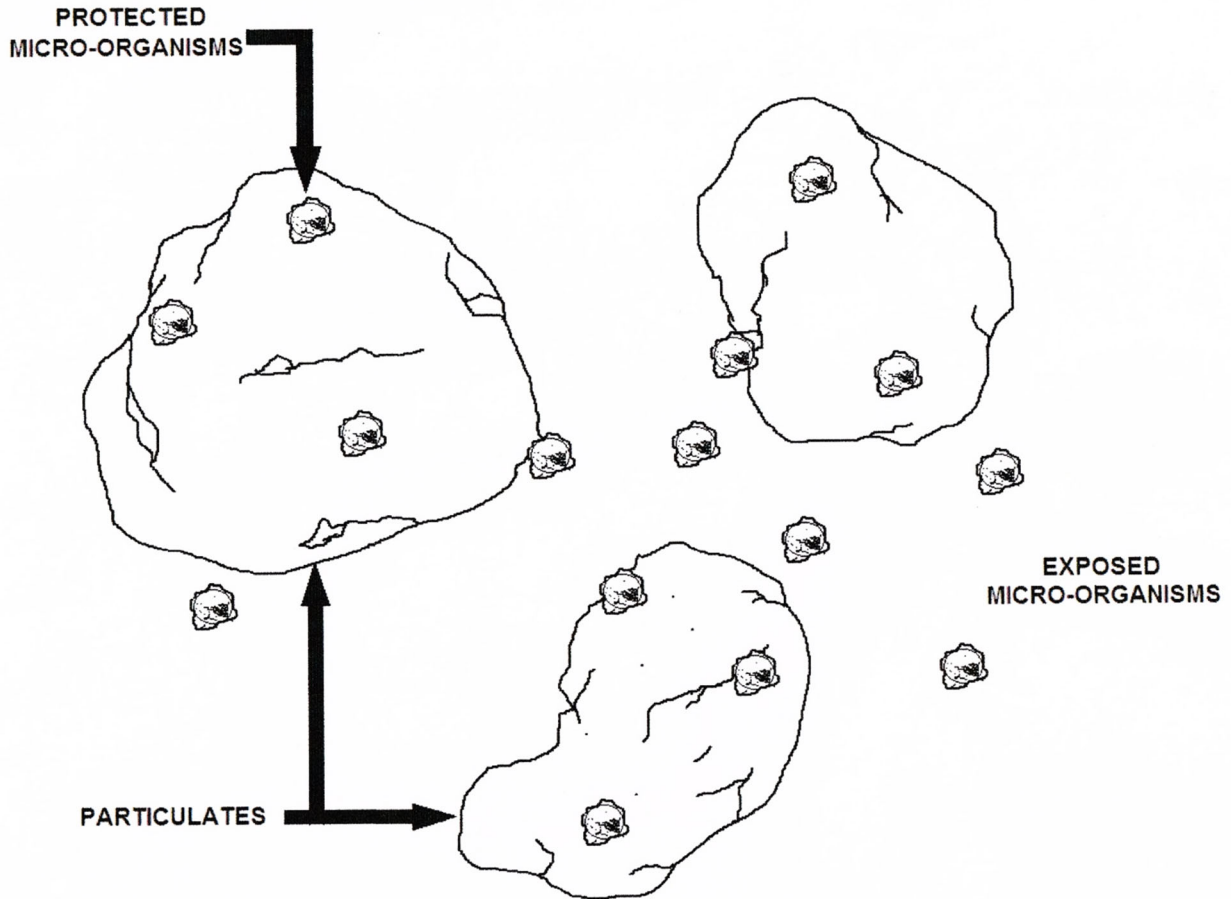
Trihalomethanes were regulated at a maximum allowable annual average level of 100 parts per billion for water systems serving over 10,000 people under the Total Trihalomethane Rule finalized by the EPA in 1979. The Stage 1 Disinfectant/Disinfection Byproduct Rule standards became effective for trihalomethanes and other disinfection byproducts listed above in December 2001 for large surface water public water systems. Those standards became effective in December 2003 for small surface water and all ground water public water systems.

**Disinfection byproducts** are formed when disinfectants used in water treatment plants react with bromide and/or natural organic matter (i.e., decaying vegetation) present in the source water. Different disinfectants produce different types or amounts of disinfection byproducts. Disinfection byproducts for which regulations have been established have been identified in drinking water, including trihalomethanes, haloacetic acids, bromate, and chlorite.

**Trihalomethanes (THM)** are a group of four chemicals that are formed along with other disinfection byproducts when chlorine or other disinfectants used to control microbial contaminants in drinking water react with naturally occurring organic and inorganic matter in water. The trihalomethanes are chloroform, bromodichloromethane, dibromochloromethane, and bromoform. The EPA has published the Stage 1 Disinfectants/Disinfection Byproducts Rule to regulate total trihalomethanes (TTHM) at a maximum allowable annual average level of 80 parts per billion. This new standard replaced the old standard of a maximum allowable annual average level of 100 parts per billion back in December 2001 for large surface water public water systems. The standard became effective for the first time back in December 2003 for small surface water and all ground water systems.

**Haloacetic Acids (HAA5)** are a group of chemicals that are formed along with other disinfection byproducts when chlorine or other disinfectants used to control microbial contaminants in drinking water react with naturally occurring organic and inorganic matter in water. The regulated haloacetic acids, known as HAA5, are: monochloroacetic acid, dichloroacetic acid, trichloroacetic acid, monobromoacetic acid, and dibromoacetic acid. EPA has published the Stage 1 Disinfectants/Disinfection Byproducts Rule to regulate HAA5 at 60 parts per billion annual average.

This standard became effective for large surface water public water systems back in December 2001 and for small surface water and all ground water public water systems back in December 2003.



**TURBIDITY PROVIDES PROTECTION FOR MICRO-ORGANISMS**  
(HINDERS DISINFECTION)

## More on the Stage 2 DBP Rule

*The following are EPA's federal rule requirements. Please be aware that each state implements drinking water regulations may be more stringent than EPA's regulations. Check with your state environmental agency for more information.*

The Stage 2 DBP rule is one part of the Microbial and Disinfection Byproducts Rules (MDBPs), which are a set of interrelated regulations that address risks from microbial pathogens and disinfectants/disinfection byproducts. The Stage 2 DBP rule focuses on public health protection by limiting exposure to DBPs, specifically total trihalomethanes (TTHM) and five haloacetic acids (HAA5), which can form in water through disinfectants used to control microbial pathogens. This rule will apply to all community water systems and nontransient noncommunity water systems that add a primary or residual disinfectant other than ultraviolet (UV) light or deliver water that has been disinfected by a primary or residual disinfectant other than UV.

Amendments to the SDWA in 1996 require EPA to develop rules to balance the risks between microbial pathogens and disinfection byproducts (DBPs). The Stage 1 Disinfectants and Disinfection Byproducts Rule and Interim Enhanced Surface Water Treatment Rule, promulgated in December 1998, were the first phase in a rulemaking strategy required by Congress as part of the 1996 Amendments to the Safe Drinking Water Act.

The Stage 2 Disinfectants and Disinfection Byproducts Rule (Stage 2 DBPR) builds upon the Stage 1 DBPR to address higher risk public water systems for protection measures beyond those required for existing regulations. The Stage 2 DBPR and the Long Term 2 Enhanced Surface Water Treatment Rule are the second phase of rules required by Congress. These rules strengthen protection against microbial contaminants, especially *Cryptosporidium*, and at the same time, reduce potential health risks of DBPs.

### **What is the Stage 2 DBPR?**

The Stage 2 Disinfection Byproducts Rule will reduce potential cancer and reproductive and developmental health risks from disinfection byproducts (DBPs) in drinking water, which form when disinfectants are used to control microbial pathogens. Over 260 million individuals are exposed to DBPs.

This final rule strengthens public health protection for customers by tightening compliance monitoring requirements for two groups of DBPs, trihalomethanes (TTHM) and haloacetic acids (HAA5). The rule targets systems with the greatest risk and builds incrementally on existing rules. This regulation will reduce DBP exposure and related potential health risks and provide more equitable public health protection. The Stage 2 DBPR is being promulgated simultaneously with the Long Term 2 Enhanced Surface Water Treatment Rule to address concerns about risk tradeoffs between pathogens and DBPs.

### **What does the rule require?**

Under the Stage 2 DBPR, systems will conduct an evaluation of their distribution systems, known as an Initial Distribution System Evaluation (IDSE), to identify the locations with high disinfection byproduct concentrations. These locations will then be used by the systems as the sampling sites for Stage 2 DBPR compliance monitoring. Compliance with the maximum contaminant levels for two groups of disinfection byproducts (TTHM and HAA5) will be calculated for each monitoring location in the distribution system. This approach, referred to as the locational running annual average (LRAA), differs from current requirements, which determine compliance by calculating the running annual average of samples from all monitoring locations across the system.

The Stage 2 DBPR also requires each system to determine if they have exceeded an operational evaluation level, which is identified using their compliance monitoring results. The operational evaluation level provides an early warning of possible future MCL violations, which allows the system to take proactive steps to remain in compliance.

A system that exceeds an operational evaluation level is required to review their operational practices and submit a report to their state that identifies actions that may be taken to mitigate future high DBP levels, particularly those that may jeopardize their compliance with the DBP MCLs.

***Who must comply with the rule?***

Entities potentially regulated by the Stage 2 DBPR are community and nontransient noncommunity water systems that produce and/or deliver water that is treated with a primary or residual disinfectant other than ultraviolet light.

A community water system (CWS) is a public water system that serves year-round residents of a community, subdivision, or mobile home park that has at least 15 service connections or an average of at least 25 residents.

A nontransient noncommunity water system (NTNCWS) is a water system that serves at least 25 of the same people more than six months of the year, but not as primary residence, such as schools, businesses, and day care facilities.

***What are disinfection byproducts (DBPs)?***

Disinfectants are an essential element of drinking water treatment because of the barrier they provide against waterborne disease-causing microorganisms. Disinfection byproducts (DBPs) form when disinfectants used to treat drinking water react with naturally occurring materials in the water (e.g., decomposing plant material).

Total trihalomethanes (TTHM - chloroform, bromoform, bromodichloromethane, and dibromochloromethane) and haloacetic acids (HAA5 - monochloro-, dichloro-, trichloro-, monobromo-, dibromo-) are widely occurring classes of DBPs formed during disinfection with chlorine and chloramine.


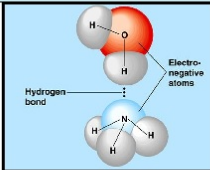
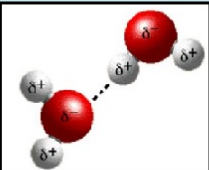
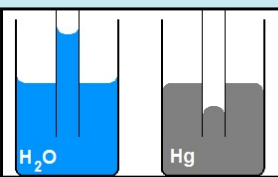
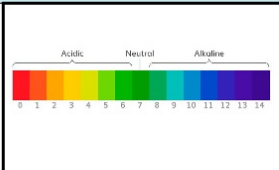



The amount of trihalomethanes and haloacetic acids in drinking water can change from day to day, depending on the season, water temperature, amount of disinfectant added, the amount of plant material in the water, and a variety of other factors.

***Are THMs and HAAs the only disinfection byproducts?***

No. The four THMs (TTHM) and five HAAs (HAA5) measured and regulated in the Stage 2 DBPR act as indicators for DBP occurrence. There are many other known DBPs, in addition to the possibility of unidentified DBPs present in disinfected water. THMs and HAAs typically occur at higher levels than other known and unknown DBPs.

The presence of TTHM and HAA5 is representative of the occurrence of many other chlorination DBPs; thus, a reduction in the TTHM and HAA5 generally indicates a reduction of DBPs from chlorination.

# WATER PROPERTIES

<p style="text-align: center; background-color: #ADD8E6; margin: 0;"><b>SURFACE TENSION</b></p>  <p style="font-size: small; margin-top: 5px;">WATER PROPERTY OF SURFACE TENSION ALLOWS TO HOLD A CERTAIN WEIGHT ON IT'S SURFACE</p>	<p style="text-align: center; background-color: #ADD8E6; margin: 0;"><b>ADHESION</b></p>  <p style="font-size: small; margin-top: 5px;">WATER'S ADHESIVE PROPERTY IS WHY WATER STICKS TO OTHER OBJECTS, LIKE A LEAF OR YOUR SKIN WHEN IT GETS WET</p>	<p style="text-align: center; background-color: #ADD8E6; margin: 0;"><b>COHESION</b></p>  <p style="font-size: small; margin-top: 5px;">WATER'S COHESIVE PROPERTY IS WHY WATER DROPLETS ARE ROUND BEFORE THEY ARE AFFECTED BY ADHESION</p>	<p style="text-align: center; background-color: #ADD8E6; margin: 0;"><b>CAPILLARY ACTION</b></p>  <p style="font-size: small; margin-top: 5px;">CAPILLARY ACTION IS AN ACTION MADE POSSIBLE BY WATER'S ADHESIVE PROPERTY AND SURFACE TENSION.</p>
<p style="text-align: center; background-color: #ADD8E6; margin: 0;"><b>NEUTRAL pH</b></p>  <p style="font-size: small; margin-top: 5px;">THE pH SCALE SHOWS HOW ACIDIC - BASIC A SUBSTANCE IS. PURE WATER HAS A NEUTRAL pH OF 7</p>	<p style="text-align: center; background-color: #ADD8E6; margin: 0;"><b>3 STATES OF MATTER</b></p>  <p style="font-size: small; margin-top: 5px;">WATER, UNLIKE ANY OTHER MATTER, CAN EXIST IN SOLID, LIQUID OR GAS FORMS</p>	<p style="text-align: center; background-color: #ADD8E6; margin: 0;"><b>HIGH HEAT CAPACITY</b></p>  <p style="font-size: small; margin-top: 5px;">WATER HAS A HIGH SPECIFIC HEAT CAPACITY, MEANING THAT IT TAKES QUITE A LOT OF ENERGY TO MAKE IT WARMER</p>	<p style="text-align: center; background-color: #ADD8E6; margin: 0;"><b>DENSITY</b></p>  <p style="font-size: small; margin-top: 5px;">WATER'S DENSITY IS SLIGHTLY LESS THAN 1g/cm<sup>3</sup></p>

## PROPERTIES OF WATER



### What is Water?

Water is the chemical substance with chemical formula  $H_2O$ : one molecule of water has two hydrogen atoms covalently bonded to a single oxygen atom.

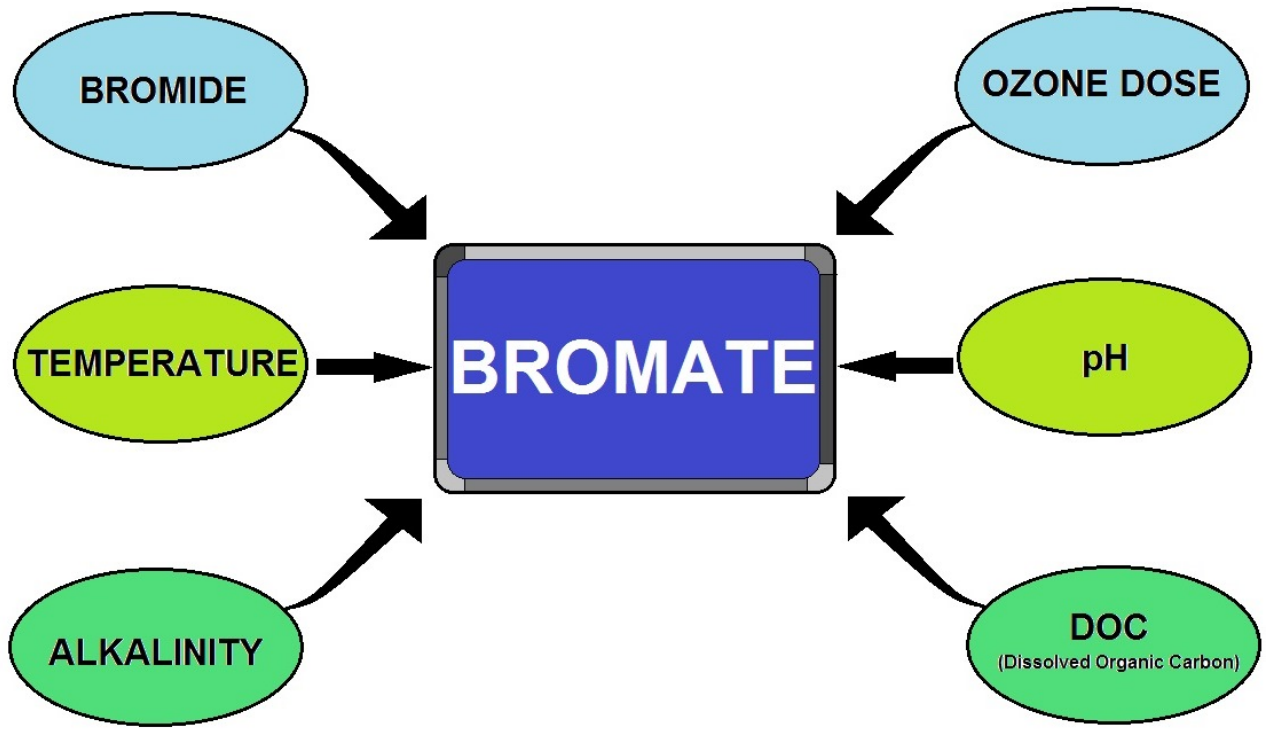
Water is a tasteless, odorless liquid at ambient temperature and pressure, and appears colorless in small quantities, although it has its own intrinsic very light blue hue. Ice also appears colorless, and water vapor is essentially invisible as a gas.

Water is primarily a liquid under standard conditions, which is not predicted from its relationship to other analogous hydrides of the oxygen family in the periodic table, which are gases such as hydrogen sulfide.

The elements surrounding oxygen in the periodic table, nitrogen, fluorine, phosphorus, sulfur and chlorine, all combine with hydrogen to produce gases under standard conditions. The reason that water forms a liquid is that oxygen is more electronegative than all of these elements with the exception of fluorine.

Oxygen attracts electrons much more strongly than hydrogen, resulting in a net positive charge on the hydrogen atoms, and a net negative charge on the oxygen atom. The presence of a charge on each of these atoms gives each water molecule a net dipole moment.

Electrical attraction between water molecules due to this dipole pulls individual molecules closer together, making it more difficult to separate the molecules and therefore raising the boiling point.



**BROMATE FORMATION FACTORS**

## Bromate

Bromate is a chemical that is formed when ozone used to disinfect drinking water reacts with naturally occurring bromide found in source water. The EPA has established the Stage 1 Disinfectants/Disinfection Byproducts Rule to regulate bromate at annual average of 10 parts per billion in drinking water.

This standard became effective for large *public water systems* by December 2001 and for small surface water and all ground public water systems back in December 2003.

Chlorite is a byproduct formed when chlorine dioxide is used to disinfect water. EPA has published the *Stage 1 Disinfectants/Disinfection Byproducts Rule* to regulate chlorite at a monthly average level of 1 part per million in drinking water. This standard became effective for large surface water public water systems back in December 2001 and for small surface water and all ground water public water systems back in December 2003.

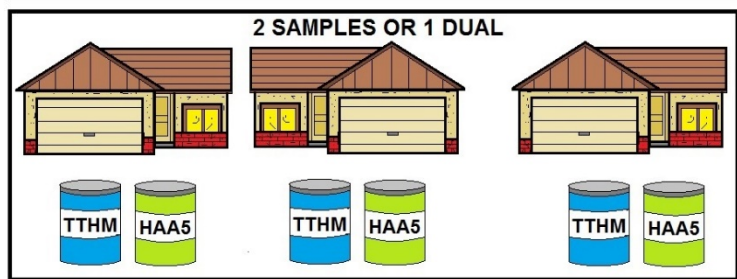
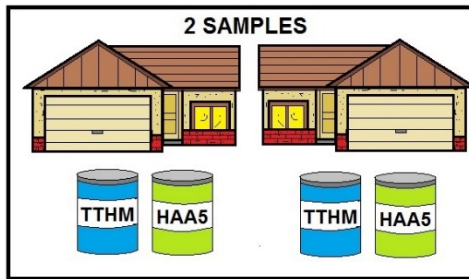
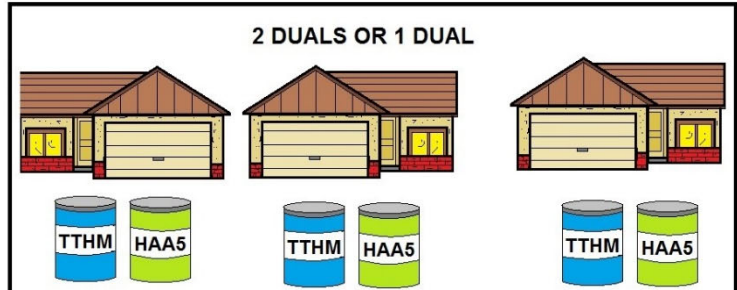
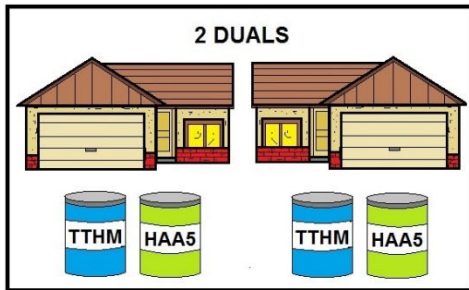
## Microbial Regulations

One of the key regulations developed and implemented by the United States Environmental Protection Agency (USEPA) to counter pathogens in drinking water is the Surface Water Treatment Rule. Among its provisions, the rule requires that a public water system, using surface water (or ground water under the direct influence of surface water) as its source, have sufficient treatment to reduce the source water concentration of *Giardia* and viruses by at least 99.9% and 99.99%, respectively. The Surface Water Treatment Rule specifies treatment criteria to assure that these performance requirements are met; they include turbidity limits, disinfectant residual, and disinfectant contact time conditions.

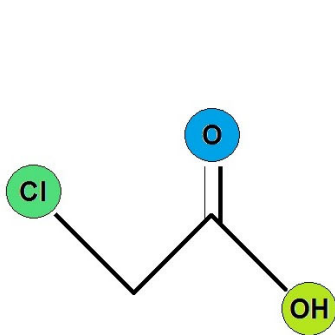
The **Interim Enhanced Surface Water Treatment Rule** was established in December 1998 to control *Cryptosporidium*, and to maintain control of pathogens while systems lower disinfection byproduct levels to comply with the Stage 1 Disinfectants/Disinfection Byproducts Rule. The EPA established a Maximum Contaminant Level Goal (MCLG) of zero for all public water systems and a 99% removal requirement for *Cryptosporidium* in filtered public water systems that serve at least 10,000 people. The new rule will tightened turbidity standards back in December 2001. Turbidity is an indicator of the physical removal of particulates, including pathogens.

The EPA is also planning to develop other rules to further control pathogens. The EPA has promulgated a Long Term 1 Enhanced Surface Water Treatment Rule, for systems serving fewer than 10,000 people. This is to improve physical removal of *Cryptosporidium*, and to maintain control of pathogens while systems comply with Stage 1 Disinfectants/Disinfection Byproducts Rule.

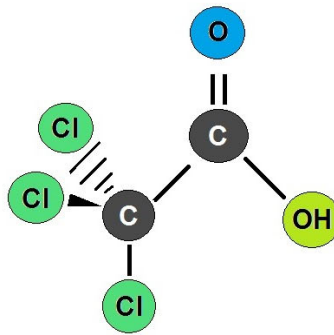




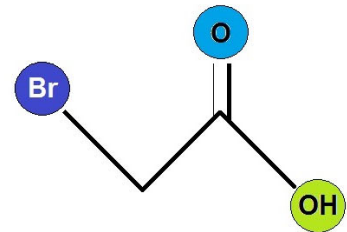
STAGE 2 DISINFECTION BYPRODUCT RULE



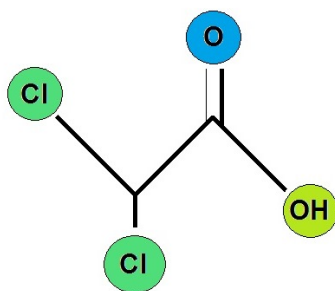
CHLOROACETIC ACID



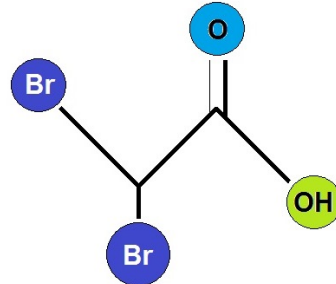
TRICHLOROACETIC ACID



BROMOACETIC ACID



DICHLOROACETIC ACID

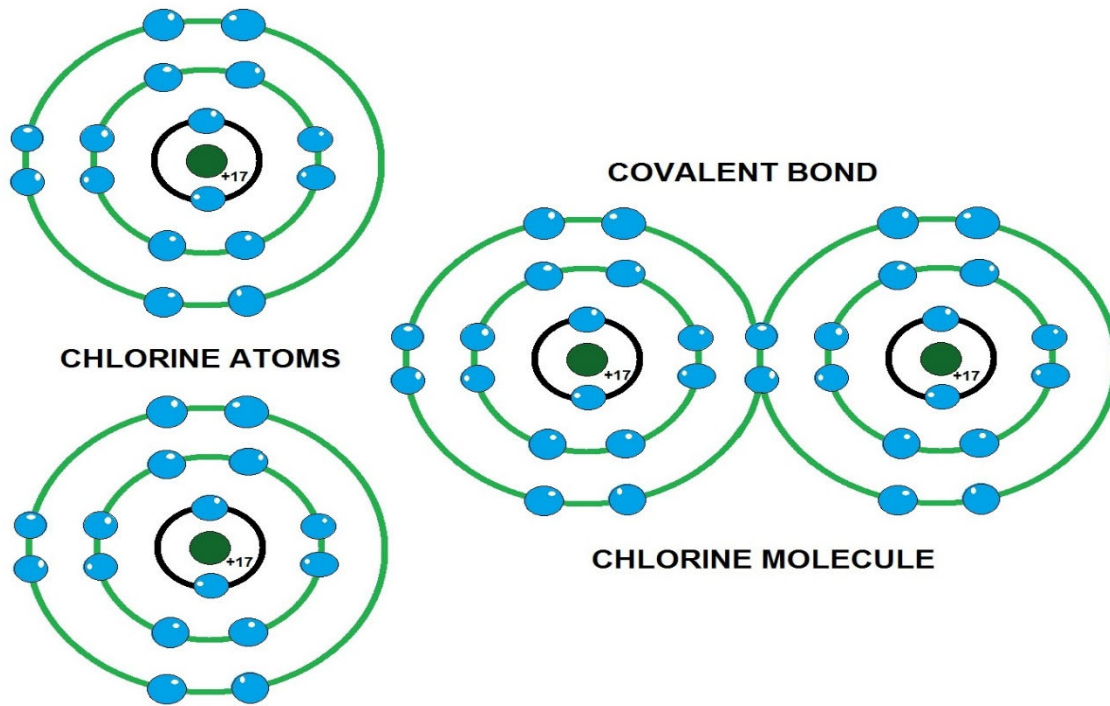


DIBROMOACETIC ACID

HALOACETIC ACIDS ( HAA5 )



## Introduction to DDBP



**CHLORINE ATOMIC STRUCTURE DIAGRAM**

Today, most of our drinking water supplies are free of the microorganisms — viruses, bacteria, and protozoa — that cause serious and life-threatening diseases, such as cholera and typhoid fever. This is largely due to the introduction of water treatment, particularly chlorination, at the turn of the century. Living cells react with chlorine and reduces the free chlorine residual concentration while they die. The organic matter and other substances that are present, convert to chlorinated derivatives, some of which are marginally effective killing agents. Chlorine present as  $\text{Cl}$ ,  $\text{HOCl}$ , and  $\text{OCl}^-$  is called *free available chlorine* and that which is bound but still effective is *combined chlorine*. A particularly important group of compounds with combined chlorine is the chloramines formed by reactions with ammonia.

One especially important feature of disinfection using chlorine is the ease of overdosing to create a "residual" concentration. There is a constant danger that safe water leaving the treatment plant may become contaminated later. There may be breaks in water mains, loss of pressure that permits an inward leak, or plumbing errors. This residual concentration of chlorine provides significant of protection right to the water faucet. With free available chlorine, a typical residual is from 0.1 to 0.5 ppm.

Because chlorinated organic compounds are less effective, a typical residual is 2 ppm for combined chlorine. There will be no chlorine residual unless there is an excess over the amount that reacts with the organic matter present. However, reaction kinetics complicates interpretation of chlorination data. The correct excess is obtained in a method called "*Break Point Chlorination*".

## **Chlorine By-Products**

Chlorination by-products are the chemicals formed when the chlorine used to kill disease-causing microorganisms reacts with naturally occurring organic matter (e.g., decay products of vegetation) in the water. The most common chlorination by-products found in U.S. drinking water supplies are the trihalomethanes (THMs).

### **The Principal Trihalomethanes are:**

Chloroform, bromodichloromethane, chlorodibromomethane, and bromoform. Other less common chlorination by-products include the haloacetic acids and haloacetonitriles.

The amount of THMs formed in drinking water are influenced by a number of factors, including the season and the source of the water. For example, THM concentrations are generally lower in winter than in summer, because concentrations of natural organic matter are lower and less chlorine is required to disinfect at colder temperatures.

THM levels are also low when wells or large lakes are used as the drinking water source, because organic matter concentrations are generally low in these sources. The opposite — high organic matter concentrations and high THM levels — is true when rivers or other surface waters are used as the source of the drinking water.

## **Health Effects**

Laboratory animals exposed to very high levels of THMs have shown increased incidences of cancer. Also, several studies of cancer incidence in human populations have reported associations between long-term exposure to high levels of chlorination by-products and an increased risk of certain types of cancer.

For instance, a recent study conducted in the Great Lakes basin reported an increased risk of bladder and possibly colon cancer in people who drank chlorinated surface water for 35 years or more.

Possible relationships between exposure to high levels of THMs and adverse reproductive effects in humans have also been examined recently. In a California study, pregnant women who consumed large amounts of tap water containing elevated levels of THMs were found to have an increased risk of spontaneous abortion.

The available studies on health effects do not provide conclusive proof of a relationship between exposure to THMs and cancer or reproductive effects, but indicate the need for further research to confirm their results and to assess the potential health effects of chlorination by-products other than THMs.

## Chlorine Disinfectants/Disinfectant By-Products Facts

- Chlorine is a naturally existing element that has been used to disinfect drinking water supplies in America for most of the 20<sup>th</sup> Century.
- Chlorine disinfection has been extremely effective in protecting drinking water resources from bacterial and viral contamination. It has virtually wiped out instances of water-borne diseases like typhoid fever, cholera and dysentery in America and other developed countries.
- Over 200 million Americans currently drink water that has been disinfected.
- The three primary chemical agents used in chlorine disinfection are: free chlorine, chloramine (chlorine and ammonia bonded together) and chlorine dioxide (chlorine and oxygen bonded together).
- Ozone is also used to disinfect water.
- Disinfectants are very active compounds. When added to a water supply, disinfectants not only kill bacteria and viruses, but also react with other chemicals present in the water. These chemicals generally enter the water supply through natural plant and soil breakdown.
- When disinfectants react with other chemicals, new compounds known as disinfectant by-products or "DBPs", are created. DBPs associated with chlorine disinfection include trihalomethanes (THMs), such as chloroform.
- Because chlorination has been used for almost 100 years to disinfect water supplies, approximately 40 percent of the DBPs from chlorination have been identified and researched. Much less is known about the kind of DBPs produced by other disinfectants because of their relatively recent emergence.
- Use of chloramine or chlorine dioxide in chlorine disinfection produces fewer DBPs than chlorine, but each has associated risks. Chloramine is not as strong a disinfectant as chlorine, and disinfection with chlorine dioxide produces its own DBPs.
- Animal research using high concentration of DBPs found increased occurrence of cancer development, although why this occurs has not yet been determined. Research on the relationship between DBPs and cancer and other health risks is ongoing.
- American drinking water has **very low** concentrations of DBPs.
- The U.S. Environmental Protection Agency (USEPA) has **not** been able to link exposure to DBPs at low concentration levels and the health risks associated with high concentration level exposure.
- Since 1984, American drinking water utilities have spent almost \$23 million researching the production of DBPs, the risks posed by them and methods to treat them. These research efforts are ongoing. In addition, the 300 largest drinking water utilities have spent more than \$150 million to conduct the information gathering required by the Information Collection Rule (ICR). The ICR is the largest study to date pertaining to the occurrence of DBPs and associated treatment practices.
- Since 1979, the U.S. Environmental Protection Agency (USEPA), under the authority of the Safe Drinking Water Act, has regulated the acceptable levels of some DBPs. USEPA cites the large population of Americans potentially at-risk from low-level DPB exposure as the impetus for regulation.

- The Safe Drinking Water Act Amendments of 1996 required USEPA to comply with the regulatory timeline it set forth in its initial Disinfectant and Disinfectant-By-Product (DDPB) rule and Interim Enhanced Surface Water Treatment Rule (IESWTR). USEPA proposed both in 1994.

The research on DBPs and their impact on public health continues and serious questions about the actual health risks posed by DBPs still remain.

### **Risks and Benefits of Chlorine**

Current evidence indicates that the benefits of chlorinating our drinking water — reduced incidence of water-borne diseases — are much greater than the risks of health effects from THMs.

Although other disinfectants are available, chlorine continues to be the choice of water treatment experts. When used with modern water filtration practices, chlorine is effective against virtually all infective agents — bacteria, viruses, and protozoa. It is easy to apply, and, most importantly, small amounts of chlorine remain in the water and continue to disinfect throughout the distribution system. This ensures that the water remains free of microbial contamination on its journey from the treatment plant to the consumer's tap.

A number of cities use ozone to disinfect their source water and to reduce THM formation. Although ozone is a highly effective disinfectant, it breaks down quickly, so that small amounts of chlorine or other disinfectants must be added to the water to ensure continued disinfection as the water is piped to the consumer's tap.

Modifying water treatment facilities to use ozone can be expensive, and ozone treatment can create other undesirable by-products that may be harmful to health if they are not controlled (e.g., bromate).

Examples of other disinfectants include chloramines and chlorine dioxide. Chloramines are weaker disinfectants than chlorine, especially against viruses and protozoa; however, they are very persistent and, as such, can be useful for preventing re-growth of microbial pathogens in drinking water distribution systems.

Chlorine dioxide can be an effective disinfectant, but it forms chlorate and chlorite, compounds whose toxicity has not yet been fully determined. Assessments of the health risks from these and other chlorine-based disinfectants and chlorination by-products are currently under way.

In general, the preferred method of controlling chlorination by-products is removal of the naturally occurring organic matter from the source water so it cannot react with the chlorine to form by-products. THM levels may also be reduced through the replacement of chlorine with alternative disinfectants.

A third option is removal of the precursors by adsorption on activated carbon beds. It is extremely important that water treatment plants ensure that methods used to control chlorination by-products do not compromise the effectiveness of water disinfection.

## Disinfection Rule

In the past 25 years, the Safe Drinking Water Act (SDWA) has been highly effective in protecting public health and has also evolved to respond to new and emerging threats to safe drinking water. Disinfection of drinking water is one of the major public health advances in the 20th century. One hundred years ago, typhoid and cholera epidemics were common through American cities; disinfection was a major factor in reducing these epidemics.

However, the disinfectants themselves can react with naturally-occurring materials in the water to form unintended byproducts which may pose health risks. In addition, in the past ten years, we have learned that there are specific microbial pathogens, such as *Cryptosporidium*, which can cause illness and is resistant to traditional disinfection practices.

Chlorine is the most widely used water disinfectant due to its effectiveness and cost. Using chlorine as a drinking water disinfectant has prevented millions of water borne diseases, such as typhoid, cholera, dysentery, and diarrhea. Most states require community water systems to use chlorination. However, research shows that chlorine has side effects. It reacts with organic matter present in water and forms a series of compounds that have been linked to cancer in animals.

**These compounds are called disinfection by-products (DBPs). All disinfectants form DBPs in one of two reactions:**

- (1) chlorine and chlorine-based compounds (halogens) react with organics in water causing the chlorine atom to substitute other atoms resulting in halogenated by-products and
- (2) oxidation reactions, where chlorine oxidizes compounds present in water. Secondary by-products are also formed when multiple disinfectants are used.

All living organisms have carbon as an essential element in their cells. When trees shed their leaves, they start decomposing and are ultimately broken down by bacteria into carbon-containing compounds.

Similarly, dead animals on land and fish and other aquatic life decompose and disintegrate into compounds that contain carbon as an essential element. Hence, all surface water and groundwater contain varying amounts of carbon-containing compounds called organic matter (primarily humic and fulvic acids).

The EPA Surface Water Treatment Rule (SWTR) requires systems using public water supplies from either surface water or groundwater under the direct influence of surface water to disinfect.

Also, since some disinfectants produce chemical by-products, the dual objective of disinfection is to provide the required level of organism destruction and remain within the maximum contaminant level (MCL) for the SWTR disinfection set by EPA. At this time, an MCL is set for only Total Trihalomethanes, and proposed for additional disinfection byproducts.

## **What are the microbial/disinfection byproducts (MDBP) rules and which ones apply to me?**

The MDBP requirements have been in place for close to 30 years and include the following federal rules:

- Total Trihalomethanes monitoring and MCL, promulgated Nov 1979
- Surface Water Treatment Rule, promulgated June 1989
- Interim Enhanced Surface Water Treatment Rule and Stage 1 Disinfectants / Disinfection Byproducts Rule, promulgated Dec 1998
- Filter Backwash Rule, promulgated June 2001
- Long Term 1 Enhanced Surface Water Treatment Rule, promulgated Jan 2002
- Long Term 2 Enhanced Surface Water Treatment Rule and Stage 2 Disinfectants / Disinfection Byproducts Rule, promulgated Jan 2006
- Groundwater Rule, promulgated Nov 2006

The Disinfectants and Disinfection Byproducts (DBP) rules apply to all community and non-community water systems using a disinfectant such as chlorine, chloramines, ozone and chlorine dioxide.

Compliance with the Stage 1 DBP requirements began in 2000. The Stage 2 DBP requirements began in 2006 with the Initial Distribution System Evaluation (IDSE). Compliance monitoring for the Stage 2 DBP began in April 2012. See phased compliance schedule dependent on system population below.

The Long Term 2 Enhanced Surface Water Treatment Rule (LT2) rule applies to all water systems using surface water, groundwater under the influence of a surface water, as well as groundwater/surface water blends.

The LT2 requirements began in 2006 with the characterization of raw water *Cryptosporidium* and *E.coli* levels. Systems serving <10,000 monitor for *E.coli* only every two weeks for one year. Compliance with the LT2 requirements began in April 2013.

The Groundwater Rule (GWR) applies to all public water systems using groundwater. The GWR requirements begin in March 2009 with 6-months investigative monitoring (IM) for source water *E.coli*, for systems currently applying disinfection only. All other requirements for the GWR began back in Dec 2009.

Amendments to the SDWA in 1996 require EPA to develop rules to balance the risks between microbial pathogens and disinfection byproducts (DBPs). It is important to strengthen protection against microbial contaminants, especially *Cryptosporidium*, and at the same time, reduce potential health risks of DBPs.

The Stage 1 Disinfectants and Disinfection Byproducts Rule and Interim Enhanced Surface Water Treatment Rule, announced in December 1998, are the first of a set of rules under the 1996 SDWA Amendments.

## Public Health Concerns

While disinfectants are effective in controlling many microorganisms, they react with natural organic and inorganic matter in source water and distribution systems to form DBPs. Results from toxicology studies have shown several DBPs (e.g., bromodichloromethane, bromoform, chloroform, dichloroacetic acid, and bromate) to be carcinogenic in laboratory animals. Other DBPs (e.g., chlorite, bromodichloromethane, and certain haloacetic acids) have also been shown to cause adverse reproductive or developmental effects in laboratory animals.

Several epidemiology studies have suggested a weak association between certain cancers (e.g., bladder) or reproductive and developmental effects, and exposure to chlorinated surface water. More than 200 million people consume water that has been disinfected. Because of the large population exposed, health risks associated with DBPs, even if small, need to be taken seriously.

### Who Must Comply With The Rule?

The Stage 1 Disinfectants and Disinfection Byproducts Rule applies to all community and nontransient non-community water systems that treat their water with a chemical disinfectant for either primary or residual treatment.

### What Does The Rule Require?

The Stage 1 Disinfectant and Disinfection Byproduct Rule updates and supersedes the 1979 regulations for total trihalomethanes. In addition, it will reduce exposure to three disinfectants and many disinfection byproducts.

The rule establishes maximum residual disinfectant level goals (MRDLGs) and maximum residual disinfectant levels (MRDLs) for three chemical disinfectants - chlorine, chloramine and chlorine dioxide (see Table 1). It also establishes maximum contaminant level goals (MCLGs) and maximum contaminant levels (MCLs) for total trihalomethanes, haloacetic acids, chlorite and bromate (see Table 1).

**Table 1**  
**MRDLGs, MRDLs, MCLGs and MCLs for Stage 1 Disinfectants**  
**and Disinfection Byproducts Rule**

DISINFECTANT RESIDUAL	MRDLG (mg/L)	MRDL (mg/L)	COMPLIANCE BASED ON
<b>Chlorine</b>	<b>4 (as Cl<sub>2</sub>)</b>	<b>4.0 (as Cl<sub>2</sub>)</b>	<b>Annual Average</b>
<b>Chloramine</b>	<b>4 (as Cl<sub>2</sub>)</b>	<b>4.0 (as Cl<sub>2</sub>)</b>	<b>Annual Average</b>
<b>Chlorine Dioxide</b>	<b>0.8 (as ClO<sub>2</sub>)</b>	<b>0.8 (as ClO<sub>2</sub>)</b>	<b>Daily Samples</b>
DISINFECTION BYPRODUCTS	MCLG (mg/L)	MCL (mg/L)	COMPLIANCE BASED ON
<b>Total trihalomethanes (TTHM)<sup>1</sup></b>	<b>N/A</b>	<b>0.080</b>	<b>Annual Average</b>
- Chloroform	<b>***</b>		
- Bromodichloromethane	<b>0</b>		
- Dibromochloromethane	<b>0.06</b>		
- Bromoform	<b>0</b>		
<b>Haloacetic acids (five) (HAA5)<sup>2</sup></b>	<b>N/A</b>	<b>0.060</b>	<b>Annual Average</b>

- Dichloroacetic acid	0		
- Trichloroacetic acid	0.3		
<b>Chlorite</b>	<b>0.8</b>	<b>1.0</b>	<b>Monthly Average</b>
<b>Bromate</b>	<b>0</b>	<b>0.010</b>	<b>Annual Average</b>

N/A - Not applicable because there are individual MCLGs for TTHMs or HAAs

1-Total trihalomethanes is the sum of the concentrations of chloroform, bromodichloromethane, dibromochloromethane, and bromoform.

2-Haloacetic acids (five) is the sum of the concentrations of mono-, di-, and trichloroacetic acids and mono- and dibromoacetic acids.

\*\*\* EPA removed the zero MCLG for chloroform from its National Primary Drinking Water Regulations, effective May 30, 2000, in accordance with an order of the U.S. Court of Appeals for the District of Columbia Circuit.

Water systems that use surface water or ground water under the direct influence of surface water and use conventional filtration treatment are required to remove specified percentages of organic materials, measured as total organic carbon (TOC) that may react with disinfectants to form DBPs (See Table 2). Removal will be achieved through a treatment technique (enhanced coagulation or enhanced softening) unless a system meets alternative criteria.

**Table 2**

**Required Removal of Total Organic Carbon by Enhanced Coagulation and Enhanced Softening for Subpart H Systems Using Conventional Treatment<sup>1</sup>**

Source Water TOC (mg/L)	Source Water Alkalinity (mg/L as CaCO <sub>3</sub> )		
	0-60	>60-120	>120 <sub>2</sub>
>2.0-4.0	35.0%	25.0%	15.0%
>4.0-8.0	45.0%	35.0%	25.0%
>8.0	50.0%	40.0%	30.0%

<sup>1</sup>Systems meeting at least one of the alternative compliance criteria in the rule are not required to meet the removals in this table.

<sup>2</sup>Systems practicing softening must meet the TOC removal requirements in the last column to the right.

**What Are The Compliance Deadlines?**

Large surface water systems are required to comply with the Stage 1 Disinfectants and Disinfection Byproducts Rule and Interim Enhanced Surface Water Treatment Rule by January 2002. Ground water systems and small surface water systems must comply with the Stage 1 Disinfectants and Disinfection Byproducts Rule by January 2004.

**What Are The Costs And Benefits Of The Rule?**

EPA estimates that implementation of the Stage 1 Disinfectants and Disinfection Byproducts Rule will result in:

- As many as 140 million people receiving increased protection from DBPs.
- 24 percent national average reduction in TTHM levels.
- Reduction in exposure to the major DBPs from use of ozone (bromate) and chlorine dioxide (chlorite).

The total annual cost of the rule is about \$700 million. EPA believes that the benefits exceed the costs of the Stage 1 Disinfectants and Disinfection Byproducts Rule. An estimated 116 million households are affected by the Stage 1 Disinfectants and Disinfection Byproducts Rule.



EPA estimates that 95 percent of the households will incur additional costs of less than \$1 per month on their water bills.

An additional four percent will pay between \$1 and \$10 per month more, and one percent are expected to incur increased water bills of \$10 to \$33 per month, if they choose to install treatment. However, many of these systems may chose less costly non-treatment options, such as consolidation. The majority of households incurring the highest costs are small systems serving less than 10,000 people that have never been regulated for DBPs.

## **Stage 2 DBP Rule Federal Register Notices**

### **Balancing DBP and Microbial Risks**

Continuing evidence of waterborne disease occurrence suggests that microbial risks should receive a much higher level of attention than disinfection byproducts. For this reason, The American Academy of Microbiology (Ford and Colwell, 1996) has recommended, the health risks posed by microbial pathogens should be placed as the highest priority in water treatment to protect public health. A report published by the International Society of Regulatory Toxicology and Pharmacology (Coulston and Kolbye, 1994) stated “The reduction in mortality due to waterborne infectious diseases, attributed largely to chlorination of potable water supplies, appears to outweigh any theoretical cancer risks (which may be as low as zero) posed by the minute quantities of chlorinated organic chemicals reported in drinking waters disinfected with chlorine.”

### **The IPCS (IPCS 2000, p. 375) reached similar conclusions:**

Disinfection is unquestionably the most important step in the treatment of water for drinking water supplies. The microbial quality of drinking water should not be compromised because of concern over the potential long-term effects of disinfectants and DBPs. The risk of illness and death resulting from exposure to pathogens in drinking water is very much greater than the risks from disinfectants and DBPs.

### **Controlling Disinfection Byproducts**

Treatment techniques are available that provide water suppliers the opportunity to maximize potable water safety and quality while minimizing the risk of DBP risks. Generally, the best approach to reduce DBP formation is to remove natural organic matter precursors prior to disinfection. EPA has published a guidance document for water system operators entitled, Controlling Disinfection byproducts and Microbial Contaminants in Drinking Water (EPA, 2001).

### **The EPA guidance discusses three processes to effectively remove natural organic matter prior to disinfection:**

#### **1. Coagulation and Clarification**

Most treatment plants optimize their coagulation process for turbidity (particle) removal. However, coagulation processes can also be optimized for natural organic matter removal with higher doses of inorganic coagulants (such as alum or iron salts), and optimization of pH.

#### **2. Absorption**

Activated carbon can be used to absorb soluble organics that react with disinfectants to form byproducts.

### **3. Membrane Technology**

Membranes, used historically to desalinate brackish waters, have also demonstrated excellent removal of natural organic matter.

Membrane processes use hydraulic pressure to force water through a semi-permeable membrane that rejects most contaminants. Variations of this technology include reverse osmosis (RO), nanofiltration (low pressure RO), and microfiltration (comparable to conventional sand filtration).

Other conventional methods of reducing DBP formation include changing the point of chlorination and using chloramines for residual disinfection. EPA predicts that most water systems will be able to achieve compliance with new DBP regulations through the use of one or more of these relatively low cost methods (EPA, 1998).

Water system managers may also consider switching from chlorine to alternative disinfectants to reduce formation of THMs and HAAs.

However, all chemical disinfectants form some DBPs. Much less is known about the byproducts of these alternatives than is known about chlorination byproducts. Furthermore, each disinfection method has other distinct advantages and disadvantages.

## Disinfection Byproduct Research and Regulations Summary

Drinking water chlorination has contributed to a dramatic decline in waterborne disease rates and increased life expectancy in the United States. Largely because of this success, many Americans take it for granted that their tap water will be free of disease-causing organisms.

In recent years, regulators and the public have focused greater attention on potential health risks from chemical contaminants in drinking water. One such concern relates to disinfection byproducts (DBPs), chemical compounds formed unintentionally when chlorine and other disinfectants react with certain organic matter in water.

In the early 1970s, EPA scientists first determined that drinking water chlorination could form a group of byproducts known as trihalomethanes (THMs), including chloroform. Concerned that these chemicals may be carcinogenic to humans, EPA set the first regulatory limits for THMs in 1979. Since that time, a wealth of research has improved our understanding of how DBPs are formed, their potential health risks, and how they can be controlled. It is now recognized that all chemical disinfectants form some potentially harmful byproducts. The byproducts of chlorine disinfection are by far the most thoroughly studied.

While the available evidence does not prove that DBPs in drinking water cause adverse health effects in humans, high levels of these chemicals are certainly undesirable. Cost-effective methods to reduce DBP formations are available and should be adopted where possible.

The health risks from these byproducts at the levels at which they occur in drinking water are extremely small in comparison with the risks associated with inadequate disinfection. Thus, it is important that disinfection not be compromised in attempting to control such byproducts.

Recent EPA regulations have further limited THMs and other DBPs in drinking water. Most water systems are meeting these new standards by controlling the amount of natural organic matter prior to disinfection, while ensuring that microbial protection remains the top priority.

Based largely on these animal data, EPA considers individual THMs and HAAs to be either possible or probable human carcinogens, although any risk from the low levels found in drinking water would be slight. After reviewing the full body of toxicology studies, the IPCS concluded, "None of the chlorination byproducts studied to date is a potent carcinogen at concentrations normally found in drinking water" (IPCS 2000, p. 376).

Some epidemiology studies have reported an association between human exposure to DBPs and elevated cancer risks, while other studies have found no association. EPA evaluated the existing cancer epidemiology studies and found that only for bladder cancer were associations with chlorinated water somewhat consistent.

Even in these studies, cancer risks were not strongly correlated to measured THM levels, indicating that other factors cannot be ruled out (Craun et al., 2001). EPA has concluded, "The present epidemiologic data do not support a causal relationship between exposure to chlorinated drinking water and development of cancer at this time" (EPA 1998). The IPCS reached a similar conclusion in 2000, noting that a causal relationship between DBPs and increased cancer remains an open question (IPCS 2000).

### **Balancing DBP and Microbial Risks**

Continuing evidence of waterborne disease occurrence suggests that microbial risks should receive a much higher level of attention than disinfection byproducts. For this reason, The American Academy of Microbiology (Ford and Colwell, 1996) has recommended, the health risks posed by microbial pathogens should be placed as the highest priority in water treatment to protect public health. A report published by the International Society of Regulatory Toxicology and Pharmacology (Coulston and Kolbye, 1994) stated “The reduction in mortality due to waterborne infectious diseases, attributed largely to chlorination of potable water supplies, appears to outweigh any theoretical cancer risks (which may be as low as zero) posed by the minute quantities of chlorinated organic chemicals reported in drinking waters disinfected with chlorine.”

### **The IPCS (IPCS 2000, p. 375) reached similar conclusions:**

Disinfection is unquestionably the most important step in the treatment of water for drinking water supplies. The microbial quality of drinking water should not be compromised because of concern over the potential long-term effects of disinfectants and DBPs. The risk of illness and death resulting from exposure to pathogens in drinking water is very much greater than the risks from disinfectants and DBPs.

### **Controlling Disinfection Byproducts**

Treatment techniques are available that provide water suppliers the opportunity to maximize potable water safety and quality while minimizing the risk of DBP risks. Generally, the best approach to reduce DBP formation is to remove natural organic matter precursors prior to disinfection. EPA has published a guidance document for water system operators entitled, Controlling Disinfection byproducts and Microbial Contaminants in Drinking Water (EPA, 2001).

### **The EPA guidance discusses three processes to effectively remove natural organic matter prior to disinfection:**

#### **1. Coagulation and Clarification**

Most treatment plants optimize their coagulation process for turbidity (particle) removal. However, coagulation processes can also be optimized for natural organic matter removal with higher doses of inorganic coagulants (such as alum or iron salts), and optimization of pH.

#### **2. Absorption**

Activated carbon can be used to absorb soluble organics that react with disinfectants to form byproducts.

#### **3. Membrane Technology**

Membranes, used historically to desalinate brackish waters, have also demonstrated excellent removal of natural organic matter. Membrane processes use hydraulic pressure to force water through a semi-permeable membrane that rejects most contaminants. Variations of this technology include reverse osmosis (RO), nanofiltration (low pressure RO), and microfiltration (comparable to conventional sand filtration).

Other conventional methods of reducing DBP formation include changing the point of chlorination and using chloramines for residual disinfection. EPA predicted that most water systems will be able to achieve compliance with new DBP regulations through the use of one or more of these relatively low cost methods (EPA, 1998). Water system managers may also consider switching from chlorine to alternative disinfectants to reduce formation of THMs and HAAs.

## Disinfection Rules Post Quiz

### ***Hyperlink to Assignment...***

<http://www.abctlc.com/downloads/PDF/Chlorination202Ass.pdf>

1. The most common chlorination by-products found in U.S. drinking water supplies are?
2. What rule specifies treatment criteria to assure that these performance requirements are met; they include turbidity limits, disinfectant residual, and disinfectant contact time conditions?
3. What rule was established to maintain control of pathogens while systems lower disinfection byproduct levels to comply with the Stage 1 Disinfectants/Disinfection Byproducts Rule and to control *Cryptosporidium*?
4. Turbidity is an indicator of the physical removal of particulates, including pathogens.  
A. True      B. False
5. What rule improves physical removal of *Cryptosporidium*, and to maintain control of pathogens?
6. What is the annual average for Bromate that was established in the Stage 1 Disinfectants/Disinfection Byproducts Rule?
7. According to the Stage 1 Disinfectants/Disinfection Byproducts Rule, what is the monthly average level of chlorite in drinking water.
8. What terms mean that chlorine is present as Cl, HOCl, and OCl<sup>-</sup> is called \_\_\_\_\_, and that which is bound but still effective is \_\_\_\_\_.
9. Chloramines are formed by reactions with?
10. The Principal Trihalomethanes are: Chloroform, bromodichloromethane, chlorodibromomethane, and bromoform.  
A. True      B. False

11. THM concentrations are generally higher in winter than in summer, because concentrations of natural organic matter are greater and more chlorine is required to disinfect at colder temperatures.

A. True      B. False

12. The available studies on health effects do not provide conclusive proof of a relationship between exposure to THMs and cancer or reproductive effects, but indicate the need for further research to confirm their results and to assess the potential health effects of chlorination by-products other than THMs.

A. True      B. False

13. Many cities utilize the use ozone to disinfect their source water and to reduce formation of this parameter?

14. Regulators and the general public have focused greater attention on potential health risks from chemical contaminants in drinking water. One such concern relates to disinfection byproducts (DBPs), chemical compounds formed unintentionally when chlorine and other disinfectants react with certain inorganic matter in water.

A. True      B. False

15. Water system managers may also consider switching from chlorine to alternative disinfectants to reduce formation of THMs and HAAs.

A. True      B. False

16. Much less is known about the byproducts of these alternatives than is known about chlorination byproducts. Furthermore, each disinfection method has other distinct advantages and disadvantages.

A. True      B. False

17. Current evidence indicates that the benefits of chlorinating our drinking water — reduced incidence of \_\_\_\_\_ — are much greater than the risks of health effects from THMs.

18. A number of cities use ozone to disinfect their source water and to reduce \_\_\_\_\_.

## Chapter 2 - Waterborne Pathogens

**Section Focus:** You will learn the basics of waterborne diseases and proper identification. At the end of this section, you will be able to describe commonly found waterborne organisms and diseases. There is a post quiz at the end of this section to review your comprehension and a final examination in the Assignment for your contact hours.

**Scope/Background:** Water/wastewater treatment operators are committed to keeping the public water supply free of potential risks that lead to waterborne illnesses; investigating transmission of pathogens that may result in such illnesses; and implementing strategies that will reduce the spread of further sickness. Much of this work is done with chlorine as the primary disinfectant agent. The use of water chlorination to disinfect public water supplies, which began in the early 1900s, has had major impacts on the incidence of waterborne disease in the U.S. and worldwide.



Cryptosporidium

We will go into great detail on this concern and others in this chapter.

### The Reason for Disinfection

Bacteria, viruses and protozoan that cause disease are known as pathogens. Most pathogens are generally associated with diseases that cause intestinal illness and affect people in a relatively short amount of time, generally a few days to two weeks. They can cause illness through exposure to small quantities of contaminated water or food or from direct contact with infected people or animals.

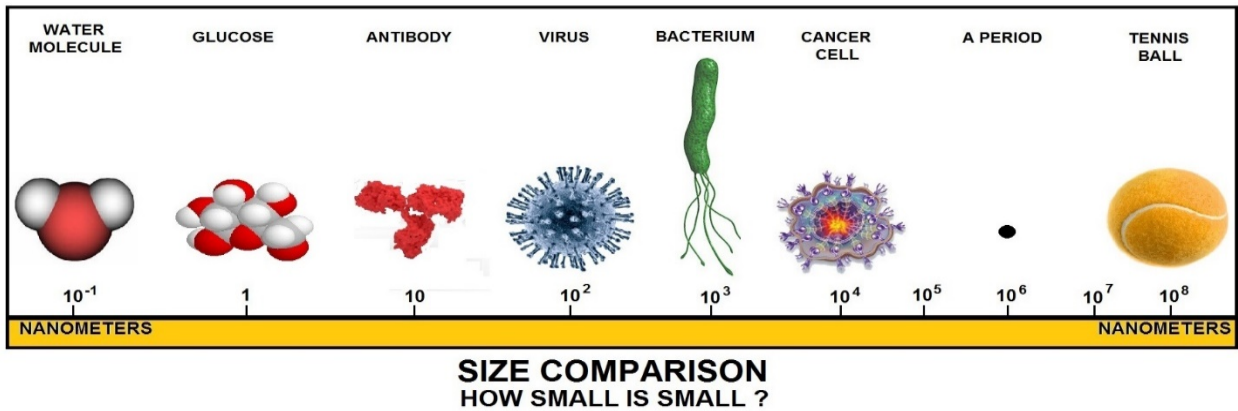
Waterborne diseases are those in which the consumption of or exposure to water and/or water systems lead to illness. Common waterborne diseases include, but are not limited to, giardiasis, cryptosporidiosis, vibriosis, shigellosis, and Legionellosis. Gastrointestinal, respiratory, and wound infections are typical signs and symptoms of these diseases. These diseases implicate compromised water sanitation and safety that have the potential to affect a large number of people.

# Microbiology Introduction

Microorganisms of greatest significance to water professionals can be classified into four groups:

1. Bacteria - Prokaryotes
2. Protozoans
3. Metazoans
4. Viruses

Each of these groups plays a key role in the complex world of wastewater biology.



## Bacteria Introduction

Bacteria are highly designed creatures formed in a variety of shapes. The simplest shape is a round sphere or ball.

Bacteria formed like this are called cocci (singular coccus). The next simplest shape is cylindrical.

Cylindrical bacteria are called rods (singular rod). Some bacteria are basically rods but instead of being straight they are twisted, bent or curved, sometimes in a spiral. These bacteria are called spirilla (singular spirillum). Spirochaetes are tightly coiled up bacteria.



## Organisms Descriptors and Meanings Chart

Description	Meaning
Aerobic	With air
Anaerobic	Without air
Auto	Self (Inorganic carbon)
Facultative	With air or without air
Hetero	Other (Organic carbon)
Troph	Feed or nourish
Photo	Light
Chemo	Chemical
Organo	Organic
Litho	Rock



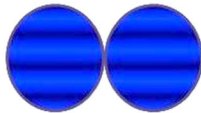
**Coccus**



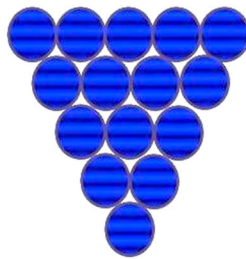
**Bacillus**



**Spirillum**



**Diplo-**



**Staphylo-**

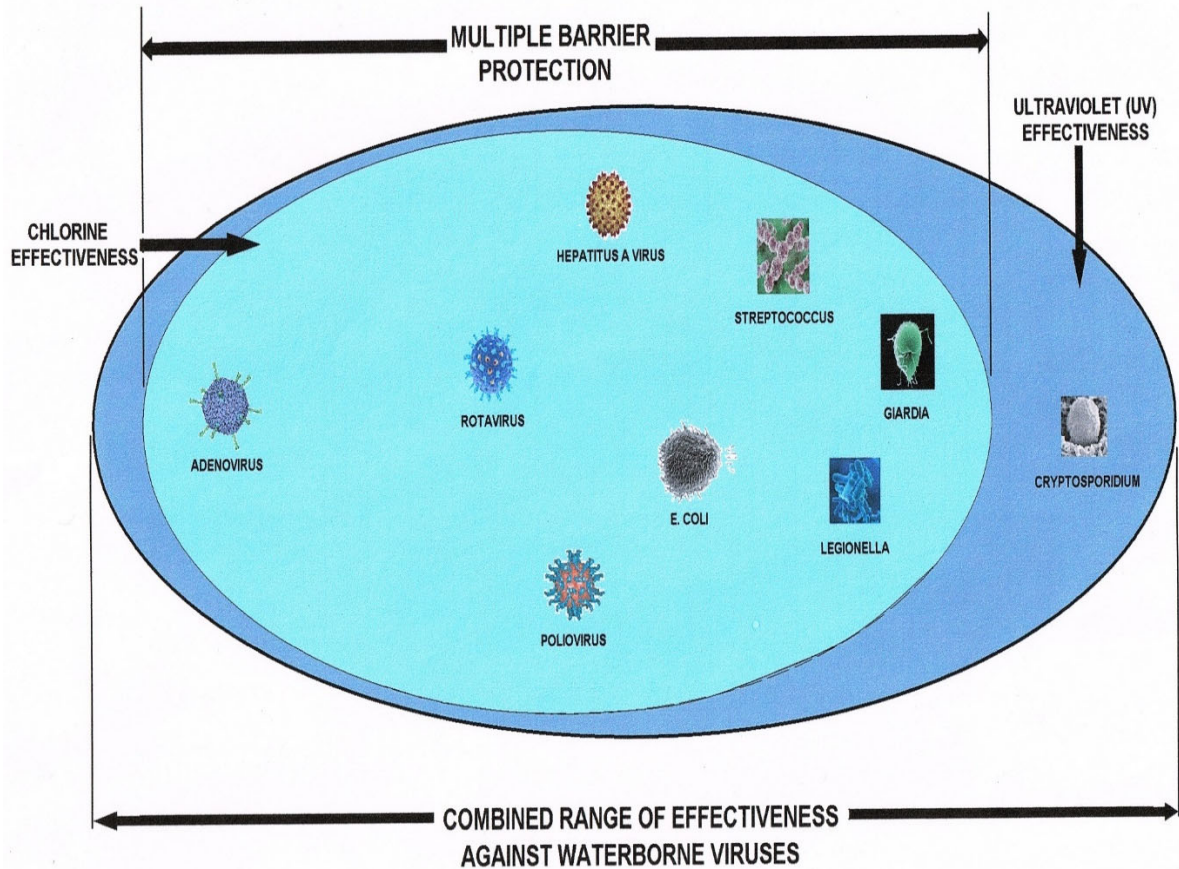


**Strepto-**

### BASIC BACTERIA SHAPES DIAGRAM

#### Bacteria Biofilm or Colonies

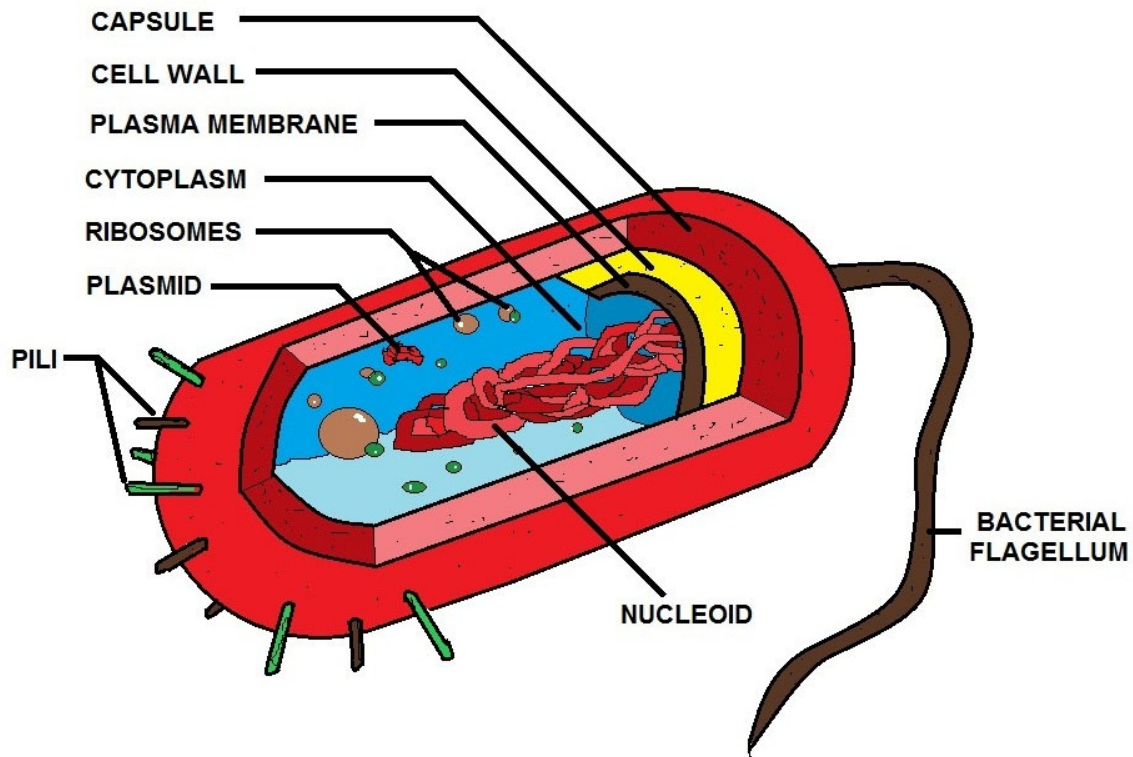
Bacteria tend to live together in clumps, chains or planes. When they live in chains, one after the other, they are called filamentous bacteria - these often have long thin cells. When they tend to collect in a plane or a thin layer over the surface of an object, they are called a biofilm. Many bacteria exist as a biofilm and the study of biofilms is very important. Biofilm bacteria secrete sticky substances that form a sort of gel in which they live. The plaque on your teeth that causes tooth decay is a biofilm.



### Commonly Used Water Disinfectants

Contaminant	MRDL <sup>1</sup> (mg/L) <sup>2</sup>	MRDL <sup>1</sup> (mg/L) <sup>2</sup>	Potential Health Effects from Ingestion of Water	Sources of Contaminant	Drinking Water
Chloramines (as Cl <sub>2</sub> )	MRDLG=4 <sup>1</sup>	MRDL=4.0 <sup>1</sup>	Eye/nose irritation; stomach discomfort, anemia	Water additive used to control microbes	
Chlorine (as Cl <sub>2</sub> )	MRDLG=4 <sup>1</sup>	MRDL=4.0 <sup>1</sup>	Eye/nose irritation; stomach discomfort	Water additive used to control microbes	
Chlorine dioxide (as ClO <sub>2</sub> )	MRDLG=0.8 <sup>1</sup>	MRDL=0.8 <sup>1</sup>	Anemia; infants & young children: nervous system effects	Water additive used to control microbes	

## Bacteria Diagram



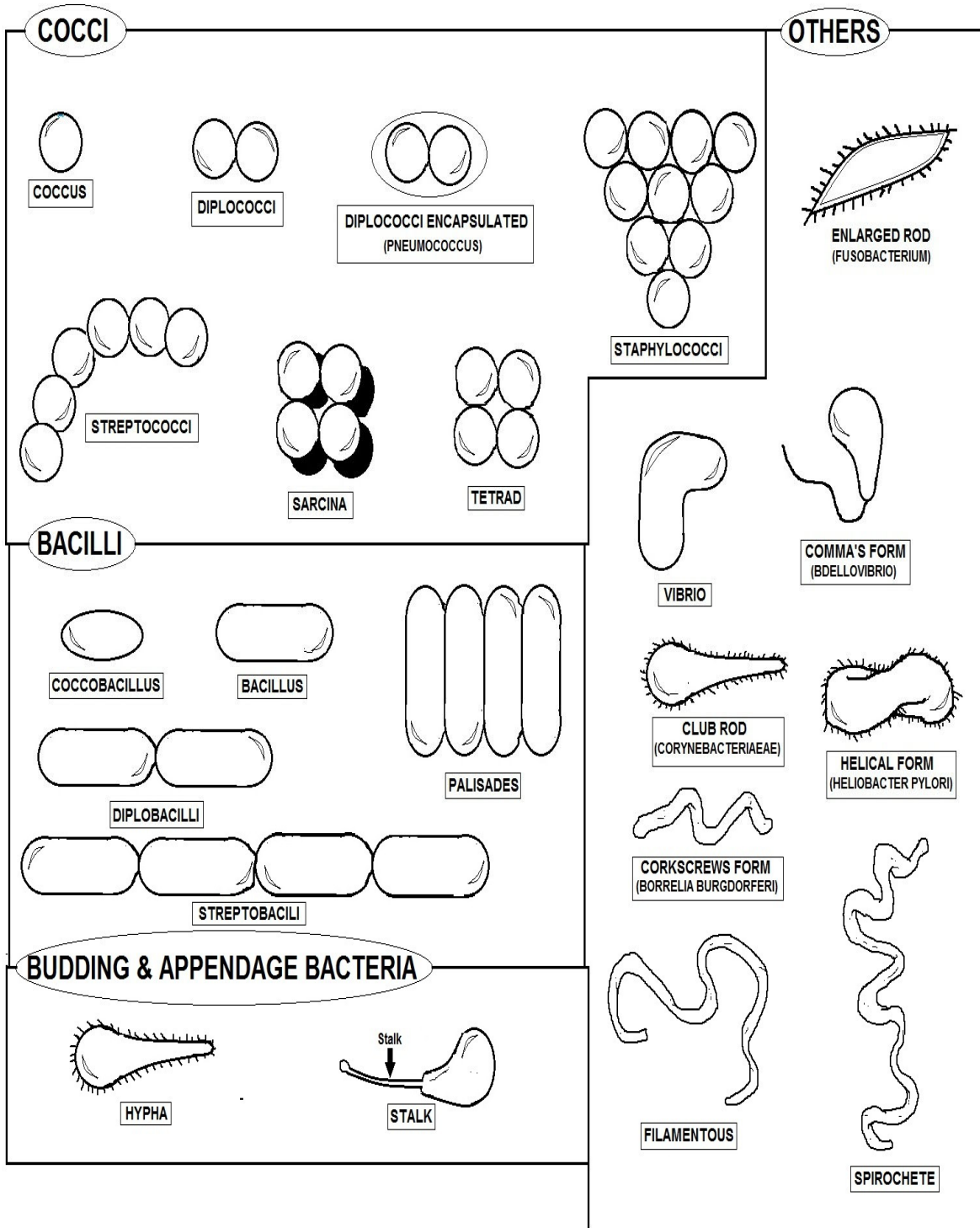
### PROKARYOTIC CELL

Above is a typical bacterial cell has a rigid outer coating that gives them structure and maintains their shape. This is the cell wall. Bacteria also have an inner, flexible membrane called the *periplasmic membrane* or *cell membrane*. This dual-layered covering has been compared to a balloon inside a box.

The cell membrane is very important because it controls the intake of food and other nutrients and discharge of waste products. It keeps "in" what needs to be inside (e.g., enzymes, nutrients, and food) and keeps "out" what should be outside (e.g., excess water). The box is the cell wall. The cell wall provides the structural support and maintains the shape of the cell.

Much of the cellular contents are large protein molecules, known as enzymes, which are manufactured by the cell. Other cellular contents may include granules of polyphosphate, sulfur, or stored organic material.

Bacteria are somewhat predictable and, at a basic level, can be compared to miniature combustion engines. For an engine to function, it requires both a fuel and oxygen source. The oxygen sources is used to chemically burn fuel to release energy. The technically correct term for this process is oxidation. The byproducts of combustion when burning organic fuel with oxygen are carbon dioxide (CO<sub>2</sub>) and water (H<sub>2</sub>O).



## BACTERIA SHAPES

## Microbiological Contaminants

The sources of drinking water include rivers, lakes, streams, ponds, reservoirs, springs, and wells. As water travels over the surface of the land or through the ground, it dissolves naturally occurring minerals and in some cases, radioactive material, and can pick up substances resulting from the presence of animals or human activity.

### **Contaminants that may be present in sources of drinking water include:**

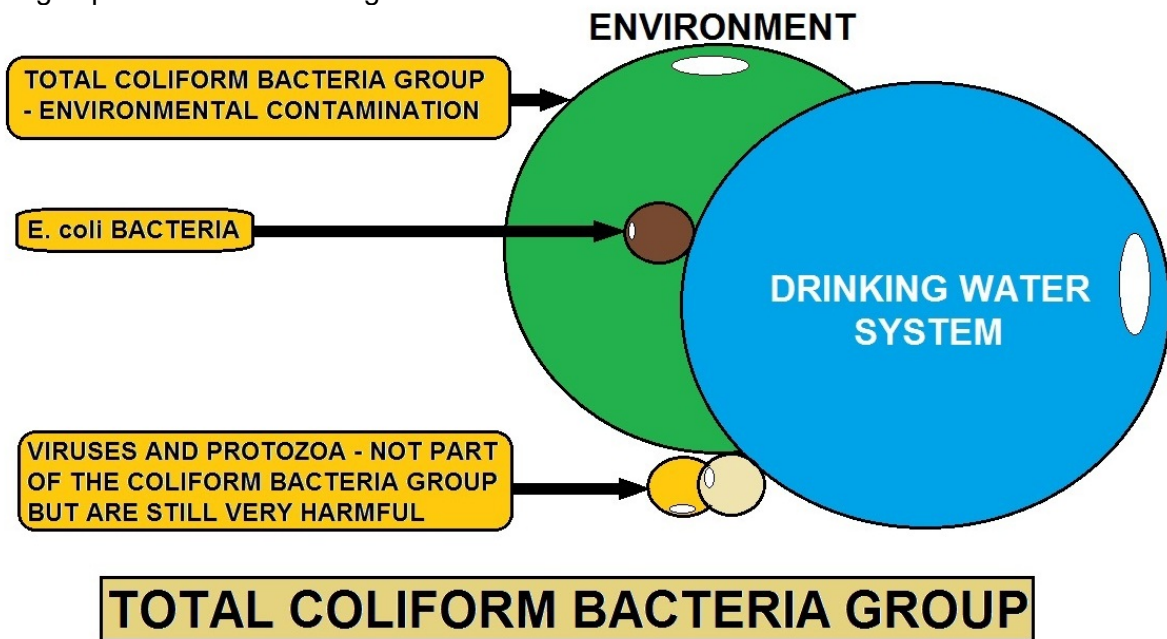
**Microbial contaminants**, such as viruses and bacteria, which may come from sewage treatment plants, septic systems, agricultural livestock operations and wildlife;

**Inorganic contaminants**, such as salts and metals, which can be naturally occurring or result from urban stormwater runoff, industrial or domestic wastewater discharges, oil and gas production, mining or farming;

**Pesticides and herbicides**, which may come from a variety of sources such as agriculture, urban stormwater run-off, and residential uses;

**Organic chemical contaminants**, including synthetic and volatile organic chemicals, which are by-products of industrial processes and petroleum production, and can also come from gas stations, urban stormwater run-off, and septic systems;

**Radioactive contaminants**, which can be naturally occurring or be the result of oil and gas production and mining activities.



### **Background**

Coliform bacteria and chlorine residual are the only routine sampling and monitoring requirements for small ground water systems with chlorination. The coliform bacteriological sampling is governed by the Total Coliform Rule (TCR) of the SDWA. Although there is presently no requirement for chlorination of groundwater systems under the SDWA, State regulations require chlorine residual monitoring of those systems that do chlorinate the water.

## **TCR**

The TCR requires all Public Water Systems (**PWS**) to monitor their distribution system for coliform bacteria according to the written sample sitting plan for that system. The sample sitting plan identifies sampling frequency and locations throughout the distribution system that are selected to be representative of conditions in the entire system.

Coliform contamination can occur anywhere in the system, possibly due to problems such as; low pressure conditions, line breaks, or well contamination, and therefore routine monitoring is required. A copy of the sample sitting plan for the system should be kept on file and accessible to all who are involved in the sampling for the water system.

### **Number of Monthly Samples**

The number of samples to be collected monthly depends on the size of the system. The TCR specifies the minimum number of coliform samples collected, but it may be necessary to take more than the minimum number in order to provide adequate monitoring.

This is especially true if the system consists of multiple sources, pressure zones, booster pumps, long transmission lines, or extensive distribution system piping. Since timely detection of coliform contamination is the purpose of the sample-sitting plan, sample sites should be selected to represent the varying conditions that exist in the distribution system. The sample sitting plan should be updated as changes are made in the water system, especially the distribution system.

### **Sampling Procedures**

The sample-sitting plan must be followed and all operating staff must be clear on how to follow the sampling plan. In order to properly implement the sample-sitting plan, staff must be aware of how often sampling must be done, the proper procedures and sampling containers to be used for collecting the samples, and the proper procedures for identification, storage and transport of the samples to an approved laboratory. In addition, proper procedures must be followed for repeat sampling whenever a routine sample result is positive for total coliform.

### **Routine Sampling Requirements**

Total coliform samples must be collected by PWSs at sites which are representative of water quality throughout the distribution system according to a written sample sitting plan subject to state review and revision.

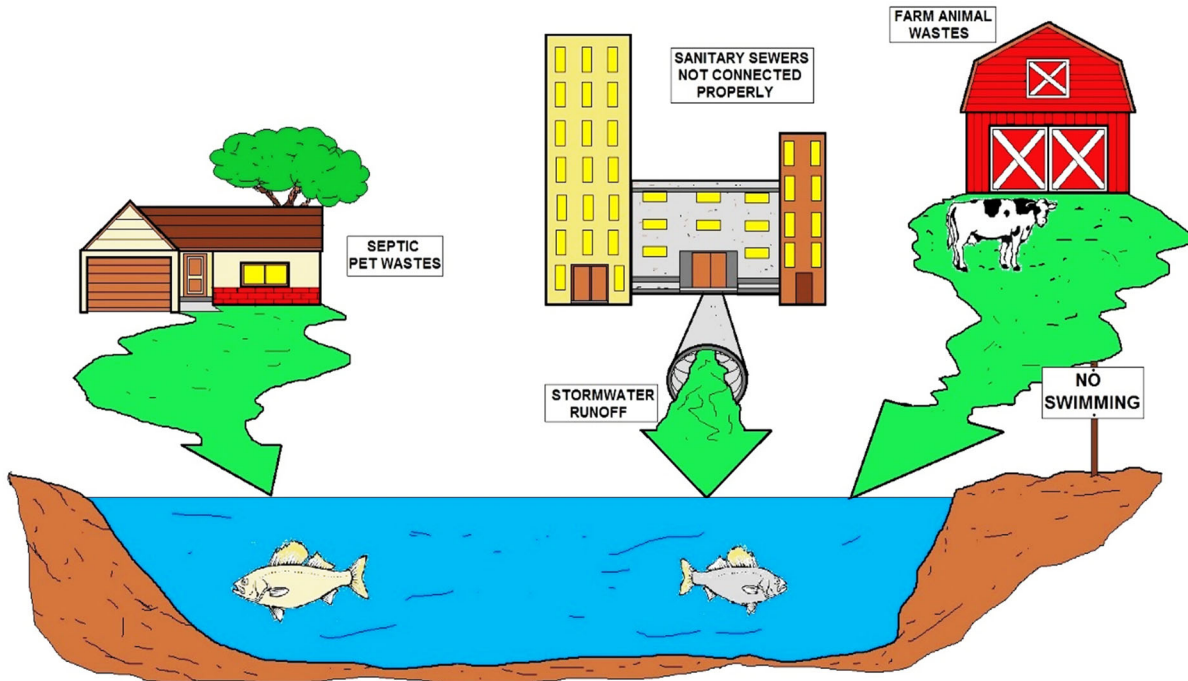
For PWSs collecting more than one sample per month, collect total coliform samples at regular intervals throughout the month, except that ground water systems serving 4,900 or fewer people may collect all required samples on a single day if the samples are taken from different sites.

Each total coliform-positive (TC+) routine sample must be tested for the presence of E. coli.

- ▶ If any TC+ sample is also E. coli-positive (EC+), then the EC+ sample result must be reported to the state by the end of the day that the PWS is notified.
- ▶ If any routine sample is TC+, repeat samples are required. – PWSs on quarterly or annual monitoring must take a minimum of three additional routine samples (known as additional routine monitoring) the month following a TC+ routine or repeat sample.
- ▶ Reduced monitoring may be available for PWSs using only ground water and serving 1,000 or fewer persons that meet certain additional PWS criteria.

## Coliform Bacteria - Introduction

Total coliforms are a group of related bacteria that are (with few exceptions) not harmful to humans. A variety of bacteria, parasites, and viruses, known as pathogens, can potentially cause health problems if humans ingest them. EPA considers total coliforms a useful indicator of other pathogens for drinking water because they are easier to measure and associate with water contamination.



**SOURCES OF FECAL COLIFORM BACTERIA**

Total coliforms are used to determine the adequacy of water treatment and the integrity of the distribution system.

All bacteriological samples are analyzed for the coliform group; however, a positive reaction to these coliform analyses may be from sources other than fecal. In order to differentiate between these sources, all samples that are total coliform positive must be analyzed again to determine if fecal coliform or *E. coli* are present.

### Key provisions of the RTCR include:

- Setting a maximum contaminant level goal (MCLG) and maximum contaminant level (MCL) for *E. coli* for protection against potential fecal contamination.
- Setting a total coliform treatment technique (TT) requirement.
- Requirements for monitoring total coliforms and *E. coli* according to a sample siting plan and schedule specific to the PWS.
- Provisions allowing PWSs to transition to the RTCR using their existing Total Coliform Rule (TCR) monitoring frequency, including PWSs on reduced monitoring under the existing TCR.
- Requirements for seasonal systems (such as Non-Community Water Systems not operated on a year-round basis) to monitor and certify the completion of a state-approved start-up procedures.

- Requirements for assessments and corrective action when monitoring results show that PWSs may be vulnerable to contamination.
- Public notification (PN) requirements for violations.
- Specific language for CWSs to include in their Consumer Confidence Reports (CCRs) when they must conduct an assessment or if they incur an E. coli MCL violation.

### TCR Key Provisions

- To comply with the monthly MCL for total coliforms (TC), PWSs must not find coliforms in more than five percent of the samples they take each month to meet EPA's standards. If more than five percent of the samples contain coliforms, PWS operators must report this violation to the state and the public.
- If a sample tests positive for TC, the system must collect a set of repeat samples located within 5 or fewer sampling sites adjacent to the location of the routine positive sample within 24 hours.
- When a routine or repeat sample tests positive for total coliforms, it must also be analyzed for fecal coliforms or E. coli, which are types of coliform bacteria that are directly associated with feces. A positive result for fecal coliforms or E. coli can signify an acute MCL violation, which necessitates rapid state and public notification because it represents a direct health risk.
- At times, an acute violation due to the presence of fecal coliform or E. coli may result in a "boil water" notice. The system must also take at least 5 routine samples the next month of operation if any sample tests positive for total coliforms.

TOTAL COLIFORM RULE (TCR) REVISIONS	
<p><b>REVISED TOTAL COLIFORM RULE (RTCR)</b>            THIS REVISES THE 1989 TOTAL COLIFORM RULE (TCR) AND IS INTENDED TO IMPROVE PUBLIC HEALTH PROTECTION. THIS ESTABLISHED A "FIND-AND-FIX" APPROACH FOR INVESTIGATING AND CORRECTING CAUSES OF COLIFORM PROBLEMS WITHIN WATER DISTRIBUTION SYSTEMS.</p> <p>THE MAXIMUM CONTAMINANT LEVEL (MCL) FOR BACTERIA IN DRINKING WATER IS ZERO TOTAL COLIFORM COLONIES PER 100 MILLILITERS OF WATER.</p> <p>BEGINNING JULY 1st, 2021, ALL RESAMPLES SUBMITTED IN RESPONSE TO A PREVIOUS POSITIVE COLIFORM RESULT MUST BE ANALYZED TO DETERMINE COLIFORM AND E.coli DENSITY</p>	<div style="text-align: center;"> <h2 style="color: #0056b3;">Coliforms Explained</h2> </div>



### TOTAL COLIFORM RULE (TCR) REVISIONS

All public water systems (PWSs), except aircraft PWSs subject to the Aircraft Drinking Water Rule (ADWR) (40 CFR 141 Subpart X), must comply with the RTCR starting April 1, 2016, or an earlier state effective date. Until then, PWSs must continue complying with the 1989 TCR.



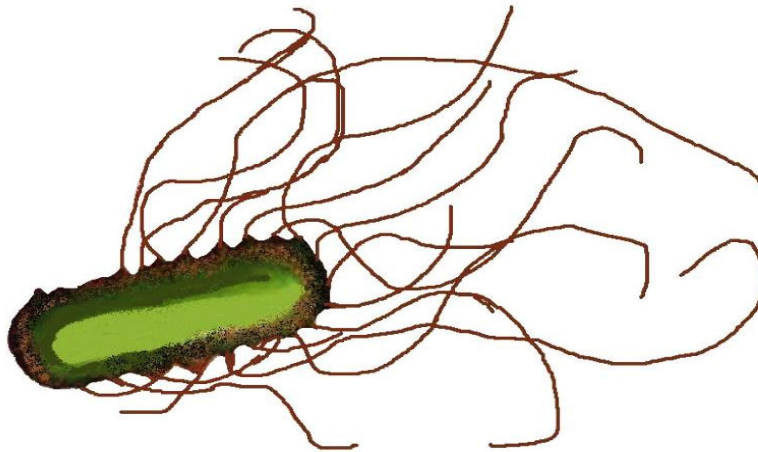
## Related and Dangerous Waterborne Microbes

**Coliform Bacteria** are common in the environment and are generally not harmful. However, the presence of these bacteria in drinking water are usually a result of a problem with the treatment system or the pipes which distribute water, and indicates that the water may be contaminated with germs that can cause disease.

**Fecal Coliform and E. coli** are bacteria whose presence indicates that the water may be contaminated with human or animal wastes. Microbes in these wastes can cause short-term effects, such as diarrhea, cramps, nausea, headaches, or other symptoms.

**Cryptosporidium** is a parasite that enters lakes and rivers through sewage and animal waste. It causes cryptosporidiosis, a mild gastrointestinal disease. However, the disease can be severe or fatal for people with severely weakened immune systems. The EPA and CDC have prepared advice for those with severely compromised immune systems who are concerned about *Cryptosporidium*.

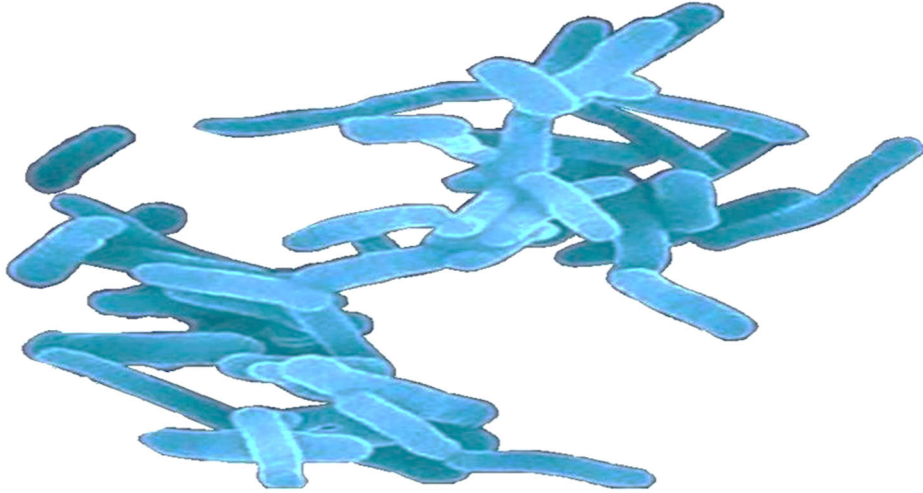
**Giardia lamblia** is a parasite that enters lakes and rivers through sewage and animal waste. It causes gastrointestinal illness (e.g. diarrhea, vomiting, and cramps).



### PERITRICHOUS SHAPED BACTERIA EXAMPLE

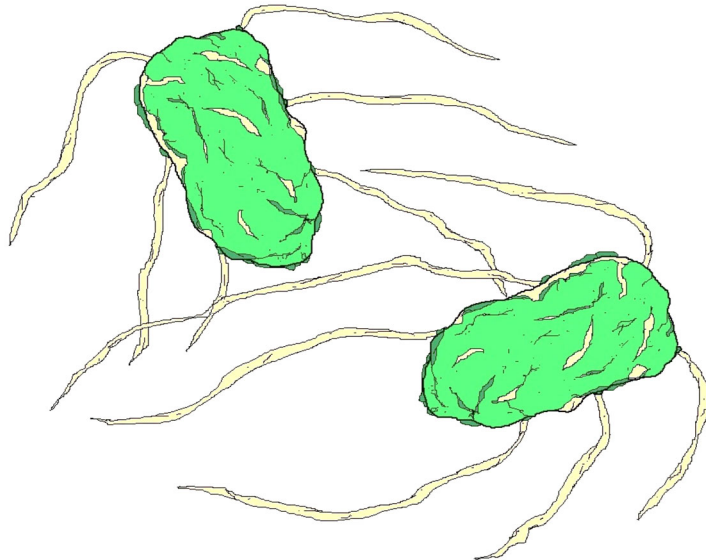
Microbiologists broadly classify bacteria according to their shape: spherical, rod-shaped, and spiral-shaped. Pleomorphic bacteria can assume a variety of shapes. Bacteria may be further classified according to whether they require oxygen (aerobic or anaerobic) and how they react to a test with Gram's stain.

Bacteria in which alcohol washes away Gram's stain are called gram-negative, while bacteria in which alcohol causes the bacteria's walls to absorb the stain are called gram-positive.



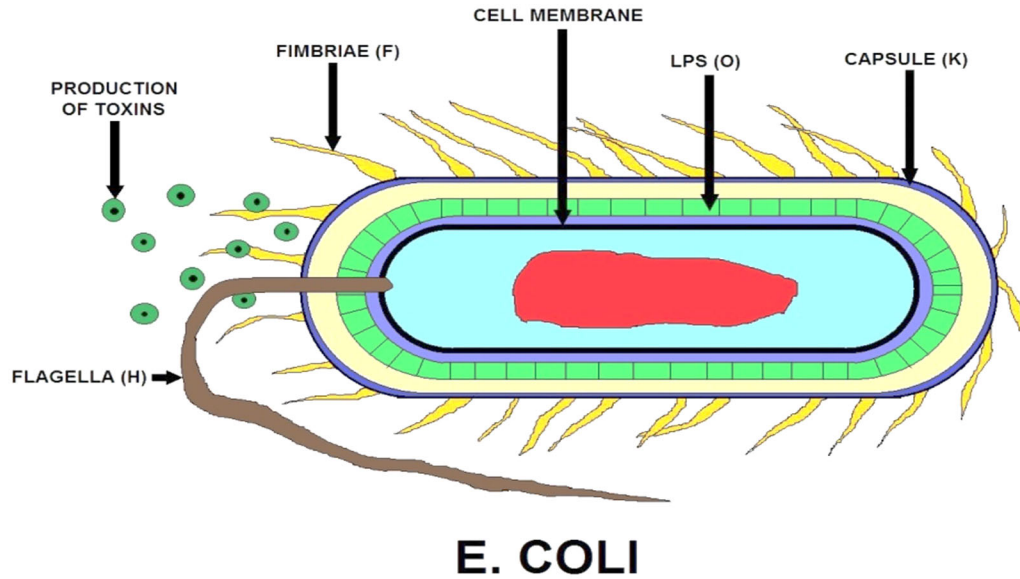
### **SHIGELLA DYSENTERIAE EXAMPLE**

Shigella dysenteriae is a species of the rod-shaped bacterial genus Shigella. Shigella can cause shigellosis (bacillary dysentery). Shigellae are Gram-negative, non-spore-forming, facultatively anaerobic, non-motile bacteria.



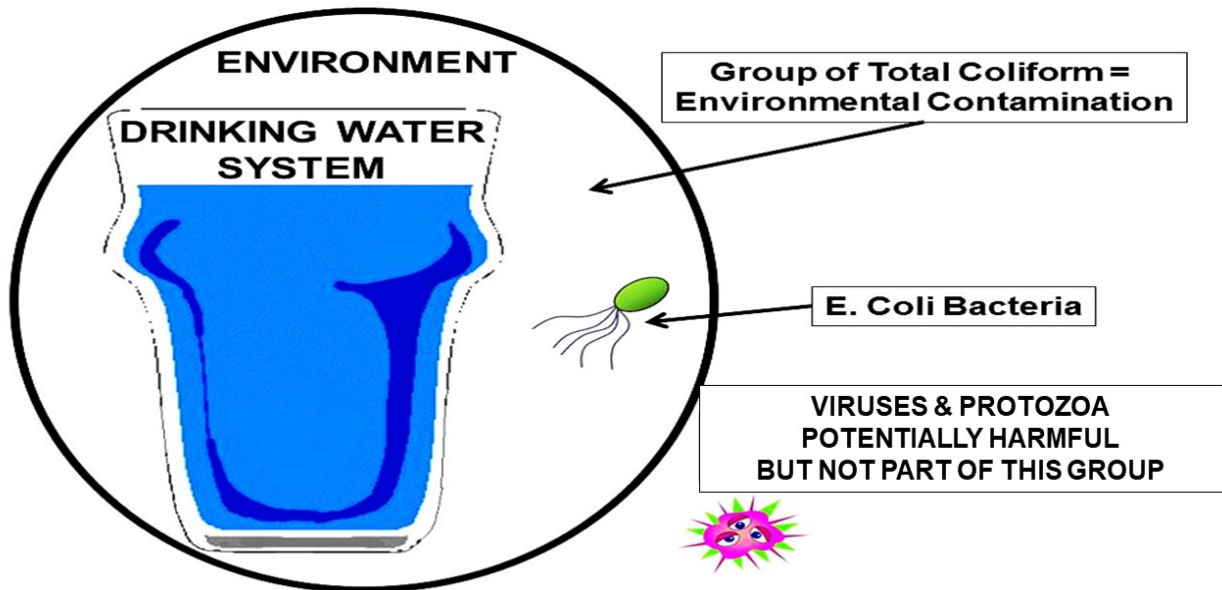
### **SALMONELLA EXAMPLE**

Salmonellae usually do not ferment lactose; most of them produce hydrogen sulfide that in media containing ferric ammonium citrate reacts to form a black spot in the center of the creamy colonies.

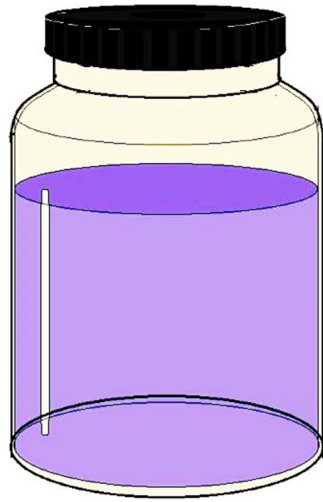


### Fecal Coliform Bacteria

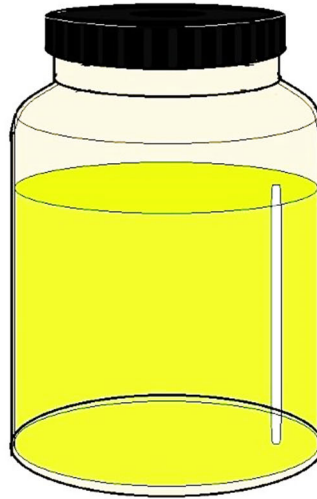
Fecal coliform bacteria are microscopic organisms that live in the intestines of warm-blooded animals. They also live in the waste material, or feces, excreted from the intestinal tract. When fecal coliform bacteria are present in high numbers in a water sample, it means that the water has received fecal matter from one source or another. Although not necessarily agents of disease, fecal coliform bacteria may indicate the presence of disease-carrying organisms, which live in the same environment as the fecal coliform bacteria.



### GROUP OF TOTAL COLIFORM BACTERIA

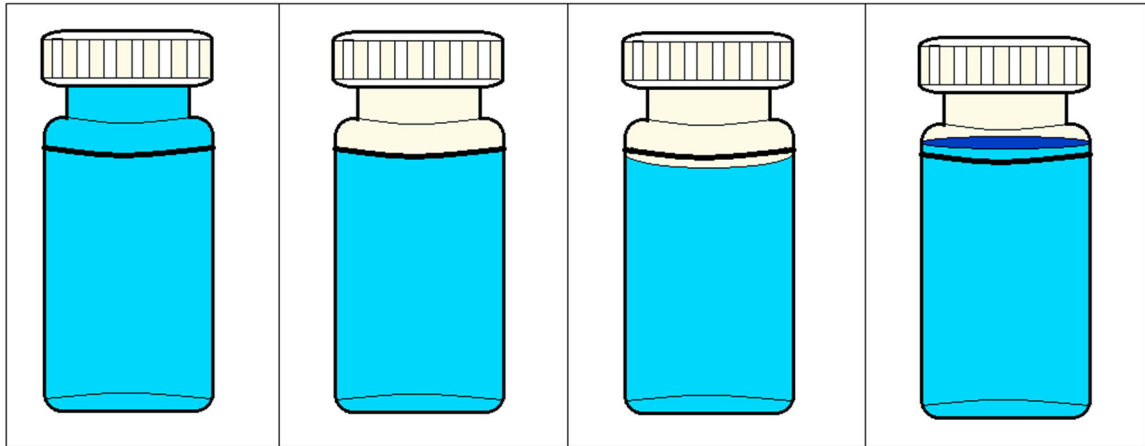





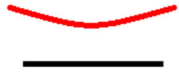
COLIFORM POSITIVE  
SAMPLE



COLIFORM NEGATIVE  
SAMPLE

**COLIFORM BACTERIA PRESENCE TEST EXAMPLE**



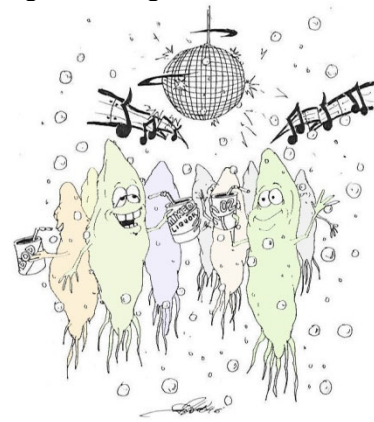
 **OVER FILLED**
 **CORRECT (100mL)**
 **INCORRECT (97mL)**
 **CORRECT**  
(Lab will pour off to 100mL)

**BAC-T SAMPLE BOTTLE DIAGRAM**

## Bacteriological Monitoring - Introduction

Most waterborne diseases and illnesses have been related to the microbiological quality of drinking water. The routine microbiological analysis of your water is for coliform bacteria. The coliform bacteria group is used as an indicator organism to determine the biological quality of your water. The presence of an indicator or pathogenic bacteria in your drinking water is an important health concern. Indicator bacteria signal possible fecal contamination, and therefore, the potential presence of pathogens. They are used to monitor for pathogens because of the difficulties in determining the presence of specific disease-causing microorganisms.

Indicator bacteria are usually harmless, occur in high densities in their natural environment, and are easily cultured in relatively simple bacteriological media. Indicators in common use today for routine monitoring of drinking water include total coliforms, fecal coliforms, and *Escherichia coli* (*E. coli*).



### Bacteria Sampling - 1 Example

Water samples for bacteria tests must always be collected in a sterile container. Take the sample from an outside faucet with the aerator removed. Sterilize by spraying a 5% Household bleach or alcohol solution or flaming the end of the tap with a propane torch. Run the water for five minutes to clear the water lines and bring in fresh water. Do not touch or contaminate the inside of the bottle or cap. Carefully open the sample container and hold the outside of the cap. Fill the container and replace the top. Refrigerate the sample and transport it to the testing laboratory within six hours (in an ice chest). Many labs will not accept bacteria samples on Friday so check the lab's schedule. Mailing bacteria samples is not recommended because laboratory analysis results are not as reliable. Iron bacteria forms an obvious slime on the inside of pipes and fixtures. A water test is not needed for identification. Check for a reddish-brown slime inside a toilet tank or where water stands for several days.

**Bac-T Sample Bottle** Often referred to as a Standard Sample, 100 mls, notice the white powder inside the bottle. That is Sodium Thiosulfate, a de-chlorination agent. Be careful not to wash-out this chemical while sampling. Notice the custody seal on the bottle.

**Coliform bacteria** are common in the environment and are generally not harmful. However, the presence of these bacteria in drinking water is usually a result of a problem with the treatment system or the pipes which distribute water, and indicates that the water may be contaminated with germs that can cause disease.

### Laboratory Procedures

The laboratory may perform the total coliform analysis in one of four methods approved by the U.S. EPA and your local environmental or health division:

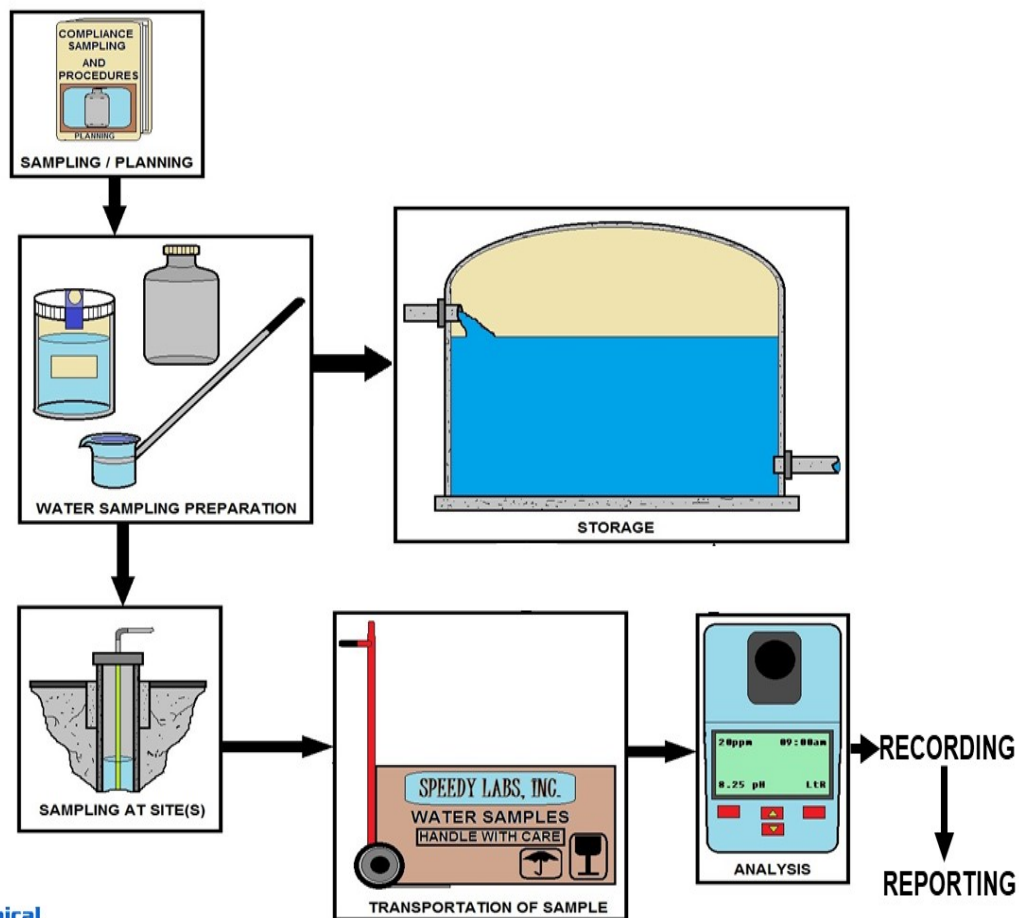
### Methods

The MMO-MUG test, a product marketed as Colilert, is the most common. The sample results will be reported by the laboratories as simply coliforms present or absent. If coliforms are present, the laboratory will analyze the sample further to determine if these are fecal coliforms or *E. coli* and report their presence or absence.

## Microbial Regulations

One of the key regulations developed and implemented by the United States Environmental Protection Agency (USEPA) to counter pathogens in drinking water is the Surface Water Treatment Rule.

Among its provisions, the rule requires that a public water system, using surface water (or ground water under the direct influence of surface water) as its source, have sufficient treatment to reduce the source water concentration of *Giardia* and viruses by at least 99.9% and 99.99%, respectively. The Surface Water Treatment Rule specifies treatment criteria to assure that these performance requirements are met; they include turbidity limits, disinfectant residual and disinfectant contact time conditions.



**WATER SAMPLING FLOW CHART**

## Basic Types of Water Samples

It is important to properly identify the type of sample you are collecting. Please indicate in the space provided on the laboratory form the type of sample.

### **The Three (3) Primary Types of Samples are:**

1. **Routine:** Samples collected on a routine basis to monitor for contamination. Collection should be in accordance with an approved sampling plan.

2. **Repeat:** Samples collected following a '*coliform present*' routine sample. The number of repeat samples to be collected is based on the number of routine samples you normally collect.

3. **Special:** Samples collected for other reasons.

Examples would be a sample collected after repairs to the system and before it is placed back into operation or a sample collected at a wellhead prior to a disinfection injection point.

A. **Trigger: Level 1 Assessment** is triggered if any one of the following occurs:

- ▶ A PWS collecting fewer than 40 samples per month has 2 or more TC+ routine/repeat samples in the same month.
- ▶ A PWS collecting at least 40 samples per month has greater than 5.0 percent of the routine/repeat samples in the same month that are TC+.
- ▶ A PWS fails to take every required repeat sample after any single TC+ sample

B. **Trigger: Level 2 Assessment** is triggered if any one of the following occurs:

- ▶ A PWS incurs an E. coli MCL violation.
- ▶ A PWS has a second Level 1 Assessment within a rolling 12-month period.
- ▶ A PWS on state-approved annual monitoring has a Level 1 Assessment trigger in 2 consecutive years.

### **Routine Coliform Sampling**

The number of routine samples and frequency of collection for community public water systems is shown in Table 3-1 below.

### **Noncommunity and nontransient noncommunity public water systems will sample at the same frequency as a like sized community public water system if:**

1. It has more than 1,000 daily population and has ground water as a source, or
2. It serves 25 or more daily population and utilizes surface water as a source or ground water under the direct influence of surface water as its source.

Noncommunity and nontransient, noncommunity water systems with less than 1,000 daily population and groundwater as a source will sample on a quarterly basis.

## No. of Samples per System Population

*Persons served - Samples per month*

<u>up to 1,000</u>	<u>1</u>
<u>1,001-2,500</u>	<u>2</u>
<u>2,501-3,300</u>	<u>3</u>
<u>3,301 to 4,100</u>	<u>4</u>
<u>4,101 to 4,900</u>	<u>5</u>
<u>4,901 to 5,800</u>	<u>6</u>
<u>5,801 to 6,700</u>	<u>7</u>
<u>6,701 to 7,600</u>	<u>8</u>
<u>7,601 to 8,500</u>	<u>9</u>
<u>8,501 to 12,900</u>	<u>10</u>
<u>12,901 to 17,200</u>	<u>15</u>
<u>17,201 to 21,500</u>	<u>20</u>
<u>21,501 to 25,000</u>	<u>25</u>
<u>25,001 to 33,000</u>	<u>30</u>
<u>33,001 to 41,000</u>	<u>40</u>
<u>41,001 to 50,000</u>	<u>50</u>
<u>50,001 to 59,000</u>	<u>60</u>
<u>59,001 to 70,000</u>	<u>70</u>
<u>70,001 to 83,000</u>	<u>80</u>
<u>83,001 to 96,000</u>	<u>90</u>
<u>96,001 to 130,000</u>	<u>100</u>
<u>130,001 to 220,000</u>	<u>120</u>
<u>220,001 to 320,000</u>	<u>150</u>
<u>320,001 to 450,000</u>	<u>180</u>
<u>450,001 to 600,000</u>	<u>210</u>
<u>600,001 to 780,000</u>	<u>240</u>



### Repeat Sampling Introduction

Repeat sampling replaces the old check sampling with a more comprehensive procedure to try to identify problem areas in the system. Whenever a routine sample has total coliform or fecal coliform present, a set of repeat samples must be collected within 24 hours after being notified by the laboratory. The follow-up for repeat sampling is:

1. If only one routine sample per month or quarter is required, four (4) repeat samples must be collected.
2. For systems collecting two (2) or more routine samples per month, three (3) repeat samples must be collected.
3. Repeat samples must be collected from:
  - a. The original sampling location of the coliform present sample.
  - b. Within five (5) service connections upstream from the original sampling location.
  - c. Within five (5) service connections downstream from the original sampling location.
  - d. Elsewhere in the distribution system or at the wellhead, if necessary.
4. If the system has only one service connection, the repeat samples must be collected from the same sampling location over a four-day period or on the same day.
5. All repeat samples are included in the MCL compliance calculation.
6. If a system which normally collects fewer than five (5) routine samples per month has a coliform present sample, it must collect five (5) routine samples the following month or quarter regardless of whether an MCL violation occurred or if repeat sampling was coliform absent.



## Positive or Coliform Present Results

*What do you do when your sample is positive or coliform present?*

When you are notified of a positive test result you need to contact either the Drinking Water Program or your local county health department within 24 hours, or by the next business day after the results are reported to you. The Drinking Water Program contracts with many of the local health departments to provide assistance to water systems.

After you have contacted an agency for assistance, you will be instructed as to the proper repeat sampling procedures and possible corrective measures for solving the problem. It is very important to initiate the repeat sampling immediately as the corrective measures will be based on those results.



### Some examples of typical corrective measures to coliform problems are:

1. Shock chlorination of a ground water well. The recommended dose of 5% household bleach is 2 cups per 100 gallons of water in the well. This should be done anytime the well is opened for repair (pump replacement, etc.). If you plan to shock the entire system, calculate the total gallonage of storage and distribution.
2. Conduct routine distribution line flushing. Install blowoffs on all dead end lines.
3. Conduct a cross connection program to identify all connections with non-potable water sources. Eliminate all of these connections or provide approved backflow prevention devices.
4. Upgrade the wellhead area to meet current construction standards as set by your state environmental or health agency.
5. If you continuously chlorinate, review your operation and be sure to maintain a detectable residual (0.2 mg/l free chlorine) at all times in the distribution system.
6. Perform routine cleaning of the storage system.

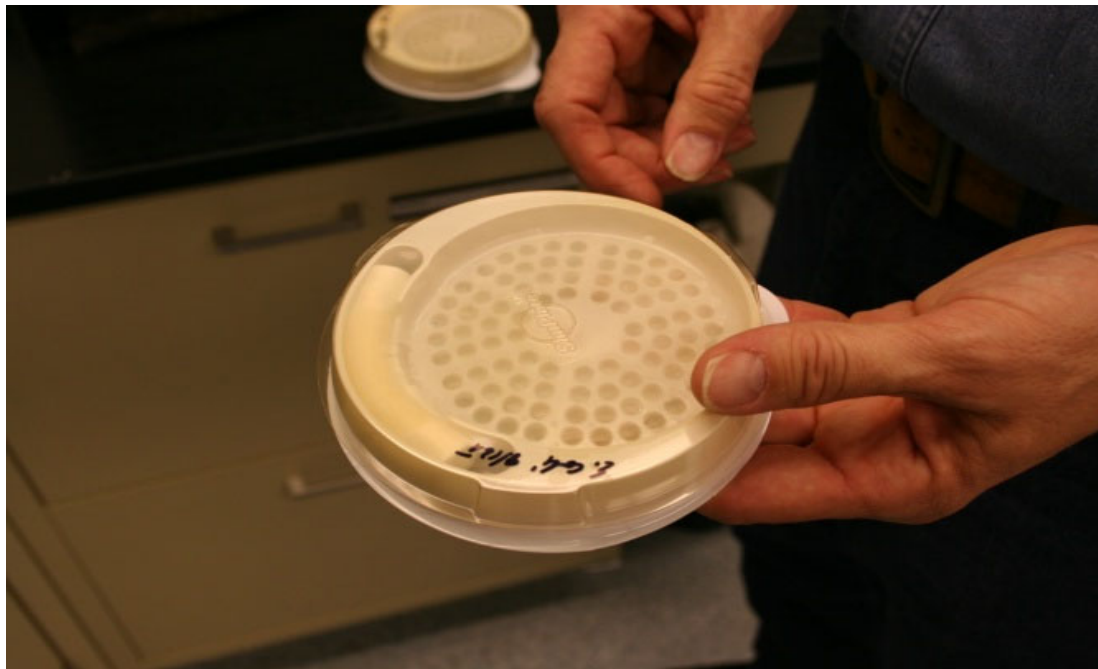
This list provides some basic operation and maintenance procedures that could help eliminate potential bacteriological problems, check with your state drinking water section or health department for further instructions.

## Maximum Contaminant Levels (MCLs)

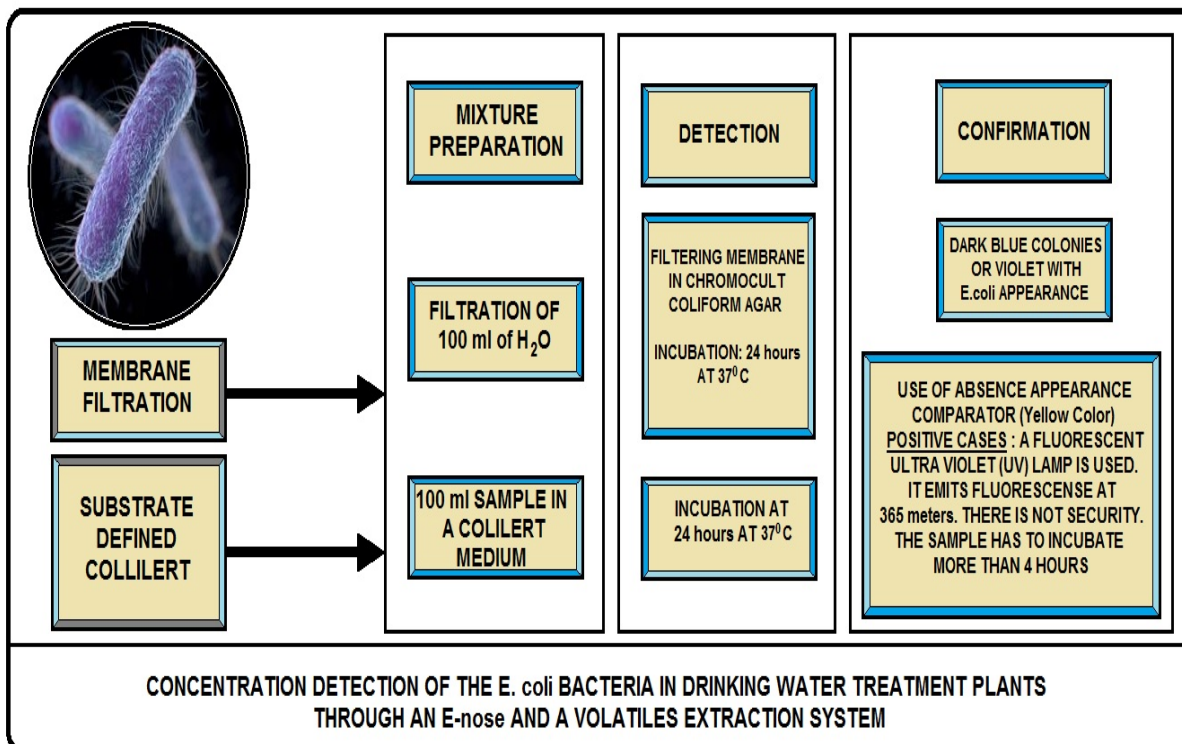
State and federal laws establish standards for drinking water quality. Under normal circumstances when these standards are being met, the water is safe to drink with no threat to human health. These standards are known as maximum contaminant levels (**MCL**). When a particular contaminant exceeds its MCL a potential health threat may occur.

The MCLs are based on extensive research on toxicological properties of the contaminants, risk assessments and factors, short term (**acute**) exposure, and long term (**chronic**) exposure. You conduct the monitoring to make sure your water is in compliance with the MCL.

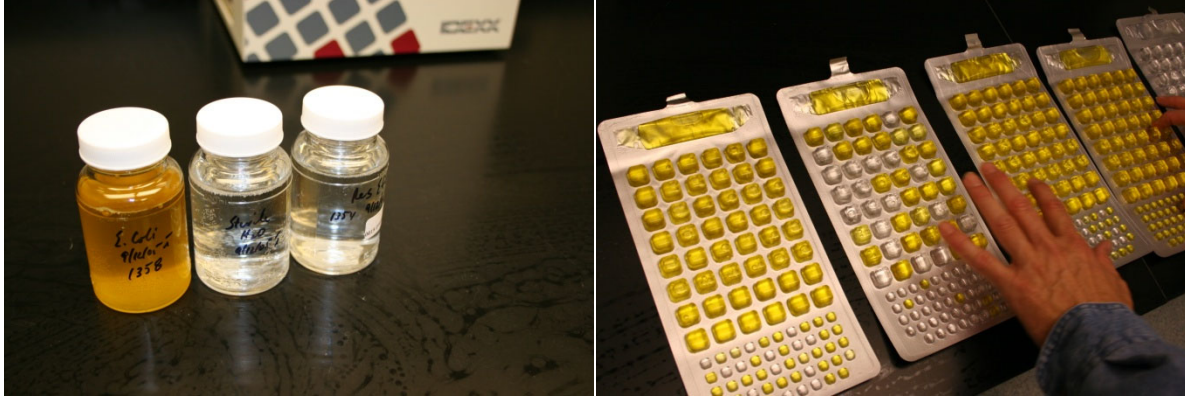
There are two types of MCL violations for coliform bacteria. The first is for total coliform; the second is an acute risk to health violation characterized by the confirmed presence of fecal coliform or *E. coli*.



## SIM PLATE METHOD



## CONVENTIONAL BACTERIOLOGICAL MONITORING

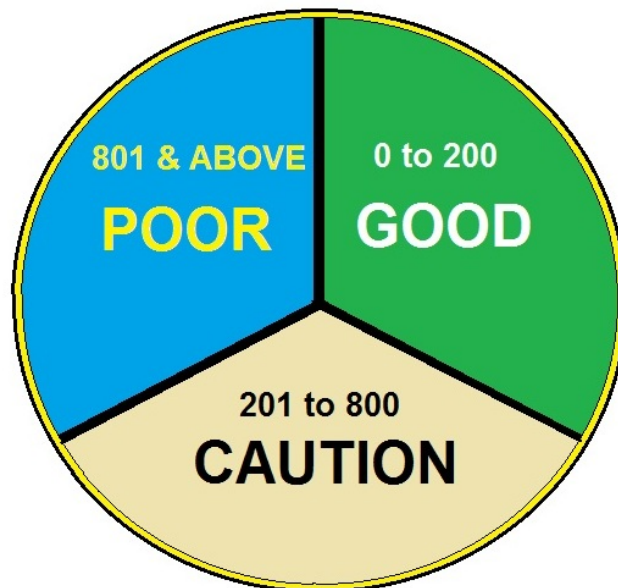
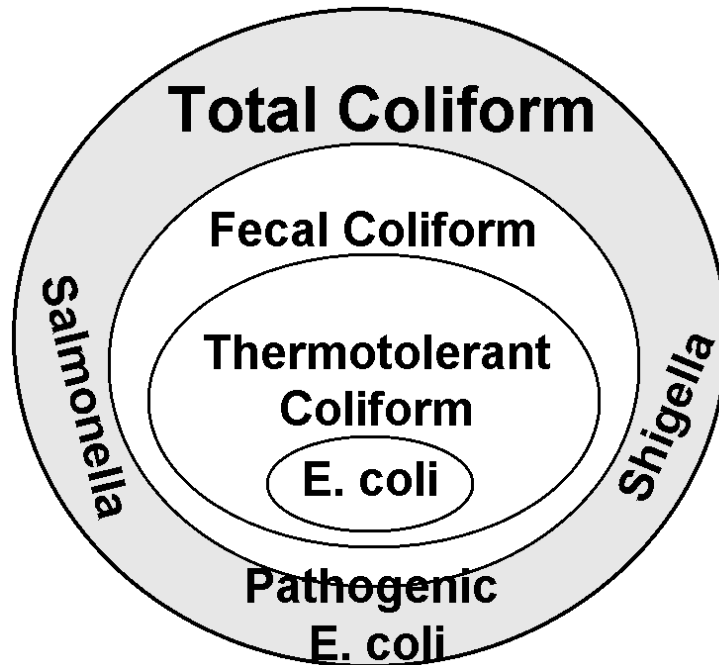


Looking under a black light to identify the presence of E. coli.

Colilert tests simultaneously detect and confirms coliform and E. coli in water samples in 24 hours or less.

Simply add the Colilert reagent to the sample, incubate for 24 hours, and read results.

Colilert is easy to read, as positive coliform samples turn yellow or blue, and when E. coli is present, samples fluoresce under UV light.



**FECAL COLIFORM BACTERIA COLONIES  
(Per 100 Milliliters)**

## Heterotrophic Plate Count - Introduction

Heterotrophic organisms utilize organic compounds as their carbon source (food or substrate). In contrast, autotrophic organisms use inorganic carbon sources. The Heterotrophic Plate Count provides a technique to quantify the bacteriological activity of a sample. The R2A agar provides a medium that will support a large variety of heterotrophic bacteria. After an incubation period, a bacteriological colony count provides an estimate of the concentration of heterotrophs in the sample of interest.

**Heterotrophic Plate Count (HPC)** --- formerly known as the standard plate count, is a procedure for estimating the number of live heterotrophic bacteria and measuring changes during water treatment and distribution in water or in swimming pools. Colonies may arise from pairs, chains, clusters, or single cells, all of which are included in the term "*colony-forming units*" (CFU).

### Method:

*There are three methods for standard plate count:*

#### 1. Pour Plate Method

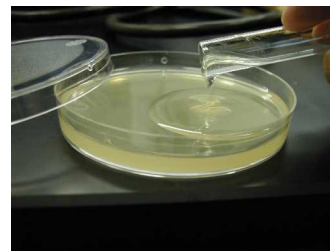
The colonies produced are relatively small and compact, showing less tendency to encroach on each other than those produced by surface growth. On the other hand, submerged colonies often are slower growing and are difficult to transfer.

#### 2. Spread Plate Method

All colonies are on the agar surface where they can be distinguished readily from particles and bubbles. Colonies can be transferred quickly, and colony morphology can be easily discerned and compared to published descriptions. See next page

#### 3. Membrane Filter Method

This method permits testing large volumes of low-turbidity water and is the method of choice for low-count waters.



### Material

- i ) Apparatus
  - Glass rod
  - Erlenmeyer flask
  - Graduated Cylinder
  - Pipette
  - Petri dish
  - Incubator
- ii ) Reagent and sample
  - Reagent-grade water
  - Nutrient agar
  - Sample

### Procedure\*

1. Boil mixture of nutrient agar and nutrient broth for 15 minutes, then cool for about 20 minutes.
2. Pour approximately 15 ml of medium in each Petri dish, let medium solidify.

3. Pipette 0.1 ml of each dilution onto surface of pre-dried plate, starting with the highest dilution.
4. Distribute inoculum over surface of the medium using a sterile bent glass rod.
5. Incubate plates at 35°C for 48h.
6. Count all colonies on selected plates promptly after incubation, consider only plates having 30 to 300 colonies in determining the plate count.

\*Duplicate samples

### Computing and Reporting

Compute bacterial count per milliliter by the following equation:

CFU/ml = colonies counted / actual volume of sample in dish a) If there is no plate with 30 to 300 colonies, and one or more plates have more than 300 colonies, use the plate(s) having a count nearest 300 colonies.

b) If plates from all dilutions of any sample have no colony, report the count as less than 1/actual volume of sample in dish estimated CFU/ml.

c) Avoid creating fictitious precision and accuracy when computing CFU by recording only the first two left-hand digits.

### Heterotrophic Plate Count (Spread Plate Method)

#### Laboratory Equipment Needed

100 x 15 Petri Dishes

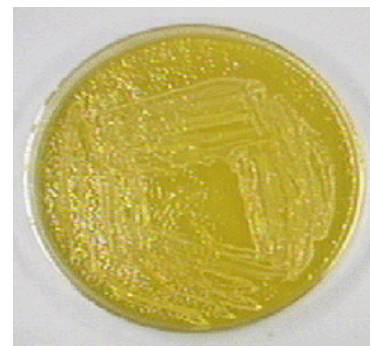
Turntable

**Glass Rods:** Bend fire polished glass rod 45 degrees about 40 mm from one end. Sterilize before using.

**Pipette:** Glass, 1.1 mL. Sterilize before using.

**Quebec Colony Counter**

**Hand Tally Counter**



#### Reagents

**1) R2A Agar:** Dissolve and dilute 0.5 g of yeast extract, 0.5 g of proteose peptone No. 3, 0.5 g of casamino acids, 0.5 g of glucose, 0.5 g of soluble starch, 0.3 g of dipotassium hydrogen phosphate, 0.05 g of magnesium sulfate heptahydrate, 0.3 g of sodium pyruvate, 15.0 g of agar to 1 L. Adjust pH to 7.2 with dipotassium hydrogen phosphate **before adding agar**. Heat to dissolve agar and sterilize at 121 C for 15 minutes.

**2) Ethanol:** As needed for flame sterilization.

#### Preparation of Spread Plates

Immediately after agar sterilization, pour 15 mL of R2A agar into sterile 100 x 15 Petri dishes; let agar solidify. Pre-dry plates inverted so that there is a 2 to 3 g water loss overnight with the lids on. Use pre-dried plates immediately or store up to two weeks in sealed plastic bags at 4°C.

#### Sample Preparation

Mark each plate with sample type, dilution, date, and any other information before sample application.

Prepare at least duplicate plates for each volume of sample or dilution examined.

Thoroughly mix all samples by rapidly making about 25 complete up-and-down movements.

### Sample Application

Uncover pre-dried agar plate. Minimize time plate remains uncovered. Pipette 0.1 or 0.5 mL sample onto surface of pre-dried agar plate.

### Record Volume of Sample Used.

Using a sterile bent glass rod, distribute the sample over surface of the medium by rotating the dish by hand on a turntable. Let the sample be absorbed completely into the medium before incubating. Put cover back on Petri dish and invert for duration of incubation time. Incubate at 28°C for 7 days. Remove Petri dishes from incubator for counting.



### Counting and Recording

After incubation period, promptly count all colonies on the plates. To count, uncover plate and place on Quebec colony counter. Use a hand tally counter to maintain count. Count all colonies on the plate, regardless of size. Compute bacterial count per milliliter by the following equation:

$$\text{CFU/mL} = \frac{\text{colonies counted}}{\text{actual volume of sample in dish, mL}}$$

To report counts on a plate with no colonies, report the count as less than one (<1) divided by the sample volume put on that plate (remember to account for any dilution of that sample).

If plates of all dilutions for a sample have no colonies, report the count as less than one (<1) divided by the largest sample volume used. Example: if 0.1 mL of a 100:1 and 10000:1 dilution of a sample both turned up with no colonies formed, the reported result would be <1 divided by the largest sample volume 0.001 mL (0.1 mL divided by 100). The final reported result for the sample is <1000 CFU per mL.

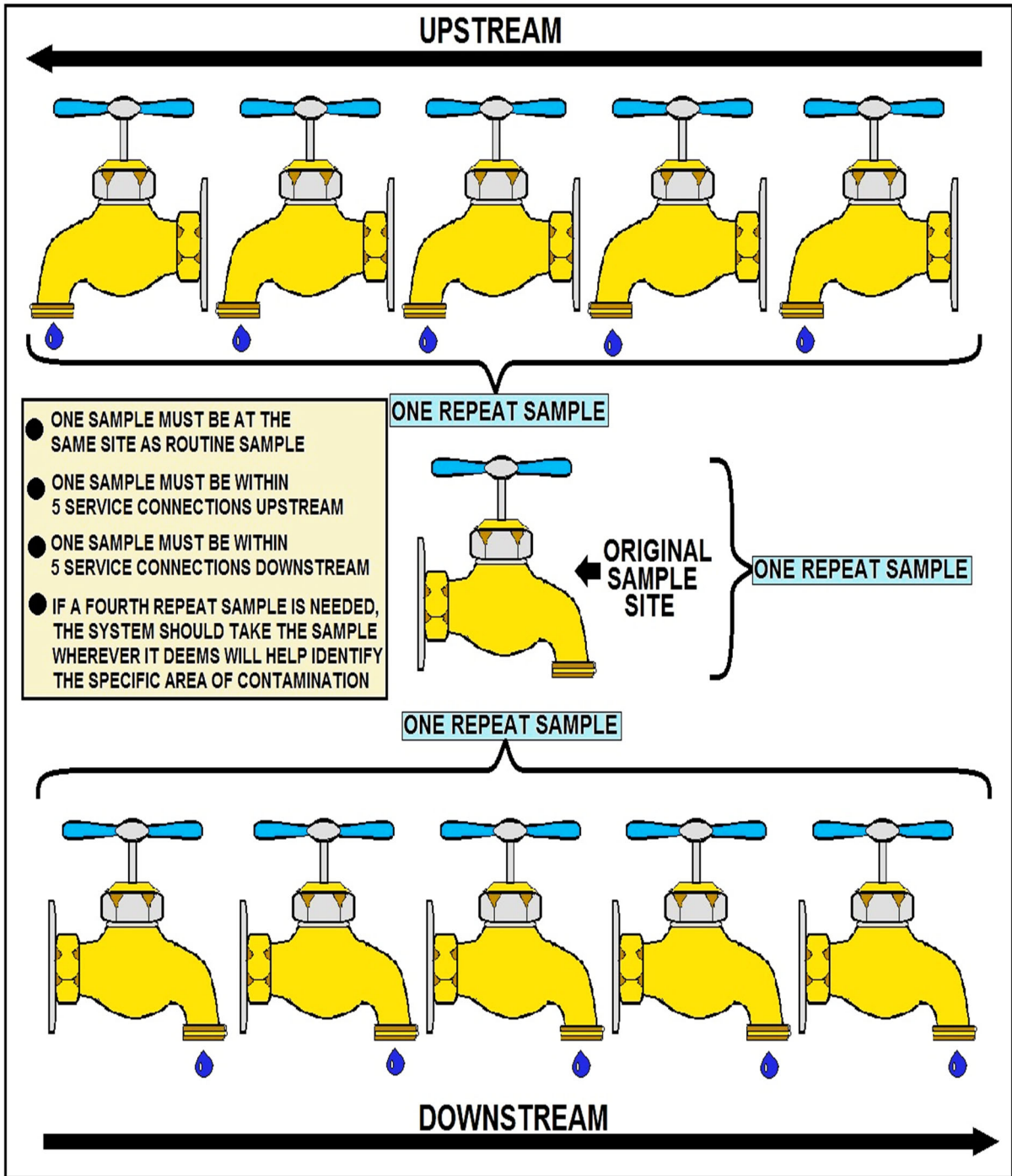
### Assignment

1. Report the number of colony forming units (**CFU**) found on each plate.
2. Calculate the **CFU** per mL for each plate.
3. The aim of diluting samples is to produce a plate having 30 to 300 colonies, which plates meet these criteria. If no sample produces a plate with a count in this range, use the plate(s) with a count closest to 300. Based on these criteria, use your calculated results to report the CFU per mL for each sample.

In the conclusion of your lab report, comment on your final results for each sample type as well as the quality of your application of this analysis technique. Feel free to justify your comments using statistical analysis. Also, comment on the general accuracy of this analytical technique and the factors that affect its accuracy and or applicability.

### Data Table for Samples

Sample ID	Volume of Sample, mL	Colonies Counted per plate



**EXAMPLE OF WHAT HAS TO BE DONE IF A PRESENCE OF COLIFORMS ARE DETECTED WHEN CONDUCTING ROUTINE SAMPLES AT DESIGNATED SAMPLE SITES**



## Total Coliforms

This MCL is based on the presence of total coliforms, and compliance is on a monthly or quarterly basis, depending on your water system type and state rule. For systems which collect *fewer* than 40 samples per month, no more than one sample per month may be positive. In other words, the second positive result (repeat or routine) in a month or quarter results in an MCL violation.

For systems which collect 40 or more samples per month, no more than five (5) percent may be positive. Check with your state drinking water section or health department for further instructions.

### Acute Risk to Health (Fecal Coliforms and E. coli)

***An acute risk to human health violation occurs if either one of the following happen:***

1. A routine analysis shows total coliform present and is followed by a repeat analysis which indicates fecal coliform or E. coli present.

2. A routine analysis shows total and fecal coliform or E. coli present and is followed by a repeat analysis which indicates total coliform present.

An acute health risk violation requires the water system to provide public notice via radio and television stations in the area. This type of contamination can pose an immediate threat to human health and notice must be given as soon as possible, but no later than 24 hours after notification from your laboratory of the test results.

Certain language may be mandatory for both these violations and is included in your state drinking water rule.

### Public Notice

A public notice is required to be issued by a water system whenever it fails to comply with an applicable MCL or treatment technique, or fails to comply with the requirements of any scheduled variance or permit. This will inform users when there is a problem with the system and give them information.

A public notice is also required whenever a water system fails to comply with its monitoring and/or reporting requirements or testing procedure.

Each public notice must contain certain information, be issued properly and in a timely manner and contain certain mandatory language. The timing and place of posting of the public notice depends on whether an acute risk is present to users. Check with your state drinking water section or health department for further instructions.

### The following are Acute Violations

1. Violation of the MCL for nitrate.
2. Any violation of the MCL for total coliforms, when fecal coliforms or E. coli are present in the distribution system.
3. Any outbreak of waterborne disease, as defined by the rules.

## Sim Plate Method



IDEXX's SimPlate for HPC method is used for the quantification of heterotrophic plate count (HPC) in water.

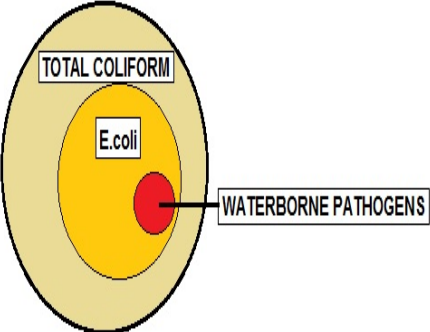
It is based on the Multiple Enzyme Technology which detects viable bacteria in water by testing for the presence of key enzymes known to be present in these little organisms.

This technique uses enzyme substrates that produce a blue fluorescence when metabolized by waterborne bacteria. The sample and media are added to a SimPlate Plate, incubated and then examined for fluorescing wells.

The number of wells corresponds to a Most Probable Number (MPN) of total bacteria in the original sample.

The MPN values generated by the SimPlate for HPC method correlate with the Pour Plate method using the Total Plate Count Agar, incubated at 35°C for 48 hours as described in *Standard Methods for the Examination of Water and Wastewater, 19<sup>th</sup> Edition*.

## Revised Total Coliform Rule (RTCR) Summary

REVISED RULE OVERVIEW		MAJOR RULE CHANGES	
<b>TITLE:</b>	REVISED TOTAL COLIFORM RULE (RTCR) 78 FR 10269, FEBRUARY 13th, 2013, Vol. 78, No. 30	<b>CURRENT TCR</b> Non-Accute MCL Violation	<b>REVISED TCR</b> Level 1 Assessment Trigger
<b>PURPOSE:</b>	INCREASE PUBLIC HEALTH PROTECTION THROUGH THE REDUCTION OF POTENTIAL PATHWAYS OF ENTRY FOR FECAL CONTAMINATION INTO DISTRIBUTION SYSTEM	FOR A SYSTEM COLLECTING AT LEAST 40 SAMPLES PER MONTH, MORE THAN 5.0% OF SAMPLES COLLECTED ARE TC POSITIVE	FOR A SYSTEM COLLECTING AT LEAST 40 SAMPLES PER MONTH, MORE THAN 5.0% OF SAMPLES COLLECTED ARE TC POSITIVE
<b>GENERAL DESCRIPTION:</b>	THE RTCR ESTABLISHES AN MCL FOR E.coli AND USES E.coli AND TOTAL COLIFORMS TO INITIATE AND "FIND A FIX" APPROACH TO ADDRESS FECAL CONTAMINATION THAT COULD ENTER DISTRIBUTION SYSTEM	FOR A SYSTEM COLLECTING FEWER THAN 40 SAMPLES PER MONTH, MORE THAN 1 SAMPLE TC POSITIVE	FOR A SYSTEM COLLECTING FEWER THAN 40 SAMPLES PER MONTH, MORE THAN 1 SAMPLE TC POSITIVE
<b>UTILITIES COVERED:</b>	THE REVISED TOTAL COLIFORM RULE APPLIES TO <u>ALL</u> PUBLIC WATER SYSTEMS	PUBLIC NOTICE IS REQUIRED	NO PUBLIC NOTICE MUST PERFORM LEVEL 1 ASSESSMENT
<b>PUBLIC HEALTH BENEFITS</b>			
IMPLEMENTATION OF THE REVISED TOTAL COLIFORM RULE <u>WILL</u> RESULT IN:			
<ul style="list-style-type: none"> <li>▶ A DECREASE IN THE PATHWAY BY WHICH FECAL CONTAMINATION CAN ENTER THE DRINKING WATER DISTRIBUTION SYSTEM</li> <li>▶ REDUCTION IN FECAL CONTAMINATION SHOULD REDUCE THE POTENTIAL RISK FROM ALL WATERBORNE PATHOGENS INCLUDING BACTERIA, VIRUSES, PROTOZOA, AND ASSOCIATED ILLNESSES.</li> </ul>			



## REVISED TOTAL COLIFORM RULE (RTCR)

*The following are EPA's federal rule requirements. Please be aware that each state implements drinking water regulations that may be more stringent than EPA's regulations. Check with your state environmental agency for more information.*

EPA published the Revised Total Coliform Rule (RTCR) in the Federal Register (FR) on February 13, 2013 (78 FR 10269). It is the revision to the 1989 Total Coliform Rule (TCR).

### Why revise the 1989 TCR?

The 1996 amendments to the Safe Drinking Water Act [Section 1412(b) (9)] require the Administrator to review and revise, as appropriate, each national primary drinking water regulation not less often than every six years. EPA published its decision to revise the TCR in July 2003 as part of its National Primary Drinking Water Regulation (NPDWR) review.

### The RTCR:

- Upholds the purpose of the 1989 TCR to protect public health by ensuring the integrity of the drinking water distribution system and monitoring for the presence of microbial contamination.
- Requires public water systems (PWSs) to meet a legal limit for E. coli, as demonstrated by required monitoring.

- Specifies the frequency and timing of required microbial testing based on population served, public water system type and source water type: ground water or surface water.

**When must PWSs comply with the RTCR requirements?**

Unless a State determines an earlier effective date, all PWSs must comply with the RTCR requirements starting April 1, 2016. All PWSs include:

- Community Water Systems (CWSs),
- Non-Transient Non-Community Water Systems (NTNCWSs), and
- Transient Non-Community Water Systems (TNCWSs).

**Minor Corrections to the Revised Total Coliform Rule (RTCRC)**

Minor corrections to the final RTCR became effective on April 28, 2014. No comments were received on the Direct Final Rule published on February 26, 2014 and the corrections therefore became effective without further notice. See the **Direct Final Rule** Federal Register Notice.

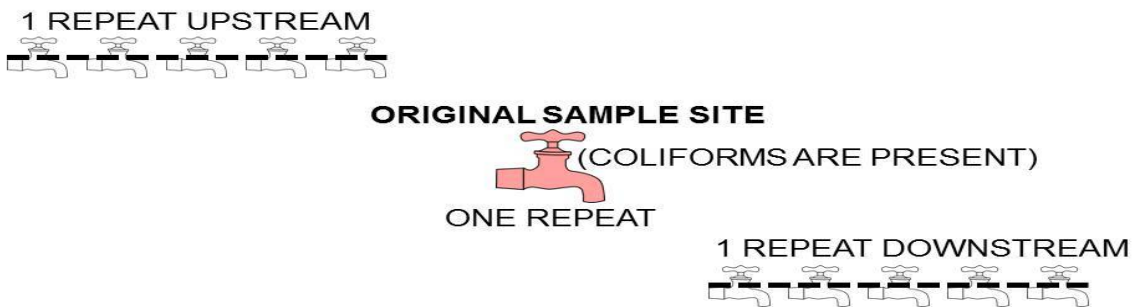
**Revised Total Coliform Rule (RTCRC) – Final Rule**

On February 13, 2013, EPA published in the Federal Register the revisions to the 1989 TCR. EPA anticipates greater public health protection under the Revised Total Coliform Rule (RTCRC) requirements.

**The RTCRC:**

- Requires public water systems that are vulnerable to microbial contamination to identify and fix problems; and
- Establishes criteria for systems to qualify for and stay on reduced monitoring, which could reduce water system burden and provide incentives for better system operation.

Public water systems (PWSs) and primacy agencies must comply with the revised requirements by April 2016. Until then, PWSs and primacy agencies must continue complying with the 1989 TCR.



ONE AT THE SAME SITE AS THE ROUTINE SAMPLE.  
 ONE WITHIN 5 SERVICE CONNECTIONS UPSTREAM.  
 ONE WITHIN 5 SERVICE CONNECTIONS DOWNSTREAM.

IF A FOURTH REPEAT SAMPLE IS REQUIRED THE SYSTEM SHOULD TAKE THE SAMPLE WHEREVER IT FEELS IT WILL HELP IDENTIFY THE AREA OF CONTAMINATION.

**REPEAT SAMPLING PROCEDURES**

## RTCR Key Provisions *Most of this section comes from the USEPA.*

Provision Category	Key Provisions
<p><b>Contaminant Level</b></p>	<p>Addresses the presence of total coliforms and E. coli in drinking water.</p> <p>For E. coli (EC), the Maximum Contaminant Level Goal (MCLG) is set at zero. The Maximum Contaminant Level (MCL) is based on the occurrence of a condition that includes routine and repeat samples.</p> <p>For total coliforms (TC), PWSs must conduct a Level 1 or Level 2 assessment of their system when they exceed a specified frequency of total coliform occurrences.</p> <p>An MCL violation or failure to take repeat samples following a routine total coliform-positive sample will trigger a Level 1 or Level 2 assessment.</p> <p>Any sanitary defect identified during a Level 1 or Level 2 assessment must be corrected by the PWS. These are the treatment technique requirements of the RTCR.</p>
<p><b>Monitoring</b></p>	<p>Develop and follow a sample-siting plan that designates the PWS's collection schedule. This includes location of routine and repeat water samples.</p> <p>Collect routine water samples on a regular basis (monthly, quarterly, annually). Have samples tested for the presence of total coliforms by a state certified laboratory.</p> <p>Analyze all routine or repeat samples that are total coliform positive (TC+) for E. coli.</p> <p>Collect repeat samples (at least 3) for each TC+ positive routine sample.</p> <p>For PWSs on quarterly or annual routine sampling, collect additional routine samples (at least 3) in the month after a TC+ routine or repeat sample.</p>

<b>RTCR Key Provisions</b> <i>Most of this section comes from the USEPA.</i>	
	Seasonal systems must monitor and certify the completion of a state-approved start-up procedures.
<b>Level 1 and Level 2 Assessments and Corrective Actions</b>	PWSs are required to conduct a Level 1 or Level 2 assessment if conditions indicate they might be vulnerable to contamination. PWSs must fix any sanitary defects within a required timeframe.
<b>Reporting and Recordkeeping</b>	PWSs are required to report certain items to their states. These reporting and recordkeeping requirements are essentially the same as under TCR. The addition to the Requirements is the Level 1 and Level 2 requirements.
<b>Violations, Public Notification (PN) and Consumer Confidence Report (CCR)</b>	<p>PWSs incur violations if they do not comply with the requirements of the RTCR. The violation types are essentially the same as under the TCR with few changes. The biggest change is no acute or monthly MCL violation for total coliform positive samples only.</p> <p>PN is required for violations incurred. Within required timeframes, the PWS must use the required health effects language and notify the public if they did not comply with certain requirements of the RTCR. The type of PN depends on the severity of the violation.</p> <p>Community water systems (CWSs) must use specific language in their CCRs when they must conduct an assessment or if they incur an E. coli MCL violation.</p>

### Disinfection Key

- ▶ Contact time is required
  - ▶ 99% or 2 log inactivation of crypto
  - ▶ 99.9% or 3 log inactivation of giardia lamblia cysts
  - ▶ 99.99% or 4 log inactivation of enteric viruses
- ▶  $CT = \text{Concentration of disinfectant} \times \text{contact time}$

The chlorine residual leaving the plant must be = or > 0.2 mg/L and measurable throughout the system

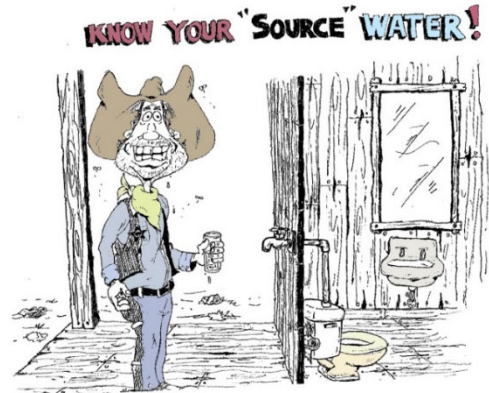
# Troubleshooting Table for Bacteriological Monitoring

## Problems

1. Positive Total Coliform.
2. Chlorine taste and odor.
3. Inability to maintain an adequately free chlorine residual at the furthest points of the distribution system or at dead end lines.

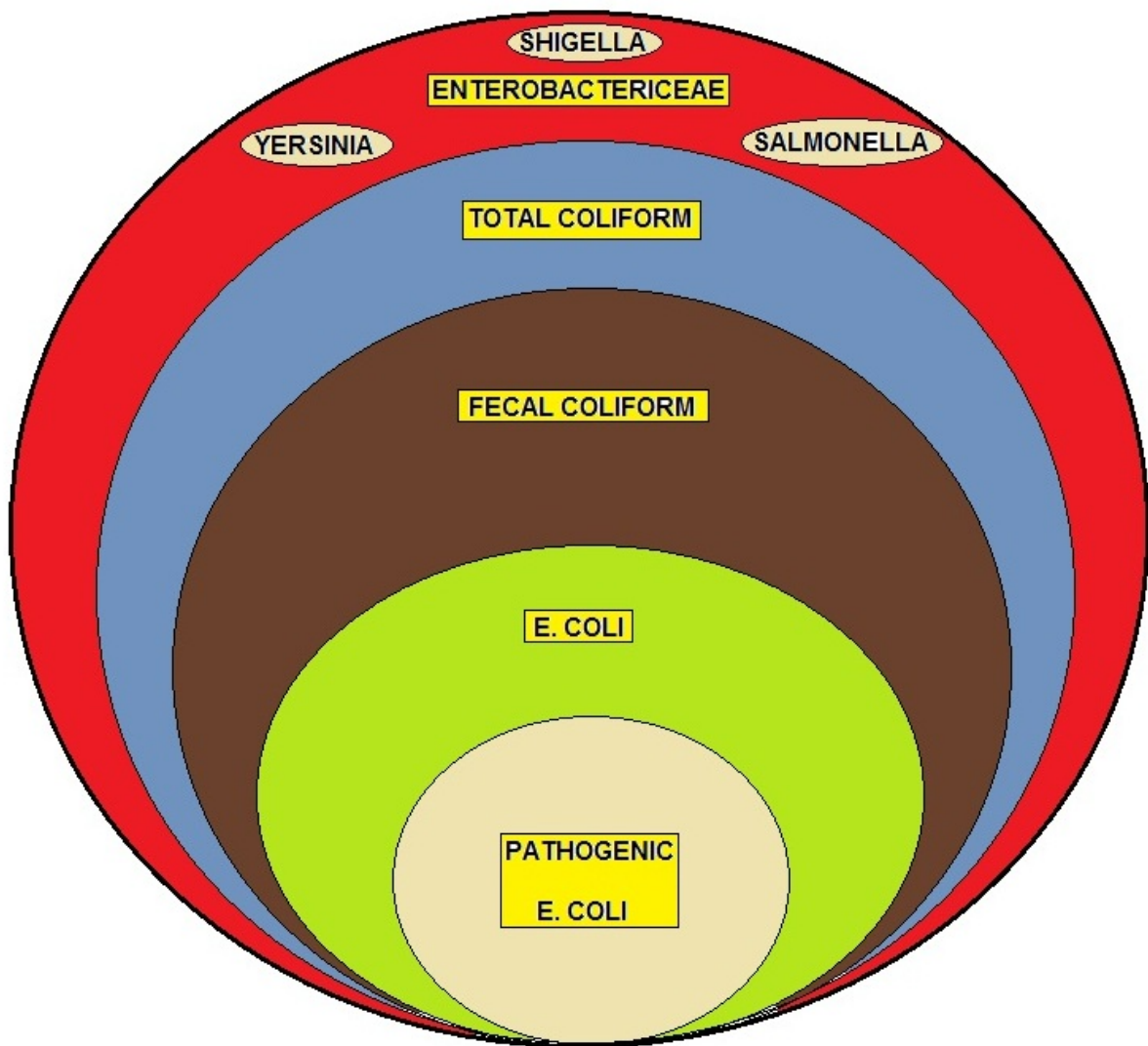
## Possible Causes

- 1A. Improper sampling technique.
- 1B. Contamination entering distribution system.
- 1C. Inadequate chlorine residual at the sampling site.
- 1D. Growth of biofilm in the distribution system.
- 2A. High total chlorine residual and low free residual.
- 3A. Inadequate chlorine dose at treatment plant.
- 3B. Problems with chlorine feed equipment.
- 3C. Ineffective distribution system flushing program.
- 3D. Growth of biofilm in the distribution system.



## Possible Solutions

- 1A. Check distribution system for low-pressure conditions, possibly due to line breaks or excessive flows that may result in a backflow problem.
- 1B. Insure that all staff are properly trained in sampling and transport procedures as described in the TCR.
- 1C. Check the operation of the chlorination feed system. Refer to issues described in the sections on pumps and hypochlorination systems. Insure that residual test is being performed properly.
- 1D. Thoroughly flush effected areas of the distribution system. Superchlorination may be necessary in severe cases.
- 2A. The free residual should be at least 85% of the total residual. Increase the chlorine dose rate to get past the breakpoint in order to destroy some of the combined residual that causes taste and odor problems. Additional system flushing may also be required.
- 3A. Increase chlorine feed rate at point of application.
- 3B. Check operation of chlorination equipment.
- 3C. Review distribution system flushing program and implement improvements to address areas of inadequate chlorine residual.
- 3D. Increase flushing in area of biofilm problem.



**COLIFORM BACTERIA SUB-SET #1  
INDICATOR ORGANISMS**



## Waterborne Pathogen Section - Introduction

Bacteria, viruses, and protozoans that cause disease are known as pathogens. Most waterborne pathogens are generally associated with diseases that cause intestinal illness and affect people in a relatively short amount of time, generally a few days to two weeks. They can cause illness through exposure to small quantities of contaminated water or food or from direct contact with infected people or animals.

Pathogens that may cause waterborne outbreaks through drinking water have one thing in common: they are spread by the fecal-oral (or feces-to-mouth) route. Pathogens may get into water and spread when infected humans or animals pass the bacteria, viruses, and protozoa in their stool. For another person to become infected, he or she must take that pathogen in through the mouth.

Waterborne pathogens are different from other types of pathogens such as the viruses that cause influenza (the flu) or the bacteria that cause tuberculosis. Influenza virus and tuberculosis bacteria are spread by secretions that are coughed or sneezed into the air by an infected person.

Human or animal wastes in watersheds, failing septic systems, failing sewage treatment plants or cross-connections of water lines with sewage lines provide the potential for contaminating water with pathogens. The water may not appear to be contaminated because feces has been broken up, dispersed and diluted into microscopic particles. These particles, containing pathogens, may remain in the water and be passed to humans or animals unless adequately treated.

Only proper treatment and a safe distribution system can ensure eliminating the spread of waterborne disease. In addition to water, other methods exist for spreading pathogens by the fecal-oral route. The foodborne route is one of the more common methods. A frequent source is a food handler who does not wash his hands after a bowel movement and then handles food with “unclean” hands. The individual who eats feces-contaminated food may become infected and ill. It is interesting to note the majority of foodborne diseases occur in the home, not restaurants.

Day care centers are another common source for spreading pathogens by the fecal-oral route. Here, infected children in diapers may get feces on their fingers, then put their fingers in a friend’s mouth or handle toys that other children put into their mouths. You will usually be asked to sample for *Giardia* at these facilities.



**Giardia**

The general public and some of the medical community usually refer to diarrhea symptoms as “*stomach flu*.” Technically, influenza is an upper respiratory illness and rarely has diarrhea associated with it; therefore, stomach flu is a misleading description for foodborne or waterborne illnesses, yet is accepted by the general public. So the next time you get the stomach flu, you may want to think twice about what you’ve digested within the past few days.

### **Chain of Transmission**

This chain lists the events that must occur for the transmission of disease via drinking water. By breaking the chain at any point, the transmission of disease will be prevented. Water is contaminated with feces. This contamination may be of human or animal origin. The feces must contain pathogens (disease-causing bacteria, viruses or protozoa). If the human or animal source is not infected with a pathogen, no disease will result.

The pathogens must survive in the water. This depends on the temperature of the water and the length of time the pathogens are in the water. Some pathogens will survive for only a short time in water, others, such as Giardia or Cryptosporidium, may survive for months.

The pathogens in the water must enter the water system's intake in numbers sufficient to infect people. The water is either not treated or inadequately treated for the pathogens present. A susceptible person must drink the water that contains the pathogen; then illness (disease) will occur.

### **Emerging Waterborne Pathogens**

Emerging waterborne pathogens constitute a major health hazard in both developed and developing nations. A new dimension to the global epidemiology of cholera-an ancient scourge-was provided by the emergence of Vibrio cholerae O139. Also, waterborne enterohemorrhagic Escherichia coli (E. coli O157:H7), although regarded as a problem of the industrialized west, has recently caused outbreaks in Africa.

Outbreaks of chlorine-resistant Cryptosporidium in the US have motivated water authorities to reassess the adequacy of current water-quality regulations. Of late, a host of other organisms, such as hepatitis viruses (including hepatitis E virus), Campylobacter jejuni, microsporidia, cyclospora, Yersinia enterocolitica, calciviruses and environmental bacteria like Mycobacterium spp, aeromonads, Legionella pneumophila and multidrug-resistant Pseudomonas aeruginosa have been associated with water-borne illnesses.

The protection and enhancement of our nation's water quality remains a chief concern of the U.S. Environmental Protection Agency. The Office of Research and Development is committed, through the extensive waterborne disease research efforts earlier described, to ensure that the most effective and efficient methods are developed to identify, detect, and inactivate/remove pathogens that may be present in our drinking water supplies.

Life cycles, mechanisms of infection, protective or dormant states, emergence of disinfection resistant variants, optimal pathogen removal techniques, regrowth in distribution lines...all are areas that must be investigated and understood to afford the water quality safeguards that are so often taken for granted. The successes and failures of these research efforts, relayed to the public and appropriate federal, state, and local agencies, have helped to ensure safe drinking water.

**More on this subject in the Microorganism Appendix. Hyperlink to the Glossary and Appendix <http://www.abctlc.com/downloads/PDF/WTGlossary.pdf>**

## Primary Waterborne Diseases Section - Alphabetical Order

### Campylobacter

Campylobacter, the basics. It is a bacterium. It causes diarrheal illness. Campylobacter is primarily associated with poultry, animals, and humans.

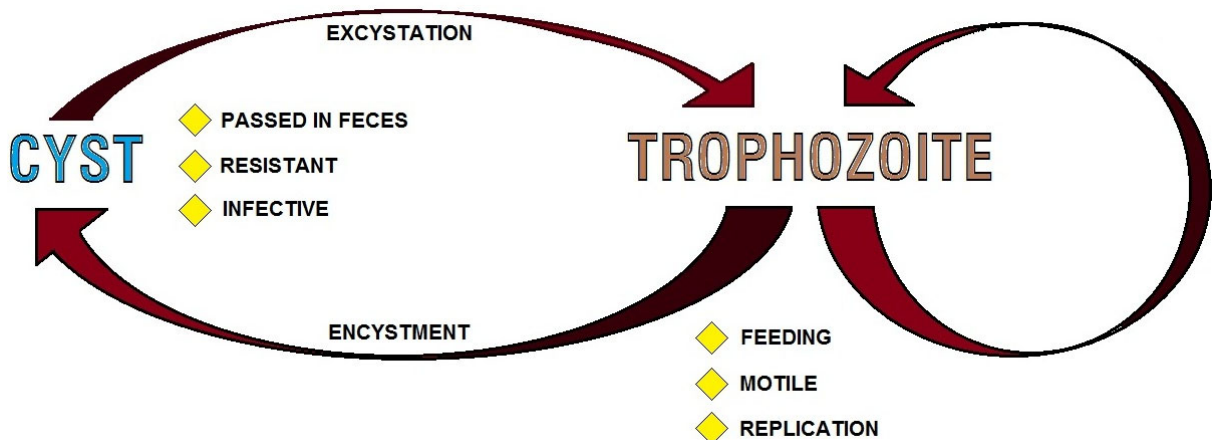
**Campylobacter prevention:** Prevention strategies for this pathogen include source protection, halogenation of water, and boiling water for one minute.

### Cryptosporidium

Cryptosporidium, the basics. It is a parasite. It causes diarrheal illness known as cryptosporidiosis. It is typically associated with animals and humans, and it can be acquired through consuming fecally contaminated food, contact with fecal contaminated soil and water.

**Cryptosporidium, prevention:** Prevention strategies for this pathogen include source protection. A CT value of 9,600 is required when dealing with fecal accidents. CT equals a concentration, in parts per million, while time equals a contact time in minutes. Cryptosporidium can also be prevented or eliminated by boiling water for one minute.

Filtration with an "*absolute*" pore size of one micron or smaller can eliminate Cryptosporidium, and reverse osmosis is known to be effective as well.



**TYPICAL FECAL-ORAL LIFE CYCLE DIAGRAM**

### E-Coli Section

Escherichia coli. Escherichia coli O157:H7, the basics. It's a bacteria. There are several pathogenic strains of Escherichia coli, which are classified under enterovirulent E. coli. They are enterohemorrhagic, enteroinvasive, enterotoxigenic, enteropathogenic, and enteroaggregative causes diarrheal illness, and it's classified as an enterohemorrhagic E. coli. In its most severe form, it can cause hemorrhagic colitis. The reservoir for this bacteria are cattle, deer, goats, and sheep. Humans can also be a reservoir. It is typically associated with contaminated food and water.

**E. coli O157:H7 prevention:** Prevention strategies for this pathogen include source protection, halogenation of water, or boiling water for one minute.

### **Giardia**

Giardia, the basics. It is a parasite. It causes diarrheal illness known as giardiasis. It is typically associated with water. It is the most common pathogen in waterborne outbreaks. It can also be found in soil and food, and humans and animals are the reservoir for this pathogen.

**Giardia prevention:** Prevention strategies for this pathogen include source protection; filtration, coagulation, and halogenation of drinking water.

### **Hepatitis A**

Hepatitis A, the basics. It is a virus. It causes inflammation of the liver, and the reservoir for Hepatitis A virus is humans.

**Hepatitis A, Prevention:** Prevention strategies for this pathogen include source protection and adequate disinfection. Fecal matter can protect Hepatitis A virus from chlorine. Additionally, Hepatitis A virus is resistant to combined chlorines, so it is important to have an adequate free chlorine residual.

### **Legionella**

Legionella, the basics. It is a bacterium. It causes a respiratory illness known as Legionellosis. There are two illnesses associated with Legionellosis: the first, Legionnaire's disease, which causes a severe pneumonia, and the second, Pontiac fever, which is a non-pneumonia illness; it is typically an influenza-like illness, and it's less severe. Legionella is naturally found in water, both natural and artificial water sources.

**Legionella, prevention:** Maintaining hot water systems at or above 50 degrees Centigrade and cold water below 20 degrees Centigrade can prevent or control the proliferation of Legionella in water systems. Hot water in tanks should be maintained between 71 and 77 degrees Centigrade.

Proper recreational water system maintenance and disinfection can prevent the proliferation of Legionella in recreational water systems. It is important to prevent water stagnation. This can be accomplished by eliminating dead ends in distribution systems and in recreational water systems. Additionally, preventing biofilm development is important to control this particular pathogen in water systems.

### **Norovirus**

Norovirus, the basics. It is a virus. It causes diarrheal illness, and humans are the reservoir for this virus.

**Norovirus, prevention:** Prevention strategies for this pathogen include source protection.

### **Pseudomonas**

Pseudomonas, the basics. It is a bacterium. It is caused by dermal contact with water. It can cause dermatitis, which is an inflammation of the skin, or it can cause otitis, which is an infection of the ear. Pseudomonas is typically associated with soil and water.

**Pseudomonas prevention:** Proper maintenance and disinfection of recreational water systems is important in preventing Pseudomonas.

### **Salmonella Typhi**

Salmonella typhi, the basics. It is a bacterium. It causes diarrheal illness, also known as typhoid fever. Humans are the reservoir for this pathogen. Salmonella species, the basics. It is a bacterium. It causes diarrheal illness known as salmonellosis.

Humans and animals are the reservoir, and it has typically associated with contaminated food and water. Salmonella species, prevention. Prevention strategies for this pathogen include source protection, halogenation of water, and boiling water for one minute.

**Salmonella typhi, prevention:** Prevention strategies for this pathogen include source protection, chlorination or halogenation of water, and boiling water for one minute.

### **Schistosomatidae**

Schistosomatidae, the basics. It is a parasite. It is acquired through dermal contact, cercarial dermatitis. It is commonly known as swimmer's itch. The reservoir for this pathogen are aquatic snails and birds.

**Schistosomatidae prevention:** Prevention strategies for this pathogen include eliminating snails with a molluscicide or interrupting the life cycle of the parasite by treating birds with an antihelminthic drug.

### **Shigella Species**


Shigella species, the basics. It is a bacterium. It causes diarrheal illness known as shigellosis. Humans and primates are the reservoir for this pathogen. Shigella species, in the United States two-thirds of the shigellosis in the U.S. is caused by Shigella sonnei, and the remaining one-third is caused by Shigella flexneri. In developing countries, Shigella dysenteriae is the primary cause of illness associated with this pathogen.

**Shigella species prevention:** Prevention strategies for this pathogen include source protection, halogenation of water, and boiling water for one minute.

### **Vibrio Cholerae**

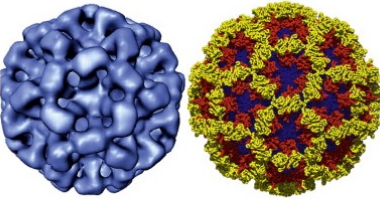
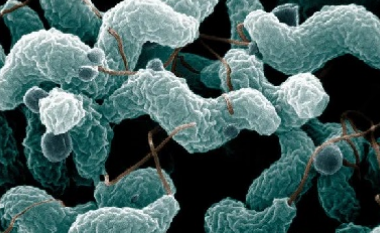
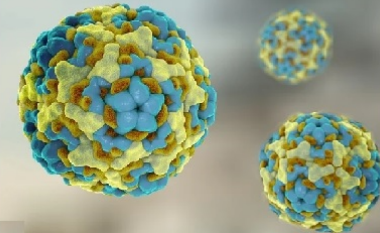

Vibrio cholerae, the basics. It is a bacterium. It causes diarrheal illness, also known as cholera. It is typically associated with aquatic environments, shell stocks, and human. Vibrio cholerae has also been associated with ship ballast water, and there will be a discussion later on in this presentation of an outbreak associated with ship ballast water.

**Vibrio cholerae prevention:** Prevention strategies for this pathogen include source protection, halogenation of water, and boiling water for one minute.

<b>PRESENCE OF PATHOGENS IN WATER</b>	<h2 style="margin: 0;">TYPES OF PATHOGENS FOUND IN WATER</h2> 
THE PRESENCE OF COLIFORM BACTERIA CAN INDICATE THERE MAY BE HARMFUL BACTERIA PATHOGENS IN THE WATER	
THE PRINCIPAL REMOVAL PROCESSES ARE THOSE LIKELY USED TO REMOVE THE MAJORITY OF THE MICROBES IN WATER BEING TREATED	
THE REMOVAL PROCESSES BEING UTILIZED ARE SEDIMENTATION, FLOTATION AND THE USE OF HIGH RATE GRANULAR MEDIA FILTRATION	
DISINFECTION WITH IODINE OR CHLORINE IS THE MOST EFFECTIVE AT KILLING VIRUSES FOUND IN WATER.	



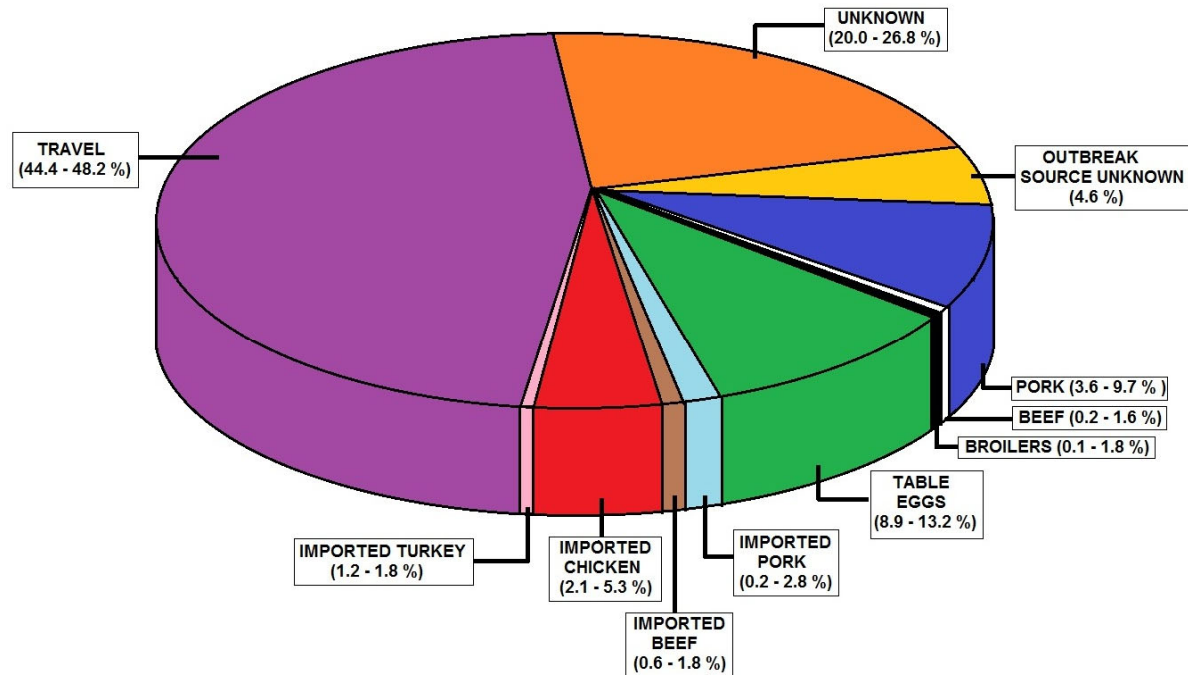
### PATHOGENS FOUND IN WATER SUPPLIES

<b>MICROBIOLOGICAL CONTAMINANTS FOUND IN WATER</b>	
THESE ARE OFTEN OF FECAL NATURE RELATED TO HUMANS, DOMESTIC ANIMALS OR WILDLIFE	
<p><b><u>CALIVIVIRUS:</u></b></p> <p>SIGNS OF THIS VIRUS INCLUDE SNEEZING, NASAL DISCHARGE, OCULAR DISCHARGE, CONJUNCTIVITIS, ULCERATION OF THE TONGUE, LETHARGY, INAPPETENCE (Lack of Appetite) AND FEVER</p>	
<p><b><u>CAMPYLOBACTER JEJUNI:</u></b></p> <p>THIS IS ONE OF THE MOST COMMON CAUSES OF FOOD POISONING. IT IS CHARACTERIZED BY DIARRHEA, ABDOMINAL PAIN, FEVER, NAUSEA AND SOMETIMES VOMITING</p>	
<p><b><u>ENTEROVIRUS:</u></b></p> <p>SYMPTOMS OF THIS VIRUS INFECTION MAY INCLUDE FEVER, RUNNY NOSE, SNEEZING, COUGH, SKIN RASH, MOUTH BLISTERS, AND BODY AND MUSCLE ACHES</p>	
<p><b><u>ESCHERICHIA COLI:</u></b></p> <p>NORMALLY LIVES IN THE INTESTINES OF HEALTHY PEOPLE AND ANIMALS. MOST E.Coli ARE HARMLESS OR RELATIVELY BRIEF DIARRHEA. SOME E.Coli CAN CAUSE SEVERE STOMACH CRAMPS, BLOODY DIARRHEA AND VOMITING</p>	



### MICROBIOLOGICAL CONTAMINANTS

## Common Waterborne Bacterial Diseases



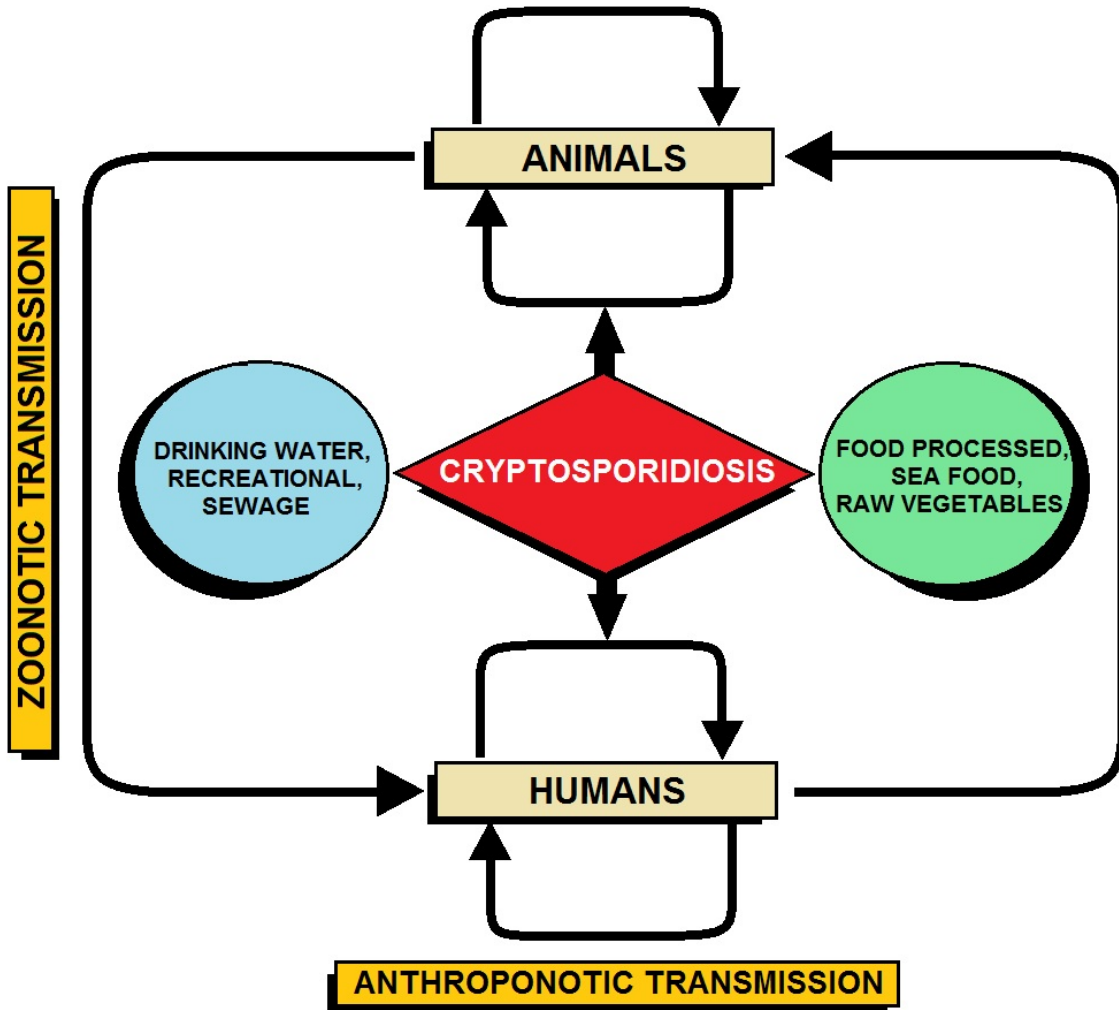
**COURSES OF SAMONELLA PIE CHART**

**Campylobacteriosis** is the most common diarrheal illness caused by bacteria. Other symptoms include abdominal pain, malaise, fever, nausea and vomiting; and begin three to five days after exposure. The illness is frequently over within two to five days and usually lasts no more than 10 days.

**Campylobacteriosis** outbreaks have most often been associated with food, especially chicken and un-pasteurized milk, as well as un-chlorinated water. These organisms are also an important cause of “*travelers’ diarrhea.*” Medical treatment generally is not prescribed for campylobacteriosis because recovery is usually rapid.

**Cholera, Legionellosis, salmonellosis, shigellosis, yersiniosis,** are other bacterial diseases that can be transmitted through water. All bacteria in water are readily killed or inactivated with chlorine or other disinfectants.

**Gastroenteritis** is an intestinal infection marked by watery diarrhea, abdominal cramps, nausea or vomiting, and sometimes fever. The most common way to develop viral gastroenteritis — often called stomach flu — is through contact with an infected person or by ingesting contaminated food or water. Because the symptoms are similar, it's easy to confuse viral diarrhea with diarrhea caused by bacteria, such as *Clostridium difficile*, salmonella and *E. coli*, or parasites, such as giardia.



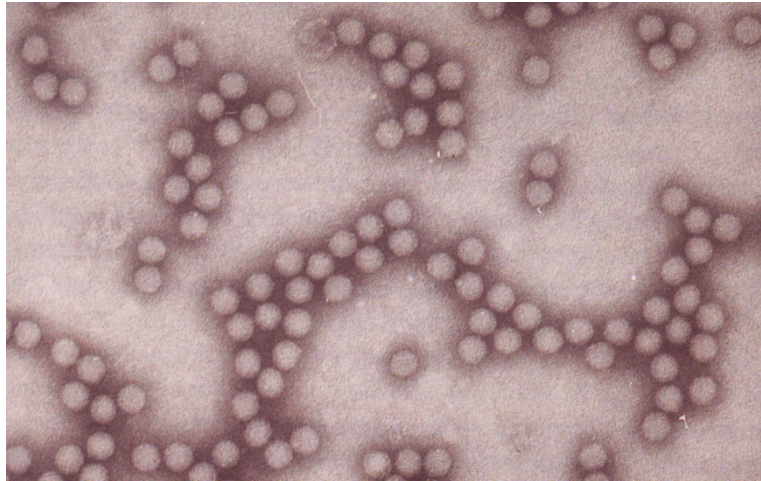
**TRANSMISSION OF CRYPTOSPORIDIOSIS**





## Waterborne Viral Diseases

- Drinking water must be free from viruses.
- Sometime viruses from intestinal tract of infected person get access to water along with feces.
- Some intestinal pathogenic viruses which are transmitted through contaminated water are- Rotavirus, Poliovirus, Hepatitis A and E, etc.



**Hepatitis A** is an example of a common viral disease that may be transmitted through water. The onset is usually abrupt with fever, malaise, loss of appetite, nausea and abdominal discomfort, followed within a few days by jaundice. The disease varies in severity from a mild illness lasting one to two weeks, to a severely disabling disease lasting several months (rare). The incubation period is 15-50 days and averages 28-30 days.

Hepatitis A outbreaks have been related to fecally contaminated water; food contaminated by infected food handlers, including sandwiches and salads that are not cooked or are handled after cooking, and raw or undercooked mollusks harvested from contaminated waters. Aseptic meningitis, polio and viral gastroenteritis (*Norwalk agent*) are other viral diseases that can be transmitted through water. Most viruses in drinking water can be inactivated by chlorine or other disinfectants.

### **Norovirus**

Norovirus, sometimes referred to as the winter vomiting bug, is the most common cause of gastroenteritis. Infection is characterized by non-bloody diarrhea, vomiting, and stomach pain. Fever or headaches may also occur. Symptoms usually develop 12 to 48 hours after being exposed, and recovery typically occurs within 1 to 3 days. Complications are uncommon, but may include dehydration, especially in the young, the old, and those with other health problems.

The virus is usually spread by the fecal–oral route. This may be through contaminated food or water or person-to-person contact. It may also spread via contaminated surfaces or through air from the vomit of an infected person. Risk factors include unsanitary food preparation and sharing close quarters.

Diagnosis is generally based on symptoms. Confirmatory testing is not usually available but may be performed during outbreaks by public health agencies.

Norovirus results in about 685 million cases of disease and 200,000 deaths globally a year. It is common both in the developed and developing world. Those under the age of five are most often affected, and in this group it results in about 50,000 deaths in the developing world. Norovirus infections occur more commonly during winter months. It often occurs in outbreaks, especially among those living in close quarters. In the United States, it is the cause of about half of all foodborne disease outbreaks. The virus is named after the city of Norwalk, Ohio, where an outbreak occurred in 1968.

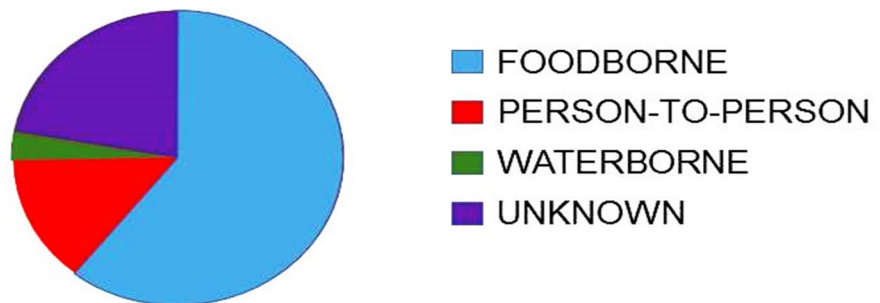
**Coronavirus**

It looks like the COVID-19 coronavirus may be able to live in water for a few days, potentially even a few weeks. Consider what is known about the severe acute respiratory syndrome coronavirus 2 (SARS-CoV-2) in water. Indeed studies have suggested that the SARS-CoV2 could actually hang out in the wet stuff for a little while.

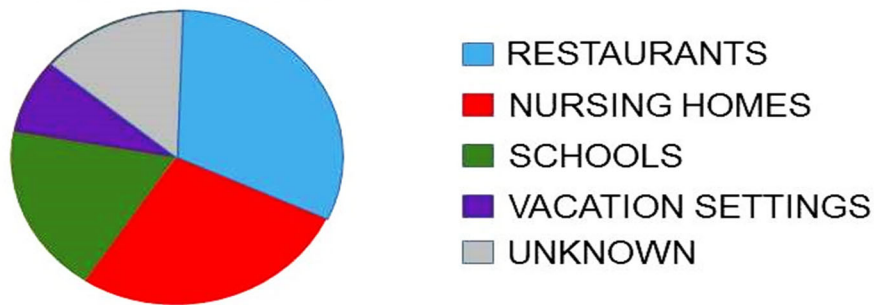
**SARS Virus**

For example, a study published in the journal Water Research in 2009 found that two viruses that have similarities to the original SARS virus, the transmissible gastroenteritis (TGEV) and mouse hepatitis (MHV) viruses, could survive up to days and even weeks in water. The University of North Carolina team (Lisa Casanova, William A. Rutal, David J. Weber, and Mark D. Sobsey) that conducted the study concluded that “coronaviruses can remain infectious for long periods in water and pasteurized settled sewage, suggesting contaminated water is a potential vehicle for human exposure if aerosols are generated.”

**A. SOURCE OF NOROVIRUS**



**B. SETTING FOR OUTBREAK**



## Waterborne Protozoan Diseases

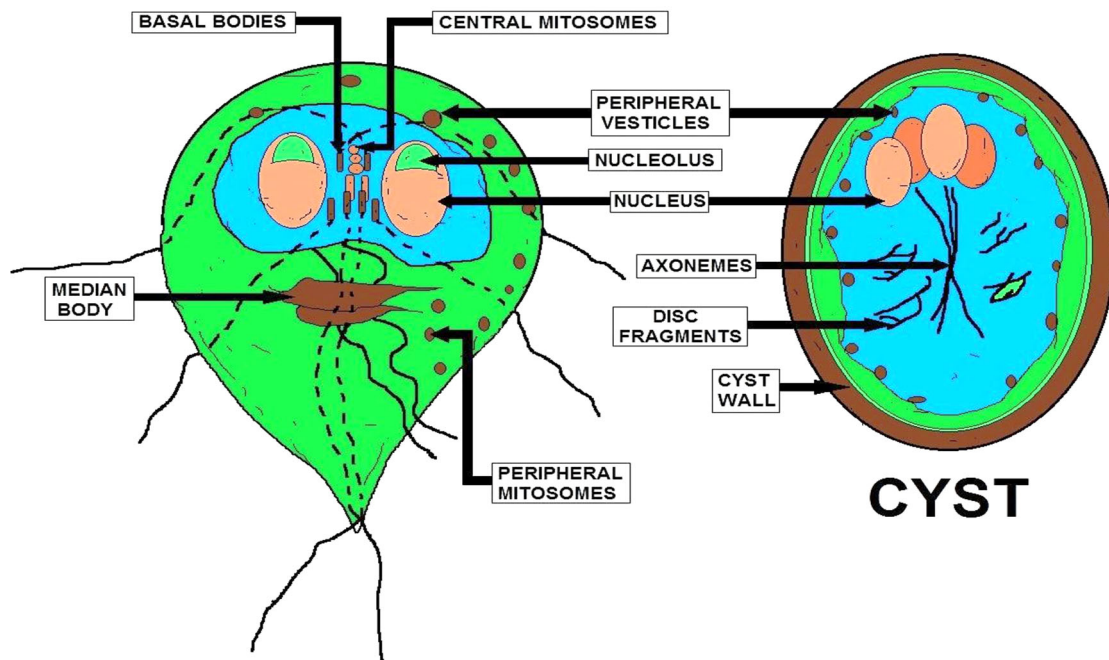
Protozoan pathogens are larger than bacteria and viruses, but still microscopic. They invade and inhabit the gastrointestinal tract. Some parasites enter the environment in a dormant form, with a protective cell wall called a “cyst.” The cyst can survive in the environment for long periods of time and be extremely resistant to conventional disinfectants such as chlorine. Effective filtration treatment is therefore critical to removing these organisms from water sources.

**Giardiasis** is a commonly reported protozoan-caused disease. It has also been referred to as “backpacker’s disease” and “beaver fever” because of the many cases reported among hikers and others who consume untreated surface water.

Symptoms include chronic diarrhea, abdominal cramps, bloating, frequent loose and pale greasy stools, fatigue and weight loss. The incubation period is 5-25 days or longer, with an average of 7-10 days.

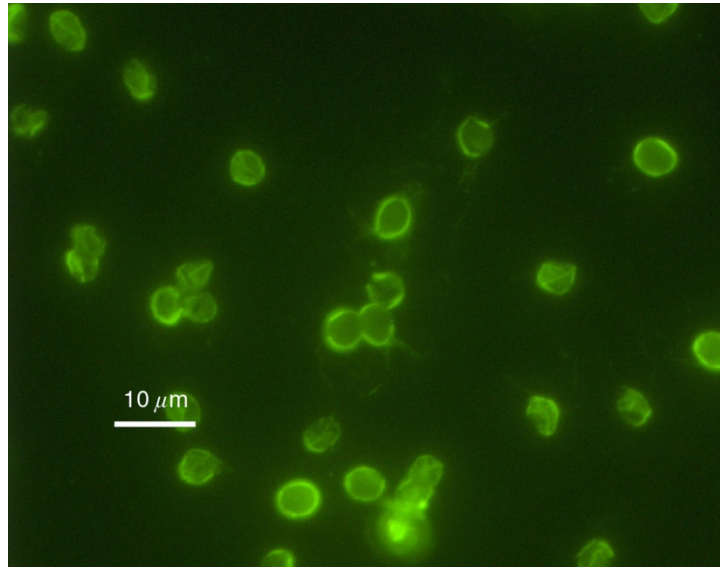
Many infections are asymptomatic (no symptoms). Giardiasis occurs worldwide. Waterborne outbreaks in the United States occur most often in communities receiving their drinking water from streams or rivers without adequate disinfection or a filtration system.

- Drinking water should be free from disease causing parasites.
- Many species of protozoa and helminthes that causes water borne disease contaminates water through feces of infected patients.



The organism, *Giardia lamblia*, has been responsible for more community-wide outbreaks of disease in the U.S. than any other pathogen. Drugs are available for treatment, but these are not 100% effective.

## Cryptosporidiosis



**Cryptosporidiosis** is an example of a protozoan disease that is common worldwide, but was only recently recognized as causing human disease. The major symptom in humans is diarrhea, which may be profuse and watery.

The diarrhea is associated with cramping abdominal pain. General malaise, fever, anorexia, nausea, and vomiting occur less often. Symptoms usually come and go, and end in fewer than 30 days in most cases. The incubation period is 1-12 days, with an average of about seven days. *Cryptosporidium* organisms have been identified in human fecal specimens from more than 50 countries on six continents.

The mode of transmission is fecal-oral, either by person-to-person or animal-to-person. There is no specific treatment for *Cryptosporidium* infections. All these diseases, with the exception of hepatitis A, have one symptom in common: diarrhea. They also have the same mode of transmission, fecal-oral, whether through person-to-person or animal-to-person contact, and the same routes of transmission, being either foodborne or waterborne.

Although most pathogens cause mild, self-limiting disease, on occasion, they can cause serious, even life threatening illness. Particularly vulnerable are persons with weak immune systems, such as those with HIV infections or cancer.

By understanding the nature of waterborne diseases, the importance of properly constructed, operated and maintained public water systems becomes obvious. While water treatment cannot achieve sterile water (no microorganisms), the goal of treatment must clearly be to produce drinking water that is as pathogen-free as possible at all times.

For those who operate water systems with inadequate source protection or treatment facilities, the potential risk of a waterborne disease outbreak is real. For those operating systems that currently provide adequate source protection and treatment, operating and maintaining the system at a high level on a continuing basis is critical to prevent disease.

## Common Waterborne Diseases Chart

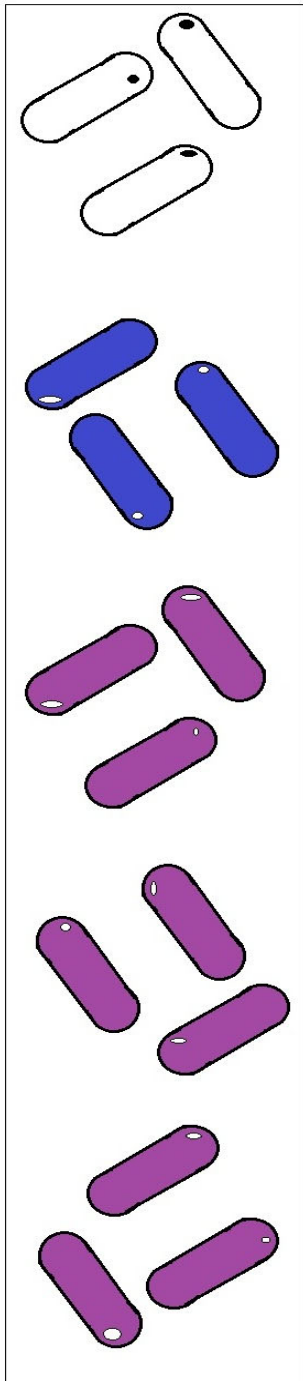
Name	Causative organism	Source of organism	Disease
Viral gastroenteritis	<b>Rotavirus</b> (mostly in young children)	Human feces	Diarrhea or vomiting
Norwalk Agent	<b>Noroviruses</b> (genus <i>Norovirus</i> , family <i>Caliciviridae</i> ) *1	Human feces; also, shellfish; lives in polluted waters	Diarrhea and vomiting
Salmonellosis	<b>Salmonella</b> (bacterium)	Animal or human feces	Diarrhea or vomiting
Gastroenteritis <i>Escherichia coli</i>	-- <b><i>E. coli</i> O157:H7</b> (bacterium): Other <i>E. coli</i> organisms:	Human feces	Symptoms vary with type caused
Typhoid	<b>Salmonella typhi</b> (bacterium)	Human feces, urine	Inflamed intestine, enlarged spleen, high temperature—sometimes fatal
Shigellosis	<b>Shigella</b> (bacterium)	Human feces	Diarrhea
Cholera	<b>Vibrio choleras</b> (bacterium)	Human feces; also, shellfish; lives in many coastal waters	Vomiting, severe diarrhea, rapid dehydration, mineral loss—high mortality
Hepatitis A	<b>Hepatitis A virus</b>	Human feces; shellfish grown in polluted waters	Yellowed skin, enlarged liver, fever, vomiting, weight loss, abdominal pain—low mortality, lasts up to four months
Amebiasis	<b>Entamoeba histolytica</b> (protozoan)	Human feces	Mild diarrhea, dysentery, extra intestinal infection
Giardiasis	<b>Giardia lamblia</b> (protozoan)	Animal or human feces	Diarrhea, cramps, nausea, and general weakness — lasts one week to months
Cryptosporidiosis	<b>Cryptosporidium parvum</b>	Animal or human feces	Diarrhea, stomach pain — lasts (protozoan) days to weeks

Notes:

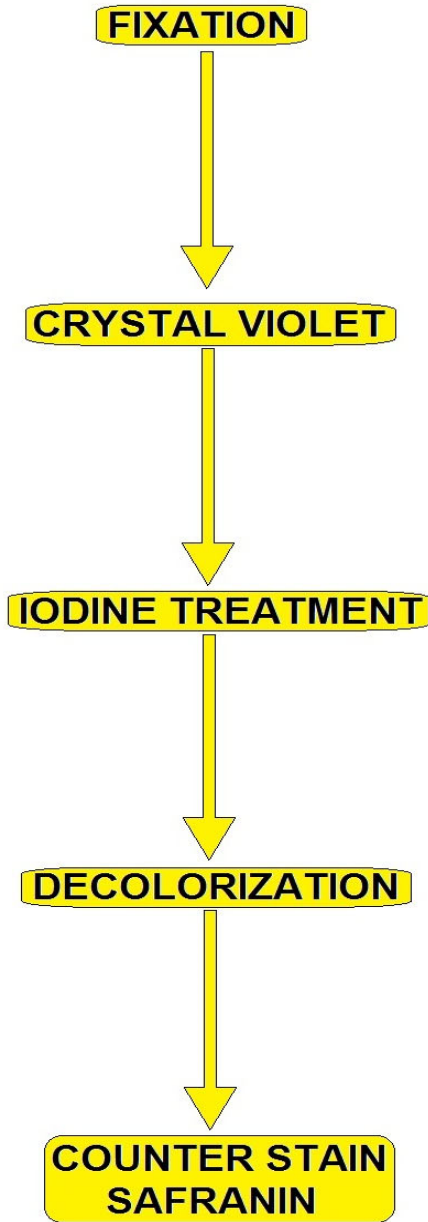
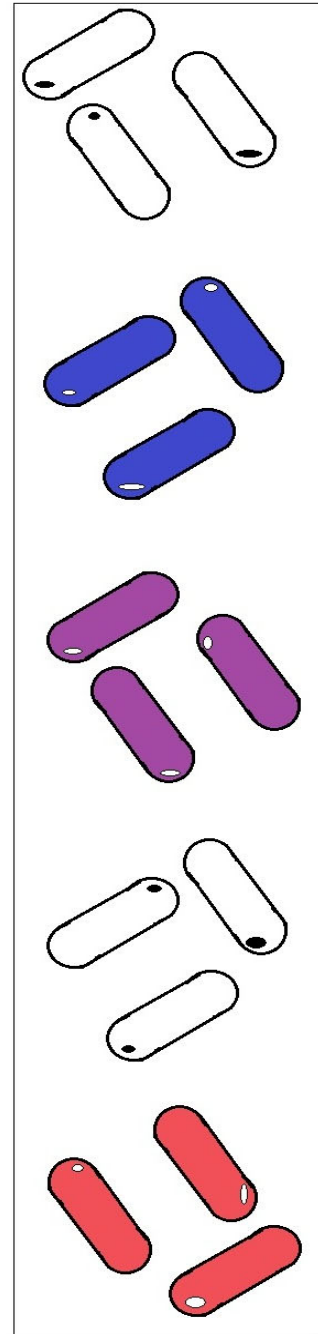
\*1 <http://www.cdc.gov/ncidod/dvrd/revb/gastro/norovirus.htm>

<http://www.cdc.gov/mmwr/preview/mmwrhtml/rr5009a1.htm>

**Gram Positive**



**Gram Negative**



**GRAM STAINING DIAGRAM**

## Sampling Procedures –Sub-Section

The sample siting plan must be followed and all operating staff must be clear on how to follow the sampling plan. In order to properly implement the sample-siting plan, staff must be aware of how often sampling must be done, the proper procedures and sampling containers to be used for collecting the samples, and the proper procedures for identification, storage and transport of the samples to an approved laboratory.

In addition, proper procedures must be followed for repeat sampling whenever a routine sample result is positive for total coliform.

### What is a Sample Siting Plan?

A written sample siting plan specifies the routine sampling schedule and the locations (i.e., routine and repeat) in the distribution system where TC samples are collected. The locations selected must be representative of the finished water supplied to consumers. The purpose of sampling is to identify any coliform contamination so it can be dealt with quickly. Sample siting plans are subject to primacy agency review and revision. A sample siting plan must include the:

- PWS's sample sites (i.e., the location) where routine and repeat samples are collected: if approved by the primacy agency, also include sample sites for dual purpose samples that are used to meet the requirements for the RTCR repeat sampling and the Ground Water Rule (GWR) triggered source water monitoring.
- PWS's schedule for collecting the routine samples: For example, "[PWS\_ID] will collect one routine TC sample every first Tuesday of the calendar month." The sample siting plan is a living document and should be updated to reflect changes to the PWS such as: major changes in population; new or additional water sources; infrastructure changes, such as a change in the distribution system (i.e., extended/ abandoned lines or pressure zones); or changes in disinfection or other treatment.



Most everyone can learn and master many of the basic lab procedures. Don't be intimidated, learn to take samples and analysis; it is an excellent career.

## Chain of Custody Procedures Example

Because a sample is physical evidence, chain of custody procedures are used to maintain and document sample possession from the time the sample is collected until it is introduced as evidence.

Chain of custody requirements will vary from agency to agency. However, these procedures are similar and the chain of custody procedure outlined in this course manual is only a guideline. Consult your project manager or state agency for specific requirements.

If you have physical possession of a sample, have it in view, or have physically secured it to prevent tampering then it is defined as being in "*custody*." A chain of custody record, therefore, begins when the sample containers are obtained from the laboratory. From this point on, a chain of custody record will accompany the sample containers.

Handle the samples as little as possible in the field. Each custody sample requires a chain of custody record and may require a seal. If you do not seal individual samples, then seal the containers in which the samples are shipped.

When the samples transfer possession, both parties involved in the transfer must sign, date and note the time on the chain of custody record. If a shipper refuses to sign the chain-of-custody you must seal the samples and chain of custody documents inside a box or cooler with bottle seals or evidence tape.

The recipient will then attach the shipping invoices showing the transfer dates and times to the custody sheets. If the samples are split and sent to more than one laboratory, prepare a separate chain of custody record for each sample. If the samples are delivered to after-hours night drop-off boxes, the custody record should note such a transfer and be locked with the sealed samples inside sealed boxes.



Using alcohol to disinfect a special sample tap before obtaining a sample.



<b>LAB I.D. NUMBER</b>																							
<b>Laboratory</b> 123 W. Main St Sun City, Arizona 85541																							
DATE: _____ PAGE 1 OF 1																							
Sampler: _____																							
Company: _____ Department: _____ Address: _____ Contact: _____ Telephone: _____																							
Sample Identification	Date	Time	Matrix	Lab ID	Metals* See Attached	TSS	Lead/Copper	BOD/COD	Nitrate	Nitrate + Nitrite	TKN / Amonia	VOC / THM's	Semi Volital Organics (625)	Chloride	Cyanide	Floride	Surfactants (MBAS)	Tot. Coliform MPN	Fecal Coliform MPN-HPC	Organo-Phosphorus Pest. (8141)	Sulfate	EC Conductivity	Number/Containers
<b>Sample Receipt</b>																							
Project Name					No. Containers: _____ Custody Seals: _____ Received Intact: _____ Received Cold: _____ Temperature: _____ PRIORITY: _____																		
Project Number					Yes No Yes No																		
Field Measurements:					pH: _____ Temp: _____																		
RELINQUISHED BY:					Signature: _____ Time: _____ Printed Name: _____ Date: _____ Company: _____																		
SAMPLED RECEIVED BY:					Signature: _____ Time: _____ Printed Name: _____ Date: _____ Company: _____																		

Chain of Custody Example.



Various water sample bottles and chain-of-custody form.

## Common Water Quality and Sampling Questions and Review

*These statements will be more explained in the previous chapters.*

### **1. What are the correct procedures to follow in collecting bacteriological samples?**

Use a sterile plastic or glass bottle. Sodium thiosulfate should be added to neutralize the chlorine residual. Refrigerate the sample to 4° C. The regulations call for a minimum of five samples for the month from any system that has positive sample results. Small systems that take only one sample per month have to take four (4) repeats when they get a total coliform positive test result. If any system has to take repeat samples, it must also take a minimum of five (5) routine samples the following month. Small systems that normally take less than 5 samples/month will have to increase the number to 5 samples. They can return to normal sampling schedules the following month if no repeats are required.

### **2. What are the proper sampling techniques for microbiological sampling?**

Proper sampling techniques are extremely important in obtaining accurate water quality information. An improperly taken coliform sample may indicate bacteriological contamination of your water when the water is actually safe. You can avoid the cost of additional testing by using good sampling procedures. Carefully follow these steps in taking a sample for bacteriological testing:

1. Select the sampling point. The sampling point must be a faucet from which water is commonly taken for public use.

The sampling point should be a non-swivel faucet.

Remove any aerator or screen and flush.

It should not be a faucet that leaks, permitting water to run over the outside of the faucet. Leaking faucets can promote bacterial growth.

If an outside faucet must be used, disconnect any hoses or other attachments and be sure to flush the line thoroughly.

Do not use fire hydrants as sampling points. Do not dip the bottle in reservoirs, spring boxes or storage tanks in order to collect the sample.

### **3. What do the following abbreviations stand for and what do they mean: gpm, MGD, TTHM, psi, HAA, NTU, and mg/L.**

Gallons per minute- Million Gallons a Day - Total Trihalomethanes – Pounds Per Square Inch –Haloacetic acids - Nephelometric turbidity unit -Milligrams Per Liter

### **4. What is the relationship between mg/L and ppm; ug/L and ppb?**

**Milligram per liter:** Milligram per liter of substance and part per million are equal amounts in water. While you can easily convert between micrograms/liter and milligrams/liter, and between PPM and PPB, it's not so easy to convert between the different types of units such as milligrams/liter to PPM.

To convert micrograms per liter to milligrams per liter, divide by 1000.

To convert to PPM, you would first need to know the density of the substance, and the density of what the substance is in.

**5. Ug/L:** Represents the concentration of something in water or soil. One ppb represents one microgram of something per liter of water (ug/l), or one microgram of something per kilogram of soil (ug/kg).

*Parts per million (ppm) or Milligrams per liter (mg/l) - one part per million corresponds to one minute in two years or a single penny in \$10,000.*

*Parts per billion (ppb) or Micrograms per liter - one part per billion corresponds to one minute in 2,000 years, or a single penny in \$10,000,000.*

*Parts per trillion (ppt) or Nanograms per liter (nanograms/l) - one part per trillion corresponds to one minute in 2,000,000 years, or a single penny in \$10,000,000,000.*

**6. What do the following terms represent in reference to water quality.**

**Total coliform:** The coliform family has been divided into two groups. Results may come back as either total coliform positive (TC positive) or fecal coliform positive, or (FC positive or *E. coli* positive.) Total coliform positive means that no human coliform are present.

**7. Fecal Coliform:** Fecal coliform positive indicates the presence of *E. coli*, which means there is a greater chance of pathogens being present. The laboratory tests for coliform include the MPN method, the Membrane Filter test, the Colilert test, and the presence-absence test.

**8. Presence-absence Test:** Presence-Absence Broth is used for the detection of coliform bacteria in water treatment plants or distribution systems using the presence-absence coliform test.

**9. Physical Characteristics of Water:** A characteristic of water defined by the temperature, turbidity, color, taste, and odor of the water.

**10. Point-of-entry sample (POE):** A type of water sample taken after treatment and before reaching the first consumer.

**11. Acute Health Effect:** An immediate (i.e. within hours or days) effect that may result from exposure to certain drinking water contaminants (e.g., pathogens).

**12. Non-acute violation:** If the MCL is exceeded and none of the positive results indicated a presence of Fecal Coliform, a Tier 2 violation has occurred. This level of violation used to be called a non-acute violation.

**13. Routine Sample:** Samples collected on a routine basis to monitor for contamination. Collection should be in accordance with an approved sampling plan.

**14. Repeat Sample:** Short answer... Samples collected following a '*coliform present*' routine sample. The number of repeat samples to be collected is based on the number of routine samples you normally collect.

**Long Answer.** Anytime a microbiological sample result comes back positive, indicating the presence of total or fecal coliform/ E.coli, repeat samples must be taken. Three repeats are usually required. One must be taken at the site of the positive sample. The two samples must be taken upstream and downstream of the original site (within five service connections). These repeat samples must be taken within 24 hours of notification of positive results.

They must be identified as a Repeat Sample on the sample form. Repeat samples may be required to be sealed with a red evidentiary seal tape. The tape must cover the cap and extend down the sides of the bottle. The sample forms must also include the reference number for the positive sample.

There is an important exception to the three repeat samples rule. The regulations also state that when repeats are taken the minimum number of samples is raised to five for the month. A system that collects just one sample a month must collect four repeat samples, when the sample is positive, in order to have five samples as required.

Whenever a system has to take repeat samples, a minimum of five routine samples must also be submitted the following month. This is only an issue for systems that normally turn in four or fewer samples each month. If the five samples are negative the system can return to its normal sampling schedule the next month.

Small systems that have fewer than four sampling sites have a problem complying with the “upstream and downstream” aspects of the repeat sampling requirements. In this case, samples should be taken at as many separate sites as possible and then wait a minimum of 2 hours before resampling enough sites to get the required number of samples. Repeat sample with red seal tape.

**15. Treatment technique:** An enforceable procedure or level of technical performance which public water systems must follow to ensure control of a contaminant.

**16. Action level:** The level of lead or copper which, if exceeded, triggers treatment or other requirements that a water system must follow.

**17. What does the membrane filter test analyze with regards to bacteriological sampling?**

**Membrane Filter Technique:** A standard test used for measuring coliform numbers (quantity) in water is the membrane filter technique. This technique involves filtering a known volume of water through a special sterile filter. These filters are made of nitrocellulose acetate and polycarbonate, are 150 µm thick, and have 0.45 µm diameter pores. A grid pattern is printed on these filter disks in order to facilitate colony counting. When the water sample is filtered, bacteria (larger than 0.45 µm) in the sample are trapped on the surface of the filter. The filter is then carefully removed, placed in a sterile petri plate on a pad saturated with a liquid medium, and incubated for 20-24 hours at 37°C.

One assumes that each bacterium trapped on the filter will then grow into a separate colony. By counting the colonies one can directly determine the number of bacteria in the water sample that was filtered. The broth medium usually employed in detecting total coliforms is M-Endo Broth MF. Total coliform colonies will be pink to dark red in color and will appear to have a golden green color.

**18. What do the following terms mean in relation to drinking water quality: disinfection, pathogenic, toxic, pH, aesthetic, culinary and potable.**

**Disinfection:** The chemical process of killing or inactivating most microorganisms in water. See also Sterilization.

**19. Pathogenic:** Organisms or bugs that cause disease. These include bacteria, viruses, cysts and anything capable of causing disease in humans, like cryptosporidiosis, typhoid, cholera and so on. There are other organisms that do not create disease, these are called non-pathogenic organisms.

**20. Toxic:** Stuff that will kill you. A substance which is poisonous to living organisms.

**21. pH:** A measure of the acidity of water. The pH scale runs from 0 to 14 with 7 being the mid-point or neutral. A pH of less than 7 is on the acid side of the scale with 0 as the point of greatest acid activity. A pH of more than 7 is on the basic (alkaline) side of the scale with 14 as the point of greatest basic activity. For example, the acidity of a sample with a pH of **5** is ten times greater than that of a sample with a pH of **6**. A difference of 2 units, from **6** to **4**, would mean that the acidity is one hundred times greater, and so on. Normal rain has a pH of **5.6** – slightly acidic because of the carbon dioxide picked up in the earth's atmosphere by the rain.

**22. Aesthetic:** Attractive or appealing water or things in water that will not make you sick but may appear to change the water's color or taste.

**23. Culinary:** Having to do with cooking food. Potable water is often called culinary water.

**24. Potable:** Water that is free of objectionable pollution, contamination, or infective agents. Generally speaking, we serve only potable water and not palatable water. Palatable is pleasant tasting water.

**25. What is hardness in water and what chemicals cause it?**

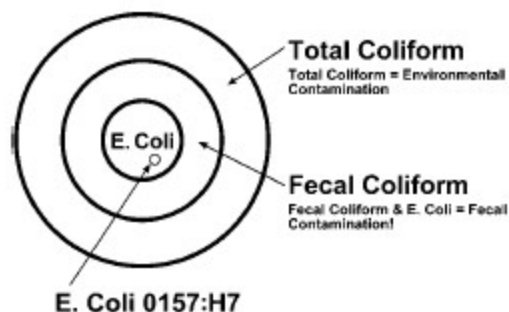
**Hardness:** Water that contains high amounts of dissolved minerals, specifically calcium and magnesium. **Ion Exchange:** A method of water softening where hardness causing ions are exchanged with sodium ions; also effective in removing many inorganic contaminants such as nitrates, copper, and lead; and treating aesthetic water problems.

**26. What is Escherichia Coliform and what does it indicate in relation to drinking water?**

**E. coli** is a sub-group of the fecal coliform group. Most *E. coli* bacteria are harmless and are found in great quantities in the intestines of people and warm-blooded animals. Some strains, however, can cause illness. The presence of *E. coli* in a drinking water sample almost always indicates recent fecal contamination meaning there is a greater risk that pathogens are present.

## TOTAL COLIFORM, FECAL COLIFORM AND E. COLI

---



Total coliform, fecal coliform, and *E. coli* are all indicators of drinking water quality. The total coliform group is a large collection of different kinds of bacteria. Fecal coliforms are types of total coliform that mostly exist in feces. *E. coli* is a sub-group of fecal coliform. When a water sample is sent to a lab, it is tested for total coliform. If total coliform is present, the sample will also be tested for either fecal coliform or *E. coli*, depending on the lab testing method.

### **27. What problems are associated with Hydrogen Sulfide in the water?**

Hydrogen sulfide is a gas which, when dissolved in water, gives it a “rotten egg” odor. Chlorination will remove this gas from the water but the effectiveness of the chlorine for disinfection is lessened.

**28. When Hydrogen sulfide reacts with chlorine, it produces Sulfuric acid and elemental Sulfur:** It is therefore recommended that aeration be applied prior to the addition of chlorine for the most effective disinfection.

### **29. Why is it important to know what the turbidity of the water is when using chlorine?**

To be careful not to overdose with chlorine or properly dose with chlorine.

### **30. What is the log removal for Cryptosporidium?**

The LT1ESWTR extends further this necessary protection from Cryptosporidium to communities of fewer than 10,000 persons. Today's rule for the first time establishes Cryptosporidium control requirements for systems serving less than 10,000 persons by requiring a minimum 2-log removal for Cryptosporidium. The rule also strengthens filter performance requirements to ensure 2-log Cryptosporidium removal, establishes individual filter monitoring to minimize poor performance in individual units, includes Cryptosporidium in the definition of GWUDI, and explicitly considers unfiltered system watershed control provisions. The rule also reflects a commitment to the importance of maintaining existing levels of microbial protection in public water systems as plants take steps to comply with newly applicable DBP standards.

### **31. What is the log removal?**

This log-reduction terminology was developed by engineers as a way to express levels of decreased biological contamination in water by factors of 10 that could be easily converted to percent reduction. The most commonly used logarithmic base is 10 because it is compatible with our base-10 decimal system.

The log of 10 in the base 10 logarithmic system is 1 and the log of 100 is 2, with the log of 1000 being 3, etc. A 1-log reduction is nine out of 10 and would be equivalent to a 90 percent reduction. A 2-log reduction would be 99 out of 100 or 99 percent reduction and a 3-log reduction would be 999 out of 1000 or 99.9 percent reduction. A 99.99 percent reduction would be called a 4-log reduction.

### **32. What are the turbidity requirements for Direct and Conventional filtration plants?**

For conventional and direct filtration systems (including those systems utilizing in-line filtration), the turbidity level of representative samples of a system's filtered water (measured every four hours) must be less than or equal to *0.3 NTU* in at least 95 percent of the measurements taken each month. The turbidity level of representative samples of a system's filtered water must not exceed *1 NTU* at any time.

Conventional filtration is defined as a series of processes including coagulation, flocculation, sedimentation, and filtration resulting in substantial particulate removal. Direct filtration is defined as a series of processes including coagulation and filtration but excluding sedimentation resulting in substantial particle removal.

### **33. What are chloramines, how are they formed, and do they have any beneficial use?**

**Chloramines:** Ammonia and Chlorine are combined.  $\text{Cl}_2\text{NH}_3$  Yes, limited use and this chemical will create less THMS than chlorine alone. Chloramine is a disinfectant used to treat drinking water. It is formed by mixing chlorine with ammonia. Although it is a weaker disinfectant than chlorine, it is more stable and extends disinfectant benefits throughout a water utility's distribution system (a system of pipes water is delivered to homes through).

Some water systems use chloramine as a secondary disinfectant to maintain a disinfectant residual throughout the distribution system so that drinking water remains safe as it travels from the treatment facility to the customer.

Chloramine has been used by water systems for almost 90 years, and its use is closely regulated. Since chloramine is not as reactive as chlorine, it forms fewer disinfection byproducts.

Some disinfection byproducts, such as the trihalomethanes (THMs) and haloacetic acids (HAAs), may have adverse health effects and are closely regulated. Because a chloramine residual is more stable and longer lasting than free chlorine, it provides better protection against bacterial regrowth in systems with large storage tanks and dead-end water mains.

Chloramine, like chlorine, is effective in controlling biofilm, which is a coating in the pipe caused by bacteria. Controlling biofilm also tends to reduce coliform bacteria concentrations and biofilm-induced corrosion of pipes.



## Summary

### **Factors in Chlorine Disinfection: Concentration and Contact Time**

In an attempt to establish more structured operating criteria for water treatment disinfection, the CXT concept came into use in 1980. Based on the work of several researchers, CXT values [ final free chlorine concentration (mg/L) multiplied by minimum contact time (minutes)], offer water operators guidance in computing an effective combination of chlorine concentration and chlorine contact time required to achieve disinfection of water at a given temperature.

The CXT formula demonstrates that if an operator chooses to decrease the chlorine concentration, the required contact time must be lengthened. Similarly, as higher strength chlorine solutions are used, contact times may be reduced (Connell, 1996).

Detection and investigation of waterborne disease outbreaks is the primary responsibility of local, state and territorial public health departments, with voluntary reporting to the CDC. The CDC and the U.S. Environmental Protection Agency (EPA) collaborate to track waterborne disease outbreaks of both microbial and chemical origins. Data on drinking water and recreational water outbreaks and contamination events have been collected and summarized since 1971.

While useful, statistics derived from surveillance systems do not reflect the true incidence of waterborne disease outbreaks because many people who fall ill from such diseases do not consult medical professionals.

For those who do seek medical attention, attending physicians and laboratory and hospital personnel are required to report diagnosed cases of waterborne illness to state health departments. Further reporting of these illness cases by state health departments to the CDC is voluntary, and statistically more likely to occur for large outbreaks than small ones.

Despite these limitations, surveillance data may be used to evaluate the relative degrees of risk associated with different types of source water and systems, problems in current technologies and operating conditions, and the adequacy of current regulations. (Craun, Nwachuku, Calderon, and Craun, 2002).

### **Understanding Cryptosporidiosis**

Cryptosporidium is an emerging parasitic protozoan pathogen because its transmission has increased dramatically over the past two decades. Evidence suggests it is newly spread in increasingly popular day-care centers and possibly in widely distributed water supplies, public pools and institutions such as hospitals and extended-care facilities for the elderly.

Recognized in humans largely since 1982 and the start of the AIDS epidemic, Cryptosporidium is able to cause potentially life-threatening disease in the growing number of immunocompromised patients.

Cryptosporidium was the cause of the largest reported drinking water outbreak in U.S. history, affecting over 400,000 people in Milwaukee in April 1993. More than 100 deaths are attributed to this outbreak. Cryptosporidium remains a major threat to the U.S. water supply (Ibid.).

The EPA is developing new drinking water regulations to reduce Cryptosporidium and other resistant parasitic pathogens. Key provisions of the Long Term 2 Enhanced Surface Water Treatment Rule include source water monitoring for Cryptosporidium; inactivation by all unfiltered systems; and additional treatment for filtered systems based on source water

Cryptosporidium concentrations. EPA will provide a range of treatment options to achieve the inactivation requirements. Systems with high concentrations of Cryptosporidium in their source water may adopt alternative disinfection methods (e.g., ozone, UV, or chlorine dioxide).

However, most water systems are expected to meet EPA requirements while continuing to use chlorination. Regardless of the primary disinfection method used, water systems must continue to maintain residual levels of chlorine-based disinfectants in their distribution systems.

### **Understanding Giardia lamblia**

Giardia lamblia, discovered approximately 20 years ago, is another emerging waterborne pathogen. This parasitic microorganism can be transmitted to humans through drinking water that might otherwise be considered pristine. In the past, remote water sources that were not affected by human activity were thought to be pure, warranting minimal treatment. However, it is known now that all warm-blooded animals may carry Giardia and that beaver are prime vectors for its transmission to water supplies.

There is a distinct pattern to the emergence of new pathogens. First, there is a general recognition of the effects of the pathogen in highly susceptible populations such as children, cancer patients and the immunocompromised.

Next, practitioners begin to recognize the disease and its causative agent in their own patients, with varied accuracy. At this point, some may doubt the proposed agent is the causative agent, or insist that the disease is restricted to certain types of patients.

Finally, a single or series of large outbreaks result in improved attention to preventive efforts. From the 1960's to the 1980's this sequence of events culminated in the recognition of Giardia lamblia as a cause of gastroenteritis (Lindquist, 1999).

## Waterborne Pathogens Post Quiz

### True or False

1. Total coliforms are a group of closely related viruses that are (with few exceptions) not harmful to humans. They are an indicator of other pathogens that can be present in water.
2. Fecal coliform bacteria are present in warm-blooded animals and they are shed from the body in the feces. Because these organisms are shed from the body in large numbers and are relatively easy to detect in the laboratory, they have been accepted as a guideline of water or food contamination.
3. All bacteriological samples are analyzed for the coliform group; however, a positive reaction to these coliform analyses may be from sources other than fecal. In order to differentiate between these sources, all samples that are total coliform positive must be analyzed again to determine if fecal coliform or *E. coli* are present.
4. To comply with the monthly MCL for total coliforms (TC), PWSs must not find coliforms in more than fifty percent of the samples they take each month to meet EPA's standards. If more than twenty percent of the samples contain coliforms, PWS operators must report this violation to the state and the public.
5. If a sample tests positive for TC, the system must collect a set of repeat samples located within 10 or fewer sampling sites adjacent to the location of the routine positive sample within 48 hours.
6. When a routine or repeat sample tests positive for total coliforms, it must also be analyzed for fecal coliforms or *E. coli*, which are types of coliform bacteria that are directly associated with feces.
7. A positive result for fecal coliforms or *E. coli* can signify an acute MCL violation, which necessitates rapid state and public notification because it represents a direct health risk.
8. At times, an acute violation due to the presence of fecal coliform or *E. coli* may result in a "boil water" notice. The system must also take at least 5 routine samples the next month of operation if any sample tests positive for total coliforms.

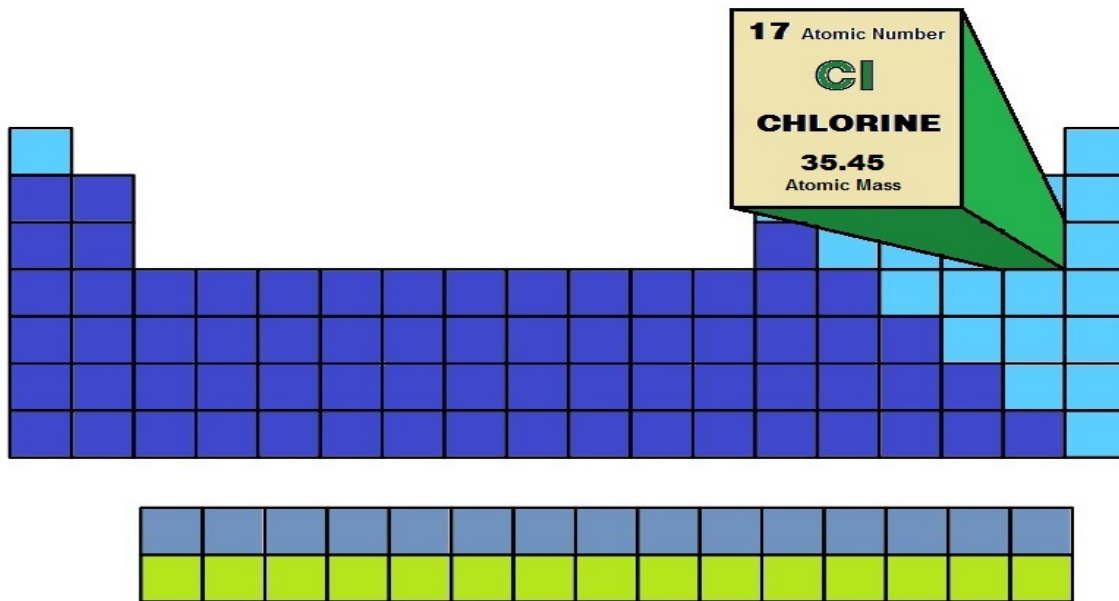
9. A coliform sample site plan is a list of sites by street address, lot number, or other permanent description, that identifies all the approved locations where your routine (monthly) coliform samples may be collected. The list of sites must be plotted on a map of your service area.

10. Small water systems shall divide their distribution system into specific sample areas.

## Chapter 3 - Water Chemistry

**Section Focus:** You will learn the basics of water chemistry with an emphasis on chemical compounds and Chlorine. At the end of this section, you will be able to describe basic water chemistry, halogens and pH. There is a post quiz at the end of this section to review your comprehension and a final examination in the Assignment for your contact hours.

**Scope/Background:** All treatment operator at some time will either take lab samples or run lab analysis. All operators should know the principles of pH, basic chemistry principles and understand simple treatment chemical compounds.



**CHLORINE ON THE PERIODIC TABLE**

### Halogens

Before we get started, let's review the halogens. The halogens are a chemical series. They are the elements in Group 17 (old-style: VII or VIIA) of the periodic table: fluorine (F), chlorine (Cl), bromine (Br), iodine (I), astatine (At) and the as yet undiscovered ununseptium (Uus). The periodic table is the single most unifying concept in chemistry. It is a structured listing of all known elements, or substances, that consist of one type of atom. Elements cannot be reduced to simpler substances.

The term "*halogen*" means "*salt-former*" and compounds containing halogens are called "salts". The word halogen was coined to mean elements which produce salt in union with a metal. It comes from 18th c. scientific French nomenclature based on erring adaptations of Greek roots.

Halogens are highly reactive, and as such can be harmful or lethal to biological organisms in sufficient quantities.

Chlorine and iodine are both used as disinfectants for such things as drinking water, swimming pools, fresh wounds, dishes, and surfaces. They kill bacteria and other potentially harmful microorganisms, a process known as sterilization. Their reactive properties are also put to use in bleaching. Chlorine is the active ingredient of most fabric bleaches and is used in the production of most paper products.

### **Halides**

These elements are diatomic molecules in their natural form. They require one more electron to fill their outer electron shells, and so have a tendency to form a singly-charged negative ion. This negative ion is referred to as a halide ion; salts containing these ions are known as halides.

Halide ions combined with single hydrogen atoms form the hydrohalic acids (i.e., HF, HCl, HBr, HI), a series of particularly strong acids. (HAt, or "hydrastatic acid", should also qualify, but it is not typically included in discussions of hydrohalic acid due to astatine's extreme instability toward alpha decay.) They react with each other to form interhalogen compounds.

Diatomic interhalogen compounds (BrF, ICl, ClF, etc.) bear strong superficial resemblance to the pure halogens. Many synthetic organic compounds such as plastic polymers, and a few natural ones, contain halogen atoms; these are known as halogenated compounds or organic halides.

### **Chlorine**

Chlorine is by far the most abundant of the halogens, and the only one needed in relatively large amounts (as chloride ions) by humans. For example, chloride ions play a key role in brain function by mediating the action of the inhibitory transmitter GABA and are also used by the body to produce stomach acid. Iodine is needed in trace amounts for the production of thyroid hormones such as thyroxine.

On the other hand, neither fluorine nor bromine are believed to be really essential for humans, although small amounts of fluoride can make tooth enamel resistant to decay.

# Halogens

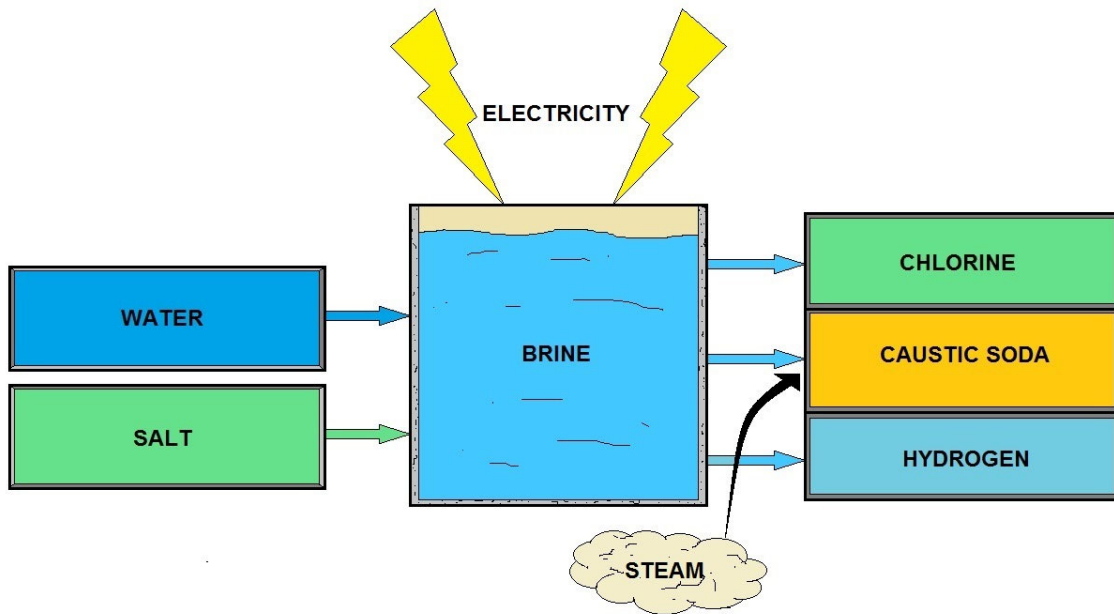
All halogens have 7 electrons in their outer shells, giving them an oxidation number of -1. The halogens exist, at room temperature, in all three states of matter:

- **Solid**- Iodine, Astatine
- **Liquid**- Bromine
- **Gas**- Fluorine, Chlorine

The Halogens are:

Halogen	Atomic Mass	Melting Point k	Boiling Point k	Electronegativity
Fluorine	19	53.53	85.03	3.98
Chlorine	35.5	171.6	239.11	3.16
Bromine	80	265.8	332.0	2.96
Iodine	127	396.85	457.4	2.66
Astatine	210	575	610	2.2
Ununseptium	291*	*	*	*

- Ununseptium has not yet been discovered; values are either unknown if no value appears, or are estimates based on other similar chemicals.



**BASIC CONCEPT OF HOW CHLORINE AND CAUSTIC SODA ARE PRODUCED**

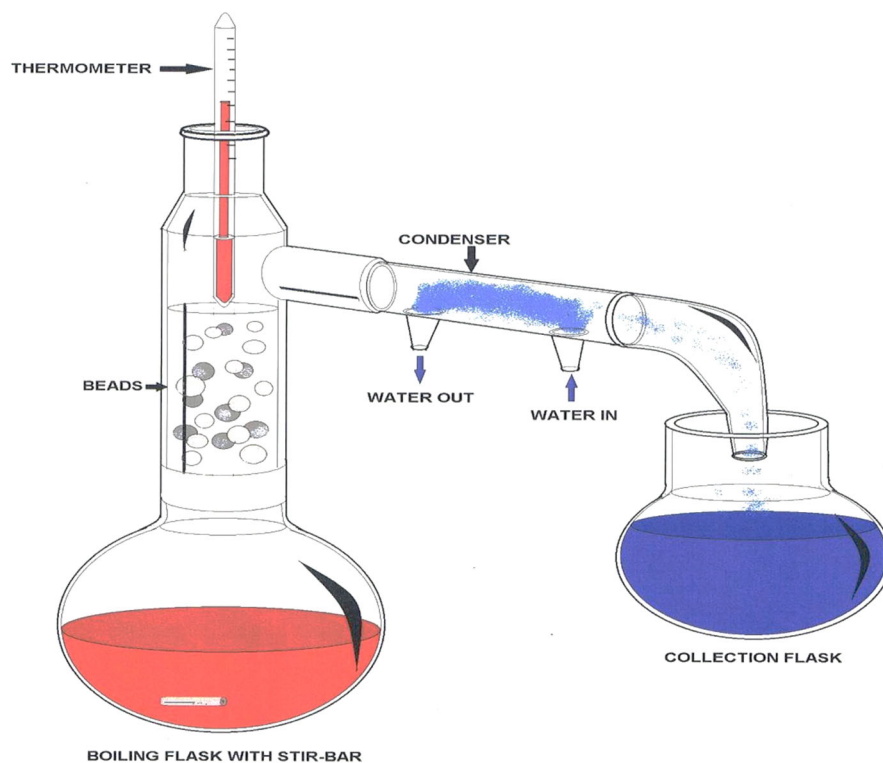




***Before we go deeper into Chlorine, we will first examine...***

## **Principles of Modern Chemistry**

The current model of atomic structure is the quantum mechanical model. Traditional chemistry starts with the study of elementary particles, atoms, molecules, substances, metals, crystals and other aggregates of matter. This matter can be studied in solid, liquid, or gas states, in isolation or in combination. The interactions, reactions and transformations that are studied in chemistry are usually the result of interactions between atoms, leading to rearrangements of the chemical bonds which hold atoms together. Such behaviors are studied in a chemistry laboratory.



The chemistry laboratory stereotypically uses various forms of laboratory glassware. However, glassware is not central to chemistry and a great deal of experimental (as well as applied/industrial) chemistry is done without it.

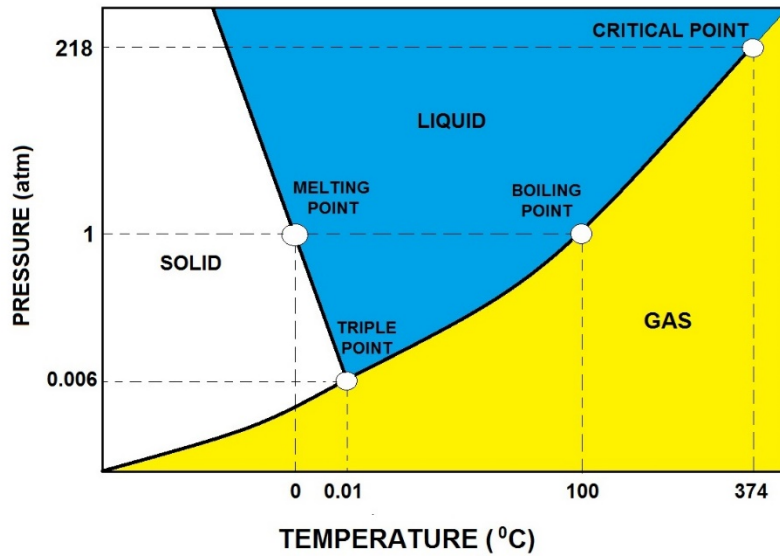
A chemical reaction is a transformation of some substances into one or more different substances. The basis of such a chemical transformation is the rearrangement of electrons in the chemical bonds between atoms. It can be symbolically depicted through a chemical equation, which usually involves atoms as subjects.

The number of atoms on the left and the right in the equation for a chemical transformation is equal. (When the number of atoms on either side is unequal, the transformation is referred to as a nuclear reaction or radioactive decay.) The type of chemical reactions a substance may undergo and the energy changes that may accompany it are constrained by certain basic rules, known as chemical laws.

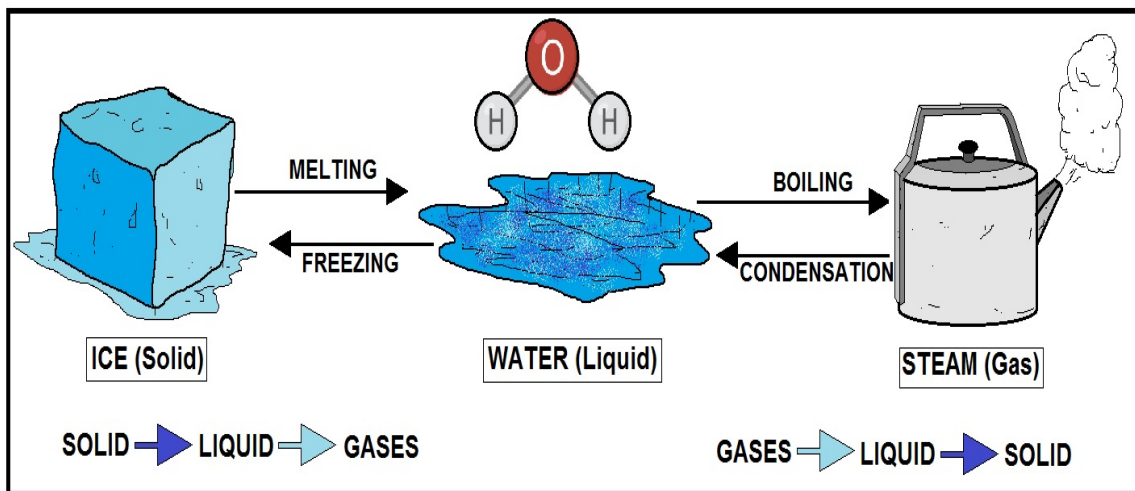
Energy and entropy considerations are invariably important in almost all chemical studies. Chemical substances are classified in terms of their structure, phase, as well as their chemical compositions. They can be analyzed using the tools of chemical analysis, e.g. spectroscopy and chromatography. Scientists engaged in chemical research are known as chemists. Most chemists specialize in one or more sub-disciplines.

### Matter

In chemistry, matter is defined as anything that has rest mass and volume (it takes up space) and is made up of particles. The particles that make up matter have rest mass as well - not all particles have rest mass, such as the photon. Matter can be a pure chemical substance or a mixture of substances.



### WATER PHASE DIAGRAM



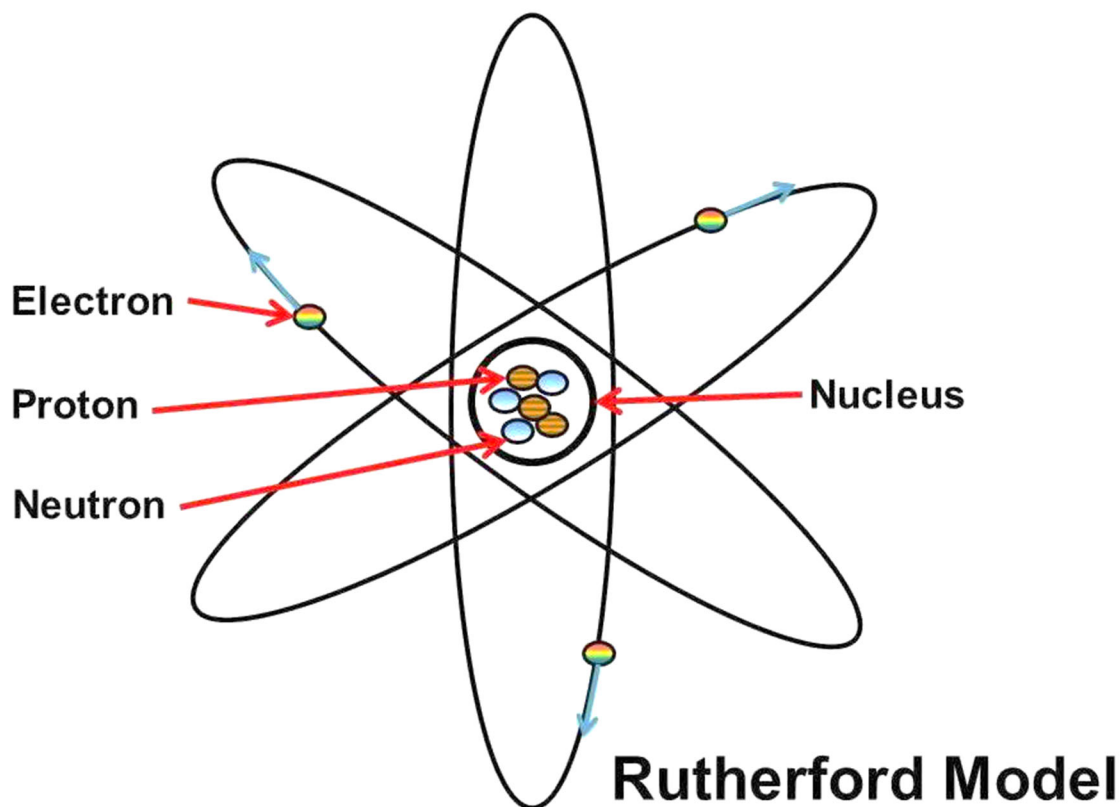
### PHYSICAL CHARACTERISTICS OF WATER



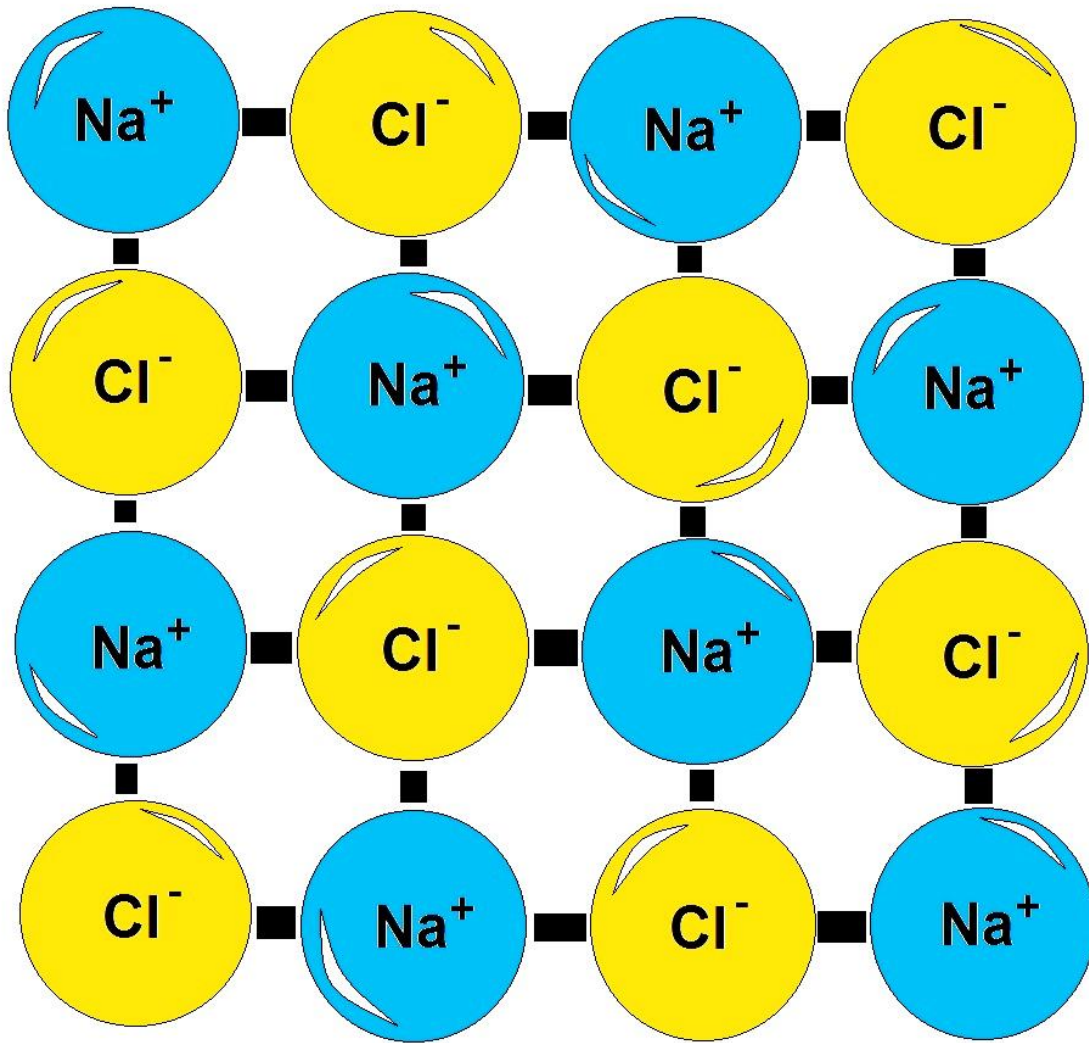
## Basic Chemical Structure

At the turn of the twentieth century the theoretical underpinnings of chemistry were finally understood due to a series of remarkable discoveries that succeeded in probing and discovering the very nature of the internal structure of atoms.

In 1897, J. J. Thomson of Cambridge University discovered the electron and soon after the French scientist Becquerel as well as the couple Pierre and Marie Curie investigated the phenomenon of radioactivity. In a series of pioneering scattering experiments Ernest Rutherford at the University of Manchester discovered the internal structure of the atom and the existence of the proton, classified and explained the different types of radioactivity and successfully transmuted the first element by bombarding nitrogen with alpha particles.

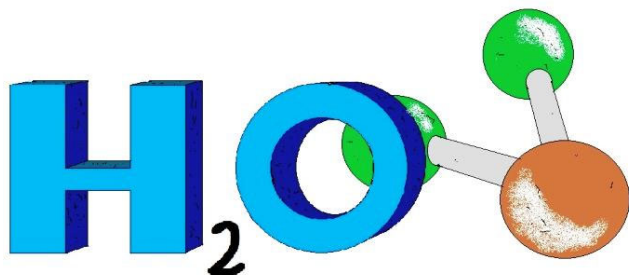


His work on atomic structure was improved on by his students, the Danish physicist Niels Bohr and Henry Moseley. The electronic theory of chemical bonds and molecular orbitals was developed by the American scientists Linus Pauling and Gilbert N. Lewis.



**TABLE SALT CRYSTAL LATTICE DIAGRAM**

## What is a Compound?



Water ( $H_2O$ ), an example of a chemical compound

A *compound* is a pure chemical substance composed of more than one element. The properties of a compound bear little similarity to those of its elements. The standard nomenclature of compounds is set by the International Union of Pure and Applied Chemistry (IUPAC). Organic compounds are named according to the organic nomenclature system. Inorganic compounds are named according to the inorganic nomenclature system.

In addition, the Chemical Abstracts Service has devised a method to index chemical substances. In this scheme each chemical substance is identifiable by a number known as its CAS registry number.

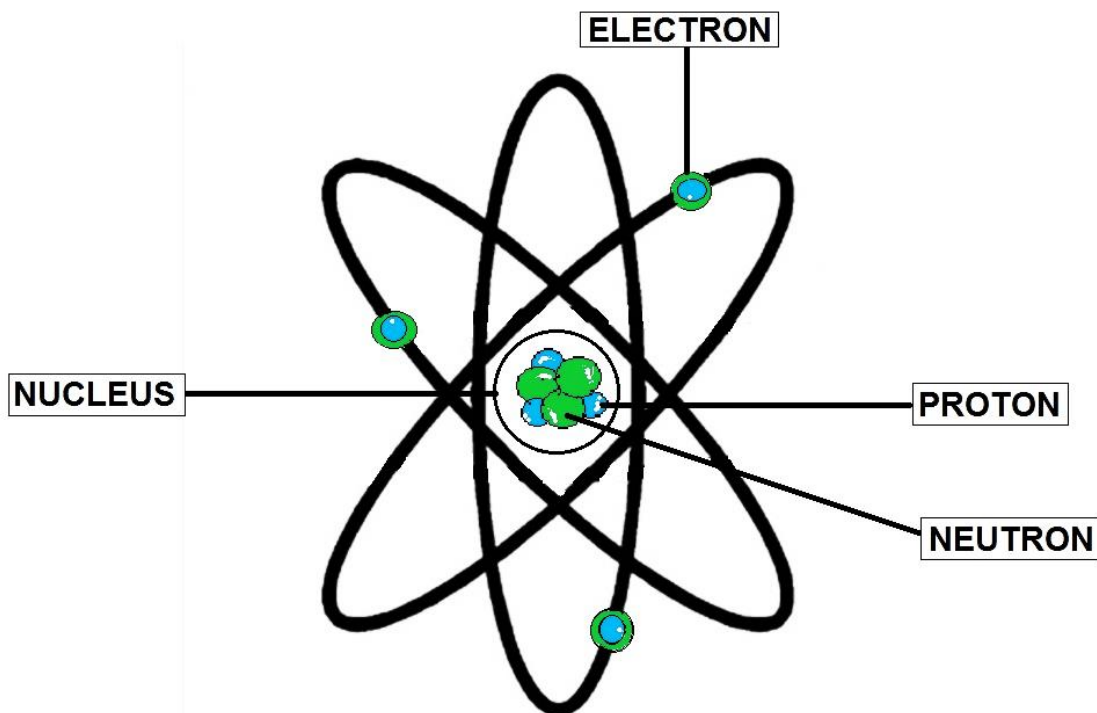
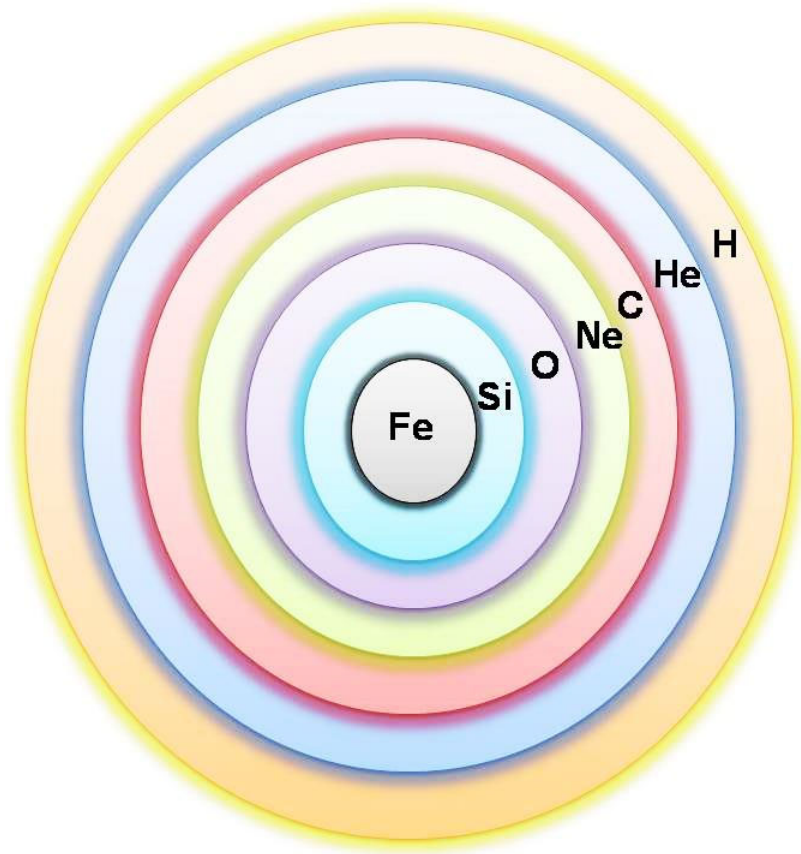


DIAGRAM OF AN ATOM



**Fe: Iron**

**Si: Silicon**

**O: Oxygen**

**Ne: Neon**

**C: Carbon**

**He: Helium**

**H: Hydrogen**

**STAR ELEMENTS**

## More on Chemical Compounds

A pure chemical compound is a chemical substance that is composed of a particular set of molecules or ions. Two or more elements combined into one substance through a chemical reaction form a chemical compound. All compounds are substances, but not all substances are compounds.

A chemical compound can be either atoms bonded together in molecules or crystals in which atoms, molecules or ions form a crystalline lattice. Compounds based primarily on carbon and hydrogen atoms are called organic compounds, and all others are called inorganic compounds. Compounds containing bonds between carbon and a metal are called organometallic compounds.



**OXYGEN –O<sub>2</sub> MOLECULE**

Compounds in which components share electrons are known as covalent compounds. Compounds consisting of oppositely charged ions are known as ionic compounds, or salts.

In organic chemistry, there can be more than one chemical compound with the same composition and molecular weight. Generally, these are called isomers. Isomers usually have substantially different chemical properties, may be isolated and do not spontaneously convert to each other.

A common example is glucose vs. fructose. The former is an aldehyde; the latter is a ketone. Their interconversion requires either enzymatic or acid-base catalysis. However, there are also tautomers, where isomerization occurs spontaneously, such that a pure substance cannot be isolated into its tautomers.

A common example is glucose, which has open-chain and ring forms. One cannot manufacture pure open-chain glucose because glucose spontaneously cyclizes to the hemiacetal form. Materials may also comprise other entities such as polymers. These may be inorganic or organic and sometimes a combination of inorganic and organic.

<b>COMMON CHEMICAL USED IN WATER TREATMENT PROCESS</b>	
<b>CHEMICAL NAME</b>	<b>CHEMICAL USE IN PROCESS</b>
FLUORIDE	Helps Build Strong Teeth
SODIUM HYPOCHLORITE	Used For Disinfection
POLYMERS (Cationic)	Aids In The Process Of Drying And Consolidating Sludge
BLEACH	Used For Odor Control And Disinfection
FERRIC CHLORIDE	Used To Help Remove Impurities In Water
SODIUM PERMANGANATE	Used For The Control Of Biological Growth
CAUSTIC SODA	Used For The Control Of pH (Raises pH)
HYDROCHLORIC ACID	Used For The Control Of pH (Lowers pH)
ALUMINUM SULFATE	Used To Help Clarify Drinking Water
CHLORINE	Used For Disinfection (Primary Disinfection Chemical)



### COMMON CHEMICALS USED IN WATER TREATMENT PROCESS



## Substances versus Mixtures

All matter consists of various elements and chemical compounds, but these are often intimately mixed together. Mixtures contain more than one chemical substance, and they do not have a fixed composition. In principle, they can be separated into the component substances by purely mechanical processes. Butter, soil and wood are common examples of mixtures.

Grey iron metal and yellow sulfur are both chemical elements, and they can be mixed together in any ratio to form a yellow-grey mixture. No chemical process occurs, and the material can be identified as a mixture by the fact that the sulfur and the iron can be separated by a mechanical process, such as using a magnet to attract the iron away from the sulfur.

In contrast, if iron and sulfur are heated together in a certain ratio (1 atom of iron for each atom of sulfur, or by weight, 56 grams (1 mol) of iron to 32 grams (1 mol) of sulfur), a chemical reaction takes place and a new substance is formed, the compound iron(II) sulfide, with chemical formula FeS.

The resulting compound has all the properties of a chemical substance and is not a mixture. Iron(II) sulfide has its own distinct properties such as melting point and solubility, and the two elements cannot be separated using normal mechanical processes; a magnet will be unable to recover the iron, since there is no metallic iron present in the compound.

### Chemicals Versus Chemical Substances

While the term *chemical substance* is a precise technical term that is synonymous with "chemical" for professional chemists, the meaning of the word *chemical* varies for non-chemists within the English speaking world or those using English.

For industries, government and society in general in some countries, the word *chemical* includes a wider class of substances that contain many mixtures of such chemical substances, often finding application in many vocations. In countries that require a list of ingredients in products, the "chemicals" listed would be equated with "chemical substances".

Within the chemical industry, manufactured "chemicals" are chemical substances, which can be classified by production volume into bulk chemicals, fine chemicals and chemicals found in research only:

- Bulk chemicals are produced in very large quantities, usually with highly optimized continuous processes and to a relatively low price.
- Fine chemicals are produced at a high cost in small quantities for special low-volume applications such as biocides, pharmaceuticals and specialty chemicals for technical applications.
- Research chemicals are produced individually for research, such as when searching for synthetic routes or screening substances for pharmaceutical activity. In effect, their price per gram is very high, although they are not sold.

The cause of the difference in production volume is the complexity of the molecular structure of the chemical.

Bulk chemicals are usually much less complex. While fine chemicals may be more complex, many of them are simple enough to be sold as "building blocks" in the synthesis of more complex molecules targeted for single use, as named above.

The *production* of a chemical includes not only its synthesis but also its purification to eliminate by-products and impurities involved in the synthesis. The last step in production should be the analysis of batch lots of chemicals in order to identify and quantify the percentages of impurities for the buyer of the chemicals.

The required purity and analysis depends on the application, but higher tolerance of impurities is usually expected in the production of bulk chemicals. Thus, the user of the chemical in the US might choose between the bulk or "technical grade" with higher amounts of impurities or a much purer "pharmaceutical grade" (labeled "USP", United States Pharmacopeia).

### **Naming and Indexing**

Every chemical substance has one or more systematic names, usually named according to the IUPAC rules for naming. An alternative system is used by the Chemical Abstracts Service (CAS).

Many compounds are also known by their more common, simpler names, many of which predate the systematic name. For example, the long-known sugar glucose is now systematically named 6-(hydroxymethyl)oxane-2,3,4,5-tetrol.

Natural products and pharmaceuticals are also given simpler names, for example the mild pain-killer Naproxen is the more common name for the chemical compound (S)-6-methoxy- $\alpha$ -methyl-2-naphthaleneacetic acid.

Chemists frequently refer to chemical compounds using chemical formulae or molecular structure of the compound. There has been a phenomenal growth in the number of chemical compounds being synthesized (or isolated), and then reported in the scientific literature by professional chemists around the world.

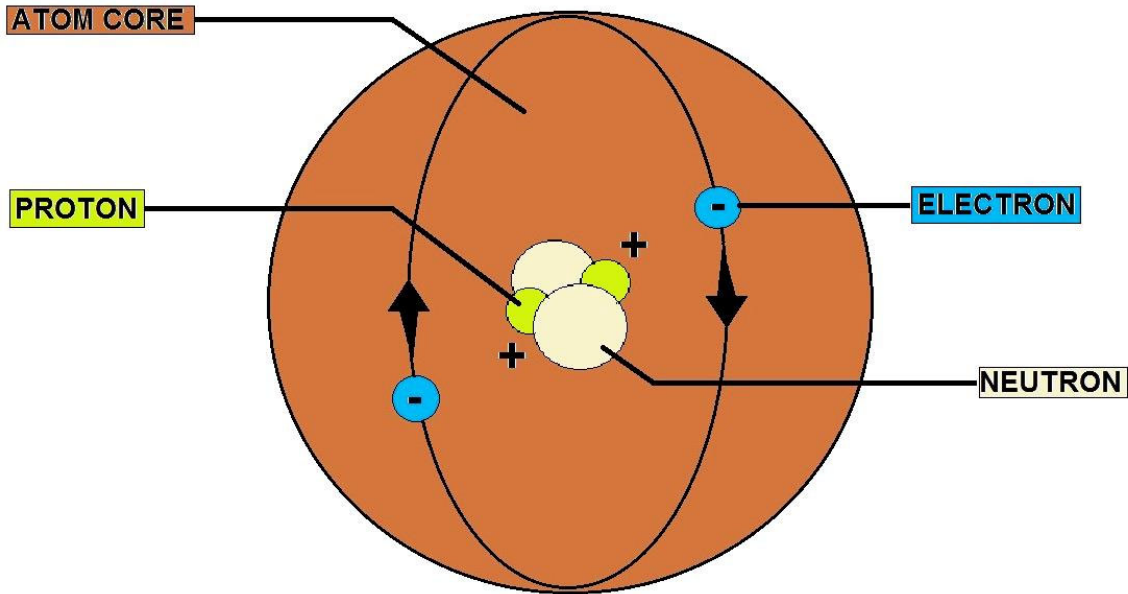
An enormous number of chemical compounds are possible through the chemical combination of the known chemical elements.

CAS provides the abstracting services of the chemical literature, and provides a numerical identifier, known as CAS registry number to each chemical substance that has been reported in the chemical literature (such as chemistry journals and patents).

This information is compiled as a database and is popularly known as the Chemical substances index. Other computer-friendly systems that have been developed for substance information, are: SMILES and the International Chemical Identifier or InChI.

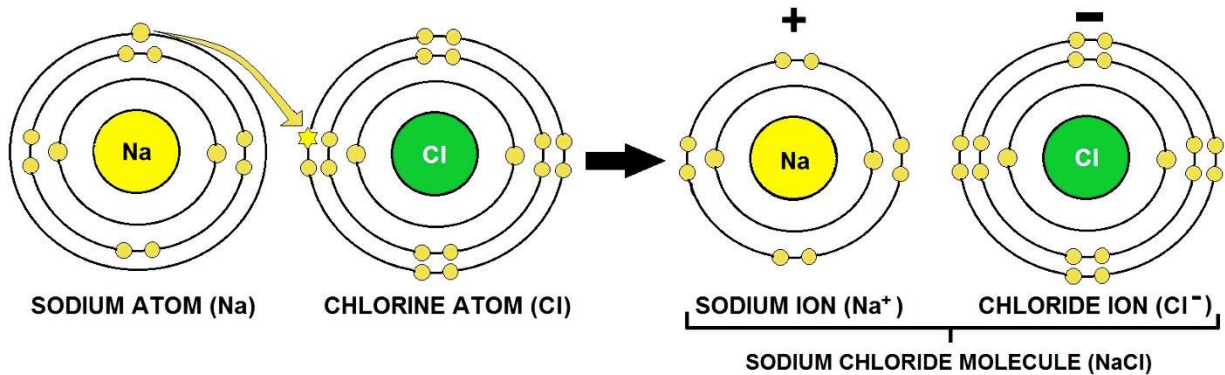
# Understanding the Atom

The atom is the basic unit of chemistry. It consists of a dense core called the atomic nucleus surrounded by a space called the electron cloud.

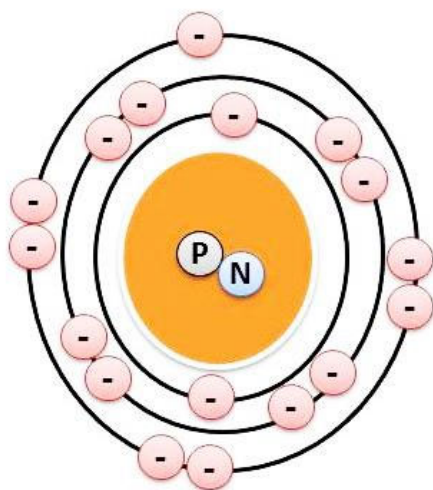






## BASICS OF AN ATOM

The nucleus is made up of positively charged protons and uncharged neutrons (together called nucleons), while the electron cloud consists of negatively-charged electrons which orbit the nucleus. In a neutral atom, the negatively-charged electrons balance out the positive charge of the protons. The nucleus is dense; the mass of a nucleon is 1,836 times that of an electron, yet the radius of an atom is about 10,000 times that of its nucleus.



The atom is also the smallest entity that can be envisaged to retain the chemical properties of the element, such as electronegativity, ionization potential, preferred oxidation state(s), coordination number, and preferred types of bonds to form (e.g., metallic, ionic, covalent).



-  ELECTRONS = 17
-  PROTONS = 17
-  NEUTRONS = 18
-  NUCLEUS

# CHLORINE

## Element

Standard form of the periodic table of chemical elements. The colors represent different categories of elements.

A chemical element is a pure substance which is composed of a single type of atom, characterized by its particular number of protons in the nuclei of its atoms, known as the atomic number and represented by the symbol  $Z$ .

The mass number is the sum of the number of protons and neutrons in a nucleus.

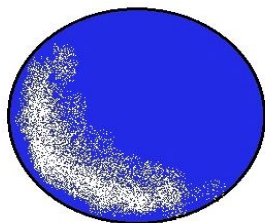
Although all the nuclei of all atoms belonging to one element will have the same atomic number, they may not necessarily have the same mass number; atoms of an element which have different mass numbers are known as isotopes.

For example, all atoms with 6 protons in their nuclei are atoms of the chemical element carbon, but atoms of carbon may have mass numbers of 12 or 13.

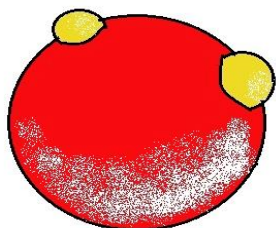
The standard presentation of the chemical elements is in the periodic table, which orders elements by atomic number. The periodic table is arranged in groups, or columns, and periods, or rows. The periodic table is useful in identifying periodic trends.

## Molecule Sub-Section

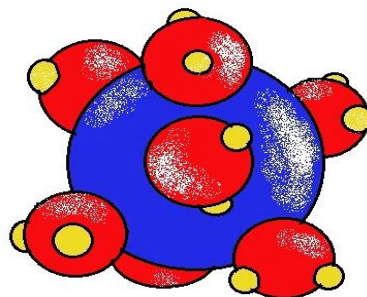
A *molecule* is the smallest indivisible portion of a pure chemical substance that has its unique set of chemical properties, that is, its potential to undergo a certain set of chemical reactions with other substances. However, this definition only works well for substances that are composed of molecules, which is not true of many substances (see below). Molecules are typically a set of atoms bound together by covalent bonds, such that the structure is electrically neutral and all valence electrons are paired with other electrons either in bonds or in lone pairs.



**BARE CALCIUM ION**



**WATER MOLECULE**



**HYDRATED CALCIUM ION**

Thus, molecules exist as electrically neutral units, unlike ions. When this rule is broken, giving the "molecule" a charge, the result is sometimes named a molecular ion or a polyatomic ion. However, the discrete and separate nature of the molecular concept usually requires that molecular ions be present only in well-separated form, such as a directed beam in a vacuum in a mass spectrometer.

Charged polyatomic collections residing in solids (for example, common sulfate or nitrate ions) are generally not considered "molecules" in chemistry.

The "inert" or noble gas elements (helium, neon, argon, krypton, xenon and radon) are composed of lone atoms as their smallest discrete unit, but the other isolated chemical elements consist of either molecules or networks of atoms bonded to each other in some way. Identifiable molecules compose familiar substances such as water, air, and many organic compounds like alcohol, sugar, gasoline, and the various pharmaceuticals.

However, not all substances or chemical compounds consist of discrete molecules, and indeed most of the solid substances that make up the solid crust, mantle, and core of the Earth are chemical compounds without molecules. These other types of substances, such as ionic compounds and network solids, are organized in such a way as to lack the existence of identifiable molecules *per se*. Instead, these substances are discussed in terms of formula units or unit cells as the smallest repeating structure within the substance.

Examples of such substances are mineral salts (such as table salt), solids like carbon and diamond, metals, and familiar silica and silicate minerals such as quartz and granite.

One of the main characteristics of a molecule is its geometry often called its structure. While the structure of diatomic, triatomic or tetra atomic molecules may be trivial, (linear, angular pyramidal etc.) the structure of polyatomic molecules, that are constituted of more than six atoms (of several elements) can be crucial for its chemical nature.

### Substance and Mixture

A chemical substance is a kind of matter with a definite composition and set of properties. A collection of substances is called a mixture. Examples of mixtures are air and alloys.

### Mole and Amount of Substance

The mole is a unit of measurement that denotes an amount of substance (also called chemical amount).

The mole is defined as the number of atoms found in exactly 0.012 kilogram (or 12 grams) of carbon-12, where the carbon-12 atoms are unbound, at rest and in their ground state. The number of entities per mole is known as the Avogadro constant, and is determined empirically to be approximately  $6.022 \times 10^{23} \text{ mol}^{-1}$ .

Molar concentration is the amount of a particular substance per volume of solution, and is commonly reported in  $\text{mol dm}^{-3}$ .

# Periodic Table of the Elements

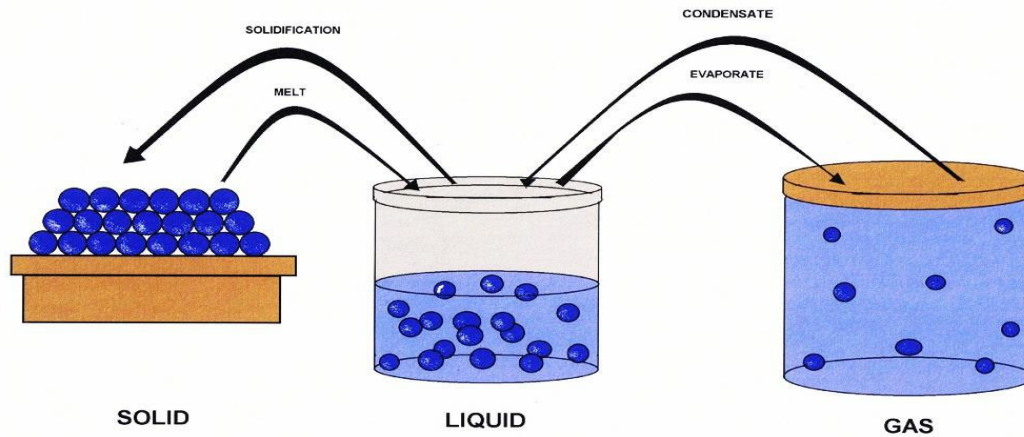
Atomic masses in parentheses are those of the most stable or common isotope.

Copyright © 2017 Michael Eassey - [www.michael-eassey.com](http://www.michael-eassey.com) - All rights reserved.

Note: The subgroup numbers 1-10 were adopted in 1994 by the International Union of Pure and Applied Chemistry. The names of elements 112-118 are the IUPAC equivalents of those numbers.

## Phase

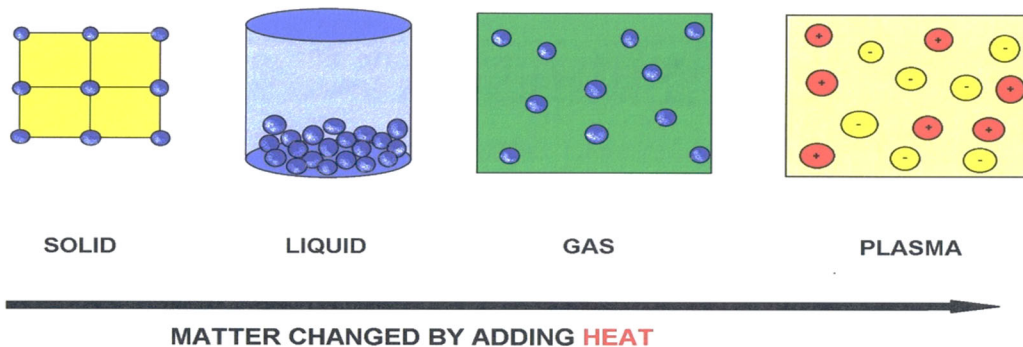
In addition to the specific chemical properties that distinguish different chemical classifications, chemicals can exist in several phases. For the most part, the chemical classifications are independent of these bulk phase classifications; however, some more exotic phases are incompatible with certain chemical properties. A *phase* is a set of states of a chemical system that have similar bulk structural properties, over a range of conditions, such as pressure or temperature.



## STATES OF MATTER

Physical properties, such as density and refractive index tend to fall within values characteristic of the phase. The phase of matter is defined by the *phase transition*, which is when energy put into or taken out of the system goes into rearranging the structure of the system, instead of changing the bulk conditions.

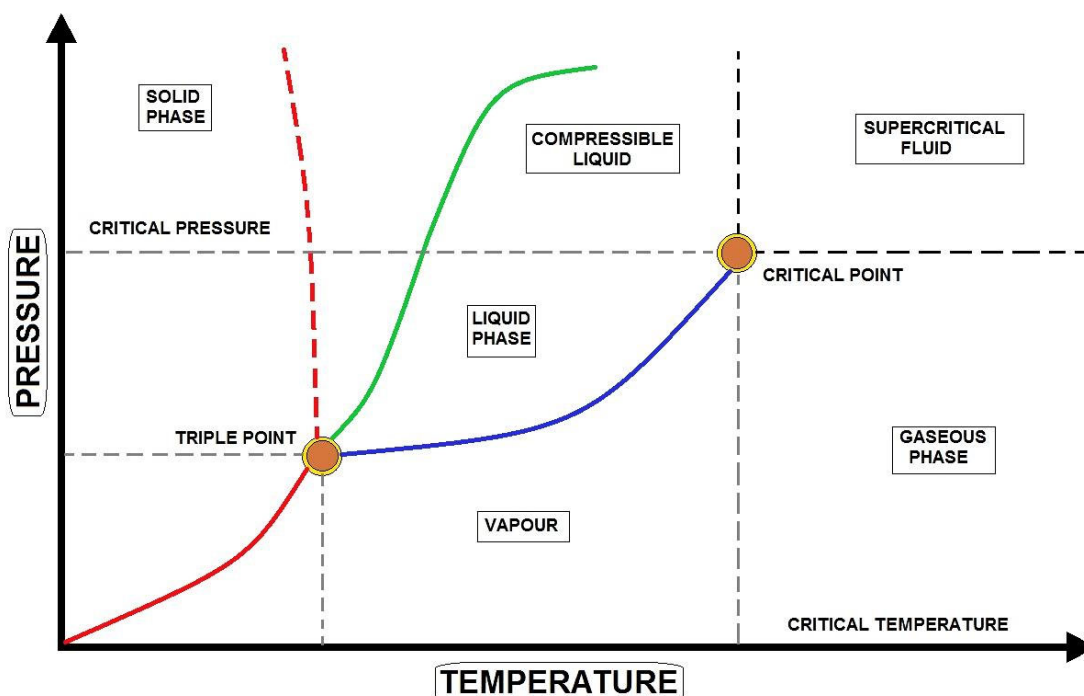
Sometimes the distinction between phases can be continuous instead of having a discrete boundary, in this case the matter is considered to be in a supercritical state. When three states meet based on the conditions, it is known as a triple point and since this is invariant, it is a convenient way to define a set of conditions.



## STATES OF MATTER

The most familiar examples of phases are solids, liquids, and gases. Many substances exhibit multiple solid phases. For example, there are three phases of solid iron (alpha, gamma, and delta) that vary based on temperature and pressure.

A principal difference between solid phases is the crystal structure, or arrangement, of the atoms. Another phase commonly encountered in the study of chemistry is the *aqueous* phase, which is the state of substances dissolved in aqueous solution (that is, in water).

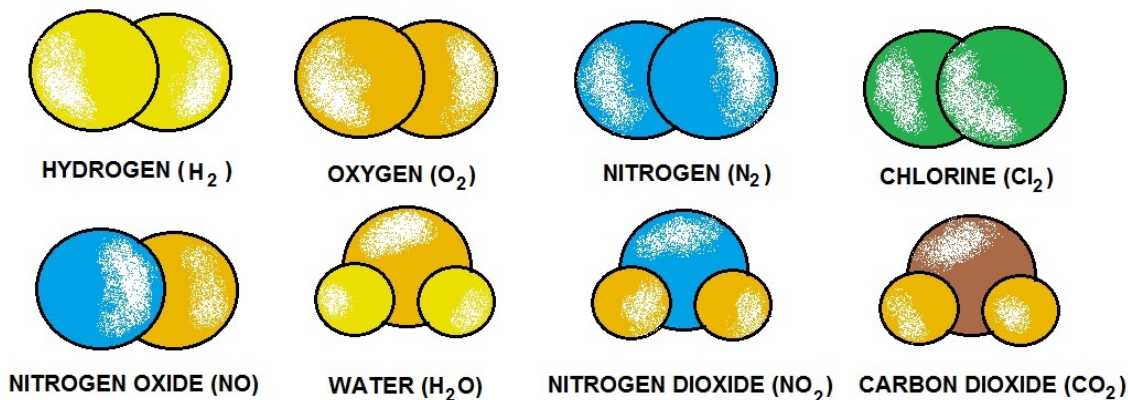


**TRIPLE AND CRITICAL POINTS OF A SUBSTANCE**

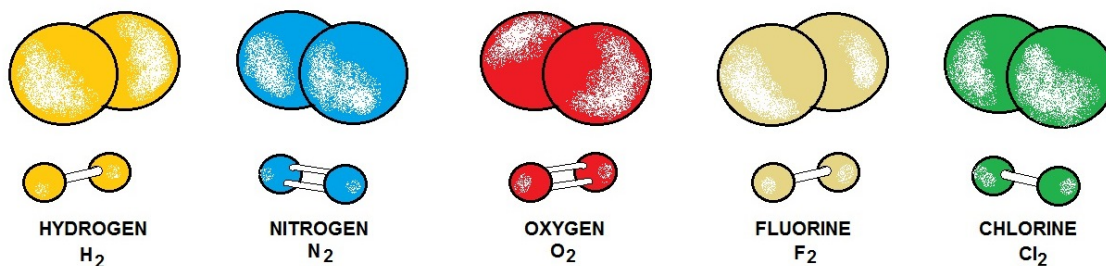
Less familiar phases include plasmas, Bose–Einstein condensates and fermionic condensates and the paramagnetic and ferromagnetic phases of magnetic materials. While most familiar phases deal with three-dimensional systems, it is also possible to define analogs in two-dimensional systems, which has received attention for its relevance to systems in biology.



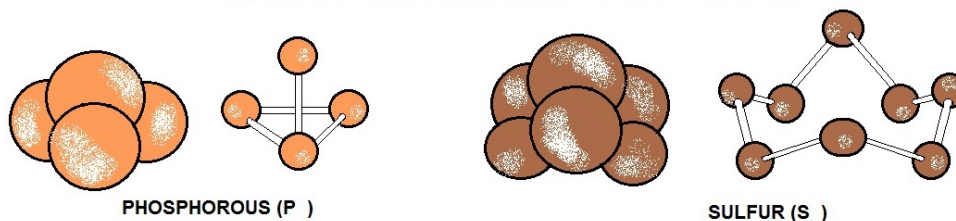
## Bonding



Atoms sticking together in molecules or crystals are said to be bonded with one another. A chemical bond may be visualized as the multipole balance between the positive charges in the nuclei and the negative charges oscillating about them. More than simple attraction and repulsion, the energies and distributions characterize the availability of an electron to bond to another atom.



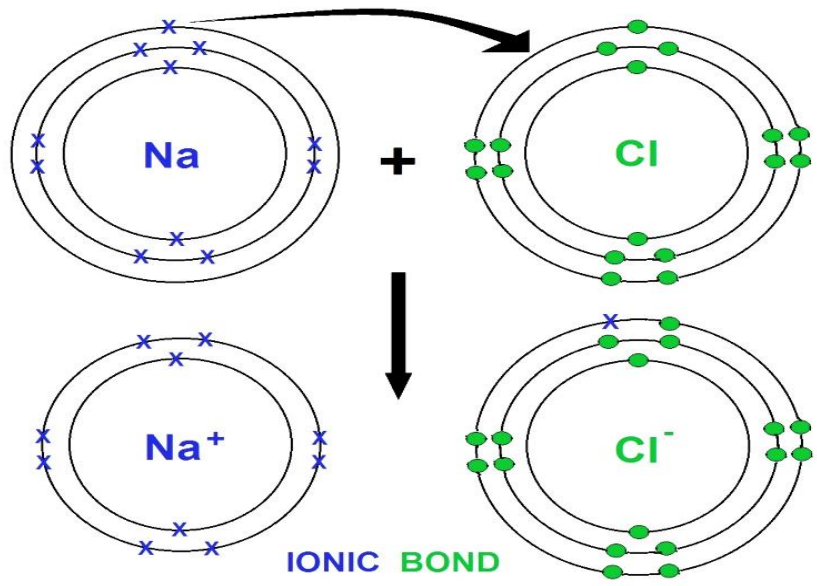
ELEMENTS THAT EXIST AS DIATOMIC MOLECULES



ELEMENTS THAT EXIST AS POLYATOMIC MOLECULES

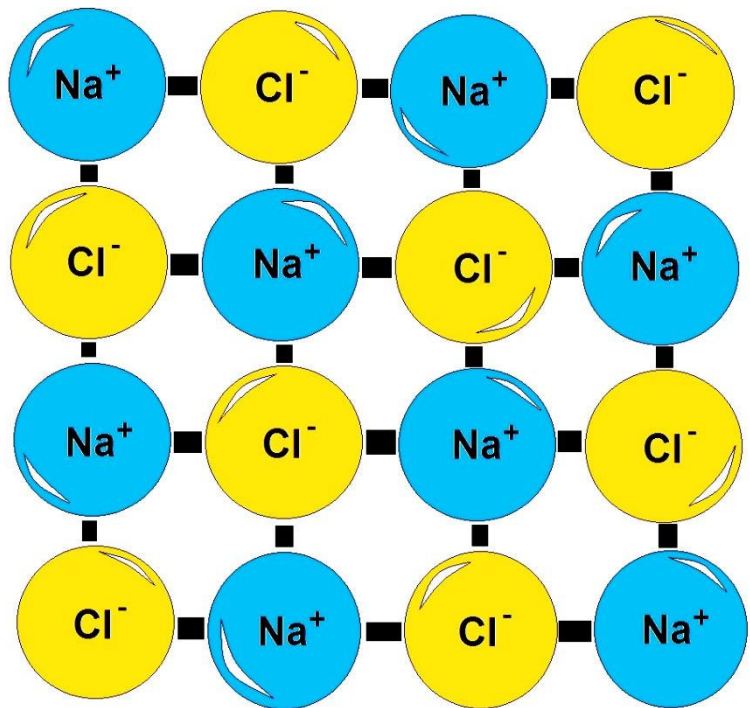
A chemical bond can be a covalent bond, an ionic bond, a hydrogen bond or just because of Van der Waals force. Each of these kinds of bonds is ascribed to some potential. These potentials create the interactions which hold atoms together in molecules or crystals. In many simple compounds, valence bond theory, the Valence Shell Electron Pair Repulsion model (VSEPR), and the concept of oxidation number can be used to explain molecular structure and composition.

An ionic bond is formed when a metal loses one or more of its electrons, becoming a positively charged cation, and the electrons are then gained by the non-metal atom, becoming a negatively charged anion.



## SODIUM CHLORIDE

The two oppositely charged ions attract one another, and the ionic bond is the electrostatic force of attraction between them. For example, sodium (Na), a metal, loses one electron to become an  $\text{Na}^+$  cation while chlorine (Cl), a non-metal, gains this electron to become  $\text{Cl}^-$ . The ions are held together due to electrostatic attraction, and that compound sodium chloride ( $\text{NaCl}$ ), or common table salt, is formed.



**CRYSTAL LATTICE OF NaCl (Table Salt)**

## Energy

In the context of chemistry, energy is an attribute of a substance as a consequence of its atomic, molecular or aggregate structure. Since a chemical transformation is accompanied by a change in one or more of these kinds of structures, it is invariably accompanied by an increase or decrease of energy of the substances involved. Some energy is transferred between the surroundings and the reactants of the reaction in the form of heat or light; thus the products of a reaction may have more or less energy than the reactants.

A reaction is said to be exergonic if the final state is lower on the energy scale than the initial state; in the case of endergonic reactions the situation is the reverse. A reaction is said to be exothermic if the reaction releases heat to the surroundings; in the case of endothermic reactions, the reaction absorbs heat from the surroundings.

Chemical reactions are invariably not possible unless the reactants surmount an energy barrier known as the activation energy. The *speed* of a chemical reaction (at given temperature T) is related to the activation energy E, by the Boltzmann's population factor - that is the probability of a molecule to have energy greater than or equal to E at the given temperature T.

$$e^{-E/kT}$$

This exponential dependence of a reaction rate on temperature is known as the Arrhenius equation. The activation energy necessary for a chemical reaction to occur can be in the form of heat, light, electricity or mechanical force in the form of ultrasound.

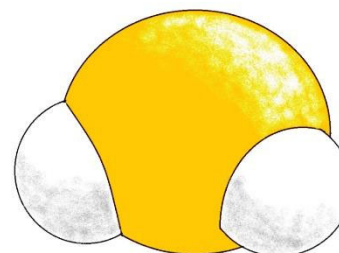
A related concept free energy, which also incorporates entropy considerations, is a very useful means for predicting the feasibility of a reaction and determining the state of equilibrium of a chemical reaction, in chemical thermodynamics. A reaction is feasible only if the total change in the Gibbs free energy is negative, if it is equal to zero the chemical reaction is said to be at equilibrium.

$$\Delta G \leq 0$$

There exist only limited possible states of energy for electrons, atoms and molecules. These are determined by the rules of quantum mechanics, which require quantization of energy of a bound system. The atoms/molecules in a higher energy state are said to be excited. The molecules/atoms of substance in an excited energy state are often much more reactive; that is, more amenable to chemical reactions.

The phase of a substance is invariably determined by its energy and the energy of its surroundings.

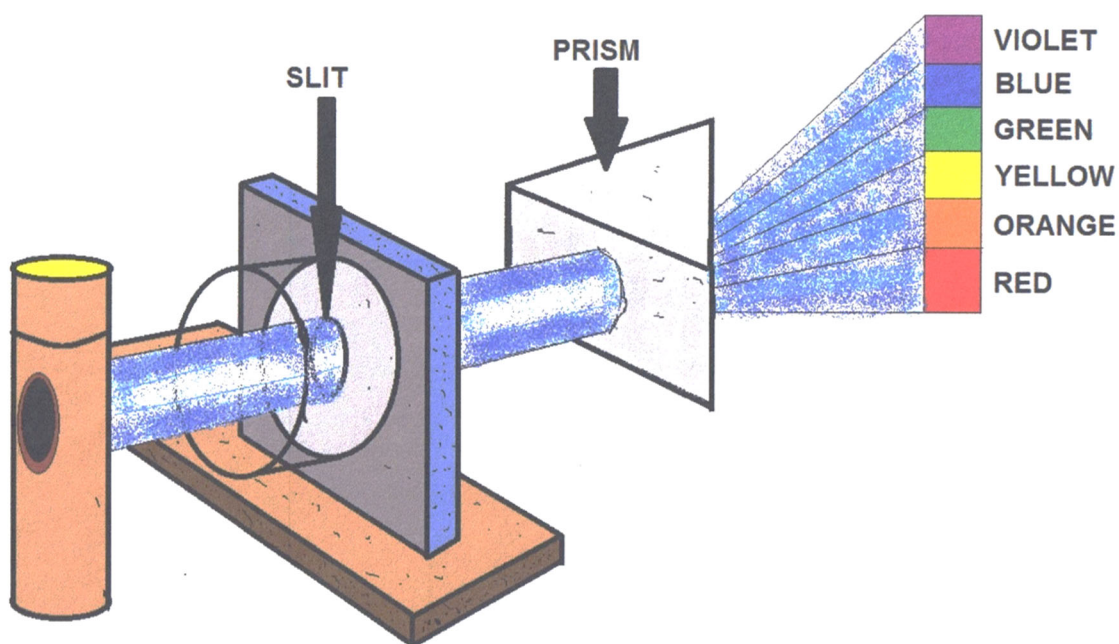
When the intermolecular forces of a substance are such that the energy of the surroundings is not sufficient to overcome them, it occurs in a more ordered phase like liquid or solid as is the case with water (H<sub>2</sub>O); a liquid at room temperature because its molecules are bound by hydrogen bonds.



Whereas hydrogen sulfide ( $\text{H}_2\text{S}$ ) is a gas at room temperature and standard pressure, as its molecules are bound by weaker dipole-dipole interactions.

The transfer of energy from one chemical substance to another depends on the *size* of energy quanta emitted from one substance. However, heat energy is often transferred more easily from almost any substance to another because the phonons responsible for vibrational and rotational energy levels in a substance have much less energy than photons invoked for the electronic energy transfer.

Thus, because vibrational and rotational energy levels are more closely spaced than electronic energy levels, heat is more easily transferred between substances relative to light or other forms of electronic energy. For example, ultraviolet electromagnetic radiation is not transferred with as much efficacy from one substance to another as thermal or electrical energy.

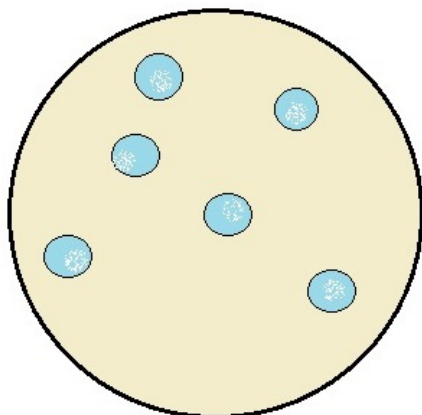


### CONTINUOUS EMISSION SPECTRUM

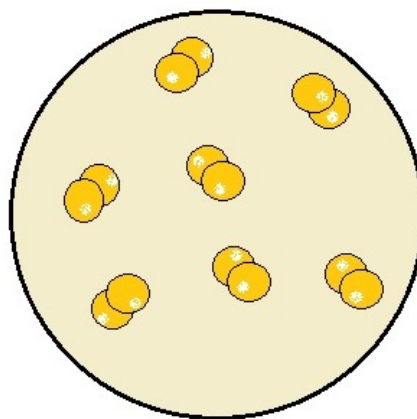
The existence of characteristic energy levels for different chemical substances is useful for their identification by the analysis of spectral lines. Different kinds of spectra are often used in chemical spectroscopy, e.g. IR, microwave, NMR, ESR, etc. Spectroscopy is also used to identify the composition of remote objects - like stars and distant galaxies - by analyzing their radiation spectra.

The term chemical energy is often used to indicate the potential of a chemical substance to undergo a transformation through a chemical reaction or to transform other chemical substances.

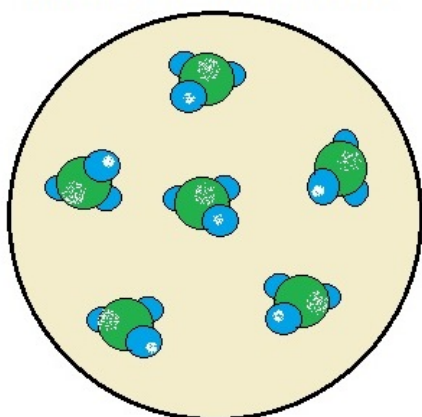
## Reaction



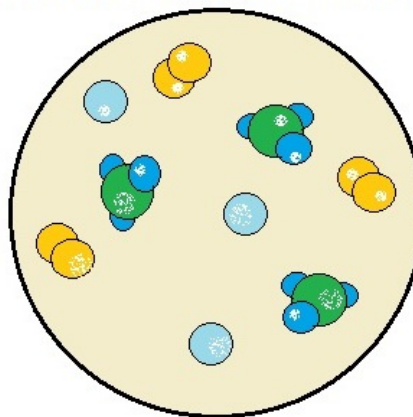
**ATOMS OF AN ELEMENT**



**MOLECULES OF AN ELEMENT**



**MOLECULES OF A COMPOUND**



**MIXTURE OF TWO ELEMENTS  
AND A COMPOUND**

During chemical reactions, bonds between atoms break and form, resulting in different substances with different properties. In a blast furnace, iron oxide, a compound, reacts with carbon monoxide to form iron, one of the chemical elements, and carbon dioxide.

When a chemical substance is transformed as a result of its interaction with another substance or with energy, a chemical reaction is said to have occurred.

A *chemical reaction* is therefore a concept related to the "reaction" of a substance when it comes in close contact with another, whether as a mixture or a solution; exposure to some form of energy, or both. It results in some energy exchange between the constituents of the reaction as well as with the system environment, which may be designed vessels—often laboratory glassware.

Chemical reactions can result in the formation or dissociation of molecules, that is, molecules breaking apart to form two or smaller molecules, or rearrangement of atoms within or across molecules. Chemical reactions usually involve the making or breaking of chemical bonds. Oxidation, reduction, dissociation, acid-base neutralization and molecular re-arrangement are some of the commonly used kinds of chemical reactions.

A chemical reaction can be symbolically depicted through a chemical equation. While in a non-nuclear chemical reaction the number and kind of atoms on both sides of the equation are equal, for a nuclear reaction this holds true only for the nuclear particles viz. protons and neutrons.

The sequence of steps in which the reorganization of chemical bonds may be taking place in the course of a chemical reaction is called its mechanism. A chemical reaction can be envisioned to take place in a number of steps, each of which may have a different speed.

Many reaction intermediates with variable stability can thus be envisaged during the course of a reaction.

Reaction mechanisms are proposed to explain the kinetics and the relative product mix of a reaction. Many physical chemists specialize in exploring and proposing the mechanisms of various chemical reactions. Several empirical rules, like the Woodward–Hoffmann rules often come in handy while proposing a mechanism for a chemical reaction.

According to the IUPAC gold book, a chemical reaction is "a process that results in the interconversion of chemical species." Accordingly, a chemical reaction may be an elementary reaction or a stepwise reaction.

An additional caveat is made, in that this definition includes cases where the interconversion of conformers is experimentally observable.

Such detectable chemical reactions normally involve sets of molecular entities as indicated by this definition, but it is often conceptually convenient to use the term also for changes involving single molecular entities (i.e. 'microscopic chemical events').

### **Ions and Salts**

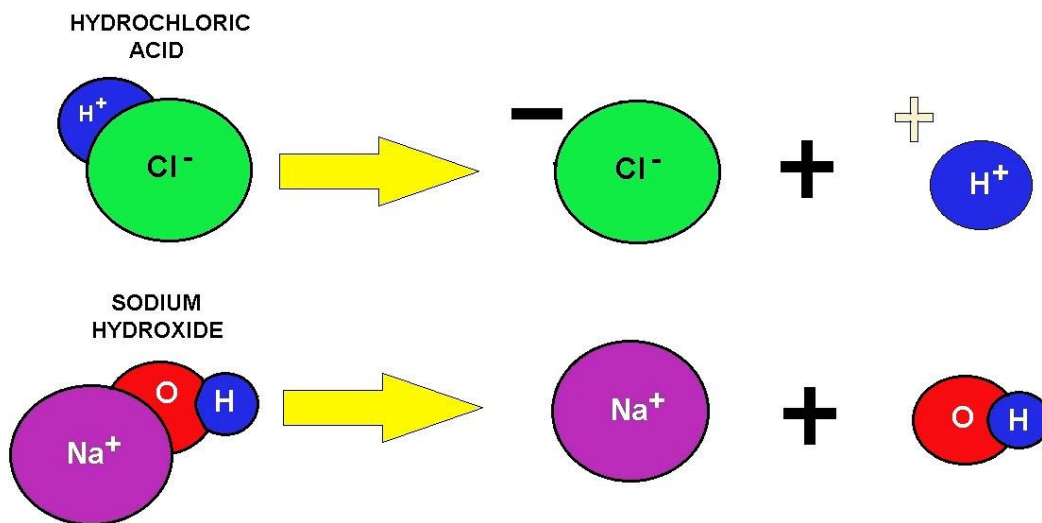
An *ion* is a charged species, an atom or a molecule, that has lost or gained one or more electrons. When an atom loses an electron and thus has more protons than electrons, the atom is a positively-charged ion or cation.

When an atom gains an electron and thus has more electrons than protons, the atom is a negatively-charged ion or anion. Cations and anions can form a crystalline lattice of neutral salts, such as the  $\text{Na}^+$  and  $\text{Cl}^-$  ions forming sodium chloride, or  $\text{NaCl}$ .

Examples of polyatomic ions that do not split up during acid-base reactions are hydroxide ( $\text{OH}^-$ ) and phosphate ( $\text{PO}_4^{3-}$ ).

Plasma is composed of gaseous matter that has been completely ionized, usually through high temperature.

## Acidity and Basicity



### ACIDS AND BASES (COMPARISON DIAGRAM)

#### Acid or a Base?

A substance can often be classified as an acid or a base. There are several different theories which explain acid-base behavior. The simplest is Arrhenius theory, which states that an acid is a substance that produces hydronium ions when it is dissolved in water, and a base is one that produces hydroxide ions when dissolved in water. According to Brønsted–Lowry acid–base theory, acids are substances that donate a positive hydrogen ion to another substance in a chemical reaction; by extension, a base is the substance which receives that hydrogen ion.

A third common theory is Lewis acid-base theory, which is based on the formation of new chemical bonds. Lewis theory explains that an acid is a substance which is capable of accepting a pair of electrons from another substance during the process of bond formation, while a base is a substance which can provide a pair of electrons to form a new bond.

According to this theory, the crucial things being exchanged are charges. There are several other ways in which a substance may be classified as an acid or a base, as is evident in the history of this concept.

Acid strength is commonly measured by two methods.

One measurement, based on the Arrhenius definition of acidity, is pH, which is a measurement of the hydronium ion concentration in a solution, as expressed on a negative logarithmic scale. Thus, solutions that have a low pH have a high hydronium ion concentration, and can be said to be more acidic.

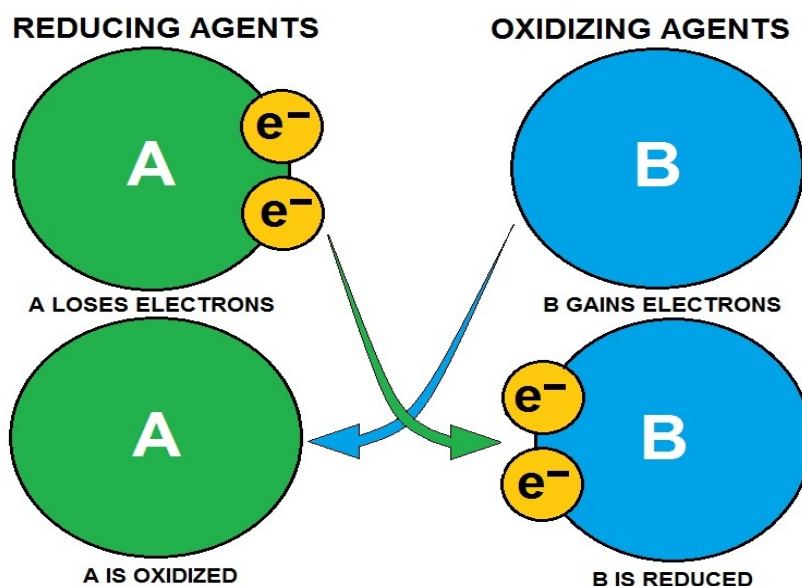
The other measurement, based on the Brønsted–Lowry definition, is the acid dissociation constant ( $K_a$ ), which measures the relative ability of a substance to act as an acid under the Brønsted–Lowry definition of an acid. That is, substances with a higher  $K_a$  are more likely to donate hydrogen ions in chemical reactions than those with lower  $K_a$  values.

## Redox

Redox (*reduction-oxidation*) reactions include all chemical reactions in which atoms have their oxidation state changed by either gaining electrons (reduction) or losing electrons (oxidation).

Substances that have the ability to oxidize other substances are said to be oxidative and are known as oxidizing agents, oxidants or oxidizers. An oxidant removes electrons from another substance. Similarly, substances that have the ability to reduce other substances are said to be reductive and are known as reducing agents, reductants, or reducers.

A reductant transfers electrons to another substance, and is thus oxidized itself. And because it "donates" electrons it is also called an electron donor. Oxidation and reduction properly refer to a change in oxidation number—the actual transfer of electrons may never occur. Thus, oxidation is better defined as an increase in oxidation number, and reduction as a decrease in oxidation number.

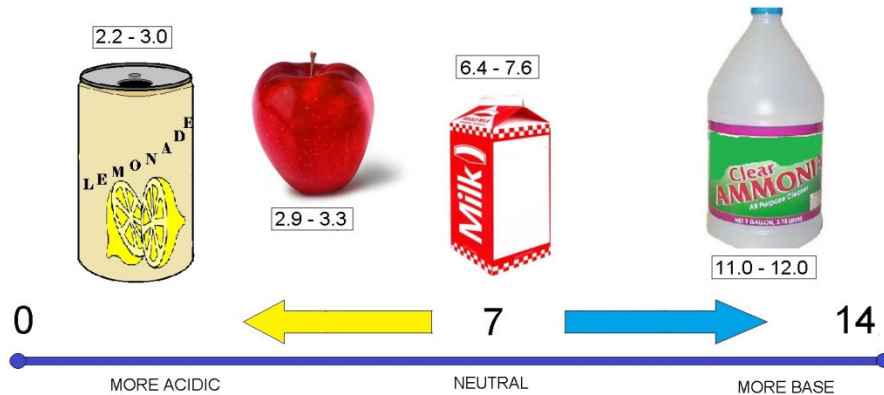


## Equilibrium

Although the concept of equilibrium is widely used across sciences, in the context of chemistry, it arises whenever a number of different states of the chemical composition are possible, as for example, in a mixture of several chemical compounds that can react with one another, or when a substance can be present in more than one kind of phase. A system of chemical substances at equilibrium, even though having an unchanging composition, is most often not static; molecules of the substances continue to react with one another thus giving rise to a dynamic equilibrium. Thus the concept describes the state in which the parameters such as chemical composition remains unchanged over time.



## pH Section



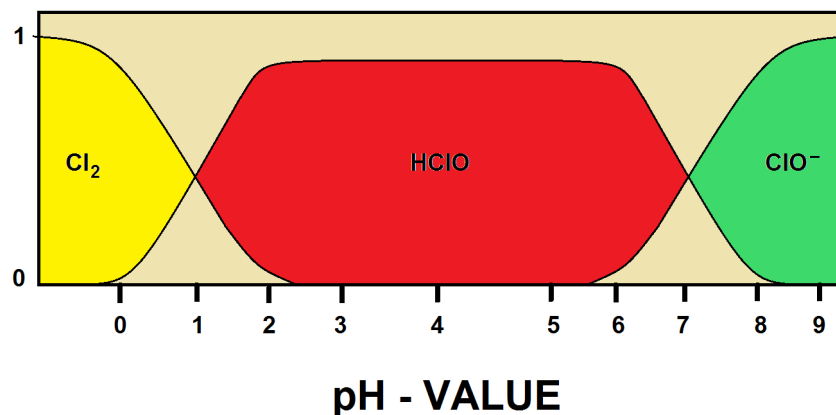
## pH SCALE

In water and wastewater processes, **pH** is a measure of the acidity or basicity of an aqueous solution. Solutions with a pH greater than 7 are basic or alkaline and solution or samples with a pH less than 7 are said to be acidic. Pure water has a pH very close to 7.

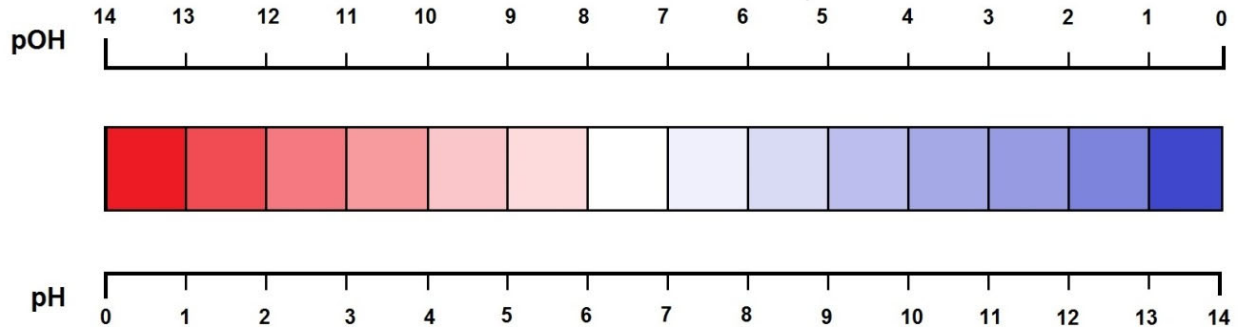
Primary pH standard values are determined using a concentration cell with transference, by measuring the potential difference between a hydrogen electrode and a standard electrode such as the silver chloride electrode. The pH scale is traceable to a set of standard solutions whose pH is established by international agreement.

Measurement of pH for aqueous solutions can be done with a glass electrode and a pH meter, or using indicators like strip test paper.

pH measurements are important in water and wastewater processes (sampling) but also in medicine, biology, chemistry, agriculture, forestry, food science, environmental science, oceanography, civil engineering, chemical engineering, nutrition, water treatment & water purification, and many other applications.



Mathematically, pH is the measurement of hydroxyl ion activity and expressed as the negative logarithm of the activity of the (solvated) hydronium ion, more often expressed as the measure of the hydronium ion concentration.



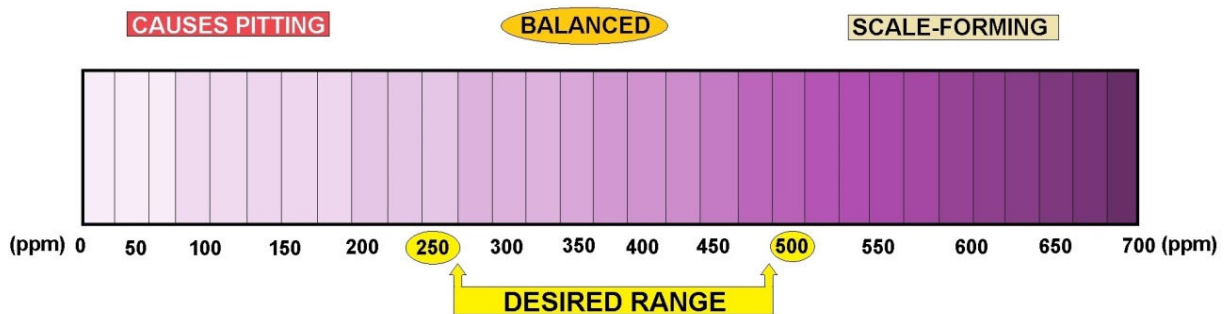
IN RELATION BETWEEN p(OH) AND p(H) (red= ACIDIC / blue= BASIC)

**Contents**  
**History**

The scientific discovery of the p[H] concept of was first introduced by Danish chemist Søren Peder Lauritz Sørensen at the Carlsberg Laboratory back in 1909 and revised to the modern pH in 1924 to accommodate definitions and measurements in terms of electrochemical cells. In the first papers, the notation had the "H" as a subscript to the lowercase "p", as so: pH.

**Alkalinity**

Alkalinity is the quantitative capacity of an aqueous solution to neutralize an acid. Measuring alkalinity is important in determining a stream's ability to neutralize acidic pollution from rainfall or wastewater. It is one of the best measures of the sensitivity of the stream to acid inputs. There can be long-term changes in the alkalinity of rivers and streams in response to human disturbances.



**CALCIUM HARDNESS MEASUREMENT**

Reference. Bates, Roger G. *Determination of pH: theory and practice*. Wiley, 1973.

## pH Definition and Measurement

CONCENTRATION OF HYDROGEN IONS COMPARED TO DISTILLED H <sub>2</sub> O	1/10,000,000	14	LIQUID DRAIN CLEANER CAUSTIC SODA	EXAMPLES OF SOLUTIONS AND THEIR RESPECTIVE pH
	1/1,000,000	13	BLEACHES OVEN CLEANERS	
	1/100,000	12	SOAPY WATER	
	1/10,000	11	HOUSEHOLD AMMONIA (11.9)	
	1/1,000	10	MILK OF MAGNESIUM (10.5)	
	1/100	9	TOOTHPASTE (9.9)	
	1/10	8	BAKING SODA (8.4) / SEA WATER EGGS	
	0	7	"PURE" WATER (7)	
	10	6	URINE (6) / MILK (6.6)	
	100	5	ACID RAIN (5.6) BLACK COFFEE (5)	
	1000	4	TOMATO JUICE (4.1)	
	10,000	3	GRAPEFRUIT & ORANGE JUICE SOFT DRINK	
	100,000	2	LEMON JUICE (2.3) VINEGAR (2.9)	
	1,000,000	1	HYDROCHLORIC ACID SECRETED FROM STOMACH LINING (1)	
	10,000,000	0	BATTERY ACID	

### pH Scale

#### Technical Definition of pH

In technical terms, pH is defined as the decimal logarithm of the reciprocal of the hydrogen ion activity,  $a_{H^+}$ , in a solution.

$$pH = -\log_{10}(a_{H^+}) = \log_{10}\left(\frac{1}{a_{H^+}}\right)$$

Ion-selective electrodes are often used to measure pH, respond to activity.

In this calculation of electrode potential,  $E$ , follows the Nernst equation, which, for the hydrogen ion can be written as

$$E = E^0 + \frac{RT}{F} \ln(a_{H^+}) = E^0 - \frac{2.303RT}{F} pH$$

where  $E$  is a measured potential,  $E^0$  is the standard electrode potential,  $R$  is the gas constant,  $T$  is the temperature in kelvin,  $F$  is the Faraday constant. For  $H^+$  number of electrons transferred is one. It follows that electrode potential is proportional to pH when pH is defined in terms of activity.

International Standard ISO 31-8 is the standard for the precise measurement of pH as follows: A galvanic cell is set up to measure the electromotive force (EMF) between a reference electrode and an electrode sensitive to the hydrogen ion activity when they are both immersed in the same aqueous solution.

The reference electrode may be a silver chloride electrode or a calomel electrode. The hydrogen-ion selective electrode is a standard hydrogen electrode.

Reference electrode | concentrated solution of KCl || test solution | H<sub>2</sub> | Pt

Firstly, the cell is filled with a solution of known hydrogen ion activity and the emf,  $E_s$ , is measured. Then the emf,  $E_x$ , of the same cell containing the solution of unknown pH is measured.

$$pH(X) = pH(S) + \frac{E_s - E_x}{Z}$$

The difference between the two measured emf values is proportional to pH. This method of calibration avoids the need to know the standard electrode potential. The proportionality

constant,  $1/z$  is ideally equal to  $\frac{1}{2.303RT/F}$  the "Nernstian slope".

If you were to apply this practice the above calculation, a glass electrode is used rather than the cumbersome hydrogen electrode. A combined glass electrode has an in-built reference electrode. It is calibrated against buffer solutions of known hydrogen ion activity. IUPAC has proposed the use of a set of buffer solutions of known H<sup>+</sup> activity.

Two or more buffer solutions should be used in order to accommodate the fact that the "slope" may differ slightly from ideal.

The electrode is first immersed in a standard solution and the reading on a pH meter is adjusted to be equal to the standard buffer's value, to implement the proper calibration. The reading from a second standard buffer solution is then adjusted, using the "slope" control, to be equal to the pH for that solution. Further details, are given in the IUPAC recommendations.

When more than two buffer solutions are used the electrode is calibrated by fitting observed pH values to a straight line with respect to standard buffer values. Commercial standard buffer solutions usually come with information on the value at 25 °C and a correction factor to be applied for other temperatures. The pH scale is logarithmic and pH is a dimensionless quantity.

### pH Indicators

Visual comparison of the color of a test solution with a standard color chart provides a means to measure pH accurate to the nearest whole number. Indicators may be used to measure pH, by making use of the fact that their color changes with pH. More precise measurements are possible if the color is measured spectrophotometrically, using a colorimeter or spectrophotometer. Universal indicator consists of a mixture of indicators such that there is a continuous color change from about pH 2 to pH 10. Universal indicator paper is made from absorbent paper that has been impregnated with universal indicator.

### pOH

pOH is sometimes used as a measure of the concentration of hydroxide ions, OH<sup>-</sup>, or alkalinity. pOH values are derived from pH measurements. The concentration of hydroxide ions in water is related to the concentration of hydrogen ions by

$$[\text{OH}^-] = \frac{K_w}{[\text{H}^+]}$$

where  $K_w$  is the self-ionization constant of water. Taking logarithms

$$\text{pOH} = \text{p}K_w - \text{pH}$$

So, at room temperature  $\text{pOH} \approx 14 - \text{pH}$ . However this relationship is not strictly valid in other circumstances, such as in measurements of soil alkalinity.

### Extremes of pH

Measurement of pH below about 2.5 (ca. 0.003 mol dm<sup>-3</sup> acid) and above about 10.5 (ca. 0.0003 mol dm<sup>-3</sup> alkali) requires special procedures because, when using the glass electrode, the Nernst law breaks down under those conditions.

Extreme pH measurements imply that the solution may be concentrated, so electrode potentials are affected by ionic strength variation. At high pH the glass electrode may be affected by "alkaline error", because the electrode becomes sensitive to the concentration of cations such as Na<sup>+</sup> and K<sup>+</sup> in the solution. Specially constructed electrodes are available which partly overcome these problems. Runoff from industrial outfalls, restaurant grease, mines or mine tailings can produce some very low pH values.

### Non-aqueous Solutions

Hydrogen ion concentrations (activities) can be measured in non-aqueous solvents. pH values based on these measurements belong to a different scale from aqueous pH values, because activities relate to different standard states. Hydrogen ion activity,  $a_{\text{H}^+}$ , can be defined as:

$$a_{\text{H}^+} = \exp\left(\frac{\mu_{\text{H}^+} - \mu_{\text{H}^+}^\ominus}{RT}\right)$$

where  $\mu_{\text{H}^+}$  is the chemical potential of the hydrogen ion,  $\mu_{\text{H}^+}^\ominus$  is its chemical potential in the chosen standard state,  $R$  is the gas constant and  $T$  is the thermodynamic temperature. Therefore pH values on the different scales cannot be compared directly, requiring an intersolvent scale which involves the transfer activity coefficient of hydrolyonium ion.

pH is an example of an acidity function. Other acidity functions can be defined. For example, the Hammett acidity function,  $H_0$ , has been developed in connection with superacids.

The concept of "Unified pH scale" has been developed on the basis of the absolute chemical potential of the proton. This scale applies to liquids, gases and even solids.

### Applications

Water has a pH of  $pK_w/2$ , so the pH of pure water is about 7 at 25 °C; this value varies with temperature. When an acid is dissolved in water, the pH will be less than that of pure water. When a base, or alkali, is dissolved in water, the pH will be greater than that of pure water.

A solution of a strong acid, such as hydrochloric acid, at concentration 1 mol dm<sup>-3</sup> has a pH of 0. A solution of a strong alkali, such as sodium hydroxide, at concentration 1 mol dm<sup>-3</sup>, has a pH of 14. Thus, measured pH values will lie mostly in the range 0 to 14, though negative pH values and values above 14 are entirely possible.

Since pH is a logarithmic scale, a difference of one pH unit is equivalent to a tenfold difference in hydrogen ion concentration.

The pH of an aqueous solution of pure water is slightly different from that of, a salt such as sodium chloride even though the salt is neither acidic nor basic. In this case, the hydrogen and hydroxide ions' activity is dependent on ionic strength, so  $K_w$  varies with ionic strength. The pH of pure water decreases with increasing temperatures. One example is the pH of pure water at 50 °C is 6.55.

### Seawater

The pH of seawater plays an important role in the ocean's carbon cycle, and there is evidence of ongoing ocean acidification caused by carbon dioxide emissions. pH measurement can be complicated by the chemical properties of seawater, and several distinct pH scales exist in chemical oceanography.

As part of its operational definition of the pH scale, the IUPAC defines a series of buffer solutions across a range of pH values (often denoted with NBS or NIST designation).

These solutions have a relatively low ionic strength (~0.1) compared to that of seawater (~0.7), and, as a consequence, are not recommended for use in characterizing the pH of seawater, since the ionic strength differences cause changes in electrode potential.

To resolve this problem, an alternative series of buffers based on artificial seawater was developed. This new series resolves the problem of ionic strength differences between samples and the buffers. The newest pH scale is referred to as the **total scale**, often denoted as **pH<sub>T</sub>**.

## Calculations of pH

The calculation of the pH of a solution containing acids and/or bases is an example of a chemical speciation calculation, that is, a mathematical procedure for calculating the concentrations of all chemical species that are present in the solution.

The complexity of the procedure depends on the nature of the solution.

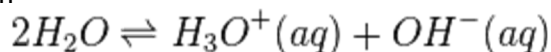
If the pH of a solution contains a weak acid requires the solution of a quadratic equation.

If the pH of a solution contains a weak base may require the solution of a cubic equation.

For strong acids and bases no calculations are necessary except in extreme situations.

The general case requires the solution of a set of non-linear simultaneous equations.

A complicating factor is that water itself is a weak acid and a weak base. It dissociates according to the equilibrium

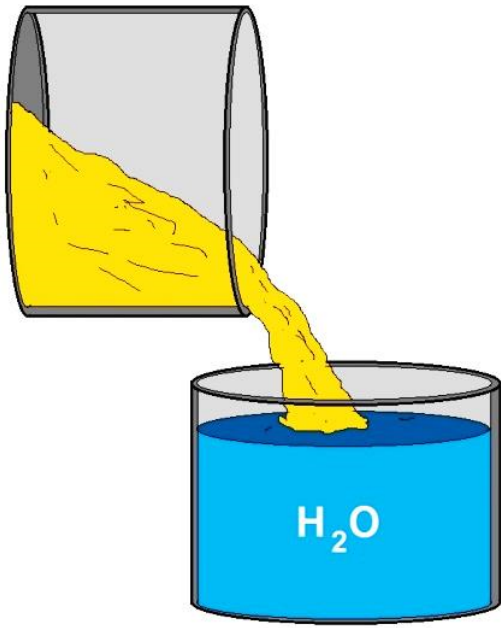


with a dissociation constant,  $K_w$  defined as

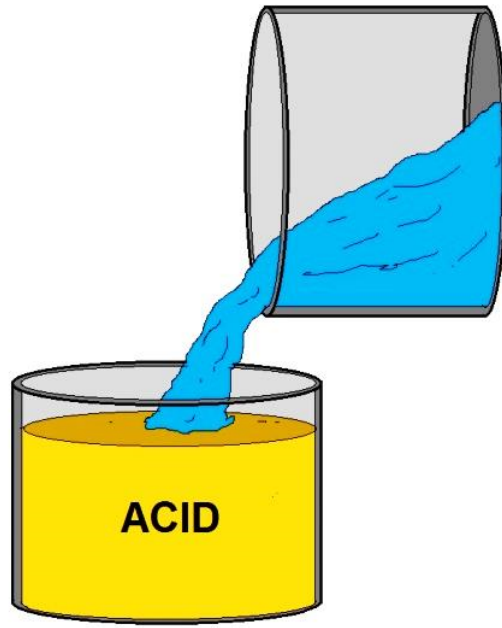
$$K_w = [H^+][OH^-]$$

where  $[H^+]$  represents for the concentration of the aquated hydronium ion and  $[OH^-]$  stands for the concentration of the hydroxide ion.  $K_w$  has a value of about  $10^{-14}$  at 25 °C, so pure water has a pH of approximately 7.

This equilibrium needs to be considered at high pH and when the solute concentration is extremely low.



**ADD ACID TO WATER**



**NEVER ADD WATER  
TO ACID**



## Strong Acids and Bases



### Strong Acids and Bases

Strong acids and bases are compounds that, for practical purposes, are completely dissociated in water. Under normal circumstances this means that the concentration of hydrogen ions in acidic solution can be taken to be equal to the concentration of the acid. The pH is then equal to minus the logarithm of the concentration value.

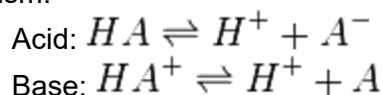
Hydrochloric acid (HCl) is an example of a strong acid. The pH of a 0.01M solution of HCl is equal to  $-\log_{10}(0.01)$ , that is,  $\text{pH} = 2$ .

Sodium hydroxide, NaOH, is an example of a strong base. The p[OH] value of a 0.01M solution of NaOH is equal to  $-\log_{10}(0.01)$ , that is,  $\text{p[OH]} = 2$ .

From the definition of p[OH] above, this means that the pH is equal to about 12. For solutions of sodium hydroxide at higher concentrations the self-ionization equilibrium must be taken into account.

### Weak Acids and Bases

A weak acid or the conjugate acid of a weak base can be treated using the same formalism.



First, an acid dissociation constant is defined as follows. Electrical charges are omitted from subsequent equations for the sake of generality

$$K_a = \frac{[H][A]}{[HA]}$$

and its value is assumed to have been determined by experiment. This being so, there are three unknown concentrations, [HA], [H<sup>+</sup>] and [A<sup>-</sup>] to determine by calculation. Two additional equations are needed.

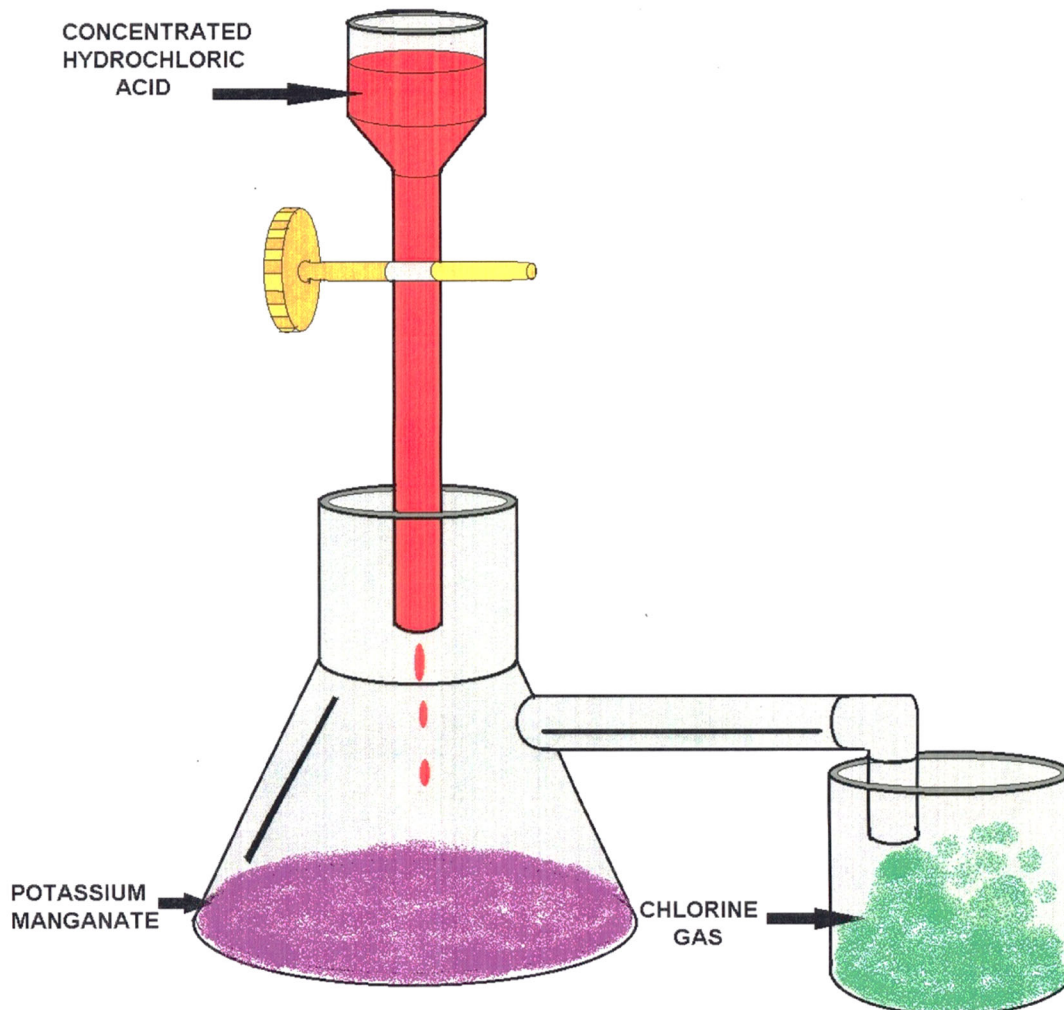
One way to provide them is to apply the law of mass conservation in terms of the two "reagents" H and A.

$$\begin{aligned}C_A &= [A] + [HA] \\C_H &= [H] + [HA]\end{aligned}$$

C stands for analytical concentration. In some texts one mass balance equation is replaced by an equation of charge balance. This is satisfactory for simple cases like this one, but is more difficult to apply to more complicated cases as those below.

Together with the equation defining  $K_a$ , there are now three equations in three unknowns. When an acid is dissolved in water  $C_A = C_H = C_a$ , the concentration of the acid, so  $[A] = [H]$ . After some further algebraic manipulation an equation in the hydrogen ion concentration may be obtained.

$$[H]^2 + K_a[H] - K_aC_a = 0$$



## Alkalinity Sub-Section

### Introduction

Alkalinity of water is its acid-neutralizing capacity. It is the sum of all the titratable bases. The measured value may vary significantly with the end-point pH used. Alkalinity is a measure of an aggregate property of water and can be interpreted in terms of specific substances only when the chemical composition of the sample is known.

### Alkalinity and pH Adjustment

Adjusting pH and alkalinity is the most common corrosion control method because it is simple and inexpensive. pH is a measure of the concentration of hydrogen ions present in water; alkalinity is a measure of water's ability to neutralize acids.

Generally, water pH less than 6.5 is associated with uniform corrosion, while pH between 6.5 and 8.0 can be associated with pitting corrosion. Some studies have suggested that systems using only pH to control corrosion should maintain a pH of at least 9.0 to reduce the availability of hydrogen ions as electron receptors. However, pH is not the only factor in the corrosion equation; carbonate and alkalinity levels affect corrosion as well.

Generally, an increase in pH and alkalinity can decrease corrosion rates and help form a protective layer of scale on corrodible pipe material.

Chemicals commonly used for pH and alkalinity adjustment are hydrated lime ( $\text{CaOH}_2$  or calcium hydroxide), caustic soda ( $\text{NaOH}$  or sodium hydroxide), soda ash ( $\text{Na}_2\text{CO}_3$  or sodium carbonate), and sodium bicarbonate ( $\text{NaHCO}_3$ , essentially baking soda).

Care must be taken, however, to maintain pH at a level that will control corrosion but not conflict with optimum pH levels for disinfection and control of disinfection by-products.

### Corrosion Inhibitors

Inhibitors reduce corrosion by forming protective coatings on pipes. The most common corrosion inhibitors are inorganic phosphates, sodium silicates and mixtures of phosphates and silicates. These chemicals have proven successful in reducing corrosion in many water systems.

The phosphates used as corrosion inhibitors include polyphosphates, orthophosphates, glassy phosphates and bimetallic phosphates. In some cases, zinc is added in conjunction with orthophosphates or polyphosphates.

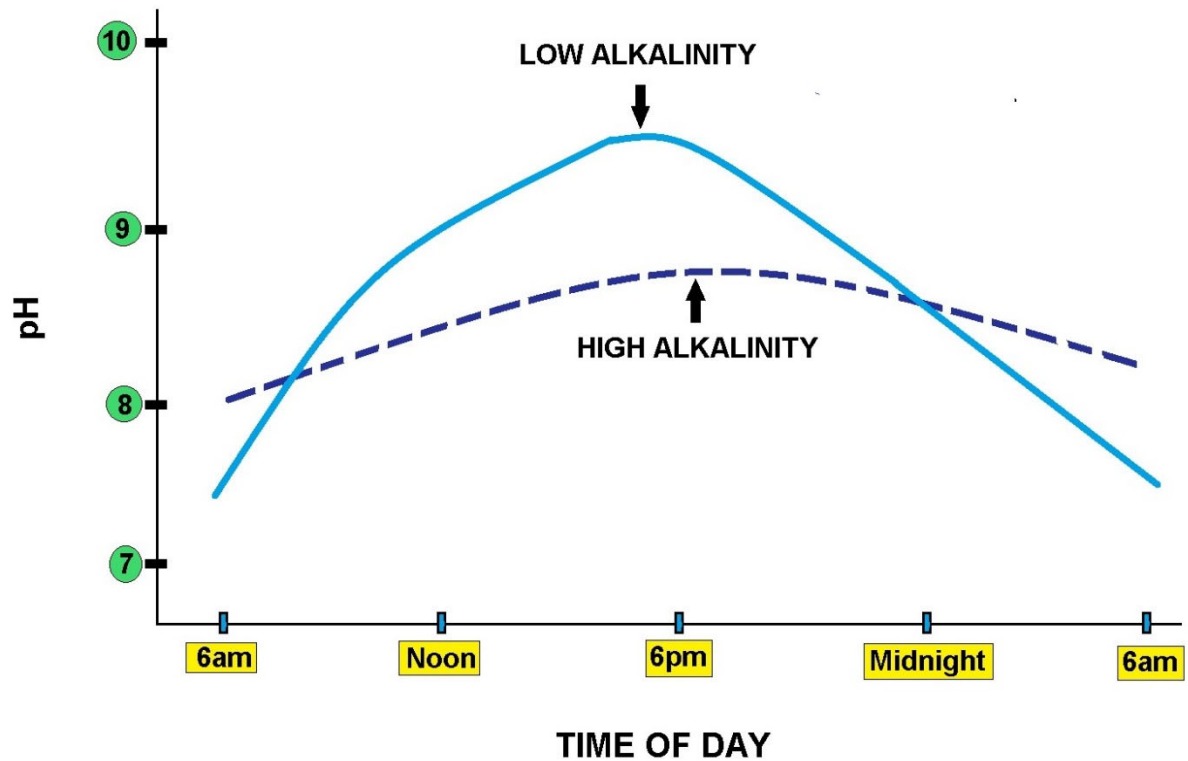
Glassy phosphates, such as sodium hexametaphosphate, effectively reduce iron corrosion at dosages of 20 to 40 mg/l.



Glassy phosphate has an appearance of broken glass and can cut the operator. Sodium silicates have been used for over 50 years to inhibit corrosion. The effectiveness depends on the water pH and carbonate concentration.

Sodium silicates are particularly effective for systems with high water velocities, low hardness, low alkalinity and a pH of less than 8.4.

Typical coating maintenance doses range from 2 to 12 mg/l. They offer advantages in hot water systems because of their chemical stability. For this reason, they are often used in the boilers of steam heating systems.



**ALKALINITY CAN CHANGE THROUGHOUT THE DAY DIAGRAM**

## Alkalinity Testing

### Introduction

Alkalinity of water is its acid-neutralizing capacity. It is the sum of all the titratable bases. The measured value may vary significantly with the end-point pH used. Alkalinity is a measure of an aggregate property of water and can be interpreted in terms of specific substances only when the chemical composition of the sample is known.

Alkalinity is significant in many uses and treatments of natural waters and wastewaters. Because the alkalinity of many surface waters is primarily a function of carbonate, bicarbonate, and hydroxide content, it is taken as an indication of the concentration of these constituents.

The measured values also may include contributions from borates, phosphates, silicates or other bases if these are present. Alkalinity in excess of alkaline earth metal concentrations is significant in determining the suitability of water for irrigation. Alkalinity measurements are used in the interpretation and control of water and wastewater treatment processes.

### Titration Method

#### a. Principle

Hydroxyl ions present in a sample, as a result of dissociation or hydrolysis of solutes react with additions of standard acid. Alkalinity thus depends on the end-point pH used.

#### b. Reagents

- i) Standard Hydrochloric Acid – 0.02 N.
- ii) Methyl Orange Indicator – Dissolve 0.1 g of methyl orange in distilled water and dilute to 1 liter.
- iii) Sodium carbonate solution, 0.02 N: Dry 3 to 5 g primary standard  $\text{Na}_2\text{CO}_3$  at  $250^\circ\text{C}$  for 4 h and cool in a desiccator. Weigh 1.03 gm. (to the nearest mg), transfer to a 1-L volumetric flask, fill flask to the mark with distilled water, dissolve and mix reagent. Do not keep longer than 1 week.

#### c. Procedure

Titrate over a white surface 100 ml of the sample contained in a 250-ml conical flask with standard hydrochloric acid using two or three drops of methyl orange Indicator. (NOTE – If more than 30 ml of acid is required for the titration, a smaller suitable aliquot of the sample shall be taken.)

#### d. Calculation

**Total alkalinity** (as  $\text{CaCO}_3$ ), mg/l =  $10 V$  or  $N \times V \times 50 \times 1000$

T.A. (as  $\text{CaCO}_3$ ) =  $\frac{\text{Sample Amount}}{\text{Sample Amount}}$

Where  $N$  = Normality of HCl used

$V$  = volume in ml of standard hydrochloric acid used in the titration.

### Alkalinity to Phenolphthalein

The sample is titrated against standard acid using phenolphthalein indicator.

**a. Reagents**

- i) Phenolphthalein Indicator Solution :  
Dissolve 0.1 g of phenolphthalein in 60 ml of ETHANOL and dilute with Distilled water to 100 ml.
- ii) Standard hydrochloric Acid – 0.02 N.

**b. Procedure**

Add 2 drops of phenolphthalein indicator solution to a sample of suitable size, 50 or 100 ml, in a conical flask and titrate over a white surface with standard hydrochloric acid.

**c. Calculation**

$$\text{Alkalinity to phenolphthalein (as CaCO}_3\text{), mg/l} = \frac{1000 V_1}{V_2}$$

Where

V<sub>1</sub> = volume in ml of standard hydrochloric acid used in the titration , and  
V<sub>2</sub> = Volume in ml of the sample taken for the test.

**Caustic Alkalinity**

**a. General**

Caustic alkalinity is the alkalinity corresponding to the hydroxides present in water and is calculated from total alkalinity (T) and alkalinity to phenolphthalein (P).

<b>b. Procedure</b> Determine total alkalinity and alkalinity to phenolphthalein and calculate caustic alkalinity as shown in Table below. Result of Titration Caustic Alkalinity or Hydroxide Alkalinity as CaCO <sub>3</sub> Carbonate Alkalinity as CaCO <sub>3</sub> Bicarbonate Concentration as CaCO <sub>3</sub>	<b>Caustic Alkalinity or Hydroxide Alkalinity as CaCO<sub>3</sub></b>	<b>Carbonate Alkalinity as CaCO<sub>3</sub></b>	<b>Bicarbonate Concentration as CaCO<sub>3</sub></b>
<b>Result of Titration</b>			
P=0	0	0	0
P<1/2T	0	2P	T-2P
P=1/2T	0	2P	0
P>1/2T	2P-T	2(T-P)	0
P=T	T	0	0

The alkalinity of water is a measure of its capacity to neutralize acids. The alkalinity of natural water is due to the salts of carbonate, bicarbonate, borates, silicates and phosphates along with the hydroxyl ions in free state. However, the major portion of the alkalinity in natural waters is caused by hydroxide, carbonate, and bicarbonates which may be ranked in order of their association with high pH values. Alkalinity values provide guidance in applying proper doses of chemicals in water and waste water treatment processes, particularly in coagulation and softening.

## Alkalinity (Total)

References: ASTM D 1067-92, Acidity or Alkalinity of Water.  
APHA Standard Methods, 19th ed., p. 2-26, method 2320B (1995).  
EPA Methods for Chemical Analysis of Water and Wastes, method 310.1 (1983).

The alkalinity of water is a measurement of its buffering capacity or ability to react with strong acids to a designated pH. Alkalinity of natural waters is typically a combination of bicarbonate, carbonate, and hydroxide ions. Sewage and wastewaters usually exhibit higher alkalinities either due to the presence of silicates and phosphates or to a concentration of the ions from natural waters.

Alkalinity inhibits corrosion in boiler and cooling waters and is therefore a desired quality which must be maintained. It is also measured as a means of controlling water and wastewater treatment processes or the quality of various process waters. In natural waters, excessive alkalinity can render water unsuitable for irrigation purposes and may indicate the presence of industrial effluents.

*The Titrimetric Method.* CHEMetrics' tests determine total or "M" alkalinity using an acid titrant and a pH indicator. The end point of the titration occurs at pH 4.5. Results are expressed as ppm (mg/L) CaCO<sub>3</sub>.

### Hardness (calcium)

Reference: West, T. S., DSC, Ph.D., Complexometry with EDTA and Related Reagents, 3rd ed., p. 46, 164 (1969).

Originally described as water's capacity to precipitate soap, hardness is one of the most frequently determined qualities of water. It is a composite of the calcium, magnesium, strontium, and barium concentrations in a sample. The current practice is to assume total hardness refers to the calcium and magnesium concentrations only.

Completely de-hardened water, resulting from sodium zeolite or other suitable ion exchange treatment, is required for various processes-including power generation, printing and photo finishing, pulp and paper manufacturing, and food and beverage processing. Hard water can cause scale formation on heat exchange surfaces, resulting in decreased heat transfer and equipment damage.

*The Titrimetric Method.* This method is specific for calcium hardness. The EGTA titrant in alkaline solution is employed with zincon indicator. Results are expressed as ppm (mg/L) CaCO<sub>3</sub>.

Shelf-life. 8 months. Although the reagent itself is stable, the end point indicator has a limited shelf-life. We recommend stocking quantities that will be used within 7 months.





## Halogen Sub-Section Fluorine Section

**Name:** Fluorine

**Symbol:** F

**Atomic Number:** 9

**Atomic Mass:** 18.998404 amu

**Melting Point:** -219.62 °C (53.530006 K, -363.31598 °F)

**Boiling Point:** -188.14 °C (85.01 K, -306.652 °F)

**Number of Protons/Electrons:** 9

**Number of Neutrons:** 10

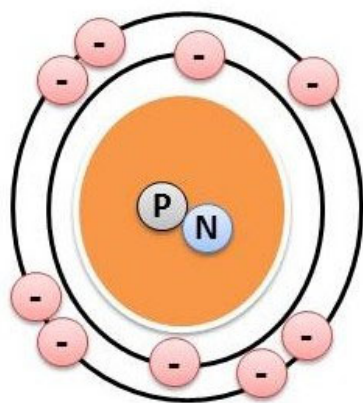
**Classification:** Halogen

**Crystal Structure:** Cubic

**Density @ 293 K:** 1.696 g/cm<sup>3</sup>

**Color:** Greenish

### Atomic Structure



 ELECTRONS = 9

 PROTONS = 9

 NEUTRONS = 10

 NUCLEUS

### Isotopes

Isotope	Half Life
F-18	1.8 hours
F-19	Stable

### Facts

**Date of Discovery:** 1886

**Discoverer:** Joseph Henri Moissan

**Name Origin:** From the Latin word *fluo* (flow)

**Uses:** Refrigerants

**Obtained From:** Mineral fluorite

## Bromine Section

**Name:** Bromine

**Symbol:** Br

**Atomic Number:** 35

**Atomic Mass:** 79.904 amu

**Melting Point:** -7.2 °C (265.95 K, 19.04 °F)

**Boiling Point:** 58.78 °C (331.93 K, 137.804 °F)

**Number of Protons/Electrons:** 35

**Number of Neutrons:** 45

**Classification:** Halogen

**Crystal Structure:** Orthorhombic

**Density @ 293 K:** 3.119 g/cm<sup>3</sup>

**Color:** Red

**Date of Discovery:** 1826

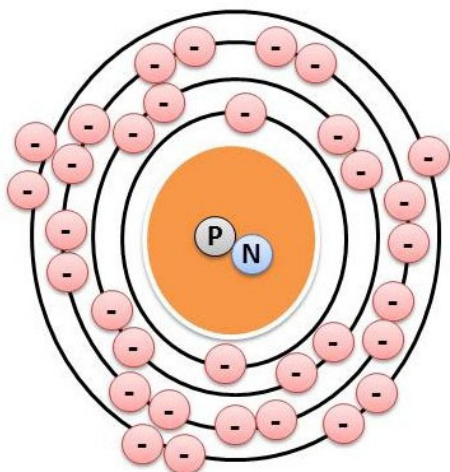
**Discoverer:** Antoine J. Balard

**Name Origin:** From the Greek word *brōmos* (stench)

**Uses:** Poisonous

**Obtained From:** Sea Water

### Atomic Structure



 ELECTRONS = 35

 PROTONS = 35

 NEUTRONS = 45

 NUCLEUS

### Isotopes

Isotope	Half Life
Br-76	16.0 hours
Br-77	2.4 days
Br-79	Stable
Br-80	17.7 minutes
Br-80m	4.42 hours
Br-81	Stable
Br-82	1.5 days
Br-83	2.4 hours
Br-84	31.8 minutes
Br-85	2.9 minutes

## Iodine Section

**Name:** Iodine

**Symbol:** I

**Atomic Number:** 53

**Atomic Mass:** 126.90447 amu

**Melting Point:** 113.5 °C (386.65 K, 236.3 °F)

**Boiling Point:** 184.0 °C (457.15 K, 363.2 °F)

**Number of Protons/Electrons:** 53

**Number of Neutrons:** 74

**Classification:** Halogen

**Crystal Structure:** Orthorhombic

**Density @ 293 K:** 4.93 g/cm<sup>3</sup>

**Color:** Blackish

**Facts:**

**Date of Discovery:** 1811

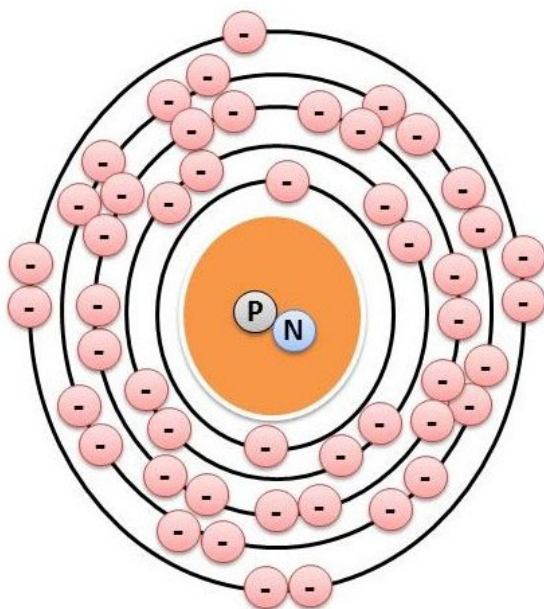
**Discoverer:** Bernard Courtois

**Name Origin:** From the Greek word *iôdes* (violet)

**Uses:** Required in humans

**Obtained From:** Sodium and potassium compounds

### Atomic Structure



 ELECTRONS = 53

 PROTONS = 53

 NEUTRONS = 74

 NUCLEUS

### Isotopes

Isotope	Half Life
I-122	3.6 minutes
I-123	13.2 hours
I-124	4.2 days
I-125	60.1 days
I-126	13.0 days
I-127	Stable
I-128	25.0 minutes

I-129	1.57E7 years
I-130	12.4 hours
I-131	8.0 days
I-132	2.3 hours
I-133	20.8 hours
I-134	52.6 minutes
I-135	6.6 hours
I-136	1.4 minutes

## Astatine Section

**Name:** Astatine

**Symbol:** At

**Atomic Number:** 85

**Atomic Mass:** (210.0) amu

**Melting Point:** 302.0 °C (575.15 K, 575.6 °F)

**Boiling Point:** 337.0 °C (610.15 K, 638.6 °F)

**Number of Protons/Electrons:** 85

**Number of Neutrons:** 125

**Classification:** Halogen

**Crystal Structure:** Unknown

**Density @ 293 K:** Unknown

**Color:** Unknown

**Date of Discovery:** 1940

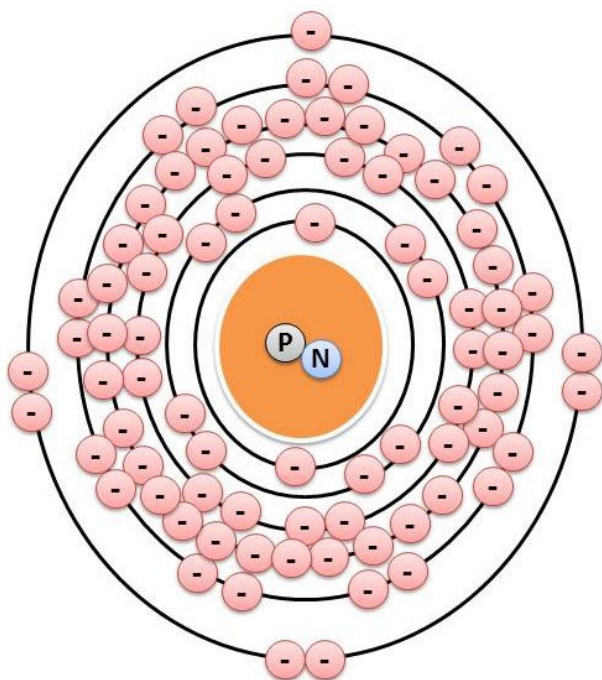
**Discoverer:** D.R. Corson

**Name Origin:** From the Greek word *astatos* (unstable)

**Uses:** No uses known

**Obtained From:** Man-made

### Atomic Structure



● ELECTRONS = 85

● PROTONS = 85

● NEUTRONS = 125

● NUCLEUS

### Isotopes

Isotope	Half Life
At-206	29.4 minutes
At-208	1.6 hours
At-211	7.2 hours
At-215	0.1 milliseconds
At-217	32.0 milliseconds
At-218	1.6 seconds
At-219	50.0 seconds

## Hard Water Section

Hard water is caused by soluble, divalent, metallic cations, (positive ions having valence of 2). The principal chemicals that cause water hardness are calcium (Ca) and magnesium (Mg). Strontium, aluminum, barium, and iron are usually present in large enough concentrations to contribute significantly to the total hardness.

Water hardness varies considerably in different geographic areas of the contiguous 48 states. This is due to different geologic formations, and is also a function of the contact time between water and limestone deposits.

Magnesium is dissolved as water passes over and through dolomite and other magnesium-bearing minerals. Because groundwater is in contact with these formations for a longer period of time than surface water, groundwater is normally harder than surface water.

### Expressing Water Hardness Concentration

Water hardness is generally expressed as a concentration of calcium carbonate, in terms of milligrams per liter as CaCO<sub>3</sub>. The degree of hardness that consumers consider objectionable will vary, depending on other qualities of the water and on the hardness to which they have become accustomed. We will show two different classifications of the relative hardness of water:

#### Comparative classifications of water for softness and hardness

Classification	mg/L as CaCO <sub>3</sub> *	mg/L as CaCO <sub>3</sub> †
Soft	0 – 75	0 – 60
Moderately hard	75 – 150	61 – 120
Hard	150 – 300	121 – 180
Very hard	Over 300	Over 180

*Source: Adapted from Sawyer 1960 and Briggs and Ficke 1977.*

\* Per Sawyer (1960)

† Per Briggs and Ficke (1977)

### Types of Water Hardness

Hardness can be categorized by either of two methods: calcium versus magnesium hardness and carbonate versus non-carbonate hardness. The calcium-magnesium distinction is based on the minerals involved.

Hardness caused by calcium is called calcium hardness, regardless of the salts associated with it, which include calcium sulfate (CaSO<sub>4</sub>), calcium chloride (CaCl<sub>2</sub>), and others. Likewise, hardness caused by magnesium is called magnesium hardness. Calcium and magnesium are normally the only significant minerals that cause hardness, so it is generally assumed that

$$\text{Total hardness} = \text{calcium hardness} + \text{magnesium hardness}$$

The carbonate-noncarbonate distinction, however, is based on hardness from either the bicarbonate salts of calcium or the normal salts of calcium and magnesium involved in causing water hardness.

Carbonate hardness is caused primarily by the bicarbonate salts of calcium and magnesium, which are calcium bicarbonate,  $\text{Ca}(\text{HCO}_3)_2$ , and magnesium bicarbonate  $\text{Mg}(\text{HCO}_3)_2$ .

Calcium and magnesium combined with carbonate ( $\text{CO}_3$ ) also contribute to carbonate hardness.

Noncarbonate hardness is a measure of calcium and magnesium salts other than carbonate and bicarbonate salts. These salts are calcium sulfate, calcium chloride, magnesium sulfate ( $\text{MgSO}_4$ ), and magnesium chloride ( $\text{MgCl}_2$ ).

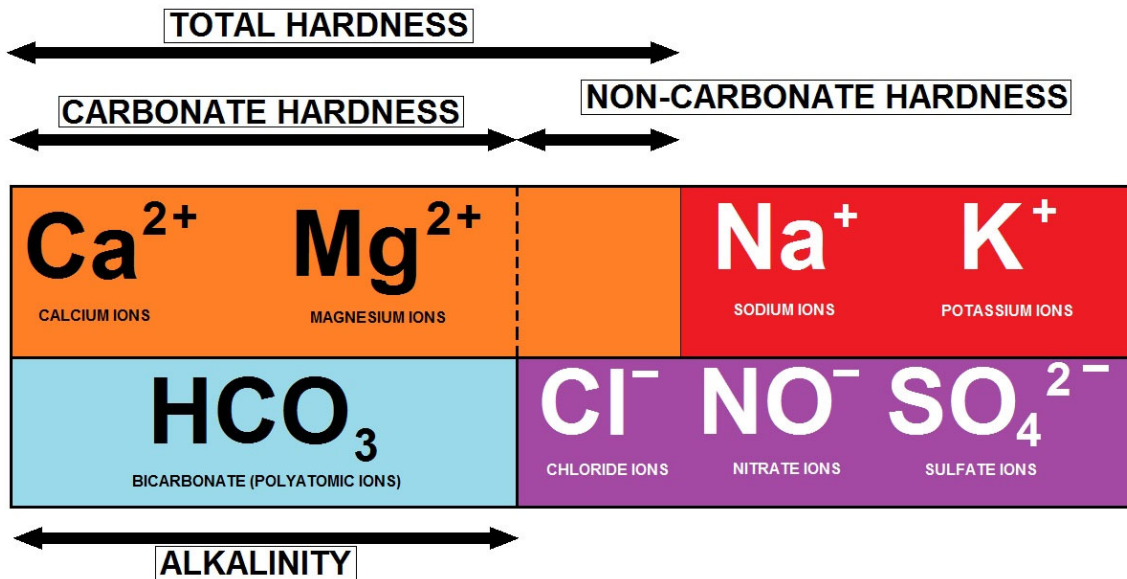
Calcium and magnesium combined with nitrate may also contribute to noncarbonate hardness, although it is a very rare condition. For carbonate and noncarbonate hardness,

$$\text{Total hardness} = \text{carbonate hardness} + \text{noncarbonate hardness}$$

When hard water is boiled, carbon dioxide ( $\text{CO}_2$ ) is driven off, and Bicarbonate salts of calcium and magnesium then settle out of the water to form calcium and magnesium carbonate precipitates. These precipitates form the familiar chalky deposits on teapots.

Because it can be removed by heating, carbonate hardness is sometimes called “*Temporary hardness.*”

Because noncarbonated hardness cannot be removed or precipitated by prolonged boiling, it is sometimes called “*permanent hardness.*”



## CARBONATE HARDNESS CHART

## Total Dissolved Solids (TDS)

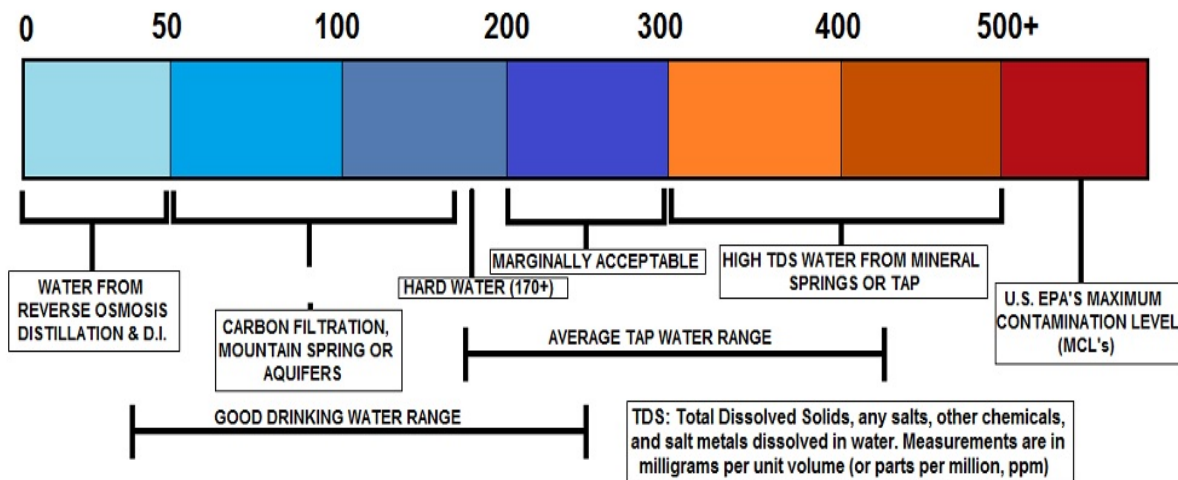
Total dissolved solids (TDS) represents the combined total of all organic and inorganic substances found in drinking water. The total dissolved solids present in water is one of the leading causes of particles and sediments in drinking water, which give water its color, odor, and flavor, and can be a general indicator of water quality.

### Organic substances found in drinking water may include:

- Algae
- Bacteria
- Fungi
- Hair
- Pesticides
- Herbicides
- Fertilizers
- Disinfectants
- Pharmaceuticals

### Inorganic substances found in drinking water may include:

- Arsenic
- Lead
- Mercury
- Chlorine
- Sodium
- Calcium
- Potassium
- Magnesium
- Fluoride



## TDS (Total Dissolved Solids) Explained

### Secondary Standard

TDS is most often measured in parts per million (ppm) or milligrams per liter of water (mg/L). The normal TDS level ranges from 50 ppm to 1,000 ppm. The Environmental Protection Agency (EPA), which is responsible for drinking water regulations in the United States, has identified TDS as a secondary standard, meaning that it is a voluntary guideline. While the United States set legal standards for many harmful substances, TDS, along with other contaminants that cause aesthetic, cosmetic, and technical effects, has only a guideline.

Levels of TDS (milligrams per litre)	Rating
Less than 300	Excellent
300 - 600	Good
600 - 900	Fair
900 - 1,200	Poor
Above 1,200	Unacceptable

Increased concentrations of dissolved solids can also have technical effects. Dissolved solids can produce hard water, which leaves deposits and films on fixtures and can corrode the insides of hot water pipes and boilers.

PARAMETERS	CLARITY	TURBIDITY	TOTAL SUSPENDED SOLIDS (TSS)
<b>DEFINITION</b>	HOW FAR LIGHT CAN PASS THROUGH THE WATER COLUMN	MEASURES THE DEGREE TO WHICH WATER LOSES IT'S TRANSPARENCY	PARTICLES THAT ARE LARGER THAN 2 MICRONS FOUND IN THE WATER COLUMN
<b>COMMENTS</b>	TURBIDITY AND CLARITY ARE DIRECTLY RELATED. TURBIDITY IS A MEASURE OF THE WATER'S CLARITY  High Turbidity = Low Clarity Low Turbidity = High Clarity		WHILE TSS DIRECTLY AFFECTS TURBIDITY, TURBIDITY IS NOT A DIRECT MEASUREMENT OF TOTAL SUSPENDED SOLIDS
<b>WHAT IS MEASURED?</b>	ORGANIC AND INORGANIC SUSPENDED SOLIDS, LIKE CLAY, SILT, SEDIMENT, ALGAE AND BATERIA  + DISSOLVED COLORED MATERIALS (Smaller than 2 Microns)		ORGANIC AND INORGANIC SUSPENDED SOLIDS SETTLABLE SOLIDS (Solids that are moved along the bottom of water by strong flow)
<b>HOW IS IT MEASURED?</b>	<u>DIRECT MEASUREMENT:</u> TURBIDIMETER or TURBIDITY SENSOR  <u>INDIRECT MEASUREMENT:</u> SECCHI DISK or TURBIDITY TUBE  Indirect Methods are Quick and Expensive but are Dependent on the Visual Acuity of the Observer		TO MEASURE TSS, A WATER SAMPLE IS FILTERED, DRIED AND WEIGHED

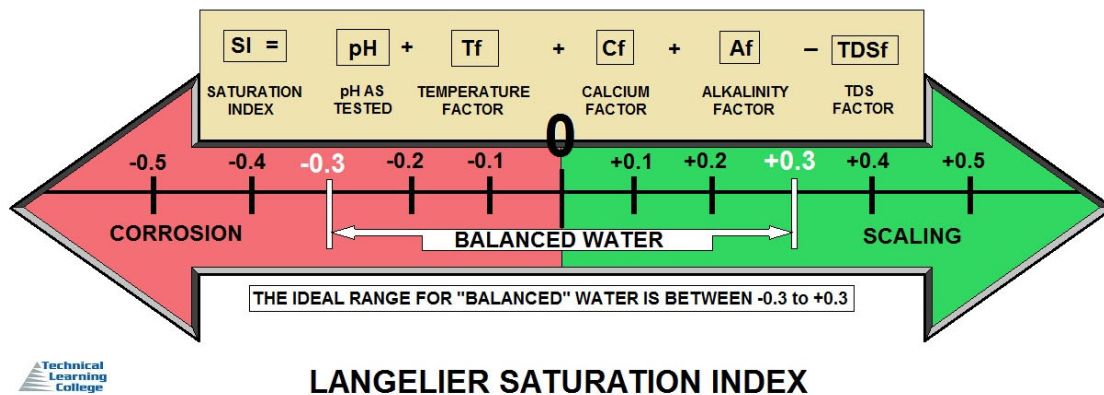
## TOTAL DISSOLVED SOLIDS / WATER TREATMENT



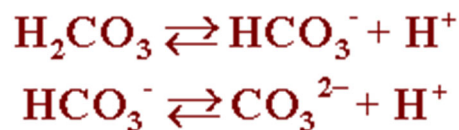


## Langelier Saturation Index

The Langelier Saturation index (LSI) is an equilibrium model derived from the theoretical concept of saturation and provides an indicator of the degree of saturation of water with respect to calcium carbonate. It can be shown that the Langelier saturation index (LSI) approximates the base 10 logarithm of the calcite saturation level. The Langelier saturation level approaches the concept of saturation using pH as a main variable. The LSI can be interpreted as the pH change required to bring water to equilibrium.



Water with a Langelier saturation index of 1.0 is one pH unit above saturation. Reducing the pH by 1 unit will bring the water into equilibrium. This occurs because the portion of total alkalinity present as  $CO_3^{2-}$  decreases as the pH decreases, according to the equilibria describing the dissociation of carbonic acid:



- If LSI is negative: No potential to scale, the water will dissolve  $CaCO_3$
- If LSI is positive: Scale can form and  $CaCO_3$  precipitation may occur
- If LSI is close to zero: Borderline scale potential.
- Water quality or changes in temperature, or evaporation could change the index.

The LSI is probably the most widely used indicator of cooling water scale potential. It is purely an equilibrium index and deals only with the thermodynamic driving force for calcium carbonate scale formation and growth. It provides no indication of how much scale or calcium carbonate will actually precipitate to bring water to equilibrium.

It simply indicates the driving force for scale formation and growth in terms of pH as a master variable. In order to calculate the LSI, it is necessary to know the alkalinity (mg/l as  $CaCO_3$ ), the calcium hardness (mg/l  $Ca^{2+}$  as  $CaCO_3$ ), the total dissolved solids (mg/l TDS), the actual pH, and the temperature of the water ( $^{\circ}C$ ).

If TDS is unknown, but conductivity is, one can estimate mg/L TDS using a conversion table.

LSI is defined as:

$$\text{LSI} = \text{pH} - \text{pH}_s$$

Where:

**pH** is the measured water pH

**pH<sub>s</sub>** is the pH at saturation in calcite or calcium carbonate and is defined as:

$$\text{pH}_s = (9.3 + \text{A} + \text{B}) - (\text{C} + \text{D})$$

Where:

$$\text{A} = (\text{Log}_{10} [\text{TDS}] - 1) / 10$$

$$\text{B} = -13.12 \times \text{Log}_{10} (^\circ\text{C} + 273) + 34.55$$

$$\text{C} = \text{Log}_{10} [\text{Ca}^{2+} \text{ as CaCO}_3] - 0.4$$

$$\text{D} = \text{Log}_{10} [\text{alkalinity as CaCO}_3]$$

## Water Chemistry Post Quiz

### pH Section

1. What is the proper term used that are determined using a concentration cell with transference, by measuring the potential difference between a hydrogen electrode and a standard electrode such as the silver chloride electrode?
2. In chemistry, *pH* is a measure of the acidity or basicity of an aqueous solution. Solutions with a pH less than 7 are said to be acidic and solutions with a pH greater than 7 are basic or alkaline. Pure water has a pH very close to?
3. Mathematically, pH is the negative logarithm of the activity of the (solvated) hydronium ion, more often expressed as the measure of the?
4. Which terms is used for aqueous solutions can be done with a glass electrode and a pH meter, or using indicators?
5. The pH scale is logarithmic and therefore pH is?
6. Measuring alkalinity is important in determining a stream's ability to neutralize acidic pollution from rainfall or wastewater. It is one of the best measures of the sensitivity of the stream to acid inputs. There can be long-term changes in the \_\_\_\_\_ of rivers and streams in response to human disturbances.
7. pH is defined as the decimal logarithm of the reciprocal of the \_\_\_\_\_,  $a_{H^+}$ , in a solution.
8. Alkalinity is the name given to the quantitative capacity of an aqueous solution to neutralize an?
9. What is the term used for the color of a test solution with a standard color chart provides a means to measure pH accurate to the nearest whole number?
10. The calculation of the pH of a solution containing acids and/or bases is an example of a chemical speciation calculation, that is, a mathematical procedure for calculating the concentrations of all chemical species that are present in the solution. The complexity of the procedure depends on the?

11. Under normal circumstances this means that the concentration of hydrogen ions in acidic solution can be taken to be equal to the concentration of the acid. The pH is then equal to minus the logarithm of?

12. Alkalinity of water is its acid-neutralizing capacity. It is the sum of all the titratable bases. The measured value may vary significantly with the?

13. For strong acids and bases no calculations are necessary except in extreme situations. The pH of a solution containing a weak acid requires the solution of a quadratic equation. The pH of a solution containing a weak base may require the?

14. Alkalinity is a measure of this \_\_\_\_\_ and can be interpreted in terms of specific substances only when the chemical composition of the sample is known.

15. More precise measurements are possible if the color is measured spectrophotometrically, using a?

16. For strong acids and bases no calculations are necessary except in extreme situations. The pH of a solution containing a weak acid requires?

17. The calculation of the pH of a solution containing acids and/or bases is an example of a \_\_\_\_\_ calculation, that is, a mathematical procedure for calculating the concentrations of all chemical species that are present in the solution

18. What is the term used for measurements in the interpretation and control of water and wastewater treatment processes?

19. What is the term used for compounds that, for practical purposes, are completely dissociated in water?

20. Sodium hydroxide, NaOH, is an example of a?

## Chapter 4 -Chlorine Section

**Section Focus:** You will learn the basics of water disinfection with an emphasis on Chlorine. At the end of this section, you will be able to describe chlorination. There is a post quiz at the end of this section to review your comprehension and a final examination in the Assignment for your contact hours.

**Scope/Background:** Traditionally, the use of chlorine gas was the most common method of water disinfection. Chlorine gas itself is relatively inexpensive but is a highly toxic chemical that must be transported and handled with extreme caution. It is stored under pressure in large tanks and is released into the water or wastewater as a gas.

**CHLORINE**  
DO NOT TAKE INTERNALLY

AVOID CONTACT WITH EYES, MOUTH OR CLOTHING **WARNING** AVOID BREATHING FUMES

**FLAMMABLE - KEEP FIRE AWAY**  
USE ONLY IN WELL VENTILATED AREAS.  
USE ONLY WHERE THERE ARE NO OPEN FLAMES  
OR OTHER SOURCES OF IGNITION

**EXTREMELY FLAMMABLE**  
KEEP AWAY FROM HEAT, SPARKS AND OPEN FLAME  
KEEP CONTAINER CLOSED

**HAZARD IDENTIFICATION**

**CODE NUMBERS**

- 4 - SEVERE
- 3 - SERIOUS
- 2 - MODERATE
- 1 - SLIGHT
- 0 - MINIMAL

Upon adding chlorine to water, two chemical species, known together as free chlorine, are formed. These species, hypochlorous acid (HOCl, electrically neutral) and hypochlorite ion (OCl<sup>-</sup>, electrically negative), behave very differently. Hypochlorous acid is not only more reactive than the hypochlorite ion, but is also a stronger disinfectant and oxidant.



### 1-Ton Containers

The top line or valve is for extracting the gas, and the bottom line is for extracting the Cl<sub>2</sub> liquid. Never place water on a leaking metal cylinder. Water will help create acid which will make the leak larger.



## Chlorine Timeline

**1879** - This marked the first time that chlorine was applied as a disinfectant. William Soper of England treated the feces of typhoid patients before disposal into the sewer. He used chlorinated lime, which was a common form of chlorine used initially. (White, 1972)

**1893** - This date was the first time that chlorine was applied as a disinfectant on a plant scale basis. This application was made at Hamburg, Germany. (White, 1972)

**1903** - This marked the first time chlorine gas was used as a disinfectant in drinking water. This took place in Middlekerke, Belgium. Prior to this date, chlorine was applied through the use of hydrated lime, chloride of lime, or bleaching powder. The use of chlorine gas was designed by Maurice Duyk, a chemist for the Belgian Ministry of Public Works. (Pontius, 1990)

**1908** - The first full scale chlorine installation at a drinking water plant in the United States was initiated in this year. This installation took place at the Bubbly Creek Filter Plant in Chicago. This plant served the Chicago Stockyards and was designed by George A. Johnson. The raw water contained a large amount of sewage which was causing sicknesses in the livestock. Johnson implemented chlorine through chloride of lime, and the bacterial content of the water dropped drastically. (Pontius, 1990)

**1910** - C. R. Darnall became the first to use compressed chlorine gas from steel cylinders, which is an approach still commonly used today. His installation was in Youngstown, Ohio. His implementation used a pressure-reducing mechanism, a metering device, and an absorption chamber. It was moderately successful, but his setup was only used once.

**1912** - John Kienle, chief engineer of the Wilmington, Delaware water department, invented another way to apply chlorine to drinking water. He developed a way to push compressed chlorine from cylinders into an absorption tower in which water was flowing opposite the flow of the chlorine. Because the gas flow was opposite the water flow, the chlorine was able to disinfect the water. (Pontius, 1990)

**1913** - An Ornstein chlorinator was installed at Kienle's Wilmington, Delaware water treatment plant. This marked the first time a commercial chlorination system was installed at a municipal water treatment plant. The chlorinator used the same basic premise that Kienle's previous installation did, but the Ornstein chlorinator used both a high and low pressure gauge to more accurately control the amount of chlorine added to the system. (Pontius, 1990)

**1914** - On October 14, 1914, the Department of the Treasury enacted the first set of standards that required the use of disinfection for drinking water. These standards called for a maximum level of bacterial concentration of 2 coliforms per 100 milliliters. Because chlorination was the main disinfectant at the time, these standards dramatically increased the number of treatment plants using chlorine. (White, 1972)

**1919** - Two important discoveries were made during this year. Wolman and Enslow discovered the concept of chlorine demand which states that the amount of chlorine needed to disinfect the water is related to the concentration of the waste and the amount of time the chlorine has to

contact the water. The other important discovery of 1919 was by Alexander Houston. He discovered that chlorine can also eliminate taste and odor problems in water. (Pontius, 1990)

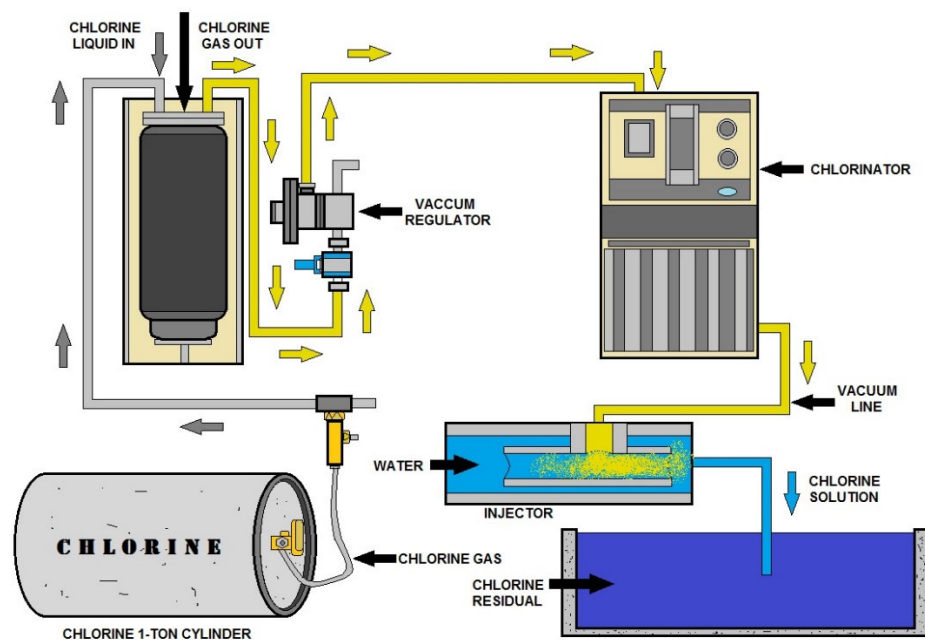
**1925** - New drinking water standards were enacted that reduced the maximum permissible limit of coliforms from 2 to 1 coliform per 100 milliliters. This increased the amount and frequency of chlorination again. (White, 1972)

**1939** - The theory of the chlorine breakpoint was discovered in this year. Chlorine breakpoint theory is discussed in the following section. (White, 1972)

**1960** - A new implementation practice was discovered in this year. The compound loop principle of chlorinator control was implemented, which is the most recent major discovery in chlorine application. (White, 1972)

**1972** - A report entitled "Industrial Pollution of the Lower Mississippi River in Louisiana" was published containing the first evidence of disinfection byproducts in drinking water resulting from organic pollution in source water. (Pontius, 1990)

As is evident by the dates in the timeline, most of the innovation in chlorination occurred over 70 years ago. Very few innovations or discoveries have been made recently. Most of the current research is being performed in other areas of disinfection. These areas include ozone, chlorine dioxide, and UV radiation.



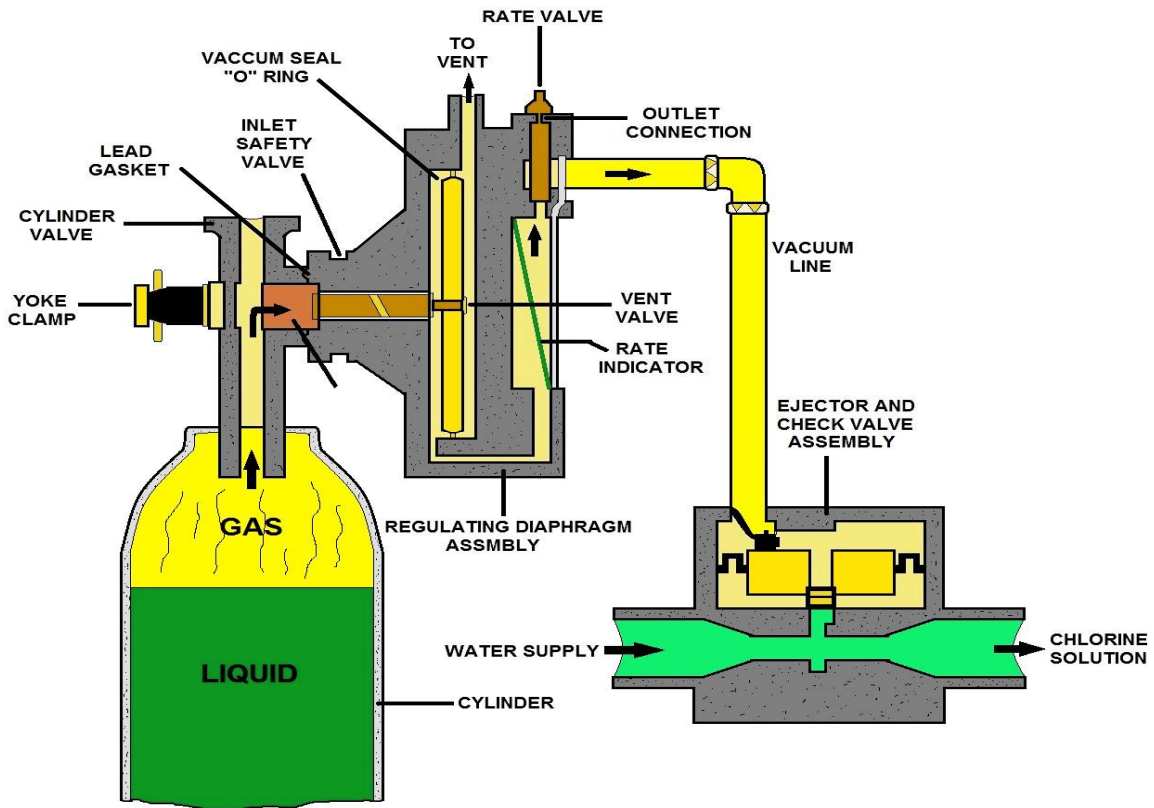
Chlorine is still the most widely used disinfectant in the United States, but other areas of the world are beginning to use other methods of disinfection with increasing frequency. Since chlorine is still widely used, a thorough understanding of how it disinfects and is implemented is important to those interested in water treatment.



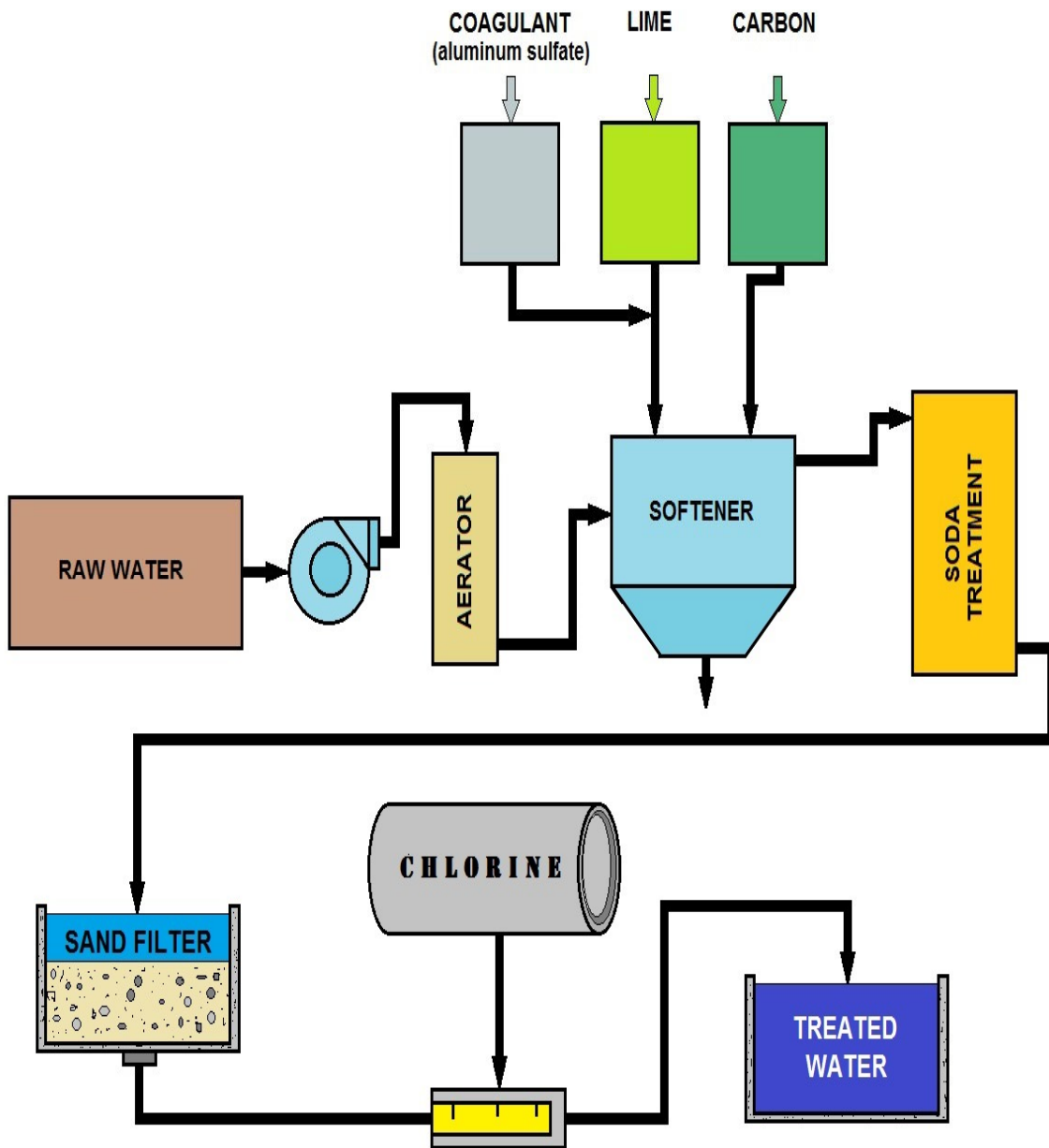
# Chlorine Diagrams # 1



150 pound chlorine cylinder



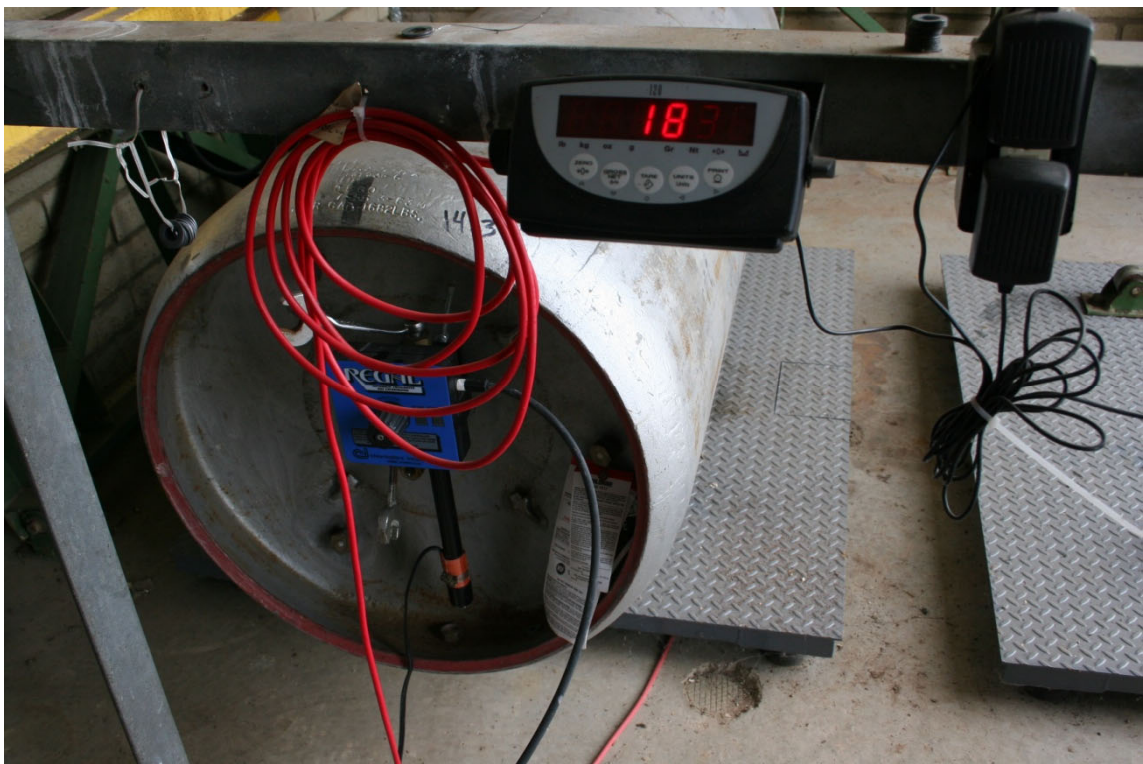
**150 Lb. SINGLE CYLINDER CHLORINATOR**



Water treatment plant chlorine addition diagram



Top photograph, adjusting the chlorine leak alarm sensor. Bottom photograph, chlorine container weight scales.

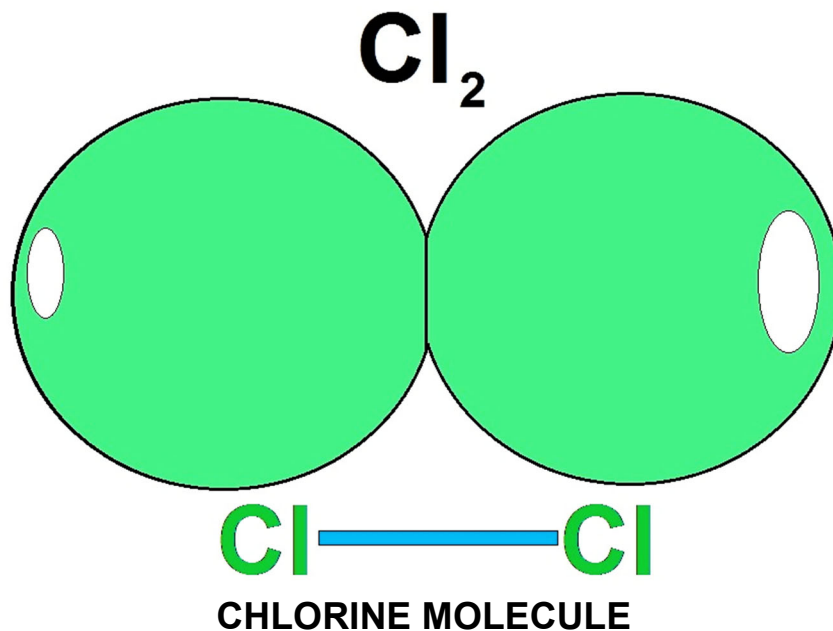




Hard to tell, but these are one-ton chlorine gas containers. Notice the five-gallon bucket of motor oil in the bottom photograph. Do you have an eye wash and emergency shower?



## Elemental Chlorine - Introduction



**Name:** Chlorine  
**Symbol:** Cl  
**Atomic Number:** 17  
**Atomic Mass:** 35.4527 amu  
**Melting Point:** -100.98 °C (172.17 K, -149.764 °F)  
**Boiling Point:** -34.6 °C (238.55 K, -30.279997 °F)  
**Number of Protons/Electrons:** 17  
**Number of Neutrons:** 18  
**Classification:** Halogen  
**Crystal Structure:** Orthorhombic  
**Density @ 293 K:** 3.214 g/cm<sup>3</sup>  
**Color:** Green  
**Uses:** Water purification, bleaches  
**Obtained From:** Salt  
**Date of Discovery:** 1774  
**Discoverer:** Carl Wilhelm Scheele  
**Name Origin:** From the Greek word *khlôros* (green)

### Chlorine Gas Information

#### Identifiers

1. CAS No.: 7782-50-5
2. RTECS No.: FO2100000
3. DOT UN: 1017 20
4. DOT label: Poison gas

## Safety Data

NIOSH IDHL: 10 ppm

NIOSH Ceiling: 0.5ppm/15 minutes

PEL/TWA: 1 ppm

TLV/TWA: 1 ppm

TLV/STEL: 3 ppm

TLV/IDLH: 1993-1994 ACGIH TLV: 0.5 ppm (1.5 mg/m<sup>3</sup>) TWA, 1 ppm (2.9 mg/m<sup>3</sup>) STEL

## Physical Data

1. **Molecular weight:** 70.9
2. **Boiling point (at 760 mm Hg):** -34.6 degrees C (-30.28 degrees F)
3. **Specific gravity (liquid):** 1.41 at 20 degrees C (68 degrees F) and a pressure of 6.86 atm
4. **Vapor density:** 2.5
5. **Melting point:** -101 degrees C (-149.8 degrees F)
6. **Vapor pressure at 20 degrees C (68 degrees F):** 4,800 mm Hg
7. **Solubility:** Slightly soluble in water; soluble in alkalis, alcohols, and chlorides.
8. **Evaporation rate:** Data not available.

## Chlorine's Appearance and Odor

Chlorine is a greenish-yellow gas with a characteristic pungent odor. It condenses to an amber liquid at approximately -34 degrees C (-29.2 degrees F) or at high pressures. Odor thresholds ranging from 0.3-0.5 parts per million (ppm) parts of air have been reported. Prolonged exposures may result in olfactory fatigue. Prolonged, low-level exposures, such as those that occur in the workplace, can lead to olfactory fatigue and tolerance of chlorine's irritant effects.

## Reactivity

1. **Conditions Contributing to Instability:** Cylinders of chlorine may burst when exposed to elevated temperatures. Chlorine in solution forms a corrosive material.
2. **Incompatibilities:** Flammable gases and vapors form explosive mixtures with chlorine. Contact between chlorine and many combustible substances (such as gasoline and petroleum products, hydrocarbons, turpentine, alcohols, acetylene, hydrogen, ammonia, and sulfur), reducing agents, and finely divided metals may cause fires and explosions. Contact between chlorine and arsenic, bismuth, boron, calcium, activated carbon, carbon disulfide, glycerol, hydrazine, iodine, methane, oxomonosilane, potassium, propylene, and silicon should be avoided. Chlorine reacts with hydrogen sulfide and water to form hydrochloric acid, and it reacts with carbon monoxide and sulfur dioxide to form phosgene and sulfuryl chloride. Chlorine is also incompatible with moisture, steam, and water.
3. **Hazardous Decomposition Products:** None reported.
4. **Special Precautions:** Chlorine will attack some forms of plastics, rubber, and coatings.

## Flammability

### ***Chlorine is a non-combustible gas.***

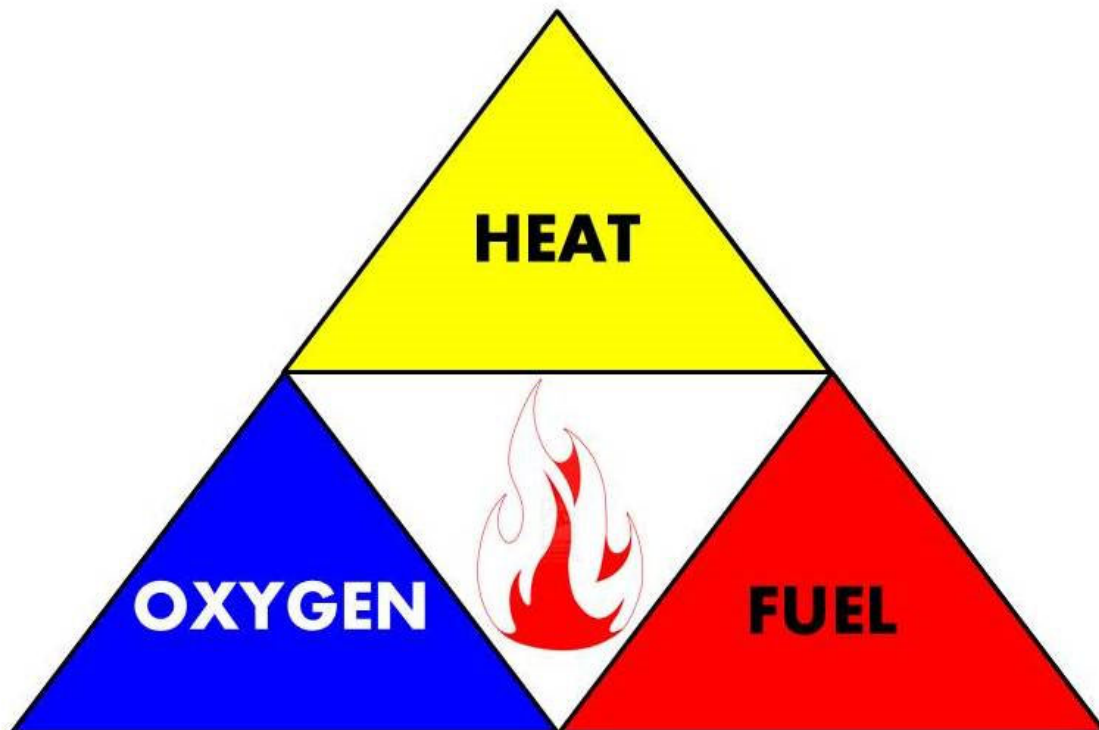
The National Fire Protection Association has assigned a flammability rating of 0 (no fire hazard) to chlorine; however, most combustible materials will burn in chlorine.

1. **Flash point:** Not applicable.
2. **Autoignition temperature:** Not applicable.
3. **Flammable limits in air:** Not applicable.
4. **Extinguishant:** For small fires use water only; do not use dry chemical or carbon dioxide. Contain and let large fires involving chlorine burn. If fire must be fought, use water spray or fog.

**Fires involving chlorine should be fought upwind from the maximum distance possible.**

Keep unnecessary people away; isolate the hazard area and deny entry. For a massive fire in a cargo area, use unmanned hose holders or monitor nozzles; if this is impossible, withdraw from the area and let the fire burn. Emergency personnel should stay out of low areas and ventilate closed spaces before entering.

Containers of chlorine may explode in the heat of the fire and should be moved from the fire area if it is possible to do so safely. If this is not possible, cool fire exposed containers from the sides with water until well after the fire is out. Stay away from the ends of containers. Firefighters should wear a full set of protective clothing and self-contained breathing apparatus when fighting fires involving chlorine.



**FIRE TRIANGLE DIAGRAM**

# Chlorine Exposure Limits

## \* OSHA PEL

The current **OSHA** permissible exposure limit (**PEL**) for chlorine is 1 ppm (3 milligrams per cubic meter ( $\text{mg}/\text{m}^3$ )) as a ceiling limit. A worker's exposure to chlorine shall at no time exceed this ceiling level [29 CFR 1910.1000, Table Z-1].

## \* NIOSH REL

The National Institute for Occupational Safety and Health (**NIOSH**) has established a recommended exposure limit (**REL**) for chlorine of 0.5 ppm ( $\text{mg}/\text{m}^3$ ) as a TWA for up to a 10-hour workday and a 40-hour workweek and a short-term exposure limit (**STEL**) of 1 ppm ( $\text{mg}/\text{m}^3$ )[NIOSH 1992].

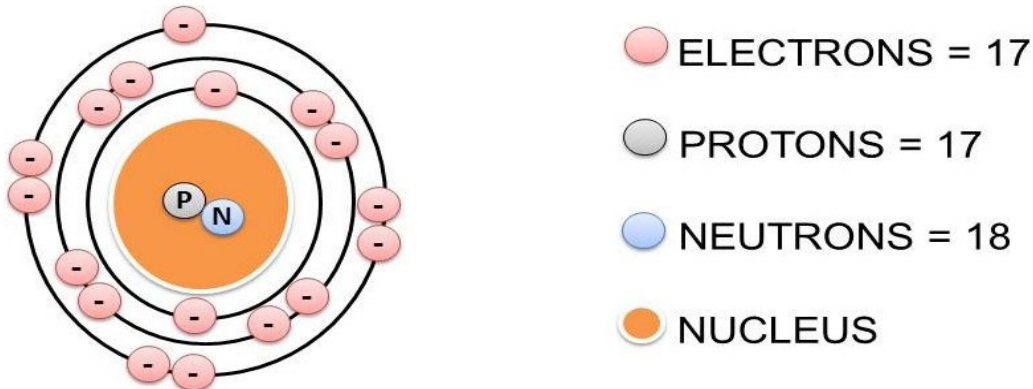
## \* ACGIH TLV

The American Conference of Governmental Industrial Hygienists (**ACGIH**) has assigned chlorine a threshold limit value (**TLV**) of 0.5 ppm ( $\text{mg}/\text{m}^3$ ) as a TWA for a normal 8-hour workday and a 40-hour workweek and a **STEL** of 1 ppm ( $\text{mg}/\text{m}^3$ ) for periods not to exceed 15 minutes. Exposures at the STEL concentration should not be repeated more than four times a day and should be separated by intervals of at least 60 minutes [ACGIH 1994, p. 15].

## \* Rationale for Limits

The NIOSH limits are based on the risk of severe eye, mucous membrane and skin irritation [NIOSH 1992]. The ACGIH limits are based on the risk of eye and mucous membrane irritation [ACGIH 1991, p. 254].

# Chlorine's Atomic Structure



## Isotopes

Isotope	Half Life
Cl-35	Stable
Cl-36	301000.0 years
Cl-37	Stable
Cl-38	37.2 minutes



## Chlorine Disinfectant Qualities

Chlorine is one of 90 natural elements, the basic building blocks of our planet. To be useful, an element must be relatively abundant or have extremely desirable properties. Chlorine has both characteristics. As a result -- over the course of many decades of careful research and development -- scientists have learned to use chlorine and the products of chlorine chemistry to make drinking water safe, destroy life-threatening germs, produce life-saving drugs and medical equipment, shield police and fire fighters in the line of duty, and ensure a plentiful food supply.

In 1774, in his small experimental laboratory, Swedish pharmacist Carl Wilhem Scheele released a few drops of hydrochloric acid onto a piece of manganese dioxide. Within seconds, a greenish-yellow gas arose. Although he had no idea at the time, he had just discovered chlorine.

The fact that the greenish-yellow gas was actually an element was only recognized several decades later by English chemist Sir Humphrey Davy. Until that time, people were convinced that the gas was a compound of oxygen. Davy gave the element its name on the basis of the Greek word *khloros*, for greenish-yellow. In 1810 he suggested the name "*chloric gas*" or "*chlorine*."

One of the most effective and economical germ-killers, chlorine also destroys and deactivates a wide range of dangerous germs in homes, hospitals, swimming pools, hotels, restaurants, and other public places. Chlorine's powerful disinfectant qualities come from its ability to bond with and destroy the outer surfaces of bacteria and viruses. First used as a germicide to prevent the spread of "child bed fever" in the maternity wards of Vienna General Hospital in Austria in 1846, chlorine has been one of society's most potent weapons against a wide array of life-threatening infections, viruses, and bacteria for 150 years.

When the first men to set foot on the moon returned to earth (Apollo 11 mission: 24.7.69) a hypochlorite solution was chosen as one of the disinfectants for destroying any possible moon germs.

### What Happens to Chlorine When it Enters the Environment?

- When released to air, chlorine will react with water to form hypochlorous acid and hydrochloric acid, which are removed from the atmosphere by rainfall.
- Chlorine is slightly soluble in water. It reacts with water to form hypochlorous acid and hydrochloric acid. The hypochlorous acid breaks down rapidly. The hydrochloric acid also breaks down; its breakdown products will lower the pH of the water (makes it more acidic).
- Since chlorine is a gas it is rarely found in soil. If released to soil, chlorine will react with moisture forming hypochlorous acid and hydrochloric acid. These compounds can react with other substances found in soil.
- Chlorine does not accumulate in the food chain.

Restaurants and meat and poultry processing plants rely on chlorine bleach and other chlorine-based products to kill harmful levels of bacteria such as *Salmonella* and *E. coli* on food preparation surfaces and during food processing. Chlorine is so important in poultry processing that the US Department of Agriculture requires an almost constant chlorine rinse for much of the cutting equipment. In fact, no proven economical alternative to chlorine disinfection exists for use in meat and poultry processing facilities.

### Properties

Because it is highly reactive, chlorine is usually found in nature bound with other elements like sodium, potassium, and magnesium. When chlorine is isolated as a free element, chlorine is a greenish yellow gas, which is 2.5 times heavier than air. It turns to a liquid state at  $-34^{\circ}\text{C}$  ( $-29^{\circ}\text{F}$ ), and it becomes a yellowish crystalline solid at  $-103^{\circ}\text{C}$  ( $-153^{\circ}\text{F}$ ). Chemists began experimenting with chlorine and chlorine compounds in the 18th century. They learned that chlorine has an extraordinary ability to extend a chemical bridge between various elements and compounds that would not otherwise react with each other. Chlorine has been especially useful in studying and synthesizing organic compounds -- compounds that have at least one atom of the element carbon in their molecular structure. All living organisms, including humans, are composed of organic compounds.

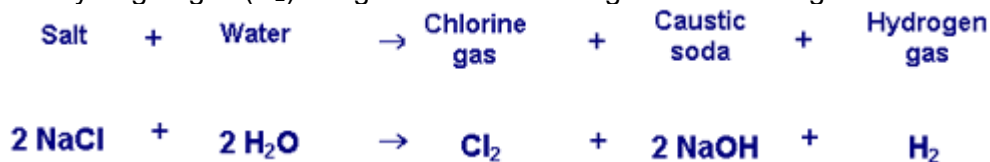
Chlorine is one of the most abundant chemical elements on Earth. It is ubiquitous in soils, minerals, plants and animals. Seawater is a huge reservoir of dissolved chlorine weathered from the continents and transported to the oceans by Earth's rivers.

Chlorine is also one of the most useful chemical elements. Each chemical element has its own set of unique properties and chlorine is known as a very reactive element--so reactive, in fact, that it is usually found combined with other elements in the form of compounds. More than 3,500 naturally occurring chlorinated organic (associated with living organisms) compounds alone have been identified.

Chlorine's chemical properties have been harnessed innovatively for good use. For example, this element plays a huge role in public health. Chlorine-based disinfectants are capable of removing a wide variety of disease-causing germs from drinking water and wastewater as well as from hospital and food production surfaces. Additionally, chlorine plays an important role in the manufacture of thousands of products we depend upon every day, including such diverse items as cars, computers, pharmaceuticals and military flak jackets. As the ninth largest chemical produced in the U.S. by volume, chlorine is truly a "workhorse chemical."

### Released From the Salt of the Earth

Chlorine is produced industrially from the compound sodium chloride, one of the many salts found in geologic deposits formed from the slow evaporation of ancient seawater. When electricity is applied to a brine solution of sodium chloride, chlorine gas ( $\text{Cl}_2$ ), caustic soda ( $\text{NaOH}$ ) and hydrogen gas ( $\text{H}_2$ ) are generated according to the following reaction:



## Co-Products

As the reaction demonstrates, chlorine gas cannot be produced without producing caustic soda, so chlorine and caustic soda are known as "co-products," and their economics are inextricably linked. Caustic soda, also called "alkali," is used to produce a wide range of organic and inorganic chemicals and soaps. In addition, the pulp and paper, alumina and textiles industries use caustic soda in their manufacturing processes. Thus, the "chlor-alkali" industry obtains two very useful chemicals by applying electrical energy to sea salt.



## Definitions

### Chlorine Gas Feed Room

A chlorine gas feed room, for the purposes of this document, is a room that contains the chlorinator(s) and active cylinder(s) used to apply chlorine gas at a water or wastewater facility.

### Chlorine Gas Storage Room

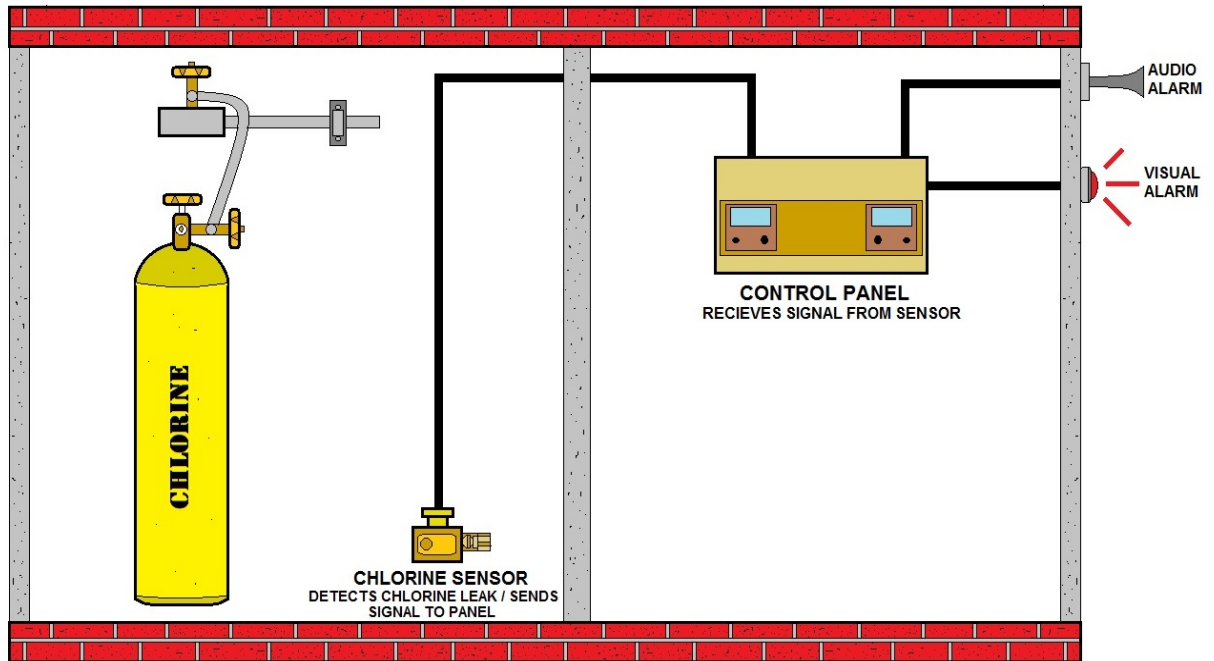
A chlorine gas storage room, for the purposes of this document, is a room other than a chlorine gas feed room, in which full, partial, or empty chlorine gas cylinders or ton containers are stored at a water or wastewater facility.

### Gas Chlorinator

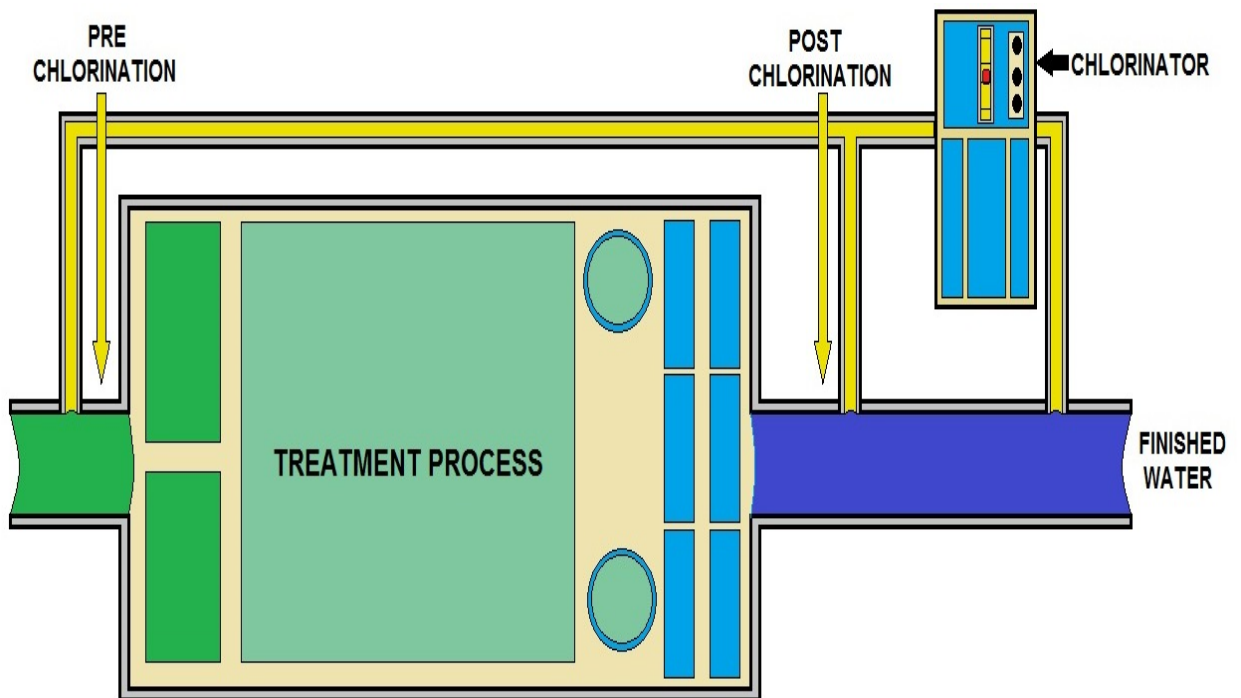
A gas chlorinator is a device used to meter and control the application rate of chlorine gas into a liquid. There is the danger of the gas escaping at a treatment facility. The gas chlorinator should be isolated from a treatment plant.

### Chlorine Cabinet

A chlorine cabinet is a pre-assembled or factory built unit that contains the equipment used to apply chlorine gas at a water or wastewater treatment facility. It is isolated from a water or wastewater treatment plant.



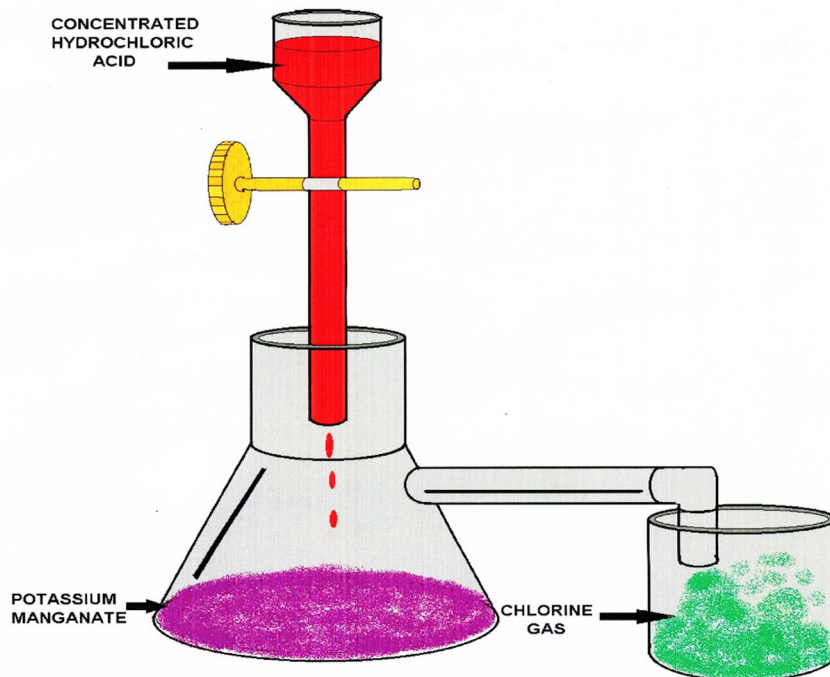
**CHLORINE STORAGE ROOM**



**CHLORINE FLOW IN A TREATMENT PLANT DIAGRAM**

## Chlorine Gas Sub-Section

**Background:** Chlorine gas is a pulmonary irritant with intermediate water solubility that causes acute damage in the upper and lower respiratory tract. Chlorine gas was first used as a chemical weapon at Ypres, France in 1915. Of the 70,552 American soldiers poisoned with various gasses in World War I, 1843 were exposed to chlorine gas. Approximately 10.5 million tons and over 1 million containers of chlorine are shipped in the U.S. each year, so it can be and is handled safely.



Chlorine is a yellowish-green gas at standard temperature and pressure. It is extremely reactive with most elements. Because its density is greater than that of air, the gas settles low to the ground. It is a respiratory irritant, and it burns the skin. Just a few breaths of it are fatal.  $\text{Cl}_2$  gas does not occur naturally, although chlorine can be found in a number of compounds.

Chlorine gas is likely the most widely used oxidizing microbiocide. Beside water and wastewater treatment, it has traditionally been the biocide of choice in many cooling water treatment systems. It is a strong oxidizer that is relatively easy to feed and is quite inexpensive. Upon introduction into the water stream, chlorine hydrolyzes into hypochlorous acid ( $\text{HOCl}$ ) and hydrochloric acid ( $\text{HCl}$ ).

This hydrolyzation provides the most active toxicant,  $\text{HOCl}$ , which is pH-dependent. In alkaline conditions, it readily dissociates to form the hypochlorite ion ( $\text{OCl}^-$ ). This dissociation phenomenon is important to remember in alkaline conditions,  $\text{OCl}^-$  becomes the predominant species and lacks the biocidal efficacy of the non-dissociated form. Considerably more  $\text{HOCl}$  is present at a pH of 7.0 than at pH 8.5.

It is also widely known that chlorine is non-selective, making it very sensitive to contamination from either cooling water makeup or from in-plant process leaks. Ammonia, organic acids and

organic compounds, sulfides, iron and manganese all easily react with HOCl. The amount of chlorine needed to react with these contamination species is referred to as chlorine demand and it must be satisfied before active HOCl is available to provide a free chlorine residual.

The combination of high chlorine demand in process-contaminated systems and the dissociation process in alkaline systems creates the need for greater chlorine feed to obtain the same microbial efficacy. This results in a higher concentration of HCl in the cooling system. Since HCl removes alkalinity, pH depression and system corrosion could occur. In low pH water, the passive metal oxide layers protecting the metal may resolubilize, exposing the surface to corrosion.

At free mineral acidity (pH <4.3), many passivating inhibitors become ineffective, and corrosion will proceed rapidly. Increased chloride may also have a negative impact on system corrosion. The chloride ion (Cl<sup>-</sup>) can damage or penetrate the passive oxide layer, leading to localized damage of the metal surface.

High chlorine concentrations have also been shown to directly attack traditional organic-based corrosion inhibitors. When these inhibitors are "deactivated," the metal surface would then be susceptible to corrosion. Process Safety Management (PSM) guidelines dictated by the U.S. Occupational Safety and Health Administration (OSHA), discharge problems related to chlorinated organic compounds such as trihalomethane (THM), dezincification of admiralty brass and delignification of cooling tower wood are other significant concerns associated with the use of chlorine.

## **Pathophysiology**

Chlorine is a greenish-yellow, noncombustible gas at room temperature and atmospheric pressure. The intermediate water solubility of chlorine accounts for its effect on the upper airway and the lower respiratory tract.

Exposure to chlorine gas may be prolonged because its moderate water solubility may not cause upper airway symptoms for several minutes. In addition, the density of the gas is greater than that of air, causing it to remain near ground level and increasing exposure time.

The odor threshold for chlorine is approximately 0.3-0.5 parts per million (ppm); however, distinguishing toxic air levels from permissible air levels may be difficult until irritative symptoms are present.

## **Mechanism of Activity**

The mechanisms of the above biological activity are poorly understood and the predominant anatomic site of injury may vary, depending on the chemical species produced. Cellular injury is believed to result from the oxidation of functional groups in cell components, from reactions with tissue water to form hypochlorous and hydrochloric acid, and from the generation of free oxygen radicals.

Although the idea that chlorine causes direct tissue damage by generating free oxygen radicals was once accepted, this idea is now controversial. The cylinders on the right contain chlorine gas.

The gas comes out of the cylinder through a gas regulator. The cylinders are on a scale that operators use to measure the amount used each day. The chains are used to prevent the tanks from falling over. Chlorine gas is stored in vented rooms that have panic bar equipped doors.

Operators have the equipment necessary to reduce the impact of a gas leak, but usually rely on trained emergency response teams to contain leaks.

### **Solubility Effects**

Hydrochloric acid is highly soluble in water. The predominant targets of the acid are the epithelia of the ocular conjunctivae and upper respiratory mucus membranes. Hypochlorous acid is also highly water soluble with an injury pattern similar to hydrochloric acid.



Hypochlorous acid may account for the toxicity of elemental chlorine and hydrochloric acid to the human body.

### **Early Response to Chlorine Gas**

Chlorine gas, when mixed with ammonia, reacts to form chloramine gas. In the presence of water, chloramines decompose to ammonia and hypochlorous acid or hydrochloric acid. The early response to chlorine exposure depends on the

- (1) concentration of chlorine gas,
- (2) duration of exposure,
- (3) water content of the tissues exposed, and
- (4) individual susceptibility.

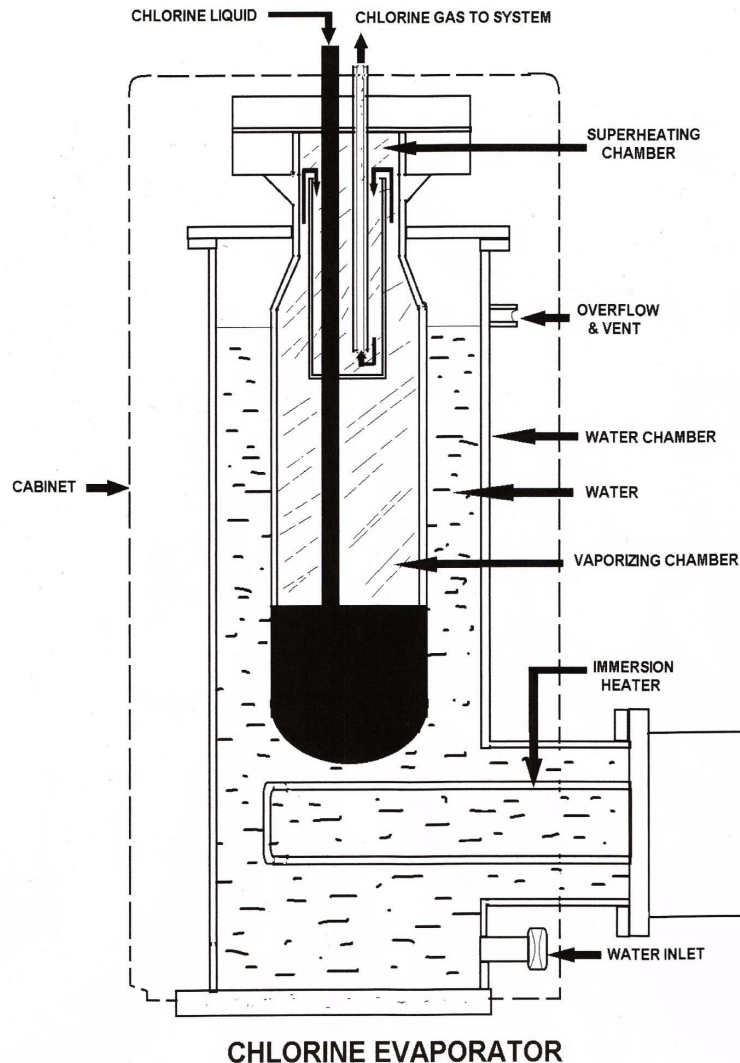
### **Immediate Effects**

The immediate effects of chlorine gas toxicity include acute inflammation of the conjunctivae, nose, pharynx, larynx, trachea, and bronchi. Irritation of the airway mucosa leads to local edema secondary to active arterial and capillary hyperemia. Plasma exudation results in filling the alveoli with edema fluid, resulting in pulmonary congestion.

### **Pathological Findings**

Pathologic findings are nonspecific. They include severe pulmonary edema, pneumonia, hyaline membrane formation, multiple pulmonary thromboses, and ulcerative tracheobronchitis.

The hallmark of pulmonary injury associated with chlorine toxicity is pulmonary edema, manifested as hypoxia. Noncardiogenic pulmonary edema is thought to occur when there is a loss of pulmonary capillary integrity.



### What handling and storage practices should be used when working with chlorine?

**Handling:** In event of a spill or leak, immediately put on escape-type respirator and exit the area. Immediately report leaks, spills or failures of the safety equipment (e.g. ventilation system). Secure cylinder in an up-right position. Protect cylinders from damage. Use a suitable hand truck to move cylinders; do not drag, roll, slide, or drop. Use the pressure regulator appropriate for cylinder pressure and contents.

**Storage:** Store in an area that is: cool, dry, well-ventilated, out of direct sunlight and away from heat and ignition sources, secure and separate from work areas, separate from incompatible materials, on the ground floor or preferably, in an isolated, detached building. Always secure (e.g. chain) cylinders in an upright position to a wall, rack or other solid structure. Label container with date received, date opened and disposal date. Use a first-in, first-out inventory system. Empty containers may contain hazardous residue. Store separately. Keep closed. Comply with all applicable health and safety regulations, fire and building codes.

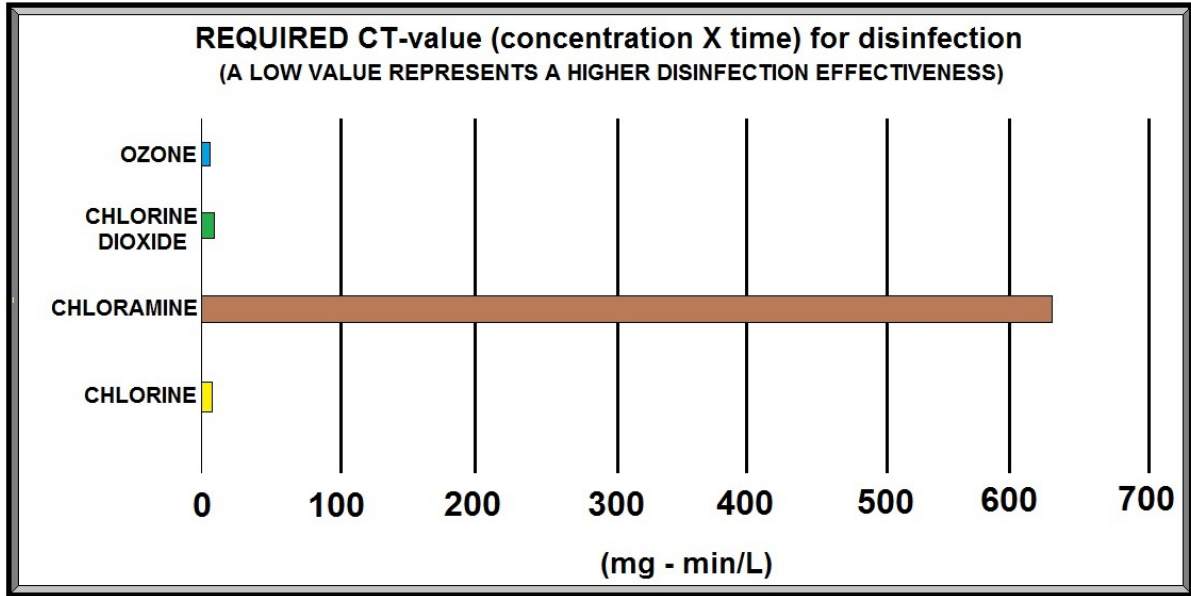


## Chlorine Diagrams #2

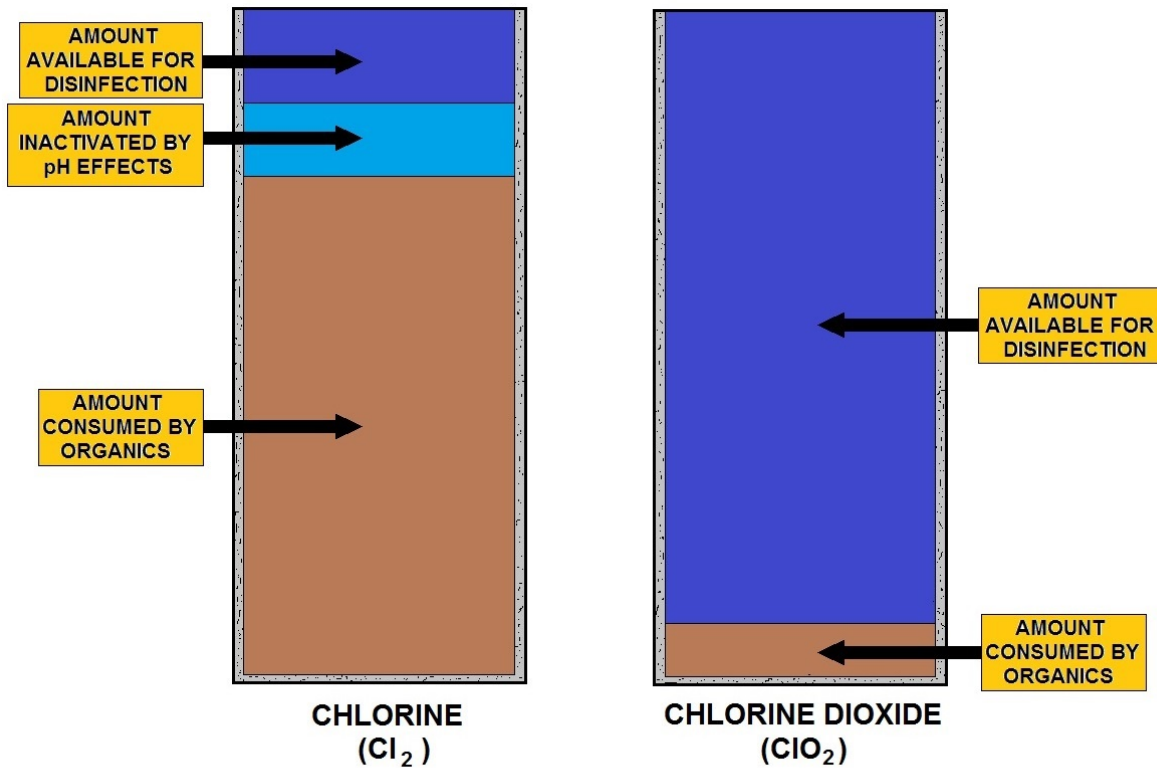
BACTERIA / VIRUS	DISINFECTION TIME FOR FECAL CONTAMINANTS IN CHLORINATED WATER
E. COLI (BACTERIUM)	LESS THAN 1 MINUTE OF CONTACT TIME
HEPATITUS A (VIRUS)	APPROXIMATELY 16 MINUTES CONTACT TIME
GIARDIA (PARASITE)	APPROXIMATELY 45 MINUTES CONTACT TIME
CRYPTOSPORIDIUM (PARASITE)	APPROXIMATELY 10.6 DAYS (15,300 minutes)

CHLORINE TIMETABLE FOR PROPER DISINFECTION

SYMPTOM OF CHLORINE POISONING:
DIFFICULTY IN BREATHING, ACCUMULATION IN LUNGS
BURNING SENSATION IN MOUTH, THROAT SWELLING
THROAT AND STOMACH PAIN, VOMITING
ACIDITY LEVELS IN BODY CHANGE, LOW BLOOD PRESSURE
BURNING AND IRRITATION OF EYES, TEMPORARY LOSS OF VISION
TISSUE DAMAGE, BURNS AND IRRITATION OF THE SKIN



CONTACT VALUES FOR VARIOUS TYPES OF DISINFECTANTS USED IN WATER TREATMENT



THE DIFFERENCE IN USING CHLORINE AND CHLORINE DIOXIDE AS A DISINFECTANT

## Chlorine's Effectiveness

The effectiveness of chlorination depends on the chlorine demand of the water, the concentration of the chlorine solution added, the time that chlorine is in contact with the organism, and water quality. These effects can be summarized in the following manner:

- As the concentration of the chlorine increases, the required contact time to disinfect decreases.
- Chlorination is more effective as water temperature increases.
- Chlorination is less effective as the water's pH increases (becomes more alkaline).
- Chlorination is less effective in cloudy (turbid) water.
- When chlorine is added to the water supply, part of it combines with other chemicals in water (like iron, manganese, hydrogen sulfide, and ammonia) and is not available for disinfection. The amount of chlorine that reacts with the other chemicals plus the amount required to achieve disinfection is the **chlorine demand** of the water.



The safest way to be sure that the amount of chlorine added is sufficient is to add a little more than is required. This will result in a free chlorine residual that can be measured easily. This chlorine residual must be maintained for several minutes depending on chlorine level and water quality. Table 4 lists the free chlorine residual level needed for different contact times, water temperatures and pH levels.

Kits are available for measuring the chlorine residual by looking for a color change after the test chemical is added. The test is simple and easy for a homeowner to perform. If chlorination is required for the water supply, the chlorine residual should be tested regularly to make sure the system is working properly. The kit should specify that it measures the free chlorine residual and not the total chlorine. Once chlorine has combined with other chemicals it is not effective as a disinfectant. If a test kit does not distinguish between free chlorine and chlorine combined with other chemicals, the test may result in an overestimation of the chlorine residual.

Chlorine will kill bacteria in water, but it takes some time (Table 4) . The time needed depends on the concentration of chlorine. Two methods of chlorination are used to disinfect water: **simple chlorination** and **superchlorination**.

<b>Table 4. Necessary chlorine residual to disinfect water for various contact times, water temperatures and pH</b>			
<b>Water Temp. 50 degrees F</b>			
<b>Contact time (minutes)</b>	<b>Necessary chlorine residual (mg/l)</b>		
	<b>pH 7</b>	<b>pH 7.5</b>	<b>pH 8</b>
40	0.2	0.3	0.4
30	0.3	0.4	0.5
20	0.4	0.6	0.8
10	0.8	1.2	1.6
5	1.6	2.4	3.2
2	4.0	6.0	8.0
1	8.0	12.0	16.0
<b>Water Temp. 32 - 40 degrees F</b>			
<b>Contact time (minutes)</b>	<b>Necessary chlorine residual (mg/l)</b>		
	<b>pH 7</b>	<b>pH 7.5</b>	<b>pH 8</b>
40	0.3	0.5	0.6
30	0.4	0.6	0.8
20	0.6	0.9	1.2
10	1.2	1.8	2.4
5	2.4	3.6	4.8
2	6.0	9.0	12.0
1	12.0	18.0	24.0

**Example: What is the necessary chlorine residual for well water with pH 7.5?**

The well water is 38 degrees F when it enters the house. The pump delivers 7 gallons per minute and after the chlorine is added it is held in a 100 gallon holding tank.

1. Contact time (from Table 5) - gallons per minute for 50 gallon tank = 5 minutes
2. Multiply by 2 for a 100 gallon tank = 10 minutes.
3. Necessary chlorine residual (from Table 4)- for water at 38 degrees F and pH 7.5 = **1.8 mg/l.**

*Simple chlorination* involves maintaining a low level of free residual chlorine at a concentration between 0.30 to .5 mg/l for at least 30 minutes. The residual is measured at the faucet most distant from the where chlorine is added to the water supply.

To ensure the proper contact time of at least 30 minutes, a holding tank can be installed (Table 5). Pressure tanks, while often thought to be sufficient, are usually too small to always provide 30 minutes of contact time.

<b>Table 5. Available contact time from a 50-gallon holding tank</b>	
<b>Water flow rate (gallons per minute)</b>	<b>Holding time (minutes)</b>
5	7
7	5
10	3.5

Another way to maintain necessary contact time is to run the chlorinated water through a coil of pipe (Table 6).

<b>Table 6. Available contact time from 1000 feet of 1-1/4 inch pipe</b>	
<b>Water flow rate (gallons per minute)</b>	<b>Holding time (minutes)</b>
5	9.2
7	6.6
10	4.6

When the water cannot be held for at least 30 minutes before it is used, super chlorination is an alternative. For **superchlorination**, a chlorine solution is added to the water to produce a chlorine residual of between 3.0 and 5.0 mg/l, which is about ten times stronger than for simple chlorination.

The necessary contact time for this concentration is reduced to less than five minutes (Table 4). The water will have a very strong chlorine smell. If this is not desirable, the chlorine can be removed just before it is used with a carbon filter (Note: may not be currently allowed under your Department of Health for private water supplies).

### **Oxidation Chemistry**

Oxidation chemistry has long been an accepted and effective part of many water treatment programs. Oxidizing chemicals used in today's water treatment programs include: chlorine, chlorine dioxide, bromine, bromine/chlorine releasing compounds, ozone and hydrogen peroxide.

Oxidizing microbiocides are often found at the forefront of many cooling water treatment programs. In large volume or once-through cooling systems they are usually the primary biocide and often are the most cost-effective programs available to a plant. When selecting these economical and versatile chemicals, several factors should be considered before a technically sound program is implemented. Environmental and regulatory impact, system pH, process contamination, and equipment capital and maintenance expense all play a role in the decision-making process.

The primary killing mechanism these types of microbiocides use is oxidizing protein groups within a microorganism. Proteins are the basic components of essential cellular enzymes that are necessary for life-sustaining cellular processes such as respiration. The destruction of these proteins deprives the cell of its ability to carry out fundamental life functions and quickly kills it. One oxidant is chlorine dioxide, which appears to provide an additional killing mechanism. Chlorine dioxide is able to diffuse readily through hydrophobic lipid layers of an organism, allowing it to react with cellular amino acids, which directly inhibits protein synthesis. Since amino acids are the basic building blocks of all cellular proteins, destruction of these molecules has a devastating effect on the microorganism.



Staff shall be familiar with the locations of the chemical feed building as indicated by a posted site plan. Self-contained breathing apparatus (SCBA) and personal protective equipment should be facing the chemical feed building. Emergency repair kits “B” and “C” should be stored on site close to the chemical feed building.



Chlorine scrubber

## **The Benefits of Chlorine**

### **Potent Germicide**

Chlorine disinfectants can reduce the level of many disease-causing microorganisms in drinking water to almost immeasurable levels. Chlorine is added to drinking water to destroy pathogenic (disease-causing) organisms. It can be applied in several forms: elemental chlorine (chlorine gas), sodium hypochlorite solution (bleach) and dry calcium hypochlorite.

When applied to water, each of these forms “free chlorine”. One pound of elemental chlorine provides approximately as much free available chlorine as one gallon of sodium hypochlorite (12.5% solution) or approximately 1.5 pounds of calcium hypochlorite (65% strength).

While any of these forms of chlorine can effectively disinfect drinking water, each has distinct advantages and limitations for particular applications. Almost all water systems that disinfect their water use some type of chlorine-based process, either alone or in combination with other disinfectants.

### **Taste and Odor Control**

Chlorine disinfectants reduce many disagreeable tastes and odors. Chlorine oxidizes many naturally occurring substances such as foul-smelling algae secretions, sulfides and odors from decaying vegetation.

### **Biological Growth Control**

Chlorine disinfectants eliminate slime bacteria, molds and algae that commonly grow in water supply reservoirs, on the walls of water mains and in storage tanks.

### **Chemical Control**

Chlorine disinfectants destroy hydrogen sulfide (which has a rotten egg odor) and remove ammonia and other nitrogenous compounds that have unpleasant tastes and hinder disinfection. They also help to remove iron and manganese from raw water.

### **Water Treatment**

Every day, approximately 170,000 (U.S. EPA, 2002) public water systems treat and convey billions of gallons of water through approximately 880,000 miles (Kirmeyer, 1994) of distribution system piping to U.S. homes, farms and businesses. Broadly speaking, water is treated to render it suitable for human use and consumption.

While the primary goal is to produce a biologically (disinfected) and chemically safe product, other objectives also must be met, including: no objectionable taste or odor; low levels of color and turbidity (cloudiness); and chemical stability (non-corrosive and non-scaling). Individual facilities customize treatment to address the particular natural and manmade contamination characteristic of their raw water.

Surface water usually presents a greater treatment challenge than groundwater, which is naturally filtered as it percolates through sediments. Surface water is laden with organic and mineral particulate matter, and may harbor protozoan parasites such as *Cryptosporidium parvum* and *Giardia lamblia*.

## **Water Distribution**

In storage and distribution, drinking water must be kept safe from microbial contamination. Frequently, slippery films of bacteria, known as biofilms, develop on the inside walls of pipes and storage containers. Among disinfection techniques, chlorination is unique in that a pre-determined chlorine concentration may be designed to remain in treated water as a measure of protection against harmful microbes encountered after leaving the treatment facility. In the event of a significant intrusion of pathogens resulting, for example, from a broken water main, the level of the average "chlorine residual" will be insufficient to disinfect contaminated water. In such cases, it is the monitoring of the sudden drop in the chlorine residual that provides the critical indication to water system operators that there is a source of contamination in the system.

## **The Challenge of Disinfection Byproducts**

While protecting against microbial contamination is the top priority, water systems must also control disinfection byproducts (DBPs), chemical compounds formed unintentionally when chlorine and other disinfectants react with natural organic matter in water. In the early 1970s, EPA scientists first determined that drinking water chlorination could form a group of byproducts known as trihalomethanes (THMs), including chloroform.

EPA set the first regulatory limits for THMs in 1979. While the available evidence does not prove that DBPs in drinking water cause adverse health effects in humans, high levels of these chemicals are certainly undesirable. Cost-effective methods to reduce DBP formation are available and should be adopted where possible.

## **Chemical Safety (IPCS 2000) Strongly Cautions:**

The health risks from these byproducts at the levels at which they occur in drinking water are extremely small in comparison with the risks associated with inadequate disinfection. Thus, it is important that disinfection not be compromised in attempting to control such byproducts. Recent EPA regulations have further limited THMs and other DBPs in drinking water. Most water systems are meeting these new standards by controlling the amount of natural organic material prior to disinfection.

## **Chlorine and Water System Security**

The prospect of a terrorist attack has forced all water systems, large and small, to re-evaluate and upgrade existing security measures. Since September 11th, 2001, water system managers have taken unprecedented steps to protect against possible attacks such as chemical or biological contamination of the water supply, disruption of water treatment or distribution, and intentional release of treatment chemicals.

With passage of the Public Health Security and Bioterrorism Response Act of 2002, Congress required community water systems to assess their vulnerability to a terrorist attack and other intentional acts. As part of these vulnerability assessments, systems assess the transportation, storage and use of treatment chemicals.

These chemicals are both critical assets (necessary for delivering safe water) and potential vulnerabilities (may pose significant hazards, if released). Water systems using elemental chlorine, in particular, must determine whether existing protection systems are adequate. If not, they must consider additional measures to reduce the likelihood of an attack or to mitigate the potential consequences.



Disinfection is crucial to water system security, providing the “front line” of defense against biological contamination. However, conventional treatment barriers in no way guarantee safety from biological attacks. Additional research and funding are needed to improve prevention, detection and responses to potential threats.

### **The Future of Chlorine Disinfection**

Despite a range of new challenges, drinking water chlorination will remain a cornerstone of waterborne disease prevention. Chlorine’s wide array of benefits cannot be provided by any other single disinfectant. While alternative disinfectants (including chlorine dioxide, ozone, and ultraviolet radiation) are available, all disinfection methods have unique benefits, limitations, and costs. Water system managers must consider these factors, and design a disinfection approach to match each system’s characteristics and source water quality.

### **Understanding Disinfection Byproducts (DBPS)**

Chlorine and other chemical disinfectants have been widely used by public water systems (along with filtration) to protect the public from microbial pathogens in drinking water. DBPs are formed when certain disinfectants react with DBP precursors (organic and inorganic materials) in source waters. In most cases, natural organic matter (NOM) is an important factor that affects the levels of DBPs that form (NOM is usually measured as TOC). The levels of DBPs in drinking water can vary significantly from one point in a distribution system to another, as many continue to form in the distribution system. DBP levels are generally higher in surface water systems because surface water usually contains higher DBP precursor levels and requires stronger disinfection.

### **Updating the Safe Drinking Water Act Regulations**

EPA has regulated DBPs in drinking water since 1979. The first DBP standards limited THM levels to 100 parts per billion (ppb) for systems serving more the 10,000 people. In the 1996 Safe Drinking Water Act (SDWA) reauthorization, Congress called for EPA to revise its standards for disinfectants and DBPs in two stages. The revised regulations are designed to reduce potential DBP risks, while ensuring that drinking water is protected from microbial contamination.

#### **Stage 1 DBP Rule**

In December 1998 USEPA issued the Stage 1 Disinfectants and Disinfection Byproducts (Stage 1 DBP) rule. The regulations are based on an agreement between members of a Federal Advisory Committee that included representatives from water utilities, the Chlorine Chemistry Division of the American Chemistry Council, public health officials, environmentalists and other stakeholder groups. This diverse group of experts developed a consensus set of recommendations to cost-effectively reduce DBP levels, without compromising protection from microbial contaminants.

The Stage 1 DBP rule mandates a process called enhanced coagulation to remove natural organic matter, reducing the potential for DBPs to form. The rule also sets enforceable Maximum Contaminant Levels (MCLs) for total trihalomethanes at 80 ppb and the sum of five Haloacetic Acids (HAAs) at 60 ppb. These MCLs are based on system-wide running annual averages, meaning that concentrations may be higher at certain times and at certain points in the system, as long as the system-wide average for the year is below the MCL. In developing the Stage 1 DBP rule, EPA was very cautious about encouraging the use of alternative disinfectants.

The Agency recognized that alternative disinfectants might reduce THMs and HAAs, but produce other, less understood, byproducts. The Agency also avoided making recommendations that would encourage utilities to reduce the level of disinfection currently being practiced.

Large water systems (those serving more than 10,000 persons) were required to comply with the Stage 1 DBP rule by December 2001. Systems serving fewer than 10,000 persons must comply by December 2003.

### **Stage 2 DBP Rule**

As the Stage 1 rule is coming into full force, EPA is completing work on its Stage 2 DBP rule. The Stage 2 rule is being developed simultaneously with the Long Term 2 Enhanced Surface Water Treatment Rule (LT2) in order to address the risk trade-offs between pathogen control and exposure to DBPs. The LT2 rule deals primarily with controlling *Cryptosporidium* and other resistant pathogens discussed in Chapter 3. Again, the EPA sought recommendations from an advisory group, the Stage 2 Microbial and Disinfection Byproducts Federal Advisory Committee.

As outlined in the advisory committee's September 2000 Agreement in Principle, the MCLs for THMs and five HAAs will remain 80 ppb and 60 ppb respectively, based on each utility's system-wide running annual averages. However, the Stage 2 rule will also limit DPB levels at specific locations within distribution systems. When fully implemented, these locational running annual average limits will mean that no part of the distribution system will be allowed to exceed the MCLs for these substances.

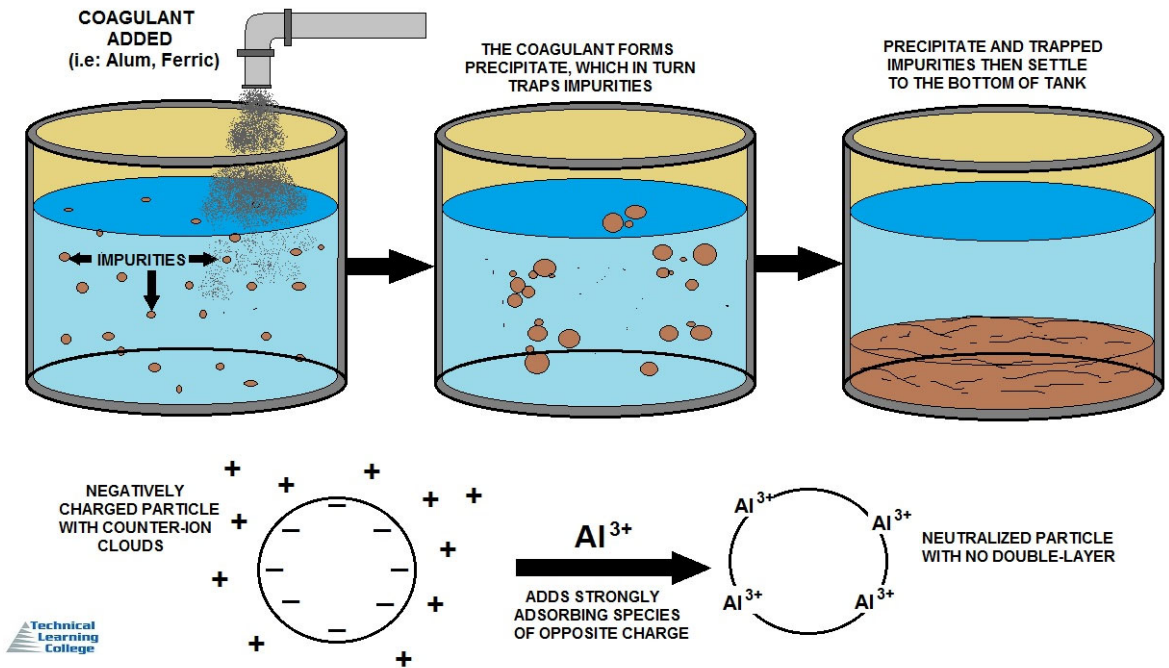
### **Total Trihalomethanes**

Trihalomethanes (THMs) are chemical compounds in which three of the four hydrogen atoms of methane (CH<sub>4</sub>) are replaced by halogen atoms. Many trihalomethanes find uses in industry as solvents or refrigerants. THMs are also environmental pollutants, and many are considered carcinogenic.

Trihalomethanes with all the same halogen atoms are called haloforms. Trihalomethanes are formed as a by-product predominantly when chlorine is used to disinfect water for drinking. They represent one group of chemicals generally referred to as disinfection by-products. They result from the reaction of chlorine and/or bromine with organic matter present in the water being treated.

The THMs produced have been associated through epidemiological studies with some adverse health effects. Many governments set limits on the amount permissible in drinking water. However, trihalomethanes are only one group of many hundreds of possible disinfection by-products—the vast majority of which are not monitored—and it has not yet been clearly demonstrated which of these are the most plausible candidate for causation of these health effects.

In the United States, the EPA limits the total concentration of the four chief constituents (chloroform, bromoform, bromodichloromethane, and dibromochloromethane), referred to as total trihalomethanes (TTHM), to 80 parts per billion in treated water.



### THE AIM OF COAGULATION

### THM Treatment

THM levels tend to increase with pH, temperature, time, and the level of "precursors" present.

Precursors are organic material which reacts with chlorine to form THM's. One way to decrease THM's is to eliminate or reduce chlorination before the filters and to reduce precursors. There are more precursors present before filtration, so we want to reduce or eliminate the time chlorine is in contact with this water.

If some oxidation before filtration is required, an alternative disinfectant like potassium permanganate or peroxide could be considered. Note that this may not be an option if prechlorination is necessary to achieve required CT values.

The EPA has indicated that the best available technology for THM control at treatment plants is removal of precursors through "enhanced coagulation".

Enhanced coagulation refers to the process of optimizing the filtration process to maximize removal of precursors. Removal is improved by decreasing pH (to levels as low as 4 or 5), increasing the feed rate of coagulants, and possibly using ferric coagulants instead of alum.



## Measuring Chlorine Residual Sub-Section

### Amperometric Titration

Amperometric titrations have been successfully used for accurate determination of residual chlorine in water at many plants to maintain regulatory compliance. Different species of chlorine have also been determined, with suitable modification of the method, as free available chlorine, chloramine, chlorine dioxide, and chlorite.

Various dual polarizable electrodes have been used for the amperometric titration of low concentrations of residual chlorine in water. In particular, amperometric (Iodometric) titrations with dual platinum electrodes have gained considerable interest in the determination of total residual chlorine in water.

Selective iodometric titrations with dual polarizable electrodes have also been found to be useful for the speciation of chlorine in water, providing the ability to distinguish between free and combined residual chlorine, and between monochloramine and dichloramine in water.

In the amperometric determination of free chlorine, chlorine is titrated with a standard reducing agent such as thiosulfate or phenyl arsine oxide (PAO) at pH 7. As long as the oxidant (free chlorine) is present in the titrated sample, a current flows through the cell.

The standard amperometric sensor design consists of two electrodes (anode and cathode) that measure a change in current caused by the chemical reduction of hypochlorous acid at the cathode. The current that flows because of this reduction is proportional to the chlorine concentration. A membrane and electrolyte help to control the reaction. Flow rate and pressure must be carefully controlled for accurate measurement.

The effect of pH on the disassociation of hypochlorous acid to the hypochlorite ion is quite significant. A standard sensor design is suitable for a constant pH in the range of 6.8-8.0. Calibration of the system enables compensation for the pH of the sample.

### Varying pH

For applications with varying pH, or pH values beyond this range, an extended pH range sensor is available using a 4.0 pH electrolyte in the membrane cap. This enables conversion of the hypochlorite ion to hypochlorous acid, enabling accurate chlorine readings in solutions between pH 4.0-12.0.

### Time for Measurement

The amount of time to achieve an accurate reading is only 30 seconds for a standard sensor, two minutes for an extended pH range sensor. Flow to the sensor must be consistently controlled in the range of 8-26.4 gal/hr; with a maximum pressure of 1 atm (discharge of sensor must be to atmospheric pressure). Each sensor typically has a required flow cell configuration to enable accurate measurements. During initial start-up, the sensor must be conditioned in the flow stream for 12-24 hours before attempting any calibration.



## Using DPD Method for Chlorine Residuals N, N – diethyl-p-phenylenediamine



Small portable chlorine measuring kit. The redder the mixture the “hotter” or stronger the chlorine in solution.

### Measuring Chlorine Residual

Chlorine residual is the amount of chlorine remaining in water that can be used for disinfection. A convenient, simple and inexpensive way to measure chlorine residual is to use a small portable kit with pre-measured packets of chemicals that are added to water. (Make sure you buy a test kit using the *DPD method*, and not the outdated orthotolodine method.)

Chlorine test kits are very useful in adjusting the chlorine dose you apply. You can measure what chlorine levels are being found in your system (especially at the far ends).

Free chlorine residuals need to be checked and recorded daily. These results should be kept on file for a health or regulatory agency inspection during a regular field visit.

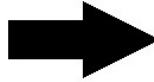
The most accurate method for determining chlorine residuals is to use the laboratory amperometric titration method.

## Additional Drinking Water Methods (Non-EPA) for Chemical Parameters

Method	Method Focus	Title	Location	Source
4500-Cl <sup>-</sup> B	Chloride by Silver Nitrate Titration	Standard Methods for the Examination of Water and Wastewater, 18th & 19th Ed.	Included in Standard Methods	American Water Works Assn. <b>(AWWA)</b>
4500-Cl <sup>-</sup> D	Chloride by Potentiometric Method	Standard Methods for the Examination of Water and Wastewater, 18th, 19th & 20th Editions	Included in Standard Methods	American Water Works Assn. <b>(AWWA)</b>
4500-Cl D	Chlorine Residual by Amperometric Titration (Stage 1 DBP use SM 19th Ed. only)	Standard Methods for the Examination of Water and Wastewater, 18th, 19th & 20th Editions	Included in Standard Methods	American Water Works Assn. <b>(AWWA)</b>
4500-Cl E	Chlorine Residual by Low Level Amperometric Titration (Stage 1 DBP use SM 19th Ed. only)	Standard Methods for the Examination of Water and Wastewater, 18th, 19th & 20th Editions	Included in Standard Methods	American Water Works Assn. <b>(AWWA)</b>
4500-Cl F	Chlorine Residual by DPD Ferrous Titration (Stage 1 DBP use SM 19th Ed. only)	Standard Methods for the Examination of Water and Wastewater, 18th, 19th & 20th Editions	Included in Standard Methods	American Water Works Assn. <b>(AWWA)</b>
4500-Cl G	Chlorine Residual by DPD Colorimetric Method (Stage 1 DBP use SM 19th Ed. only)	Standard Methods for the Examination of Water and Wastewater, 18th, 19th & 20th Editions	Included in Standard Methods	American Water Works Assn. <b>(AWWA)</b>
4500-Cl H	Chlorine Residual by Syringaldazine (FACTS) Method (Stage 1 DBP use SM 19th Ed. only)	Standard Methods for the Examination of Water and Wastewater, 18th, 19th & 20th Editions	Included in Standard Methods	American Water Works Assn. <b>(AWWA)</b>
4500-Cl I	Chlorine Residual by Iodometric Electrode Technique (Stage 1 DBP use SM 19th Ed. only)	Standard Methods for the Examination of Water and Wastewater, 18th, 19th & 20th Editions	Included in Standard Methods	American Water Works Assn. <b>(AWWA)</b>
4500-ClO <sub>2</sub> C	Chlorine Dioxide by the Amperometric Method I	Standard Methods for the Examination of Water and Wastewater, 18th, 19th & 20th Editions	Included in Standard Methods	American Water Works Assn. <b>(AWWA)</b>
4500-ClO <sub>2</sub> D	Chlorine Dioxide by the DPD Method (Stage 1 DBP use SM 19th Ed. only)	Standard Methods for the Examination of Water and Wastewater, 18th, 19th & 20th Editions	Included in Standard Methods	American Water Works Assn. <b>(AWWA)</b>
4500-ClO <sub>2</sub> E	Chlorine Dioxide by the Amperometric Method II (Stage 1 DBP use SM 19th Ed. only)	Standard Methods for the Examination of Water and Wastewater, 18th, 19th & 20th Editions	Included in Standard Methods	American Water Works Assn. <b>(AWWA)</b>

## 1. Do The Basics

- TEST WATER CHEMISTRY
- CHECK WATER FLOW RATE
- ESTIMATE CHLORINE DEMAND
- DETERMINE CONTACT TANK SIZE
- NOTE THE LINE PRESSURE WHERE CHLORINE WILL BE INJECTED INTO



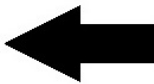
## 2. Choose A Chlorinator

- LIQUID CHLORINATOR OR DRY FEED
- WHERE TO INSTALL CHLORINATOR BEFORE / AFTER PRESSURE TANK
- PERISTALTIC METERING PUMP OR DIAPHRAGM PUMP



## 3. Installation

- BUY DIRECTLY AND INSTALL  
OR
- BUY DIRECTLY AND HIRE PLUMBER  
OR
- BUY FROM WATER TREATMENT DEALER



## 4. Quality Control

- SET-UP MAINTENANCE SCHEDULE
- CLIPBOARD WITH CHECKLIST
- TEST THE WATER ANNUALLY

# HOW TO DETERMINE A CHLORINATION SYSTEM



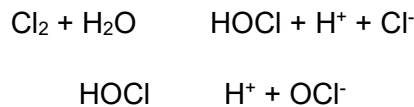
## Chlorine Residual Sub-Section

**Chlorine Demand:** The minimum amount of chlorine needed to react in a water purification system; used as a monitoring measurement by system operators.

**Chlorine Residual:** The concentration of chlorine in the water after the chlorine demand has been satisfied. The concentration is normally expressed in terms of total chlorine residual, which includes both the free and combined or chemically bound chlorine residuals.

**Combined Chlorine Residual:** The amount of chlorine used up in a water purification system; used as a monitoring measurement by system operators. Combined chlorine is defined as the residual chlorine existing in water in chemical combination with ammonia or organic amines which can be found in natural or polluted waters. Ammonia is sometimes deliberately added to chlorinated public water supplies to provide inorganic chloramines.

**Free Chlorine:** Free chlorine is defined as the concentration of residual chlorine in water present as dissolved gas ( $\text{Cl}_2$ ), hypochlorous acid ( $\text{HOCl}$ ), and/or hypochlorite ion ( $\text{OCl}^-$ ). The three forms of free chlorine exist together in equilibrium.



Their relative proportions are determined by the pH value and temperature. Regardless of whether pre-chlorination is practiced or not, a free chlorine residual of at least 1.0 mg/L should be maintained in the clear well or distribution reservoir immediately downstream from the point of post-chlorination and .2 mg/L in the distribution system to guard against backflow.

**Total Chlorine Residual:** The total of free residual and combined residual chlorine in a water purification system; used as a monitoring measurement by system operators.

Total chlorine is the sum of free and combined chlorine. When chlorinating most potable water supplies, total chlorine is essentially equal to free chlorine since the concentration of ammonia or organic nitrogen compounds (needed to form combined chlorine) will be very low. When chloramines are present in the municipal water supply, then total chlorine will be higher than free chlorine.

## Common Terms

**Pre-chlorination:** The addition of chlorine at the plant headworks or prior to other water treatment or groundwater production processes and mainly used for disinfection and control of tastes, odors, and aquatic growths.

**Post-chlorination:** The addition of chlorine after a process or adding chlorine downstream to meet a demand in the system.

**Breakpoint chlorination:** Breakpoint chlorination means adding  $\text{Cl}_2$  to the water until the  $\text{Cl}_2$  demand is satisfied. Until all the microorganisms are killed.

**What is the process of chlorination called as a treatment process and how does it differ from sterilization?**

**Chlorination:** A method of water disinfection where gaseous, liquid, or dissolved chlorine is added to a water supply system. Water which has been treated with chlorine is effective in preventing the spread of disease. The chlorination of public drinking supplies was originally met with resistance, as people were concerned about the health effects of the practice. The use of chlorine has greatly reduced the prevalence of waterborne disease as it is effective against almost all bacteria and viruses, as well as amoeba. Sterilization kills everything.

**What are the physical properties of chlorine, what hazards does it present, what advantages does it have over most other disinfectants, and how does it react with bacteria?**

Physical and chemical properties of chlorine: A yellowish green, nonflammable and liquefied gas with an unpleasant and irritating smell. Can be readily compressed into a clear, amber-colored liquid, a noncombustible gas, and a strong oxidizer. Liquid chlorine is about 1.5 times heavier than water and gaseous chlorine is about 2.5 times heavier than air. Atomic number of chlorine is 17. Cl is the elemental symbol and Cl<sub>2</sub> is the chemical formula.

Chlorine reacts with bacteria as if it was very corrosive and burns the skin or covering killing the bacteria.

**What is the purpose of a fusible plug, at what temperature does it melt, and where is it located on 150-lb. and 1-ton cylinders?**

Fusible plug is a safety device that melts. If the temperature of a full Cl<sub>2</sub> cylinder is increased by 50° F or 30° C, a rupture may occur. It will melt at 158 to 165 degrees F. It is found on the side of a 1-ton container and on top of the 150-pound cylinder and is located in the valve below the valve seat.

**What is the correct procedure to follow in changing a chlorine cylinder and what item should always be replaced with a new one in doing so?**

Hook up the chlorinator to the container or cylinder with the chlorine valve turned off. Use the gas side not the liquid if using a 1-ton container.

Remove the cylinder valve outlet cap and check the valve face for damage. Clean with wire brush if necessary. If the valve face is smooth, clean proceed with hooking up the cylinder.

Check the inlet face of the chlorinator and clean if necessary. Place a new lead gasket on the chlorinator inlet, place the chlorinator on the cylinder valve, install the yoke clamp and slowly tighten the yoke clamp until the two faces are against the lead gasket. Tighten the yoke, compressing the gasket one half to three quarters turn, do not over tighten. Replace the lead gasket with every change out.

**How, when and where should chlorine residuals be taken and what information do they provide?** The sample must be taken within the distribution system of your PWS. If you take it before the distribution system you will not get an accurate reading. The sample must be taken at the same tap that you take the Bac-t sample.

## Types of Residual

If water were pure, the measured amount of chlorine in the water should be the same as the amount added. Nevertheless, water is not 100% pure. There are always other substances (interfering agents) such as iron, manganese, turbidity, etc., which will combine chemically with the chlorine.



$$\text{CHLORINE IN USE} + \text{FREE CHLORINE} = \text{TOTAL CHLORINE}$$

This is called the **chlorine demand**. Naturally, once chlorine molecules are combined with these interfering agents, they are not capable of disinfection. It is free chlorine that is much more effective as a disinfecting agent.

### Chlorine Demand

The minimum amount of chlorine needed to react in a water purification system; used as a monitoring measurement by system operators.

### Chlorine Residual

The concentration of chlorine in the water after the chlorine demand has been satisfied. The concentration is normally expressed in terms of total chlorine residual, which includes both the free and combined or chemically bound chlorine residuals.

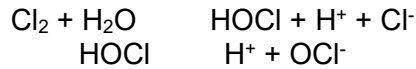
### Combined Chlorine Residual

The amount of chlorine used up in a water purification system; used as a monitoring measurement by system operators. Combined chlorine is defined as the residual chlorine existing in water in chemical combination with ammonia or organic amines that can be found in natural or polluted waters.

Ammonia is sometimes deliberately added to chlorinated public water supplies to provide inorganic chloramines.

### Free Chlorine

Free chlorine is defined as the concentration of residual chlorine in water present as dissolved gas (Cl<sub>2</sub>), hypochlorous acid (HOCl), and/or hypochlorite ion (OCl<sup>-</sup>). The three forms of free chlorine exist together in equilibrium.



Their relative proportions are determined by the pH value and temperature. Regardless of whether pre-chlorination is practiced or not, a free chlorine residual of at least 1.0 mg/L should be maintained in the clear well or distribution reservoir immediately downstream from the point of post-chlorination and .2 mg/L in the distribution system to guard against backflow.

### Total Chlorine Residual

The total of free residual and combined residual chlorine in a water purification system; used as a monitoring measurement by system operators.

Total chlorine is the sum of free and combined chlorine. When chlorinating most potable water supplies, total chlorine is essentially equal to free chlorine since the concentration of ammonia or organic nitrogen compounds (needed to form combined chlorine) will be very low.

When chloramines are present in the municipal water supply, then total chlorine will be higher than free chlorine.

### Free, Total, and Combined Chlorine

When a chlorine residual test is taken, either a total or a free chlorine residual can be read.

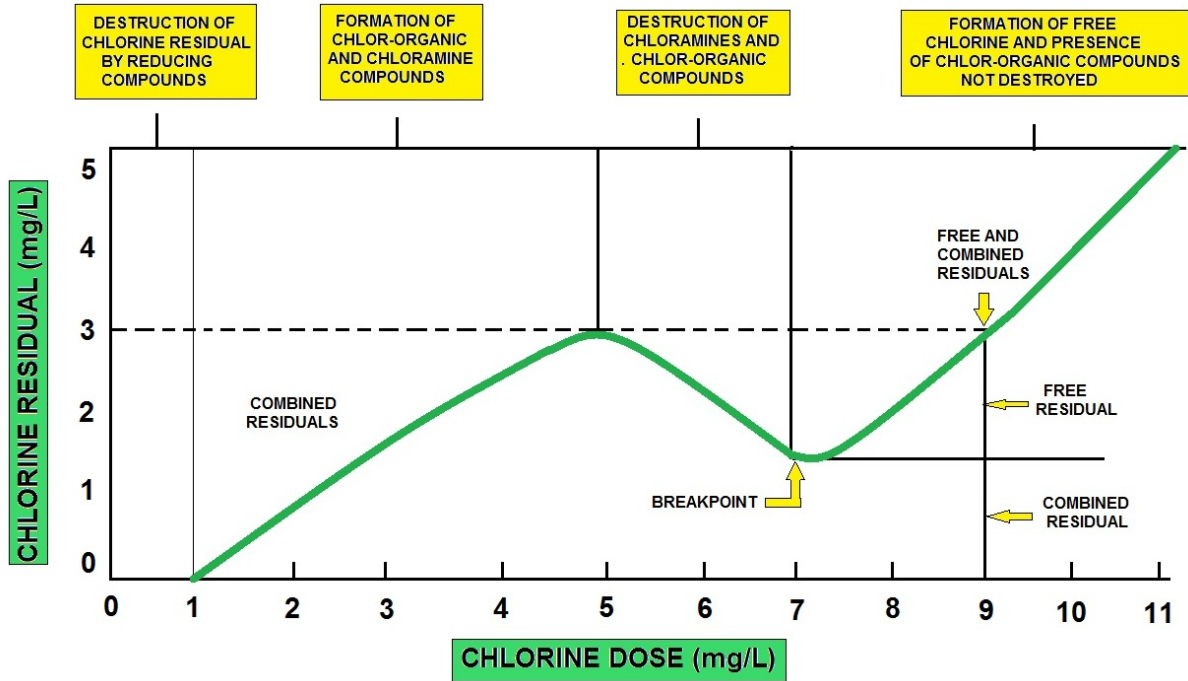
**Total residual is all chlorine that is available for disinfection.**

**Total chlorine residual = free + combined chlorine residual.**

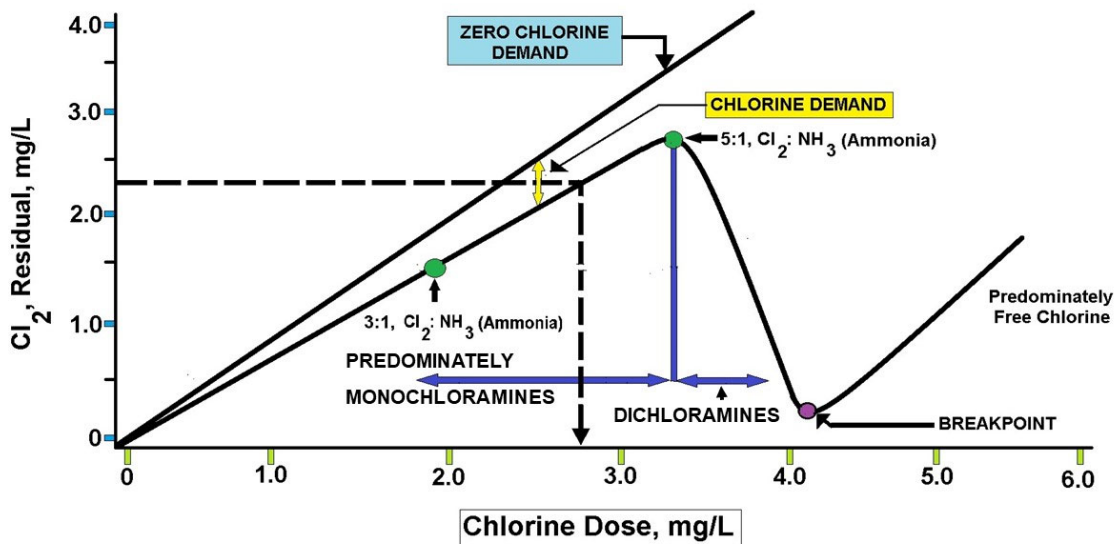
Free chlorine residual is a much stronger disinfecting agent. Therefore, most water regulating agencies will require that your daily chlorine residual readings be of free chlorine residual.

**Break-point chlorination** is where the chlorine demand has been satisfied, and any additional chlorine will be considered **free chlorine**.

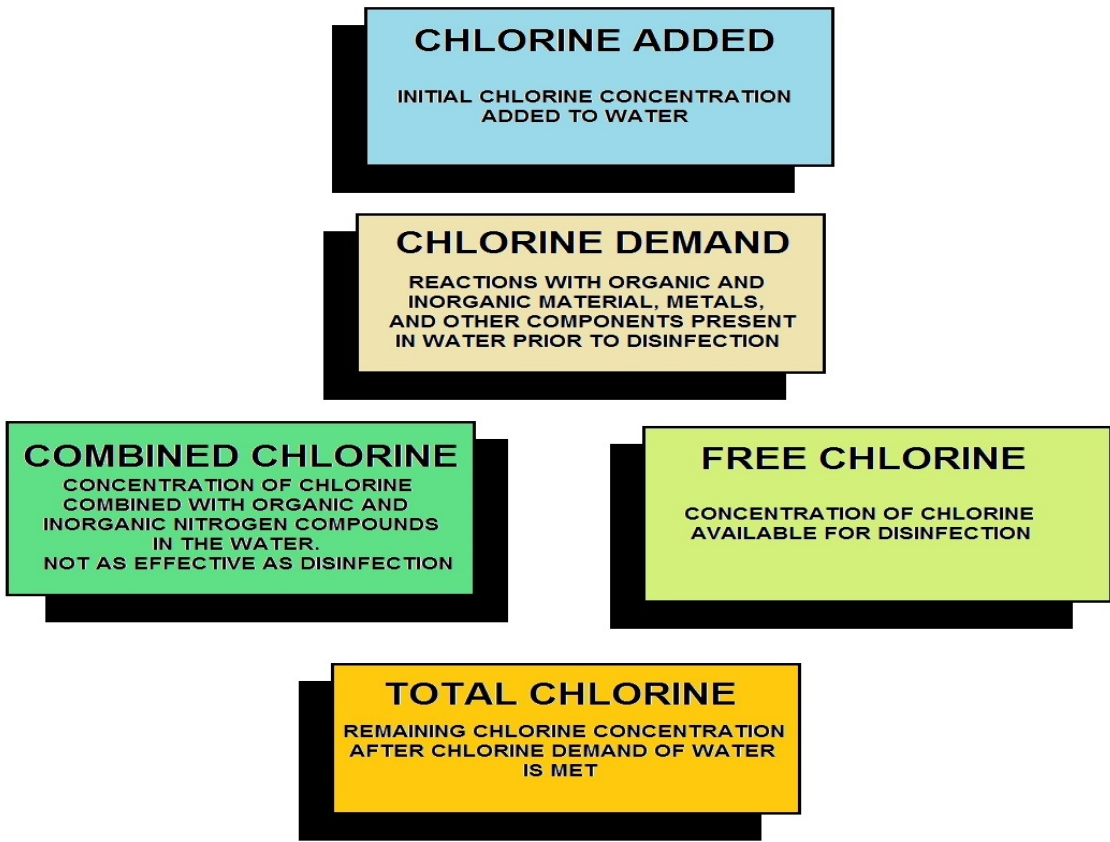
# Chlorine Diagrams #3



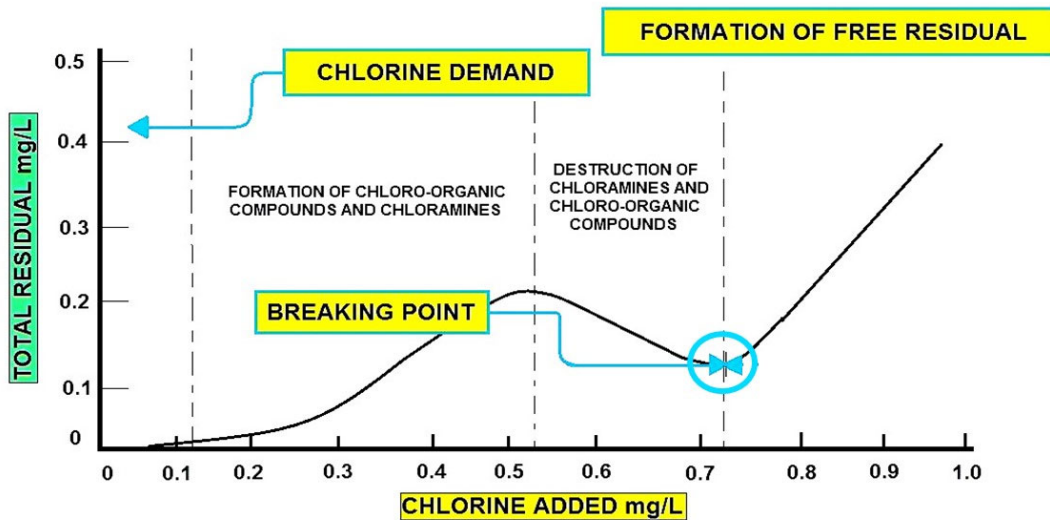
**CHLORINE BREAKPOINT CHART #1**



**CHLORAMINATION DOSING CURVE**



### CHLORINE RESIDUAL ORDER CHART



## REACTION OF CHLORINE IN WATER

Disinfection to eliminate fecal and coliform bacteria may not be sufficient to adequately reduce pathogens such as Giardia or viruses to desired levels. Use of the "CT" disinfection concept is recommended to demonstrate satisfactory treatment, since monitoring for very low levels of pathogens in treated water is analytically very difficult.

The CT concept, as developed by the United States Environmental Protection Agency (Federal Register, 40 CFR, Parts 141 and 142, June 29, 1989), uses the combination of disinfectant residual concentration (mg/L) and the effective disinfection contact time (in minutes) to measure effective pathogen reduction. The residual is measured at the end of the process, and the contact time used is the T10 of the process unit (time for 10% of the water to pass).

$$CT \text{ (Contact time)} = \text{Concentration (mg/L)} \times \text{Time (Minutes)}$$

**Required Giardia/Virus Reduction**

All surface water treatment systems shall ensure a minimum reduction in pathogen levels: 3-log reduction in Giardia and 4-log reduction in viruses. These requirements are based on unpolluted raw water sources with Giardia levels of = 1 cyst/100 L, and a finished water goal of 1 cyst/100,000 L (equivalent to 1 in 10,000 risk of infection per person per year). Higher raw water contamination levels may require greater removals as shown on Table 4.1.

BACTERIA / VIRUS	DISINFECTION TIME FOR FECAL CONTAMINANTS IN CHLORINATED WATER
E. COLI (BACTERIUM)	LESS THAN 1 MINUTE OF CONTACT TIME
HEPATITUS A (VIRUS)	APPROXIMATELY 16 MINUTES CONTACT TIME
GIARDIA (PARASITE)	APPROXIMATELY 45 MINUTES CONTACT TIME
CRYPTOSPORIDIUM (PARASITE)	APPROXIMATELY 10.6 DAYS (15,300 minutes)

**CHLORINE TIMETABLE FOR PROPER DISINFECTION**

**TABLE 4.1  
LEVEL OF GIARDIA REDUCTION  
Raw Water Giardia Levels\*  
Recommended Giardia Log  
Reduction**

- < 1 cyst/100 L 3-log
- 1 cyst/100 L - 10 cysts/100 L 3-log - 4-log
- 10 cysts/100 L - 100 cysts/100 L 4-log - 5-log
- > 100 cysts/100 L > 5-log

\*Use geometric means of data to determine raw water Giardia levels for compliance.

### Required CT Value

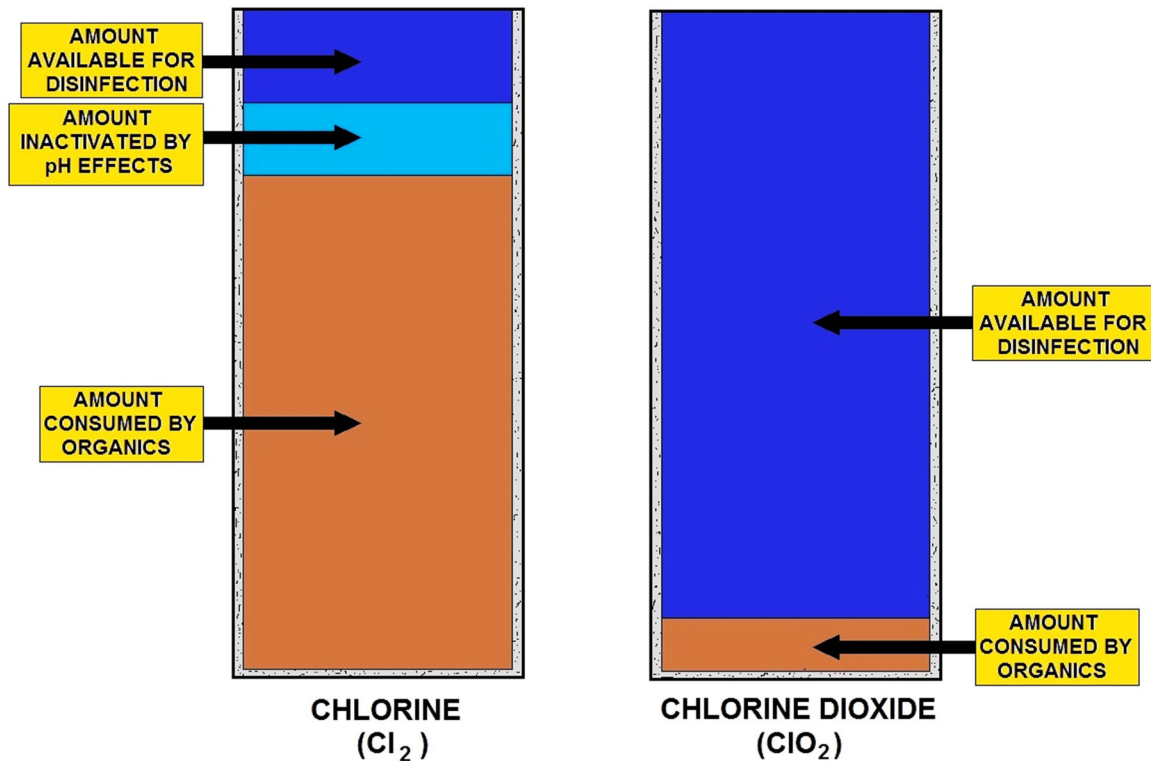
Required CT values are dependent on pH, residual concentration, temperature, and the disinfectant used.

### Calculation and Reporting of CT Data

Disinfection CT values shall be calculated daily, using either the maximum hourly flow and the disinfectant residual at the same time, or by using the lowest CT value if it is calculated more frequently. Actual CT values are then compared to required CT values.

Results shall be reported as a reduction Ratio, along with the appropriate pH, temperature, and disinfectant residual. The reduction Ratio must be greater than 1.0 to be acceptable. Users may also calculate and record actual log reductions.

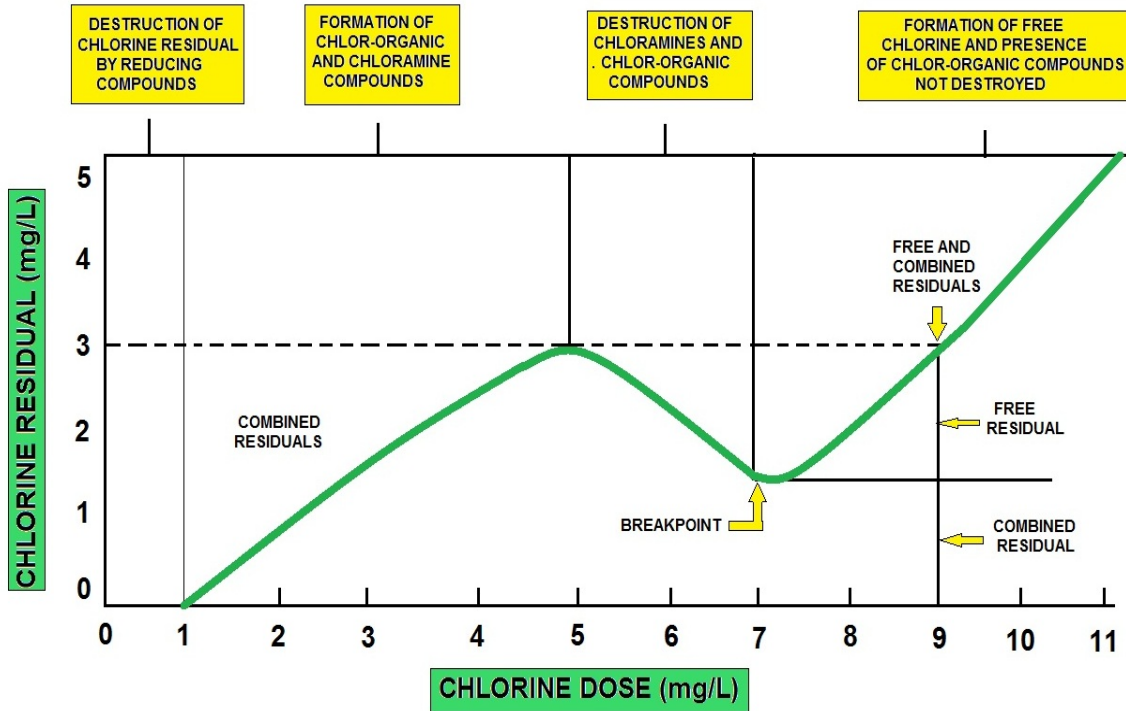
$$\text{Reduction Ratio} = \text{CT actual} \div \text{CT required}$$



### DIFFERENCE IN USING CHLORINE VS CHLORINE DIOXIDE AS DISINFECTANT



## Understanding Chlorine Residual



### CHLORINE BREAKPOINT DIAGRAM #1

The amount of available chlorine present in water or wastewater after a given contact time (20 minutes at peak flow; 30 minutes at average flow), and under specific conditions including pH and temperature.

For effective water treatment, the water supply industry has recognized the need for adequate exposure to the disinfectant and sufficient disinfectant dosage for a certain amount of time. In the 1980s, the two functions were combined with the development of the CT values for various disinfectants.

CT represents the combination of the disinfectant dosage and the length of time water has been exposed to a minimum amount of the disinfectant residual.

Mathematically it is represented as  $CT = \text{concentration} \times \text{time}$   
 concentration = final disinfectant concentration in mg/l  
 time = minimum exposure time in minutes

In an assessment of disinfection effectiveness, two types of organisms have been chosen as disinfection surrogates – the protozoan *Giardia* and viruses.

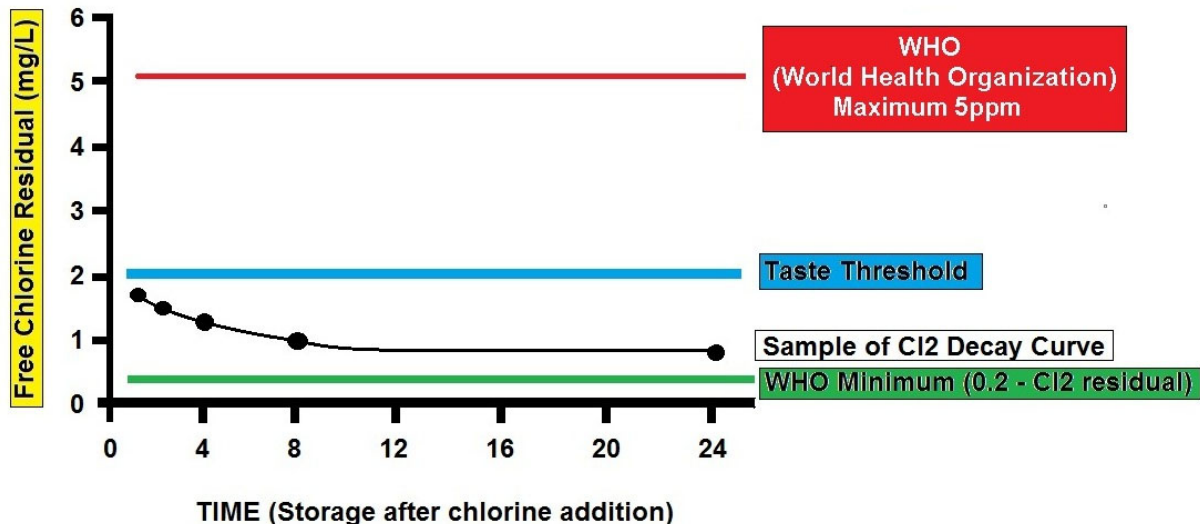
CT values established for disinfection of surface waters require treatment plants to achieve a three-log or 99.9% reduction in *Giardia* and a four-log or 99.99% virus reduction. It is important to recognize that the use of chlorine as the disinfectant is only one part of the treatment process. Equally important is the need for improved filtration to remove organisms.

A combination of proper disinfection and filtration is most effective in providing safe drinking water. Recent experiments in controlling *Cryptosporidium* also suggest the effectiveness of filtration in the water treatment process.

Free residual chlorination involves the application of chlorine to water to produce--either directly or by first destroying any naturally present ammonia--a free available chlorine residual and to maintain this residual through part or all of the water treatment plant and distribution system. Free available residual forms have higher oxidation potentials than combined available chlorine forms and are more effective as disinfectants.

**When free available chlorine residuals are desired, the characteristics of the water will determine how this will be accomplished. This may have to be considered:**

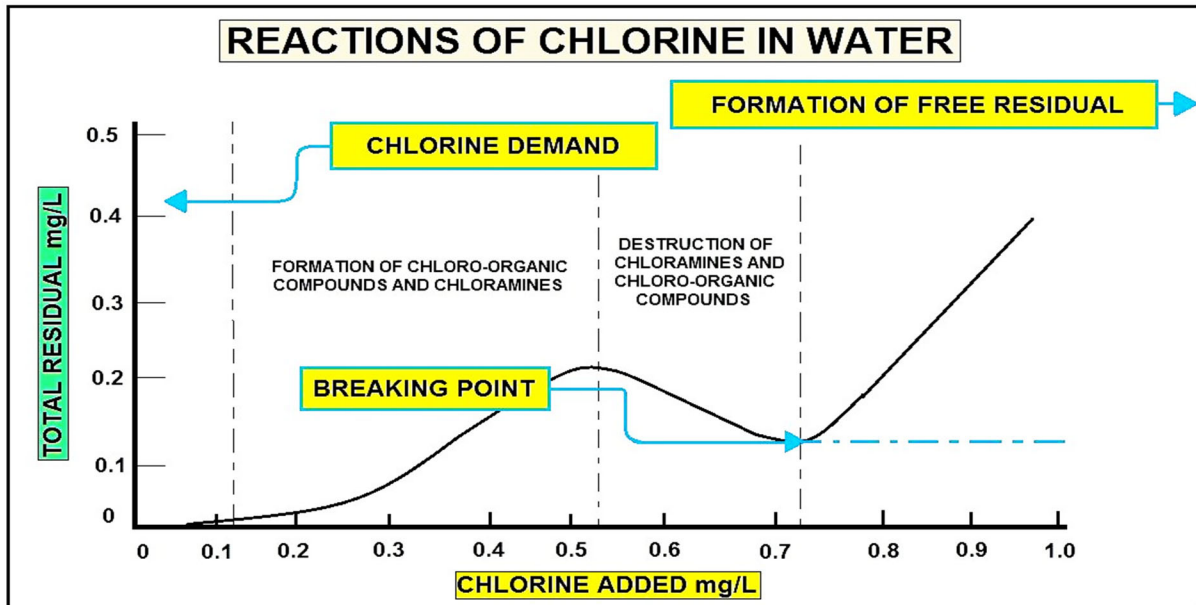
1. If the water contains no ammonia or other nitrogen compounds, any application of chlorine will yield a free residual once it has reacted with any bacteria, virus and other microorganisms present in the water.
2. If the water contains ammonia, it results in the formation of a combined residual, which must be destroyed by applying an excess of chlorine.



**CHLORNE DECAY CURVE DIAGRAM #1**

## Breakpoint Chlorination

Breakpoint chlorination is the name of the process of adding chlorine to water until the chlorine demand has been satisfied. Chlorine demand equals the amount of chlorine used up before a free available chlorine residual is produced. Further additions of chlorine will result in a chlorine residual that is directly proportional to the amount of chlorine added beyond the breakpoint. Public water supplies normally chlorinate past the breakpoint.



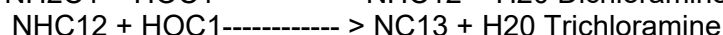
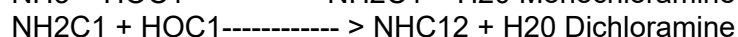
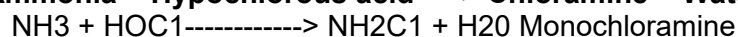
**When chlorine is initially added to water, the following may happen:**

1. If the water contains some iron, manganese, organic matter, and ammonia, the chlorine reacts with these materials and no residual is formed, meaning that no disinfection has taken place.
2. If additional chlorine is added at this point, it will react with the organics and ammonia to form chloramines. The chloramines produce a combined chlorine residual. As the chlorine is combined with other substances, it loses some of the disinfection strength. Combined residuals have poor disinfection power and may be the cause of taste and odor problems.
3. With a little more chlorine added, the chloramines and some of the chlororganics are destroyed.
4. With still more chlorine added, a free chlorine residual is formed, free in the sense that it can react quickly.

Free available chlorine is the best residual for disinfection. It disinfects faster and without the swimming-pool odor of combined residual chlorine. The free available residual forms at the breakpoint; therefore, the process is called breakpoint chlorination. The common practice today is to go just beyond the breakpoint to a residual of about .2 to .5 ppm.

A variety of reactions take place during chlorination. When chlorine is added to a water containing ammonia ( $\text{NH}_3$ ), the ammonia reacts with hypochlorous acid ( $\text{HOCl}$ ) to form monochloramine, dichloramine, and trichloramine. The formation of these chloramines depends on the pH of the water and the initial chlorine-ammonia ratio.

### **Ammonia + Hypochlorous acid ----> Chloramine + Water**



At the pH of most natural water (pH 6.5 to 7.5), monochloramine and dichloramine exist together. At pH levels below 5.5, dichloramine exists by itself. Below pH 4.0, trichloramine is the only compound found. The monochloramine and dichloramine forms have a definite disinfection power. Dichloramine is a more effective disinfecting agent than monochloramine. However, dichloramine is not recommended as a disinfectant due to the possibility of the formation of taste and odor compounds. Chlorine reacts with phenol and salicylic acid to form chlorophenol, which has an intense medicinal odor. This reaction is much slower in the presence of monochloramines.

Both the chlorine residual and the contact time are essential for effective disinfection. It is important to have complete mixing. The operator also needs to be aware that changes in the pH may affect the ability of the chlorine to disinfect the water. The operator must examine the application and select the best point of feed and the best contact time to achieve the results desired. The operator needs to consider:

1. Whether the injection point and the method of mixing is designed so that the disinfectant is able to get into contact with all of the water to be disinfected. This also depends on whether pre- and/or post-chlorination is being used.
2. Contact time. In situations of good initial mixing, the longer the contact time, the more effective the disinfection.
3. Effectiveness of upstream treatment processes. The lower the turbidity of the water, the more effective the disinfection.
4. Temperature. At higher temperatures the rate of disinfection is more rapid.
5. Dosage and type of chemical. Usually the higher the dose, the quicker the disinfection rate. The form of disinfectant (chloramine or free chlorine) and the type of chemical used influence the disinfection rate.
6. pH. The lower the pH, the better the disinfection.

### **Chlorine Demand**

Chlorine combines with a wide variety of materials. These side reactions complicate the use of chlorine for disinfecting purposes. Their demand for chlorine must be satisfied before chlorine becomes available to accomplish disinfection. The amount of chlorine required to react on various water impurities before a residual is obtained. In addition, it means the amount of chlorine required to produce a free chlorine residual of 0.1 mg/l after a contact time of fifteen minutes as measured by iodometric method of a sample at a temperature of twenty degrees in conformance with Standard methods.

### **Disinfection Information**

- ▶ Contact time is required
  - ▶ 99% or 2 log inactivation of crypto
  - ▶ 99.9% or 3 log inactivation of giardia lamblia cysts
  - ▶ 99.99% or 4 log inactivation of enteric viruses
- ▶ CT = Concentration of disinfectant x contact time
- ▶ The chlorine residual leaving the plant must be = or > 0.2 mg/L and measurable throughout the system.

### **Understanding Combined Chlorine Residual**

The residual consisting of chlorine that is combined with ammonia, nitrogen, or nitrogenous compounds (chloramines).

### **Understanding Free Available Chlorine**

The residual consisting of hypochlorite ions ( $\text{OCl}^-$ ), hypochlorous acid ( $\text{HOCl}$ ) or a combination of the two. These are the most effective in killing bacteria.

### **Total Combined Chlorine Residual**

The total amount of chlorine present in a sample. This is the sum of the free chlorine residual and the combined available chlorine residual.

### **Understanding Pre-Chlorination**

Chlorination is the application of chlorine to water to accomplish some definite purpose. In this lesson, we will be concerned with the application of chlorine for the purpose of disinfection, but you should be aware that chlorination can also be used for taste and odor control, iron and manganese removal, and to remove some gases such as ammonia and hydrogen sulfide.

Chlorination is currently the most frequently used form of disinfection in the water treatment field. However, other disinfection processes have been developed. These alternatives will be discussed at the end of this lesson.

### **Pre-Chlorination and Post-Chlorination**

Like several other water treatment processes, chlorination can be used as a pretreatment process (prechlorination) or as part of the primary treatment of water (postchlorination). Treatment usually involves either postchlorination only or a combination of prechlorination and postchlorination.

Pre-chlorination is the act of adding chlorine to the raw water. The residual chlorine is useful in several stages of the treatment process - aiding in coagulation, controlling algae problems in basins, reducing odor problems, and controlling mudball formation. In addition, the chlorine has a much longer contact time when added at the beginning of the treatment process, so prechlorination increases safety in disinfecting heavily contaminated water.

Post-chlorination is the application of chlorine after water has been treated but before the water reaches the distribution system. At this stage, chlorination is meant to kill pathogens and to provide a chlorine residual in the distribution system.

Post-chlorination is nearly always part of the treatment process, either used in combination with prechlorination or used as the sole disinfection process.

Until the middle of the 1970s, water treatment plants typically used both prechlorination and post-chlorination. However, the longer contact time provided by prechlorination allows the chlorine to react with the organics in the water and produce carcinogenic substances known as trihalomethanes. As a result of concerns over trihalomethanes, prechlorination has become much less common in the United States. Currently, prechlorination is only used in plants where trihalomethane formation is not a problem.

### **Understanding Breakpoint Chlorination**

Addition of chlorine to water until the chlorine demand has been satisfied. Since ammonia is present in all domestic wastewaters, the reaction of ammonia with chlorine is a great significance. When chlorine is added to waters containing ammonia, the ammonia reacts with hypochlorous acid (HOCl) to form monochloramine, dichloramine and trichloramine. The formation of these chloramines depends on the pH of the solution and the initial chlorine-ammonia ratio.

### **Chlor-Alkali Membrane Process**

The chloralkali process (also chlor-alkali and chlor alkali) is an industrial process for the electrolysis of sodium chloride solution (brine). Depending on the method, several products besides hydrogen can be produced. If the products are separated, chlorine and sodium hydroxide (caustic soda) are the products; by mixing, sodium hypochlorite or sodium chlorate are produced, depending on the temperature. Higher temperatures are needed for the production of sodium chlorate instead of sodium hypochlorite. Industrial scale production began in 1892. When using calcium chloride or potassium chloride, the products contain calcium or potassium instead of sodium.

The process has a high energy consumption, for example over 4 billion kWh per year in West Germany in 1985, and produces equal (molar) amounts of chlorine and sodium hydroxide, which makes it necessary to find a use for the product for which there is less demand, usually the chlorine. There are three production methods in use. While the mercury cell method produces chlorine-free sodium hydroxide, the use of several tons of mercury leads to serious environmental problems. In a normal production cycle a few hundred pounds of mercury per year are emitted, which accumulate in the environment. Additionally, the chlorine and sodium hydroxide produced via the mercury-cell chloralkali process are themselves contaminated with trace amounts of mercury. The membrane and diaphragm method use no mercury, but the sodium hydroxide contains chlorine, which must be removed.

### **Understanding Chlorine's Effectiveness**

In 1881, German bacteriologist Robert Koch demonstrated under controlled laboratory conditions that pure cultures of bacteria could be destroyed by hypochlorite (bleach). The bulk of chlorine disinfection research, which was conducted from the 1940s to the 1970s with a focus on bacteria, provided observations as to how chlorine kills the microorganism. The observations that (1) bacterial cells dosed with chlorine release nucleic acids, proteins and potassium and (2) membrane functions such as respiration and active transport are affected more by chlorine than are cytoplasmic processes, directed researchers' attention to the surface of the bacterial cell. The hypothesis was that the bacterial cell wall, under environmental stress, could interact with chlorine.

Chlorine exposure appears to cause physical, chemical, and biochemical alterations to the cell wall, thus destroying the cell's protective barrier, terminating vital functions, resulting in death of the microorganism. A possible sequence of events during chlorination would be: (1) disruption of the cell wall barrier by reactions of chlorine with target sites at the cell surface, (2) release of vital cellular constituents from the cell, (3) termination of membrane-associated functions, and (4) termination of cellular functions within the cell. During the course of this sequence of events, the microorganism dies, meaning it is no longer capable of growing or causing disease.

### **Understanding Chlorine Solubility Effects**

Chlorine is only slightly soluble in water; its maximum solubility is approximately one percent at 49° C. At temperatures below this point it combines with water to form chlorine ice, a crystalline substance. When the water supply to a gas chlorinator is below normal room temperature, it may cool the chlorine gas to the point at which chlorine ice is formed and accumulates on the needle valve and gas outlet tube, resulting in erratic feed results. Because the vapor pressure of chlorine increases with rising temperatures, its solubility also decreases. At 212° F. chlorine is insoluble in water.

Chlorine dissolved in water forms a weak corrosive mixture of hydrochloric and hypochlorous acid. The corrosivity of chlorine solutions in water creates problems in handling chlorine spills and chlorine containers. Chlorine reacts with many compounds. Because of its great affinity for hydrogen, it removes hydrogen from some compounds, such as hydrogen sulfide. It also reacts with ammonia or other nitrogen-containing compounds to form various mixtures of chloramines. It reacts with organic materials, sometimes with explosive violence.

Chemicals like chlorine, bromine, and ozone are examples of oxidizers. It is their ability to oxidize or steal electrons from other substances that makes them good water sanitizers. As soon as the oxidizing agent is added to the water, it begins to combine with microorganisms like bacteria, algae, and whatever else the water may contain.

Now the free and available oxidizer is combining with contaminants and its effectiveness is reduced according to how much combining took place. Although the hydrogen ion does not play a direct reduction role on copper surfaces, pH can influence copper corrosion by altering the equilibrium potential of the oxygen reduction half-reaction and by changing the speciation of copper in solution (Reiber, 1989). Copper corrosion increases rapidly as the pH drops below 6; in addition, uniform corrosion rates can be high at low pH values (below about pH 7), causing metal thinning.

At higher pH values (above about pH 8), copper corrosion problems are almost always associated with non-uniform or pitting corrosion processes (Edwards et al., 1994a; Ferguson et al., 1996). Edwards et al. (1994b) found that for new copper surfaces exposed to simple solutions that contained bicarbonate, chloride, nitrate, perchlorate or sulfate, increasing the pH from 5.5 to 7.0 roughly halved corrosion rates, but further increases in pH yielded only subtle changes.

The prediction of copper levels in drinking water relies on the solubility and physical properties of the cupric oxide, hydroxide and basic carbonate solids that comprise most scales in copper water systems (Schock et al., 1995). In the cupric hydroxide model of Schock et al. (1995), a decrease in copper solubility with higher pH is evident. Above a pH of approximately 9.5, an upturn in solubility is predicted, caused by carbonate and hydroxide complexes increasing the solubility of cupric hydroxide. Examination of experience from 361 utilities reporting copper levels under the U.S. EPA Lead and Copper Rule revealed that the average 90th-percentile copper levels were highest in waters with pH below 7.4 and that no utilities with pH above 7.8 exceeded the U.S. EPA's action level for copper of 1.3 mg/L (Dodrill and Edwards, 1995). However, problems associated with copper solubility were also found to persist up to about pH 7.9 in cold, high-alkalinity and high-sulfate groundwater (Edwards et al., 1994a).

In the pH range of 7-9, both the corrosion rate and the degree of tuberculation of iron distribution systems generally increase with increasing pH (Larson and Skold, 1958; Stumm, 1960; Hatch, 1969; Pisigan and Singley, 1987).

Iron levels, however, were usually reported to decrease with increasing pH (Karalekas et al., 1983; Kashinkunti et al., 1999; Broo et al., 2001; Sarin et al., 2003). In a pipe loop system constructed from 90- to 100-year-old unlined cast iron pipes taken from a Boston distribution system, iron concentrations were found to steadily decrease when the pH was raised from 7.6 to 9.5 (Sarin et al., 2003). Similarly, when iron was measured in the distribution system following a pH increase from 6.7 to 8.5, a consistent downward trend in iron concentrations was found over 2 years (Karalekas et al., 1983). These observations are consistent with the fact that the solubility of iron-based corrosion by-products decreases with increasing pH.

Water with low pH, low alkalinity and low calcium is particularly aggressive towards cement materials. The water quality problems that may occur are linked to the chemistry of the cement. Lime from the cement releases calcium ions and hydroxyl ions into the drinking water. This, in turn, may result in a substantial pH increase, depending on the buffering capacity of the water (Leroy et al., 1996). Pilot-scale tests were conducted to simulate low-flow conditions of newly lined cement mortar pipes carrying low-alkalinity water (Douglas et al., 1996). In the water with an initial pH of 7.2, alkalinity of 14 mg/L as calcium carbonate and calcium at 13 mg/L as calcium carbonate, measures of pH as high as 12.5 were found.

Similarly, in the water with an initial pH of 7.8, alkalinity of 71 mg/L as calcium carbonate and calcium at 39 mg/L as calcium carbonate, measures of pH as high as 12 were found. The most significant pH increases were found during the 1st week of the experiment, and pH decreased slowly with aging of the lining. In a series of field and test rig trials to determine the impact of in situ cement mortar lining on water quality,



## Understanding Amperometric Titration

It appears that DPD colorimetric determination and amperometric titration as described in Standard Methods are the procedures most commonly used for routine measurement of total chlorine. Few studies have been conducted to evaluate these or other total residual chlorine measurement techniques. Bender studied approximately 10 test procedures and found that results using the DPD colorimetric procedure were consistently higher than those using amperometric titration. Brooks and Seegert described an amperometric titration procedure employing a recording polarograph and microburette, which was reported to be accurate and free from interference. The reliability of the DPD colorimetric method for free chlorine has been increasingly questioned in recent years. The suitability of that procedure for accurate total chlorine determinations appears to the authors to be questionable, as well. Amperometric titration as described in Standard Methods cannot be used to measure total chlorine concentrations less than about 0.05 mg/L, which is at least an order of magnitude greater than levels of concern in natural waters for potential toxicity to aquatic organisms. A reliable, simple procedure for low-level total chlorine determinations is clearly needed.

### Analytical Procedure

Section 409C of Standard Methods includes a General Discussion section on amperometric titration for the determination of chlorine in aqueous solutions. That discussion is applicable to the procedure used by the authors. Also included in Standard Methods is a section concerning the titration apparatus. Basically, the titration equipment consists of a buret capable of accurately delivering 0.01 mL of titrant, a sample cup, and a stirring device in which is housed a platinum electrode and a KCl reference electrode. Several companies manufacture amperometric titrators that fit this general description. The experience of the senior author is that some of the commercial titrators are less suitable than others, primarily because of the small surface area of some of the electrodes employed. A Wallace and Tiernan amperometric titrator was used by the authors in developing and applying the procedure described below.

### Reagents

a. Chlorine-free water. Only distilled or demineralized water that is free of chlorine should be used in preparing reagents. Chlorine-free water may be prepared by passing distilled or demineralized water through a suitable activated carbon filter adsorption column. The water may be tested for the presence of chlorine by titrating a sample as described in the Procedure section. Any deflection in the meter upon the addition of PAO titrant indicates the presence of chlorine or other oxidants that would interfere in the titration procedure.

b. Standard phenylarsine oxide (PAO), 0.00564 N. See Standard Methods Section 409B, paragraph 3a.

Standardization – Dilute 50.00 mL of freshly prepared 0.0002256 N potassium biniodate to 200 mL in chlorine-free water. Add approximately 1.5 g KI and stir to dissolve. Add 1 mL acetate buffer and allow to stand in the dark for 6 minutes. Titrate using the amperometric titrator and determine the equivalence point as detailed in the Procedure section. If the standard PAO is 0.00564 N, exactly 2.00 mL of PAO will be required to reach the equivalence point.

c. Phenylarsine oxide titrant, 0.000564 N. Dilute 10.00 mL of 0.00564 N PAO to 100.0 mL in chlorine-free water.

Standardization – Dilute 5.00 mL of 0.0002256 N potassium biniodate to 200 mL with chlorine-free water. Add approximately 1.5 g KI and stir to dissolve. Add 1 mL acetate buffer and allow to stand in the dark for 6 minutes.

Titrate using the amperometric titrator and determine the equivalence point as detailed in the Procedure section below. If the PAO titrant is 0.000564 N, exactly 2.00 mL of PAO will be required to reach the equivalence point.

d. Potassium biniodate, 0.0002256 N. Dissolve 0.7332 g reagent grade  $\text{KH}(\text{IO}_3)_2$  in 500 mL chlorine-free water and dilute to 1.00 L. Dilute 10.00 mL of that solution to 100.0 mL with chlorine-free water. That solution is used for the standardization of the PAO and should be freshly prepared.

e. Acetate buffer solution, pH 4. See Standard Methods<sup>1</sup> Section 409B, paragraph 3e.

f. Potassium iodide, (KI), reagent grade crystals.

### Procedure

a. Titrant selection. Normally a 200-mL sample is used in titration. Each 0.1 mL of 0.000564 N PAO corresponds to 0.01 mg/L in a 200-mL sample. The titrant normality should be selected such that no more than about 4 mL of titrant will be required to reach the equivalence point. Thus, if the chlorine concentration in the majority of the samples to be titrated is less than about 0.4 mg/L, use 0.000564 N PAO as the titrant. If only samples containing chlorine concentrations in excess of 0.4 mg/L are to be analyzed, use 0.00564 N PAO as the titrant. If samples containing concentrations of chlorine in excess of about 0.4 mg/L are to be titrated only occasionally and the volume of 0.000564 N PAO required for titration is found to be excessive, a suitable subsample may be used and diluted to 200 mL with chlorine-free water.

b. Titration procedure (total residual chlorine). Prior to beginning the titration, rinse the buret with PAO titrant by filling it completely and allowing the titrant to run into an empty sample cup. Repeating this operation three or four times will ensure that the correct titrant concentration reaches the sample cup. Remove the sample cup and rinse with distilled water and with the sample to be titrated. Add 200 mL of the sample to the sample cup. Add approximately 1.5 g ( $\pm$  0.2 g) crystalline KI and allow to dissolve, using the agitator on the titrator for mixing.

The exact amount of KI added is not critical, but the analyst should weigh 1.5 g of this reagent periodically to become familiar with the approximate amount required. Add 1 mL of acetate buffer and allow the microammeter on the titrator to reach a stable reading; the titration should be started within about 30 seconds following the addition of the KI to the sample.

Full-scale deflection on the microammeter is 100 units. The meter should be initially adjusted to read between 90 and 100 units. Record the initial reading prior to the addition of titrant. Titrate by adding suitable volumes of titrant and recording the titrant volume added and the resultant current reading. At least three (and preferably five to ten) readings of current and titrant volume added should be obtained prior to passing the equivalence point; then add excess titrant to ensure that there is no further meter deflection. Record the final meter reading. If, during the titration, the meter reading falls to near or below 10 units, record the low reading, re-adjust the meter to read between 90 and 100 units, record the high reading, and continue the titration. This approach allows calculation of the total meter deflection, which is used in determining the equivalence point.

The equivalence point is determined by plotting the total meter deflection as a function of titrant volume added. It is important that the total meter deflection be used in preparing this plot. A straight line is drawn through the first few points in the plot and a second straight line is drawn parallel to the abscissa and corresponding to the final total deflection in the meter reading.

The equivalence point is determined by the intersection of those two lines. When 0.000564 N PAO is used as the titrant, the chlorine concentration is 0.1-times the titrant volume at the equivalence point.

This plotting procedure is also outlined in the ASTM Water Manual<sup>8</sup> under procedures ASTM D1253 (Tests for Residual Chlorine in Water) and ASTM D1427 (Tests for Residual Chlorine in Waste Water).

c. Sample storage and handling. Chlorine measurements should be made as soon after sample collection as possible. Samples to be analyzed for chlorine should be stored in the dark and packed on ice if they must be held for more than a few minutes before analysis. Chlorine compounds are highly reactive and may be rapidly lost from samples due to the effects of volatilization, phototransformation, and chlorine demand. Storage of samples on ice and in the dark between sampling and analysis will help minimize the rate of dissipation. It is important to estimate the changes that occur in chlorine content in the subject water between sample collection and analysis.

This can be accomplished by performing a “time-lag” test. To perform a time-lag test, a single large (approximately 2-L) sample of the water being analyzed is collected. The chlorine concentration in that sample is determined six to ten times over a period of one to three hours, depending on the normal sample holding time. The measured concentrations are then plotted as a function of time, normally on semilog paper. In most cases, the decrease in chlorine concentration over time can be described by first-order reaction kinetics.

The original chlorine content in any sample can be computed given the measured concentration and the holding time. A time-lag study should be performed on a regular basis for each type of water being analyzed because of variability in water compositions.

The sample set used for the study should be handled in the same way as other samples (i.e., the samples should be kept cold and in the dark). Even when time-lag studies are made a part of the routine analytical procedure, it is important that the delay between sample collection and chlorine analysis be held to a minimum.

### **Sodium Hypochlorite**

Sodium Hypochlorite, or bleach, is produced by adding elemental chlorine to sodium hydroxide. Typically, hypochlorite solutions contain from 5 to 15% chlorine, and are shipped by truck in one- to 5,000- gallon containers.

#### **Advantages**

- ✓ Solution is less hazardous and easier to handle than elemental chlorine
- ✓ Fewer training requirements and regulations than elemental chlorine

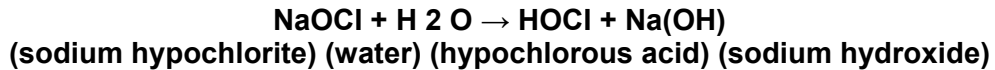
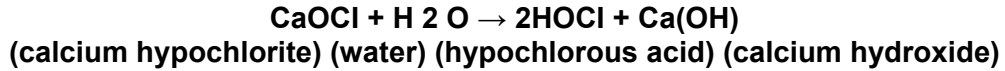
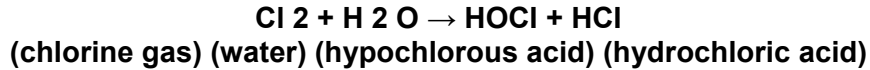
#### **Limitations**

- ✓ Limited shelf-life
- ✓ Potential to add inorganic byproducts (chlorate, chlorite and bromate) to water
- ✓ Corrosive to some materials and more difficult to store than most solution chemicals
- ✓ Higher chemical costs than elemental chlorine



## Chemistry of Chlorination

Chlorine can be added as sodium hypochlorite, calcium hypochlorite or chlorine gas. When any of these is added to water, chemical reactions occur as these equations show:



All three forms of chlorine produce hypochlorous acid (HOCl) when added to water. Hypochlorous acid is a weak acid but a strong disinfecting agent. The amount of hypochlorous acid depends on the pH and temperature of the water. Under normal water conditions, hypochlorous acid will also chemically react and break down into a hypochlorite ion. The direction of this reaction is highly pH and temperature dependent



The hypochlorite ion is a much weaker disinfecting agent than hypochlorous acid; about 100 times less effective.

Let's now look at how pH and temperature affect the ratio of hypochlorous acid to hypochlorite ions. As the temperature is decreased, the ratio of hypochlorous acid increases. Temperature plays a small part in the acid ratio. Although the ratio of hypochlorous acid is greater at lower temperatures, pathogenic organisms are actually harder to kill. All other things being equal, higher water temperatures and a lower pH are more conducive to chlorine disinfection.

## Types of Residual

If water were pure, the measured amount of chlorine in the water should be the same as the amount added. But water is not 100% pure. There are always other substances (interfering agents) such as iron, manganese, turbidity, etc., which will combine chemically with the chlorine.

These products have no disinfection value and are called the **chlorine demand**. Naturally, once chlorine molecules are combined with these interfering agents, they are not capable of disinfection. Next, ammonia combines to form chloramines. It is free chlorine that is much more effective as a disinfecting agent.

So let's look now at how free, total and combined chlorine are related. When a chlorine residual test is taken, either a total or a free chlorine residual can be read.

**Total residual is all chlorine that is available for disinfection.**

**Total chlorine residual = free + combined chlorine residual.**

Free chlorine residual is a much stronger disinfecting agent. Therefore, most water regulating agencies will require that your daily chlorine residual readings be of free chlorine residual.

**Break-point chlorination** is where the chlorine demand has been satisfied; and any additional chlorine will be considered **free chlorine**.

BACTERIA / VIRUS	DISINFECTION TIME FOR FECAL CONTAMINANTS IN CHLORINATED WATER
<p><b>E. COLI</b> (BACTERIUM)</p>	<p>LESS THAN 1 MINUTE OF CONTACT TIME</p>
<p><b>HEPATITUS A</b> (VIRUS)</p>	<p>APPROXIMATELY 16 MINUTES CONTACT TIME</p>
<p><b>GIARDIA</b> (PARASITE)</p>	<p>APPROXIMATELY 45 MINUTES CONTACT TIME</p>
<p><b>CRYPTOSPORIDIUM</b> (PARASITE)</p>	<p>APPROXIMATELY 10.6 DAYS (15,300 minutes)</p>

**CHLORINE TIMETABLE FOR PROPER DISINFECTION**

## Residual Concentration/Contact Time (CT) Requirements

Disinfection to eliminate fecal and coliform bacteria may not be sufficient to adequately reduce pathogens such as Giardia or viruses to desired levels. Use of the "**CT**" disinfection concept is recommended to demonstrate satisfactory treatment, since monitoring for very low levels of pathogens in treated water is analytically very difficult.

The CT concept, as developed by the United States Environmental Protection Agency (Federal Register, 40 CFR, Parts 141 and 142, June 29, 1989), uses the combination of disinfectant residual concentration (mg/L) and the effective disinfection contact time (in minutes) to measure effective pathogen reduction. The residual is measured at the end of the process, and the contact time used is the T10 of the process unit (time for 10% of the water to pass).

$$\text{CT} = \text{Concentration (mg/L)} \times \text{Time (minutes)}$$

The effective reduction in pathogens can be calculated by reference to standard tables of required CTs.

### Required Giardia/Virus Reduction

All surface water treatment systems shall ensure a minimum reduction in pathogen levels: 3-log reduction in Giardia; and 4-log reduction in viruses.

These requirements are based on unpolluted raw water sources with Giardia levels of = 1 cyst/100 L, and a finished water goal of 1 cyst/100,000 L (equivalent to 1 in 10,000 risk of infection per person per year). Higher raw water contamination levels may require greater removals as shown on Table 4.1.

#### TABLE 4.1

##### Level of Giardia Reduction

##### Raw Water Giardia Levels\*

##### Recommended Giardia Log Reduction

< 1 cyst/100 L 3-log

1 cyst/100 L - 10 cysts/100 L 3-log - 4-log

10 cysts/100 L - 100 cysts/100 L 4-log - 5-log

> 100 cysts/100 L > 5-log

\*Use geometric means of data to determine raw water Giardia levels for compliance.

### Required CT Value

Required CT values are dependent on pH, residual concentration, temperature, and the disinfectant used.

**Calculation and Reporting of CT Data**

Disinfection CT values shall be calculated daily, using either the maximum hourly flow and the disinfectant residual at the same time, or by using the lowest CT value if it is calculated more frequently. Actual CT values are then compared to required CT values.

Results shall be reported as a reduction Ratio, along with the appropriate pH, temperature, and disinfectant residual. The reduction Ratio must be greater than 1.0 to be acceptable.

Users may also calculate and record actual log reductions.

**Reduction Ratio = CT actual divide by CT required.**



## Disinfection Summary

### Wastewater Disinfection

There are a number of chemicals and processes that will disinfect wastewater, but none are universally applicable. Most septic tanks discharge into various types of subsurface wastewater infiltration systems (SWIS), such as tile fields or leach fields. These applications rely on the formation of a biomat at the gravel-soil interface where "biodegradation and filtration combine to limit the travel of pathogens."

Aerobic treatment processes reduce pathogens, but not enough to qualify as a disinfection process. "Chlorination/dechlorination has been the most widely used disinfection technology in the U.S.; ozonation and UV light are emerging technologies." Each of these three methods have different considerations for the disinfection of wastewater.

### Water Disinfection

Disinfection is usually the final stage in the water treatment process in order to limit the effects of organic material, suspended solids and other contaminants. Like the disinfection of wastewater, the primary methods used for the disinfection of water in very small (25-500 people) and small (501-3,300 people) treatment systems are ozone, ultraviolet irradiation (UV) and chlorine.

There are numerous alternative disinfection processes that have been less widely used in small and very small water treatment systems, including chlorine dioxide, potassium permanganate, chloramines and peroxone (ozone/hydrogen peroxide).

Surface waters have been the focal point of water disinfection regulations since their inception, as groundwaters (like wells) have been historically considered to be free of microbiological contamination. Current data indicates this to not be true. Amendments to the Safe Drinking Water Act in 1996 mandate the development of regulations to require disinfection of groundwater "as necessary."

While these regulations will apply to very small systems serving twenty-five people at least 60 days out of the year, the rules will not apply to private wells. However, the EPA recommends that wells be tested at least once per year and disinfected as necessary.

While these proposed regulations have not yet been finalized, they will likely include; testing by each state, identification of contaminated water supplies, corrective action requiring disinfection and compliance monitoring. The rules are currently scheduled to be implemented in July 2003.

### Residual Disinfection

The EPA requires a residual level of disinfection of water in pipelines to prevent microbial re-growth and help protect treated water throughout the distribution system. EPA's maximum residual disinfection levels (MRDLs) are 4 mg/l for chlorine, 4 mg/l for chloramines and 0.8 mg/l for chlorine dioxide. Although chlorine levels are usually significantly lower in tap water, EPA believes that levels as high as the MRDLs pose no risk of adverse health effects, allowing for an adequate margin of safety (U.S. EPA, 1998a).

### **Chlorate Ion**

The chlorate anion has the formula  $\text{ClO}_3^-$ . In this case, the chlorine atom is in the +5 oxidation state. "Chlorate" can also refer to chemical compounds containing this anion; chlorates are the salts of chloric acid. "Chlorate", when followed by a roman numeral in parentheses, e.g. chlorate (VII), refers to a particular oxyanion of chlorine. As predicted by VSEPR, chlorate anions have trigonal pyramidal structures.

Chlorates are powerful oxidizers and should be kept away from organics or easily oxidized materials. Mixtures of chlorate salts with virtually any combustible material (sugar, sawdust, charcoal, organic solvents, metals, etc.) will readily deflagrate. Chlorates were once widely used in pyrotechnics for this reason, though their use has fallen due to their instability. Most pyrotechnic applications which formerly used chlorates in the past now use the more stable perchlorates instead

### **Examples of chlorates include**

- ✓ potassium chlorate,  $\text{KClO}_3$
- ✓ sodium chlorate,  $\text{NaClO}_3$
- ✓ magnesium chlorate,  $\text{Mg}(\text{ClO}_3)_2$

### **Chloride Ion**

The chloride ion is formed when the element chlorine, a halogen, gains an electron to form an anion (negatively-charged ion)  $\text{Cl}^-$ . The salts of hydrochloric acid contain chloride ions and can also be called chlorides. The chloride ion, and its salts such as sodium chloride, are very soluble in water. It is an essential electrolyte located in all body fluids responsible for maintaining acid/base balance, transmitting nerve impulses and regulating fluid in and out of cells.

The word chloride can also form part of the name of chemical compounds in which one or more chlorine atoms are covalently bonded. For example, methyl chloride, more commonly called chloromethane, ( $\text{CH}_3\text{Cl}$ ) is an organic covalently bonded compound, which does not contain a chloride ion.

Chloride is used to form salts that can preserve food such as sodium chloride. Other salts such as calcium chloride, magnesium chloride, potassium chloride have varied uses ranging from medical treatments to cement formation.

An example is table salt, which is sodium chloride with the chemical formula  $\text{NaCl}$ . In water, it dissociates into  $\text{Na}^+$  and  $\text{Cl}^-$  ions.

### **Examples of inorganic covalently bonded chlorides that are used as reactants are:**

- ✓ Phosphorus trichloride, phosphorus pentachloride, and thionyl chloride, all three of which reactive chlorinating reagents that have been used in a laboratory.
- ✓ Disulfur dichloride ( $\text{S}_2\text{Cl}_2$ ), used for vulcanization of rubber.

A chloride ion is also the prosthetic group present in the amylase enzyme. Another example is calcium chloride with the chemical formula  $\text{CaCl}_2$ . Calcium chloride is a salt that is marketed in pellet form for removing dampness from rooms.

Calcium chloride is also used for maintaining unpaved roads and for sanite fortifying roadbases for new construction. In addition, Calcium chloride is widely used as a deicer since it is effective in lowering the melting point when applied to ice.

In the petroleum industry, the chlorides are a closely monitored constituent of the mud system. An increase of the chlorides in the mud system may be an indication of drilling into a high-pressure saltwater formation. Its increase can also indicate the poor quality of a target sand. Chloride is also a useful and reliable chemical indicator of river / groundwater fecal contamination, as chloride is a non-reactive solute and ubiquitous to sewage & potable water. Many water regulating companies around the world utilize chloride to check the contamination levels of the rivers and potable water sources.

### Chlorite Ion

The chlorite ion is  $\text{ClO}_2^-$ . A chlorite (compound) is a compound that contains this group, with chlorine in oxidation state +3. Chlorites are also known as salts of chlorous acid. Chlorine can assume oxidation states of -1, +1, +3, +5, or +7 within the corresponding anions  $\text{Cl}^-$ ,  $\text{ClO}^-$ ,  $\text{ClO}_2^-$ ,  $\text{ClO}_3^-$ , or  $\text{ClO}_4^-$ , known commonly and respectively as chloride, hypochlorite, chlorite, chlorate, and perchlorate. An additional oxidation state of +4 is seen in the neutral compound chlorine dioxide  $\text{ClO}_2$ , which has a similar structure to chlorite  $\text{ClO}_2^-$  (oxidation state +3) and the cation chloryl ( $\text{ClO}_2^+$ ) (oxidation state +5).

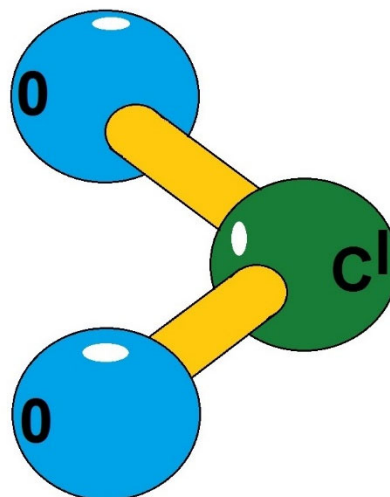
### Chlorine Dioxide

Chlorine dioxide is a chemical compound with the formula  $\text{ClO}_2$ . This yellowish-green gas crystallizes as bright orange crystals at  $-59^\circ\text{C}$ . As one of several oxides of chlorine, it is a potent and useful oxidizing agent used in water treatment and in bleaching. The molecule  $\text{ClO}_2$  has an odd number of valence electrons and it is therefore a paramagnetic radical. Its electronic structure has long baffled chemists because none of the possible Lewis structures are very satisfactory. In 1933 L.O. Brockway proposed a structure that involved a three-electron bond.

Chemist Linus Pauling further developed this idea and arrived at two resonance structures involving a double bond on one side and a single bond plus three-electron bond on the other.

In Pauling's view the latter combination should represent a bond that is slightly weaker than the double bond. In molecular orbital theory this idea is commonplace if the third electron is placed in an anti-bonding orbital. Later work has confirmed that the HOMO is indeed an incompletely-filled orbital.

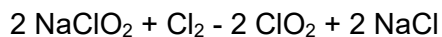
Chlorine dioxide is a highly endothermic compound that can decompose extremely violently when separated from diluting substances.



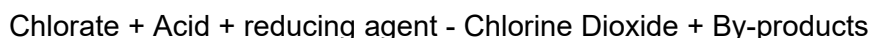
**CHLORINE DIOXIDE MOLECULE**

As a result, preparation methods that involve producing solutions of it without going through a gas phase stage are often preferred. Arranging handling in a safe manner is essential.

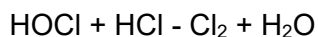
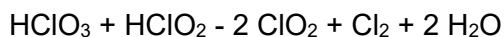
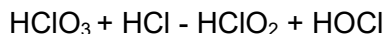
In the laboratory, ClO<sub>2</sub> is prepared by oxidation of sodium chlorite:



Over 95% of the chlorine dioxide produced in the world today is made from sodium chlorate and is used for pulp bleaching. It is produced with high efficiency by reducing sodium chlorate in a strong acid solution with a suitable reducing agent such as methanol, hydrogen peroxide, hydrochloric acid or sulfur dioxide. Modern technologies are based on methanol or hydrogen peroxide, as these chemistries allows the best economy and do not co-produce elemental chlorine. The overall reaction can be written;



The reaction of sodium chlorate with hydrochloric acid in a single reactor is believed to proceed via the following pathway:



The commercially more important production route uses methanol as the reducing agent and sulfuric acid for the acidity. Two advantages by not using the chloride-based processes are that there is no formation of elemental chlorine, and that sodium sulfate, a valuable chemical for the pulp mill, is a side-product. These methanol-based processes provide high efficiency and can be made very safe.

A much smaller, but important, market for chlorine dioxide is for use as a disinfectant. Since 1999 a growing proportion of the chlorine dioxide made globally for water treatment and other small-scale applications has been made using the chlorate, hydrogen peroxide and sulfuric acid method, which can produce a chlorine-free product at high efficiency.

Traditionally, chlorine dioxide for disinfection applications has been made by one of three methods using sodium chlorite or the sodium chlorite - hypochlorite method:

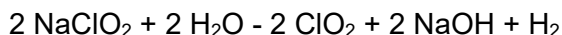


or the sodium chlorite - hydrochloric acid method:

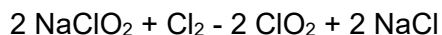


All three sodium chlorite chemistries can produce chlorine dioxide with high chlorite conversion yield, but unlike the other processes the chlorite-HCl method produces completely chlorine-free chlorine dioxide but suffers from the requirement of 25% more chlorite to produce an equivalent amount of chlorine dioxide. Alternatively, hydrogen peroxide may efficiently be used also in small scale applications.

Very pure chlorine dioxide can also be produced by electrolysis of a chlorite solution:



High purity chlorine dioxide gas (7.7% in air or nitrogen) can be produced by the Gas: Solid method, which reacts dilute chlorine gas with solid sodium chlorite.



These processes and several slight variations have been reviewed.

### **Haloacetic Acids**

Haloacetic acids are carboxylic acids in which a halogen atom takes the place of a hydrogen atom in acetic acid. Thus, in a monohaloacetic acid, a single halogen would replace a hydrogen atom.

For example, chloroacetic acid would have the structural formula  $\text{CH}_2\text{ClCO}_2\text{H}$ . In the same manner, in dichloroacetic acid two chlorine atoms would take the place of two hydrogen atoms ( $\text{CHCl}_2\text{CO}_2\text{H}$ ). The inductive effect caused by the electronegative halogens often result in the higher acidity of these compounds by stabilizing the negative charge of the conjugate base.

### **Contaminants in Drinking Water**

Haloacetic acids (HAAs) are a common undesirable by-product of drinking water chlorination. Exposure to such disinfection by-products in drinking water has been associated with a number of health outcomes by epidemiological studies, although the putative agent in such studies has not been identified.

#### **In water, HAAs are stable, with the five most common being:**

- ✓ monochloroacetic acid (MCA)  $\text{ClCH}_2\text{COOH}$ ;
- ✓ dichloroacetic acid (DCA)  $\text{Cl}_2\text{CHCOOH}$ ;
- ✓ trichloroacetic acid (TCA)  $\text{Cl}_3\text{CCOOH}$ ;
- ✓ monobromoacetic acid (MBA)  $\text{BrCH}_2\text{COOH}$ ;
- ✓ dibromoacetic acid (DBA)  $\text{Br}_2\text{CHCOOH}$ .

Collectively, these are referred to as the HAA5. HAAs can be formed by chlorination, ozonation or chloramination of water with formation promoted by slightly acidic water, high organic matter content and elevated temperature.

Chlorine from the water disinfection process can react with organic matter and small amounts of bromide present in water to produce various HAAs. A study published in August 2006 found that total levels of HAAs in drinking water were not affected by storage or boiling, but that filtration was effective in decreasing levels.

## **Hypochlorites**

Hypochlorites are calcium or sodium salts of hypochlorous acid and are supplied either dry or in liquid form (as, for instance, in commercial bleach). The same residuals are obtained as with gas chlorine, but the effect on the pH of the treated water is different. Hypochlorite compounds contain an excess of alkali and tend to raise the pH of the water.

Calcium hypochlorite tablets are the predominant form in use in the United States for swimming pools. Sodium hypochlorite is the only liquid hypochlorite disinfectant in current use. There are several grades and proprietary forms available. Pound-for-pound of available chlorine, hypochlorite compounds have oxidizing powers equal to gas chlorine and can be employed for the same purposes in water treatment. Gas chlorination requires a larger initial investment for feed equipment than what is needed for hypochlorite compounds.

Calcium hypochlorite materials used in the water industry are chemically different from those materials variously marketed for many years as bleaching powder, chloride of lime, or chlorinated lime. Materials now in common use are high-test calcium hypochlorites containing about 70 percent available chlorine and marketed under several trade names.

High-test calcium hypochlorites are white corrosive solids that give off a strong chlorine odor. Granular powdered or tablet forms are commercially available and all are readily soluble in water.

Sodium hypochlorite is sold only as a liquid and is normally referred to as liquid bleach. It is generally available in concentrations of 5 to 15 percent available chlorine. These solutions are clear, light yellow, strongly alkaline, and corrosive in addition to having a strong chlorine smell.

High-test hypochlorites, though highly active, are relatively stable throughout production, packaging, distribution, and storage. Storage at 86° F. for a year may reduce the available chlorine by about 10 percent.

Storing at lower temperatures reduces the loss. All sodium-hypochlorite solutions are unstable to some degree and deteriorate more rapidly than the dry compounds. Most producers recommend a shelf life of 60 to 90 days. Because light and heat accelerate decomposition, containers should be stored in a dry, cool, and dark area.

## **Disinfection Byproducts**

Disinfection byproducts are formed when disinfectants used in water treatment plants react with bromide and/or natural organic matter (i.e., decaying vegetation) present in the source water.

Different disinfectants produce different types or amounts of disinfection byproducts. Disinfection byproducts for which regulations have been established have been identified in drinking water, including trihalomethanes, haloacetic acids, bromate, and chlorite.

### **Trihalomethanes (THM)**

Trihalomethanes (THM) are a group of four chemicals that are formed along with other disinfection byproducts when chlorine or other disinfectants used to control microbial contaminants in drinking water react with naturally occurring organic and inorganic matter in water.

The trihalomethanes are chloroform, bromodichloromethane, dibromochloromethane, and bromoform. EPA has published the Stage 1 Disinfectants/Disinfection Byproducts Rule to regulate total trihalomethanes (TTHM) at a maximum allowable annual average level of 80 parts per billion. This standard will replace the current standard of a maximum allowable annual average level of 100 parts per billion in December 2001 for large surface water public water systems. The standard became effective for the first time in December 2003 for small surface water and all ground water systems.

### **Haloacetic Acids (HAA5)**

Haloacetic Acids (HAA5) are a group of chemicals that are formed along with other disinfection byproducts when chlorine or other disinfectants used to control microbial contaminants in drinking water react with naturally occurring organic and inorganic matter in water. The regulated haloacetic acids, known as HAA5, are: monochloroacetic acid, dichloroacetic acid, trichloroacetic acid, monobromoacetic acid, and dibromoacetic acid. EPA has published the Stage 1 Disinfectants/Disinfection Byproducts Rule to regulate HAA5 at 60 parts per billion annual average. This standard became effective for large surface water public water systems in December 2001 and for small surface water and all ground water public water systems in December 2003.

Bromate is a chemical that is formed when ozone used to disinfect drinking water reacts with naturally occurring bromide found in source water. EPA has established the Stage 1 Disinfectants/Disinfection Byproducts Rule to regulate bromate at annual average of 10 parts per billion in drinking water. This standard became effective for large public water systems by December 2001 and for small surface water and all ground public water systems in December 2003.

### **Chlorite**

Chlorite is a byproduct formed when chlorine dioxide is used to disinfect water. EPA has published the Stage 1 Disinfectants/Disinfection Byproducts Rule to regulate chlorite at a monthly average level of 1 part per million in drinking water. This standard became effective for large surface water public water systems in December 2001 and for small surface water and all ground water public water systems in December 2003.

### **Chloroform**

Chloroform, typically the most prevalent THM measured in chlorinated water, is probably the most thoroughly studied disinfection byproduct. Toxicological studies have shown that high levels of chloroform can cause cancer in laboratory animals. Extensive research conducted since the early 1990s provides a clearer picture of what this means for humans exposed to far lower levels through drinking water.

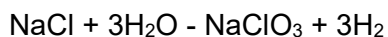
One study (Larson et al. 1994a) conducted by the Centers for Health Research (CIIT) observed that a very large dose of chloroform, when given to mice once per day into the stomach (a procedure known as gavage), produced liver damage and eventually cancer. In a second CIIT cancer study (Larson et al., 1994b), mice were given the same daily dose of chloroform through the animals' drinking water.

This time, no cancer was produced. Follow-up research showed that the daily gavage doses overwhelmed the capability of the liver to detoxify the chloroform, causing liver damage, cell death and regenerative cell growth, thereby increasing risks for cell mutation and cancer in exposed organs. When chloroform was given through drinking water, however, the liver could continually detoxify the chloroform as the mice sipped the water throughout the day. Without the initial liver toxicity, there was no cancer in the liver, kidney or other exposed organs (Butterworth et al., 1998).

In its most recent risk assessment, EPA considered the wealth of available information on chloroform, including the important work done at CIIT. EPA concludes that exposure to chloroform below the threshold level that causes cell damage is unlikely to increase the risk of cancer. While chloroform is likely to be carcinogenic at a high enough dose, exposures below a certain dose range are unlikely to pose any cancer risk to humans (US EPA, 2002a). For drinking water meeting EPA standards, chloroform is unlikely to be a health concern.

### **Sodium Chlorate**

Sodium chlorate is a chemical compound with the chemical formula ( $\text{NaClO}_3$ ). When pure, it is a white crystalline powder that is readily soluble in water. It is hygroscopic. It decomposes above  $250\text{ }^\circ\text{C}$  to release oxygen and leave sodium chloride. Industrially, sodium chlorate is synthesized from the electrolysis of a hot sodium chloride solution in a mixed electrode tank:



It can also be synthesized by passing chlorine gas into a hot sodium hydroxide solution. It is then purified by crystallization.

### **Chemical Oxygen Generation**

Chemical oxygen generators, such as those in commercial aircraft, provide emergency oxygen to passengers to protect them from drops in cabin pressure by catalytic decomposition of sodium chlorate. The catalyst is normally iron powder. Barium peroxide ( $\text{BaO}_2$ ) is used to absorb the chlorine which is a minor product in the decomposition. Iron powder is mixed with sodium chlorate and ignited by a charge which is activated by pulling on the emergency mask. The reaction produces more oxygen than is required for combustion. Similarly, the Solidox welding system used pellets of sodium chlorate mixed with combustible fibers to generate oxygen.

### **Toxicity in Humans**

Due to its oxidative nature, sodium chlorate can be very toxic if ingested. The oxidative effect on hemoglobin leads to methemoglobin formation, which is followed by denaturation of the globin protein and a cross-linking of erythrocyte membrane proteins with resultant damage to the membrane enzymes.

This leads to increased permeability of the membrane, and severe hemolysis. The denaturation of hemoglobin overwhelms the capacity of the G6PD metabolic pathway. In addition, this enzyme is directly denatured by chlorate reducing its activity. Therapy with ascorbic acid and methylene blue are frequently used in the treatment of methemoglobinemia.



However, since methylene blue requires the presence of NADPH that requires normal functioning of G6PD system, it is less effective than in other conditions characterized by hemoglobin oxidation.

Acute severe hemolysis results, with multi-organ failure, including DIC and renal failure. In addition, there is a direct toxicity to the proximal renal tubule. The treatment will consist of exchange transfusion, peritoneal dialysis or hemodialysis.

### **Developmental and Reproductive Effects**

Several epidemiology studies have reported a possible association between disinfection byproducts and adverse reproductive outcomes, including spontaneous abortion (miscarriage). One study of women in several California communities (Waller et al. 1998) found a stronger association with bromodichloromethane (BDCM) than with other byproducts. Because the available studies have significant limitations, EPA and the American Water Works Association Research Foundation are sponsoring a new epidemiology study to replicate the 1998 Waller study.

When the Waller study was published, the available toxicology data on reproductive and developmental effects of some DBPs was quite limited. It was recognized that BDCM, in particular, should be thoroughly studied for a potential causal relationship to reproductive and developmental toxicity.

The Research Foundation for Health and Environmental Effects, a tax-exempt foundation established by the Chlorine Chemistry Division of the American Chemistry Council, sponsored a set of animal studies (Christian et al. 2001, 2002) including two developmental toxicity studies on BDCM, a reproductive toxicity study on BDCM, and a reproductive toxicity study on dibromoacetic acid (DBA). The studies, published in the International Journal of Toxicology, found no adverse effects from BDCM and DBA at dose levels thousands of times higher than what humans are exposed to through drinking water. The studies were designed to comply with stringent EPA guidelines, and each study was independently monitored and peer reviewed.

### **Formulations**

Sodium chlorate comes in dust, spray and granule formulations. There is a risk of fire and explosion in dry mixtures with other substances, especially organic materials, and other herbicides, sulfur, phosphorus, powdered metals, strong acids. In particular, when mixed with sugar, it has explosive properties.

If accidentally mixed with one of these substances it should not be stored in human dwellings. Marketed formulations contain a fire retardant, but this has little effect if deliberately ignited. Most commercially available chlorate weedkillers contain approximately 53% sodium chlorate with the balance being a fire depressant such as sodium metaborate or ammonium phosphates.

### **Sodium Chlorite**

Sodium chlorite, like many oxidizing agents, should be protected from inadvertent contamination by organic materials to avoid the formation of an explosive mixture. The chemical explodes on percussive impact, and will ignite if combined with a strong reducing agent.

## **Toxicity**

Sodium chlorite is a strong oxidant and can therefore be expected to cause clinical symptoms similar to the well-known sodium chlorate: methemoglobinemia, hemolysis, renal failure. A dose of 10-15 grams of sodium chlorate can be lethal. Methemoglobinemia had been demonstrated in rats and cats, and recent studies by the EMEA have confirmed that the clinical symptomatology is very similar to the one caused by sodium chlorate in the rat, mouse, rabbit, and the green monkey.

There is only one human case in the medical literature of chlorite poisoning. It seems to confirm that the toxicity is equal to sodium chlorate. From the analogy with sodium chlorate, even small amounts of about 1 gram can be expected to cause nausea, vomiting and even life-threatening hemolysis in Glucose-6-Phosphate Dehydrogenase deficient persons. The EPA has set a maximum contaminant level of 1 milligram of chlorite per liter (1 mg/L) in drinking water.

## **Manufacture**

The free acid, chlorous acid,  $\text{HClO}_2$ , is only stable at low concentrations. Since it cannot be concentrated, it is not a commercial product. However, the corresponding sodium salt, sodium chlorite,  $\text{NaClO}_2$  is stable and inexpensive enough to be commercially available. The corresponding salts of heavy metals ( $\text{Ag}^+$ ,  $\text{Hg}^+$ ,  $\text{Tl}^+$ ,  $\text{Pb}^{2+}$ , and also  $\text{Cu}^{2+}$  and  $\text{NH}_4^+$ ) decompose explosively with heat or shock.

Sodium chlorite is derived indirectly from sodium chlorate,  $\text{NaClO}_3$ . First, the explosive (only at concentrations greater than 10% in atmosphere) chlorine dioxide,  $\text{ClO}_2$  is produced by reducing sodium chlorate in a strong acid solution with a suitable reducing agent (for example, sodium sulfite, sulfur dioxide, or hydrochloric acid). The chlorine dioxide is then absorbed into an alkaline solution and reduced with hydrogen peroxide ( $\text{H}_2\text{O}_2$ ), yielding sodium chlorite.

## **Stachybotrys**

Stachybotrys is a genus of molds, or asexually-reproducing, filamentous fungi. Closely related to the genus *Memnoniella*, most Stachybotrys species inhabit materials rich in cellulose. The genus has a widespread distribution, and contains about 50 species.

The most infamous species, *S. chartarum* (also known as *S. atra*) and *S. chlorohalonata* are known as "black mold" or "toxic black mold" in the U.S. and are frequently associated with poor indoor air quality that arises after fungal growth on water-damaged building materials

## **Symptoms of Stachybotrys Exposure in Humans**

Exposure to the mycotoxins present in *Stachybotrys chartarum* or *Stachybotrys atra* can have a wide range of effects.

Depending on the length of exposure and volume of spores inhaled or ingested, symptoms can manifest as chronic fatigue or headaches, fever, irritation to the eyes, mucous membranes of the mouth, nose and throat, sneezing, rashes, and chronic coughing. In severe cases of exposure or cases exacerbated by allergic reaction, symptoms can be extreme including nausea, vomiting, and bleeding in the lungs and nose.

### **Understanding Commonly Used Water Disinfectants**

Almost all U.S. systems that disinfect their water use some type of chlorine-based process, either alone or in combination with other disinfectants. In addition to controlling disease-causing organisms, chlorination offers a number of benefits including:

- Reduces many disagreeable tastes and odors;
- Eliminates slime bacteria, molds and algae that commonly grow in water supply reservoirs, on the walls of water mains and in storage tanks;
- Removes chemical compounds that have unpleasant tastes and hinder disinfection; and
- Helps remove iron and manganese from raw water.

As importantly, only chlorine-based chemicals provide “residual disinfectant” levels that prevent microbial re-growth and help protect treated water throughout the distribution system.

### **The Risks of Waterborne Disease**

Where adequate water treatment is not readily available, the impact on public health can be devastating. Worldwide, about 1.2 billion people lack access to safe drinking water, and twice that many lack adequate sanitation. As a result, the World Health Organization estimates that 3.4 million people, mostly children, die every year from water-related diseases.

Even where water treatment is widely practiced, constant vigilance is required to guard against waterborne disease outbreaks. Well-known pathogens such as *E. coli* are easily controlled with chlorination, but can cause deadly outbreaks given conditions of inadequate or no disinfection.

A striking example occurred in May 2000 in the Canadian town of Walkerton, Ontario. Seven people died and more than 2,300 became ill after *E. coli* and other bacteria infected the town’s water supply. A report published by the Ontario Ministry of the Attorney General concludes that, even after the well was contaminated, the Walkerton disaster could have been prevented if the required chlorine residuals had been maintained.

Some emerging pathogens such as *Cryptosporidium* are resistant to chlorination and can appear even in high quality water supplies.

*Cryptosporidium* was the cause of the largest reported drinking water outbreak in U.S. history, affecting over 400,000 people in Milwaukee in April 1993. More than 100 deaths are attributed to this outbreak.

New regulations from the U.S. Environmental Protection Agency (EPA) will require water systems to monitor *Cryptosporidium* and adopt a range of treatment options based on source water *Cryptosporidium* concentrations. Most water systems are expected to meet EPA requirements while continuing to use chlorination.

## Conclusions

- Chlorine is one of nature's most common chemical elements.
- Electricity applied to salt solutions enables the chlor-alkali industry to harness chlorine captured in salt deposits of ancient oceans.
- Chlorine's chemical properties make it an extremely effective disinfectant and essential component in the chemical manufacture of literally thousands of vital products used every day.
- Pairs of substances that chlorine will react explosively or form explosive compounds with are acetylene and ether, turpentine and ammonia and hydrogen and finely divided metals.
- Monochloramine, dichloramine, and trichloramine are known as combined available chlorine.
- The chlorine pressure reducing valve should be located downstream of the evaporator when using an evaporator.
- Chlorine is added to the effluent before the contact chamber for complete mixing. What is the reason for not adding it directly to the chamber? The chamber has very little mixing due to low velocities.
- The two main chemical species formed by chlorine in water and the name that are they are known collectively are HOCl and OCl<sup>-</sup>; free available chlorine.
- When chlorine gas is added to water, it rapidly hydrolyzes. The chemical equation that best describes this reaction is  $\text{Cl}_2 + \text{H}_2\text{O} \rightarrow \text{H}^+ + \text{Cl}^- + \text{HOCl}$ .
- Yoke-type connectors should be used on a chlorine cylinder's valve; always assume the threads on the valve may be worn.
- Excessive chlorine can kill the aerobic organisms in the secondary treatment plant. Take precaution when applying chlorine in the sewer line near a wastewater treatment plant to control hydrogen sulfide production and anaerobic bacteria.
- When replacing the connection from a chlorine cylinder to a chlorinator always use a new, approved gasket on the connector and follow the manufacturer's instructions.
- Safety precautions when using chlorine gas: In addition to protective clothing and goggles, chlorine gas should be used only in a well-ventilated area so that any leaking gas cannot concentrate.
- Several symptoms of chlorine exposure: Burning of eyes, nose, and mouth, coughing, sneezing, choking, nausea and vomiting; headaches and dizziness; fatal pulmonary edema, pneumonia, and skin blisters.
- Approved method for storing a chlorine cylinder: Secure each cylinder in an upright position, attach the protective bonnet over the valve and firmly secure each cylinder.
- Emergency procedures in the case of a large uncontrolled chlorine leak: Notify local emergency response team, warn and evacuate people in adjacent areas, be sure that no one enters the leak area without adequate self-contained breathing equipment.

## Chlorine Facts Review

*This information is necessary to pass your post-quiz.*

### \* OSHA PEL 1 PPM - IDLH 10 PPM and Fatal Exposure Limit 1,000 PPM

The current Occupational Safety and Health Administration (OSHA) permissible exposure limit (PEL) for chlorine is 1 ppm (3 milligrams per cubic meter (mg/m<sup>3</sup>)) as a ceiling limit. A worker's exposure to chlorine shall at no time exceed this ceiling level. \* IDLH 10 PPM

Physical and chemical properties of chlorine: A yellowish green, nonflammable and liquefied gas with an unpleasant and irritating smell. Can be readily compressed into a clear, amber-colored liquid, it is a noncombustible gas, and a strong oxidizer.

Liquid chlorine is about 1.5 times heavier than water and gaseous chlorine is about 2.5 times heavier than air. Atomic number of chlorine is 17. Cl is the elemental symbol and Cl<sub>2</sub> is the chemical formula.

Monochloramine, dichloramine, and trichloramine are also known as Combined Available Chlorine. Cl<sub>2</sub> + NH<sub>4</sub>.

HOCl and OCl<sup>-</sup>; The **OCL<sup>-</sup>** is the hypochlorite ion and both of these species are known as free available chlorine. These are the two main chemical species formed by chlorine in water and they are known collectively as hypochlorous acid and the hypochlorite ion.

When chlorine gas is added to water, it rapidly hydrolyzes. The chemical equation that best describes this reaction is **Cl<sub>2</sub> + H<sub>2</sub>O --> H<sup>+</sup> + Cl<sup>-</sup> + HOCl**. Hypochlorous acid is the most germicidal of the chlorine compounds with the possible exception of chlorine dioxide.

Yoke-type connectors should be used on a chlorine cylinder's valve, as a safer connection in case the threads on the valve may be worn.

The connection from a chlorine cylinder to a chlorinator should be made by using a new, approved gasket on the connector every time. Always follow your manufacturer's instructions.

On 1-ton chlorine gas containers, the chlorine pressure reducing valve should be located downstream of the evaporator when using an evaporator. This is the liquid chlorine supply line and it is going to be made into chlorine gas.

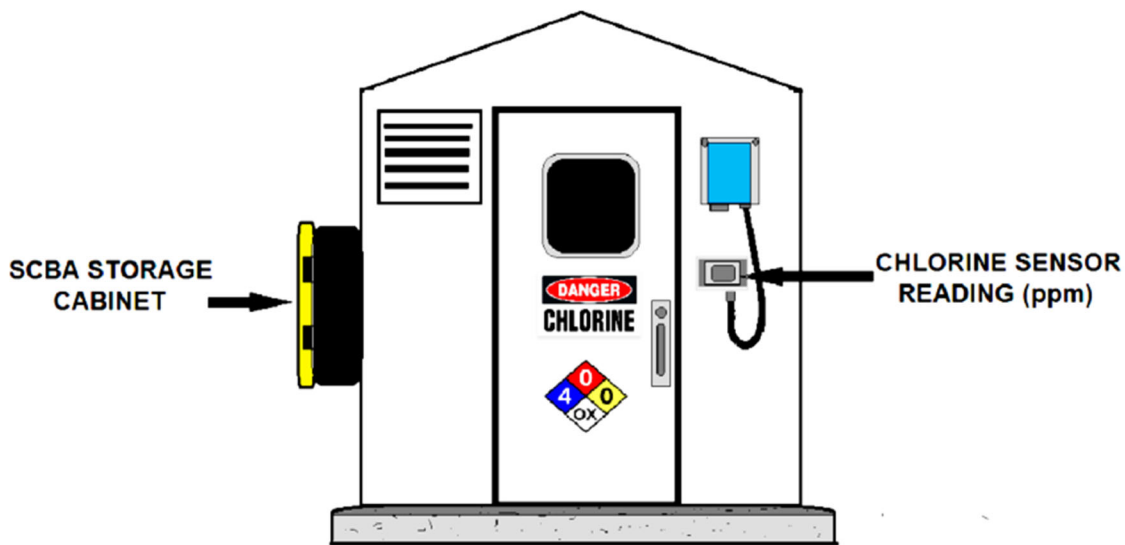
In water treatment, chlorine is added to the effluent before the contact chamber (before the clear well) for complete mixing. One reason for not adding it directly to the chamber is that the chamber has very little mixing due to low velocities.

Here are several safety precautions when using chlorine gas. In addition to protective clothing and goggles, chlorine gas should be used only in a well-ventilated area so that any leaking gas cannot concentrate.

Emergency procedures in the case of a large uncontrolled chlorine leak are as follows: Notify local emergency response team, warn and evacuate people in adjacent areas, and be sure that no one enters the leak area without adequate self-contained breathing equipment.

Here are several symptoms of chlorine exposure. Burning of eyes, nose, and mouth, coughing, sneezing, choking, nausea and vomiting, headaches and dizziness, fatal pulmonary edema, pneumonia, skin blisters and a little  $\text{Cl}_2$  will corrode the teeth and then progress to throat cancer.

Approved method for storing a 150 - 200-pound chlorine cylinder: Secure each cylinder in an upright position, attach the protective bonnet over the valve and firmly secure each cylinder. Never store near heat. Always store the empty in an upright, secure position with proper signage.



**FIBERGLASS CHLORINE STORAGE SHELTER**

### **Operator and Public Safety**

The design of gas chlorine facilities should consider operator and public safety as well as maintaining long-term plant reliability and operation.

Chlorination facilities are designed such that chlorine gas can be contained in the chlorine storage room. Doors and windows should be gas-tight to minimize escape of gaseous chlorine to the exterior atmosphere or building interior.

Leak detectors should be located 1 foot above the floor of the chlorine storage room and should activate an alarm when a chlorine leak occurs. It is preferable that the detector be capable of differentiating between two or more chlorine concentrations to alert personnel of the severity of the release. This would help determine the appropriate procedure for entrance to the room, ventilation, or other solutions.

Self-contained breathing apparatus (SCBA) should not be located within the chlorine storage room. It is preferable that this equipment be located in a convenient location where personnel can easily access it in the event of an emergency.

## Chlorine Section Post Quiz

1. How should the connection from a chlorine cylinder to a chlorinator be replaced?
2. How many turns should a chlorine gas cylinder be initially opened?
3. If the temperature of a full chlorine cylinder is increased by 50°F or 30°C, what is the most likely result?
4. What is meant by the specific gravity of a liquid?
5. Which metals are the only metals that are **TOTALLY** inert to moist chlorine gas?
6. What will be discharged when opening the top valve on a one-ton chlorine cylinder?
7. What are the approved methods for storing a chlorine cylinder?
8. What are normal conditions for a gas chlorination start-up?
9. Name a safety precaution when using chlorine gas?
10. What compounds are formed in water when chlorine gas is introduced?
11. Why should roller bearings not be used to rotate a one-ton chlorine cylinder?
12. What are the physical and chemical properties of chlorine?
13. What are the necessary emergency procedures in the case of a large uncontrolled chlorine leak?

14. Name several symptoms of chlorine exposure.

15. 5 lbs. of a 70% concentration sodium hypochlorite solution is added to a tank containing 650 gallons of water. What is the chlorine dosage?

16. As soon as  $\text{Cl}_2$  gas enters the throat area, a victim will sense a sudden stricture in this area - nature's way of signaling to prevent passage of the gas to the lungs. At this point, the victim must attempt to do two things. Name them.

17. Positive pressure SCBAs and full face piece SARs can be used in oxygen deficient atmospheres containing less than what percentage of oxygen in the atmosphere?

18. Death is possible from asphyxia, shock, reflex spasm in the larynx, or massive pulmonary edema. Populations at special risk from chlorine exposure are individuals with pulmonary disease, breathing problems, bronchitis, or chronic lung conditions.

A. TRUE      B. FALSE

19. Chlorine gas reacts with water producing a strongly oxidizing solution causing damage to the moist tissue lining the respiratory tract when the tissue is exposed to chlorine. The respiratory tract is rapidly irritated by exposure to 10-20 ppm of chlorine gas in air, causing acute discomfort that warns of the presence of the toxicant.

A. TRUE      B. FALSE

20. Even brief exposure to 1,000 ppm of  $\text{Cl}_2$  can be fatal.

A. TRUE      B. FALSE

21. What are the two main chemical species formed by chlorine in water and what name are they are known collectively as?

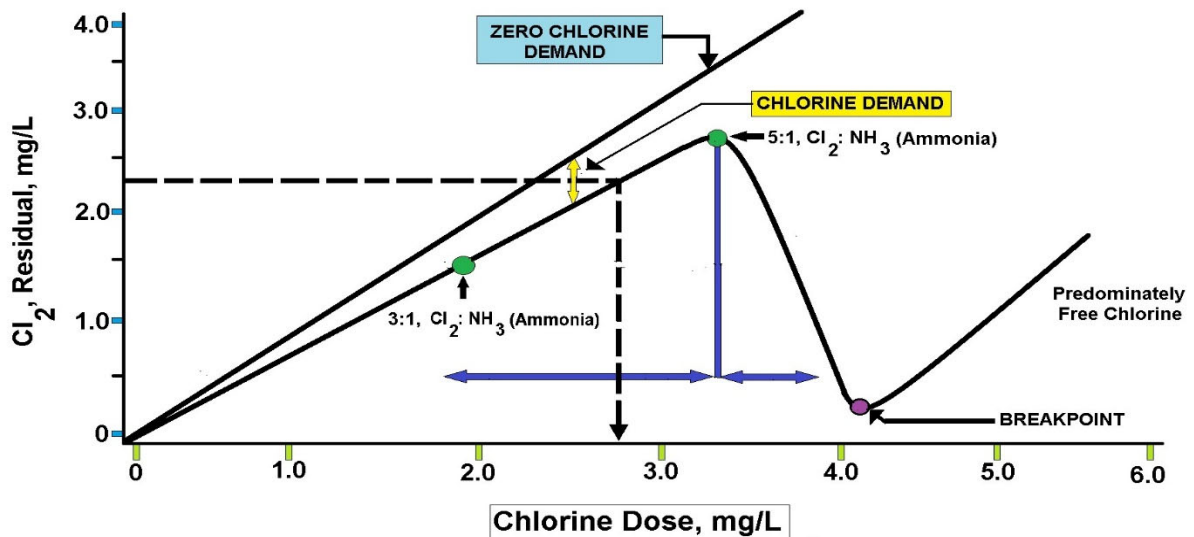
22. When chlorine gas is added to water, it rapidly hydrolyzes according to the reaction:



## Chapter 5- Hypochlorites and Chloramines

**Section Focus:** You will learn the basics of water disinfection with an emphasis on hypochlorites, and chloramines. At the end of this section, you will be able to describe disinfection using hypochlorites and chloramines. There is a post quiz at the end of this section to review your comprehension and a final examination in the Assignment for your contact hours.

**Scope/Background:** Chloramines - Sodium or Calcium hypochlorite is a diluted liquid form of chlorine that is also commonly used for disinfection.



### CHLORAMINATION

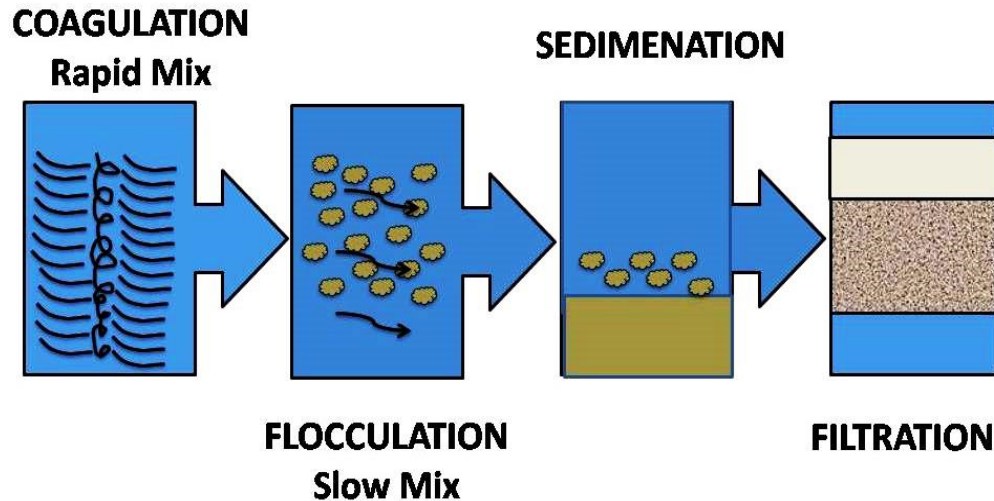
## Reviewing Chloramines in Drinking Water

Chloramines are disinfectants used to treat drinking water. Chloramines are most commonly formed when ammonia is added to chlorine to treat drinking water. The typical purpose of chloramines is to provide longer-lasting water treatment as the water moves through pipes to consumers. This type of disinfection is known as secondary disinfection. Chloramines have been used by water utilities for almost 90 years, and their use is closely regulated. More than one in five Americans uses drinking water treated with chloramines. Water that contains chloramines and meets EPA regulatory standards is safe to use for drinking, cooking, bathing and other household uses.

Many utilities use chlorine as their secondary disinfectant; however, in recent years, some of them changed their secondary disinfectant to chloramines to meet disinfection byproduct regulations. In order to address questions that have been raised by consumers about this switch, EPA scientists and experts have answered 29 of the most frequently asked questions about chloramines. We have also worked with a risk communication expert to help us organize complex information and make it easier for us to express current knowledge.

## Water Treatment

The following is a schematic of a water treatment plant.



In water treatment, pre-chlorination is utilized mainly in situations where the inflow is taken from a surface water source such as a river, lake, or reservoir.

Chlorine is usually added in the rapid mixing chamber and effectively prevents the majority of algal growth.

Algae is a problem in water treatment plants because it builds up on the filter media and increases the head which means that the filters need to be backwashed more frequently. In addition, the algal growth on the filter media causes taste and odor problems in the treated water.

### Post Chlorination

Post chlorination is almost always done in water treatment, but can be replaced with chlorine dioxide or chloramines. In this stage chlorine is fed to the drinking water stream which is then sent to the chlorine contact basin to allow the chlorine a long enough detention time to kill all viruses, bacteria, and protozoa that were not removed and rendered inactive in the prior stages of treatment.

Drinking water requires a large addition of chlorine because there must be a residual amount of chlorine in the water that will carry through the system until it reaches the tap of the user. After post chlorination, the water is retained in a clear well prior to distribution.

## Chloramine Sub-Section

This process involves the addition of ammonia and chlorine compounds to a water filtration plant. When properly controlled, the mixture forms chloramines. They are commonly used to maintain a residual in the distribution system following treatment with a stronger disinfectant, such as free chlorine.

### Chloramine Advantages

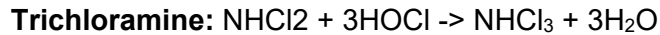
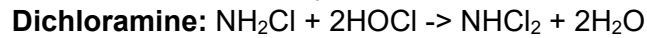
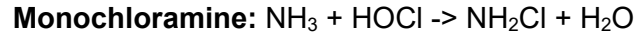
- Persistent residual.
- Taste and odor minimization.
- Lower levels of trihalomethane (THM) and haloacetic acid (HAA) formation.
- Effective disinfection of biofilms in the distribution system.

### Chloramine Disadvantages

- Produces disinfection by-products (DBPs), including nitrogen-based compounds and chloral hydrate, which may be regulated as a DBP in the future. There is limited information on the toxicity of chloramine DBPs. In an analysis of the health effects of alternatives, Bull states that "there is little information on which to base an estimate of the health hazard that chloramine poses."
- Presents problems to individuals on dialysis machines. Chloramine residuals in tap water can pass through membranes in dialysis machines and directly induce oxidant damage to red blood cells.
- Causes eye irritation. Exposure to high levels of chloramine may result in eye irritation.
- Requires increased dosage and contact time (higher CT values, *i.e.*, concentration X time).
- Has questionable value as viral and parasitic biocide.
- Can promote growth of algae in reservoirs and an increase in distribution system bacteria due to residual ammonia.
- Can produce HAAs.
- Provides weaker oxidation and disinfection capabilities than free chlorine.

## Chloramine Breakdown

Monochloramine and dichloramine are formed in the pH range of 4.5 to 8.5, however, monochloramine is most common when the pH is above 8. When the pH of the water is below 4.5, the most common form of chloramine is trichloramine which produces a very foul odor. The equations for the formation of the different chloramines are as follows: (Reynolds & Richards, 1996)



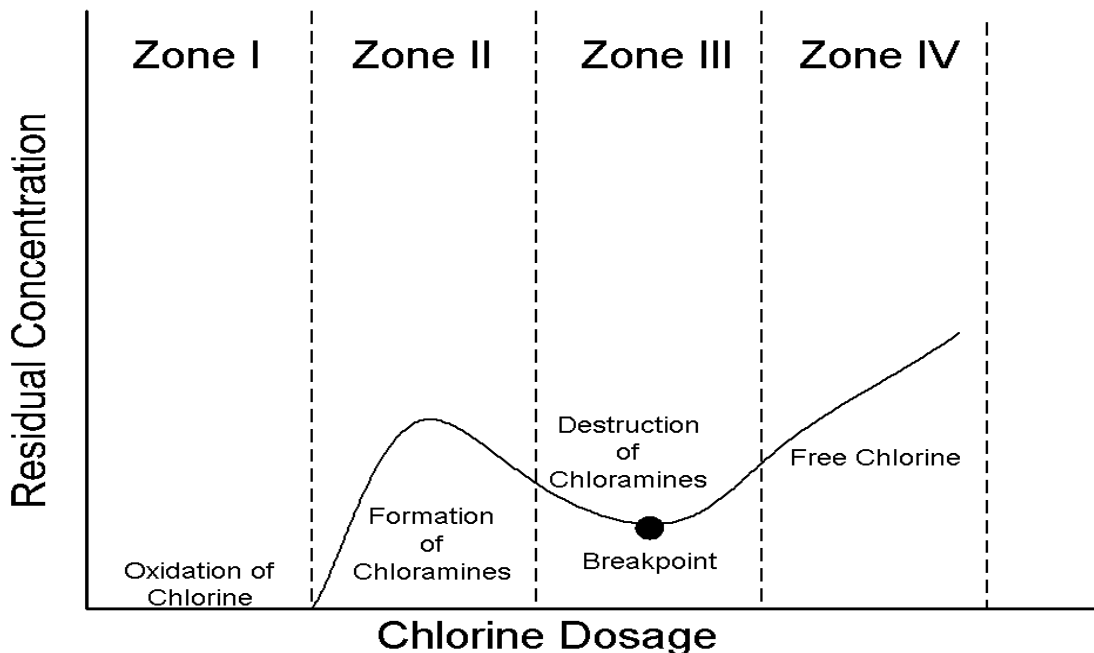
Chloramines are an effective disinfectant against bacteria but not against viruses. As a result, it is necessary to add more chlorine to the water to prevent the formation of chloramines and form other stronger forms of disinfectants.

The final step is that additional free chlorine reacts with the chloramine to produce hydrogen ion, water, and nitrogen gas which will come out of solution. In the case of the monochloramine, the following reaction occurs:



Thus, added free chlorine reduces the concentration of chloramines in the disinfection process. Instead the chlorine that is added is allowed to form the stronger disinfectant, hypochlorous acid.

Perhaps the most important stage of the water or wastewater treatment process is the disinfection stage. This stage is most critical because it has the greatest effect on public health as well as the health of the world's aquatic systems. It is important to realize that water or wastewater treatment is not a cut and dry process but requires in depth knowledge about the type of wastewater being treated and its characteristics to obtain optimum results.



The graph shown depicts the chlorine residual as a function of increasing chlorine dosage with descriptions of each zone given below (Drawing by Erik Johnston, adapted from Reynolds and Richards, 1996).

**Zone I:** Chlorine is reduced to chlorides.

**Zone II:** Chloramines are formed.

**Zone III:** Chloramines are broken down and converted to nitrogen gas which leaves the system (Breakpoint).

**Zone IV:** Free residual.

Therefore, it is very important to understand the amount and type of chlorine that must be added to overcome the difficulties in the strength of the disinfectant which results from the water or wastewater's characteristics.



## Sodium Hypochlorite - Introduction

CHEMICAL NAME	CHEMICAL FORMULA	FORM	% CHLORINE	STORAGE	QUALITY	ADVANTAGE	DISADVANTAGE
CHLORINE GAS	Cl <sub>2</sub>	GAS	100%	MAY STORE FOR LONG PERIODS	CONSISTENTLY HIGH QUALITY	COST EFFECTIVE	BY-PRODUCT FORMATIONS (THM'S, HAA)
SODIUM HYPOCHLORITE	NaOCl	LIQUID	~ 12%	LIMITED DUE TO DECOMPOSITION	POOR QUALITY DUE TO LIMITED CONTROL	LESS TRAINING REQUIRED TO HANDLE DUE TO FEWER REGULATIONS	LIMITED SHELF LIFE AND HIGHER COST

### CHLORINE GAS VS. SODIUM HYPOCHLORITE (BLEACH)

**Physical Properties** - Sodium Hypochlorite

**Description:** Clear greenish yellow liquid.

**Warning properties:** Chlorine odor; inadequate warning of hazardous concentrations.

**Molecular weight:** 74.44 daltons

**Boiling point** (760 mm Hg): Decomposes above 40°C (HSDB 2001)

**Freezing point:** 6°C (21°F)

**Specific gravity:** 1.21 (14% NaOCl solution) (water=1)

**Water solubility:** 29.3 g/100 g at 32°F (0°C)

**Flammability:** Not flammable

#### Alternative Names

Bleach; Clorox; Carrel-Dakin solution

#### Incompatibilities

Calcium or sodium hypochlorite react explosively or form explosive compounds with many common substances such as ammonia, amines, charcoal, or organic sulfides

#### Introduction

The world's most universal and reliable means of water and wastewater disinfection is chlorination. Two fundamental methods include gas chlorination (Cl<sub>2</sub>) and liquid chlorination (NaOCl) otherwise known as Sodium Hypochlorite. Sodium hypochlorite (NaOCl) is a solution made from reacting chlorine with a sodium hydroxide solution. These two reactants are the major co-products from most chlor-alkali cells. Sodium hypochlorite has a variety of uses and is an excellent disinfectant/antimicrobial agent. Sodium hypochlorite also significantly increases the pH of the water. When sodium hypochlorite is used, it must be counterbalanced by a strong acid like sodium bisulfate or muriatic acid to keep the pH within the ideal range.

The hypochlorite form of chlorine has been used since 1850. The most widely used form of hypochlorite is the liquid, sodium hypochlorite (NaOCl), with more than 150 tons per day consumed in the United States.

Sodium hypochlorite application in cooling water is essentially the same as with gas chlorine; HOCl is produced as the active toxicant. The HOCl is equally susceptible to process contamination, has the same chlorine demand as gas chlorine and displays the same tendency to dissociate.

Sodium hypochlorite differs from chlorine gas in two respects: method of feed and hydrolyzation properties. Sodium hypochlorite can either be gravity-fed or applied with a metering pump. The latter is generally recognized as a consistently more accurate method. The second difference, in hydrolysis, lies in the end products. The NaOCl reaction with water liberates sodium hydroxide (NaOH).

The addition of NaOH differs in that it tends to add alkalinity to the water. In large concentrations it may artificially elevate pH, leading to precipitation of calcium carbonate. While NaOCl eliminates low pH corrosion as a concern, the use of large quantities in contaminated systems still introduces a high concentration of the chloride ion, which can be very aggressive to cooling system metals. Many of the other problems associated with chlorine remain present with sodium hypochlorite.

### **When was Sodium Hypochlorite Discovered?**

Sodium hypochlorite has a long history. Around 1785 the Frenchman Berthollet developed liquid bleaching agents based on sodium hypochlorite. The Javel company introduced this product and called it 'liqueur de Javel'. At first, it was used to bleach cotton. Because of its specific characteristics it soon became a popular compound. Hypochlorite can remove stains from clothes at room temperature. In France, sodium hypochlorite is still known as 'eau de Javel'.

### **Characteristics of Sodium hypochlorite**

Sodium hypochlorite is a clear, slightly yellowish solution with a characteristic odor.

Sodium hypochlorite has a relative density of is 1.1 (5.5% watery solution).

As a bleaching agent for domestic use it usually contains 5% sodium hypochlorite (with a pH of around 11, it is irritating). If it is more concentrated, it contains a concentration 10-15% sodium hypochlorite (with a pH of around 13, it burns and is corrosive).

Sodium hypochlorite is unstable. Chlorine evaporates at a rate of 0,75 gram active chlorine per day from the solution. Then heated sodium hypochlorite disintegrates. This also happens when sodium hypochlorite comes in contact with acids, sunlight, certain metals and poisonous and corrosive gasses, including chlorine gas. Sodium hypochlorite is a strong oxidator and reacts with flammable compounds and reductors. Sodium hypochlorite solution is a weak base that is inflammable. These characteristics must be kept in mind during transport, storage and use of sodium hypochlorite.

### **pH value When Sodium Hypochlorite is Added to Water**

Due to the presence of caustic soda in sodium hypochlorite, the pH of the water is increased. When sodium hypochlorite dissolves in water, two substances form, which play a role in oxidation and disinfection. These are hypochlorous acid (HOCl) and the less active hypochlorite ion (OCl<sup>-</sup>). The pH of the water determines how much hypochlorous acid is formed. While sodium hypochlorite is used, hydrochloric (HCl) is used to lower the pH. Sulfuric acid (H<sub>2</sub>SO<sub>4</sub>) can be used as an alternative for acetic acid. Less harmful gasses are produced when sulfuric acid is used. Sulfuric acid is a strong acid that strongly reacts with bases and is very corrosive.



### **How Can Sodium Hypochlorite be produced?**

Sodium hypochlorite can be produced in two ways:

- By dissolving salt in softened water, which results in a concentrated brine solution. The solution is electrolyzed and forms a sodium hypochlorite solution in water. This solution contains 150 g active chlorine (Cl<sub>2</sub>) per liter. During this reaction the explosive hydrogen gas is also formed.
- By adding chlorine gas (Cl<sub>2</sub>) to caustic soda (NaOH). When this is done, sodium hypochlorite, water (H<sub>2</sub>O) and salt (NaCl) are produced according to the following reaction:



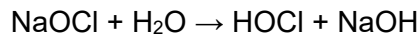
### **Applications of Sodium Hypochlorite**

Sodium hypochlorite is used on a large scale; for example agriculture, chemical industries, paint- and lime industries, food industries, glass industries, paper industries, pharmaceutical industries, synthetics industries and waste disposal industries all use it. In the textile industry sodium hypochlorite is used to bleach textile. It is sometimes added to industrial waste water--this is done to reduce odors.

Hypochlorite neutralizes sulfur hydrogen gas (SH) and ammonia (NH<sub>3</sub>). It is also used to detoxify cyanide baths in metal industries. Hypochlorite can be used to prevent algae and shellfish growth in cooling towers. In water treatment, hypochlorite is used to disinfect water. In households, hypochlorite is used frequently for the purification and disinfection of the house.

### **How does Sodium Hypochlorite Disinfection Work?**

By adding hypochlorite to water, hypochlorous acid (HOCl) is formed:



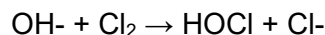
Hypochlorous acid is divided into hydrochloric acid (HCl) and oxygen (O). The oxygen atom is a very strong oxidant.

Sodium hypochlorite is effective against bacteria, viruses and fungi. Sodium hypochlorite disinfects the same way as chlorine does.

There are various ways to use sodium hypochlorite. For on-site salt electrolysis, a solution of salt (NaCl) in water is applied. Sodium (Na<sup>+</sup>) and chloride (Cl<sup>-</sup>) ions are produced.



Subsequently, chlorine and hydroxide react to form hypochlorite:



### **Salt Electrolysis System**

The advantage of the salt electrolysis system is that no transport or storage of sodium hypochlorite is required. When sodium hypochlorite is stored for a long time, it becomes inactive. Another advantage of the onsite process is that chlorine lowers the pH and no other acid is required to lower pH.

The hydrogen gas that is produced is explosive and as a result ventilation is required for explosion prevention. This system is slow and a buffer of extra hypochlorous acid needs to be used. The maintenance and purchase of the electrolysis system is much more expensive than sodium hypochlorite.

When sodium hypochlorite is used, acetic or sulfuric acid are added to the water. An overdose can produce poisonous gasses. If the dosage is too low, the pH becomes too high and can irritate the eyes.

Because sodium hypochlorite is used both to oxidize pollutants (urine, sweat, cosmetics) and to remove pathogenic microorganisms, the required concentration of sodium hypochlorite depends on the concentrations of these pollutants. Especially the amount of organic pollutants helps determine the required concentration. If the water is filtered before sodium hypochlorite is applied, less sodium hypochlorite is needed.

### Theory

Disinfection with chlorine is very popular in water and wastewater treatment because of its low cost, ability to form a residual, and its effectiveness at low concentrations. Although it is used as a disinfectant, it is a dangerous and potentially fatal chemical if used improperly.

Despite the fact the disinfection process may seem simple, it is actually a quite complicated process. Chlorination in wastewater treatment systems is a fairly complex science which requires knowledge of the plant's effluent characteristics.

When free chlorine is added to the water, it takes on various forms depending on the pH of the wastewater. It is important to understand the forms of chlorine which are present because each has a different disinfecting capability. The acid form, HOCL, is a much stronger disinfectant than the hypochlorite ion, OCL<sup>-</sup>.

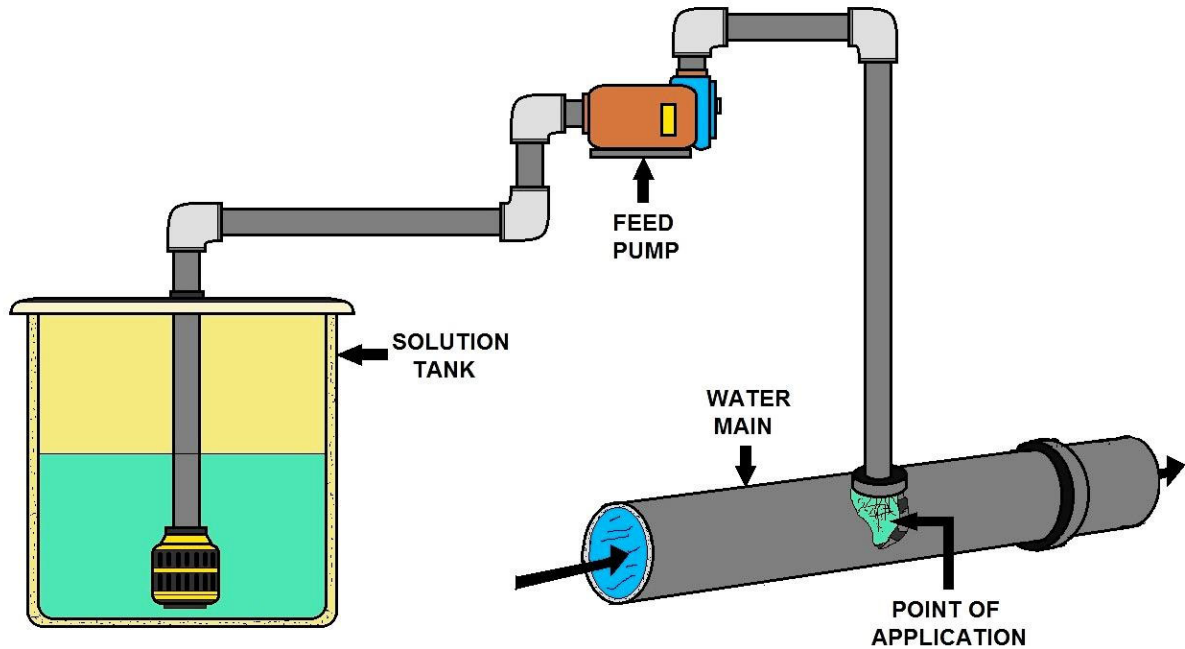
Ammonia present in the effluent can also cause problems as chloramines are formed, which have very little disinfecting power. Some methods to overcome the types of chlorine formed are to adjust the pH of the water prior to chlorination or to simply add a larger amount of chlorine. An adjustment in the pH would allow the operators to form the most desired form of chlorine, hypochlorous acid, which has the greatest disinfecting power.

Adding larger amounts of chlorine would be an excellent method to combat the chloramines because the ammonia present would bond to the chlorine but further addition of chlorine would stay in the hypochlorous acid or hypochlorite ion state.

- a) Chlorine gas, when exposed to water reacts readily to form hypochlorous acid, HOCl, and hydrochloric acid.  $\text{Cl}_2 + \text{H}_2\text{O} \rightarrow \text{HOCl} + \text{HCl}$
- b) If the pH of the water is greater than 8, the hypochlorous acid will dissociate to yield hypochlorite ion.  $\text{HOCl} \leftrightarrow \text{H}^+ + \text{OCl}^-$  If however, the pH is much less than 7, and then HOCl will not dissociate.
- c) If ammonia is present in the wastewater effluent, then the hypochlorous acid will react to form one three types of chloramines depending on the pH, temperature, and reaction time.

# Sodium Hypochlorite Solutions

## Recommendations for Preparing/Handling/Feeding



### SODIUM HYPOCHLORITE FEEDING

As a result of the pressures brought to bear by Health and Safety requirements, some users of gas have chosen to seek alternative forms of disinfectants for their water and wastewater treatment plants. One of these alternative forms is sodium hypochlorite (**NaOCl**). This is often purchased commercially at 10 to 15% strength.

The handling and storage of NaOCl presents the plant with a new and sometimes unfamiliar, set of equipment installation configurations and operating conditions.

**Product Stability** The oxidizing nature of this substance means that it should be handled with extreme care. As NaOCl is relatively unstable, it degrades over time.

#### There are Three Ways in Which NaOCl Solutions Degrade

- Chlorate-forming reaction due to age, temperature, light and minor reduction in pH.
- Oxygen-producing reaction that occurs when metals, such as iron, copper or nickel, or metal oxides are brought into contact with the solution.
- Chlorine-producing reaction when solution pH falls below 6.

#### There are Many Factors that Affect the Stability of a NaOCl Solution

- Initial solution strength.
- pH solution.
- Temperature of the solution.
- Exposure of the solution to sunlight.

## Exposure

There is no threshold value for to sodium hypochlorite exposure. Various health effects occur after exposure to sodium hypochlorite. People are exposed to sodium hypochlorite by inhalation of aerosols. This causes coughing and a sore throat. After swallowing sodium hypochlorite the effects are stomach ache, a burning sensation, coughing, diarrhea, a sore throat and vomiting. Sodium hypochlorite on skin or eyes causes redness and pain. After prolonged exposure, the skin can become sensitive. Sodium hypochlorite is poisonous for water organisms. It is mutagenic and very toxic when it comes in contact with ammonium salts.

## **Routes of Exposure**

### **Inhalation**

Hypochlorite solutions can liberate toxic gases such as chlorine. Chlorine's odor or irritant properties generally provide adequate warning of hazardous concentrations. However, prolonged, low-level exposures, such as those that occur in the workplace, can lead to olfactory fatigue and tolerance of chlorine's irritant effects.

Chlorine is heavier than air and may cause asphyxiation in poorly ventilated, enclosed, or low-lying areas. Children exposed to the same levels of gases as adults may receive a larger dose because they have greater lung surface area/body weight ratios and higher minute volumes/weight ratios. Children may be more vulnerable to corrosive agents than adults because of the smaller diameter of their airways. In addition, they may be exposed to higher levels than adults in the same location because of their short stature and the higher levels of chlorine found nearer to the ground.

### **Skin/Eye Contact**

Direct contact with hypochlorite solutions, powder, or concentrated vapor causes severe chemical burns, leading to cell death and ulceration. Because of their relatively larger surface area/weight ratio, children are more vulnerable to toxicants affecting the skin.

### **Ingestion**

Ingestion of hypochlorite solutions causes vomiting and corrosive injury to the gastrointestinal tract. Household bleaches (3 to 6% sodium hypochlorite) usually cause esophageal irritation, but rarely cause strictures or serious injury such as perforation. Commercial bleaches may contain higher concentrations of sodium hypochlorite and are more likely to cause serious injury. Metabolic acidosis is rare, but has been reported following the ingestion of household bleach. Pulmonary complications resulting from aspiration may also be seen after ingestion.

### **Sources/Uses**

Sodium and calcium hypochlorite are manufactured by the chlorination of sodium hydroxide or lime. Sodium and calcium hypochlorite are used primarily as oxidizing and bleaching agents or disinfectants. They are components of commercial bleaches, cleaning solutions, and disinfectants for drinking water and waste water purification systems and swimming pools.

### **Sodium Hypochlorite as a Disinfectant has the Following Advantages:**

It can be easily stored and transported when it is produced on-site. Dosage is simple; transport and storage of sodium hypochlorite are safe. Sodium hypochlorite is as effective as chlorine gas for disinfection. Sodium hypochlorite produces residual disinfectant.

## **Disadvantages**

Sodium hypochlorite is a dangerous and corrosive substance. While working with sodium hypochlorite, safety measures have to be taken to protect workers and the environment. Sodium hypochlorite should not come in contact with air, because that will cause it to disintegrate. Both sodium hypochlorite and chlorine do not deactivate *Giardia Lambia* and *Cryptosporidium*. The regulation for sodium hypochlorite is the same as the regulation considering chlorine. Household bleaches usually contain sodium hypochlorite in a 3% to 6% solution. Some sodium hydroxide (lye) is added to keep the pH high to avoid decomposition. If the solution is made more acidic, sodium hypochlorite will dissociate, producing chlorine gas and oxygen. It is made by bubbling chlorine gas through a solution of sodium hydroxide. In the environment, it breaks down into water, oxygen, and table salt.

## **Conditions that tend to increase gassing in Sodium Hypochlorite Solutions are:**

- \* Elevated temperatures
- \* High concentration solution
- \* Exposure to sunlight or UV rays
- \* Reduction in pressure
- \* Cavitation
- \* Poor piping conditions
- \* Contact with metallic impurities
- \* Contact with organic impurities
- \* Age of solution
- \* Quality of solution

## **Reciprocating Piston Metering Pumps**

When handling sodium hypochlorite and acids, be certain to wear gloves and a face shield for protection. Sodium hypochlorite is introduced to treated water by a chemical feeder (pump.) Chemical feeders tend to clog often, so it's important to clean the feeder regularly. Sodium Hypochlorite is subject to degradation within the piping and pump systems as it releases oxygen gas and results in crystallization of the residual. If the oxygen gas or vapor is allowed to build up within the piping and reagent head in sufficient volume, a typical reciprocating piston metering pump, used for accurately feeding chlorine to the process, will not function properly as gas in the pump head is compressed, minimizing the discharge check valve to open upon discharge stroke of the pump.

Consequently, this effect could require that the pump be re-primed for operation. Reciprocating piston metering pumps or diaphragm metering pumps have been historically preferred in the dispensing of Sodium Hypochlorite because of their superior ability to accurately dose chemicals into a process stream with great precision and repeatability at a constant pressure. Additionally, the diaphragm metering pump is sealless and leak proof by design with negligible maintenance and simple commissioning.

Traditionally, the diaphragm metering pump industry has promoted the use of degas valves on the discharge port of the pump which diverts gas back to the suction supply source of the bleach. This method has been widely accepted and successful in many applications. However, the small diameter ports in the valve system tend to plug and require continuous flushing or cleaning through human intervention since the system is open to atmosphere on the discharge side of the orifice. Additionally, an external bypass piping system and degas valve assembly require additional costs and maintenance while presenting more opportunities for undesired chlorine leak paths.

**USING 5.25 - 8.25 % CHLORINE (HOUSEHOLD BLEACH)  
TO TREAT WATER**

<b>VOLUME OF WATER TO BE TREATED</b>	<b>BLEACH SOLUTION TO BE ADDED</b>
<b>1 QUART / 1 LITER</b>	<b>5 DROPS</b>
<b>1/2 GALLON / 2 QUARTS / 2 LITERS</b>	<b>10 DROPS</b>
<b>1 GALLON</b>	<b>1/4 TEASPOON</b>
<b>5 GALLONS</b>	<b>1 TEASPOON</b>
<b>10 GALLONS</b>	<b>2 TEASPOONS</b>

**USING HOUSEHOLD BLEACH TO TREAT WATER**

# Troubleshooting Hypochlorination Problems

## Problem

1. Chemical feed pump won't run.
2. Low chlorine residual at POE.
2. Low chlorine residual at POE.
3. Chemical feed pump won't prime.
4. Loss of prime

## Possible Causes

- 1A. No power.
- 1B. Electrical problem with signal from well pump or flow sensor.
- 1C. Motor failure.
- 2A. Improper procedure for running chlorine residual test or expired chemical reagents.
- 2B. Pump not feeding an adequate quantity of chlorine.
- 2C. Change in raw water quality.
- 2D. Pump **air bound**.
- 2E. Chlorine supply tank empty.
- 2F. Reduced effectiveness of chlorine solution.
- 2G. Damaged suction or discharge lines. (cracks or crimps)
- 2H. Connection at point of **injection** clogged or leaking.
- 3A. Speed and stroke setting inadequate.
- 3B. Suction lift too high due to feed pump relocation.
- 3C. Discharge pressure too high.
- 3D. Suction fitting clogged.
- 3E. Trapped air in suction line.
- 3F. Suction line not submerged in solution.
- 4A. Solution tank empty.
- 4B. Air leaks in suction fittings.
- 4C. Foot valve not in vertical position.
- 4D. Air trapped in suction tubing.

## Possible Solutions

- 1A. Check to see if plug is securely in place.  
Insure that there is power to the outlet and control systems.
- 1B. Check pump motor starter. Bypass flow sensor to determine if pump will operate manually.
- 1C. Check manufacturer's information.
- 2A Check expiration date on **chemical reagents**. Check test procedure as described in test kit manual. Speed or stroke setting too low.
- 2B. Damaged **diaphragm** or suction leak.
- 2C. Test raw water for constituents that may cause increased chlorine demand. (i.e. iron, manganese, etc.)
- 2D. Check foot valve.
- 2E. Fill supply tank.
- 2F. Check date that chlorine was received. Sodium hypochlorite solution may lose effectiveness after 30 days. If that is the case, the feed rate must be increased to obtain the desired residual.
- 2G. Clean or repair lines with problems.
- 2H. Flush line and connection with mild acid such as **Acetic** or **Muriatic**. Replace any damaged parts that may be leaking.
- 3A. Check manufacturers' recommendations for proper settings to prime pump.

- 3B. Check maximum suction lift for pump and relocate as necessary.
- 3C. Check well pump discharge pressure.  
Check pressure rating on chemical feed pump.
- 3D. Clean or replace screen.
- 3E. Insure all fittings are tight.
- 3F. Add chlorine solution to supply tank.
- 4A. Fill tank.
- 4B. Check for cracked fittings.
- 4C. Adjust foot valve to proper position.
- 4D. Check connections and fittings.



Small chlorine solution tank, normally found on small wells or post-chlorination areas in the distribution system



## Shock Chlorination — Simple Well Maintenance- Small Example

Shock chlorination is a relatively inexpensive and straightforward procedure used to control bacteria in water wells. Many types of bacteria can contaminate wells, but the most common are iron and sulfate-reducing bacteria.

Although not a cause of health problems in humans, bacteria growth will coat the inside of the well casing, water piping and pumping equipment, creating problems such as:

- Reduced well yield
- Restricted water flow in distribution lines
- Staining of plumbing fixtures and laundry
- Plugging of water treatment equipment
- “Rotten egg” odor.

Bacteria may be introduced during drilling of a well or when pumps are removed for repair and laid on the ground. However, iron and sulfate-reducing bacteria (as well as other bacteria) can exist naturally in groundwater.

A well creates a direct path for oxygen to travel into the ground where it would not normally exist. When a well is pumped, the water flowing in will also bring in nutrients that enhance bacterial growth.

**Note:** All iron staining problems are not necessarily caused by iron bacteria. The iron naturally present in the water can be the cause.

### Ideal Conditions for Iron Bacteria

Water wells provide ideal conditions for iron bacteria. To thrive, iron bacteria require 0.5-4 mg/L of dissolved oxygen, as little as 0.01 mg/L dissolved iron and a temperature range of 5 to 15°C. Some iron bacteria use dissolved iron in the water as a food source.

### Signs of Iron and Sulfate-Reducing Bacteria

There are a number of signs that indicate the presence of iron and sulfate-reducing bacteria. They include:

- Slime growth
- Rotten egg odor
- Increased staining.

### Slime Growth

The easiest way to check a well and water system for iron bacteria is to examine the inside surface of the toilet flush tank. If you see a greasy slime or growth, iron bacteria are probably present. Iron bacteria leave this slimy by-product on almost every surface the water is in contact with.

### Rotten Egg Odor

Sulfate-reducing bacteria can cause a rotten egg odor in water. Iron bacteria aggravate the problem by creating an environment that encourages the growth of sulfate-reducing bacteria in the well. Sulfate-reducing bacteria prefer to live underneath the slime layer that the iron bacteria form.



Some of these bacteria produce hydrogen sulfide as a by-product, resulting in a “rotten egg” or sulfur odor in the water. Others produce small amounts of sulfuric acid which can corrode the well casing and pumping equipment.

### **Increased Staining Problems**

Iron bacteria can concentrate iron in water sources with low iron content. It can create a staining problem where one never existed before or make an iron staining problem worse as time goes by.

Use the following checklist to determine if you have an iron or sulfate-reducing bacteria problem. The first three are very specific problems related to these bacteria. The last two problems can be signs of other problems as well.

### **Checklist to Determine an Iron or Sulfate-Reducing Bacteria Problem**

- Greasy slime on inside surface of toilet flush tank
- Increased red staining of plumbing fixtures and laundry
- Sulfur odor
- Reduced well yield
- Restricted water flow

### **Mixing a Chlorine Solution**

Add a half gallon of bleach to a clean pail with about 3 gallons of water. This is generally sufficient to disinfect a 4 inch diameter well 100 feet deep or less. For wells greater than 100 feet deep or with a larger casing diameter, increase the amount of bleach proportionately.

If you have a dug well with a diameter greater than 18 inches, use 2 to 4 gallons of bleach added directly to the well. Please note that many dug wells are difficult or impossible to disinfect due to their unsanitary construction.

## **Shock Chlorination — Well Maintenance**

### **Shock Chlorination Method**

Shock chlorination is used to control iron and sulfate-reducing bacteria and to eliminate fecal coliform bacteria in a water system. To be effective, shock chlorination must disinfect the following:

- The entire well depth
- The formation around the bottom of the well
- The pressure system
- Some water treatment equipment
- The distribution system.

To accomplish this, a large volume of super chlorinated water is siphoned down the well to displace all the water in the well and some of the water in the formation around the well.

### **Effectiveness of Shock Chlorination**

With shock chlorination, the entire system (from the water-bearing formation, through the well-bore and the distribution system) is exposed to water which has a concentration of chlorine strong enough to kill iron and sulfate reducing bacteria. Bacteria collect in the pore spaces of the formation and on the casing or screened surface of the well.

To be effective, you must use enough chlorine to disinfect the entire cased section of the well and adjacent water-bearing formation.

The procedure described below does not completely eliminate iron bacteria from the water system, but it will hold it in check.

To control the iron bacteria, you may have to repeat the procedure each spring and fall as a regular maintenance procedure. If your well has never been shock chlorinated or has not been done for some time, it may be necessary to use a stronger chlorine solution, applied two or three times, before you notice a significant improvement in the water.

You might also consider hiring a drilling contractor to thoroughly clean and flush the well before chlorinating in order to remove any buildup on the casing.

In more severe cases, the pump may have to be removed and chemical solutions added to the well and vigorous agitation carried out using special equipment. This is to dislodge and remove the bacterial slime. This should be done by a drilling contractor.

## Shock Chlorination Procedure for Small Drilled Wells

A modified procedure is also provided for large diameter wells.

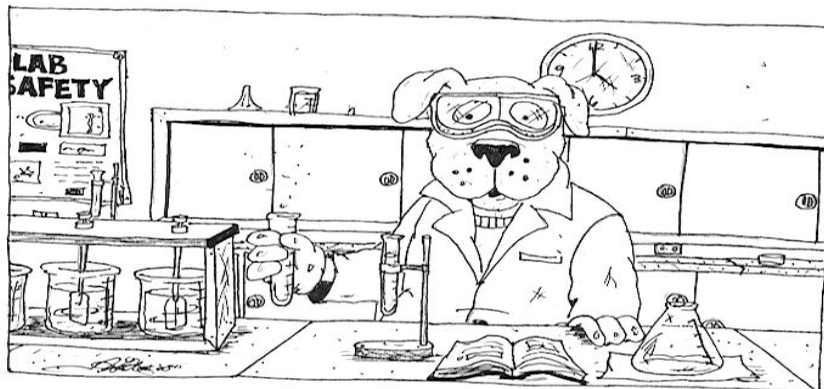
**Caution:** If your well is low yielding or tends to pump any silt or sand, you must be very careful using the following procedure because over pumping may damage the well.

When pumping out the chlorinated solution, monitor the water discharge for sediment.

Follow these steps to shock chlorinate your well.

Store sufficient water to meet farm and family needs for 8 to 48 hours.

Pump the recommended amount of water (see Amount of Chlorine Required to Obtain a Chlorine Concentration of 1000 PPM) into clean storage. A clean galvanized stock tank or pickup truck box lined with a 4 mil thick plastic sheet is suitable. The recommended amount of water to use is twice the volume of water present in the well casing. To measure how much water is in the casing, subtract the non-pumping water level from the total depth of the well.



**12% industrial sodium hypochlorite and 70% high test hypochlorite are available from:**

- Water treatment suppliers
- Drilling contractor
- Swimming pool maintenance suppliers
- Dairy equipment suppliers
- Some hardware stores.

**Amount of Chlorine required to obtain a Chlorine Concentration of 1000 PPM. Since a dry chemical is being used, it should be mixed with water to form a chlorine solution before placing it in the well.**

Calculate the amount of chlorine that is required. Mix the chlorine with the previously measured water to obtain a 1000 ppm chlorine solution.

#### **Calculating Amount of Chlorine Example**

If your casing is 6 in. and you are using 12% industrial sodium hypochlorite, you will require .091 L per ft. of water in the casing. If you have 100 ft. of water in the casing, you will use  $0.091 \text{ L} \times 100 \text{ ft.} = 9.1 \text{ L}$  of 12% chlorine.

Calculate the amount of chlorine you will need for your well.

Casing diameter \_\_\_\_\_ Chlorine strength \_\_\_\_\_

L needed per 1 ft. of water \_\_\_\_\_ x \_\_\_\_\_ ft. of water in casing = \_\_\_\_\_ L of chlorine.

***Caution: Chlorine is corrosive and can even be deadly.***

***If your well is located in a pit, you must make sure there is proper ventilation during the chlorination procedure. Well pits are no longer legal to construct. Use a drilling contractor who has the proper equipment and experience to do the job safely.***

#### **Shock Chlorination — Well Maintenance**

Siphon this solution into the well.

Open each hydrant and faucet in the distribution system (including all appliances that use water such as dishwasher, washing machine, furnace humidifier) until the water coming out has a chlorine odor. This will ensure all the plumbing fixtures are chlorinated.

Allow the hot water tank to fill completely. Consult your water treatment equipment supplier to find out if any part of your water treatment system should be bypassed to prevent damage.

Leave the chlorine solution in the well and distribution system for 8 to 48 hours. The longer the contact time, the better the results.

- Open an outside tap and allow the water to run until the chlorine odor is greatly reduced. Make sure to direct the water away from sensitive plants or landscaping.
- Flush the chlorine solution from the hot water heater and household distribution system. The small amount of chlorine in the distribution system will not harm the septic tank.

Backwash and regenerate any water treatment equipment.

If you have an old well that has not been routinely chlorinated, consider hiring a drilling contractor to thoroughly clean the well prior to chlorinating. Any floating debris should be removed from the well and the casing should be scrubbed or hosed to disturb the sludge buildup.

### **Modified Procedure for Large Diameter Wells**

Due to the large volume of water in many bored wells the above procedure can be impractical. A more practical way to shock chlorinate a bored well is to mix the recommended amount of chlorine right in the well. The chlorinated water is used to force some of the chlorine solution into the formation around the well. Follow these steps to shock chlorinate a large diameter bored well.

Pump 200 gal. (1000 L) of water into a clean storage tank at the well head.

Mix 20 L of 5 1/4% domestic chlorine bleach (or 8 L of 12% bleach or 1.4 kg of 70% calcium hypochlorite) into the 200 gal. of stored water.

Calculate the amount of chlorine you require per foot of water in the casing and add directly into the well. (Note that the 70% hypochlorite powder should be dissolved in water to form a solution before placing in the well.)

Circulate chlorine added to the water in the well by hooking a garden hose up to an outside faucet and placing the other end back down the well. This circulates the chlorinated water through the pressure system and back down the well. Continue for at least 15 minutes.

Siphon the 200 gal. bleach and water solution prepared in Steps 1 and 2 into the well. Complete the procedure as described in Steps 5 to 9 for drilled wells.

***Don't mix acids with chlorine. This is dangerous.***

CHEMICAL NAME	CHEMICAL FORMULA	FORM	% CHLORINE	STORAGE	QUALITY	ADVANTAGE	DISADVANTAGE
CHLORINE GAS	Cl <sub>2</sub>	GAS	100%	MAY STORE FOR LONG PERIODS	CONSISTENTLY HIGH QUALITY	COST EFFECTIVE	BY-PRODUCT FORMATIONS (THM'S, HAA)
SODIUM HYPOCHLORITE	NaOCl	LIQUID	~ 12%	LIMITED DUE TO DECOMPOSITION	POOR QUALITY DUE TO LIMITED CONTROL	LESS TRAINING REQUIRED TO HANDLE DUE TO FEWER REGULATIONS	LIMITED SHELF LIFE AND HIGHER COST

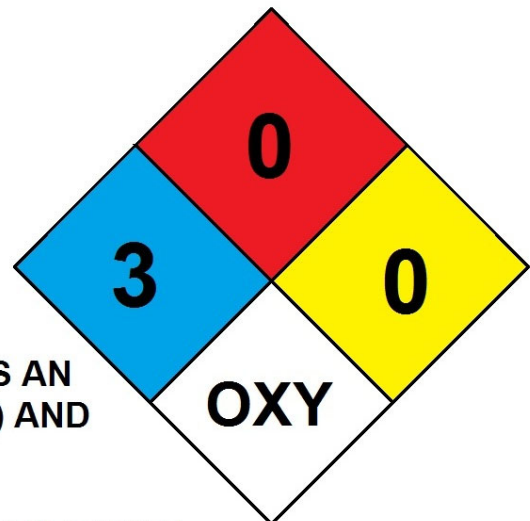
### CHLORINE GAS VS. SODIUM HYPOCHLORITE (BLEACH)

◆ CHLORINE IS EXTREMELY IRRITATING AND CAN BURN THE EYES AND SKIN

◆ IF INHALED, CHLORINE CAUSES RESPIRATORY DISTRESS, AND POSSIBLY BE FATAL

◆ LIQUID CHLORINE RELEASE FORMS AN IMMEDIATE CLOUD (FLASH VAPOR) AND COOLS TO -29°F

◆ EXPOSURE TO CHLORINE LIQUID CAN CAUSE SEVERE FROSTBITE, AS WELL AS CHEMICAL BURNS.



### HEALTH EFFECTS OF CHLORINE EXPOSURE

## Sodium Hydroxide Dilution

**Safety:** Please note that sodium hydroxide is corrosive and irritating to the skin. If sodium hydroxide touches the skin, wash with water immediately to prevent chemical burn. Wear protective clothing such as rubber gloves and goggles when handling sodium hydroxide.

For every 50 lb bag of water softener salt, approximately 36 gallons of 18 percent sodium hydroxide solution is made. The actual amount of sodium hydroxide produced is dependent upon the level and frequency of dilution. Assuming a 7 lb chlorine cycle per cell, the amount of sodium hydroxide produced from the cell is approximately 8.5 gallons. Using the same 18-day operational cycle as discussed above, approximately one-half gallon of sodium hydroxide solution is produced every day of operation.

Dilution of sodium hydroxide in the cathode compartment requires the removal of approximately one-half gallon of sodium hydroxide and the addition of dilution water to 4-inches from the top of the cathode compartment (Note: more sodium hydroxide is produced than water added for dilution). It is desirable to use softened water for the dilution to reduce the mineral fouling of the membrane.

Maintenance of the sodium hydroxide solution within the optimum range (10-18 percent) provides extended life of the membrane. Daily testing of the sodium hydroxide solution with a typical battery hydrometer will verify the need to dilute the sodium hydroxide. The following table illustrates the specific gravity and concentration of sodium hydroxide at a temperature of 60 degrees F (15.5 degrees C):

% NaOH	Specific Gravity
2	1.023
4	1.045
6	1.067
10	1.090
12	1.112
14	1.134
16	1.156
18	1.178
20	1.201
22	1.223

### Dilution of the Sodium Hydroxide Consists of:

- Turn off the power supply to the cell.
- Removal of 1/2 gallon of solution (or more if operating the cell at higher rates or longer periods of time), and dispose/store as desired (this could be disposal down a sanitary drain if solution is not needed; however, sodium hydroxide is needed for pH adjustment in the pool, CIP cleaning for dairies, lift station cleaning in sewer systems, and/or pH adjustment of water for lead and copper corrosion control in municipal drinking water).
- Add dilution water (preferably softened water) to a level of 4-inches from the top of the cathode compartment.
- place system back into service.

- check small amount of solution daily with a hydrometer.

### **System Maintenance**

The chlorine generator has no moving parts and requires minimal maintenance. The system maintenance involves the periodic cleaning of the membrane. The salt and water added to the chlorine generator contain calcium and other minerals that accumulate on the surface of the membrane.

These mineral deposits increase the electrical resistance across the membrane eventually reducing the amperage to the cell, thus reducing the chlorine production. Using the same 18-day operational cycle as discussed above, you may achieve two to four months of cell operation before needing to clean the cell membrane (depends on the dilution water quality) Operating the cell at 1 lb/day for 24 hours/day may require membrane cleaning every month (again, depending on the dilution water quality).

### **Cleaning the Membrane Involves the Following:**

- Turn off the power supply to the cell.
- Remove brine and salt from anode compartment as described above.
- Draining and storage of sodium hydroxide from the cathode compartment.
- Flushing the interior of both compartments with water to remove all loose deposits.
- Encrusted mineral deposits on the membrane can be removed by one of two methods.
  - The membrane removal and replacement method requires the removal of the membrane from the union fitting and replacement with a cleaned membrane. The membrane removed from the cell is then cleaned in a weak hydrochloric acid solution (muriatic or pool acid) to dissolve the mineral deposits. After cleaning, observe the condition of the membrane and discard if pin-holes are observed in the membrane. Otherwise, store membrane in a water solution for the next cleaning cycle.
  - The insitu cleaning method involves the addition of water to top of the horizontal pipe connecting the anode and cathode compartments. Addition of 1 cup of muriatic acid to each cell compartment and agitate cell. After five minutes, drain the cell and flush with water.
- Restore sodium hydroxide to the cathode chamber and salt and water to the anode chamber.
- Reconnect power to cell and resume operation.

### **Replacement Items**

Items that wear and need eventual replacement include the vacuum tubing, rubber gasket/O-ring, membrane, and the anode. The anode has an expected life of five years based on a chlorine rate of 1 lb/day under moderate usage.

The membrane has an anticipated life of one year depending on the frequency and dilution of the sodium hydroxide (see above). The rubber gasket in the cathode compartment may also need to be replaced every few years as needed.

The vacuum tubing should be checked annually and replace when cracks are observed. Use chlorine compatible tubing such as polyethylene tubing when replacing.



## Calcium Hypochlorite Sub-Section (CaCl<sub>2</sub>O<sub>2</sub>)



### **Physical Properties** - Calcium Hypochlorite

**Description:** White powder, pellets or flat plates

**Warning properties:** Chlorine odor; inadequate warning of hazardous concentrations

**Molecular weight:** 142.98 daltons

**Boiling point** (760 mm Hg): Decomposes at 100°C (HSDB 2001)

**Freezing point:** Not applicable

**Specific gravity:** 2.35 (water = 1)

**Water solubility:** 21.4% at 76°F (25°C)

**Flammability:** Not flammable

### **Calcium Hypochlorite: Powder and Tablets**

There are two forms of calcium hypochlorite: powder and tablets. Tablets range in size from 5 mg about the size of an Aspirin to 3 inch tablets. Synonyms of calcium hypochlorite include Losantin, hypochlorous acid, calcium salt, BK powder, Hy-Chlor, chlorinated lime, lime chloride, chloride of lime, calcium oxychloride, HTH, mildew remover X-14, perchloron, and pittchlor.

Calcium hypochlorite is generally available as a white powder, pellets, or flat plates; sodium hypochlorite is usually a greenish yellow, aqueous solution. Although not flammable, they may react explosively.

Calcium hypochlorite decomposes in water to release chlorine and oxygen; sodium hypochlorite solutions can react with acids or ammonia to release chlorine or chloramine. Odor may not provide an adequate warning of hazardous concentrations.

### **Toxic**

Both hypochlorites are toxic by the oral and dermal routes and can react to release chlorine or chloramine which can be inhaled. The toxic effects of sodium and calcium hypochlorite are primarily due to the corrosive properties of the hypochlorite moiety. Systemic toxicity is rare, but metabolic acidosis may occur after ingestion.

### **Description**

Solid chlorine stands alone as the safest form of chlorine disinfection. Requiring only minimal safety equipment for handling, users can breathe easy knowing our tablets are safe for both people and the environment. The elimination of costly scrubbers, containment, or hazard response capability, guarantees lower initial costs and reduced operating expense. Calcium hypochlorite is generally available as a white powder, pellets, or flat plates. It decomposes readily in water or when heated, releasing oxygen and chlorine. It has a strong chlorine odor, but odor may not provide an adequate warning of hazardous concentrations. Calcium hypochlorite is not flammable, but it acts as an oxidizer with combustible material and may react explosively with ammonia, amines, or organic sulfides. Calcium hypochlorite should be stored in a dry, well-ventilated area at a temperature below 120°F (50°C) separated from acids, ammonia, amines, and other chlorinating or oxidizing agents.

### **Chlorine Tablet Feeder**

These feed systems are low maintenance and an extremely effective means to treat water or wastewater. Dry tablet feeder may or may not have mechanical components and most require no electricity. The dry tablet feeding system is a good alternative to liquid bleach and potential gas hazards. With no chlorine gas cylinders to handle, chlorine releases are non-existent. Process safety Management and Risk Management Program compliance worries disappear.

Chlorine Tablet Feeder Capacities: range - 1,500 to 200,000 (GPD)

Chlorine tablets are stable for 3 years or more.

If a tablet produces 1000 PPM in a liter of water when first off the press, the tablet will produce 1000 PPM plus. This guarantees the activity will be at least 100% 3 years later and probably for much longer than that. In fact, tablets have been stored for 6 years at 6% C and 42% C and still contained the specified levels of available chlorine.

Sodium hypochlorite liquid, on the other hand, is inherently unstable and degrades with age until all the active strength disappears. This degradation accelerates in conditions of high temperature or strong sunlight.





These two different tablet chlorinator feeding systems are installed as a sidestream (see the clear plastic line) to the mainstream water flow or directly in the well casing. Using a flow meter or timed device, a chlorine tablet is dropped or delivered inside the well casing or to another location in the distribution system. Sometimes, the chlorinated balance is piped to an integrated solution tank. Then the resulting concentrated chlorine solution is pumped into a pressurized line or holding tank. By mixing chlorinated water from the solution tank with unchlorinated water from the main stream, a controllable level of available chlorine is achieved.



### **Accuracy**

Because of their stability, chlorine tablets are an accurate dose, always yielding the stated level of available chlorine in water or very slightly over, never under. Liquid chlorine strengths vary so widely and are mostly unknown (the container usually says "less than 5%") that it is impossible to make up accurate in-use solutions without access to laboratory equipment.

### **Storage and Distribution**

In recent years, concern regarding the safety hazards associated with liquid chlorine has grown to such an extent that several major cities now restrict transportation of chlorine within their boundaries. Tablets, on the other hand, are easy and convenient to store and transport. One pallet containing 600 jars each of 200 tablets is equivalent to 120,000 x 1 liter in use bleach solutions of 1,000 PPM active chlorine concentration.

Liquid chlorine is bulky, heavy and prone to leakage and spillage. Chlorine tablets are compact, economical and safe to ship and can even be sent by airfreight.

### **Effectiveness**

Both chlorine tablets and liquid Sodium hypochlorite produce Hypochlorous Acid (HOCl) and Hypochlorite ion (OCl<sup>-</sup>) in solution. It has been postulated by Ortenzio and Stuart in 1959 and again by Trueman in 1971 that Hypochlorous Acid is the predominantly active species whilst Hypochlorite ion has little activity due to its negative charge impeding penetration of the cell wall and membrane. The ratio of Hypochlorous Acid to Hypochlorite ion increases with acidity. Chlorine tablets have a pH of 6.7 and liquid hypochlorite a pH of between 9 and 12. Ergo; tablets have a greater disinfection capacity and are less prone to inactivation due to soiling.

### **Safety**

Chlorine tablets in dry form will not leak or splash and do not damage clothing. Liquid chlorine can affect eyes, skin and mucous membranes; it is easily splashed and rots clothing.

### **Corrosion**

Chlorine tablets are much less corrosive than liquid chlorine, which is highly corrosive to most metals

### **Comparison**

The final very important comparison to be made between Sodium hypochlorite (NaOCl) and Sodium dichloroisocyanurate (NaDCC) is their neutralization by organic matter. They are both prone to this but by using horse serum, it has been shown (Coates 1988) that the degree of neutralization is directly proportional to the concentration of serum present.

However, the degree of neutralization of NaOCl disinfectant is much greater than that of NaDCC disinfectant and the disparity increases with the concentration of serum. Hence, where there is a high concentration of organic material present, NaDCC will be very much more effective than NaOCl.

The degree of inactivation of NaOCl and NaDCC solutions by different concentrations of horse serum demonstrates that NaDCC solutions are less prone to inactivation by serum than are NaOCl solutions. For example, in 30% serum it required only 4000 PPM av. Cl of NaDCC as opposed to 17000 PPM av Cl of NaOCl to exhibit similar bactericidal activity.

### System Sizing

To determine the correct system for your application, some specific information is required:

What form of chlorination is used now? \_\_\_ Gas \_\_\_ Liquid Bleach \_\_\_ Granular

Source water temperature \_\_\_\_\_ Other (specify: \_\_\_\_\_)

Is chlorination performed \_\_\_ intermittently or \_\_\_ continuously?

What is the current consumption? \_\_\_\_\_ LBS or GALS/DAY

What is the system pressure to be treated? \_\_\_\_\_ PSI

What is the system flow rate to be treated? \_\_\_\_\_ GPM

What is the final desired chlorine concentration? \_\_\_\_\_ PPM

### Dose Rate Math

$$\begin{aligned} & \text{_____ System Flow Rate (GPM)} \\ & \times \text{_____ Tablets Demand (PPM)} \\ & \\ & \times 0.0005 \text{ Conversion Factor} \\ & \text{Total _____} = \text{LBS/HR Tablets Required} \end{aligned}$$

### System Selection

Compare the LBS/HR of chlorine requirement above with the following system capacity and delivery characteristics. An additional factor that needs to be considered is how frequently the unit must be refilled in light of the volume of tablets that the feeder holds.

### Health Effects

Hypochlorite powder, solutions, and vapor are irritating and corrosive to the eyes, skin, and respiratory tract. Ingestion and skin contact produces injury to any exposed tissues. Exposure to gases released from hypochlorite may cause burning of the eyes, nose, and throat; cough as well as constriction and edema of the airway and lungs can occur.

✓ Hypochlorite produces tissue injury by liquefaction necrosis. Systemic toxicity is rare, but metabolic acidosis may occur after ingestion.

### Acute Exposure

The toxic effects of sodium and calcium hypochlorite are primarily due to the corrosive properties of the hypochlorite moiety. Hypochlorite causes tissue damage by liquefaction necrosis. Fats and proteins are saponified, resulting in deep tissue destruction. Further injury is caused by thrombosis of blood vessels. Injury increases with hypochlorite concentration and pH. Symptoms may be apparent immediately or delayed for a few hours. Calcium hypochlorite decomposes in water releasing chlorine gas.

## **Sodium Hypochlorite Solutions**

Sodium hypochlorite solutions liberate the toxic gases chlorine or chloramine if mixed with acid or ammonia (this can occur when bleach is mixed with another cleaning product). Thus, exposure to hypochlorite may involve exposure to these gases.

Children do not always respond to chemicals in the same way that adults do. Different protocols for managing their care may be needed.

### **Gastrointestinal**

Pharyngeal pain is the most common symptom after ingestion of hypochlorite, but in some cases (particularly in children), significant esophagogastric injury may not have oral involvement. Additional symptoms include dysphagia, stridor, drooling, odynophagia, and vomiting. Pain in the chest or abdomen generally indicates more severe tissue damage. Respiratory distress and shock may be present if severe tissue damage has already occurred. In children, refusal to take food or drink liquid may represent odynophagia.

Ingestion of hypochlorite solutions or powder can also cause severe corrosive injury to the mouth, throat, esophagus, and stomach, with bleeding, perforation, scarring, or stricture formation as potential sequelae.

### **Dermal**

Hypochlorite irritates the skin and can cause burning pain, inflammation, and blisters. Damage may be more severe than is apparent on initial observation and can continue to develop over time. Because of their relatively larger surface area/body weight ratio, children are more vulnerable to toxins affecting the skin.

### **Ocular**

Contact with low concentrations of household bleach causes mild and transitory irritation if the eyes are rinsed, but effects are more severe and recovery is delayed if the eyes are not rinsed. Exposure to solid hypochlorite or concentrated solutions can produce severe eye injuries with necrosis and chemosis of the cornea, clouding of the cornea, iritis, cataract formation, or severe retinitis.

### **Respiratory**

Ingestion of hypochlorite solutions may lead to pulmonary complications when the liquid is aspirated. Inhalation of gases released from hypochlorite solutions may cause eye and nasal irritation, sore throat, and coughing at low concentrations. Inhalation of higher concentrations can lead to respiratory distress with airway constriction and accumulation of fluid in the lungs (pulmonary edema). Patients may exhibit immediate onset of rapid breathing, cyanosis, wheezing, rales, or hemoptysis. Pulmonary injury may occur after a latent period of 5 minutes to 15 hours and can lead to reactive airways dysfunction syndrome (RADS), a chemical irritant-induced type of asthma.

Children may be more vulnerable to corrosive agents than adults because of the smaller diameter of their airways. Children may also be more vulnerable to gas exposure because of increased minute ventilation per kg and failure to evacuate an area promptly when exposed.

### **Metabolic**

Metabolic acidosis has been reported in some cases after ingestion of household bleach.

### **Potential Sequelae**

Exposure to toxic gases generated from hypochlorite solutions can lead to reactive airways dysfunction syndrome (RADS), a chemical irritant-induced type of asthma. Chronic complications following ingestion of hypochlorite include esophageal obstruction, pyloric stenosis, squamous cell carcinoma of the esophagus, and vocal cord paralysis with consequent airway obstruction.

### **Chronic Exposure**

Chronic dermal exposure to hypochlorite can cause dermal irritation.

### **Carcinogenicity**

The International Agency for Research on Cancer has determined that hypochlorite salts are not classifiable as to their carcinogenicity to humans.

### **Reproductive and Developmental Effects**

No information was located regarding reproductive or developmental effects of calcium or sodium hypochlorite in experimental animals or humans. Calcium and sodium hypochlorite are not included in Reproductive and Developmental Toxicants, a 1991 report published by the U.S. General Accounting Office (GAO) that lists 30 chemicals of concern because of widely acknowledged reproductive and developmental consequences.

### **Sources/Uses**

Sodium and calcium hypochlorite are manufactured by the chlorination of sodium hydroxide or lime. Sodium and calcium hypochlorite are used primarily as oxidizing and bleaching agents or disinfectants. They are components of commercial bleaches, cleaning solutions, and disinfectants for drinking water and waste water purification systems and swimming pools.







## Chlorine Production Principles Sub-Section

Faraday's laws states that one coulomb of electricity deposits 0.00111801 grams (g) of silver, or 1 ampere of electric current deposits 0.00111801 g of silver in one second.

Faraday's second law states that the quantity of electricity that liberates one gram equivalent weight (e.w.) of an element is the same for all elements. Since the equivalent weight of silver is 107.880, it takes one faraday, or 96,493 coulombs (107.88 e.w. / 0.00111801 g), to liberate 1 gram equivalent weight of any element.

The 1986 recommended value for one faraday is 96,485.309 coulomb. Being consistent with Faraday's laws, one faraday (96,485.3 coulomb) of electricity liberates 1.008 gram of hydrogen and 35.457 grams of chlorine in the chlor-alkali process. Since there are 86,400 seconds in each day (60 sec/min x 60 min/hour x 24 hour/day) and 454 grams in each pound of element, 14.3 amperes of current are required to liberate one pound of chlorine gas during a 24 hour period:

$$\begin{array}{rclcl} 454 \text{ g/lb} & \times & 96,485.3 \text{ coulomb} & = & 14.3 \text{ amperes} \\ 35.457 \text{ g Cl} & & 86,400 \text{ sec/day} & & \end{array}$$

### Coulomb (C)

The SI unit of electric charge. One coulomb is the amount of charge accumulated in one second by a current of one ampere. Electricity is actually a flow of charged particles, such as electrons, protons, or ions. The charge on one of these particles is a whole-number multiple of the charge  $e$  on a single electron, and one coulomb represents a charge of approximately  $6.241\ 506 \times 10^{18} e$ . The coulomb is named for a French physicist, Charles-Augustin de Coulomb (1736-1806), who was the first to measure accurately the forces exerted between electric charges.

Considering typical current efficiencies of 95 percent, the actual electrochemical reaction requires roughly 15 amperes of direct current to produce one pound of chlorine gas during a 24-hour period:  $14.3 \text{ amperes} / 0.95 \text{ (efficiency factor)} = 15 \text{ amperes}$

The chlorine gas is vacuum swept from the chlorine cell by a Venturi ejector. The chlorine mixes with the ejector water to form hypochlorous acid and/or hypochlorite ion depending on the water pH.

### Industrial Uses

In addition to water treatment chemicals, chlorine is used to make plastics such as PVC (polyvinyl chloride) and polyurethanes, pulp and paper treatment chemicals, solvents and a large number of chemicals.

The most common industrial use of chlorine is the manufacture of a versatile plastic known as polyvinyl chloride, or PVC. PVC is a polymer, meaning on a microscopic level many small units of the same types of atoms are bound together to form long chains, similar to the linking of multiple paper clips.

One use of PVC is as lightweight, durable pipes for safe drinking water delivery. PVC pipes resist the pitting and corrosion common in metal pipes which often develop a slimy build-up of disease-causing microbes known as "biofilm."

Biofilms can be destroyed by elevated levels of chlorine disinfectant. With so many varied and valuable uses, chlorine chemistry is truly an indispensable asset to modern life.

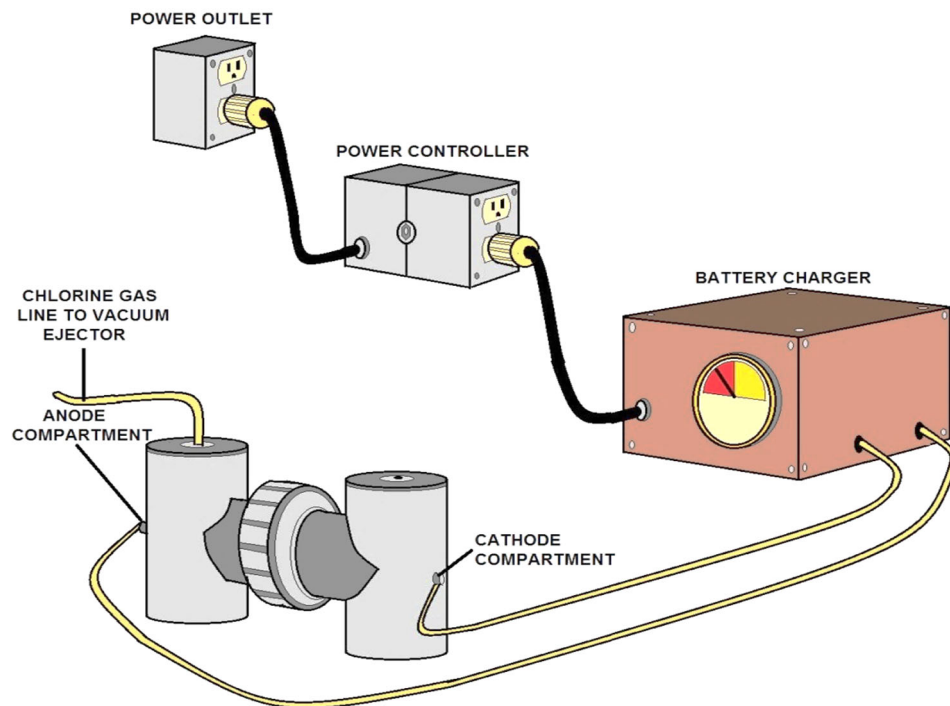
### Chlorine Generator Process

The chlorine generator is as simple as a battery. There are no moving parts; however, the chlorine generator does require operation and maintenance.

- Process Components
- Process Installation
- System Operation
- Dose Control
- Salt Addition
- Sodium Hydroxide Dilution
- System Maintenance

### Process Components

The chlorine generator requires a cell, DC power supply (battery charger, battery, solar power), power controller, energy source (power outlet, generator), and a pressurized water supply to operate the Venturi ejector.



### CHLORINE PRODUCTION PROCESS

**Cell:** The cell includes the anode and cathode compartments that are hydraulically isolated by an ion selective membrane located between the two cell compartments. The anode compartment contains the anode (electrode), salt, saltwater electrolyte, and chlorine.

Chlorine gas generated from the anode compartment is swept under vacuum by the Venturi ejector into the water supply. The cathode compartment contains the cathode (electrode), sodium hydroxide (caustic soda) electrolyte, and hydrogen.

The hydrogen produced from the cathode compartment is vented to the outside atmosphere. The two cell compartments are joined together by a union pipe fitting that also holds the ion selective membrane between the union flanges. Please note that the use of a union pipe fitting in the cell configuration is patented and subject to royalty fees.

### **DC Power Supply**

The DC power supply can be any DC battery charger of adequate size to handle the needed chlorine demand. See our power supply sizing page for determining the size of power supply needed.

### **Power Controller**

The power controller is simply a common dimmer switch (used to dim lights) that the power supply is plugged into to adjust the voltage input to the power supply. Like dimming your lights, the power controller will "dim" your chlorine production to the desired chlorine level.

### **Energy Source**

The energy source can basically be a 120 VAC power outlet you plug the Power Controller into.

### **Pressurized Water Supply**

The water passes through a Venturi creating a vacuum that is applied to the anode compartment of the cell.

The Venturi ejector also includes a flow switch connected to a relay that operates the Power Controller. This safety feature ensures that flow is going through the Venturi ejector before chlorine is generated. The discharge from the vacuum ejectors is highly chlorinated water in the form of hypochlorous acid and/or hypochlorite ion.

### **Process Installation**

Provided the plumbing for the system is complete (existing vacuum ejector, or simply using a garden hose connected to the ejector); it should not take longer than 30 minutes to an hour to have your chlorine generator completely operational. The installation includes the following steps:

- Remove components from the box, check contents for any missing or broken parts
- Soak the membrane in warm water
- Install the membrane on the cell flange
- Add salt and water to the anode compartment
- Add water and dry sodium hydroxide (i.e. Drano) to the cathode compartment
- Connect water supply to Venturi ejector
- Connect the vacuum tubing from the anode compartment to the Venturi ejector
- Clamp red (positive) power clamp from power supply to anode
- Clamp black (negative) power clamp from power supply to cathode
- Turn on power supply switch
- Plug power supply into power controller
- Plug power controller into power circuit
- Operate Venturi ejector and energize power circuit, adjust power controller to desired chlorine level.



## System Operations

The system operation includes the control of the system, addition of salt and water to the anode compartment, periodic dilution of the sodium hydroxide in the cathode compartment, and occasional cleaning of the cell membrane. There are several ways the chlorine generator can be operated. The simplest way is to plug the power controller into a power outlet that is only energized at times when the generator is needed for chlorine production. This on/off operation procedure can be accomplished by installing a power control relay on the power outlet circuit. Nearly all municipal well installations include this type of circuit typically used for a hypochlorination pump.

The power controller includes a flow switch that ensures operation of the chlorine generator only when there is flow through the Venturi ejector. Having the pool filter and water supply fill line on the vacuum ejector will allow the chlorine generator to operate at any moment when water is moving into the pool.

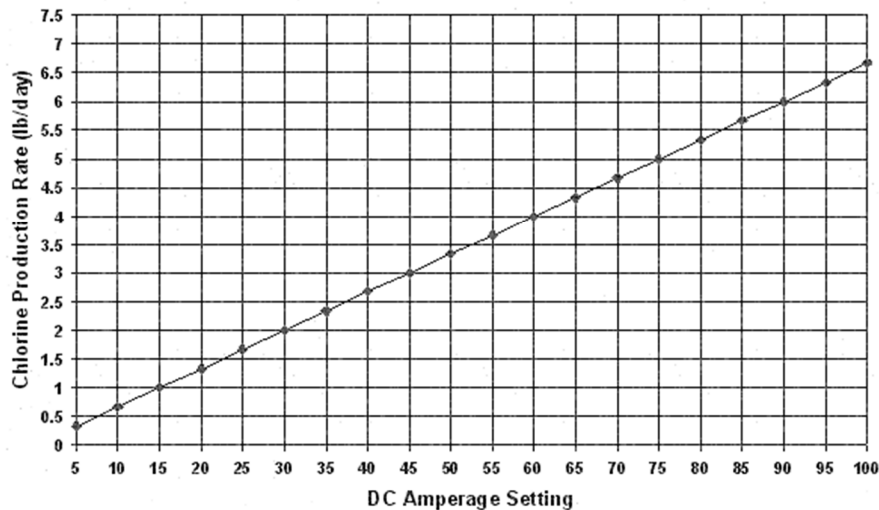
At a booster pump station having multiple pumps, a chlorine generator for each pump circuit will supply the step chlorine dosage needed depending on the number of pumps operating. This operational procedure eliminates the need for an electronic logic controlled loop and/or pacing valve systems.

The chlorine generator can be controlled in an automatic mode associated with a chlorine demand change. The automatic mode requires an electronic input signal (4-20 mA) associated with the demand change that controls an optional EP1 Series - SCR Power.

### Dose Control

Chlorine output is adjusted by the power input of the process. Every 15 amps of direct current (DC) provide a chlorine production rate of 1 pound per day (24 hours). The graph below illustrates the equivalent chlorine production at the desired amperage setting.

**System Production**



**Note:** With time, the membrane accumulates calcium and other mineral deposits that increase the resistance between the electrodes. The increased resistance causes a reduced amperage output and a corresponding reduced chlorine output. The system needs periodic membrane cleaning to recover the desired amperage output. A water softener system can be added to the system water supply to reduce the amount of calcium, thus increasing the service life of the membrane.

Connecting your power supply (battery charger) into the power controller will allow you to manually adjust the voltage supply to your battery charger, thus controlling the DC amperage output to the cell. The power controller provided with each cell includes a 600-watt dimmer switch to manually adjust the input voltage to the battery charger.

Adjustment of the dimmer switch will increase or decrease the voltage output of your battery charger to the desired amperage setting. For example, a chlorine output of 0.5 lbs per day is desired for a 50 gpm well. Based on amperage conversions, approximately 8 amperes of DC power is needed for the well. The operator would adjust the dimmer switch to achieve a power output of 8 DC amperes for the cell.

### **Salt Addition**

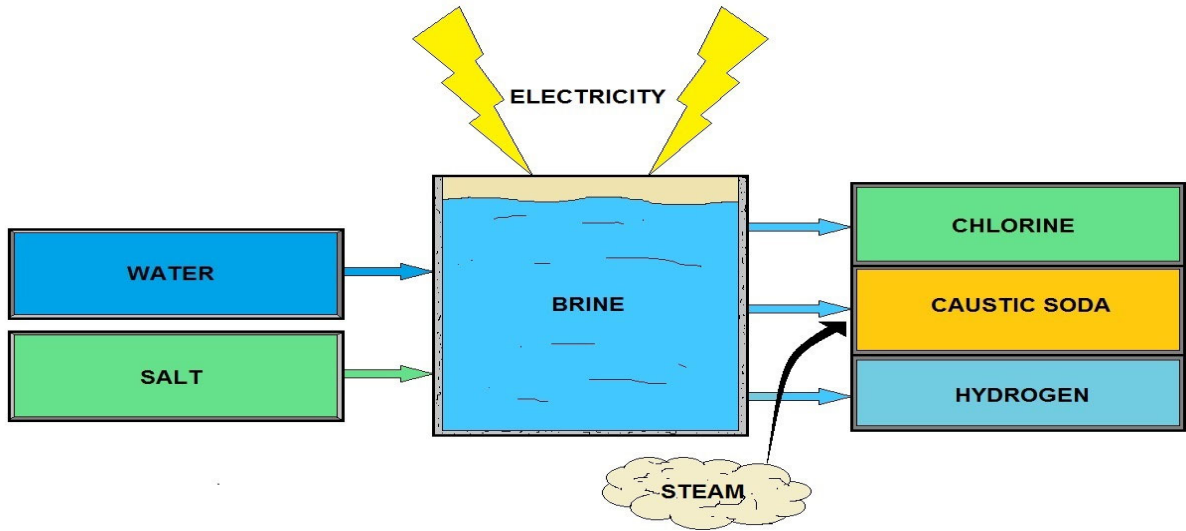
For every 50 lb bag of water softener salt, approximately 30 lbs of chlorine is made. The amount of salt that can be added to the cell depends on the shape of the salt pellets; however, a typical amount of salt added in each cycle is roughly 12 lbs. Twelve pounds of salt in the anode compartment will generate 7 lbs of chlorine considering that not all the salt is used in each cycle. The frequency of salt addition depends on the operating cycle. For example:

A 150 gpm municipal well operating a total of 6 hours per day (54,000 gpd) using a 1.5 lb/day (22 amperes) chlorine dosage rate (0.5 mg/l chlorine residual w/ a 0.35 mg/l chlorine demand) will need to have salt added every 18 days (7 lbs/cell / [1.5 lb/day \* 6 hr / 24 hr]).

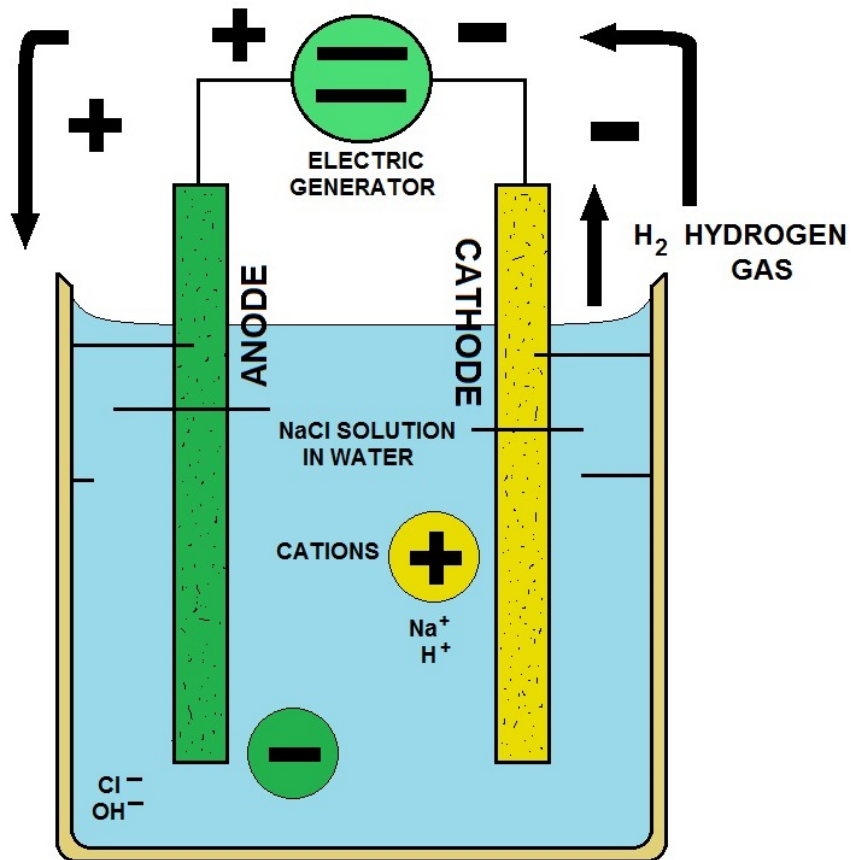
Salt replenishment in the anode compartment requires the drainage of the brine, flushing the anode compartment with water, and addition of new salt and water to the cell. Adding of salt to the cell without flushing and cleaning is not recommended for several reasons. First, the anode compartment contains residual chlorine gas that will be displaced when salt is added. The amount of chlorine gas in this space is small (0.02 lbs); however, this amount of chlorine gas is irritating, especially if in a confined space. Second, the brine contains concentrated mineral impurities that will foul the membrane at a more rapid rate if it is not removed.

### **Replenishing the Salt Consists of:**

- Turn off the power supply to the cell.
- Add roughly 1 cup of sodium hydroxide to the anode compartment. The sodium hydroxide will neutralize the residual chlorine in the brine and make a salt saturated hypochlorite solution.
- Drain the brine solution to waste and flush out the cell removing all the residual matter in the bottom of the cell.
- Add new salt and water to the anode compartment (it is desirable to use softened water to reduce the mineral fouling of the membrane).
- Place system back into service.



**BASIC CONCEPT OF HOW CHLORINE AND CAUSTIC SODA ARE PRODUCED**



**ELECTROLYSIS OF NaCl**

## Chlor-Alkali Membrane Process

The electrolysis occurs in a cell containing electrodes submerged in solutions called electrolytes. One electrode is referred to as the anode and is submerged in a salt water solution. The second electrode is the cathode and is submerged in a sodium hydroxide (caustic soda) solution. A membrane is used to keep the two different solutions from mixing. This particular method of producing chlorine is called the chlor-alkali membrane process.

When a low voltage direct current (DC) power supply is applied to the electrodes in the cell, the sodium and chlorine ions in the brine are attracted in opposite directions to the polarized electrodes. The sodium ion passes across an ion selective membrane leaving the chlorine ion to combine with a second chlorine ion, which makes a chlorine gas bubble at the anode (electrode).

When the sodium crosses the membrane, it combines with a hydroxyl ion at the cathode (electrode) making sodium hydroxide, or caustic soda (NaOH). The hydroxyl ion originates from the dissolution of water at the cathode where hydrogen gas also develops. The membrane in the cell keeps the two solutions separate; otherwise, the chlorine gas bubble would immediately combine with the caustic soda forming sodium hypochlorite, or bleach. This process, which uses a membrane to separate the two solutions, is called the chlor-alkali process. The chemical equation for the chlor-alkali process is illustrated in the following equation:





## Summary

### Chlorine

Upon adding chlorine to water, two chemical species, known together as free chlorine, are formed. These species, hypochlorous acid (HOCl, electrically neutral) and hypochlorite ion (OCl<sup>-</sup>, electrically negative), behave very differently. Hypochlorous acid is not only more reactive than the hypochlorite ion, but is also a stronger disinfectant and oxidant.

The ratio of hypochlorous acid to hypochlorite ion in water is determined by the pH. At low pH (higher acidity), hypochlorous acid dominates while at high pH hypochlorite ion dominates. Thus, the speed and efficacy of chlorine disinfection against pathogens may be affected by the pH of the water being treated. Fortunately, bacteria and viruses are relatively easy targets of chlorination over a wide range of pH. However, treatment operators of surface water systems treating raw water contaminated by the parasitic protozoan *Giardia* may take advantage of the pH-hypochlorous acid relationship and adjust the pH to be effective against *Giardia*, which is much more resistant to chlorination than either viruses or bacteria.

Another reason for maintaining a predominance of hypochlorous acid during treatment has to do with the fact that pathogen surfaces carry a natural negative electrical charge. These surfaces are more readily penetrated by the uncharged, electrically neutral hypochlorous acid than the negatively charged hypochlorite ion. Moving through slime coatings, cell walls and resistant shells of waterborne microorganisms, hypochlorous acid effectively destroys these pathogens. Water is made microbiologically safe as pathogens either die or are rendered incapable of reproducing. A typical bacterium has a negatively charged slime coating on its exterior cell wall, which is effectively penetrated by electrically neutral hypochlorous acid, favored by lower pH's.

### Chloramines

Chloramines are chemical compounds formed by combining a specific ratio of chlorine and ammonia in water. Because chloramines are relatively weak as a disinfectant, they are almost never used as a primary disinfectant. Chloramines provide a durable residual, and are often used as a secondary disinfectant for long distribution lines and where free chlorine demand is high. Chloramines may also be used instead of chlorine in order to reduce chlorinated byproduct formation and to remove some taste and odor problems.

### Advantages

- Reduced formation of THMs, HAAs
- Will not oxidize bromide to bromine forming brominated byproducts
- More stable residual than free chlorine
- Excellent secondary disinfectant, has been found to be better than free chlorine at controlling coliform bacteria and biofilm growth
- Lower taste and odor than free chlorine

### Limitations

- Weak disinfectant and oxidant
- Requires shipment and handling of ammonia or ammonia compounds as well as chlorinating chemicals
- Ammonia is toxic to fish, and may pose problems for aquarium owners
- Will cause problems for kidney dialysis if not removed from water

## **Chlorine Dioxide**

Chlorine dioxide ( $\text{ClO}_2$ ) is generated on-site at water treatment facilities. In most generators sodium chlorite and elemental chlorine are mixed in solution, which almost instantaneously forms chlorine dioxide. Chlorine dioxide characteristics are quite different from chlorine. In solution it is a dissolved gas, which makes it largely unaffected by pH but volatile and relatively easily stripped from solution. Chlorine dioxide is also a strong disinfectant and a selective oxidant. While chlorine dioxide does produce a residual it is only rarely used for this purpose.

### **Advantages**

- ✓ Effective against Cryptosporidium
- ✓ Up to five times faster than chlorine at inactivating Giardia
- ✓ Disinfection is only moderately affected by pH
- ✓ Will not form chlorinated byproducts (THMs, HAAs)
- ✓ Does not oxidize bromide to bromine (can form bromate in sunlight)
- ✓ More effective than chlorine in treating some taste and odor problems
- ✓ Selective oxidant used for manganese oxidation and targeting some chlorine resistant organics

### **Limitations**

- ✓ Inorganic byproduct formation (chlorite, chlorate)
- ✓ Highly volatile residuals
- ✓ Requires on-site generation equipment and handling of chemicals (chlorine and sodium chlorite)
- ✓ Requires a high level of technical competence to operate and monitoring equipment, product and residuals
- ✓ Occasionally poses unique odor and taste problems
- ✓ High operating cost (chlorite chemical cost is high)

## Hypochlorites and Chloramines Post Quiz

1. \_\_\_\_\_:  $\text{NHCl}_2 + 3\text{HOCl} \rightarrow \text{NHCl}_3 + 3\text{H}_2\text{O}$
2. \_\_\_\_\_ are an effective disinfectant against bacteria but not against viruses. As a result, it is necessary to add more chlorine to the wastewater to prevent the formation of chloramines and form other stronger forms of disinfectants.
3. \_\_\_\_\_:  $\text{NH}_3 + \text{HOCl} \rightarrow \text{NH}_2\text{Cl} + \text{H}_2\text{O}$
4. Free chlorine reacts with the chloramine to produce hydrogen ion, water, and \_\_\_\_\_ which will come out of solution. In the case of the monochloramine, the following reaction occurs:  $2\text{NH}_2\text{Cl} + \text{HOCl} \rightarrow \text{N}_2 + 6\text{HCl} + \text{H}_2\text{O}$
5. \_\_\_\_\_:  $\text{NH}_2\text{Cl} + 2\text{HOCl} \rightarrow \text{NHCl}_2 + 2\text{H}_2\text{O}$
6. \_\_\_\_\_ are formed in the pH range of 4.5 to 8.5, however, monochloramine is most common when the pH is above 8.
7. \_\_\_\_\_ comes in two forms: powder and tablets. Tablets range in size from 5 mg about the size of an Aspirin to 3 inch tablets.
8. \_\_\_\_\_ decomposes in water to release chlorine and oxygen; sodium hypochlorite solutions can react with acids or ammonia to release chlorine or chloramine?
9. \_\_\_\_\_ is generally available as a white powder, pellets, or flat plates; sodium hypochlorite is usually a greenish yellow, aqueous solution. Although not flammable, they may react explosively.
10. Solid chlorine stands alone as the safest form of chlorine disinfection. Requiring only minimal safety equipment for handling, users can breathe easy knowing our tablets are safe for both people and the environment.  
A. True      B. False

11. Sodium hypochlorite is generally available as a white powder, pellets, or flat plates. It decomposes readily in water or when heated, releasing oxygen and chlorine. It has a strong chlorine odor, but odor may not provide an adequate warning of hazardous concentrations.

A. True      B. False

12. \_\_\_\_\_ strengths vary so widely and are mostly unknown (the container usually says "less than 5%") that it is impossible to make up accurate in-use solutions without access to laboratory equipment?

13. Liquid Sodium hypochlorite and chlorine tablets produce Hypochlorous Acid (HOCl) and \_\_\_\_\_.

14. The ratio of Hypochlorous Acid to \_\_\_\_\_ increases with acidity. Chlorine tablets have a pH of 6.7 and liquid hypochlorite a pH of between 9 and 12. Ergo; tablets have a greater disinfection capacity and are less prone to inactivation due to soiling.

15. \_\_\_\_\_ can affect eyes, skin and mucous membranes; it is easily splashed and rots clothing?

16. \_\_\_\_\_ produces tissue injury by liquefaction necrosis. Systemic toxicity is rare, but metabolic acidosis may occur after ingestion.

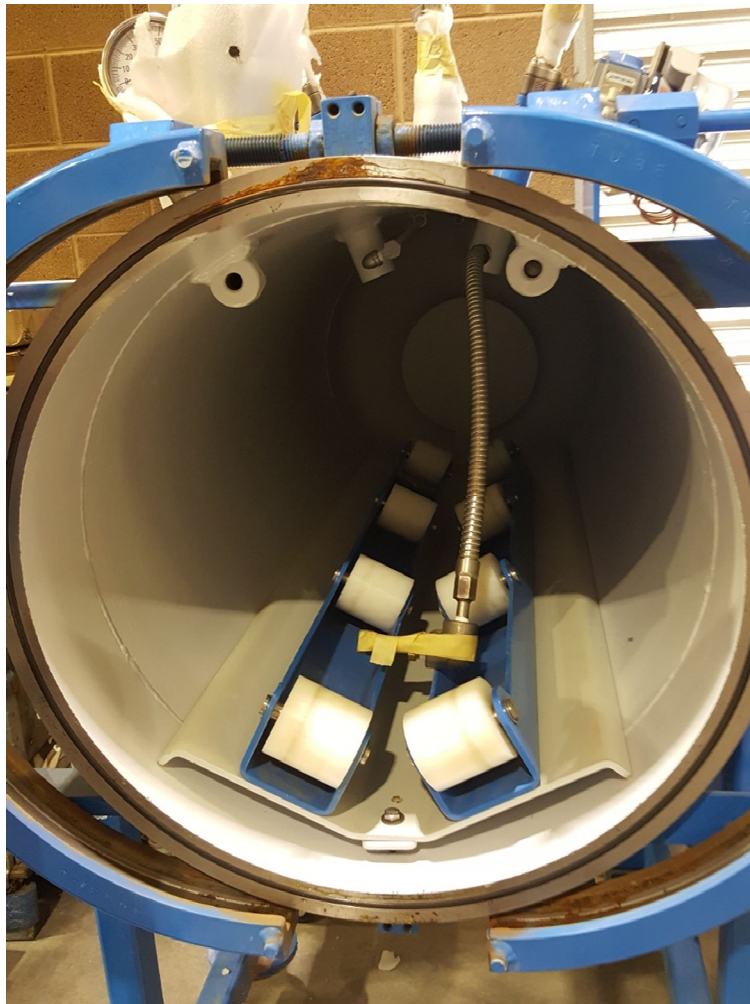
17. According to the text, the toxic effects of this compound are primarily due to the corrosive properties of the hypochlorite moiety.

18. Calcium hypochlorite decomposes in water releasing?

## Chapter 6 - Chlorination Safety and Equipment Section

**Section Focus:** You will learn the basics of disinfection equipment and safety requirements with an emphasis on Chlorine. At the end of this section, you will be able to describe chlorination safety and related equipment. There is a post quiz at the end of this section to review your comprehension and a final examination in the Assignment for your contact hours.

**Scope/Background:** You as a treatment operator need to use safe working procedures when exposed to this dangerous chemical substance. You need to master chlorine safety training and safe work practices. This section teaches you about the chemical properties of chlorine, how they may be exposed, and the physical and health hazards of chlorine.



### Chlorine Gas Containment Safety Vessels (Encapsulation)

These vessels are self-contained; no engineering or construction is required. Its design is a simple, passive design means no pumps, fans, scrubbers or caustic circulation systems are needed.

## Safety Option- Chlorine Gas Containment

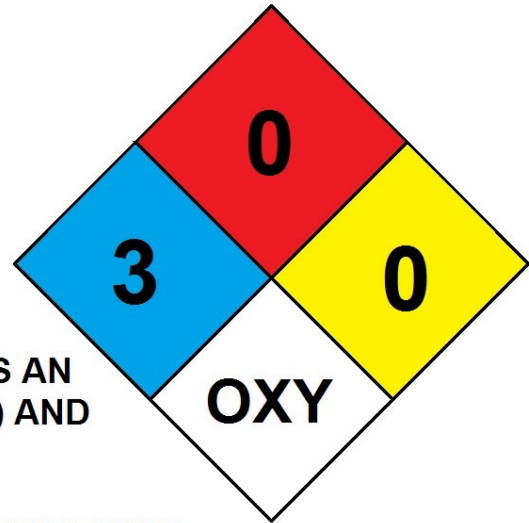


These photos are of high-pressure chlorine containment vessels into which a 1-Ton or 150-lb chlorine gas cylinder is processed. If the cylinder should leak, chlorine gas is contained within the vessel and processed at a normal rate. All of the chlorine gas is used and no hazardous waste is generated.



## Chlorine Health Hazard Sub-Section

- ◆ CHLORINE IS EXTREMELY IRRITATING AND CAN BURN THE EYES AND SKIN
- ◆ IF INHALED, CHLORINE CAUSES RESPIRATORY DISTRESS, AND POSSIBLY BE FATAL
- ◆ LIQUID CHLORINE RELEASE FORMS AN IMMEDIATE CLOUD (FLASH VAPOR) AND COOLS TO  $-29^{\circ}\text{F}$
- ◆ EXPOSURE TO CHLORINE LIQUID CAN CAUSE SEVERE FROSTBITE, AS WELL AS CHEMICAL BURNS.



## HEALTH EFFECTS OF CHLORINE EXPOSURE

### Signs and Symptoms of Exposure

1. Acute exposure: Acute exposure to low levels of chlorine results in eye, nose, and throat irritation, sneezing, excessive salivation, general excitement, and restlessness. Higher concentrations causes difficulty in breathing, violent coughing, nausea, vomiting, cyanosis, dizziness, headache, choking, laryngeal edema, acute tracheobronchitis, chemical pneumonia. Contact with the liquid can result in frostbite burns of the skin and eyes [Genium 1992].
2. Chronic exposure: Chronic exposure to low levels of chlorine gas can result in a dermatitis known as chloracne, tooth enamel corrosion, coughing, severe chest pain, sore throat, hemoptysis and increased susceptibility to tuberculosis [Genium 1992].

### Inhalation

Immediately remove the exposed person upwind from the contaminated area and contact the poison control center. Inhalation can cause coughing, sneezing, shortness of breath, sensation of tightness in the chest, as well as severe restlessness or anxiety, nausea, and vomiting. The nose and throat may become irritated; a stinging and burning sensation may be experienced. Immediate fatalities can occur as a result of suffocation. Delayed fatalities can occur as a result of pulmonary edema (fluid in the lungs). For this reason, rest and immediate attention after inhalation is important.

Persons with known cardiovascular or lung problems should not risk chlorine exposure. If breathing has stopped, give artificial respiration; if breathing is difficult, give oxygen if equipment and trained personnel are available.

If exposed person is breathing, place in a comfortable position and keep person warm and at rest until medical assistance becomes available.

### **Eye/Skin Contact**

Liquid and concentrated gas could produce severe burns and injury on contact.

#### **Eye**

Pour a gentle stream of warm water through the affected eye for at least 15 minutes. Contact the poison control center, emergency room or physician right away as further treatment will be necessary.

#### **Skin**

Run a gentle stream of water over the affected area for 15 minutes. A mild soap may be used if available. Contact the poison control center, emergency room or physician right away as further treatment will be necessary.

#### **Chronic**

Repeated exposures can result in a loss of ability to detect the odor of chlorine. Long term exposures may cause damage to teeth and inflammation or ulceration of the nasal passages.

#### **Ingestion**

Not applicable for gas. Liquid could produce severe burns and injury on contact.

### **Pre-hospital Management**

\* Rescue personnel are at low risk of secondary contamination from victims who have been exposed only to gases released from hypochlorite solutions. However, clothing or skin soaked with industrial-strength bleach or similar solutions may be corrosive to rescuers and may release harmful gases.

\* Ingestion of hypochlorite solutions may cause pain in the mouth or throat, dysphagia, stridor, drooling, odynophagia, and vomiting. Hypochlorite irritates the skin and can cause burning pain, inflammation, and blisters. Acute exposure to gases released from hypochlorite solutions can cause coughing, eye and nose irritation, lacrimation, and a burning sensation in the chest. Airway constriction and noncardiogenic pulmonary edema may also occur.

\* There is no specific antidote for hypochlorite poisoning. Treatment is supportive.

#### **Hot Zone**

Rescuers should be trained and appropriately attired before entering the Hot Zone. If the proper equipment is not available, or if rescuers have not been trained in its use, assistance should be obtained from a local or regional HAZMAT team or other properly equipped response organization.

#### **Rescuer Protection**

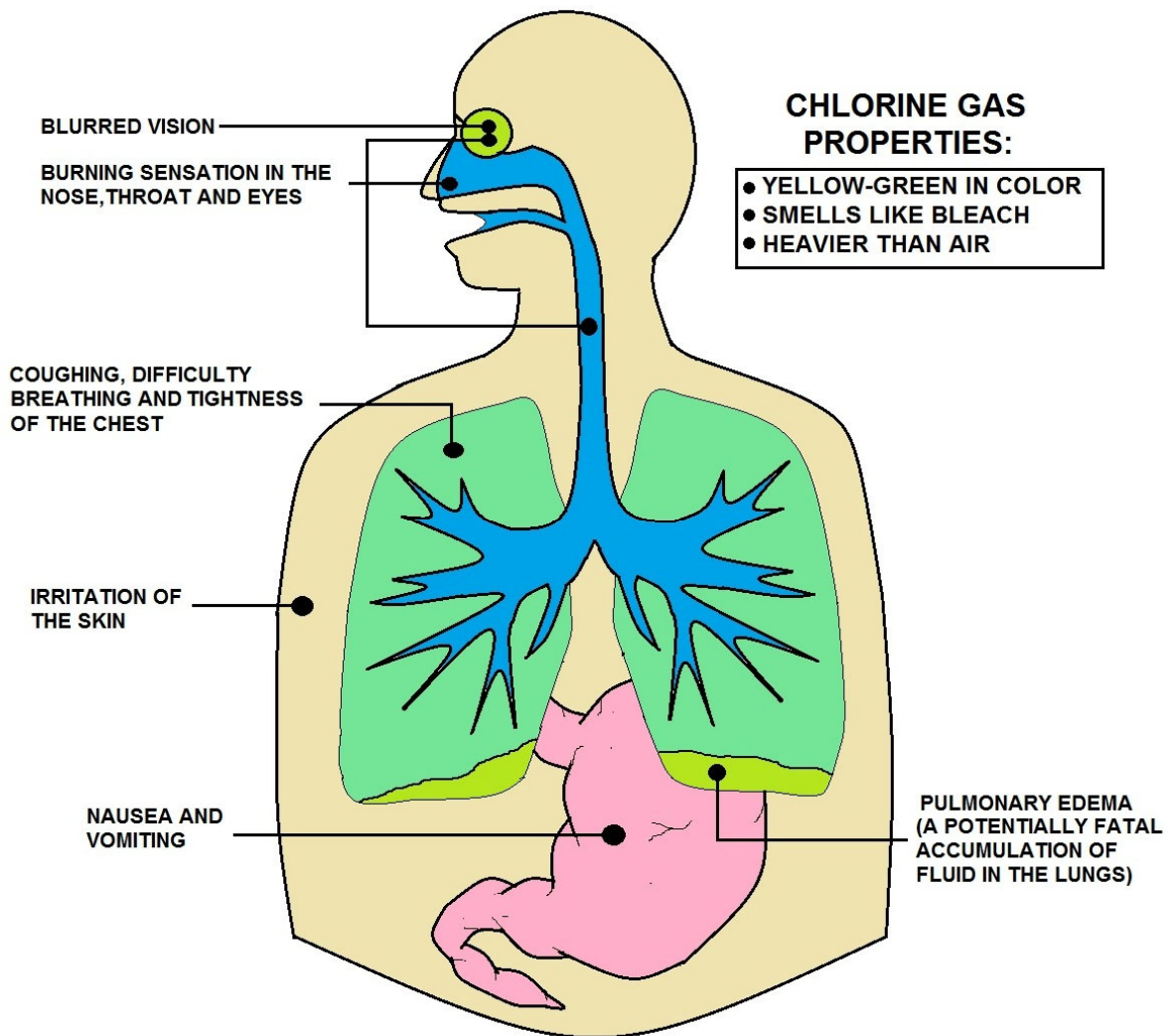
Hypochlorite is irritating to the skin and eyes and in some cases may release toxic gases.



## Respiratory Protection

Positive-pressure, self-contained breathing apparatus (SCBA) is recommended in response to situations that involve exposure to potentially unsafe levels of chlorine gas.

**Skin Protection:** Chemical-protective clothing should be worn due to the risk of skin irritation and burns from direct contact with solid hypochlorite or concentrated solutions.



## HEALTH RISKS OF CHLORINE GAS DIAGHRAM

### ABC Reminders

Quickly establish a patient airway, ensure adequate respiration and pulse. If trauma is suspected, maintain cervical immobilization manually and apply a cervical collar and a backboard when feasible.

### **Victim Removal**

If victims can walk, lead them out of the Hot Zone to the Decontamination Zone. Victims who are unable to walk may be removed on backboards or gurneys; if these are not available, carefully carry or drag victims to safety.

Consider appropriate management in victims with chemically-induced acute disorders, especially children who may suffer separation anxiety if separated from a parent or other adult.

### **Decontamination Zone**

Victims exposed only to chlorine gas released by hypochlorite who have no skin or eye irritation do not need decontamination. They may be transferred immediately to the Support Zone. All others require decontamination as described below.

### **Rescuer Protection**

If exposure levels are determined to be safe, decontamination may be conducted by personnel wearing a lower level of protection than that worn in the Hot Zone (described above).

### **ABC Reminders**

Quickly establish a patient airway, ensure adequate respiration and pulse. Stabilize the cervical spine with a collar and a backboard if trauma is suspected. Administer supplemental oxygen as required. Assist ventilation with a bag-valve-mask device if necessary.

### **Basic Decontamination**

Rapid decontamination is critical. Victims who are able may assist with their own decontamination. Remove and double-bag contaminated clothing and personal belongings. Flush exposed skin and hair with copious amounts of plain tepid water. Use caution to avoid hypothermia when decontaminating victims, particularly children or the elderly. Use blankets or warmers after decontamination as needed.

Irrigate exposed or irritated eyes with saline, Ringer's lactate, or D5W for at least 20 minutes. Eye irrigation may be carried out simultaneously with other basic care and transport. Remove contact lenses if it can be done without additional trauma to the eye. If a corrosive material is suspected or if pain or injury is evident, continue irrigation while transferring the victim to the support zone.

### **In Cases of Ingestion, Do Not Induce Emesis or Offer Activated Charcoal.**

Victims who are conscious and able to swallow should be given 4 to 8 ounces of water or milk; if the victim is symptomatic, delay decontamination until other emergency measures have been instituted. Dilutants are contraindicated in the presence of shock, upper airway obstruction, or in the presence of perforation.

Consider appropriate management of chemically contaminated children at the exposure site. Provide reassurance to the child during decontamination, especially if separation from a parent occurs.

### **Transfer to Support Zone**

As soon as basic decontamination is complete, move the victim to the Support Zone.

### **Support Zone**

Be certain that victims have been decontaminated properly (see Decontamination Zone above). Victims who have undergone decontamination or have been exposed only to vapor pose no serious risks of secondary contamination to rescuers. In such cases, Support Zone personnel require no specialized protective gear.

### **ABC Reminders**

Quickly establish a patient airway, ensure adequate respiration and pulse. If trauma is suspected, maintain cervical immobilization manually and apply a cervical collar and a backboard when feasible. Administer supplemental oxygen as required and establish intravenous access if necessary. Place on a cardiac monitor, if available.

### **Additional Decontamination**

1. Continue irrigating exposed skin and eyes, as appropriate.
2. In cases of ingestion, do not induce emesis or offer activated charcoal.
3. Victims who are conscious and able to swallow should be given 4 to 8 ounces of water or milk; if the victim is symptomatic, delay decontamination until other emergency measures have been instituted. Dilutants are contraindicated in the presence of shock, upper airway obstruction, or in the presence of perforation.

### **Advanced Treatment**

In cases of respiratory compromise, secure airway and respiration via endotracheal intubation. Avoid blind nasotracheal intubation or use of an esophageal obturator: only use direct visualization to intubate. When the patient's condition precludes endotracheal intubation, perform cricothyrotomy if equipped and trained to do so.

Treat patients who have bronchospasm with an aerosolized bronchodilator such as albuterol.

Consider racemic epinephrine aerosol for children who develop stridor. Dose 0.25-0.75 mL of 2.25% racemic epinephrine solution in water, repeat every 20 minutes as needed cautioning for myocardial variability.

Patients who are comatose, hypotensive, or having seizures or who have cardiac arrhythmias should be treated according to advanced life support (ALS) protocols.

### **Transport to Medical Facility**

Only decontaminated patients or those not requiring decontamination should be transported to a medical facility. "Body bags" are not recommended.

Report to the base station and the receiving medical facility the condition of the patient, treatment given, and estimated time of arrival at the medical facility.

If a chemical has been ingested, prepare the ambulance in case the victim vomits toxic material. Have ready several towels and open plastic bags to quickly clean up and isolate vomitus.

### **Multi-Casualty Triage**

Consult with the base station physician or the regional poison control center for advice regarding triage of multiple victims.

Patients who have ingested hypochlorite, or who show evidence of significant exposure to hypochlorite or chlorine (e.g., severe or persistent cough, dyspnea or chemical burns) should be transported to a medical facility for evaluation. Patients who have minor or transient irritation of the eyes or throat may be discharged from the scene after their names, addresses, and telephone numbers are recorded. They should be advised to seek medical care promptly if symptoms develop or recur.

### **Routes of Exposure**

Exposure to chlorine can occur through inhalation, ingestion, and eye or skin contact [Genium 1992].

### **Summary of Toxicology**

1. Effects on Animals: Chlorine is a severe irritant of the eyes, mucous membranes, skin, and lungs in experimental animals. The 1 hour LC(50) is 239 ppm in rats and 137 ppm in mice ([Sax and Lewis 1989]. Animals surviving sublethal inhalation exposures for 15 to 193 days showed marked emphysema, which was associated with bronchiolitis and pneumonia [Clayton and Clayton 1982]. Chlorine injected into the anterior chamber of rabbits' eyes resulted in severe damage with inflammation, opacification of the cornea, atrophy of the iris, and injury to the lens [Grant 1986].

2. Effects on Humans: Severe acute effects of chlorine exposure in humans have been well documented since World War I when chlorine gas was used as a chemical warfare agent. Other severe exposures have resulted from the accidental rupture of chlorine tanks. These exposures have caused death, lung congestion, and pulmonary edema, pneumonia, pleurisy, and bronchitis [Hathaway et al. 1991]. The lowest lethal concentration reported is 430 ppm for 30 minutes [Clayton and Clayton 1982].

Exposure to 15 ppm causes throat irritation, exposures to 50 ppm are dangerous, and exposures to 1000 ppm can be fatal, even if exposure is brief [Sax and Lewis 1989; Clayton and Clayton 1982]. Earlier literature reported that exposure to a concentration of about 5 ppm caused respiratory complaints, corrosion of the teeth, inflammation of the mucous membranes of the nose and susceptibility to tuberculosis among chronically-exposed workers.

However, many of these effects are not confirmed in recent studies and are of very dubious significance [ACGIH 1991]. A study of workers exposed to chlorine for an average of 10.9 years was published in 1970. All but six workers had exposures below 1 ppm; 21 had TWAs above 0.52 ppm.

No evidence of permanent lung damage was found, but 9.4 percent had abnormal EKGs compared to 8.2 percent in the control group. The incidence of fatigue was greater among those exposed above 0.5 ppm [ACGIH 1991]. In 1981, a study was published involving 29 subjects exposed to chlorine concentrations up to 2.0 ppm for 4- and 8-hour periods.

Exposures of 1.0 ppm for 8 hours produced statistically significant changes in pulmonary function that were not observed at a 0.5 ppm exposure concentration.

Six of 14 subjects exposed to 1.0 ppm for 8 hours showed increased mucous secretions from the nose and in the hypopharynx.

Responses for sensations of itching or burning of the nose and eyes, and general discomfort were not severe, but were perceptible, especially at the 1.0 ppm exposure level [ACGIH 1991]. A 1983 study of pulmonary function at low concentrations of chlorine exposure also found transient decreases in pulmonary function at the 1.0 ppm exposure level, but not at the 0.5 ppm level [ACGIH 1991].

Acne (chloracne) is not unusual among persons exposed to low concentrations of chlorine for long periods of time. Tooth enamel damage may also occur [Parmeggiani 1983]. There has been one confirmed case of myasthenia gravis associated with chlorine exposure [NLM 1995].

#### **Emergency Medical Procedures: [NIOSH to Supply]**

- Rescue: Remove an incapacitated worker from further exposure and implement appropriate emergency procedures (e.g., those listed on the Safety Data Sheet (formerly MSDS) required by OSHA's Hazard Communication Standard [29 CFR 1910.1200]).
- All workers should be familiar with emergency procedures, the location and proper use of emergency equipment, and methods of protecting themselves during rescue operations.

#### **Exposure Sources and Control Methods**

The following operations may involve chlorine and lead to worker exposures to this substance:

#### **The Manufacture and Transportation of Chlorine**

- Used as a chlorinating and oxidizing agent in organic and inorganic synthesis; in the manufacture of chlorinated solvents, automotive antifreeze and antiknock compounds, polymers (synthetic rubber and plastics), resins, elastomers, pesticides, refrigerants, and in the manufacture of rocket fuel.
- Used as a fluxing, purification, and extraction agent in metallurgy.
- Used as a bacteriostat, disinfectant, odor control, and demulsifier in treatment of drinking water, swimming pools, and in sewage.
- Used in the paper and pulp, and textile industries for bleaching cellulose for artificial fibers; used in the manufacture of chlorinated lime; used in detinning and dezincing iron; used to shrink-proof wool.
- Used in the manufacture of pharmaceuticals, cosmetics, lubricants, flameproofing, adhesives, in special batteries containing lithium or zinc, and in hydraulic fluids; use in the processing of meat, fish, vegetables, and fruit.
- Used as bleaching and cleaning agents, and as a disinfectant in laundries, dishwashers, cleaning powders, cleaning dairy equipment, and bleaching cellulose.

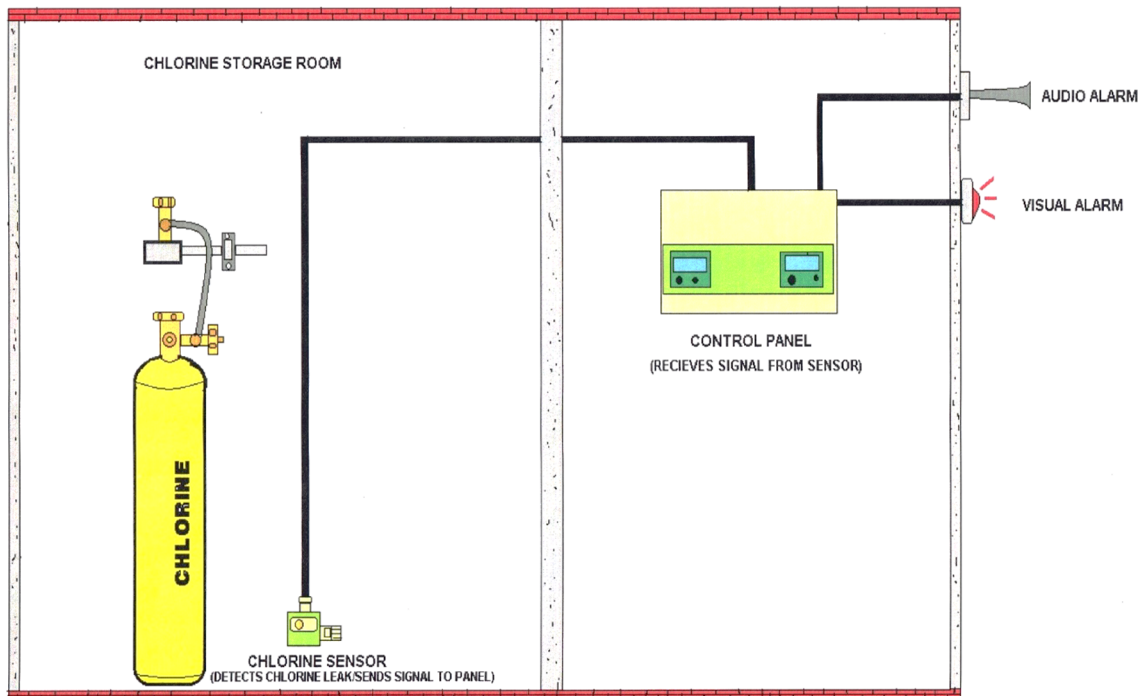
Methods that are effective in controlling worker exposures to chlorine, depending on the feasibility of implementation, are as follows: process enclosure, local exhaust ventilation, general dilution, ventilation and personal protective equipment.

Workers responding to a release or potential release of a hazardous substance must be protected as required by paragraph (q) of OSHA's Hazardous Waste Operations and Emergency Response Standard 29 CFR.

**Good Sources of Information about Control Methods are as Follows:**

1. ACGIH [1992]. Industrial ventilation--a manual of recommended practice. 21st ed. Cincinnati, OH: American Conference of Governmental Industrial Hygienists.
2. Burton DJ [1986]. Industrial ventilation--a self-study companion. Cincinnati, OH: American Conference of Governmental Industrial Hygienists.
3. Alden JL, Kane JM [1982]. Design of industrial ventilation systems. New York, NY: Industrial Press, Inc.
4. Wadden RA, Scheff PA [1987]. Engineering design for control of workplace hazards. New York, NY: McGraw-Hill.
5. Plog BA [1988]. Fundamentals of industrial hygiene. Chicago, IL: National Safety Council.

## Chlorination Equipment Requirements



For all treatment facilities, chlorine gas under pressure shall not be permitted outside the chlorine room. A chlorine room is where chlorine gas cylinders and/or ton containers are stored. Vacuum regulators shall also be located inside the chlorine room. The chlorinator, which is the mechanical gas proportioning equipment, may or may not be located inside the chlorine room.

For new and upgraded facilities, from the chlorine room, chlorine gas vacuum lines should be run as close to the point of solution application as possible. Injectors should be located to minimize the length of pressurized chlorine solution lines. A gas pressure relief system shall be included in the gas vacuum line between the vacuum regulator(s) and the chlorinator(s) to ensure that pressurized chlorine gas does not enter the gas vacuum lines leaving the chlorine room.

The gas pressure relief system shall vent pressurized gas to the atmosphere at a location that is not hazardous to plant personnel; vent line should be run in such a manner that moisture collecting traps are avoided.

The vacuum regulating valve(s) shall have positive shutdown in the event of a break in the downstream vacuum lines.

As an alternative to chlorine gas, it is permissible to use hypochlorite with positive displacement pumping. Anti-siphon valves shall be incorporated in the pump heads or in the discharge piping.

### Capacity

The chlorinator shall have the capacity to dose enough chlorine to overcome the demand and maintain the required concentration of the "**free**" or "**combined**" chlorine.

### Methods of Control

A chlorine feed system shall be automatic proportional controlled, automatic residual controlled, or compound loop controlled. In the automatic proportional controlled system, the equipment adjusts the chlorine feed rate automatically in accordance with the flow changes to provide a constant pre-established dosage for all rates of flow. In the automatic residual controlled system, the chlorine feeder is used in conjunction with a chlorine residual analyzer which controls the feed rate of the chlorine feeders to maintain a particular residual in the treated water.

In the compound loop control system, the feed rate of the chlorinator is controlled by a flow proportional signal and a residual analyzer signal to maintain particular chlorine residual in the water.

Manual chlorine feed systems may be installed for groundwater systems with constant flow rates.

### Standby Provision

As a safeguard against malfunction and/or shut-down, standby chlorination equipment having the capacity to replace the largest unit shall be provided. For uninterrupted chlorination, gas chlorinators shall be equipped with an automatic changeover system. In addition, spare parts shall be available for all chlorinators.

### Weigh Scales

Scales for weighing cylinders shall be provided at all plants using chlorine gas to permit an accurate reading of total daily weight of chlorine used. At large plants, scales of the recording and indicating type are recommended. As a minimum, a platform scale shall be provided. Scales shall be of corrosion-resistant material.

### Securing Cylinders

All chlorine cylinders shall be securely positioned to safeguard against movement. Tag the cylinder "**empty**" and store upright and chained.

Ton containers may not be stacked.







### Chlorine measurement devices or Rotameters.

Chlorine is only slightly soluble in water; its maximum solubility is approximately one percent at 49° C. At temperatures below this point it combines with water to form chlorine ice, a crystalline substance. When the water supply to a gas chlorinator is below normal room temperature, it may cool the chlorine gas to the point at which chlorine ice is formed and accumulates on the needle valve and gas outlet tube, resulting in erratic feed results. Because the vapor pressure of chlorine increases with rising temperatures, its solubility also decreases. At 212° F. chlorine is insoluble in water.



**Safety Information:** There is a fusible plug on every chlorine gas cylinder. This metal plug will melt at 158° to 165° F. This is to prevent a build-up of excessive pressure and the possibility of cylinder rupture due to fire or high temperatures.

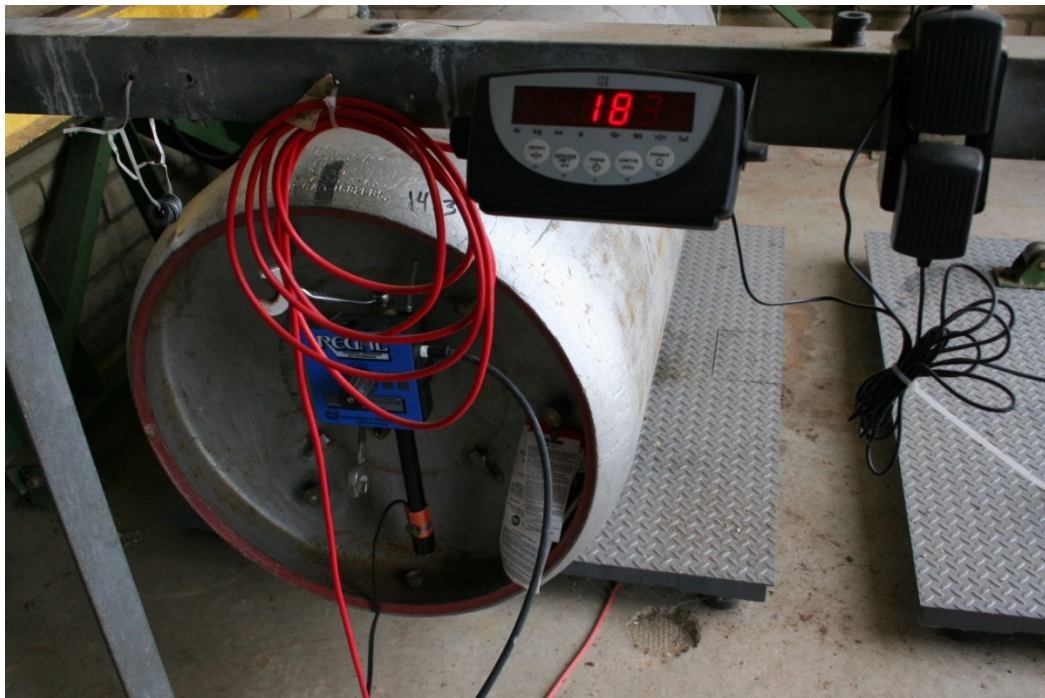


Small chlorine storage shed in the foreground; notice the vents at the bottom and top. The bottom vent will allow the gas to ventilate because  $\text{Cl}_2$  gas is heavier than air.

## Chlorine Diagrams #4



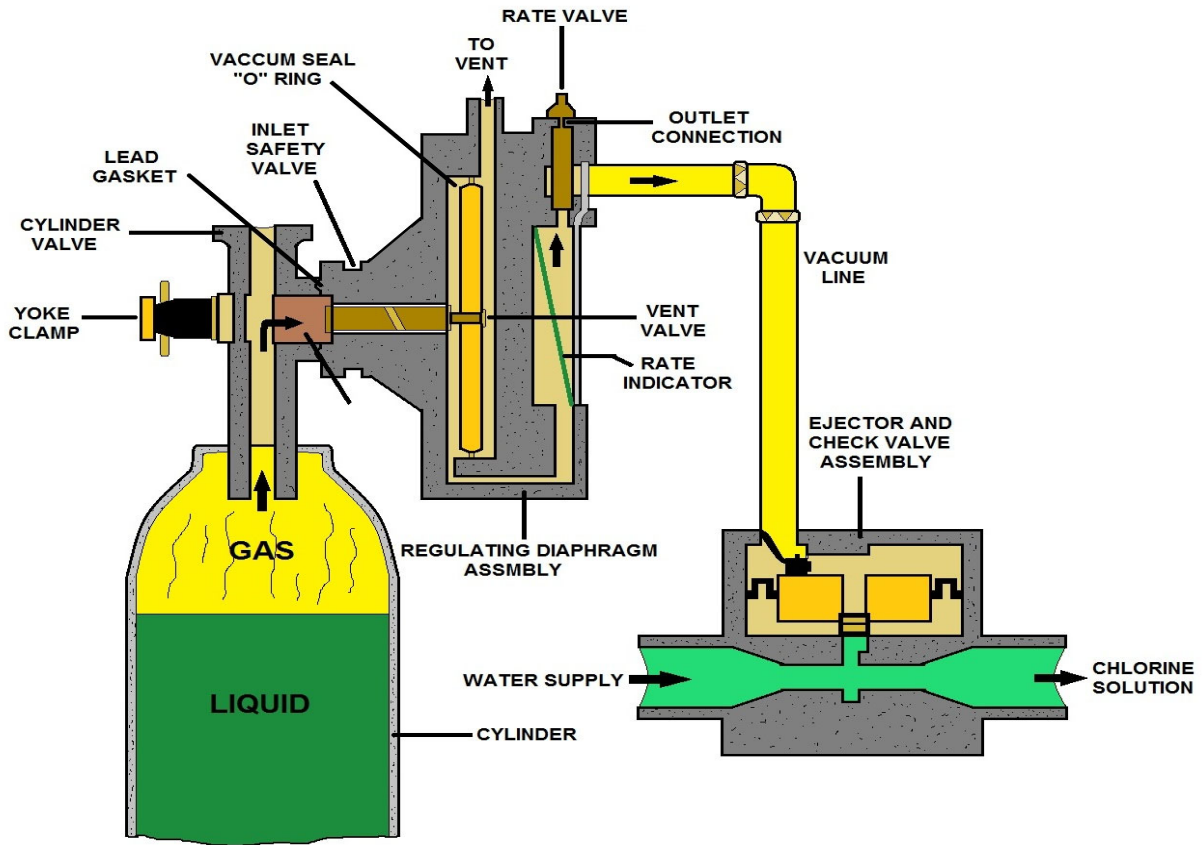
Top photograph, adjusting the chlorine leak alarm sensor. Bottom photograph, chlorine container weight scales.





1-ton chlorine containers. Automatic shutoff device connected to the liquid side only. The top valve is used for the gas. Remember that containers lay on their sides and cylinders stand upright. Roller bearings should not be used to rotate the container because of the ease of rotation is too great.





**150 LB SINGLE CHLORINE CYLINDER CHLORINATOR DIAGRAM #1**

**Cylinder Procedures**

When replacing the connection from a chlorine cylinder to a chlorinator always use a new, approved gasket on the connector and follow the manufacturer’s instructions.

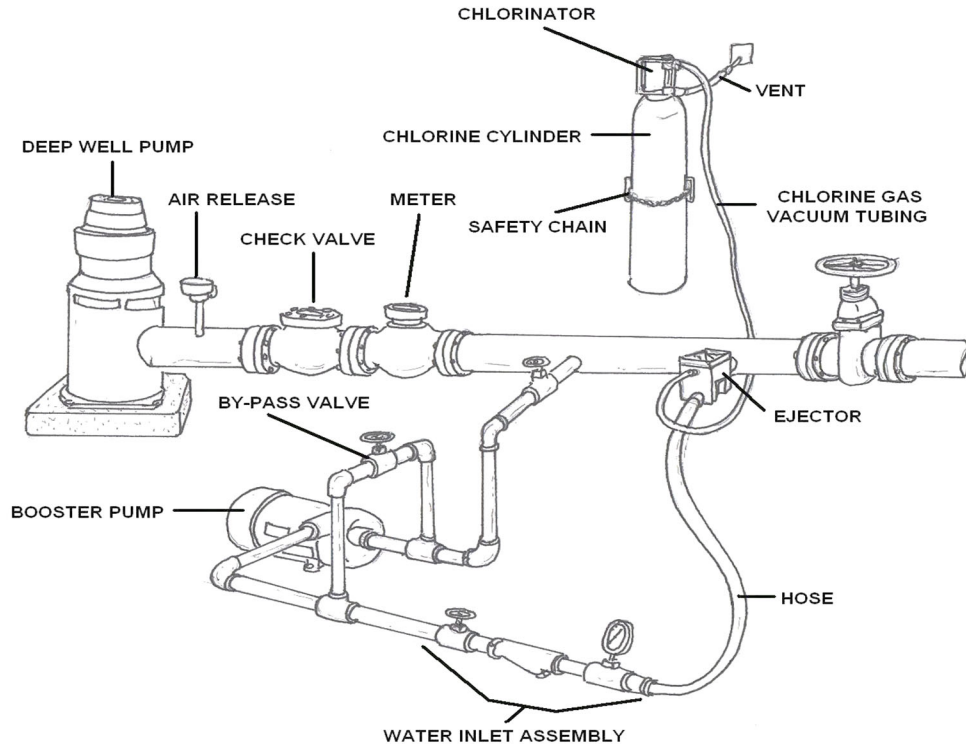
**Safety precautions when using chlorine gas:**

In addition to protective clothing and goggles, chlorine gas should be used only in a well-ventilated area so that any leaking gas cannot concentrate.

Approved method for storing a chlorine cylinder: Secure each cylinder in an upright position, attach the protective bonnet over the valve and firmly secure each cylinder.

**Emergency procedures in the case of a large uncontrolled chlorine leak:**

Notify local emergency response team, warn and evacuate people in adjacent areas, be sure that no one enters the leak area without adequate self-contained breathing equipment.



## 150 LB SINGLE CHLORINE CYLINDER CHLORINATOR DIAGRAM #2

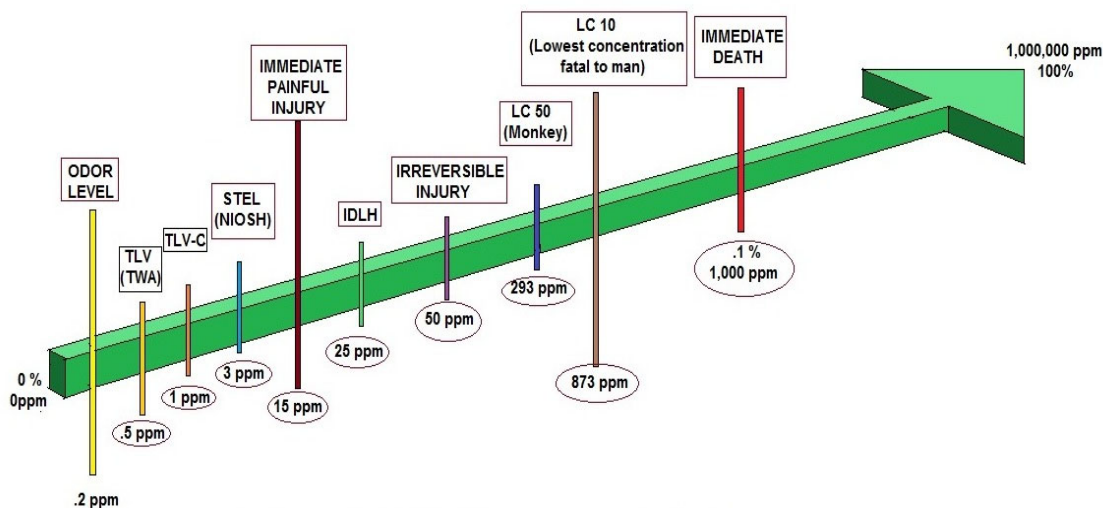
### Changing 100- and 150-Pound Cylinder Instructions

1. Turn valve stem clockwise to close cylinder valve.
2. Allow float in flow meter to drop to zero. Indicator on front of gas feeder should indicate no gas.
3. Wait about one minute. Float should remain at zero. If the float flutters or does not drop to zero, the valve is not closed tightly. Make sure the valve is closed before proceeding.
4. Turn off ejector, and make certain the gas supply indicator stays in the "No Gas" position by turning the "Reset" knob. If the indicator resets, either gas pressure is still present or there is an air leak in the system. Refer to instruction manual if an air leak is evident.
5. Loosen gas feeder yoke screw. Remove gas feeder from valve.
6. Replace gas cylinder. Be sure to use a chain or cable to secure the new cylinder properly.
7. Remove old lead gasket. Inspect and clean mating surfaces of gas feeder and valve. Install new lead gasket.
8. Position gas feeder on new gas cylinder and tighten yoke screw. Do not tighten excessively.
9. Crack open gas cylinder valve and close quickly.
10. Use ammonia solution to check for leaks. If a white cloud or vapor appears, turn on ejector and repeat steps 2, 3, 4, and correct leaks.
11. After you verify there are no leaks, open gas cylinder valve, about ¼-turn only, and leave cylinder wrench on valve.
12. Turn on the ejector.

### Notes:

- A. See your gas feeder manufacturer's guide for more detailed instructions.
- B. Immediately contact your gas supplier if the cylinder valve or cylinder is defective.

### Chlorine Diagrams #5



## CHLORINE POISON LINES

EXPOSURE LEVELS (ppm)	EFFECTS OF CHLORINE ON HUMANS
0.2 - 0.4 ppm	ODOR THRESHOLD (VARIES BY INDIVIDUAL)
Less than 0.5 ppm	NO KNOWN ACUTE OR CHRONIC EFFECT
0.5 ppm	ACGIH 8-HOUR TIME WEIGHTED AVERAGE
1.0 ppm	OSHA CEILING LEVEL (PEL)      ERPG - 1      TLV-STEL
1.0 - 10 ppm	IRRITATION OF THE EYES AND MUCOUS MEMBRANES OF THE UPPER RESPIRATORY TRACT. SEVERITY OF SYMPTOMS DEPENDS ON THE CONCENTRATIONS AND LENGTHS OF EXPOSURE
3 ppm	ERPG-2 (EMERGENCY RESPONSE PLANNING GUIDELINES AS VALUES DEVELOPED BY AIHA) IS THE MAXIMUM AIRBORNE CONCENTRATION BELOW WHICH IT IS BELIEVED THAT NEARLY ALL INDIVIDUALS COULD BE EXPOSED FOR UP TO 1-HOUR WITHOUT EXPERIENCING OR DEVELOPING IRREVERSABLE OR OTHER SERIOUS HEALTH EFFECTS THAT COULD IMPAIR AN INDIVIDUAL'S ABILITY TO TAKE PROTECTIVE ACTION.
10 ppm	NIOSH IDLH (IMMEDIATELY DANGEROUS TO LIFE AND HEALTH)
20 ppm	ERPG-3 IS THE MAXIMUM AIRBORNE CONCENTRATION BELOW WHICH IT IS BELIEVED THAT NEARLY ALL INDIVIDUALS COULD BE EXPOSED FOR UP TO 1-HOUR WITHOUT EXPERIENCING OR DEVELOPING LIFE-THREATENING HEALTH EFFECTS.

### EFFECTS OF CHLORINE EXPOSURE IN PARTS PER MILLION



Top photograph, a view of the top of a 150-pound gas cylinder. Bottom, always work in pairs when working around chlorine. Here the hoist is being used to move the 1-ton container. Employees are required to wear PPE while working with chlorine gas.

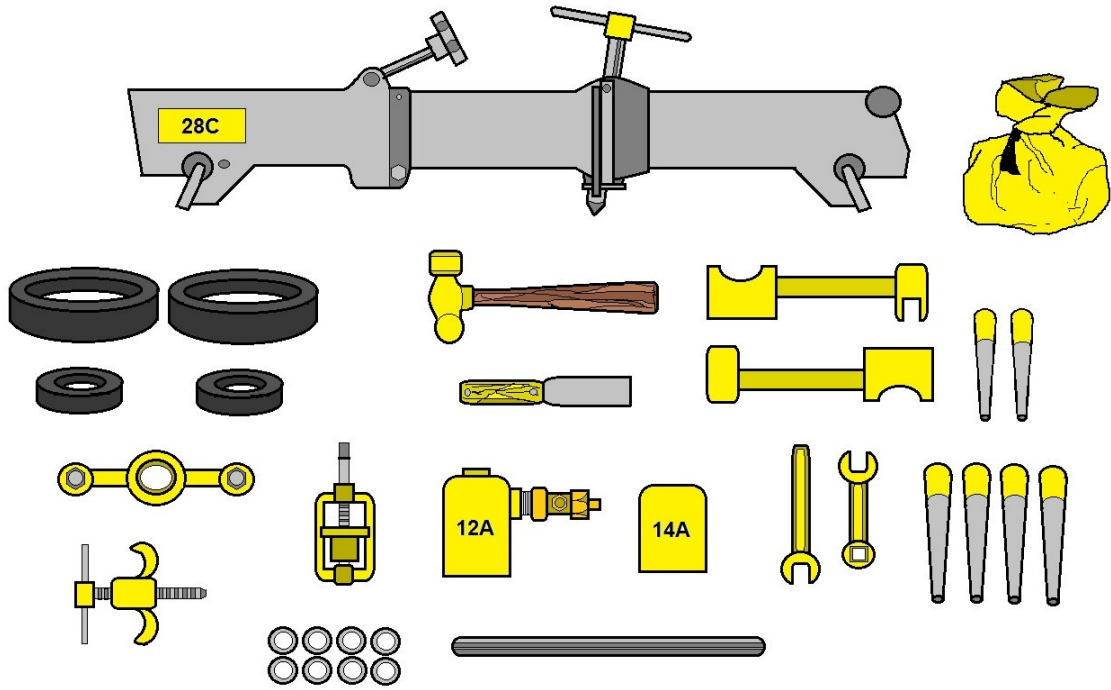






Top photograph, this blue device prevents the liquid from being pulled and freezing the lines. Bottom photograph, the application of an ammonia mist to detect a chlorine gas leak. Notice that employee is not wearing required PPE.





**SAMPLE OF INVENTORY OF CHLORINE EMERGENCY KIT "B"  
(CHLORINE 1-TON REPAIR KIT)**

## Chlorine Leak Detection - Example

Automatic chlorine leak detection and related alarm equipment shall be installed at all water treatment plants using chlorine gas. Leak detection shall be provided for the chlorine rooms. Chlorine leak detection equipment should be connected to a remote audible and visual alarm system and checked on a regular basis to verify proper operation.

Leak detection equipment shall not automatically activate the chlorine room ventilation system in such a manner as to discharge chlorine gas.

During an emergency, if the chlorine room is unoccupied, the chlorine gas leakage shall be contained within the chlorine room itself in order to facilitate a proper method of clean-up.

Consideration should also be given to the provision of caustic soda solution reaction tanks for absorbing the contents of leaking one-ton cylinders where such cylinders are in use.

Chlorine leak detection equipment may not be required for very small chlorine rooms with an exterior door (e.g., floor area less than 10 foot squared or 3m<sup>2</sup>).

You can use a spray solution of ammonia or a rag soaked with ammonia to detect a small Cl<sub>2</sub> leak. If there is a leak, the ammonia will create a white colored smoke, ammonium chloride.

### Safety Equipment

The facility shall be provided with personnel safety equipment including the following: Respiratory equipment; safety shower, eyewash, gloves, eye protection; protective clothing; cylinder and/or ton repair kits.

Respiratory equipment shall be provided which has been approved under the Occupational Health and Safety Act, General Safety Regulation - Selection of Respiratory Protective Equipment. Equipment shall be in close proximity to the access door(s) of the chlorine room.

### Chlorine Room Design Requirements

Where gas chlorination is practiced, the gas cylinders and/or the ton containers up to the vacuum regulators shall be housed in a gas-tight, well illuminated, corrosion resistant and mechanically ventilated enclosure. The chlorinator may or may not be located inside the chlorine room. The chlorine room shall be located at the ground floor level.

### Ventilation

Gas chlorine rooms shall have entirely separate exhaust ventilation systems capable of delivering one (1) complete air change per minute during periods of chlorine room occupancy only. The air outlet from the room shall be ½ inch or 150 mm above the floor and the point of discharge located to preclude contamination of air inlets to buildings or areas used by people. The vents to the outside shall have insect screens.

Air inlets should be louvered near the ceiling, the air being of such temperature as to not adversely affect the chlorination equipment. Separate switches for fans and lights shall be outside the room at all entrance or viewing points, and a clear wire-reinforced glass window shall be installed in such a manner as to allow the operator to inspect from the outside of the room.

**Heating**

Chlorine rooms shall have separate heating systems, if a forced air system is used to heat the building. The hot water heating system for the building will negate the need for a separate heating system for the chlorine room. The heat should be controlled at approximately 59° F or 15°C.

Cylinders or containers shall be protected to ensure that the chlorine maintains its gaseous state when entering the chlorinator.

**Access**

All access to the chlorine room shall only be from the exterior of the building. Visual inspection of the chlorination equipment from inside may be provided by the installation of glass window(s) in the walls of the chlorine room. Windows should be at least 8 inches squared or 0.20 m<sup>2</sup> in area, and be made of clear wire reinforced glass.

There should also be a '*panic bar*' on the inside of the chlorine room door for emergency exit.

**Storage of Chlorine Cylinders**

If necessary, a separate storage room may be provided to simply store the chlorine gas cylinders, with no connection to the line. The chlorine cylinder storage room shall have access either to the chlorine room or from the plant exterior, and arranged to prevent the uncontrolled release of spilled gas.

The chlorine gas storage room shall have provision for ventilation at thirty air changes per hour. Viewing glass windows and a panic button on the inside of the door should also be provided.

In very large facilities, entry into the chlorine rooms may be through a vestibule from outside.

**Scrubbers**

For facilities located within residential or densely populated areas, consideration shall be given to provide scrubbers for the chlorine room.

## Chlorine Gas Cylinder System Safety Procedures - Example

There is a need to emphasize major precautions to be observed while working with chlorine, which is a very dangerous gas. The following outlines a program governing the moving, storage, and maintenance procedures to be used for handling chlorine gas. Consult the Safety Engineer for procedures to be followed in an emergency, and the type of first aid treatment to be rendered to persons exposed to chlorine fumes.

This list does not cover everything, but covers general Chlorine gas safety principles.

You are required to wear PPE at all times. Chlorine gas is fatal and very dangerous to skin and clothing.

### 1. MOVING GAS CYLINDERS

- a. Never move a chlorine gas cylinder unless the cylinder valve cap is in place.
- b. Do not drop a cylinder or allow an object to strike the container with extreme force.
- c. Never apply heat to chlorine cylinders or valves.
- d. Any hand-truck used for moving cylinders shall have a clamp support at least two-thirds of the way up the cylinder.
- e. When lifting a cylinder using a crane or hoist, a special cradle or carrier should be used. Never use a rope sling, chain, or magnetic device.
- f. Never lift a cylinder by the valve cap or neck.

### 2. STORING CYLINDERS

- a. One extra, full or empty, container may be racked and stored in the chlorine room. (Depends upon safety pan) All other containers should be stored outside of attended power or pumping plants. The storage area should be cool and dry, and protected from all heat sources including the sun.
- b. Never store containers near the following: turpentine, ether, anhydrous ammonia, finely divided metals, hydrocarbons, oxygen cylinders, acetylene cylinders, or any flammable materials.
- c. The storage area shall be clean, well vented to atmosphere, and remote from elevators, gangways, ventilating systems, or any other type of area that would allow leaking gas to disperse rapidly throughout the building.
- d. Cylinder valve caps should always be screwed securely in place during storage.
- e. Cylinders should always be stored vertically and never stacked or laid horizontally. The storage room should never contain other stored material.

### 3. GENERAL PRECAUTIONS

- a. Never tamper with the fusible plug safety device on containers.
- b. Never alter or repair a container or valve. Tell the chlorine supplier if any damage is found.
- c. Never place a container in hot water, or apply direct heat to increase the flow rate, or for any other reason.
- d. A flexible copper tube connection should be used between the container and the piping system. Copper tubing shall be type K or L and sized for a minimum of 3500-

kPa (500-lb/in<sup>2</sup>) working pressure. A type L9.5 mm (3/8-1n) o.d. flexible copper tube is recommended.

e. Never perform maintenance work on a system unless the tank valves are closed.

f. When a container is empty the valve should be closed, lines disconnected, and the valve tested for leakage. An outlet pipe cap should be promptly attached and the cylinder valve cap secured. If the valve does not seat immediately, open and close it lightly until it seats. Never impact the valve or cylinder with anything, with the mistaken idea it would help make a tight valve closure.

g. To detect a chlorine gas leak, attach a cloth to the end of a stick, soak it with ammonia, and hold it close to the suspected area. A white cloud of ammonia chloride will result if there is a chlorine leak. Commercial ammonia must be used; household ammonia is not strong enough.

### **DO NOT GET ANY AMMONIA ON THE BRASS.**

h. Do not enter a chlorine contaminated area without wearing a self-contained breathing apparatus, which shall be available outside the chlorine room. Canister-type chlorine masks do not protect against chlorine concentration over 1 percent when the oxygen concentration is below 16 percent.

i. If a leak develops in a chlorine system, shut off the cylinder valves and ventilate the area to the outdoors prior to repairing the leak. Should a major leak develop which cannot be controlled, clear the area of personnel, and exhaust the fumes to the outdoors.

j. If a cylinder valve leaks, tighten the packing nut with the special wrench. Should it continue to leak, replace the outlet pipe cap and remove the cylinder to the outdoors.

k. If a cylinder leaks, tilt the cylinder to permit gas instead of liquid to escape. Less equivalent leakage can flow through a crack as gas than as liquid.

l. Do not use water on a chlorine leak.

m. In case of fire all cylinders should be removed from the fire zone Immediately.

## Chlorine Storage

Chlorine should be stored in a cool, dry, well-ventilated area in tightly sealed containers that are labeled in accordance with OSHA's Hazard Communication Standard [29 CFR 1910.1200].



Containers of chlorine should be protected from exposure to weather, extreme temperatures changes, and physical damage, and they should be stored separately from flammable gases and vapors, combustible substances (such as gasoline and petroleum products, hydrocarbons, turpentine, alcohols, acetylene, hydrogen, ammonia, and sulfur), reducing agents, finely divided metals, arsenic, bismuth, boron, calcium, activated carbon, carbon disulfide, glycerol, hydrazine, iodine, methane, oxomono-silane, potassium, propylene, silicon, hydrogen sulfide and water, carbon monoxide and sulfur dioxide, moisture, steam, and water.

Workers handling and operating chlorine containers, cylinders, and tank wagons should receive special training in standard safety procedures for handling compressed corrosive gases.

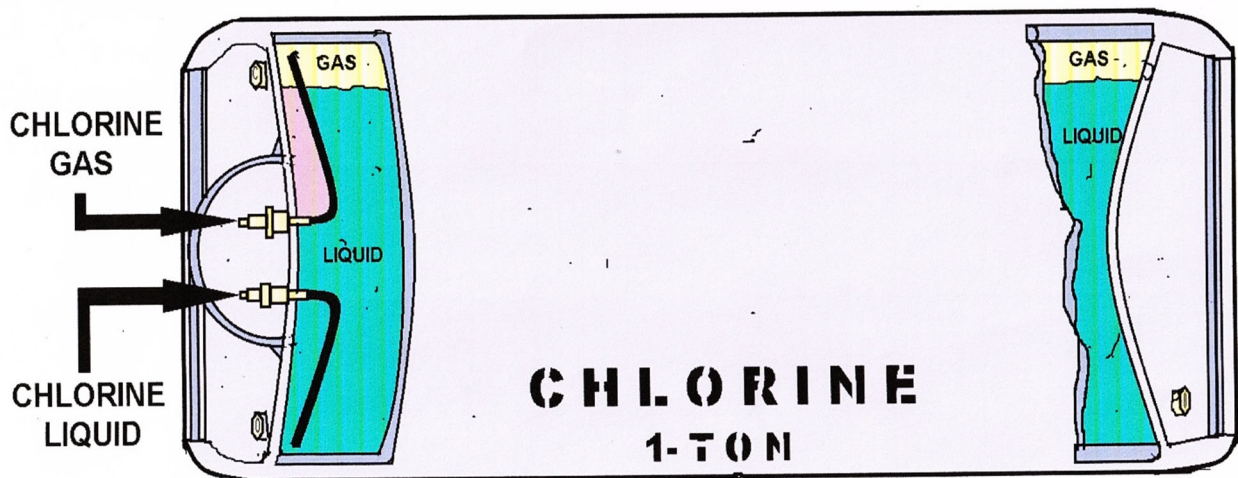
All pipes and containment used for chlorine service should be regularly inspected and tested. Empty containers of chlorine should have secured protective covers on their valves and should be handled appropriately.

## Spills and Leaks- Example

In the event of a spill or leak involving chlorine, persons not wearing protective equipment and fully-encapsulating, vapor-protective clothing should be restricted from contaminated areas until cleanup has been completed.

The following steps should be undertaken following a spill or leak:

1. Notify safety personnel.
2. Remove all sources of heat and ignition.
3. Keep all combustibles (wood, paper, oil, etc.) away from the leak.
4. Ventilate potentially explosive atmospheres.
5. Evacuate the spill area at least 50 feet in all directions.
6. Find and stop the leak if this can be done without risk; if not, move the leaking container to an isolated area until gas has dispersed. The cylinder may be allowed to empty through a reducing agent such as sodium bisulfide and sodium bicarbonate.
7. Use water spray to reduce vapors; do not put water directly on the leak or spill area.



## What handling and storage practices should be used when working with chlorine?

**Handling:** In event of a spill or leak, immediately put on escape-type respirator and exit the area. Immediately report leaks, spills or failures of the safety equipment (e.g. ventilation system). Secure cylinder in an up-right position. Protect cylinders from damage. Use a suitable hand truck to move cylinders; do not drag, roll, slide, or drop. Use the pressure regulator appropriate for cylinder pressure and contents.

**Storage:** Store in an area that is: cool, dry, well-ventilated, out of direct sunlight and away from heat and ignition sources, secure and separate from work areas, separate from incompatible materials, on the ground floor or preferably, in an isolated, detached building. Always secure (e.g. chain) cylinders in an upright position to a wall, rack or other solid structure. Label container with date received, date opened and disposal date. Use a first-in, first-out inventory system. Empty containers may contain hazardous residue. Store separately. Keep closed. Comply with all applicable health and safety regulations, fire and building codes.



## Chemical Spill Procedure - Example

### TOXIC CHEMICAL RELEASE: CHLORINE GAS, AMMONIA, AND LIQUID CHLORINE OR OTHER SUBSTANCE POSING IMMEDIATE HEALTH

**DANGER:** Evacuate the area. Close all fire doors. Contact the fire department or appropriate emergency response crew immediately. If the substance is liquid and a drain is in the area of the spill, contact the sewer department.

If it is safe for you to clean up the spill:

**READ SAFETY DATA SHEET (FORMERLY MSDS) (SDS) FOR SPILLED CHEMICAL.**

**Read the section STEPS TO BE TAKEN IN CASE MATERIAL IS RELEASED OR SPILLED.**

Read the **WASTE DISPOSAL METHOD** listed.

#### LOCATE CHEMICAL SPILLS KIT:

Apply gloves and protective eyewear.

Use chemical pads located in the kit to soak up the spill.

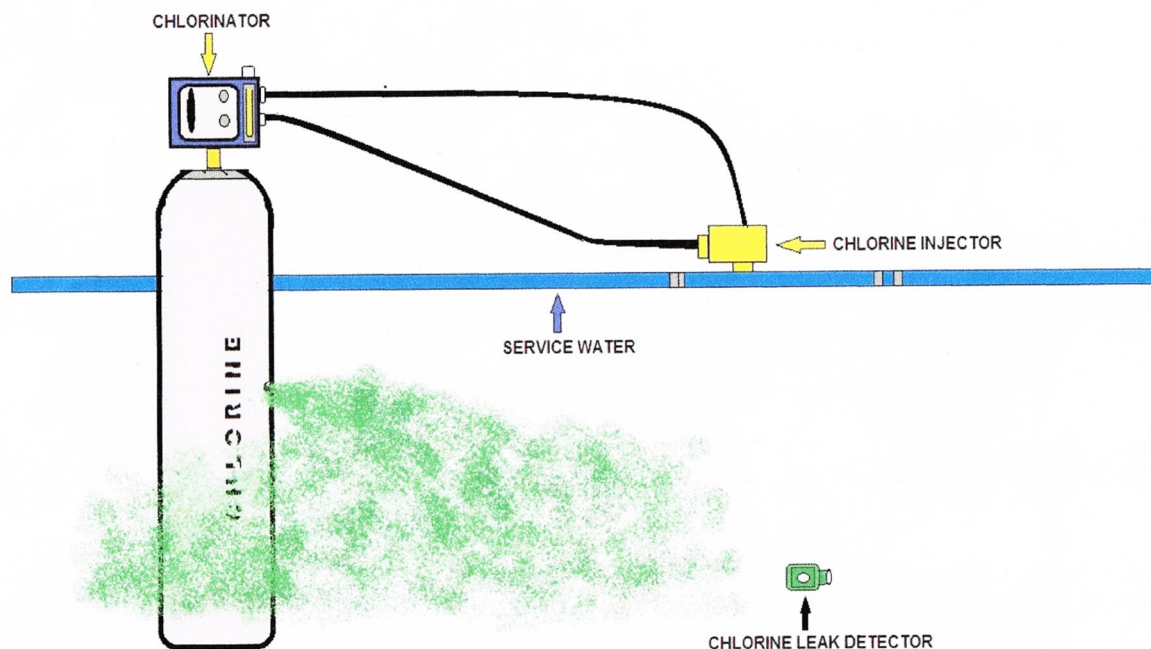
Place contaminated pads and gloves in the disposal bag and seal.

**IF THE CHEMICAL IS A HAZARDOUS CHEMICAL WASTE**, write the name of the chemical on the chemical label, attach the label to the disposal bag and notify a licensed Hazardous Waste Hauler for pick up. All other chemicals can be placed in regular trash.

Follow the methods listed on the SDS for cleaning the contaminated area.

Replace items used from the Chemical Spill Kit.





150 lb. CHLORINE CYLINDER LEAKING FROM SIDEWALL

## What are Accidental Release Measures for Chlorine?

**Personal Precautions:** Evacuate the area immediately. Isolate the hazard area. Keep out unnecessary and unprotected personnel. Vapor or gas may accumulate in hazardous amounts in low-lying areas especially inside confined spaces, if ventilation is not sufficient. Remove or isolate incompatible materials as well as other hazardous materials.

**Methods for Containment and Clean-up:** Small spills or leaks: stop or reduce leak if safe to do so. Ventilate the area to prevent the gas from accumulating, especially in confined spaces. Large spills or leaks: stop or reduce leak if safe to do so. Ventilate the area to prevent the gas from accumulating, especially in confined spaces. If possible, turn leaking container so that gas escapes rather than liquefied gas. Knock down gas with fog or fine water spray. Do not direct water at spill or source.

**Other Information:** Contact supplier, local fire and emergency services for help.

## Major Leak – Example

If you determine from outside the chlorine gas feed or storage room that there is a major leak, you could have a real problem not only for your fellow workers but also for nearby residents and for the plant equipment! Workers can protect themselves with SCBA. Residents may have to be evacuated.

### **We recommend the following steps, if you discover a Major Leak at your facility.**

1. Protect yourself at all times during the emergency, and make sure you will not be overcome by the leaking gas. Stay out of the chlorine gas room. Keep the SCBA ready. Chlorine gas escaping through the ventilation outlet may be collecting outside the chlorine gas room, so be careful outside as well.
2. Isolate the area.
3. Notify your supervisor.
4. Implement the Emergency Response Contingency Plan that has been established for your facility, in consultation with the Safety/Health Committee and/or Risk Management Department.

**NOTE:** The following steps should be customized as necessary.

5. Notify your Chlorop/Supplier, fire department, police, Spill Report Center, according to your facility's policy.
6. Follow directions given by Chlorop/Supplier.
7. Document the events. Take photographs. Measure the Chlorine in the air.
8. Notify the State or Occupational Safety and Health Administration and/or Environmental Protection Agency (for Possible Air Violations and Toxic Releases). Also contact the local Fire Department and your Risk Management personnel.



# Evacuation and Emergency Procedures-Example

## Leak Procedures

### Minor Leak

Note: A minor leak is a small leak which can be discharged to the environment without danger or when the source of the leak can be readily controlled.

**If you determine from outside the chlorine feed room that there is a minor leak, do the following:**

1. Notify your supervisor.
2. Have your safety partner don SCBA and be watching you from outside the chlorine room.
3. Equip yourself with a SCBA.
4. Enter chlorine gas room.

### Once Inside

5. Turn chlorine cylinder(s) OFF, leave water on.
6. Adjust feed rate to maximum to purge system.
7. Vacate room and remove air pack. Wait for 15 minutes, until chlorine pressure drops to zero or vacuum goes to maximum.
8. Do the Pre-Entry Check, put SCBA back on.
9. Crack open cylinder(s) and shut off right away.
10. Use ammonium hydroxide solution to find the leak.
11. Mark the leak.
12. Purge the system of gas as indicated on page 18, Section C (3), with the water still on.
13. Repair gently, using correct tools.
14. Start-up and re-check for leaks.
15. If no more leaks, place system back into service.



**NOTE:** If unable to repair the source of the leak, call it a Major Leak, and follow the appropriate emergency steps.

### 16. Clean up:

- remove air pack and recharge;
- air or launder clothes; and
- take a shower.

17. **Document the event completely.** Report the events which may have serious health or safety implications to the State or Federal Occupational Safety and Health Administration and/or Environmental Protection Agency (for Possible Air Violations and Toxic Releases). Also contact the local Fire Department and your Risk Management personnel.

# Emergency Response Contingency Plans–Example

## General Planning Considerations

1. The plan should be clear, concise and easy to use.
  2. Include diagrams of the surrounding land use and occupancy (e.g. schools, residences, hospitals, businesses, etc.), with the approximate distances.
  3. Include a diagram of the chlorine room layout. It should show equipment location, floor drainage direction, and show the north direction with an arrow. If a floor drain is installed, include drainage system details.
  4. Prepare a complete telephone list of the current employees, persons, organizations or other necessary contacts, including 24-hour emergency contact telephone numbers. The list should be revised, updated and distributed periodically by an assigned person.
  5. List the personal protective equipment available on-site and from the local fire department. Include phone number(s).
  6. List the emergency equipment and supplies available 24 hours a day on-site and from local suppliers. Include phone number(s).
  7. Refer to the Occupational Safety and Health Administration and/or Environmental Protection Agency for any assistance and advice.
  8. Routinely set up an emergency chlorine leak safety exercise. Practice makes perfect.
- When developing your detailed Emergency Response Contingency Plan, consider the following questions:

- Who may be affected by a potential incident? This is governed by site location, adjacent population, terrain, the amount of chemical stored at your facility and its potential for release.
- Is an emergency phone list of trained personnel available and updated periodically?
- When should outside emergency response agencies (chlorine supplier, CHLOREP team, government agency, etc.) be called? By whom?
- When should the news media be notified? By whom? What information should a statement include?
- Who should be contacted first, second, etc.? An emergency notification list should be developed and periodically updated. It should prioritize who is called, including your own utility personnel.
- Is there an evacuation procedure for employees at the facility? Was this reviewed in the last year?
- How do you notify the public (in close proximity to the facility) when to evacuate?
- Should barricades be set up to keep unauthorized personnel from the scene?
- Are proper chlorine leak detectors installed and functioning? Are the alarm systems routinely checked? Are audible and/or visual alarms observable from any approach to the contaminated area?
- Is the local fire department familiar with the facility and your chlorine emergency procedure?
- Does the treatment facility heating and air-conditioning system have to be shut down in a chlorine emergency at the facility?
- Should doors and windows in close proximity to the affected area be closed?
- Are the duty operator(s) familiar with emergency procedures?
- Are proper warning signs in place?
- Is a manual with chlorine emergency guidelines readily available?
- Is there proper documentation of training, equipment inspection, and incidents?
- Is emergency training adequate? Is the training instructor knowledgeable?
- Are personnel trained in the use of self-contained air packs and leak-repair kits? Is this equipment routinely inspected?

- Are medical examinations given to personnel who are trained in the use of self-contained air packs?
- Are chlorine Safety Data Sheet (formerly MSDS) (SDS) and first-aid procedures readily available?
- Stopping a leak-who, when and how? Personnel must be trained to determine when it is best to stop the leak or when to spend their efforts in other areas such as evacuation, you often cannot do both. Who is going to help you stop the leak? Are they nearby or must they travel a great distance?
- Who determines when it is safe to return to evacuated neighborhoods?
- How can your facility be put back into operation? What are the most likely sources of help to put your facility back into operation? How does the emergency plan fit into your operational plan for equipment breakdowns?
- Should the facility designer be notified?
- What else should I plan for?

## **Emergency Phone Contacts**

(To Be Posted Next To Chlorine Room Switches and Phone)

Name

Telephone

Supervisor:

Supervisor:

Operator:

Operator:

Operator:

Emergency Measures Organization (EMO) or Risk Management Team/Response Team

EMO Coordinator:

Fire Department:

Local Ambulance:

Local Hospital:

Fire Department

CHLORINE EMERGENCY RESPONSE: 24 hour collect call

Chlorine Supplier:

Chlorine Supplier:

CHLOREP TEAM:

CHLORINE INFORMATION:

## Special Requirements

The U.S. Environmental Protection Agency (EPA) requirements for emergency planning, reportable quantities of hazardous releases, community right-to-know, and hazardous waste management may change over time. Users are therefore advised to determine periodically whether new information is available.

### Emergency Planning Requirements

Employers owning or operating a facility at which there are 100 pounds or more of chlorine must comply with the EPA's emergency planning requirements [40 CFR Part 355.30].

### Reportable Quantity Requirements for Hazardous Releases

A hazardous substance release is defined by the EPA as any spilling, leaking, pumping, pouring, emitting, emptying, discharging, injecting, escaping, leaching, dumping, or disposing into the environment, including the abandonment or discarding of contaminated containers) of hazardous substances. In the event of a release that is above the reportable quantity for that chemical, employers are required to notify the proper Federal, State, and local authorities [40 CFR

### The Reportable Quantity of Chlorine is 10 Pounds.

If an amount equal to or greater than this quantity is released within a 24-hour period in a manner that will expose persons outside the facility, employers are required to do the following:

Notify the National Response Center immediately at (800) or at (202) 426-2675 in Washington, D.C. [40 CFR 302.6]. Notify the emergency response commission of the State likely to be affected by the release [40 CFR 355.40]. Notify the community emergency coordinator of the local emergency planning committee (or relevant local emergency response personnel) of any area likely to be affected by the release [40 CFR 355.40].

### Community Right-to-Know Requirements

Employers who own or operate facilities in SIC codes 20 to 39 that employ 10 or more workers and that manufacture 25,000 pounds or more of chlorine per calendar year or otherwise use 10,000 pounds or more of chlorine per calendar year are required by EPA [40 CFR Part 372.30] to submit a Toxic Chemical Release Inventory form (Form R) to the EPA reporting the amount of chlorine emitted or released from their facility annually.

### Hazardous Waste Management Requirements

EPA considers a waste to be hazardous if it exhibits any of the following characteristics: ignitability, corrosivity, reactivity, or toxicity as defined in 40 CFR 261.21-261.24. Under the Resource Conservation and Recovery Act (**RCRA**) [40 USC 6901 et seq.], the EPA has specifically listed many chemical wastes as hazardous.

Although chlorine is not specifically listed as a hazardous waste under RCRA, the EPA requires employers to treat waste as hazardous if it exhibits any of the characteristics discussed above.

Providing detailed information about the removal and disposal of specific chemicals is beyond the scope of this guideline. The U.S. Department of Transportation, the EPA, and State and local regulations should be followed to ensure that removal, transport, and disposal of this substance are conducted in accordance with existing regulations.

To be certain that chemical waste disposal meets the EPA regulatory requirements, employers should address any questions to the RCRA hotline at (703) 412-9810 (in the Washington, D.C. area) or toll-free at (800) 424-9346 (outside Washington, D.C.).

In addition, relevant State and local authorities should be contacted for information on any requirements they may have for the waste removal and disposal of this substance.





## Summary

Accidental exposure to chlorine gas need not be deadly when the proper safety procedures and equipment are in place. Both EPA and OSHA have strict regulations for the use of chlorine. Many accidents are preventable with the proper training and toxic gas monitoring safety equipment.

In the workplace, both portable gas detectors and fixed gas detection systems are employed to help protect workers from chlorine. Depending on the type of workplace hazard, one or both types of gas detectors may be in use. The use of chlorine is prevalent in so many industries that it is helpful to have a broader understanding of its applications before developing a chlorine gas safety program and determining the requirements for portable and/or fixed gas detectors in any plant.

### Protective Equipment for Systems that use Chlorine Gas

Respiratory equipment where employees handle chlorine: Your equipment should meet National Institute for Occupational Safety and Health requirements. It should use compressed air, have at least a 30-minute capacity, and be:

- Available where employees handle chlorine gas.
- Kept in a convenient location, but not inside any room where chlorine is used or stored.
- Compatible with—or identical to—the units your fire department uses.
- Tested and refilled regularly. Ask your fire department to inspect and test the unit(s).

### Other equipment:

- Each operator should have rubber gloves, a protective apron or other protective clothing, and goggles or a facemask.
- A deluge shower and eye washing station where operators use or store strong acids or alkalis. Provide warm water for the shower.

### The Buddy System

It's wise to have a second person present when you change or handle chlorine. If one operator is incapacitated, the other can call for help. Do not work alone!

### Separate Chlorine Room

It's important to have a separate room for chlorine gas. Check with local building officials, the fire marshal, and the Chlorine Institute about safe storage and use requirements for chlorine. The chlorine storage and feed rooms should be:

- Enclosed, sealed, and separated from other operating areas. On the downwind side of the building, away from entrances, windows, louvers, walkways, and other occupied areas.
- At least 60° F, but protected from extreme heat or direct sunlight.

### The room should have:

- A shatter-resistant inspection window mounted in an interior wall of the plant.
- Doors equipped with panic hardware that provide an easy escape by opening outward to the building exterior.
- A ventilating fan that exchanges the air at least once a minute. Run the fan whenever the room is occupied.

- An air intake near the ceiling and an exhaust near the floor. Make sure the fan exhausts outdoors and moves air as far as possible away from doors, air inlets, or occupied areas. Motorized louvers that provide airtight closure.
- Individual vandal-proof switches for the fan and lights located both outside the chlorine room and at the inspection window. Provide signal lights if you can control the fan from more than one location.

#### **A nonslip floor.**

Floor drains are a bad idea. If your chlorine room does have a floor drain, seal it or make sure it discharges outdoors away from air inlets, doors, or occupied areas. The drain should not connect to other internal or external drainage systems.

#### **Chlorine Leak Detection**

The chlorine room should have continuous leak-detection equipment with audible and visual alarms employees throughout the treatment plant can see and hear. Follow the manufacturer's recommendation for calibrating and testing the equipment. Record your findings.

You can use a rag soaked in concentrated ammonia solution to locate gas leaks at fittings and pipe connections. A white cloud or vapor indicates a leak. Make sure workers have a Chlorine Institute-approved leak repair kit (Kit A for cylinders and Kit B for containers).

### **For more information**

#### **The Chlorine Institute**

Get information on safe chlorine handling online at <http://www.chlorineinstitute.org/> (Go to bookstore and click on "Free titles about chlorine packaging" in the right column). The Chlorine Institute, Inc., Headquarters Office, 1300 Wilson Blvd., Arlington, VA 22209. Phone (703)741-5760 Fax (703)741-6068

#### **National Institute for Occupational Safety and Health (NIOSH)**

Find chlorine resources online at <http://www.cdc.gov/niosh/topics/chlorine/> NIOSH, Centers for Disease Control and Prevention, 1600 Clifton Rd., Atlanta, GA 30333. Phone (800) CDC-INFO (800-232-4636), TTY: (888) 232-6348, 24-hours a day, e-mail [cdcinfo@cdc.gov](mailto:cdcinfo@cdc.gov)

#### **Occupational Safety and Health Administration (OSHA)**

Find OSHA's guide to chlorine online at <http://www.osha.gov/SLTC/healthguidelines/chlorine/recognition.html> OSHA, 200 Constitution Avenue, NW, Washington, DC 20210

#### **Recommended Standards for Water Works**

Ten State Standards Published by Health Research Inc., Health Education Services Division, P.O. Box 7126, Albany, NY 12224. To order, call (518) 439-7286 or visit the Web site at <http://www.hes.org/HES/ten.html>

## Chlorination Equipment Requirement Post Quiz

1. \_\_\_\_\_ shall have entirely separate exhaust ventilation systems capable of delivering one (1) complete air change per minute during periods of chlorine room occupancy only.
2. Where gas chlorination is practiced, the gas cylinders and/or the ton containers up to the vacuum regulators shall be housed in a gas-tight, well illuminated, corrosion resistant and \_\_\_\_\_.
3. The chlorinator may or may not be located inside \_\_\_\_\_.
4. \_\_\_\_\_ should be louvered near *the ceiling*, the air being of such temperature as to not adversely affect the chlorination equipment.
5. \_\_\_\_\_ should be outside the room at all entrance or viewing points, and a clear wire-reinforced glass window shall be installed in such a manner as to allow the operator to inspect from the outside of *the room*.
6. What related chlorine alarm equipment shall be installed at all water treatment plants using chlorine gas?
7. You can use a spray solution of ammonia or a rag soaked with sulfur dioxide to detect a small  $\text{Cl}_2$  leak. If there is a leak, the sulfur dioxide will create a white colored smoke - *Sulfuric chloride*.  
A. True      B. False
8. What related chlorine alarm equipment should be connected to a remote audible and visual alarm system and checked on a regular basis to verify proper operation?
9. During an emergency, if *the chlorine room* is occupied, the chlorine gas leakage shall be contained within the chlorine room itself in order to facilitate a proper method of clean-up.  
A. True      B. False

10. Consideration should also be given to the provision of *caustic soda solution reaction tanks* for absorbing the contents of leaking one-ton cylinders where such cylinders are in use.

A. True      B. False

11. If necessary, \_\_\_\_\_ may be provided to simply store the chlorine gas cylinders, with no connection to the line.

12. \_\_\_\_\_ shall have provision for ventilation at thirty air changes per hour?

13. Sometimes entry in very large facilities, may be through a vestibule from outside in to?

#### **Chlorine Health Hazard Section**

14. \_\_\_\_\_ expresses low levels of chlorine results in eye, nose, and throat irritation, sneezing, *Excessive salivation*, general excitement, and restlessness.

15. \_\_\_\_\_ expresses low levels of chlorine gas can result in a dermatitis known as chloracne, tooth enamel corrosion, coughing, sore throat, hemoptysis and increased susceptibility to tuberculosis.

16. \_\_\_\_\_ expresses coughing, sneezing, shortness of breath, sensation of tightness in the chest, as well as severe restlessness or Anxiety, nausea, and vomiting.

17. The nose and throat may become irritated; a stinging and *Burning sensation* may be experienced. Immediate fatalities can occur as a result of suffocation. Delayed fatalities can occur as a result of pulmonary edema (fluid in the lungs). For this reason, rest and immediate attention after inhalation is important.

A. True      B. False

18. If breathing has stopped, give artificial respiration; if breathing is difficult, give oxygen if equipment and trained personnel are available. If exposed person is breathing, place in a comfortable position and keep person warm and at rest until medical assistance becomes available.

A. True      B. False

# Chapter 7 - Alternative Disinfectants

**Section Focus:** You will learn the basics of water disinfection with an emphasis alternative disinfectants. At the end of this section, you will be able to describe various alternative disinfectants. There is a post quiz at the end of this section to review your comprehension and a final examination in the Assignment for your contact hours.

**Scope/Background:** Traditionally, the use of chlorine gas was the most common method of water disinfection, however, Chlorine gas creates dangerous disinfection by-products. Therefore, we need to utilize alternative disinfectants, like chlorine dioxide, ozone and ultraviolet radiation.

		MICROBIOLOGICAL SAFETY	CHEMICAL SAFETY	CUSTOMER AESTHETICS	EASE OF MONITORING	ABILITY TO TREAT DIFFICULT WATER	COST OF OPERATING	CAPITAL COSTS	STATE OF COMMERCIAL DEVELOPMENT	SCALE-UP	WASTE PRODUCTION AND ENERGY USE	RELIABILITY
GROUNDWATER	CHLORINE	-	-	-	+	+	+	+	+	+	+	-
	UF ONLY	-	+	+	-	+	●	●	-	-	●	-
	UV ONLY	+	+	+	●	+	+	●	+	+	●	●
	Alternate + Residual (1)	+	●	●	+	+	●	-	+	+	+	+
SURFACE WATER	CHLORINE ONLY	-	-	-	+	-	+	+	+	+	+	+
	Conventional pre-treat + CHLORINE	+	-	-	+	-	●	●	+	+	●	-
	UF ONLY	-	-	●	-	-	●	●	-	-	●	-
	Conventional pre-treat +UF	●	+	+	-	+	-	-	-	-	-	-
	Coventional pre-treat + OZONE + UF	-	●	-	-	+	-	-	-	-	-	-
	MF + UV	●	+	-	●	-	+	●	-	-	●	+
	Conventional pre-treat + UV	●	+	+	●	-	+	●	+	+	●	●
	Conventional pre-treat + OZONE + UV	+	●	+	+	+	-	-	+	+	●	+
	Alternative + Residual (2)	+	●	●	+	+	-	-	+	+	+	+

Conventional pre-treat = Coagulation / Sedimentation  
 UF - Ultrafiltration MF - Microfiltration  
 + = Better than average  
 - = Worse than average  
 ● = Average

(1) UF + Chlorine residual or Conv + UV + Chlorine residual  
 (2) Conv pre-treat + UF + Chlorine residual or MF + UV + Chlorine residual or Conv pre-treat + UV + Residual

## DETERMINATION ASSESSMENT OF EFFECTIVE DISINFECTION METHODS

### **Chloramine**

Chloramine is a very weak disinfectant for Giardia and virus reduction. It is recommended that it be used in conjunction with a stronger disinfectant. It is best utilized as a stable distribution system disinfectant because it limits the formation of DBPs. In the production of chloramines, the ammonia residuals in the finished water, when fed in excess of the stoichiometric amount needed, should be limited to inhibit growth of nitrifying bacteria.

### **Chlorine Dioxide**

Chlorine dioxide may be used for either taste or odor control or as a pre-disinfectant. Total residual oxidants (including chlorine dioxide and chlorite, but excluding chlorate) shall not exceed 0.30 mg/L during normal operation or 0.50 mg/L (including chlorine dioxide, chlorite and chlorate) during periods of extreme variations in the raw water supply. Chlorine dioxide provides good Giardia and virus protection, but its use is limited by the restriction on the maximum residual of 0.5 mg/L  $\text{ClO}_2$ /chlorite/chlorate allowed in finished water. Where chlorine dioxide is approved for use as an oxidant, the preferred method of generation is to entrain chlorine gas into a packed reaction chamber with a 25% aqueous solution of sodium chlorite ( $\text{NaClO}_2$ ).

### **Ozone ( $\text{O}_3$ )**

Ozone is a very effective disinfectant for both Giardia and viruses. Ozone CT values( contact time) must be determined for the ozone basin alone; an accurate T10 value must be obtained for the contact chamber, residual levels measured through the chamber and an average ozone residual calculated.

### **Ultraviolet Radiation**

The enormous temperatures on the sun create ultraviolet (UV) rays in great amounts, and this radiation is so powerful that all life on earth would be destroyed if these rays were not scattered by the atmosphere and filtered out by the layers of ozone gas that float some 20 miles above the earth.

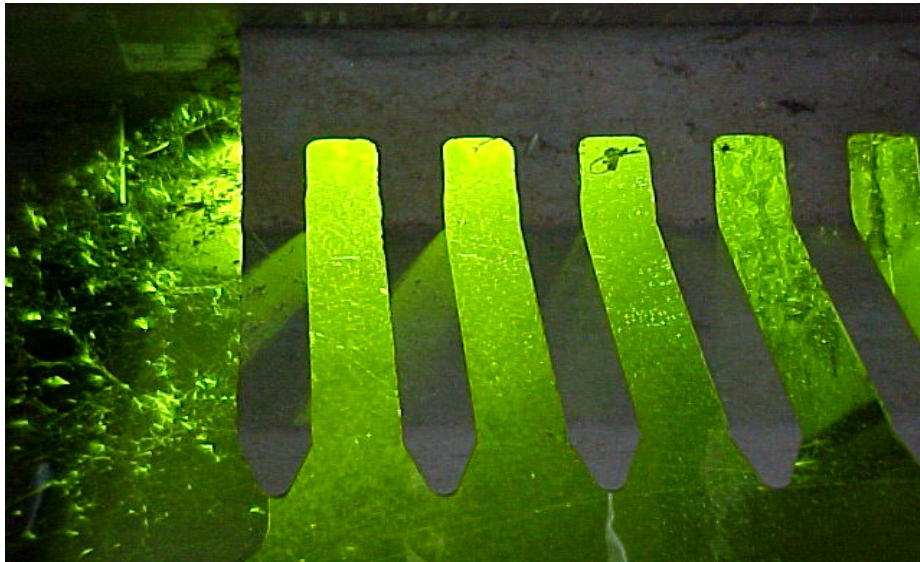


Photo of the visible green UV light

## Water Treatment Disinfectants Review

Many water suppliers add a disinfectant to drinking water to kill germs such as giardia and e coli. Especially after heavy rainstorms, your water system may add more disinfectant to guarantee that these germs are killed.

### **Chlorine**

Some people who use drinking water containing chlorine well in excess of EPA's standard could experience irritating effects to their eyes and nose. Some people who drink water containing chlorine well in excess of the EPA's standard could experience stomach discomfort.

### **Chloramine**

Some people who use drinking water containing chloramines well in excess of EPA's standard could experience irritating effects to their eyes and nose. Some people who drink water containing chloramines well in excess of the EPA's standard could experience stomach discomfort or anemia.

### **Chlorine Dioxide**

Some infants and young children who drink water containing chlorine dioxide in excess of the EPA's standard could experience nervous system effects. Similar effects may occur in fetuses of pregnant women who drink water containing chlorine dioxide in excess of the EPA's standard. Some people may experience anemia.

***Disinfectant alternatives will include Ozone, and Ultraviolet light. You will see an increase of these technologies in the near future.***

### **Disinfection Byproducts (DBPS)**

Disinfection byproducts form when disinfectants added to drinking water to kill germs react with naturally-occurring organic matter in water.

### **Total Trihalomethanes**

Some people who drink water containing trihalomethanes in excess of the EPA's standard over many years may experience problems with their liver, kidneys, or central nervous systems, and may have an increased risk of getting cancer.

### **Haloacetic Acids**

Some people who drink water containing haloacetic acids in excess of the EPA's standard over many years may have an increased risk of getting cancer.

### **Bromate**

Some people who drink water containing bromate in excess of the EPA's standard over many years may have an increased risk of getting cancer.

### **Chlorite**

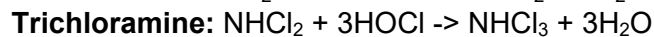
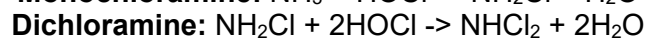
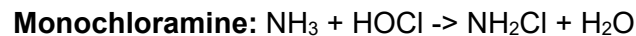
Some infants and young children who drink water containing chlorite in excess of the EPA's standard could experience nervous system effects. Similar effects may occur in fetuses of pregnant women who drink water containing chlorite in excess of the EPA's standard. Some people may experience anemia.

## Commonly Used Water Disinfectants

Contaminant	MRDL <sup>1</sup> (mg/L) <sup>2</sup>	MRDL <sup>1</sup> (mg/L) <sup>2</sup>	Potential Health Effects from Ingestion of Water	Sources of Contaminant Drinking Water
Chloramines (as Cl <sub>2</sub> )	MRDLG=4 <sup>1</sup>	MRDL=4.0 <sup>1</sup>	Eye/nose irritation; stomach discomfort, anemia	Water additive used to control microbes
Chlorine (as Cl <sub>2</sub> )	MRDLG=4 <sup>1</sup>	MRDL=4.0 <sup>1</sup>	Eye/nose irritation; stomach discomfort	Water additive used to control microbes
Chlorine dioxide (as ClO <sub>2</sub> )	MRDLG=0.8 <sup>1</sup>	MRDL=0.8 <sup>1</sup>	Anemia; infants & young children: nervous system effects	Water additive used to control microbes

## Chloramine Breakdown

Monochloramine and dichloramine are formed in the pH range of 4.5 to 8.5, however, monochloramine is most common when the pH is above 8. When the pH of the water is below 4.5, the most common form of chloramine is trichloramine, which produces a very foul odor. The equations for the formation of the different chloramines are as follows: (Reynolds & Richards, 1996)



Chloramines are an effective disinfectant against bacteria but not against viruses. As a result, it is necessary to add more chlorine to the water to prevent the formation of chloramines and form other stronger forms of disinfectants.

The final step is that additional free chlorine reacts with the chloramine to produce hydrogen ion, water, and nitrogen gas that will come out of solution. In the case of the monochloramine, the following reaction occurs:



Thus, added free chlorine reduces the concentration of chloramines in the disinfection process. Instead the chlorine that is added is allowed to form the stronger disinfectant, hypochlorous acid.

Perhaps the most important stage of the water or wastewater treatment process is the disinfection stage. This stage is most critical because it has the greatest effect on public health as well as the health of the world's aquatic systems.

It is important to realize that treatment is not a cut and dry process but requires in depth knowledge about the type of water or wastewater being treated and its characteristics to obtain optimum results.



## Water Disinfection Methods Review

Disinfection is an important step in ensuring that water is safe to drink. Water systems add disinfectants to destroy microorganisms that can cause disease in humans. The Surface Water Treatment Rule requires public water systems to disinfect water obtained from surface water supplies or groundwater sources under the influence of surface water. Primary methods of disinfection are chlorination, chloramines, ozone, and ultraviolet light. Other disinfection methods include chlorine dioxide, potassium permanganate, and nanofiltration. Since certain forms of chlorine react with organic material naturally present in many water sources to form harmful chemical by-products, the U.S. Environmental Protection Agency has proposed maximum levels for these contaminants.

Many people in most developing countries suffer from the inadequacy or hazardous condition of public water supplies (WHO 1985). A wide variety of known waterborne diseases, including those associated with children's diarrhea, are rampant (Tartakow and Vorperian 1980; Feachem et al. 1983; WHO 1984, 1987). This prompted the establishment of the International Drinking Water Supply and Sanitation Decade. It aims at providing about 90% of the human population with an adequate, safe community water supply by 1990 (WHO 1985).

In Lebanon, the shortage of community water supplies, their actual or potential pollution from anthropogenic sources, inadequate treatment, and the resultant spread of associated diseases are still unresolved problems (Acra et al. 1985). To curb these issues would require implementing feasible measures for prevention and treatment. These should include sanitation and disinfection of drinking water.

### Physical Methods

Formation of mutagenic and carcinogenic agents in water and wastewater effluent treated with chlorine has prompted research to seek alternative disinfecting methods that would minimize environmental and public health impacts. The technology, based on nonchemical methods, is undergoing rapid development. Some techniques are already available commercially. This category is represented by techniques employing such physical principles for disinfection as W radiation, ultrasound, ultrafiltration, reverse osmosis, heating, freezing, and ionizing radiation (Cheremissinoff et al. 1981).

Disinfecting small quantities of water by pasteurizing with heat or solar energy is a technology with some potential, but requires further development (Cheremissinoff et al. 1981; Ciochetti and Metcalf 1984). The recently developed method for water disinfection by direct exposure to solar radiation (Acra et al. 1980, 1984) is further described in the following sections.

### Chemical Methods

Chemical methods depend mostly on selected chemicals with oxidizing and biocidal properties. Their practical applications range from removing undesirable constituents to disinfecting water supplies, wastewater treatment effluent, or industrial waters. The most commonly used chemicals include ozone, chlorine and some of its compounds, potassium permanganate, and hydrogen peroxide.

Ozone has been used for water disinfection for about 80 years in France, Germany, and other European countries.

It is now undergoing a critical evaluation as a possible alternative to chlorine when used alone or in conjunction with other disinfection systems (Foster et al. 1980; Kott et al. 1980; Dolora et al. 1981; Venosa 1983; Rakness et al. 1984; Wickramanayake et al. 1984; Den-Blanken 1985).

There is some evidence that it forms smaller amounts of hazardous trihalomethanes (THM) when employed to treat polluted waters or wastewater effluent than either chlorine or chlorine dioxide. However, its potential for producing other equally toxic substances is still not clearly defined (Glaze 1987). Ozonation has become popular in North America partly because of its superiority over chlorination. It enhances the coagulation process despite its inherent weakness in leaving practically no residual in the distribution system.

Interhalogen compounds, formed from two different halogens, resemble their parent substances in properties and germicidal characteristics. The interhalogens BrCl, ICl, and IBr have recently been investigated as possible alternative disinfectants for water and wastewater effluent (Groninger and Mills 1980; Cheremissinoff et al. 1981). Added to water, they rapidly hydrolyze to the corresponding hypohalous acids, which are stronger oxidants and disinfectants than hypochlorous acid. For instance, BrCl is hydrolyzed to HCl and HOBr. However, their improved germicidal activity is counterbalanced by the formation of haloforms. They react with humates in water or wastewater effluent by the haloform reaction (HOBr, for example, reacts with humates yielding bromoform). In this context, hypobromite would be formed in seawater by reaction of the natural bromides with hypochlorites in chlorinated wastewater effluent or cooling waters from power plants (Sugam and Helz 1980; Wong 1982; Bousher et al. 1986). This also applies to natural waters rich in bromides with subsequent formation of bromoform and other trihalomethanes (Amy et al. 1984; Rav-Acha, Choshen et al. 1985; Rav-Acha, Serri et al. 1985; Ishikawa et al. 1986; Guttman-Bass et al. 1987). Consequently, coastal groundwater affected by seawater infiltration should create some concern if used for drinking.

Using hydrogen peroxide for water disinfection began in the 1950s in Eastern Europe (Laubusch 1971). Although it has been well known for its high oxidative and germicidal activity, its application as a water disinfectant has not gained wide acceptance. Its increasing use, however, has been noted (Gaudy and Gaudy 1980). The degradation of organic matter in water treated sequentially with up to 0.5% by weight of hydrogen peroxide and W radiation (>200 nm) has been reported (Malaiyandi et al. 1982).

In another form of application, hydrogen peroxide produced no significant oxidation of soluble manganese in water containing organic matter in the pH range of 5.0-8.0 (Knocke et al. 1987). A newly marketed product (Sanosil, Sanosil AG, Feldmeilen, Switzerland) is claimed to be applicable to large-scale water disinfection; its effective bacteriostatic and fungicidal activity has been demonstrated at concentrations of 10-35 mg/L on *Escherichia coli*, *Klebsiella pneumoniae*, *Streptococcus aureus*, *Pseudomonas aeruginosa*, *Proteus mirabilis*, *Micobacter* spp., *Chlamidia sporogenes*, and *Candida albicans*. The two active biocidal constituents of this product are hydrogen peroxide and colloidal silver.

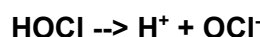
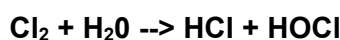
### **Chlorination and Dechlorination**

The use of chlorine and some of its derivatives will continue as an integral part of the disinfection process in water and wastewater treatment. This also applies to developing countries, where this mode of disinfection is fairly well established (Mara 1978; Droste and McJunkin 1982; Smethurst 1983). Apart from almost a century of chlorination practices (Laubusch 1962a, b; Cheremissinoff et al. 1981), two other favorable determinants are the technical expertise already acquired and the relatively low costs involved.

In the wake of the recent discovery of the formation of THM in chlorinated natural waters (Rook 1974), and their potential health hazards (Glaze et al. 1980; Williamson 1981; Carpenter and Beresford 1986), its credibility is diminishing.

Alternative disinfecting agents such as chlorine dioxide (Rav-Acha et al. 1985b), UV light (Severin et al. 1984; Scheible 1987), and UV light in conjunction with hydrogen peroxide (Crandall 1986) are being considered. However, the formation of mutagens and carcinogens in chlorinated waters and wastewaters can be abolished or minimized by modifying the unit processes (Stelter et al. 1984; Fiessinger et al. 1985; Finger et al. 1985; Huang et al. 1985; Kool et al. 1985; Moyers and Wu 1985; Suh and Abdel-Rahman 1985; Means et al. 1986; Rogers and Lauer 1986; Guttman-Bass et al. 1987; Knocke et al. 1987). The potential health impacts that are yet to be clearly discerned and the toxicity to aquatic life resulting from discharged chlorinated effluent (Brungs 1973; Jolley et al. 1980) do not seem to outweigh the public health benefits derived from chlorination practices (Cortruvo 1985). However, as the controversy continues, epidemiological studies (Craun 1985) and the pertinent drinking water standards and legislation (Toft 1985) are being revised.

Reactions of chlorine in water that form the basis for its application as a disinfectant and oxidant are as follows:



These reactions in water devoid of other inorganic or organic matter that could react with chlorine are pH and temperature dependent. The products, hypochlorous acid (HOCl) and hypochlorite ions ( $\text{OCl}^-$ ), are referred to as free available chlorine (FAC). The biocidal activity is attributed chiefly to HOCl, as it is more effective than the  $\text{OCl}^-$ . In the presence of natural or added ammonium ions, HOCl reacts to form chloramines, known as combined available chlorine (CAC). As a disinfectant, FAC is more effective. It is essential to chlorinate beyond the subsequent attainment of FAC at the desired level for optimal biocidal effectiveness ("free residual" chlorination).

The influencing factors to be considered in chlorination practices are the following:

- chlorine concentration,
- contact time,
- pH,
- temperature, and
- interfering substances.

The relationship between chlorine concentration ( $C$ , milligrams per liter) and contact time ( $T$ , minutes) required for a specific percentage destruction of microorganisms is expressed as a constant ( $CT = K$ ) (Gaudy and Gaudy 1980). The proper use of this  $CT$  relationship to determine adequate water chlorination requirements has been emphasized as an approach to prevent and control waterborne diseases. Minimum  $CT$  values of 15-30 for systems using groundwater as a source and 100-150 for those using surface supplies have been recommended (Lippy 1986).

Based on these values, the required FAC concentration can be determined mathematically for a given contact time. Once the chlorine demand ( $D$ ) for a water supply is determined by testing,

then the optimal chlorine dose to attain the desired free chlorine residual (C) can be calculated by addition: chlorine dose = D + C.

One of the factors in the many waterborne disease outbreaks in the United States in the past decades was failure to comply with the *CT* relationship in chlorination practices (Lippy and Waltrip 1984; Bitton et al. 1986; Lippy 1986; Williams and Akin 1986).

In addition, the need for the disinfection of wastewater discharged into streams has been emphasized and justified by the 23 different kinds of pathogenic organisms present in wastewater from US communities (Shertzer 1986).

Excess chlorine residuals can be controlled by a dechlorination procedure. Of the various chemicals used for the partial or complete removal of the residual chlorine in water or wastewater, sulfur dioxide gas (SO<sub>2</sub>) is the most common (Laubusch 1971; Cheremissinoff et al. 1981; Finger et al. 1985; Huang et al. 1985). Dechlorination is often applied to heavily dosed water supplies as they are aesthetically objectionable to consumers or undesirable for industrial water uses. Chlorinated cooling waters and wastewaters need to be dechlorinated before discharging into water bodies in view of their toxicity to aquatic life. They have also potentially harmful effects because of the formed THM.

### **Household Methods**

There are many situations where individuals or families would need to resort to simple and effective methods for drinking-water disinfection. These include the following:

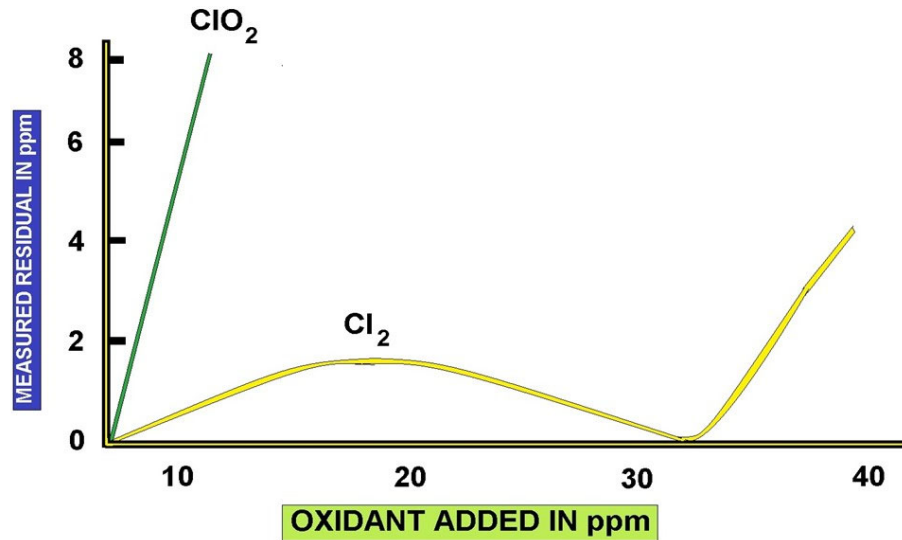
- catastrophic conditions leading to displacement (earthquakes, floods, hurricanes, wars, or civil disturbances);
- emergencies arising from flourishing waterborne diseases; and
- resident populations and foreigners at risk in endemic areas with unsafe water supplies.

Physical methods (boiling or the use of ceramic filters), chemical methods (chlorine compounds in solution or tablet form, e.g., sodium hypochlorite solutions, calcium hypochlorite tablets, organic chlorine compounds, iodine solution, and organic iodine compounds) and others have been recommended for such cases (Morris et al. 1953; Gershenfeld 1957; Hadfield 1957; Cox 1969; O'Connor and Cooper 1970; WHO 1972, 1973; Rajagopalan and Shiffman 1974; UNHCR 1982).

None of these methods is entirely free from practical problems that could induce users to revert to untreated water. Fuelwood, for instance, for boiling is no longer a tenable practice, particularly in areas where it is absent or being depleted. Besides, the flat taste of boiled water discourages some consumers. The diverse types of ceramic filters have a wide range of pore sizes and present difficulties in selection. They suffer frequent clogging of the ceramic candles and often leak through disguised fine cracks.

Proprietary halogen preparations frequently lead to consumer complaints and rejection because of the undesirable tastes and odors imparted to the water. It is especially so if high doses are applied inadvertently or as required in cases of heavily polluted waters. Relief agencies are often trapped in a dilemma by the requirements for importing and distributing, in addition to shortages, cost acceptability, and expiry dates. These issues encourage attempts to resolve them through the development of practical and effective techniques, simple enough to be applied by individuals or households.

## Chlorine Dioxide Sub-Section



### USING CHLORINE DIOXIDE vs CHLORINE

Skin contact	Solutions are highly irritant
Skin Absorption	Gas may be absorbed, causing tissue and blood cell damage.
Eye Contact	Severe Irritant. Exposure may cause visual disturbance, i.e., seeing haloes around lights.
Inhalation	A severe respiratory irritant. May cause bronchospasm and pulmonary edema, which may be delayed in onset. May also cause severe headache. All symptoms may be delayed and long-lasting. Long-term exposure may cause bronchitis. An LC <sub>50</sub> value of 500 ppm/ 15m <sup>3</sup> (rat) is quoted in the literature.
Ingestion	Not applicable except for solutions, in which case the symptoms would be expected to parallel those for inhalation.
Exposure Limits	ACGIH 1992-93: TWA 0.1 ppm, STEL 0.3 ppm. Most legal limits are similar.
Irritancy	Severe
Sensitization	Information not available.
Carcinogenicity	Not listed by IARC or ACGIH.
Teratogenicity & Mutagenicity	No information is available.
Reproductive Toxicology	No information is available.
Toxicological Synergism	May have synergistic effects in conjunction with chlorine, other chlorine oxides, and chlorine fluorine compounds

The threshold limit value (TLV) established by the American Conference of Governmental Industrial Hygienists is 0.1 ppm. Two cases of poisoning (one fatal) resulted from exposure to less than 19 ppm while the victims were inside an empty bleach tank. Concentrations of 150 ppm were fatal to guinea pigs in 44 minutes. Characteristic acute effects from over exposure are coughing, eyes and nose watering and the development of a sore throat. Burns resulting from chlorine are severe since the decomposition produces  $\text{Cl}_2$ .

### **More about Chlorine Dioxide**

Chlorine dioxide is generated on-site at water treatment facilities. The popularity of chlorine dioxide as a water disinfectant increased in the 1970s when it was discovered that it did not promote THM formation. Chlorine dioxide ( $\text{ClO}_2$ ), long used in the paper industry, has been an acceptable and effective alternative to chlorination in cooling systems.

Chlorine dioxide is a yellow-green gas with an irritating odor not unlike chlorine. It cannot be compressed and shipped in a container, so it must be generated on site.

There are three proven methods of efficiently generating chlorine dioxide. The most common is the chlorine/chlorite or "one pump" method.  $\text{ClO}_2$  generation uses sodium chlorite ( $\text{NaClO}_2$ ) and chlorine gas. Chlorine gas is educted into a motive water stream in a  $\text{ClO}_2$  generator forming HOCl and HCl. Sodium chlorite is pumped into the stream and allowed to react in a generating column to produce  $\text{ClO}_2$ .

A second, common method of generation uses NaOCl and HCl in place of chlorine gas. Also referred to as the "three pump" method of generation, this method is valuable to a facility that wants to eliminate gaseous chlorine.

A third, more recent method of generation uses sodium chlorate ( $\text{NaClO}_3$ ) and sulfuric acid. This differs from the other two methods in that  $\text{ClO}_2$  is generated in a vacuum and is then educted into the motive water stream.

Chlorine dioxide holds many advantages over chlorine in cooling water systems.  $\text{ClO}_2$  is considerably more selective than chlorine in the presence of various compounds, which allows it to be more effective in contaminated systems. Table 2 lists a series of compounds for which chlorine would show a greater affinity than  $\text{ClO}_2$ . Under certain conditions  $\text{ClO}_2$  may, in fact, be two-and-one-half times more reactive than chlorine. Under efficient  $\text{ClO}_2$  generation, THMs are not formed and THM precursors are reduced. In one application, THM formation was reduced from 34 m g/l to 1 m g/l using  $\text{ClO}_2$ .

Chlorine dioxide does not hydrolyze in water as does chlorine and there is no dissociation of  $\text{ClO}_2$ . It remains fully active in a pH range far broader than chlorine or sodium hypochlorite. Since  $\text{ClO}_2$  remains a gas in water, it does not have the corrosive tendencies of chlorine gas. Its selectivity generally allows for lower dosages compared to chlorine, limiting the amount of aggressive  $\text{Cl}^-$  available to attack passivated metal surfaces. Finally,  $\text{ClO}_2$  is much less aggressive to traditional corrosion inhibitors.

Hypochlorous acid, whether formed from the dissolution of chlorine gas or sodium hypochlorite in water, has satisfactorily controlled microorganisms in cooling water systems. However, dissolution does yield a mineral acid or caustic soda that may adversely affect system pH, inhibitor passivation layers or metal surfaces.

Hypochlorous acid is heavily pH-dependent, because as system pH increases, there is a correspondingly rapid decrease in the concentration of the biocidally active species. It is also a non-specific oxidant which readily reacts with various organic and inorganic compounds that may be present in a cooling water system. Some of these reactions tend to yield undesirable by-products which are regulated or may be regulated in the future.

The effects of pH on hypochlorous acid and its reactivity with a variety of compounds both combine to vastly diminish its effectiveness in contaminated, high-pH cooling water systems. Conversely, chlorine dioxide remains completely pH-independent in the range where recirculating and once-through cooling systems are typically operated.

Since  $\text{ClO}_2$  is a dissolved gas in water, there is no mineral acid or caustic soda formation as happens when using HOCl. Chlorine dioxide tends to be much less, if not totally non-reactive, with many organic and inorganic compounds.

### **Chlorine Dioxide Advantages**

- Acts as an excellent virucide.
- Does not react with ammonia nitrogen to form chlorinated amines.
- Does not react with oxidizable material to form THMs; destroys up to 30% of THM precursors.
- Destroys phenols that cause taste and odor problems in potable water supplies.
- Forms fewer chlorinated DBPs such as THMs, HAAs and TOX.
- Disinfects and oxidizes effectively, including good disinfection of both *Giardia* and *Cryptosporidium*.
- Works at low dosage in post-disinfection step with no need of booster stations.
- Improves removal of iron and manganese by rapid oxidation and settling of oxidized compounds.
- Does not react with bromide to form bromate or brominated by-products.
- Has enhanced turbidity removal under certain conditions.

### **Chlorine Dioxide Disadvantages**

- Reacts with natural organic matter and forms inorganic by-products. Chlorite ion, and to a lesser extent chlorate ion, are formed when chlorine dioxide is used.
- Requires on-site generation equipment and handling of chemicals.
- Occasionally poses unique odor and taste problems.

### **First Aid and Treatment**

a) Remove the victim from the contaminated area at once. Loosen all constrictive clothing around the neck.

b) If breathing has stopped, apply artificial respiration.

c) Oxygen should be administered by an (external) Emergency Response Team in case of severe exposure.

d) Call a physician as soon as possible and keep patient warm and quiet.

e) If conscious, discourage coughing; essence of peppermint is sometimes given.

### Reactive Chemical Hazards

- During preparation of gaseous ClO<sub>2</sub> decomposition can occur beyond 100 mm Hg partial pressure or above 100°C.
- Chlorine dioxide is incompatible with ammonia, mercury vapors, methane, phosphine and hydrogen sulfide.
- Chlorine dioxide gas is a highly unstable substance. Long stagnation of the vapors will result in an explosive decomposition. Vapors are reactive with most organics.

### Chlorine Dioxide Methods

Most tests for chlorine dioxide rely upon its oxidizing properties. Consequently, numerous test kits are readily available that can be adapted to measure chlorine dioxide. In addition, new methods that are specific for chlorine dioxide are being developed. The following are the common analytical methods for chlorine dioxide:

	DPD glycine	Chlorophenol Red	Direct Absorbance	Iodometric Titration	Amperometric Titration
<b>Method Type:</b>	Colorimetric	Colorimetric	Colorimetric	Titrimetric	Titrimetric
<b>How It Works</b>	Glycine removes Cl <sub>2</sub> ; ClO <sub>2</sub> forms a pink color, whose intensity is proportional to the ClO <sub>2</sub> concentration.	ClO <sub>2</sub> bleaches chlorophenol red indicator. The degree of bleaching is proportional to the concentration of ClO <sub>2</sub> .	The direct measurement of ClO <sub>2</sub> is determined between 350 and 450 nM.	Two aliquots are taken one is sparged with N <sub>2</sub> to remove ClO <sub>2</sub> . KI is added to the other sample at pH7 and titrated to a colorless endpoint. The pH is lower to 2, the color allowed to reform and the titration continued. These titrations are repeated on the sparged sample.	
<b>Range</b>	0.5 to 5.0 ppm.	0.1 to 1.0 ppm	100 to 1000 ppm	> 1 ppm	< 1ppm
<b>Interferences</b>	Oxidizers	None	Color, turbidity	Oxidizers	
<b>Complexity</b>	Simple	Moderate	Simple	Moderate	High
<b>Equipment Required</b>	Spectrophotometer or Colorimeter			Titration equipment	Amperometric Titrator
<b>EPA Status</b>	Approved	Not approved	Not approved	Not approved	Approved
<b>Recommendation</b>	Marginal	Yes	Marginal	Yes	Marginal



## Chlorine Dioxide Questions

**1) Q: Is chlorine dioxide more expensive than chlorine?**

**A:** Yes. Generally, chlorine dioxide is used only when chlorine is not capable of doing the job at hand, or when the use of chlorine creates unacceptable levels of by-products, such as THM or HAA.

**2) Q: When applying chlorine dioxide for drinking water treatment, how do I ensure that I don't exceed the chlorite MCL?**

**A:** To make sure that chlorite levels in drinking water treated with chlorine dioxide don't exceed the MCL, you should apply pure chlorine dioxide at a dose of no more than about 1.5ppm, depending on the particular water matrix being treated. (Generally, 50-70% of the applied chlorine dioxide "winds up" as chlorite.)

**3) Q: What is the chlorite MCL for drinking water?**

**A:** The chlorite MCL allowed in drinking water is 1.0 mg/l.

**4) Q: What is the chlorate MCL for drinking water?**

**A:** There is no MCL for chlorate for drinking water, due to insufficient toxicology data. However, the State of California has set an "advisory level" for chlorate of 0.8mg/l.

**5) Q: What is the practical dosage limit for chlorine dioxide for drinking water treatment?**

**A:** The practical dosage limit for chlorine dioxide in drinking is driven by compliance with the chlorite MCL, and is about 1.5mg/l unless chlorite is removed prior to the water leaving the plant.

**6) Q: Will switching from chlorine gas to hypochlorite (bleach) help control disinfection byproducts (THM, HAA)?**

**A:** Switching from chlorine gas to hypochlorite addresses risks associated with potential chlorine gas release; the chemistry of chlorine and hypochlorite in water are substantially the same, so far as DBP formation is concerned.

**7) Q: Can chlorine dioxide kill Cryptosporidium?**

**A:** Chlorine dioxide can kill Cryptosporidium far better than chlorine. However, a relatively high CxT (concentration x time) product is still required to get substantial Cryptosporidium kill with chlorine dioxide, especially in cold water. Only water treatment utilities with very long intake structures and low-demand raw water can expect to achieve significant Cryptosporidium reduction (1-2 logs) with chlorine dioxide alone.

**8) Q: Can chlorine dioxide remove off-tastes and odors from drinking water?**

**A:** Chlorine dioxide is effective at the removal of many off-tastes and odors associated with drinking water. However, chlorine dioxide is substantially ineffective in controlling certain "earthy-musty" odor causing compounds, such as MIB and Geosmin.

**9) Q: Does chlorine dioxide form bromate ion when used to treat bromide-containing water?**

**A:** Chlorine dioxide does not oxidize bromide ion to form bromate ion, unless the reaction is photolyzed. That is, some bromate ion may be formed in the presence of light.

**10) Q: Does chlorine dioxide react with organics to produce trihalomethanes (THM) or haloacetic acids (HAA)?**

**A:** In contrast to chlorine, chlorine dioxide does not react with organics (to any appreciable extent) to produce THM or HAA.

**11) Q: What is the typical chlorine dioxide dosage for drinking water treatment?**

**A:** The chlorine dioxide dosage for drinking water treatment depends on the particular application, as well as on the water matrix being treated. For example, a typical dosage for manganese removal might be 0.25-0.50ppm; for primary disinfection, a dose of 0.75 to 1.25ppm is more likely.

## **Phosphine**

Phosphine is the common name for phosphorus hydride ( $\text{PH}_3$ ), also known by the IUPAC name phosphane. It is a colorless, flammable gas with a boiling point of 88 °C at standard pressure. Pure phosphine is odorless, but "technical grade" phosphine has a highly unpleasant odor like garlic or rotting fish, due to the presence of substituted phosphine and diphosphine ( $\text{P}_2\text{H}_4$ ).

Phosphine is highly toxic; it can easily kill in relatively low concentrations. Because of this, the gas is used for pest control by fumigation. For farm use, it is often sold in the form of aluminum phosphide pellets, which yield phosphine on contact with atmospheric water.

These pellets also contain other chemicals which evolve ammonia which helps to reduce the potential for spontaneous ignition or explosion of the phosphine gas. They also contain other agents (e.g. methanethiol) to give the gas a detectable garlic smell to help warn against its presence in the atmosphere. Phosphine is also used as a dopant in the semiconductor industry.

## Chlorine Dioxide Testing Methods

Most tests for chlorine dioxide rely upon its oxidizing properties. Consequently, numerous test kits are readily available that can be adapted to measure chlorine dioxide. In addition, new methods that are specific for chlorine dioxide are being developed. The following are the common analytical methods for chlorine dioxide:

	<b>DPD glycine</b>	<b>Chlorophenol Red</b>	<b>Direct Absorbance</b>	<b>Iodometric Titration</b>	<b>Amperometric Titration</b>
<b>Method Type:</b>	Colorimetric	Colorimetric	Colorimetric	Titrimetric	Titrimetric
<b>How It Works</b>	Glycine removes Cl <sub>2</sub> ; ClO <sub>2</sub> forms a pink color, whose intensity is proportional to the ClO <sub>2</sub> concentration.	ClO <sub>2</sub> bleaches chlorophenol red indicator. The degree of bleaching is proportional to the concentration of ClO <sub>2</sub> .	The direct measurement of ClO <sub>2</sub> is determined between 350 and 450 nM.	Two aliquots are taken one is sparged with N <sub>2</sub> to remove ClO <sub>2</sub> . KI is added to the other sample at pH7 and titrated to a colorless endpoint. The pH is lower to 2, the color allowed to reform and the titration continued. These titrations are repeated on the sparged sample.	
<b>Range</b>	0.5 to 5.0 ppm.	0.1 to 1.0 ppm	100 to 1000 ppm	> 1 ppm	< 1ppm
<b>Interferences</b>	Oxidizers	None	Color, turbidity	Oxidizers	
<b>Complexity</b>	Simple	Moderate	Simple	Moderate	High
<b>Equipment Required</b>	Spectrophotometer or Colorimeter			Titration equipment	Amperometric Titrator
<b>EPA Status</b>	Approved	Not approved	Not approved	Not approved	Approved
<b>Recommendation</b>	Marginal	Yes	Marginal	Yes	Marginal

## Additional Drinking Water Methods (Non EPA) for Chemical Parameters

Method	Method Focus	Title	Order Number	Source
4500-Cl B	Chloride by Silver Nitrate Titration	Standard Methods for the Examination of Water and Wastewater, 18th & 19th Ed.	Included in Standard Methods	American Water Works Assn. ( <b>AWWA</b> )
4500-Cl D	Chloride by Potentiometric Method	Standard Methods for the Examination of Water and Wastewater, 18th, 19th & 20th Editions	Included in Standard Methods	American Water Works Assn. ( <b>AWWA</b> )
4500-Cl D	Chlorine Residual by Amperometric Titration (Stage 1 DBP use SM 19th Ed. only)	Standard Methods for the Examination of Water and Wastewater, 18th, 19th & 20th Editions	Included in Standard Methods	American Water Works Assn. ( <b>AWWA</b> )
4500-Cl E	Chlorine Residual by Low Level Amperometric Titration (Stage 1 DBP use SM 19th Ed. only)	Standard Methods for the Examination of Water and Wastewater, 18th, 19th & 20th Editions	Included in Standard Methods	American Water Works Assn. ( <b>AWWA</b> )
4500-Cl F	Chlorine Residual by DPD Ferrous Titration (Stage 1 DBP use SM 19th Ed. only)	Standard Methods for the Examination of Water and Wastewater, 18th, 19th & 20th Editions	Included in Standard Methods	American Water Works Assn. ( <b>AWWA</b> )
4500-Cl G	Chlorine Residual by DPD Colorimetric Method (Stage 1 DBP use SM 19th Ed. only)	Standard Methods for the Examination of Water and Wastewater, 18th, 19th & 20th Editions	Included in Standard Methods	American Water Works Assn. ( <b>AWWA</b> )
4500-Cl H	Chlorine Residual by Syringaldazine (FACTS) Method (Stage 1 DBP use SM 19th Ed. only)	Standard Methods for the Examination of Water and Wastewater, 18th, 19th & 20th Editions	Included in Standard Methods	American Water Works Assn. ( <b>AWWA</b> )
4500-Cl I	Chlorine Residual by Iodometric Electrode Technique (Stage 1 DBP use SM 19th Ed. only)	Standard Methods for the Examination of Water and Wastewater, 18th, 19th & 20th Editions	Included in Standard Methods	American Water Works Assn. ( <b>AWWA</b> )
4500-ClO <sub>2</sub> C	Chlorine Dioxide by the Amperometric Method I	Standard Methods for the Examination of Water and Wastewater, 18th, 19th & 20th Editions	Included in Standard Methods	American Water Works Assn. ( <b>AWWA</b> )
4500-ClO <sub>2</sub> D	Chlorine Dioxide by the DPD Method (Stage 1 DBP use SM 19th Ed. only)	Standard Methods for the Examination of Water and Wastewater, 18th, 19th & 20th Editions	Included in Standard Methods	American Water Works Assn. ( <b>AWWA</b> )
4500-ClO <sub>2</sub> E	Chlorine Dioxide by the Amperometric Method II (Stage 1 DBP use SM 19th Ed. only)	Standard Methods for the Examination of Water and Wastewater, 18th, 19th & 20th Editions	Included in Standard Methods	American Water Works Assn. ( <b>AWWA</b> )

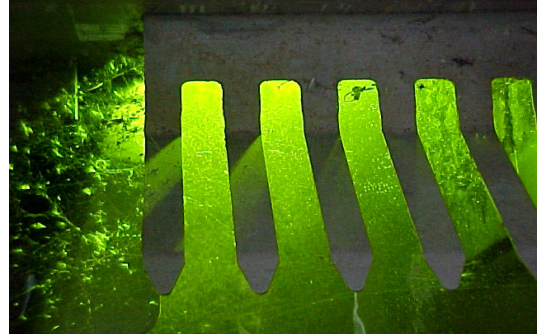
## Ultraviolet Disinfection

This process involves exposing water to ultraviolet (UV) radiation, which inactivates various microorganisms. The technique has enjoyed increased application in wastewater treatment but very limited application in potable water treatment.

The enormous temperatures on the sun create ultraviolet (UV) rays in great amounts, and this radiation is so powerful that all life on earth would be destroyed if these rays were not scattered by the atmosphere and filtered out by the layers of ozone gas that float some 20 miles above the earth.

This radiation can be artificially produced by sending strong electric currents through various substances. A sun lamp, for example, sends out UV rays that, when properly controlled, result in a suntan. Of course, too much will cause sunburn.

The UV lamp that can be used for the disinfection of water depends upon the low-pressure mercury vapor lamp to produce the ultraviolet energy. A mercury vapor lamp is one in which an electric arc is passed through an inert gas. This in turn will vaporize the mercury contained in the lamp; and it is a result of this vaporization that UV rays are produced.

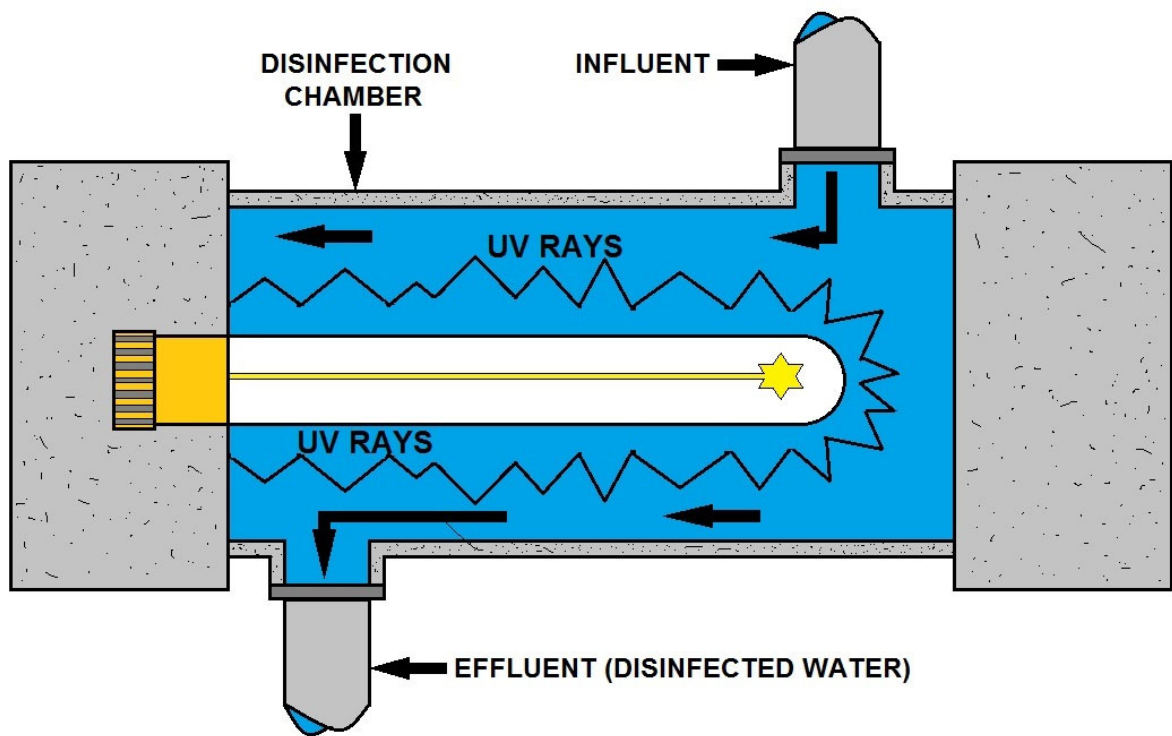


The lamp itself does not come in to contact with water, the lamp is placed inside a quartz tube, and the water is in contact with the outside of the quartz tube. Quartz is used in this case since practically none of the UV rays are absorbed by the quartz, allowing all of the rays to reach the water. Ordinary glass cannot be used since it will absorb the UV rays, leaving little for disinfection.

The UV sterilizer will consist of a various number of lamps and tubes, depending upon the quantity of water to be treated. As water enters the sterilizer, it is given a tangential flow pattern so that the water spins over and around the quartz sleeves.

In this way the microorganisms spend maximum time and contact with the outside of the quartz tube and the source of the UV rays. The basic design flow of water of certain UV units is in the order of 2.0 gpm for each inch of the lamp. Further, the units are designed so that the contact or retention time of the water in the unit is not less than 15 seconds.

UV disinfection transfers electromagnetic energy from a mercury arc lamp to a pathogen's DNA material, thus affecting its ability to replicate itself. UV's effectiveness depends on the characteristics of the wastewater, the intensity of the UV radiation being emitted, the length of time that the water comes in contact with the UV radiation, and the arrangement of the UV reactor.



## USING ULTRA VIOLET RAYS TO DISINFECT WATER

UV has the advantage of being effective at inactivating viruses and, because it's a physical process rather than a chemical process, there are no residual constituents remaining in the treated wastewater after exposure to UV. Also, the contact time for the wastewater with the UV source is the shortest of any of the disinfectant strategies, lasting no longer than 20 to 30 seconds.

Disadvantages include the effects of turbidity in the water reducing the infiltration and therefore the effectiveness of UV and the need to provide an effective cleaning and replacement program for the UV components.

"If you just need pure disinfection you probably would tend towards UV rather than ozone".  
"The cost of the UV just for disinfection is usually less than ozone, and the amount of equipment needed is less.



### **UV DISINFECTION UNIT ON WASTEWATER EFFLUENT**

But every water treatment has to be looked at individually in order to get what you want. Sometimes you cannot use UV because the waste treatment is too turbid; if you can filter it to get the turbidity levels down, maybe you'll use UV."

Primarily, there are two designs for UV systems. One system involves a non-contact design in which the UV-light system is suspended away from contact with the water. The second system is the contact reactor-type design in which the lamps are encased in a quartz sleeve that is submerged in the water. This contact-type system is further separated by whether it is an open- or closed-channel system.

The open-channel system submerges the lamps in either a horizontal or vertical arrangement. A closed-channel system is within a sealed chamber that can be used in a pressurized system. The open-channel system is mostly used in wastewater treatment.

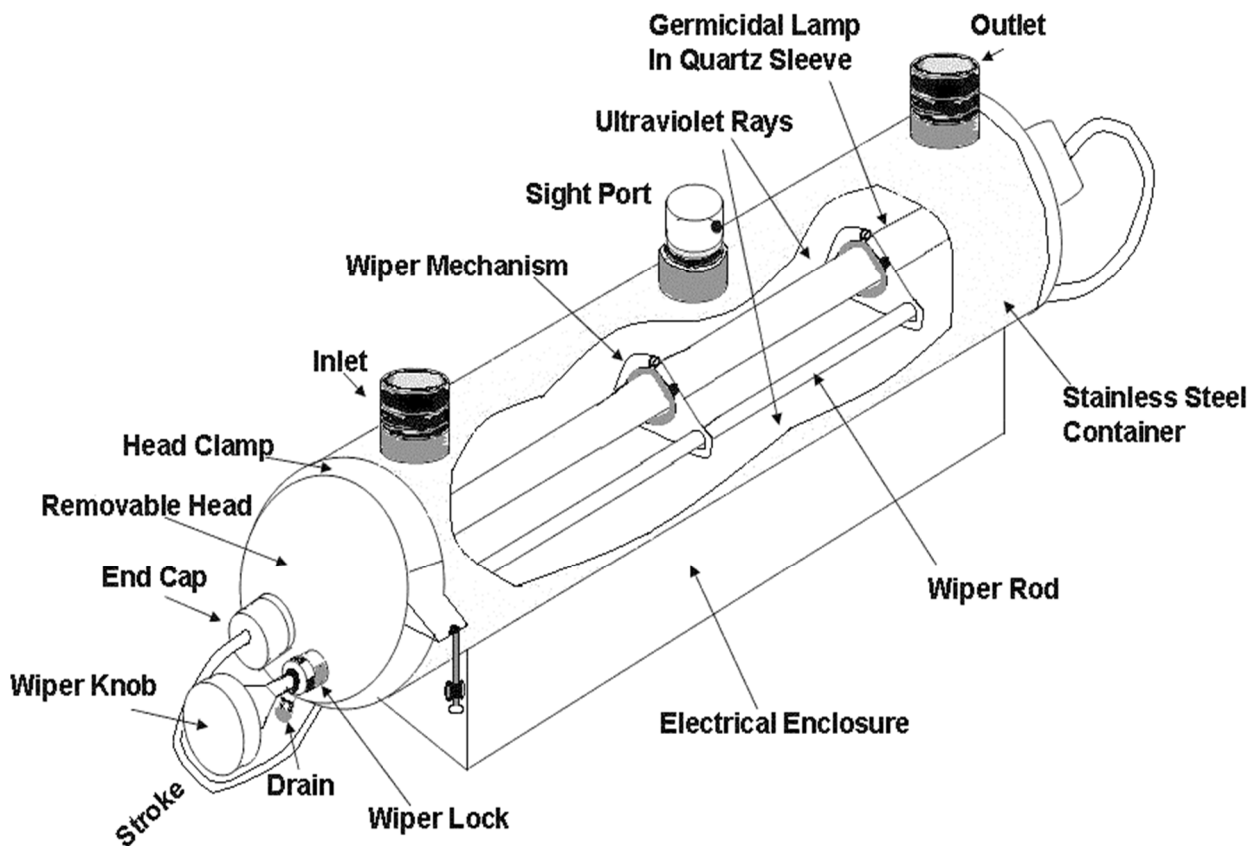
Ensuring that the UV maintains good contact with the water requires control of the water level within the channel to ensure that the UV is making total contact at the designed depths. Also, because of the heat generated by the electric components of the system, adequate ventilation and cooling must be applied to the UV arrays to reduce heat build-up, otherwise the ballasts could fail.

UV lamps have a rated life of up to 14,000 hours, and should be routinely replaced at 12,000 hours or roughly every 1.5 years of continuous operation. The electrical consumption of this system, combined with the cost of routine replacement of ballasts and shields, should be considered against other systems.

## Photoelectric Cell

Most manufacturers claim that the UV lamps have a life of about 7,500 hours, which is about 1 years' time. The lamp must be replaced when it loses about 40% to 50% of its UV output; in any installation this is determined by means of a photoelectric cell and a meter that shows the output of the lamp. Each lamp is outfitted with its own photoelectric cell, and with its own alarm that will be activated when the penetration drops to a preset level.

Ultraviolet radiation is an excellent disinfectant that is highly effective against viruses, molds, and yeasts; and it is safe to use. It adds no chemicals to the water, it leaves no residual, and it does not form THMs. It is used to remove traces of ozone and chloramines from the finished water. Alone, UV radiation will not remove precursors, but in combination with ozone, it is said to be effective in the removal of THM precursors and THMs.



The germicidal effect of UV is thought to be associated with its absorption by various organic components essential to the cell's functioning. For effective use of ultraviolet, the water to be disinfected must be clean, and free of any suspended solids. The water must also be colorless and must be free of any colloids, iron, manganese, taste, and odor. These are conditions that must be met.

Also, although a water may appear to be clear, such substances as excesses of chlorides, bicarbonates, and sulfates affect absorption of the ultraviolet rays. These parameters will probably require at least filtration of one type or another. The UV manufacturer will of course stipulate which pretreatment may be necessary.



<b>Removal of Disinfection By-Products</b>		
<b><i>Disinfectant</i></b>	<b><i>Disinfectant By-product</i></b>	<b><i>Disinfectant By-product Removal</i></b>
Chlorine (HOCl)	Trihalomethane (THM) Chloramine Chlorophenol	Granular Activated Carbon ( <b>GAC</b> ), resins, controlled coagulation, aeration. GAC-UV GAC
Chloramine (NH <sub>x</sub> Cl <sub>y</sub> )	Probably no THM Others?	GAC UV?
Chlorine dioxide (ClO <sub>2</sub> )	Chlorites Chlorates	Use of Fe <sup>2+</sup> in coagulation, RO, ion-exchange
Permanganate (KMnO <sub>4</sub> )	No THMs	
Ozone (O <sub>3</sub> )	Aldehydes, Carboxylics, Phthalates	GAC
Ultraviolet (UV)	None known	GAC

The table indicates that most of the disinfectants will leave a by-product that is or would possibly be inimical to health. This may aid with a decision as to whether or not precursors should be removed before these disinfectants are added to water.

If it is decided that removal of precursors is needed, research to date indicates that this removal can be attained through the application of controlled chlorination plus coagulation and filtration, aeration, reverse osmosis, nanofiltration, GAC or combinations of others processes.

## **Ultraviolet Radiation *Advantages and Disadvantages***

### **Ultraviolet Radiation Advantages**

- No chemical storage, handling or feed equipment required.
- No identified disinfection by-products.

### **Ultraviolet Radiation Disadvantages**

- No residual action.
- High maintenance requirements.
- High initial capital costs.
- High operating (energy) costs.

Disinfecting action can be compromised by variables such as water clarity, hardness (scaling on the UV tubes), fouling (biological materials) of UV lamps, wavelength of the UV radiation or power failure.



## Ozone Sub-Section

Ozone has been used for several decades in Europe and is now starting to be found in the U.S. for taste and odor control, color removal and disinfection.

### Strongest Oxidizing Agent

Ozone (O<sub>3</sub>) is probably the strongest oxidizing agent available for water treatment. Ozone is obtained by passing a flow of air or oxygen between two electrodes that are subjected to an alternating current in the order of 10,000 to 20,000 volts.



Liquid ozone is very unstable and can readily explode. As a result, it is not shipped and must be manufactured on-site. Ozone is a light blue gas at room temperature.

It has a self-policing pungent odor similar to that sometimes noticed during and after heavy electrical storms. In use, ozone breaks down into oxygen and nascent oxygen.



It is the nascent oxygen that produces the high oxidation and disinfections, and even sterilization. Each water has its own ozone demand, in the order of 0.5 ppm to 5.0 ppm. Contact time, temperature, and pH of the water are factors to be determined.

Ozone acts as a complete disinfectant. It is an excellent aid to the flocculation and coagulation process, and will remove practically all color, taste, odor, iron, and manganese. It does not form chloramines or THMs, and while it may destroy some THMs, it may produce others when followed by chlorination.

Ozone is not practical for complete removal of chlorine or chloramines, or of THM and other inorganics. Further, because of the possibility of formation of other carcinogens (such as aldehydes or phthalates) it falls into the same category as other disinfectants in that it can produce DBPs.



Oxygen tank is necessary to generate O<sub>3</sub>

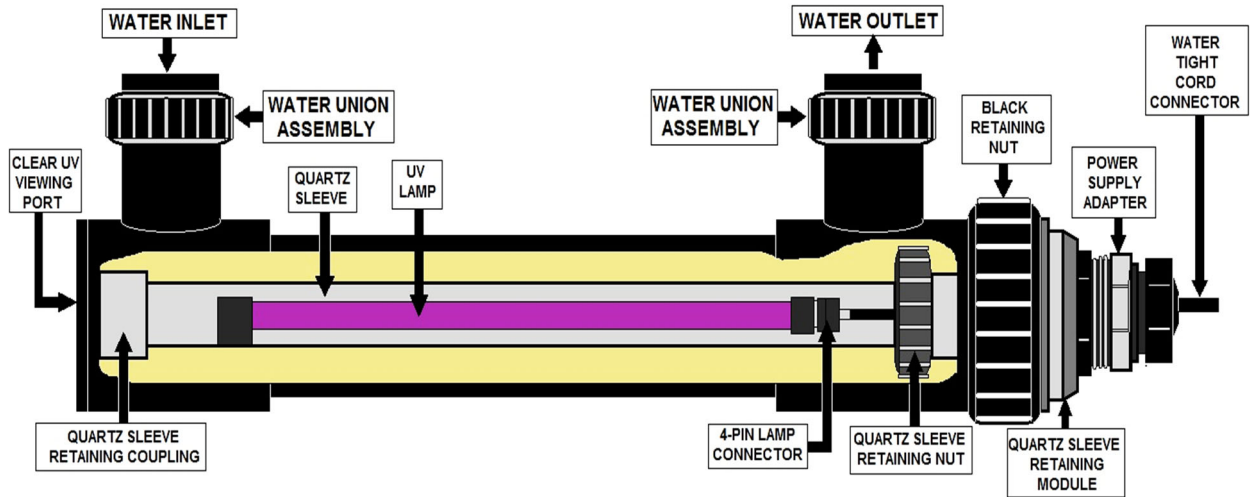
### **Ozone Advantages**

- Acts as an excellent virucide.
- Disinfects and oxidizes very effectively.
- Produces no chlorinated THMs, HAAs or other chlorinated by-products.
- Enhances turbidity removal under certain conditions.
- Inactivates both *Cryptosporidium* and *Giardia*, as well as other known pathogens.
- Controls taste and odor.

### **Ozone Disadvantages**

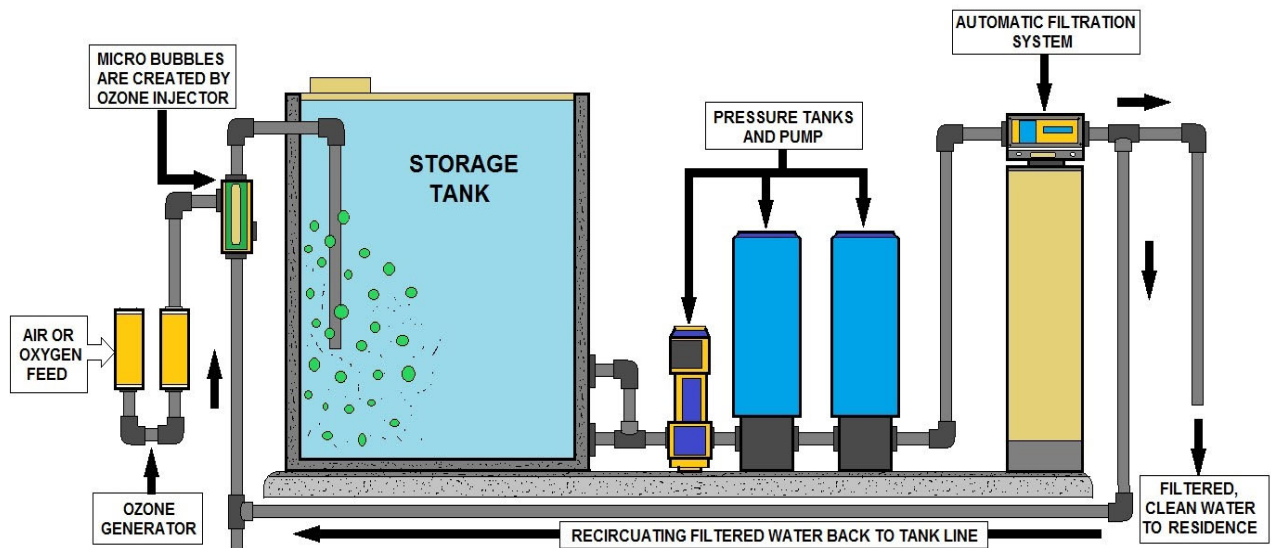
- Produces disinfection by-products, including:
  - ~Aldehydes
  - ~Ketones
  - ~Carboxylic acids
  - ~Brominated THMs (including bromoform)
  - ~Brominated acetic acids
  - ~Bromate (in the presence of bromide)
  - ~Quinones
  - ~Peroxides
- Fosters THM formation when some ozonation by-products combine with secondary disinfection processes. A biologically active filter will likely be necessary to remove these newly formed precursors.
- Does not provide a persistent residual.
- Raises regulatory concerns. Future DBP regulations may require plants using ozone to install costly precursor removal systems (such as granular activated carbon filtration systems).
- Requires capital investment. Ozone must be produced on-site by costly generation that requires a high level of maintenance and substantial operator training.
- Promotes microbial growth. Ozone readily reacts with more complex organic matter and can break this down to smaller compounds that serve to increase nutrients in water supplies, thus enhancing microbial regrowth in water distribution systems.

## Alternative Process Comparison Diagrams

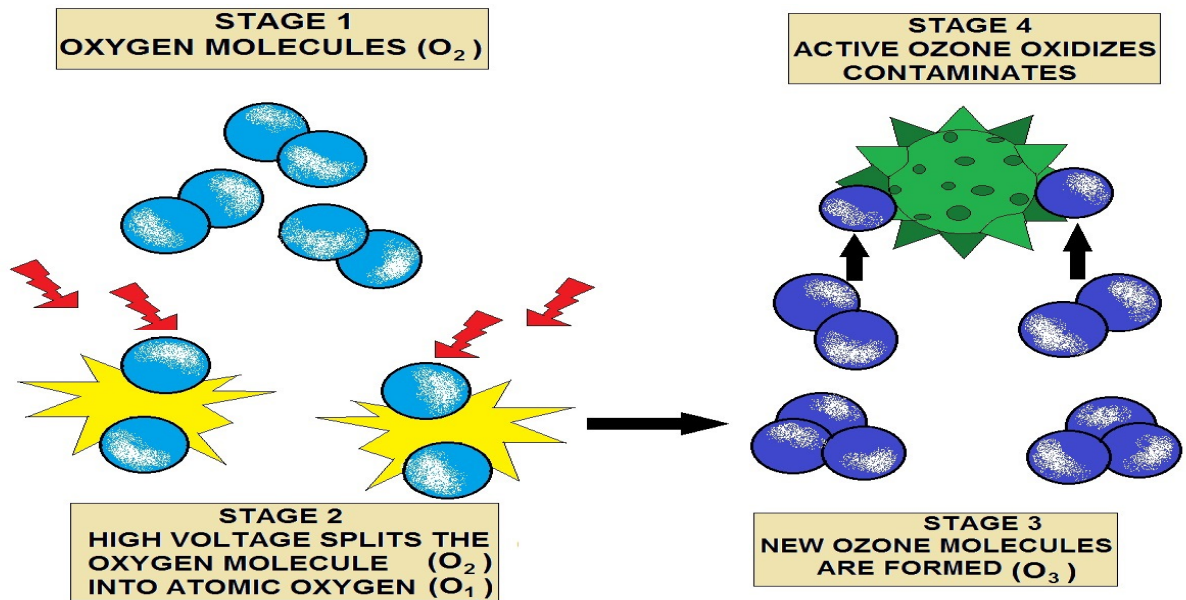


### UV LIGHT USED FOR DISINFECTION

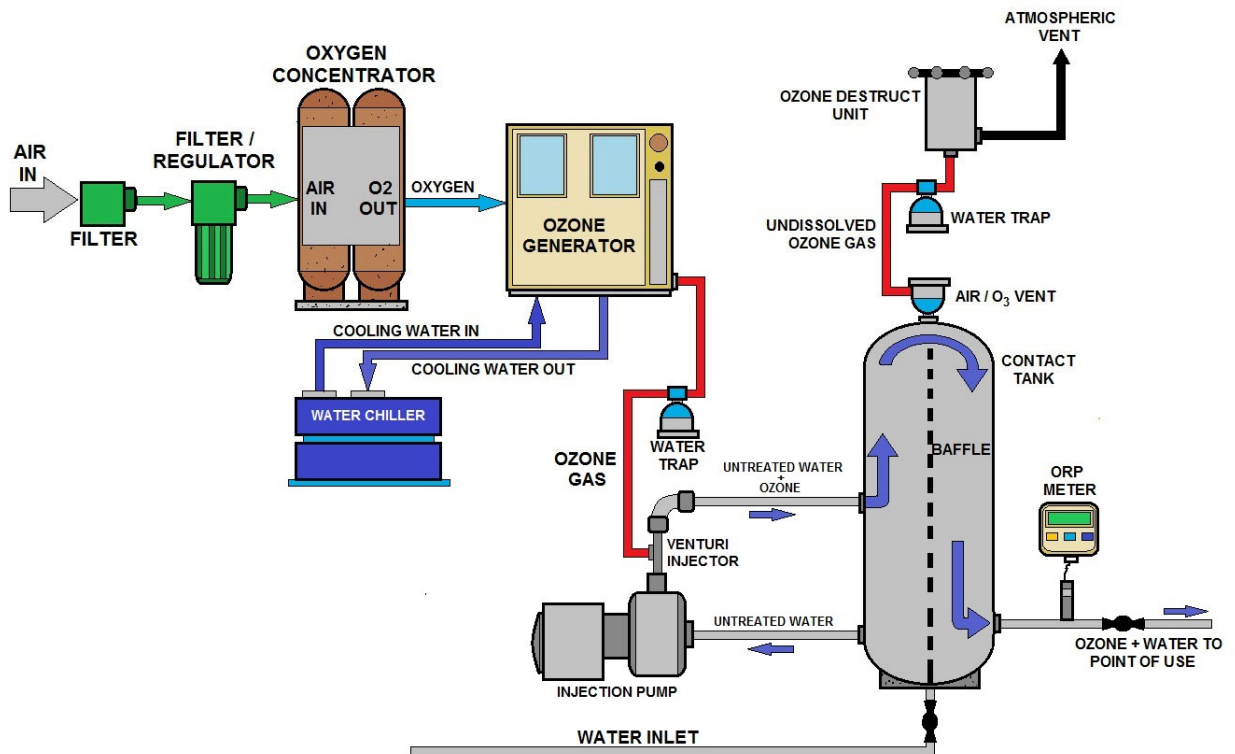
Ultraviolet light for disinfection was primarily used in the wastewater industry because of its effectiveness to deactivate microorganisms and not having to dechlorinate the effluent for discharge. In drinking water, UV has become popular because it doesn't produce Trihalomethanes however there is no residual disinfectant. Another consideration is the cost to operate and maintain the UV unit.



### OZONE PROCESS EXAMPLE



**HOW OZONE IS PRODUCED**



**OZONE GENERATION SYSTEM**

## Alternate Disinfectants Summary

### Chloramines

Chloramine is a very weak disinfectant for Giardia and virus reduction. It is recommended that it be used in conjunction with a stronger disinfectant. It is best utilized as a stable distribution system disinfectant. In the production of chloramines the ammonia residuals in the finished water, when fed in excess of stoichiometric amount needed, should be limited to inhibit growth of nitrifying bacteria.

### Chlorine Dioxide

Chlorine dioxide may be used for either taste and odor control or as a pre-disinfectant. Total residual oxidants (including chlorine dioxide and chlorite, but excluding chlorate) shall not exceed 0.30 mg/L during normal operation or 0.50 mg/L (including chlorine dioxide, chlorite and chlorate) during periods of extreme variations in the raw water supply.

Chlorine dioxide provides good Giardia and virus protection but its use is limited by the restriction on the maximum residual of 0.5 mg/L  $\text{ClO}_2$ /chlorite/chlorate allowed in finished water. This limits usable residuals of chlorine dioxide at the end of a process unit to less than 0.5 mg/L.

Where chlorine dioxide is approved for use as an oxidant, the preferred method of generation is to entrain chlorine gas into a packed reaction chamber with a 25% aqueous solution of sodium chlorite ( $\text{NaClO}_2$ ).

**Warning:** Dry sodium chlorite is explosive and can cause fires in feed equipment if leaking solutions or spills are allowed to dry out.

### Ozone

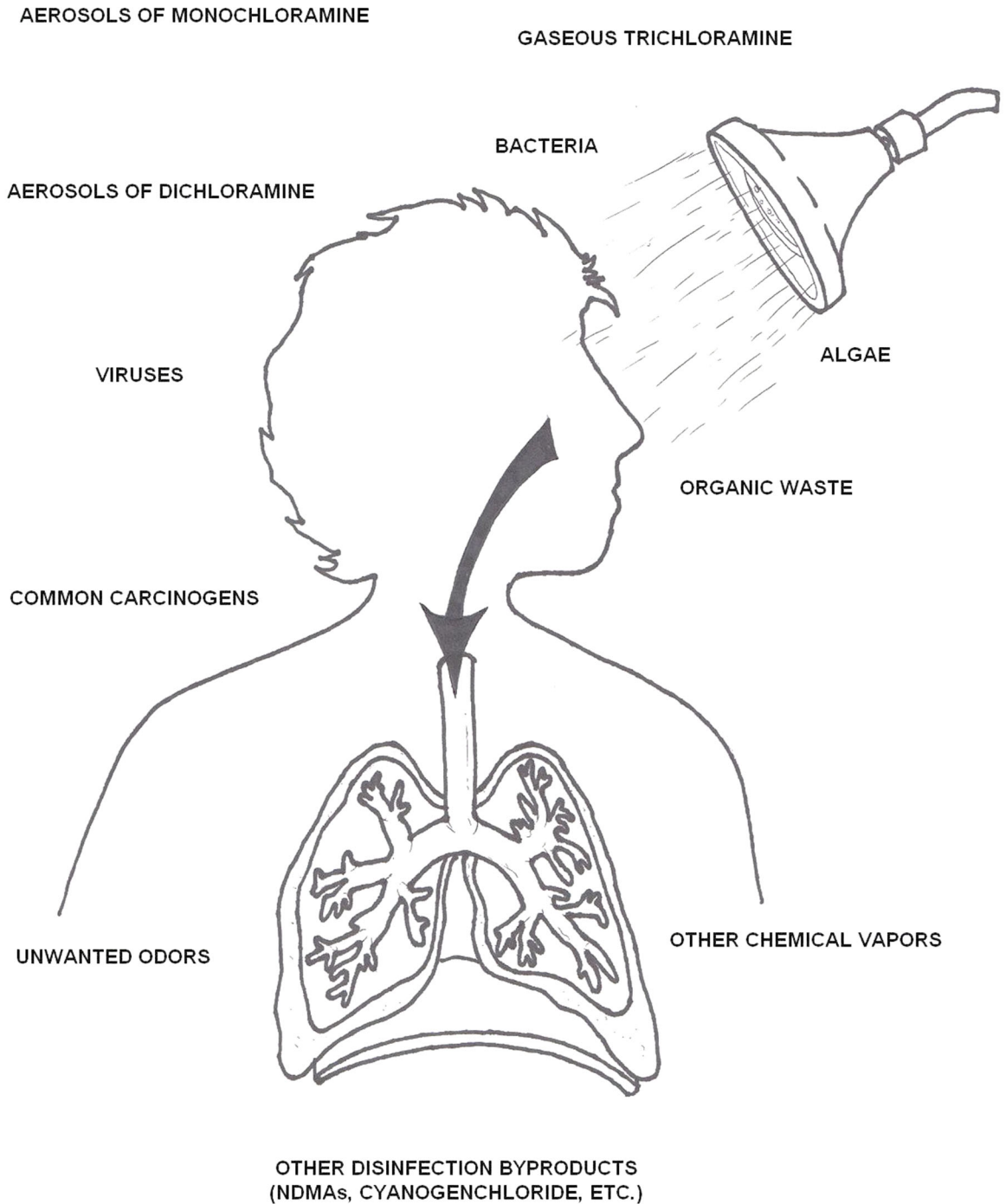
Ozone is a very effective disinfectant for both Giardia and viruses. Ozone CT (Contact time) values must be determined for the ozone basin alone; an accurate T10 value must be obtained for the contact chamber, residual levels measured through the chamber and an average ozone residual calculated. Ozone does not provide a system residual and should be used as a primary disinfectant only in conjunction with free and/or combined chlorine.

Ozone does not produce chlorinated byproducts (such as trihalomethanes) but it may cause an increase in such byproduct formation if it is fed ahead of free chlorine; ozone may also produce its own oxygenated byproducts such as aldehydes, ketones, or carboxylic acids.

Any installed ozonation system must include adequate ozone leak detection alarm systems, and an ozone off-gas destruction system. Ozone may also be used as an oxidant for removal of taste and odor, or may be applied as a pre-disinfectant.

### UV

The germicidal effect of UV is thought to be associated with its absorption by various organic components essential to the cell's functioning. For effective use of ultraviolet, the water to be disinfected must be clean and free of any suspended solids. The water must also be colorless and must be free of any colloids, iron, manganese, taste, and odor. These are conditions that must be met.



Chloroform may be absorbed into the body through ingestion, inhalation, and through the skin. The largest source of human exposure to THMs in the U.S. is from the consumption of chlorinated drinking water. Besides consuming water, other water uses in the home may contribute significantly to total chloroform exposure both from breathing in chloroform vaporized into the air and from it passing through the skin during bathing. Swimming in chlorinated pools will also contribute to the total exposure from the same exposure paths. One study observed that a greater percentage of chloroform passed through the skin when bathing water temperatures were increased. Chloroform does not concentrate in plants; therefore, the contribution from food to total chloroform exposure is small.



## Alternative Disinfectants Post Quiz

1. This compound is pumped into the stream and allowed to react in a generating column to produce  $\text{ClO}_2$ ?
2. What compound does not hydrolyze in water as does with chlorine and there is no dissociation of  $\text{ClO}_2$ ? This remains fully active in a pH range far broader than chlorine or sodium hypochlorite.
3. Other common methods of generation use \_\_\_\_\_ in place of chlorine gas. Also referred to as the "three pump" method of generation, this method is valuable to a facility that wants to eliminate gaseous chlorine.
4. Another and, more recent method of generation uses sulfuric acid and?
5. A disinfection process involves exposing water to \_\_\_\_\_, which inactivates various microorganisms. The technique has enjoyed increased application in wastewater treatment but very limited application in potable water treatment.
6. The basic design flow of water of certain *UV units* is in the order of 2.0 gpm for each inch of the lamp. Further, the units are designed so that the contact or retention time of the water in the unit is not less than 15 seconds
7. The microorganisms spend maximum time and contact with the outside of the quartz tube and the source of the \_\_\_\_\_.
8. In UV, quartz is often used in this case since practically none of the UV rays are absorbed by the quartz, ordinary glass cannot be used since it will absorb the \_\_\_\_\_, leaving little for disinfection.
9. Heat is generated by the electric components of the UV system, adequate ventilation and cooling must be applied to the \_\_\_\_\_ to reduce heat build-up, otherwise the ballasts could fail.
10. \_\_\_\_\_ represents the transfer of electromagnetic energy from a mercury arc lamp to a pathogen's DNA material, thus affecting its ability to replicate itself.

11. \_\_\_\_\_ is obtained by passing a flow of air or oxygen between two electrodes that are subjected to an alternating current in the order of 10,000 to 20,000 volts.
12. \_\_\_\_\_ is a light blue gas at room temperature.
13. Ozone has a \_\_\_\_\_ similar to that sometimes noticed during and after heavy electrical storms. In use, ozone breaks down into oxygen and nascent oxygen.
14. Ozone does not form chloramines or \_\_\_\_\_, and while it may destroy some THMs, it may produce others when followed by chlorination.
15. Ozone falls into the same category as other disinfectants in that it can produce \_\_\_\_\_.
16. This compound is very unstable and can readily explode. As a result, it is not shipped and must be manufactured on-site.
17. Each water has its own \_\_\_\_\_, in the order of 0.5 ppm to 5.0 ppm. Contact time, temperature, and pH of the water are factors to be determined.
18. \_\_\_\_\_ remains a gas in water, it does not have the corrosive tendencies of chlorine gas?

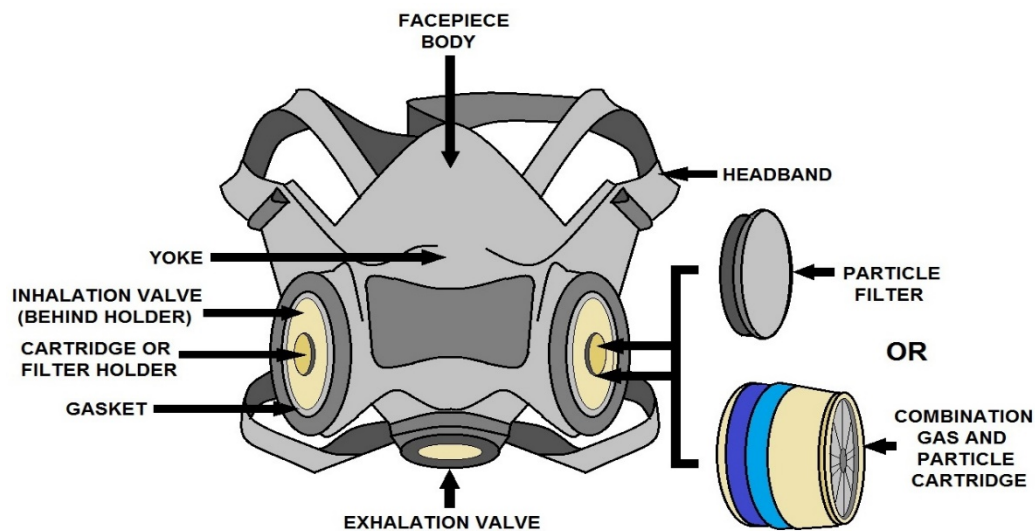
## Chapter 8- Respiratory Protection Section

### Respiratory Protection Chapter

**Section Focus:** You will learn the basics of respiratory protection. At the end of this section, you will be able to describe the need and rules regarding respiratory protection. There is a post quiz at the end of this section to review your comprehension and a final examination in the Assignment for your contact hours.

#### Scope/Background: OSHA 1910.134 – Respiratory Protection

(c) - Respiratory protection program. This paragraph requires the employer to develop and implement a written respiratory protection program with required worksite-specific procedures and elements for required respirator use. The program must be administered by a suitably trained program administrator.



**BASIC PARTS OF A HALF-FACEPIECE RESPIRATOR**

**Half –Facepiece cannot be used with Chlorine, due to the lack of eye-protection, unless you wear goggles. Check with OSHA or your safety agency.**

The primary means to control occupational diseases caused by breathing contaminated air is through the use of feasible engineering controls, such as enclosures, confinement of operations, ventilation, or substitution of less toxic materials

- When effective engineering controls are not feasible, or while they are being instituted, appropriate respirators shall be used pursuant to this standard
- Employer shall provide respirators, when necessary, which are applicable and suitable for the purpose intended
- Employer shall be responsible for establishment and maintenance of a respirator program which includes the requirements of paragraph (c), Respiratory protection program

## What Is a Respirator?

As you are aware, a respirator is a type of device that is worn by an employee when working in an air contaminated environment. There are two ways respirators can be worn:

- Respirators that **fit tightly** are ones that are a half mask, which covers only the mouth and nose. There are also full facepieces that must fit closely to the areas that they are designed to fit.
- Respirators in the form of helmets, hoods, or body-suits **fit loosely** when worn.

You also know that there are two significant categories of respirators. The **air-purifying respirator** is designed to remove contaminants, such as airborne particles, from the air. The **atmosphere-supplying respirator**, on the other hand, is used to provide clean air from an area that is not contaminated. This type of breathing apparatus includes airline respirators that pump in compressed air via a hose connected to an isolated air source. Another type of atmosphere-supplying respirator produces its own air supply and is known as a **self-contained breathing apparatus**.

## NIOSH Chlorine Respiratory Protection Chart

### Up to 5 ppm:

(APF = 10) Any chemical cartridge respirator with cartridge(s) providing protection against the compound of concern\*

(APF = 10) Any supplied-air respirator\*

### Up to 10 ppm:

(APF = 25) Any supplied-air respirator operated in a continuous-flow mode\*

(APF = 25) Any powered, air-purifying respirator with cartridge(s) providing protection against the compound of concern\*

(APF = 50) Any chemical cartridge respirator with a full facepiece and cartridge(s) providing protection against the compound of concern

(APF = 50) Any air-purifying, full-facepiece respirator (gas mask) with a chin-style, front- or back-mounted canister providing protection against the compound of concern

(APF = 50) Any self-contained breathing apparatus with a full facepiece

(APF = 50) Any supplied-air respirator with a full facepiece

### Emergency or planned entry into unknown concentrations or IDLH conditions:

(APF = 10,000) Any self-contained breathing apparatus that has a full facepiece and is operated in a pressure-demand or other positive-pressure mode

(APF = 10,000) Any supplied-air respirator that has a full facepiece and is operated in a pressure-demand or other positive-pressure mode in combination with an auxiliary self-contained positive-pressure breathing apparatus

### Escape:

(APF = 50) Any air-purifying, full-facepiece respirator (gas mask) with a chin-style, front- or back-mounted canister providing protection against the compound of concern.

Any appropriate escape-type, self-contained breathing apparatus

## Respiratory Protection - Introduction

In the Respiratory Protection program, hazard assessment and selection of proper respiratory PPE is conducted in the same manner as for other types of PPE. In the control of those occupational diseases caused by breathing air contaminated with harmful dusts, fogs, fumes, mists, gases, smokes, sprays, or vapors, the primary objective shall be to prevent atmospheric contamination.

This shall be accomplished as far as feasible by accepted engineering control measures (for example, enclosure or confinement of the operation, general and local ventilation, and substitution of less toxic materials). When effective engineering controls are not feasible, or while they are being instituted, appropriate respirators shall be used.

**References:** OSHA Standards *Respiratory Protection (29 CFR 1910.134)*

### Why Respirators Are Needed

Respirators protect against the inhalation of dangerous substances (vapors, fumes, dust, gases). They can also provide a separate air supply in a very hazardous situation.

#### *Some of the health hazards that respirators prevent include*

- Lung damage
- Respiratory diseases
- Cancer and other illnesses.



### Respiratory Protection Responsibilities

The employer is responsible for:

- Providing training in the use and care of respirators.
- Ensuring that equipment is adequate, sanitary, and reliable.
- Allowing employees to leave area if ill, for breaks, and to obtain parts.
- Fit testing.
- Providing annual medical evaluations.
- Providing a powered air-purifying respirator (**PAPR**) if an employee cannot wear a tight-fitting respirator.

#### **The employee is responsible for:**

- Properly using respirators.
- Maintaining respirator properly.
- Reporting malfunctions.
- Reporting medical changes.



### Selection of Respiratory Protection

When choosing the correct respiratory protection for your work environment, it is important to consider:

- Identification of the substance or substances for which respiratory protection is necessary
- A substance's safety data sheet (SDS) (it will state which type of respirator is most effective for the substance)
- Activities of the workers
- Hazards of each substance and its properties

- Maximum levels of air contamination expected
- Probability of oxygen deficiency
- Period of time workers will need to use the respiratory protection devices
- Capabilities and physical limitations of the device used

**Types of Respirators** The following is a description of different types of respirators.

**Commonly Used Respirators (Air Purifying)**

- **Disposable Dust** masks are worn over the nose and mouth to protect the respiratory system from certain nuisance dusts, mists, etc. They can only provide protection against particular contaminants as specified by the manufacturer (e.g., general dust, fiberglass, etc.). These dust masks cannot be fit tested, and are generally single use. They are not generally recognized as proper respiratory protection and may not be worn if a potential for overexposure exists. They are not included in most companies' Respiratory Protection Programs.
- **Half-Face Respirators** with interchangeable filter cartridges can protect the respiratory system from hazardous dusts, fumes, mists, etc. They can only provide protection against certain contaminants up to limited concentrations specified by the manufacturer for the particular cartridge type used (e.g., toluene, acetone). These generally operate under negative pressure within the respirator which is created by the wearer's breathing through the filter cartridges. As the protection is only gained if there is a proper seal of the respirator face piece, this type requires fit testing prior to respirator assignment and a fit check prior to each use.
- **Full-Face Respirators** operate under the same principle and requirements as the half-face type, however, they offer a better facepiece fit and also protect the wearer's eyes from particularly irritating gases or vapors.
- **Full-face, helmet or hood type powered air purifying respirators (PAPRs)** operate under positive pressure inside the facepiece using a battery operated motor blower assembly to force air through a filter cartridge into the wearer's breathing zone. Use of these respirators is also subject to the manufacturers' guidelines.

**Less Commonly Used Types Respirators (Air Supplying)**

- **Air-Line Respirators** supply clean air through a small diameter hose from a compressor or compressed air cylinders. The wearer must be attached to the hose at all times, which limits mobility. Use of these respirators is subject to the manufacturers' guidelines.
- **Self-Contained Breathing Apparatus (SCBA)** respirators supply clean air from a compressed air tank carried on the back of the wearer. These types of respirators are highly mobile and are used primarily for emergency response or rescue work, since only a limited amount of air can be supplied by a single tank, generally 20-60 minutes. Units must be thoroughly inspected on a monthly basis and written records must be kept of all inspections, operator training, etc. Use of these respirators is subject to the manufacturer's guidelines

**Basic Types of Respirators**

Air-purifying or filtering respirators. Such respirators are used when there is enough oxygen (at least 19.5 percent) and contaminants are present below IDLH level. The respirator filters out or chemically "**scrubs**" contaminants, usually with a replaceable filter. Use color-coded filter cartridges or canisters for different types of contaminants. It's important to select the right filter for the situation.

**Air-supplying respirators.** These respirators are required when air-purifying respirators aren't effective. Air-purifying respirators are not sufficient in the following settings:

- When there is not enough oxygen.
- Confined spaces.
- When contaminants cannot be filtered out.
- When contaminants are at or above IDLH level.

**Different kinds of air-supplying respirators include**

- Those connected by hose to stationary air supply (airline)
- Portable tank self-contained breathing apparatus (**SCBA**).



Respirators are an effective method of protection against designated hazards when properly selected and worn. Respirator use is encouraged, even when exposures are below the exposure limit, to provide an additional level of comfort and protection for workers.

However, if a respirator is used improperly or not kept clean, the respirator itself can become a hazard to the worker.

Sometimes, workers may wear respirators to avoid exposures to hazards, even if the amount of hazardous substance does not exceed the limits set by OSHA standards. If your employer provides respirators for your voluntary use, or if you provide your own respirator, you need to take certain precautions to be sure that the respirator itself does not present a hazard.

## The Importance of Correct Fit

Even a tiny gap between the respirator and the face can allow contaminants to enter.

Respirators should be comfortable and properly fitted. Proper fit includes:

- **Secure but not too tight**
- **No slipping or pinching**
- **Allowance for head movement and speech**

An OSHA-accepted qualitative fit test or quantitative fit test must be performed prior to an employee using any tight-fitting respirator.

Tight-fitting respirators must be seal checked before each use by using positive- or negative-pressure check procedures or the manufacturer's instructions.

### Respirator Filters/Cartridges

For protection against gases and vapors, the cartridges used for air-purifying respirators must be either equipped with an end-of-service-life indicator (**ESLI**), certified by NIOSH for the contaminant, or a cartridge change schedule has to be established.

For protection against particulates, there are nine classes of filters (three levels of filter efficiency, each with three categories of resistance to filter efficiency degradation). Levels of filter efficiency are 95 percent, 99 percent, and 99.97 percent. Categories of resistance to filter efficiency degradation are labeled N, R, and P.

### Protection Factors

The protection factor of a respirator is an expression of performance based on the ratio of two concentrations: The contaminant concentration outside the respirator to the contaminant concentration inside the respirator.

Each class of respirator is also given an assigned protection factor (**APF**). The APF is a measure of the minimum anticipated level of respiratory protection that a properly functioning respirator or class of respirators would provide to a percentage of properly fitted and trained users. When a contaminant concentration is known, the APF can be used to estimate the concentration inside a particular type of respirator worn by a user.





## Who Cannot Wear a Respirator?

Respirator fit is essential. Employees must have a medical checkup to make sure they can wear respirators safely.

Generally, respirators cannot be worn when a person:

- Wears glasses or personal protective equipment that interferes with the seal of the face piece to the face of the user.
- Has facial hair that comes between the sealing surface of the face piece and the face or interferes with valve function.
- Has a breathing problem, such as asthma.
- Has a heart condition.
- Is heat sensitive.

Sometimes a person's facial features will not permit a good fit. Check with the supervisor or medical department if the fit is a problem.

### Checking for Damage

Before each use, make sure there are no holes, tears, etc., in the respirator. Rubber parts can wear out and should be checked very carefully every time a respirator is used. Replace worn and damaged parts when necessary. Make sure air and oxygen cylinders are fully charged.

### Staying Prepared for Respirator Use

Respirators are bulky and awkward, so getting used to them takes practice. Possible problems with wearing respirators may include heat exhaustion or heat stroke. Be alert for symptoms, use the "**buddy system**," and wear a lifeline or harness when necessary. Drink plenty of fluids and take frequent breaks.

**Poor maneuverability.** Practice with respirators in narrow passages, on ladders, etc., if your use of respirators may be in these types of conditions.

**Using up the air supply.** When a SCBA is in use, keep checking the gauges and listening for alarms; be ready to leave the area immediately if there is a problem.

**Panic.** Remember the importance of staying calm in a hot, stressful, or awkward situation.

### Cleaning Respirators

Respirators should be cleaned and disinfected after every use. Check the respirator for damage before putting it away; look for holes, cracks, deterioration, dented cartridges, etc. If any damage is found, it should be reported to a supervisor. Respirators stored for emergency use must be inspected monthly when not in use, as well as after each use.

Respirators should be stored away from light, heat, cold, chemicals, and dust.

Store respirators in a "**normal**" (natural, undistorted) position to hold their shape. Do not allow respirators to get crushed, folded, or twisted.

***All of this text is credited to OSHA.***

## What are the most important things to know about chlorine in an emergency?

**Emergency Overview:** Inhalation. Skin contact. Eye contact.

- **Inhalation:** VERY TOXIC, can cause death. Can cause severe irritation of the nose and throat. Can cause severe lung injury. Can cause life-threatening accumulation of fluid in the lungs (pulmonary edema). Symptoms may include coughing, shortness of breath, difficult breathing and tightness in the chest. Symptoms may develop hours after exposure and are made worse by physical effort. Long-term damage may result from a severe short-term exposure. A single exposure to a high concentration can cause a long-lasting condition like asthma. If this occurs, many things like other chemicals or cold temperatures can easily irritate the airways. Symptoms may include shortness of breath, tightness in the chest and wheezing. {Reactive Airways Dysfunction Syndrome (RADS)}.
- **Skin Contact:** CORROSIVE. The gas irritates or burns the skin. Permanent scarring can result. Direct contact with the liquefied gas can chill or freeze the skin (frostbite). Symptoms of mild frostbite include numbness, prickling and itching. Symptoms of more severe frostbite include a burning sensation and stiffness. The skin may become waxy white or yellow. Blistering, tissue death and infection may develop in severe cases.
- **Eye Contact:** CORROSIVE. The gas irritates or burns the eyes. Permanent damage including blindness can result. Direct contact with the liquefied gas can freeze the eye. Permanent eye damage or blindness can result.
- **Ingestion:** Not a relevant route of exposure (gas).
- **Effects of Long-Term (Chronic) Exposure:** May harm the respiratory system. Can irritate and inflame the airways.
- **Carcinogenicity:** Not known to cause cancer.

International Agency for Research on Cancer (IARC): Not specifically evaluated.

American Conference for Governmental Industrial Hygienists (ACGIH): A4 - Not classifiable as a human carcinogen.

- **Teratogenicity / Embryotoxicity:** Not known to harm the unborn child.
- **Reproductive Toxicity:** Not known to be a reproductive hazard.
- **Mutagenicity:** Not known to be a mutagen.

## OSHA Overview

OSHA requires that supervisors consult with employees and encourage their participation in the process safety management plan. In fact, managers must have a written plan of action for employee participation in process safety management. Employee participation is critical because...

- **Employees know a lot about the process which they work upon**
- **They play key roles in making sure that process operation is conducted safely.**

### Operating Procedures

Managers must furnish written operating procedures that clearly explain how to perform each covered process safely. The procedures must be accurate and must be written in language that people can understand. Avoid technical jargon and, if necessary, supply translations.

#### Operating procedures must include at least the following:

- Operating steps for initial startup, normal and temporary operations, emergency shutdown (including when it's called for and who does it), emergency operations, normal shutdown, and startup after a turnaround or an emergency shutdown
- Operating limits, including what happens if workers don't conform to operating limits and how to avoid or correct such problems
- Safety and health considerations, such as chemical or other hazards, precautions to prevent exposure, quality and inventory control for chemicals, and what to do if an employee is exposed to a hazardous substance
- Safety systems and their functions, including up-to-date operating procedures and safe work practices.

### Contractor Employees

Process safety training and safety programs are also required for contractors who work on-site. Managers must check out the safety performance and programs of any contractors being considered for maintenance, repair, turnaround, major renovation, or specialty work on or around a process covered by the regulation.

When a contractor is hired, the manager must provide the contractor with information on the hazards of the process the contractor will work on. To further ensure contractor safety, managers must also

- ❖ provide the contractor with information on safe work practices for the process they're involved with and tell them what to do in an emergency
- ❖ keep a log of contractor employees' injuries or illnesses related to their work in process areas
- ❖ evaluate the contractor's performance to make sure they're living up to their safety obligations set by the standard.



### **The Contractor has Responsibilities, too**

- Document that employees are trained to recognize hazards and to follow safe work practices on the job
- Make sure that the contractor's employees understand potential job-related hazards, are trained to work safely, and follow the safety rules of the facility in which they're working.

### **Written Respiratory Protection Program**

This paragraph requires the employer to develop and implement a written respiratory protection program with required worksite-specific procedures and elements for required respirator use. The program must be administered by a suitably trained program administrator. In addition, certain program elements may be required for voluntary use to prevent potential hazards associated with the use of the respirator.

The Small Entity Compliance Guide contains criteria for the selection of a program administrator and a sample program that meets the requirements of this paragraph. Copies of the Small Entity Compliance Guide will be available on or about April 8, 1998 from the Occupational Safety and Health Administration's Office of Publications, Room N 3101, 200 Constitution Avenue, NW, Washington, DC, 20210 (202-219-4667).

**(c)(1)** In any workplace where respirators are necessary to protect the health of the employee or whenever respirators are required by the employer, the employer shall establish and implement a written respiratory protection program with worksite-specific procedures. The program shall be updated as necessary to reflect those changes in workplace conditions that affect respirator use. The employer shall include in the program the following provisions of this section, as applicable:

**(c)(1)(i)** Procedures for selecting respirators for use in the workplace;

**(c)(1)(ii)** Medical evaluations of employees required to use respirators;

**(c)(1)(iii)** Fit testing procedures for tight-fitting respirators;

**(c)(1)(iv)** Procedures for proper use of respirators in routine and reasonably foreseeable emergency situations;

**(c)(1)(v)** Procedures and schedules for cleaning, disinfecting, storing, inspecting, repairing, discarding, and otherwise maintaining respirators;

**(c)(1)(vi)** Procedures to ensure adequate air quality, quantity, and flow of breathing air for atmosphere-supplying respirators;

**(c)(1)(vii)** Training of employees in the respiratory hazards to which they are potentially exposed during routine and emergency situations;

## Example of RP Employee Responsibilities

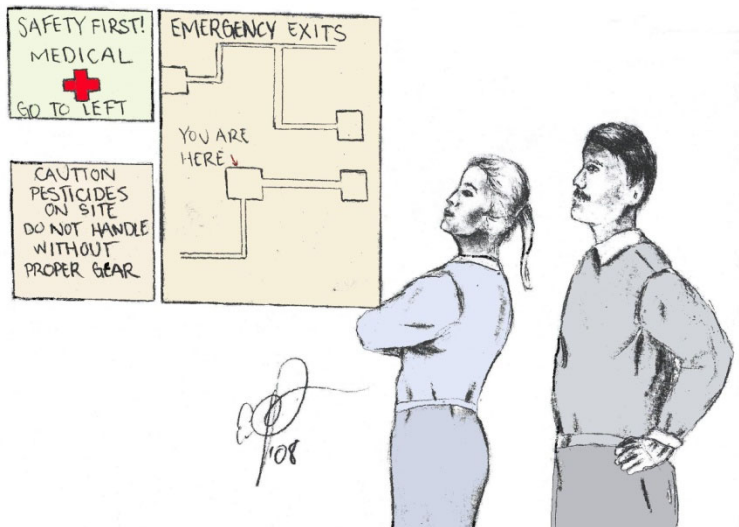
All Employees shall follow the requirements of the Respiratory Protection Program.

### Management

- Implement the requirements of this program.
- Provide a selection of respirators as required.
- Enforce all provisions of this program.
- Appoint a **Specific Designated** individual to conduct the respiratory protection program.

### Administrative Department

- Review sanitation/storage procedures.
- Ensure respirators are properly stored, inspected and maintained.
- Monitor compliance for this program.
- Provide training for affected Employees.
- Review compliance and ensure monthly inspection of all respirators.
- Provide respirator fit testing.



### Designated-Occupational Health Care Provider

- Conducts medical aspects of program.

### Program Administrator

Each Department will designate a program administrator who is qualified by appropriate training or experience that is commensurate with the complexity of the program to administer or oversee the respiratory protection program and conduct the required evaluations of program effectiveness.

### Voluntary Use of Respirators is Prohibited

OSHA requires that voluntary use of respirators, when not required by the Employer, must be controlled as strictly as under required circumstances. To prevent violations of the Respiratory Protection Standard, Employees are not allowed voluntary use of their own or Employer supplied respirators of any type.

**Exception:** Employees whose only use of respirators involves the voluntary use of filtering (non-sealing) face pieces (dust masks).

# Respiratory Protection Program Statement *Example*

**Facility** \_\_\_\_\_

## ***Policy Statement***

A respiratory protection program is hereby established so as to coordinate the use and maintenance of respiratory protective equipment as determined necessary to:

1. Reduce Personnel exposure to toxic chemical agents, harmful dusts, mist and fumes and
2. Allow trained personnel to work safely in hazardous environments, such as welding, oxygen deficient atmospheres, toxic atmospheres, etc.

## ***Designation of Program Administrator***

Management has designated \_\_\_\_\_  
to be responsible for the respiratory protection program at this facility. He/she has been delegated authority by Management to make decisions and implement changes in the respirator program anywhere in this facility.

The following responsibilities apply:

1. Supervision of respirator selection process and procedures
2. Establishment of respiratory protection training sessions
3. Establishment of a continuing program of cleaning and inspections
4. Establishment of medical screening program
5. Establishment of issuing procedures
6. Establishment of periodic inspections
7. Continuing evaluation of all aspects of the respiratory protection program to assure continued effectiveness
8. Establishment of annual fit tests procedures

Any questions or problems concerning respirators or their use should be directed to the Program Administrator

\_\_\_\_\_  
Facility Manager

\_\_\_\_\_  
Date



## Program Evaluation

Evaluations of the workplace are necessary to ensure that the written respiratory protection program is being properly implemented; this includes consulting with employees to ensure that they are using the respirators properly.

Evaluations shall be conducted as necessary to ensure that the provisions of the current written program are being effectively implemented and that it continues to be effective.

Program evaluation will include discussions with employees required to use respirators to assess the employees' views on program effectiveness and to identify any problems.

Any problems that are identified during this assessment shall be corrected. Factors to be assessed include, but are not limited to:

- Respirator fit (including the ability to use the respirator without interfering with effective workplace performance);
- Appropriate respirator selection for the hazards to which the employee is exposed;
- Proper respirator use under the workplace conditions the employee encounters; and
- Proper respirator maintenance.



## **RP Recordkeeping**

The employer will retain written information regarding medical evaluations, fit testing, and the respiratory protection program.

This information will facilitate employee involvement in the respiratory protection program, assist the Employer in auditing the adequacy of the program, and provide a record for compliance determinations by OSHA.

### **Training and Information**

Effective training for employees who are required to use respirators is essential. The training must be comprehensive, understandable, and recur annually and more often if necessary. Training will be provided prior to requiring the employee to use a respirator in the workplace.

The training shall ensure that each employee can demonstrate knowledge of at least the following:

- Why the respirator is necessary and how improper fit, usage, or maintenance can compromise the protective effect of the respirator
- Limitations and capabilities of the respirator
- How to use the respirator effectively in emergency situations, including situations in which the respirator malfunctions
- How to inspect, put on and remove, use, and check the seals of the respirator
- Procedures for maintenance and storage of the respirator
- How to recognize medical signs and symptoms that may limit or prevent the effective use of respirators
- The general requirements of this program

### **Retraining shall be conducted annually and when:**

- changes in the workplace or the type of respirator render previous training obsolete
- inadequacies in the employee's knowledge or use of the respirator indicate that the employee has not retained the requisite understanding or skill
- other situation arises in which retraining appears necessary to ensure safe respirator use

### ***Training is divided into the following sections:***

#### **Classroom Instruction**

1. Overview of the Employer's Respiratory Protection Program & OSHA Standard.
2. Respiratory Protection Safety Procedures.
3. Respirator Selection.
4. Respirator Operation and Use.
5. Why the respirator is necessary.
6. How improper fit, usage, or maintenance can compromise the protective effect.
7. Limitations and capabilities of the respirator.
8. How to use the respirator effectively in emergency situations, including respirator malfunctions.
9. How to inspect, put on and remove, use, and check the seals of the respirator.
10. Procedures for maintenance and storage of the respirator.
11. How to recognize medical signs and symptoms that may limit or prevent the effective use of respirators.
12. Change out schedule and procedure for air purifying respirators.



## Respiratory Protection Program Training Certificate *Example*

Name: \_\_\_\_\_

Department: \_\_\_\_\_ Date: \_\_\_\_\_

I have received Training on the Respiratory Protection Program. The Training included the following:

### **Classroom Training**

- ✓ Overview of the Company Respiratory Protection Program
- ✓ Respiratory Protection Safety Procedures
- ✓ Respirator Selection
- ✓ Respirator Operation and Use
- ✓ Why the respirator is necessary
- ✓ How improper fit, usage, or maintenance can compromise the protective effect.
- ✓ Limitations and capabilities of the respirator.
- ✓ How to use the respirator effectively in emergency situations, including respirator malfunctions.
- ✓ How to inspect, put on and remove, use, and check the seals of the respirator.
- ✓ Procedures for maintenance and storage of the respirator.
- ✓ How to recognize medical signs and symptoms that may limit or prevent the effective use of respirators.
- ✓ Respirator filter & cartridge changeout schedule
- ✓ The general requirements of this program

### **Hands-on Training**

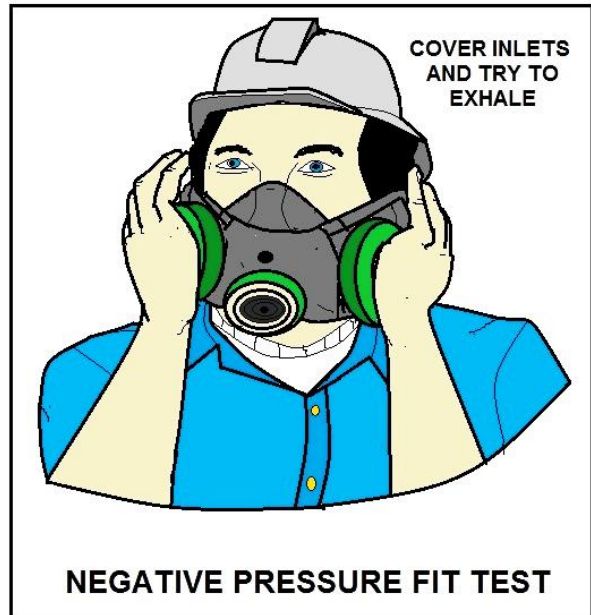
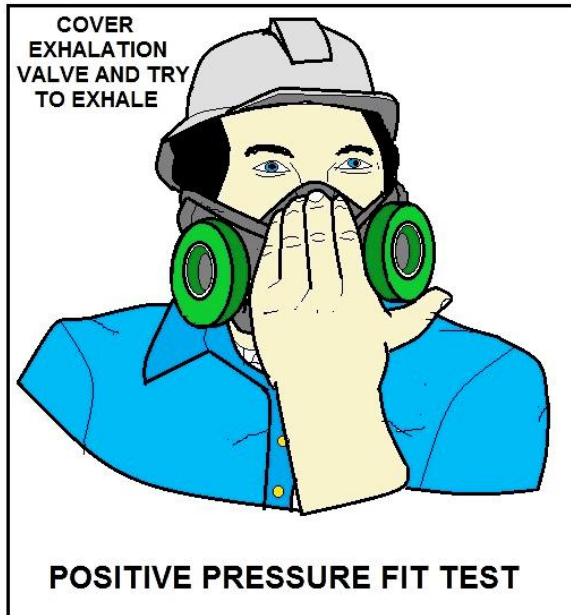
- ✓ Respirator Inspection
- ✓ Respirator cleaning and sanitizing
- ✓ Fit Check
- ✓ Record Keeping
- ✓ Respirator Storage
- ✓ Emergencies

\_\_\_\_\_  
Employee Signature

\_\_\_\_\_  
Trainer's Signature



## Fit Testing Hands-On Respirator Training



### POSITIVE AND NEGATIVE PRESSURE FIT CHECKS

1. Respirator Inspection
2. Respirator cleaning and sanitizing
3. Record Keeping
4. Respirator Storage
5. Respirator Fit Check
6. Emergencies

### Basic Respiratory Protection Safety Procedures

1. Only authorized and trained employees may use respirators. Those employees may use only the respirator that they have been trained on and properly fitted to use.
2. Only physically qualified employees may be trained and authorized to use respirators. A pre-authorization and annual certification by a qualified physician will be required and maintained. Any changes in an Employee's health or physical characteristics will be reported to the Occupational Health Department and will be evaluated by a qualified physician.
3. Only the proper prescribed respirator or SCBA may be used for the job or work environment. Air cleansing respirators may be worn in work environments when oxygen levels are between 19.5 percent to 23.5 percent and when the appropriate air cleansing canister, as determined by the Manufacturer and approved by NIOSH or MESA, for the known hazardous substance is used. SCBAs will be worn in oxygen deficient and oxygen rich environments (below 19.5 percent or above 23.5 percent oxygen).
4. Employees working in environments where a sudden release of a hazardous substance is likely will wear an appropriate respirator for that hazardous substance (example: employees working in an ammonia compressor room will have an ammonia APR respirator on their person.).

5. Only SCBAs will be used in oxygen deficient environments, environments with an unknown hazardous substance or unknown quantity of a known hazardous substance or any environment that is determined "**Immediately Dangerous to Life or Health**" (IDLH).
6. Employees with respirators loaned on "permanent check out" will be responsible for the sanitation, proper storage and security. Respirators damaged by normal wear will be repaired or replaced by the employer when returned.
7. The last employee using a respirator and/or SCBA that are available for general use will be responsible for proper storage and sanitation. Monthly and after each use, all respirators will be inspected with documentation to assure its availability for use.
8. All respirators will be located in a clean, convenient and sanitary location.
9. In the event that employees must enter a confined space, work in environments with hazardous substances that would be dangerous to life or health should an RPE fail (a SCBA is required in this environment), and/or conduct a HAZMAT entry, a "**buddy system**" detail will be used with a safety watchman with constant voice, visual or signal line communication. Employees will follow the established emergency response program and/or confined space entry program when applicable.
10. Management will establish and maintain surveillance of jobs and work place conditions and degree of employee exposure or stress to maintain the proper procedures and to provide the necessary RPE.
11. Management will establish and maintain safe operation procedures for the safe use of RPE with strict enforcement and disciplinary action for failure to follow all general and specific safety rules. Standard operation procedures for general RPE use will be maintained as an attachment to the respiratory protection program and standard operation procedures for RPE use under emergency response situations will be maintained as an attachment to the emergency response program.

### **Selection of Respirators**

The employer is responsible for and needs to have evaluated the respiratory hazard(s) in each workplace, identified relevant workplace and user factors and have based respirator selection on these factors. Also included are estimates of employee exposures to respiratory hazard(s) and an identification of the contaminant's chemical state and physical form.

This selection has included appropriate protective respirators for use in IDLH atmospheres, and has limited the selection and use of air-purifying respirators. All selected respirators are NIOSH-certified.

**Filter Classifications** - These classifications are marked on the filter or filter package

**N-Series: Not Oil Resistant**

- Approved for non-oil particulate contaminants
- Examples: dust, fumes, mists not containing oil

**R-Series: Oil Resistant**

- Approved for all particulate contaminants, including those containing oil
- Examples: dusts, mists, fumes
- Time restriction of 8 hours when oils are present

**P-Series: Oil Proof**

- Approved for all particulate contaminants including those containing oil
- Examples: dust, fumes, mists
- See Manufacturer's time use restrictions on packaging



### **Respirators for IDLH Atmospheres**

- The following respirators will be used in IDLH atmospheres:
- A full face piece pressure demand SCBA certified by NIOSH for a minimum service life of thirty minutes, or
- A combination full face piece pressure demand supplied-air respirator (**SAR**) with auxiliary self-contained air supply.
- Respirators provided only for escape from IDLH atmospheres shall be NIOSH-certified for escape from the atmosphere in which they will be used.

### **Respirators for Atmospheres that are not for IDLH**

The respirators selected shall be adequate to protect the health of the employee and ensure compliance with all other OSHA statutory and regulatory requirements, under routine and reasonably foreseeable emergency situations. The respirator selected shall be appropriate for the chemical state and physical form of the contaminant.

## What is the American Conference of Governmental Industrial Hygienists (ACGIH®) recommended exposure limit for chlorine?

ACGIH® TLV® - TWA : 0.5 ppm A4

ACGIH® TLV® - STEL [C]: 1 ppm

**Exposure Guideline Comments:** TLV® = Threshold Limit Value. TWA = Time-Weighted Average. STEL = Short-term exposure Limit. C = Ceiling limit. A4 = Not classifiable as a human carcinogen.

**NOTE:** In many (but not all) Canadian jurisdictions, the exposure limits are similar to the ACGIH® TLVs®. Since legislation varies by jurisdiction, contact your local jurisdiction for exact details.

### What Personal Protective Equipment (PPE) is needed when working with chlorine?

**Eye/Face Protection:** Wear chemical safety goggles. A face shield (with safety goggles) may also be necessary.

**Skin Protection:** Wear chemical protective clothing e.g. gloves, aprons, boots. Coveralls or long sleeve shirts and pants in some operations. Wear a chemical protective, full-body encapsulating suit and self-contained breathing apparatus (SCBA).

Suitable materials include: butyl rubber, neoprene rubber, Viton®, Viton®/butyl rubber, Barrier® - PE/PA/PE, Silver Shield® - PE/EVAL/PE, Trelchem® HPS, Trelchem® VPS, Saranex®™, Tychem® BR/LV, Tychem® Responder® CSM, Tychem® TK. The following materials should NOT be used: natural rubber, polyvinyl chloride. Recommendations are NOT valid for very thin neoprene rubber gloves (0.3 mm or less).

### Respiratory Protection:

Up to 5 ppm:

(APF = 10) Any chemical cartridge respirator with cartridge(s) providing protection against chlorine\*; or Any supplied-air respirator\*.

\*Reported to cause eye irritation or damage; may require eye protection.

APF = Assigned Protection Factor

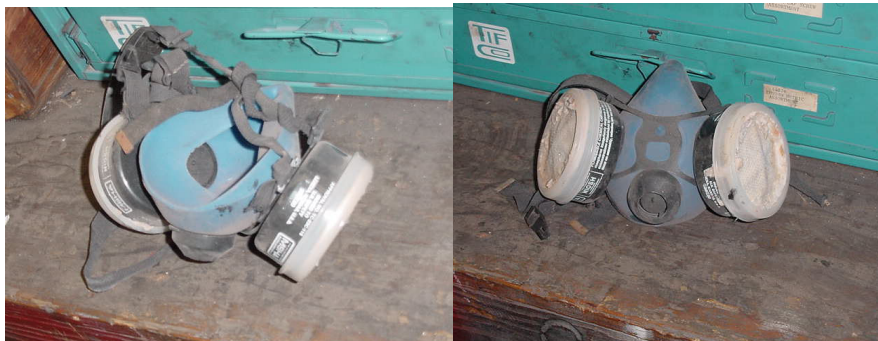
Recommendations apply only to National Institute for Occupational Safety and Health (NIOSH) approved respirators. Refer to the NIOSH Pocket Guide to Chemical Hazards for more information.

## Identification of Filters & Cartridges

All filters and cartridges shall be labeled and color coded with the NIOSH approval label; the label is not to be removed and must remain legible. A change out schedule for filters and canisters has been developed to ensure the elements of the respirators remain effective.

### Respirator Filter & Canister Replacement

An important part of the Respiratory Protection Program includes identifying the useful life of canisters and filters used on air-purifying respirators. Each filter and canister shall be equipped with an end-of-service-life indicator (**ESLI**) certified by NIOSH for the contaminant; or If there is no ESLI appropriate for conditions a change schedule for canisters and cartridges that is based on objective information or data that will ensure that canisters and cartridges are changed before the end of their service life.



**It is unacceptable maintenance and storage (OSHA Violation).**

### Filter & Cartridge Change Schedule

Stock of spare filters and cartridges shall be maintained to allow immediate change when required or desired by the employee.

#### Cartridges shall be changed based on the most limiting factor below:

- Prior to expiration date
- Manufacturer's recommendations for the specific use and environment
- After each use
- When requested by employee
- When contaminate odor is detected
- When restriction to air flow has occurred as evidenced by increased effort by user to breathe normally
- Cartridges shall remain in their original sealed packages until needed for immediate use

#### Filters shall be changed on the most limiting factor below:

- Prior to expiration date
- Manufacturer's recommendations for the specific use and environment
- When requested by employee
- When contaminate odor is detected
- When restriction to air flow has occurred as evidenced by increased effort by user to breathe normally
- When discoloring of the filter media is evident
- Filters shall remain in their original sealed package until needed for immediate use.

RESPIRATORY PROTECTION PROGRAM CHECKLIST		PAGE 1 OF 1 PAGES		
DIVISION:	SECTION:	SUPERVISOR:	DATE:	
		YES	NO	NA
1	Is respiratory protection (RP) being worn in the section?			
2	Has air sampling been accomplished that mandates using RP?			
3	Where air sampling results greater than Occupational Exposure Limits? (If NO, why are you using a respirator?)			
4	Has a Hazard Assessment been generated concerning the task or process that placed the section on the RP Program?			
5	Have all processes that may warrant the use of RP been evaluated? (If NO, request an assessment from the Department Safety Analyst /Personnel Safety, unless the operation is emergency response).			
6	Have workers received physicals and been found medically qualified to wear RP?			
7	Is there documentation that workers were formally briefed on air sampling results and why RP is required?			
8	Is respiratory protection training and fit-testing documentation available on everyone who wears a respirator?			
9	Are RP wearers being fit-tested at least annually?			
10	Are section employees wearing RP voluntarily when conditions have not mandated their use?			
11	Are employees wearing contacts in hazardous atmospheres or using eye-wear that negates face to face piece seal?			
12	Do RP users have facial hair that negates face to face piece seal?			
13	Has a respirator inventory been compiled that list the type of respirator(s) used in the workplace? (Use Respirator Inventory Worksheet attach to this checklist)			
14	Has the Section Supervisor received formal RP training on OSHA, City Personnel Safety and Respiratory Protection Program requirements and his or her responsibilities?			
15	Does the section have written standard operating instructions governing the selection, fit-testing, use, cleaning, storage and maintenance of respirators?			
16	Is the Fire Department the only source being used to charge SCBA's with compressed air?			
17	Are SCBA's being inspected at least every 30 days?			
18	Does the section have on hand, applicable OSHA, CITY, and Section Respiratory Protection Program guidance documents?			
19	Are periodic audits of the section's RP program conducted with discrepancies tracked until closed out?			
20	Have program deficiencies been elevated to the Director and Department Safety Analyst?			
SURVEYED BY:		REVIEWED BY:		



## Respiratory Protection Schedule by Job and Working Condition

The employer needs to maintain a Respiratory Protection Schedule by Job and working condition. This schedule is provided to each authorized and trained employee.

### ***The Schedule provides the following information:***

1. Job/Working conditions.
2. Work location.
3. Hazards present.
4. Type of respirator or SCBA required.
5. Type of filter/canister required.
6. Location of respirator or SCBA.
7. Filter/Cartridge change out schedule.

The schedule will be reviewed and updated at least annually and whenever any changes are made in the work environments, machinery, equipment, or processes or if respirator different respirator models are introduced or existing models are removed.



### **Permanent respirator Schedule Assignments are:**

Each person who engages in welding will have their own employer provided dust-mist-fume filter APR. This respirator will be worn during all welding operations.

### **Physical and Medical Qualifications**

Records of medical evaluations must be retained and made available in accordance with 29 CFR 1910.1020.

### **Medical Evaluation Required**

Using a respirator may place a physiological burden on employees that varies with the type of respirator worn, the job and workplace conditions in which the respirator is used, and the medical status of the employee. The Employer is required to provide a medical evaluation to determine the employee's ability to use a respirator before the employee is fit tested or required to use the respirator in the workplace.

### **Medical Evaluation Procedures**

The employee will be provided a medical questionnaire by the designated Occupational Health Care Provider.



## Follow-up Medical Examination

The employer shall ensure that a follow-up medical examination is provided for an employee who gives a positive response to any question among questions in Part B of the questionnaire or whose initial medical examination demonstrates the need for a follow-up medical examination.

The follow-up medical examination shall include any medical tests, consultations, or diagnostic procedures that the physician deems necessary to make a final determination.

### Administration of the Medical Questionnaire and Examinations.

The medical questionnaire and examinations shall be administered confidentially during the employee's normal working hours or at a time and place convenient to the employee.

The medical questionnaire shall be administered in a manner that ensures that the employee understands its content. The employer shall provide the employee with an opportunity to discuss the questionnaire and examination results with the Physician.



### Supplemental Information for the Physician

The following information must be provided to the physician before the Physician makes a recommendation concerning an employee's ability to use a respirator.

- The type and weight of the respirator to be used by the employee
- The duration and frequency of respirator use (including use for rescue and escape)
- The expected physical work effort
- Additional protective clothing and equipment to be worn
- Temperature and humidity extremes that may be encountered
- Any supplemental information provided previously to the physician regarding an employee need not be provided for a subsequent medical evaluation if the information and the physician remain the same.

The employer has provided the physician with a copy of the written respiratory protection program and a copy of the OSHA Standard 1910.134

### Acronyms

**Qualitative fit test (QLFT)** means a pass/fail fit test to assess the adequacy of respirator fit that relies on the individual's response to the test agent.

**Quantitative fit test (QNFT)** means an assessment of the adequacy of respirator fit by numerically measuring the amount of leakage into the respirator.

## Medical Determination

In determining the employee's ability to use a respirator, the employer shall:

- Obtain a written recommendation regarding the employee's ability to use the respirator from the physician. The recommendation shall provide only the following information:
  - Any limitations on respirator use related to the medical condition of the employee, or relating to the workplace conditions in which the respirator will be used, including whether or not the employee is medically able to use the respirator.
  - The need, if any, for follow-up medical evaluations.
  - A statement that the Physician has provided the employee with a copy of the physician's written recommendation.
- If the respirator is a negative pressure respirator and the physician finds a medical condition that may place the employee's health at increased risk if the respirator is used, the employer shall provide an APR if the physician's medical evaluation finds that the employee can use such a respirator; if a subsequent medical evaluation finds that the employee is medically able to use a negative pressure respirator, then the employer is no longer required to provide an APR.

### Additional Medical Evaluations

At a minimum, the employer shall provide additional medical evaluations that comply with the requirements of this section if:

- An employee reports medical signs or symptoms that are related to the ability to use a respirator
- A physician, supervisor, or the respirator program administrator informs the employer that an employee needs to be reevaluated
- Information from the respiratory protection program, including observations made during fit testing and program evaluation, indicates a need for employee reevaluation
- A change occurs in workplace conditions (e.g., physical work effort, protective clothing, and temperature) that may result in a substantial increase in the physiological burden placed on an employee.

### Respirator Fit Testing (see Appendix A for more information)

Before an employee is required to use any respirator with a negative or positive pressure tight-fitting face piece, the employee must be fit tested with the same make, model, style, and size of respirator that will be used. The Employer shall ensure that an employee using a tight-fitting face piece respirator is fit tested prior to initial use of the respirator, whenever a different respirator face piece (size, style, model or make) is used, and at least annually thereafter.

The employer has established a record of the qualitative and quantitative fit tests administered to employees including:

- The name or identification of the employee tested
- Type of fit test performed
- Specific make, model, style, and size of respirator tested
- Date of test
- The pass/fail results for QLFTs or the fit factor and strip chart recording or other recording of the test results for QNFTs

Additional fit tests will be conducted whenever the employee reports, or the employer, physician, supervisor, or program administrator makes visual observations of, changes in the employee's physical condition that could affect respirator fit.

Such conditions include, but are not limited to, facial scarring, dental changes, cosmetic surgery, or an obvious change in body weight.

If after passing a QLFT or QNFT, the employee notifies the employer's program administrator, supervisor, or physician that the fit of the respirator is unacceptable, the employee shall be given a reasonable opportunity to select a different respirator face piece and to be retested.

### **Types of Fit Tests**

The fit test shall be administered using an OSHA-accepted QLFT or QNFT protocol. The OSHA-accepted QLFT and QNFT protocols and procedures are contained in Appendix A of OSHA Standard 1910.134.

- QLFT may only be used to fit test negative pressure air-purifying respirators that must achieve a fit factor of 100 or less.
- If the fit factor, as determined through an OSHA-accepted QNFT protocol, is equal to or greater than 100 for tight-fitting half face pieces, or equal to or greater than 500 for tight-fitting full face pieces, the QNFT has been passed with that respirator.
- Fit testing of tight-fitting atmosphere-supplying respirators and tight-fitting powered air-purifying respirators shall be accomplished by performing quantitative or qualitative fit testing in the negative pressure mode, regardless of the mode of operation (negative or positive pressure) that is used for respiratory protection.
- Qualitative fit testing of these respirators shall be accomplished by temporarily converting the respirator user's actual face piece into a negative pressure respirator with appropriate filters, or by using an identical negative pressure air-purifying respirator face piece with the same sealing surfaces as a surrogate for the atmosphere-supplying or powered air-purifying respirator face piece.
- Quantitative fit testing of these respirators shall be accomplished by modifying the face piece to allow sampling inside the face piece in the breathing zone of the user, midway between the nose and mouth. This requirement shall be accomplished by installing a permanent sampling probe onto a surrogate face piece, or by using a sampling adapter designed to temporarily provide a means of sampling air from inside the face piece.
- Any modifications to the respirator face piece for fit testing shall be completely removed, and the face piece restored to NIOSH approved configuration, before that face piece can be used in the workplace.

Fit test records shall be retained for respirator users until the next fit test is administered. Written materials required to be retained shall be made available upon request to affected employees.

### **Respirator Operation and Use**

Respirators will only be used following the respiratory protection safety procedures established in this program. The Operations and Use Manuals for each type of respirator will be maintained by the program administrator and be available to all qualified users.

Surveillance by the direct supervisor shall be maintained of work area conditions and degree of employee exposure or stress. When there is a change in work area conditions or degree of employee exposure or stress that may affect respirator effectiveness, the employer shall reevaluate the continued effectiveness of the respirator.

### **For continued protection of respirator users, the following general use rules apply:**

- Users shall not remove respirators while in a hazardous environment
- Respirators are to be stored in sealed containers out of harmful atmospheres
- Store respirators away from heat and moisture

- Store respirators such that the sealing area does not become distorted or warped
- Store respirators such that the face piece is protected
- Face piece seal protection

**The Employer does not permit respirators with tight-fitting face pieces to be worn by employees who have:**

- Facial hair that comes between the sealing surface of the face piece and the face or that interferes with valve function; or
- Any condition that interferes with the face-to-face piece seal or valve function.

If an employee wears corrective glasses or goggles or other personal protective equipment, the employer shall ensure that such equipment is worn in a manner that does not interfere with the seal of the face piece to the face of the user.

**Continuing Effectiveness of Respirators**

The employer shall ensure that employees leave the respirator use area for the following:

- To wash their faces and respirator face pieces as necessary to prevent eye or skin irritation associated with respirator use
- If they detect vapor or gas breakthrough, changes in breathing resistance, or leakage of the face piece
- To replace the respirator or the filter, cartridge, or canister elements.

If the employee detects vapor or gas breakthrough, changes in breathing resistance, or leakage of the face piece, the employer will replace or repair the respirator before allowing the employee to return to the work area.

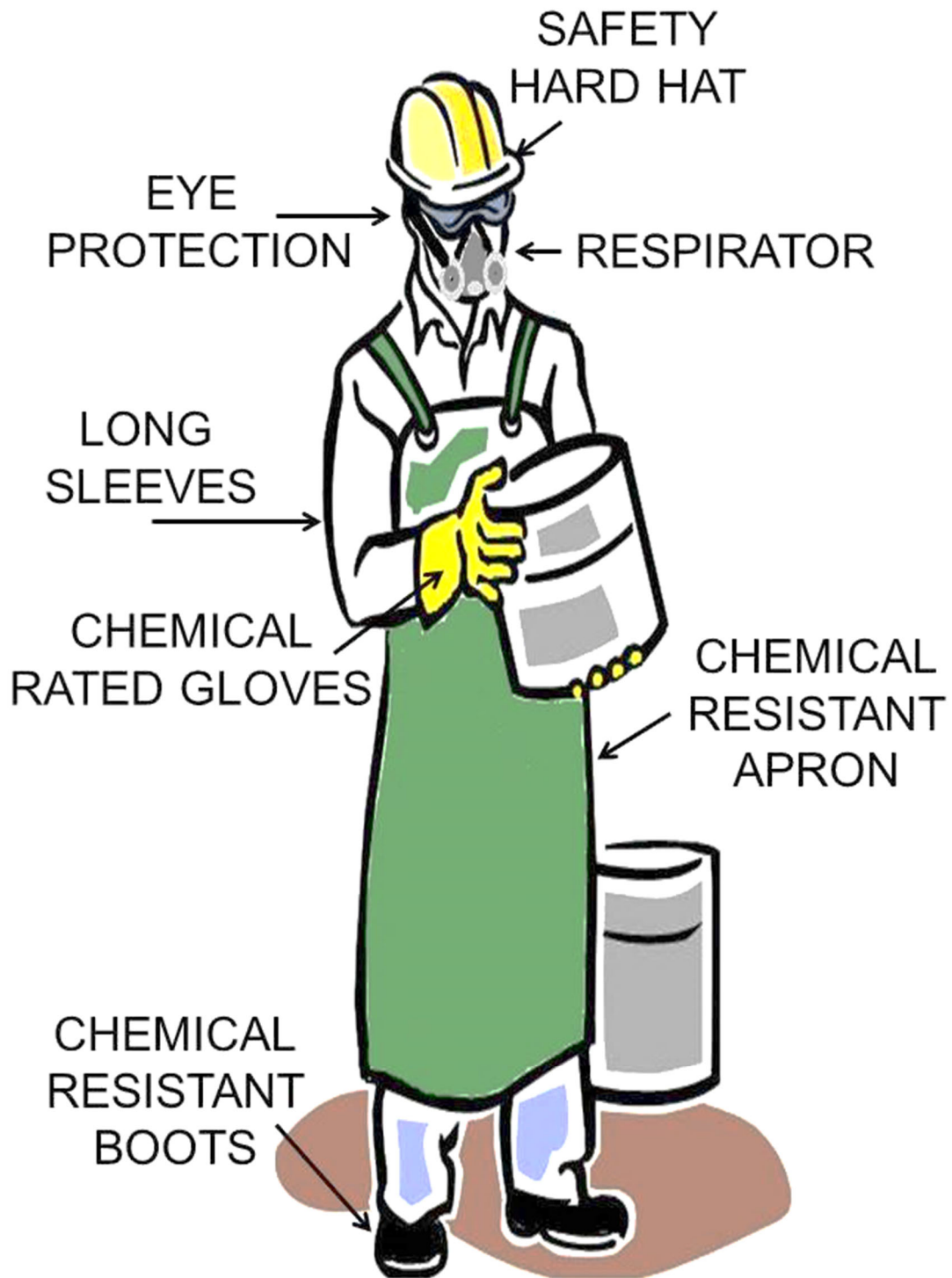
**Procedures for IDLH atmospheres**

**For all IDLH atmospheres, the Employer shall ensure that:**

- One employee or, when needed, more than one employee is located outside the IDLH atmosphere
- Visual, voice, or signal line communication is maintained between the employee(s) in the IDLH atmosphere and the employee(s) located outside the IDLH atmosphere
- The employee(s) located outside the IDLH atmosphere are trained and equipped to provide effective emergency rescue
- The employer or designee is notified before the employee(s) located outside the IDLH atmosphere enter the IDLH atmosphere to provide emergency rescue
- The employer or designee authorized to do so by the employer, once notified, provides necessary assistance appropriate to the situation

**Employee(s) located outside the IDLH atmospheres will be equipped with:**

- Pressure demand or other positive pressure SCBAs, or a pressure demand or other positive pressure supplied-air respirator with auxiliary SCBA; and either
- Appropriate retrieval equipment for removing the employee(s) who enter(s) these hazardous atmospheres where retrieval equipment would contribute to the rescue of the employee(s) and would not increase the overall risk resulting from entry; or
- Equivalent means for rescue where retrieval equipment is not required.



## Gas and Vapor Contaminants

Gas and vapor contaminants can be classified according to their chemical characteristics. True gaseous contaminants are similar to air in that they possess the same ability to diffuse freely within an area or container. Nitrogen, chlorine, carbon monoxide, carbon dioxide and sulfur dioxide are examples.

Vapors are the gaseous state of substances that are liquids or solids at room temperature. They are formed when the solid or liquid evaporates. Gasoline, solvents and paint thinners are examples of liquids that evaporate easily, producing vapors.

***In terms of chemical characteristics, gaseous contaminants may be classified as follows:***

- **Inert Gases** —These include such true gases as helium, argon, neon, etc. Although they do not metabolize in the body, these gases represent a hazard because they can produce an oxygen deficiency by displacement of air.
- **Acidic Gases** —Often highly toxic, acidic gases exist as acids or produce acids by reaction with water. Sulfur dioxide, hydrogen sulfide and hydrogen chloride are examples.
- **Alkaline Gases** —These gases exist as alkalis or produce alkalis by reaction with water. Ammonia and phosphine are two examples.

***In terms of chemical characteristics, vaporous contaminants may be classified as follows:***

- **Organic Compounds** —Contaminants in this category can exist as true gases or vapors produced from organic liquids. Gasoline, solvents and paint thinners are examples.
- **Organometallic Compounds** —These are generally comprised of metals attached to organic groups. Tetraethyllead and organic phosphates are examples.

### Hazard Assessment

Proper assessment of the hazard is the first important step to protection. This requires a thorough knowledge of processes, equipment, raw materials, end-products and by-products that can create an exposure hazard.

To determine an atmosphere's oxygen content or concentration levels of particulate and/or gaseous contaminants, air samples must be taken with proper sampling instruments during all conditions of operation. The sampling device and the type and frequency of sampling (spot testing or continuous monitoring) will be dictated by the exposure and operating conditions.

Breathing zone samples are recommended and sampling frequency should be sufficient to assess the average exposure under the variable operating and exposure conditions.

Should contaminant concentrations exceed exposure limits recommended by the American Conference of Governmental Industrial Hygienists (**ACGIH**), OSHA or NIOSH, hazard control procedures must be implemented promptly.

Exposure monitoring plays a critical role in the respirator selection process. The results from such tests will help you determine whether respiratory protection is needed and, if it is, the type of respirator required. Generally, respirator selection is based on three factors:

- The results of your atmospheric monitoring or sampling program;
- The accepted ACGIH, OSHA or NIOSH exposure limits for the substance(s) present;
- And the maximum use concentration (of a substance) for which a respirator can be used.

Exposure limits include ACGIH Threshold Limit Values (**TLVs**), OSHA Permissible Exposure Limits (**PELs**), NIOSH Recommended Exposure Levels (**RELs**) and AIHA Workplace Environmental Exposure Levels (**WEELs**).

These values are guides for exposure concentrations that healthy individuals can normally tolerate for eight hours a day, five days a week without harmful effects. Unless otherwise noted, exposure limits are eight-hour, time-weighted-average (**TWA**) concentrations.

In general, gas and vapor exposure limits are expressed in ppm by volume (parts of contaminant per million parts of air), while particulate concentrations are expressed as mg/m<sup>3</sup> (milligrams of concentrations per cubic meter of air). For substances that can exist in more than one form (particulate or gaseous), concentrations are expressed in both values.

It is important to note that exposure limits and other exposure standards are constantly changing as more data is gathered about specific chemicals and substances. As such, you must be certain that you are using the most recent data when determining allowable exposure levels for employees.

### **Hazard Control**

Hazard control should start at the process, equipment and plant design levels where contaminants can be effectively controlled at the outset. With operating processes, the problem becomes more difficult. In all cases, however, consideration should be given to the use of effective engineering controls to eliminate and/or reduce exposures to respiratory hazards.

This includes consideration of process encapsulation or isolation, use of less toxic materials in the process and suitable exhaust ventilation, filters and scrubbers to control the effluents.

Because it is sometimes not practical to maintain engineering controls that eliminate all airborne concentrations of contaminants, proper respiratory protective devices should be used whenever such protection is required.

***Hazard Assessment or Hazard Certification sheet example is on the following page.***

Even if you have a written RP Program and complete training records, OSHA will ask for a hazard certification or assessment form on where or why you need RP.

For example, if you were required to don SCBA to change a chlorine cylinder once a week, OSHA would request to see how that task was evaluated and certified.



## RP Cleaning and Disinfecting

The employer shall provide each respirator user with a respirator that is clean, sanitary, and in good working order. The employer shall ensure that respirators are cleaned and disinfected using the Standard Operating Procedure SOP: Cleaning and Disinfecting.

### The respirators shall be cleaned and disinfected when:

- Respirators issued for the exclusive use of an employee shall be cleaned and disinfected as often as necessary to be maintained in a sanitary condition.
- Respirators issued to more than one employee shall be cleaned and disinfected before being worn by different individuals.
- Respirators maintained for emergency use shall be cleaned and disinfected after each use.
- Respirators used in fit testing and training shall be cleaned and disinfected after each use.

Cleaning and Storage of respirators assigned to specific employees is the responsibility of that employee.

### Respirator Inspection

All respirators/SCBAs, both available for "**General Use**" and those on "**Permanent Check-out**", will be inspected after each use and at least monthly. Should any defects be noted, the respirator/SCBA will be taken to the program Administrator. Damaged Respirators will be either repaired or replaced. The inspection of respirators loaned on "**Permanent Check-out**" is the responsibility of that trained employee.

### Respirators shall be inspected as follows:

- All respirators used in routine situations shall be inspected before each use and during cleaning.
- All respirators maintained for use in emergency situations shall be inspected at least monthly and in accordance with the manufacturer's recommendations, and shall be checked for proper function before and after each use.
- Emergency escape-only respirators shall be inspected before being carried into the workplace for use.

### Respirator inspections include the following:

- A check of respirator function, tightness of connections, and the condition of the various parts including, but not limited to, the face piece, head straps, valves, connecting tube, and cartridges, canisters or filters
- Check of elastomeric parts for pliability and signs of deterioration.
- Self-contained breathing apparatus shall be inspected monthly. Air and oxygen cylinders shall be maintained in a fully charged state and shall be recharged when the pressure falls to 90% of the manufacturer's recommended pressure level. The employer shall determine that the regulator and warning devices function properly

### For Emergency Use Respirators the additional requirements apply:

- Certify the respirator by documenting the date the inspection was performed, the name (or signature) of the person who made the inspection, the findings, required remedial action, and a serial number or other means of identifying the inspected respirator.
- Provide this information on a tag or label that is attached to the storage compartment for the respirator, is kept with the respirator, or is included in inspection reports stored as paper or electronic files. This information shall be maintained until replaced following a subsequent certification.



## Respirator Storage

### Respirators are to be stored as follows:

- All respirators shall be stored to protect them from damage, contamination, dust, sunlight, extreme temperatures, excessive moisture, and damaging chemicals, and they shall be packed or stored to prevent deformation of the face piece and exhalation valve.
- **Emergency Respirators shall be:**
- Kept accessible to the work area;
- Stored in compartments or in covers that are clearly marked as containing emergency respirators; and
- Stored in accordance with any applicable manufacturer instructions.

### Repair of Respirators

Respirators that fail an inspection or are otherwise found to be defective will be removed from service to be discarded, repaired or adjusted in accordance with the following procedures:

- Repairs or adjustments to respirators are to be made only by persons appropriately trained to perform such operations and shall use only the respirator manufacturer's NIOSH-approved parts designed for the respirator;
- Repairs shall be made according to the manufacturer's recommendations and specifications for the type and extent of repairs to be performed; and
- Reducing and admission valves, regulators, and alarms shall be adjusted or repaired only by the manufacturer or a technician trained by the manufacturer.

### Breathing Air Quality and Use

The employer shall ensure that compressed air, compressed oxygen, liquid air, and liquid oxygen used for respiration accords with the following specifications:

- Compressed and liquid oxygen shall meet the United States Pharmacopoeia Requirements for medical or breathing oxygen; and
- Compressed breathing air shall meet at least the requirements for Grade D breathing air described in ANSI/Compressed Gas Association Commodity Specification for Air, G-7.1-1989, to include:
  - Oxygen content (v/v) of 19.5-23.5%;
  - Hydrocarbon (condensed) content of 5 milligrams per cubic meter of air or less;
  - Carbon monoxide content of 10 ppm or less;
  - Carbon dioxide content of 1,000 ppm or less; and
  - Lack of noticeable odor.
- Compressed oxygen will not be used in atmosphere-supplying respirators that have previously used compressed air.
- Oxygen concentrations greater than 23.5% are used only in equipment designed for oxygen service or distribution.

### Cylinders used to supply breathing air to respirators meet the following requirements:

- Cylinders are tested and maintained as prescribed in the Shipping Container Specification Regulations of the Department of Transportation (49 CFR part 173 and part 178).
- Cylinders of purchased breathing air have a certificate of analysis from the supplier that the breathing air meets the requirements for Grade D breathing air.
- Moisture content in breathing air cylinders does not exceed a dew point of -50 deg. F (-45.6 deg. C) at 1 atmosphere pressure.

- Breathing air couplings are incompatible with outlets for nonrespirable worksite air or other gas systems. No asphyxiating substance shall be introduced into breathing air lines.
- Breathing gas containers shall be marked in accordance with the NIOSH respirator certification standard, 42 CFR part 84.

## Summary



**READ THE SAFETY DATA SHEET**



**WEAR PROPER PPE**



**HANDLING CHEMICALS**

### Following this training session, employees should:

- Wear the respirator assigned to him or her
- Always check for fit before wearing
- Always check for damage and deterioration before wearing
- Know when to replace canisters and cartridges
- Practice maneuvering with a respirator
- Store carefully in the proper location.

## Personal Protective Equipment Example Sub-Section

### Purpose

Your Employer is required to provide all Employees with required PPE to suit the task and known hazards. This Chapter covers the requirements for Personal Protective Equipment with the exception of PPE used for respiratory protection or PPE required for hazardous material response to spills or releases. Applicable OSHA Standards are 1910 Subpart 1 App B and 1910.120 App B, 132, 133, 136, and 138.

### General Rules Design

All personal protective equipment shall be of safe design and construction for the work to be performed.

### Hazard Assessment and Equipment Selection

Hazard analysis procedures shall be used to assess the workplace to determine if hazards are present, or are likely to be present, which necessitate the use of personal protective equipment (PPE). If such hazards are present, or likely to be present, the following actions will be taken:

- 1) Select, and have each affected Employee use, the proper PPE.
- 2) Communicate selection decisions to each affected Employee.
- 3) Select PPE that properly fits each affected employee.

### Defective and Damaged Equipment.

Defective or damaged personal protective equipment shall not be used.

### Training

All Employees who are required to use PPE shall be trained to know at least the following:

- 1) When PPE is necessary;
- 2) What PPE is necessary;
- 3) How to properly don, remove, adjust, and wear PPE;
- 4) The limitations of the PPE
- 5) The proper care, maintenance, useful life and disposal of the PPE.

Each affected Employee shall demonstrate an understanding of the training and the ability to use PPE properly, before being allowed to perform work requiring the use of PPE.

Certification of training for PPE is required by OSHA and shall be accomplished by using the Job Safety Checklist to verify that each affected Employee has received and understood the required PPE training.

### Personal Protective Equipment Selection

#### Controlling Hazards

PPE devices alone should not be relied on to provide protection against hazards, but should be used in conjunction with guards, engineering controls, and sound manufacturing practices.



## Selection Guidelines

### ***The general procedure for selection of protective equipment is to:***

- a) Become familiar with the potential hazards and the type of protective equipment that is available, and what it can do; i.e., splash protection, impact protection, etc.
- b) Compare the hazards associated with the environment (i.e., impact velocities, masses, projectile shape, radiation intensities) with the capabilities of the available protective equipment;
- c) Select the protective equipment which ensures a level of protection greater than the minimum required to protect employees from the hazards;
- d) Fit the user with the protective device and give instructions on care and use of the PPE. It is very important that end users be made aware of all warning labels for and limitations of their PPE.

### **Fitting the Device**

Careful consideration must be given to comfort and fit. PPE that fits poorly will not afford the necessary protection. Continued wearing of the device is more likely if it fits the wearer comfortably. Protective devices are generally available in a variety of sizes. Care should be taken to ensure that the right size is selected.

### **Devices with Adjustable Features**

Adjustments should be made on an individual basis for a comfortable fit that will maintain the protective device in the proper position. Particular care should be taken in fitting devices for eye protection against dust and chemical splash to ensure that the devices are sealed to the face. In addition, proper fitting of helmets is important to ensure that it will not fall off during work operations.

In some cases a chin strap may be necessary to keep the helmet on an employee's head. (Chin straps should break at a reasonably low force, however, so as to prevent a strangulation hazard). Where manufacturer's instructions are available, they should be followed carefully.

### **Eye and Face Protection**

Each affected employee shall use appropriate eye or face protection when exposed to eye or face hazards from flying particles, molten metal, liquid chemicals, acids or caustic liquids, chemical gases or vapors, or potentially injurious light radiation.

Each affected employee shall use eye protection that provides side protection when there is a hazard from flying objects. Detachable side protectors are acceptable.

Each affected employee who wears prescription lenses while engaged in operations that involve eye hazards shall wear eye protection that incorporates the prescription in its design, or shall wear eye protection that can be worn over the prescription lenses without disturbing the proper position of the prescription lenses or the protective lenses.

Eye and face PPE shall be distinctly marked to facilitate identification of the manufacturer.

Each affected employee shall use equipment with filter lenses that have a shade number appropriate for the work being performed for protection from injurious light radiation. The following is a listing of appropriate shade numbers for various operations.



Always utilize a chemical fume hood and ventilation system when working or testing Chlorine. Melissa Durbin shown in photo.

### **What are the engineering controls for chlorine?**

**Engineering Controls:** Use a local exhaust ventilation and enclosure, if necessary, to control amount in the air. Consider using Use a corrosion-resistant exhaust ventilation system separate from other ventilation systems.

It may be necessary to use stringent control measures such as process enclosure to prevent product release into the workplace. Use back-up controls (e.g. double mechanical pump seals) to prevent the release of this material due to equipment failure. Provide eyewash and safety shower if contact or splash hazard exists.





## Glossary of Respiratory Protection Terms

The following definitions are important terms used in the respiratory protection standard and terms that will assist in the understanding and the application of the NIOSH decision logic.

**Air-Purifying Respirator:** A respirator with an air-purifying filter, cartridge, or canister that removes specific air contaminants by passing ambient air through the air-purifying element. OSHA Definition

**Assigned Protection Factor (APF):** See **PROTECTION FACTOR**. NIOSH Definition

**Atmosphere-Supplying Respirator:** A respirator that supplies the respirator user with breathing air from a source independent of the ambient atmosphere, and includes supplied-air respirators (SARs) and self-contained breathing apparatus (SCBA) units. OSHA Definition

**Breakthrough:** The penetration of challenge material(s) through a gas or a vapor air-purifying element. The quantity or extent of breakthrough during service life testing is often referred to as the percentage of the input concentration. NIOSH Definition

**Canister or Cartridge:** A container with a filter, sorbent, or catalyst, or combination of these items, which removes specific contaminants from the air passed through the container. OSHA Definition

**Demand Respirator:** An atmosphere-supplying respirator that admits breathing air to the facepiece only when a negative pressure is created inside the facepiece by inhalation. OSHA Definition

**Disposable Respirators:** A respirator that is discarded after the end of its recommended period of use, after excessive resistance or physical damage, or when odor breakthrough or other warning indicators render the respirator unsuitable for further use. NIOSH Definition

**Dust:** A solid, mechanically produced particle with a size ranging from submicroscopic to macroscopic. NIOSH Definition

**Emergency Respirator Use Situation:** A situation that requires the use of respirators due to the unplanned generation of a hazardous atmosphere (often of unknown composition) caused by an accident, mechanical failure, or other means and that requires evacuation of personnel or immediate entry for rescue or corrective action. NIOSH Definition

**Emergency Situation:** Any occurrence such as, but not limited to, equipment failure, rupture of containers, or failure of control equipment that may or does result in an uncontrolled significant release of an airborne contaminant. OSHA Definition

**Employee Exposure:** Exposure to a concentration of an airborne contaminant that would occur if the employee were not using respiratory protection. OSHA Definition

**End-Of-Service-Life Indicator (ESLI):** A system that warns the respirator user of the approach of the end of adequate respiratory protection; for example, that the sorbent is approaching saturation or is no longer effective. OSHA Definition

**Escape Gas Mask:** A gas mask that consists of a half-mask facepiece or mouthpiece, a canister, and associated connections, and that is designed for use during escape-only from hazardous atmospheres. NIOSH Definition

**Escape Only Respirator:** Respiratory devices that are designed for use only during escape from hazardous atmospheres. NIOSH Definition

**Escape-Only Respirator:** A respirator intended to be used only for emergency exit. OSHA Definition

**Filter or Air-Purifying Element:** A component used in respirators to remove solid or liquid aerosols from the inspired air. OSHA Definition

**Filtering Facepiece:** A particulate respirator with a filter as an integral part of the facepiece or with the entire facepiece composed of the filtering medium. (See *SINGLE-USE DUST or DUST and MIST RESPIRATORS and DISPOSABLE RESPIRATORS*.) NIOSH Definition

**Filtering Facepiece (Dust Mask):** A negative pressure particulate respirator with a filter as an integral part of the facepiece or with the entire facepiece composed of the filtering medium. OSHA Definition

**Fit Factor:** A quantitative measure of the fit of a specific respirator facepiece to a particular individual. NIOSH Definition

**Fit Factor:** A quantitative estimate of the fit of a particular respirator to a specific individual, and typically estimates the ratio of the concentration of a substance in ambient air to its concentration inside the respirator when worn. OSHA Definition

**Fit Test:** Means the use of a protocol to qualitatively or quantitatively evaluate the fit of a respirator on an individual. (See also Qualitative fit test QLFT and Quantitative fit test QNFT.) OSHA Definition

**Fume:** A solid condensation particulate, usually of a vaporized metal. NIOSH Definition

**Gas:** An aeriform fluid that is in a gaseous state at standard temperature and pressure. NIOSH Definition

**Helmet:** A rigid respiratory inlet covering that also provides head protection against impact and penetration. OSHA Definition

**High-Efficiency Particulate Air (Hepa) Filter:** A filter that is at least 99.97% efficient in removing monodisperse particles of 0.3 micrometers in diameter. The equivalent NIOSH 42 CFR 84 particulate filters are the N100, R100, and P100 filters. OSHA Definition

**Hood:** Means a respiratory inlet covering that completely covers the head and neck and may also cover portions of the shoulders and torso. OSHA Definition

**Immediately Dangerous to Life or Health (IDLH):** Acute respiratory exposure that poses an immediate threat of loss of life, immediate or delayed irreversible adverse effects on health, or acute eye exposure that would prevent escape from a hazardous atmosphere. NIOSH Definition

**Immediately Dangerous to Life or Health (IDLH):** An atmosphere that poses an immediate threat to life, would cause irreversible adverse health effects, or would impair an individual's ability to escape from a dangerous atmosphere. OSHA Definition

**Interior Structural Firefighting:** The physical activity of fire suppression, rescue or both, inside of buildings or enclosed structures which are involved in a fire situation beyond the incipient stage. (See 29 CFR 1910.155) OSHA Definition

**Loose-Fitting Facepiece:** A respiratory inlet covering that is designed to form a partial seal with the face. OSHA Definition

**Maximum Use Concentration (MUC):** [Reserved] OSHA Definition

**Mist:** A liquid condensation particulate. NIOSH Definition

**Negative Pressure Respirator (Tight Fitting):** A respirator in which the air pressure inside the facepiece is negative during inhalation with respect to the ambient air pressure outside the respirator. OSHA Definition

**Orinasal Respirator:** A respirator that covers the nose and mouth and that generally consists of a quarter- or half-facepiece. NIOSH Definition

**Oxygen Deficient Atmosphere:** An atmosphere with an oxygen content below 19.5% by volume. OSHA Definition

**Physician or Other Licensed Health Care Professional (PLHCP):** Means an individual whose legally permitted scope of practice (i.e., license, registration, or certification) allows him or her to independently provide, or be delegated the responsibility to provide, some or all of the health care services required by paragraph (e) of this section. OSHA Definition

**Planned or Unplanned Entry into an IDLH Environment, an Environment of Unknown Concentration of Hazardous Contaminant, or an Environment of Unknown Composition:** A situation in which respiratory devices are recommended to provide adequate protection to workers entering an area where the contaminant concentration is above the IDLH or is unknown. NIOSH Definition

**Positive Pressure Respirator:** A respirator in which the pressure inside the respiratory inlet covering exceeds the ambient air pressure outside the respirator. OSHA Definition

**Potential Occupational Carcinogen:** Any substance, or combination or mixture of substances, which causes an increased incidence of benign and/or malignant neoplasms, or a substantial decrease in the latency period between exposure and onset of neoplasms in humans or in one or more experimental mammalian species as the result of any oral, respiratory, or dermal exposure, or any other exposure which results in the induction of tumors at a site other than the site of administration. This definition also includes any substance that is metabolized into one or more potential occupational carcinogens by mammals (29 CFR 1910.103, OSHA Cancer Policy). NIOSH Definition

**Powered Air-Purifying Respirator (PAPR):** An air-purifying respirator that uses a blower to force the ambient air through air-purifying elements to the inlet covering. OSHA Definition

**Pressure Demand Respirator:** A positive pressure atmosphere- supplying respirator that admits breathing air to the facepiece when the positive pressure is reduced inside the facepiece by inhalation. OSHA Definition

**Protection Factors:** NIOSH Definition

**Assigned Protection Factor (APF):** The minimum anticipated protection provided by a properly functioning respirator or class of respirators to a given percentage of properly fitted and trained users.

**Simulated Workplace Protection Factor (SWPF):** A surrogate measure of the workplace protection provided by a respirator.

**Workplace Protection Factor (WPF):** A measure of the protection provided in the workplace by a properly functioning respirator when correctly worn and used.

**Qualitative Fit Test (QLFT):** A pass/fail fit test to assess the adequacy of respirator fit that relies on the individual's response to the test agent. OSHA Definition

**Quantitative Fit Test (QNFT):** Means an assessment of the adequacy of respirator fit by numerically measuring the amount of leakage into the respirator. OSHA Definition

**Recommended Exposure Limit (REL):** An 8- or 10-hour time-weighted average (TWA) or ceiling (C) exposure concentration recommended by NIOSH that is based on an evaluation of the health effects data. NIOSH Definition

**Respiratory Inlet Covering:** The portion of a respirator that forms the protective barrier between the user's respiratory tract and an air-purifying device or breathing air source, or both. It may be a facepiece, a helmet, a hood, a suit, or a mouthpiece respirator with nose clamp. OSHA Definition

**Self-Contained Breathing Apparatus (SCBA):** An atmosphere-supplying respirator for which the breathing air source is designed to be carried by the user. OSHA Definition

**Service Life:** The length of time required for an air-purifying element to reach a specific effluent concentration. Service life is determined by the type of substance being removed, the concentration of the substance, the ambient temperature, the specific element being tested (cartridge or canister), the flow rate resistance, and the selected breakthrough value. The service life for a self-contained breathing apparatus (SCBA) is the period of time, as determined by the NIOSH certification tests, in which adequate breathing gas is supplied. NIOSH Definition

**Service Life:** The period of time that a respirator, filter or sorbent, or other respiratory equipment provides adequate protection to the wearer. OSHA Definition

**Single-Use Dust or Dust and Mist Respirators:** Respirators approved for use against dusts or mists that may cause pneumoconiosis and fibrosis. NIOSH Definition

**Supplied-Air Respirator (SAR) or Airline Respirator:** An atmosphere-supplying respirator for which the source of breathing air is not designed to be carried by the user. OSHA Definition

**This Section:** This respiratory protection standard. OSHA Definition

**Tight-Fitting Facepiece:** A respiratory inlet covering that forms a complete seal with the face. OSHA Definition

**User Seal Check:** An action conducted by the respirator user to determine if the respirator is properly seated to the face. OSHA Definition

**Vapor:** The gaseous state of a substance that is solid or liquid at temperatures and pressures normally encountered. NIOSH Definition

## Respiratory Protection Post Quiz

### True or False Questions

1. The Employee is required to retain written information regarding medical evaluations, fit testing, and the respirator program.
2. Training will be provided prior to requiring the employee to use a respirator in the workplace.

The training shall ensure that each employee can demonstrate knowledge of at least the following:

#3-7

3. Why the respirator is necessary and how improper fit, usage, or maintenance can compromise the protective effect of the respirator.
4. How to use the respirator effectively in emergency situations, including situations in which the respirator malfunctions.
5. How to inspect, put on and remove, use, and check the seals of a transmission.
6. What the procedures are for maintenance and storage of the respirator.
7. How not to recognize medical signs and symptoms that may not limit or prevent the effective use of respirators

### Retraining shall be conducted annually and when:

8. Changes in the workplace or the type of respirator render previous training obsolete.
9. Adequacies in the employee's knowledge or use of the respirator indicate that the employee has retained the requisite understanding or skill.
10. Other situation arises in which retraining appears necessary to ensure safe respirator use.
11. A pre-authorization and annual certification by a qualified physician will be required and maintained. Any changes in an Employees health or physical characteristics will be reported to the Occupational Health Department and will be evaluated by a qualified physician.

12. Only the proper prescribed dust mask or OSHA may be used for the job or work environment.

13. Employees working in environments where a sudden release of a hazardous substance is likely will wear an appropriate respirator for that hazardous substance (example: Employees working in an ammonia compressor room will have an ammonia APR respirator on their person.).

14. Only SCBAs will be used in oxygen deficient environments, environments with an unknown hazardous substance or unknown quantity of a known hazardous substance or any environment that is determined "Immediately Dangerous to Life or Health" (IDLH).

15. Employees will follow the established Emergency Response Program and/or Confined Space Entry Program when applicable.

16. Management will establish and maintain surveillance of jobs and work place conditions and degree of Employee exposure or stress to maintain the proper procedures and to provide the necessary RPE.

17. The Employer is responsible and need to have evaluated the respiratory hazard(s) in each workplace, identified relevant workplace and user factors and has based respirator selection on these factors. Also included are estimates of employee exposures to respiratory hazard(s) and an identification of the contaminant's chemical state and physical form.

18. Respirators provided only for escape from PEL atmospheres shall be NIOSH-certified for escape from the atmosphere in which they will be used.

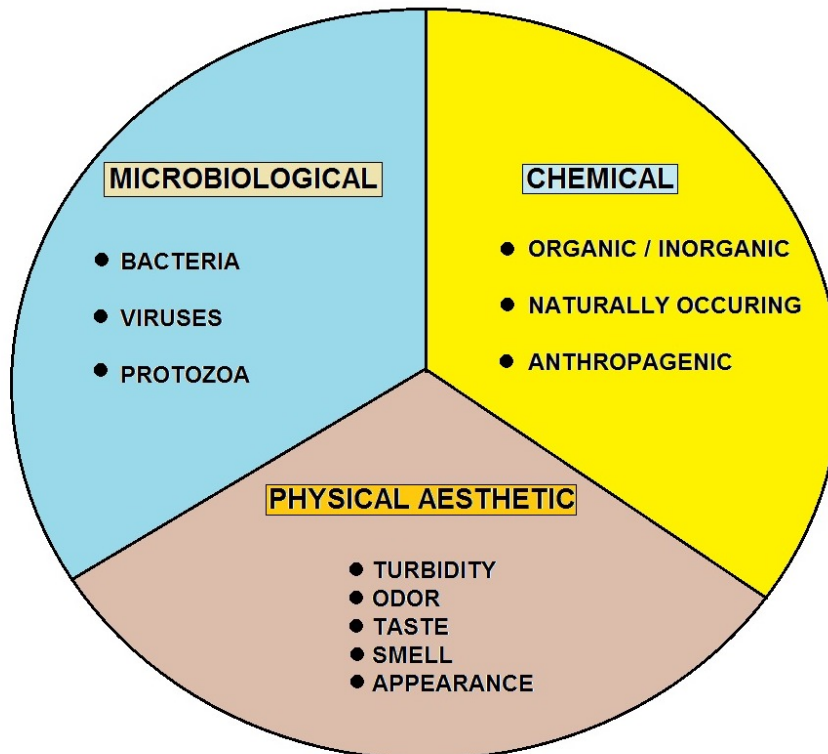
19. The respirators selected shall be adequate to protect the health of the employee and ensure compliance with all other OSHA statutory and regulatory requirements, under routine and reasonably foreseeable emergency situations.

20. The respirator selected shall be appropriate for the chemical state and physical form of the contaminant.

## Chapter 9- Laboratory Analysis

**Section Focus:** You will learn the basics of water laboratory analysis with an emphasis on Chlorine and microorganisms. At the end of this section, you will be able to describe disinfection related testing and microbial examination techniques. There is a post quiz at the end of this section to review your comprehension and a final examination in the Assignment for your contact hours.

**Scope/Background:** Laboratory analysis of water quality refers primarily to the chemical, physical, biological, and radiological characteristics of water. It is a measure of the condition of water relative to compliance or process control requirements. Laboratory analysis is frequently used by reference to a set of standards against which compliance, generally achieved through treatment of the water, can be assessed



### WATER QUALITY BROKEN DOWN INTO 3 BROAD CATEGORIES

#### Quality of Water – Primary Factors

If you classified water by its characteristics and could see how water changes as it passes on the surface and below the ground it would be in these four categories:

**Physical** characteristics such as taste, odor, temperature, and turbidity; this is how the consumer judges how well the provider is treating the water.

**Chemical** characteristics are the elements found that are considered alkali, metals, and non-metals such as fluoride, sulfides or acids. The consumer relates it to scaling of faucets or staining.

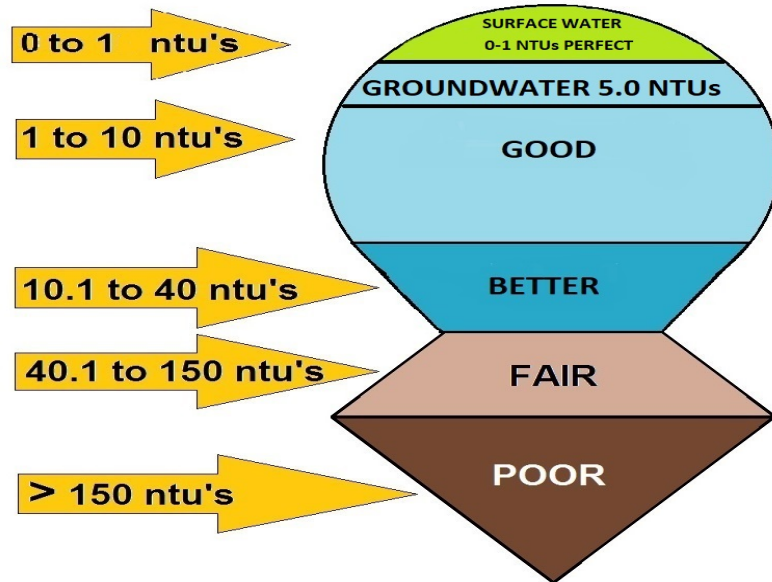
**Biological** characteristics are the presence of living or dead organisms. This will also interact with the chemical composition of the water. The consumer will become sick or complain about hydrogen sulfide odors--the rotten egg smell.

**Radiological** characteristics are the result of water coming in contact with radioactive materials. This could be associated with atomic energy. We will not cover this concern in this course.



## Turbidity Testing Sub-Section

Suspension of particles in water interfering with passage of light is called turbidity. Turbidity is caused by wide variety of suspended matter that range in size from colloidal to coarse dispersions, depending upon the degree of turbulence, and ranges from pure inorganic substances to those that are highly organic in nature. Turbid waters are undesirable from an aesthetic point of view in drinking water supplies. Turbidity is measured to evaluate the performance of water treatment plants.



**TURBIDITY PARAMETERS (NTU) FOR WATER QUALITY**

### Surface Water (SW) System Compliance

- ▶ 0.34 NTU in 95% of samples, never to exceed 1.0 NTU spike
- ▶ Sample turbidity at each individual filter effluent
- ▶ Sample the combined filter turbidity at the clear well
- ▶ (Groundwater turbidity = 5.0 NTU)

### Disinfection Key

- ▶ Contact time is required
  - ▶ 99% or 2 log inactivation of crypto
  - ▶ 99.9% or 3 log inactivation of giardia lamblia cysts
  - ▶ 99.99% or 4 log inactivation of enteric viruses
- ▶ CT = Concentration of disinfectant x contact time
- ▶ The chlorine residual leaving the plant must be = or > 0.2 mg/L and measurable throughout the system.

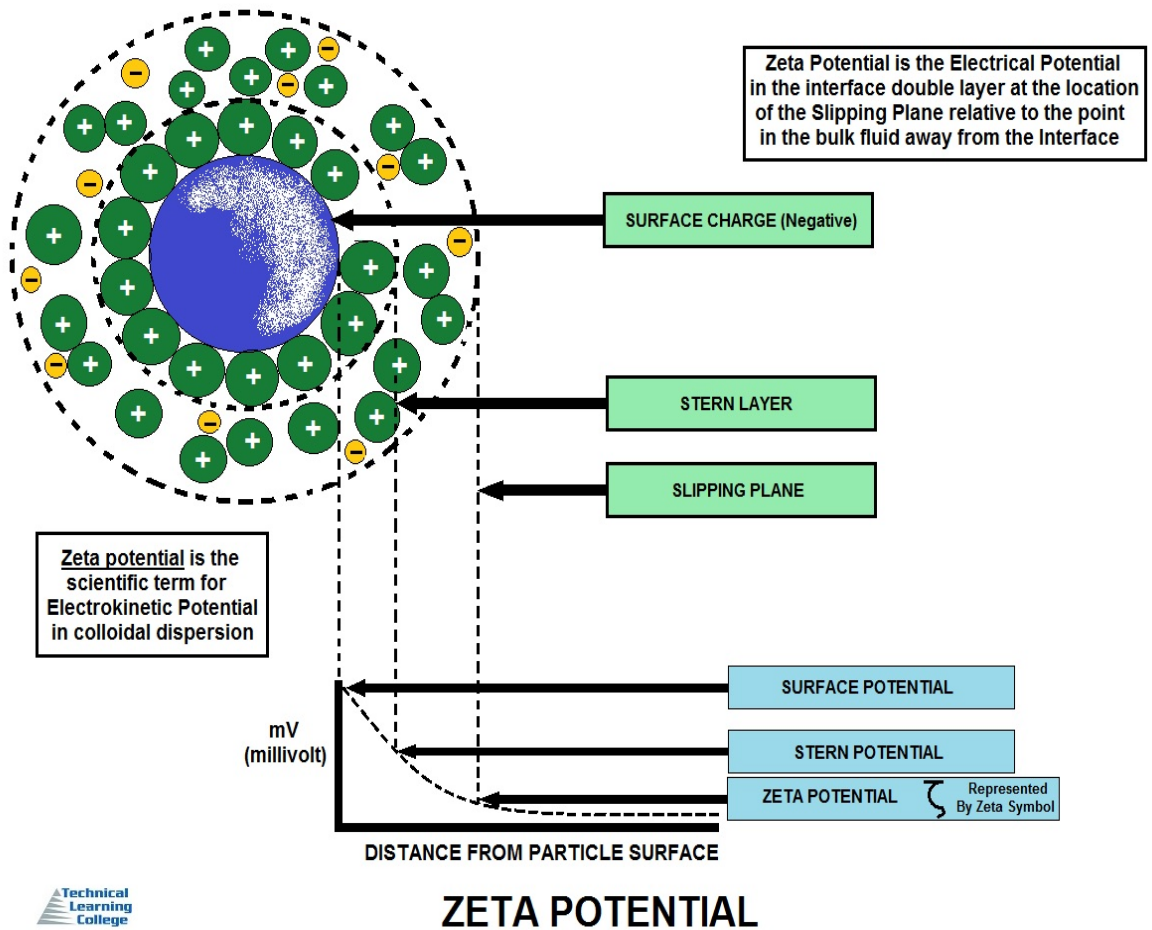
### Turbidity Key

- ▶ Turbidity can also be measured in ppm (parts per million) and its size is measured in microns. Turbidity can be particles in the water consisting of finely divided solids, larger than molecules, but not visible by the naked eye; ranging in size from .001 to .150mm (1 to 150 microns).
- ▶ 0.34 NTU in 95% of surface water samples, never to exceed 1.0 NTU spike

## Cloudy Water

Particles less than or about 1 to 10  $\mu\text{m}$  in diameter (primarily colloidal particles) will not settle out by gravitational forces, therefore making them very difficult to remove. These particles are the primary contributors to the turbidity of the raw water causing it to be “cloudy”. The most important factor(s) contributing to the stability of colloidal particles is not their mass, but their surface properties.

This idea can be better understood by relating the colloidal particles’ large surface area to their small volume (S/V) ratio resulting from their very small size. In order to remove these small particles, we must either filter the water or somehow incorporate gravitational forces such that these particles will *settle* out. In order to have gravity affect these particles, we must somehow make them larger, somehow have them come together (agglomerate); in other words, somehow make them “stick” together, thereby increasing their size and mass.



The two primary forces that control whether or not colloidal particles will agglomerate are:

### Repulsive Force

$$\zeta = \frac{4 \pi q d}{D}$$

An electrostatic force called the “Zeta Potential” -

#### Where:

$\zeta$  = Zeta Potential

$q$  = charge per unit area of the particle

$d$  = thickness of the layer surrounding the shear surface through which the charge is effective

$D$  = dielectric constant of the liquid

### Attractive force

#### *Force due to van der Waals forces*

Van der Waals forces are weak forces based on a polar characteristic induced by neighboring molecules. When two or more nonpolar molecules, such as He, Ar, H<sub>2</sub>, are in close proximity, the nucleus of each atom will weakly attract electrons in the counter atom resulting, at least momentarily, in an asymmetrical arrangement of the nucleus.

This force, van der Waals force, is inversely proportional to the sixth power of the distance (1/d<sup>6</sup>) between the particles. As can clearly be seen from this relationship, decay of this force occurs exponentially with distance.

### Ways to Measure Turbidity

- 1.) Jackson Candle Test
- 2.) Secchi Disk - a black and white disk divided like a pie in 4 quadrants about 6" in diameter. This device is lowered by a rope into the water until it cannot be seen and then the rope is measured.
- 3.) Turbidimeter - Light is passed through a sample. A sensitive photomultiplier tube at a 90° angle from the incident light beam detects the light scattered by the particles in the sample. The photomultiplier tube converts the light energy into an electrical signal, which is amplified and displayed on the instrument.

The reading is expressed in Nephelometric Turbidity Unit (NTU) or Formazin Turbidity Unit (FTU).

## How to Treat Turbidity

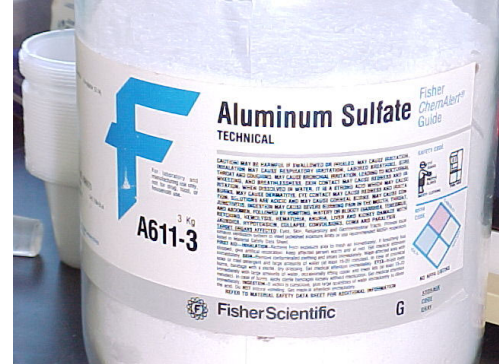
By supercharging the water supply momentarily with a positive charge, we can upset the charge effect of the particle enough to reduce the Zeta potential (repulsive force), thereby allowing van der Waals forces (attractive forces) to take over.

By introducing aluminum ( $\text{Al}_3^+$ ) into the water in the form of Alum ( $\text{Al}_2(\text{SO}_4)_3 \cdot n\text{H}_2\text{O}$ ) we can accomplish the supercharging of the water. This is the *coagulation* part of the coagulation/flocculation process; flocculation follows coagulation.

During the *flocculation* process the particles join together to form flocs; the larger the flocs, the faster they will settle within a clarifier.

Other chemical coagulants used are Ferric Chloride and Ferrous Sulfate.

Alum works best in the pH range of natural waters, 5.0 - 7.5. Ferric Chloride works best at lower pH values, down to pH 4.5.



Ferrous Sulfate works well through a range of pH values, 4.5 to 9.5.

During the coagulation process, charged hydroxy-metallic complexes are formed momentarily (i.e.  $\text{Al}(\text{OH})_2^+$ ,  $\text{Al}(\text{OH})_2^{1+}$  etc.). These complexes are charged highly positive, and therefore upset the stable negative charge of the target particles, thereby momentarily displacing the water layer surrounding the charged particle. This upset decreases the distance “d,” in turn decreasing the Zeta potential.

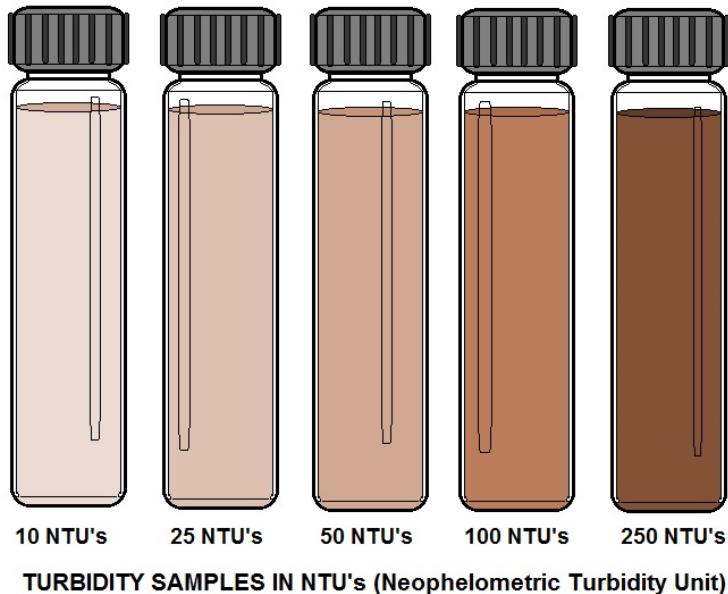
The particles are then able to get close enough together for van der Waals forces to take over and the particles begin to flocculate. The chemical reaction continues until the aluminum ions ( $\text{Al}^3_+$ ) reach their final form,  $\text{Al}(\text{OH})_3$  (s), and settle out (note – the flocculated particles settle out separately from the precipitated  $\text{Al}(\text{OH})_3$  (s)).

If too much alum is added, then the opposite effect occurs--the particles form sub complexes with the  $\text{Al}^3_+$  and gain a positive charge about them, and the particles re-stabilize.

The final key to obtaining good flocs is the added energy put into the system by way of rotating paddles in the flocculator tanks. By “*pushing*” (adding energy) the particles together we can aid in the flocculation process, forming larger flocs.

It is important to understand that too much energy, i.e. rotating the paddles too fast, would cause the particles to shear (breakup), thereby reducing the size of the particles and increasing the settling time in the clarifier.

## Turbidity Analysis



### Principle

Turbidity can be measured either by its effect on the transmission of light, which is termed as Turbidimetry, or by its effect on the scattering of light, which is termed as Nephelometry. A Turbidimeter can be used for samples with moderate turbidity and a Nephelometer for samples with low turbidity. The higher the intensity of scattered light, the higher the turbidity.

### Interference

Color is the main source of interference in the measurement of turbidity.

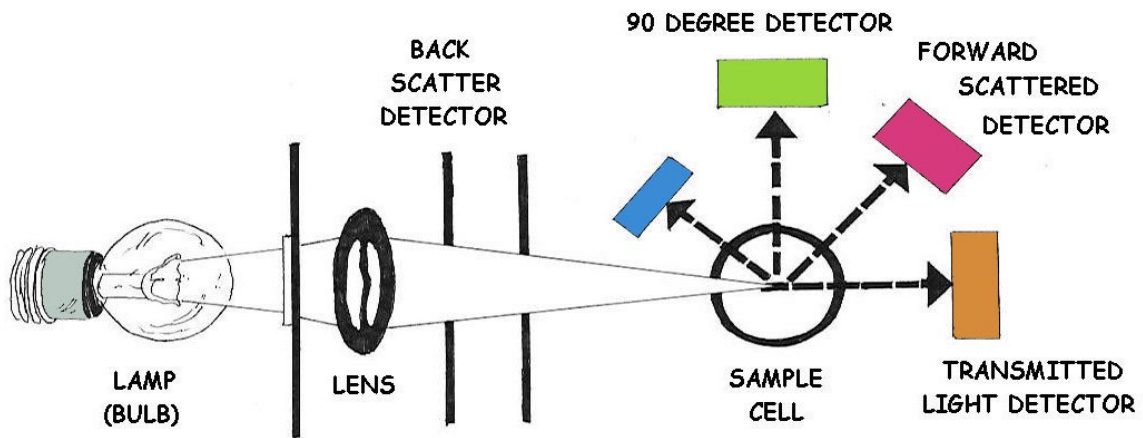
### Apparatus Necessary: Turbidimeter or Nephelometer.

### Reagents

1. Solution I: Dissolve 1.0 gm Hydrazine Sulfate and dilute to 100 mL.
2. Solution II: Dissolve 10.0 gm Hexamethylene tetramine and dilute to 100 mL.
3. Mix 5 mL of I with 5 mL of II. Allow to stand for 24 hrs. at  $25 \pm 3^\circ\text{C}$  and dilute to 100 mL. This solution (III) will have turbidity of 400 units (N.T.U.)
4. Standard turbidity suspension: Dilute 10 mL of solution III as prepared above to 100 mL to have solution of the turbidity of 40 units. (N.T.U.)

### Procedure

1. Prepare calibration curve in the range of 0-400 units by carrying out appropriate dilutions of solutions III and IV above taking readings on turbidimeter.
2. Take sample or a suitably diluted aliquot and determine its turbidity either by visual comparison with the diluted standards or by reading on turbidimeter.
3. Read turbidity from the standard curves and apply correction due to dilution, if necessary.
4. Report the readings in turbidity units.



### TURBIDIMETER OPERATION

## Test Methods Available for Residual Chlorine

Residual Chlorine can be measured using different methods. Iodometric and DPD colorimetric methods are the most common methods. Each method has its own set of reagents and concentration range.

### Iodometric Method

Residual Chlorine by Iodometric has a minimum detectable concentration of 40ppb if 0.01N sodium thiosulfate is used. Prepare the sample for titration by adding 5mL of acetic acid and 1g of potassium iodide to the sample. Titrate the sample with 0.01N sodium thiosulfate. Concentrations below 1 mg/L should be measured by using either 0.00564N sodium thiosulfate or 0.00564N phenylarsine oxide.

### DPD Colorimetric Method

Residual Chlorine can also be measured by the DPD Colorimetric method. This method has a minimum detectable concentration of 10ppb. In this method, the calibration is either made up from a chlorine solution or a potassium permanganate solution. The typical calibration range for this method is 0.05 to 4mg/L.

The reagents used in this method are a phosphate buffer and N,N-diethyl-p-phenylenediamine indicator solution. The samples are mixed with the reagents and then read on a spectrophotometer at a wavelength of 515nm.

Chlorine in water solutions is not stable. As a result, its concentration in samples decreases rapidly. Exposure to sunlight or other strong light, air, or agitation will further reduce the quantity of chlorine present in solutions.

Samples to be analyzed for chlorine cannot be stored or preserved.

Tests must be started immediately after sampling. Therefore, samples taken for the chlorine residual test must be grab samples only and excessive agitation must be avoided.

It is not necessary to use special sampling devices or containers for the chlorine residual test. However, the sampling container should be capable of collecting samples from a representative sampling point following chlorine contact, and should be made of resistant materials that will not rust or corrode, and which can be easily cleaned.

**NOTE:** A long handled aluminum dipper attached to a wooden handle, or an equivalent device, is acceptable for collecting samples. Do not use coffee cans, bleach bottles, etc.

### Preparation of Chemicals

At a minimum, hand and eye protection should be used when handling any of the chemicals mentioned in this section. Before working with any chemical, consult the appropriate Safety Data Sheet (formerly MSDS) (SDS) to determine if other safety precautions are necessary.





## Chlorine Residual Reagents

### Iodometric and Amperometric Methods:

#### I. Standard Phenylarsine Oxide (PAO) Solution, 0.00564 N

A. Prepare 0.3 N sodium hydroxide solution (NaOH) by dissolving 12.0 g NaOH in 800 mL distilled water and diluting to 1 liter.

B. Prepare a 6.0 N hydrochloric acid solution (HCl) by adding 108 mL concentrated HCl to 800 mL distilled water and diluting to 1 liter. (Caution: Concentrated HCl fumes can burn eyes and lungs—do not breathe fumes!)

C. Prepare an approximately 0.00564 N solution of PAO using the following procedures:

1. Dissolve approximately 0.8 g PAO powder in 150 mL of 0.3 N NaOH solution, and allow to settle.
2. Decant 110 mL into 800 mL distilled water and mix thoroughly.
3. Bring to pH 6 to 7 with 6N HCl and dilute to 950 mL with distilled water. (Caution: PAO is poisonous. Wash thoroughly after use and do not ingest.)

#### D. Standardization

1. Accurately measure 5 to 10 mL freshly standardized 0.0282 N iodine solution into a flask and add 1 mL potassium iodide solution (50g KI dissolved and diluted to 1 L with freshly boiled and cooled distilled water).
2. Titrate with PAO solution, using starch solution as an indicator, until blue disappears.
3. Normality (N) of PAO = (mL iodine solution x 0.0282)/mL PAO titrated.
4. Adjust PAO to 0.00564 N and recheck.

#### II. Standard Sodium Thiosulfate Solution, 0.00564 N

A. Prepare a 0.1 N sodium thiosulfate solution by dissolving 25 g  $\text{Na}_2\text{S}_2\text{O}_3 \cdot 5\text{H}_2\text{O}$  in 1000 mL of freshly boiled distilled water. Store reagent for at least 2 weeks to allow oxidation of any bisulfite ion present. Add a few mL of chloroform ( $\text{CHCl}_3$ ) to minimize bacterial decomposition.

## Standardize by one of the following methods:

### 1. Iodate Method

a. Dissolve 3.249 g anhydrous primary standard quality potassium bi-iodate ( $\text{KH}(\text{IO}_3)_2$ ) or 3.567 g potassium iodate ( $\text{KIO}_3$ ) dried at  $103 \pm 2^\circ\text{C}$  for 1 hour in distilled water and dilute to 1000 mL to yield a 0.1000 N iodate solution. Store in a glass stoppered bottle.

b. Add, with constant stirring, 1 mL concentrated sulfuric acid ( $\text{H}_2\text{SO}_4$ ), 10 mL 0.1000 N iodate solution, and 1 g potassium iodide (KI) to 80 mL distilled water. Titrate immediately with 0.1 N sodium thiosulfate ( $\text{Na}_2\text{S}_2\text{O}_3$ ) until the yellow color of the liberated iodine is almost discharged. Add 1 mL starch indicator solution and continue titration until the blue color disappears.

c. The normality (N) of the sodium thiosulfate is calculated as follows: N of  $\text{Na}_2\text{S}_2\text{O}_3 = 1/\text{mL Na}_2\text{S}_2\text{O}_3$  for titration

### 2. Dichromate Method

A. Dissolve 4.904 g anhydrous primary standard grade potassium dichromate ( $\text{K}_2\text{Cr}_2\text{O}_7$ ) in distilled water and dilute to 1000 mL to yield a 0.1000 N dichromate solution. Store in a glass stoppered bottle.

B. For maximum stability of the standard 0.00564 N sodium thiosulfate solution, prepare by diluting an aged 0.1N  $\text{Na}_2\text{S}_2\text{O}_3$  standard solution with freshly boiled distilled water. Add 10 mg Mercuric iodide and 4 g of sodium borate per liter of solution. Standardize daily using 0.00564 N potassium dichromate or iodate solution.

### III. Standard Iodine Solution ( $\text{I}_2$ ), 0.1 N

A. Dissolve 40 g potassium iodide (KI) in 25 mL chlorine-demand-free water.

B. Add 13 g resublimed iodine ( $\text{I}_2$ ) and stir until dissolved.

C. Transfer to a 1-liter volumetric flask and dilute to the mark.

### D. Standardization

1. Volumetrically measure 40 to 50 mL 0.1 N arsenite solution into a flask.

2. Titrate with 0.1 N iodine solution using starch solution as an indicator.

3. Just before end-point is reached, add a few drops of hydrochloric acid solution to liberate sufficient carbon dioxide ( $\text{CO}_2$ ) to saturate the solution.

4. Titrate until blue color first appears and remains.

5. Normality (N) of iodine = (mL of arsenite solution used x 0.1)/mL of iodine titrated

**IV. Standard Iodine Titrant (I<sub>2</sub>), 0.0282 N**

- A. Dissolve 25 g KI in a bottle of distilled water in a 1L volumetric flask.
- B. Add the correct amount of the exactly standardized 0.1 N iodine solution to yield a 0.0282 N solution.
- C. Dilute to one liter with chlorine-demand-free water.
- D. Store iodine solutions in amber bottles or in the dark, and protect from exposure to direct sunlight. Do not use rubber stoppers; keep iodine from all contact with rubber.
- E. Check titrant normality daily against 0.00564 N PAO or sodium thiosulfate solution. A procedure for calculating a correction factor for this titrant is given in Appendix C.

**V. Standard Potassium Iodate Titrant (KIO<sub>3</sub>), 0.00564 N**

- A. Dissolve 201.2 mg primary standard grade potassium iodate (KIO<sub>3</sub>), dried for 1 hour at 103°C, or 183.3 mg primary standard grade anhydrous potassium bi-iodate (KH(IO<sub>3</sub>)<sub>2</sub>) in distilled water.
- B. Dilute to 1 liter volumetrically.
- C. Store in glass bottles in the dark and protect from exposure to direct sunlight.

**VI. Potassium Iodide Solution (KI), 5% W/V**

- A. Dissolve 50 g KI in freshly boiled and cooled distilled water and dilute to 1 liter.
- B. Store in a brown glass-stoppered bottle in the dark, preferably at 4°C.
- C. Discard when solution becomes yellow.

**VII. Acetate Buffer Solution, pH 4.0**

- A. Dissolve 146 g anhydrous sodium acetate (NaC<sub>2</sub>H<sub>3</sub>O<sub>2</sub> · 3H<sub>2</sub>O) in 400 mL distilled water.
- B. CAREFULLY add 458 mL concentrated (glacial) acetic acid.
- C. Dilute to 1 liter with chlorine-demand-free water.

### VIII. Standard Arsenite Solution ( $\text{As}_2\text{O}_3$ ), 0.1N

- A. Accurately weigh a dried, cooled stoppered weighing bottle.

NOTE: Use forceps or tongs—do not handle weighing bottle with fingers.

- B. In weighing bottle, weigh out approximately 4.95 g arsenic trioxide ( $\text{As}_2\text{O}_3$ ).
- C. Transfer without loss to a 1-liter volumetric flask

NOTE: Do not attempt to brush out remaining arsenic trioxide).

- D. Reweigh bottle and record weight of arsenic trioxide transferred.
- E. Add enough distilled water to moisten the arsenic trioxide.
- F. Add 15 g sodium hydroxide (NaOH) and 100 mL distilled water.
- G. Swirl flask gently until  $\text{As}_2\text{O}_3$  is dissolved.
- H. Dilute to 250 mL and saturate the solution with carbon dioxide ( $\text{CO}_2$ ) by bubbling  $\text{CO}_2$  gas through the solution for a few minutes.

NOTE: This converts the sodium hydroxide (NaOH) to sodium bicarbonate ( $\text{NaHCO}_3$ ).

- I. Dilute to the 1-liter mark, stopper, and mix thoroughly.
- J. This solution has an almost indefinite shelf life.

CAUTION: This solution is highly poisonous and is a suspected cancer causing agent: handle carefully!

### IX. Starch Indicator

- A. Weigh out 5 g soluble or potato starch.
- B. Add enough distilled water to make a thin paste.
- C. Pour into 1 liter boiling distilled water, stir and let settle overnight.
- D. Transfer clear supernatant into a storage container and preserve by adding 1.25 g salicylic acid, 4 g zinc chloride, or a combination of 4 g sodium propionate and 2 g sodium azide per liter of starch solution.
- E. Some commercial starch substitutes or powder indicators are acceptable.

**X. Phosphoric Acid solution (H<sub>3</sub>PO<sub>4</sub>), 1 + 9**

- A. Carefully add 100 mL of phosphoric acid (H<sub>3</sub>PO<sub>4</sub>), 85%, to 900 mL of freshly boiled distilled water.
- B. Caution should be used when handling this solution, as it can be corrosive.

**XI. Phosphoric Acid—Sulfamic Acid Solution**

- A. Dissolve 20 g sulfamic acid (NH<sub>2</sub>SO<sub>3</sub>H) in 1 liter of 1 + 9 phosphoric acid (H<sub>3</sub>PO<sub>4</sub>).

**DPD Titrimetric Method**

**I. Phosphate Buffer Solution**

- A. Dissolve 24 g anhydrous disodium hydrogen phosphate (Na<sub>2</sub>HPO<sub>4</sub>) in 400 to 500 mL distilled water.
- B. Add 46 g anhydrous potassium dihydrogen phosphate (KH<sub>2</sub>PO<sub>4</sub>).
- C. Dissolve 800 mg disodium ethylenediaminetetraacetate dihydrate (EDTA) in a separate container.

**NOTE: This chemical is also known as (ethylenediamine) tetraacetic acid sodium salt.**

- D. Combine the 2 solutions and dilute to 1 liter.
- E. Add 20 mg mercuric chloride to prevent mold growth.
- F. Caution: Mercuric chloride is toxic. Take care to avoid ingestion.

**II. DPD Indicator Solution**

- A. Add 8 mL of a 1 + 3 sulfuric acid solution (H<sub>2</sub>SO<sub>4</sub>) into 500 mL distilled water. Prepare by mixing one part concentrated H<sub>2</sub>SO<sub>4</sub> to 3 parts distilled water. (For example, 5 mL H<sub>2</sub>SO<sub>4</sub> to 15 mL distilled water.)
- B. Add 200 mg EDTA (disodium ethylenediaminetetraacetate dihydrate).
- C. Add 1 g DPD Oxalate (N, N-Diethyl-p-phenylenediamine oxalate).
- D. Dilute to 1 liter and store in a brown glass-stoppered bottle and discard when discolored.

**CAUTION: The DPD oxalate is poisonous, handle carefully!**

### III. Standard Ferrous Ammonium Sulfate (FAS) Titrant, 0.00282 N

- A. Add 1 mL of 1 + 3 sulfuric acid solution (H<sub>2</sub>SO<sub>4</sub>) to 500 mL of freshly boiled and cooled distilled water. Prepare by adding one part concentrated H<sub>2</sub>SO<sub>4</sub> to 3 parts distilled water.
- B. Dissolve 1.106 g ferrous ammonium sulfate (Fe(NH<sub>4</sub>)<sub>2</sub>(SO<sub>4</sub>)<sub>2</sub> · 6H<sub>2</sub>O)
- C. Dilute to 1 liter.
- D. This standard can be used for 1 month before replacement.
- E. Standardize weekly using the following procedure:
  1. Measure 100 mL of FAS standard solution into an Erlenmeyer flask.
  2. Add 10 mL of 1 + 5 sulfuric acid. Prepare by adding one part concentrated H<sub>2</sub>SO<sub>4</sub> to 5 parts distilled water.
  3. Add 5 mL concentrated phosphoric acid.
  4. Add 2 mL 0.1% barium diphenylamine sulfonate indicator. Prepare by dissolving 0.1 g (C<sub>6</sub>H<sub>5</sub>NHC<sub>6</sub>H<sub>4</sub>-4-SO<sub>3</sub>) Ba in 100 mL distilled water.
  5. Titrate with 0.100N potassium dichromate (see Iodometric and amperometric section for preparation directions) to a violet end-point that persists for 30 seconds.

### DPD Colorimetric Method

#### I. Phosphate Buffer Solution

(see DPD Titrimetric Method chemicals)

#### II. DPD Indicator Solution

(see DPD Titrimetric Method chemicals)

### III. Potassium Permanganate Stock Solution

- A. Dissolve 891 mg potassium permanganate (KMnO<sub>4</sub>) in distilled water and dilute to 1000 mL.

### IV. Potassium Permanganate Standard Solution

- A. Dilute 10 mL of stock solution to 100 mL in a volumetric flask.
- B. 1 mL of the standard solution diluted to 100 mL with distilled water will be equivalent to 1.0 mg/L chlorine residual in a DPD reaction.

- C. Prepare standard solutions by diluting appropriate volumes to 100 mL with distilled water.

If a direct concentration readout colorimeter is used, the DPD and buffer reagents should be prepared or ordered in accordance with the instrument manufacturer's instructions. If the Hach DR100 colorimeter is used, the prepared DPD powder pillows used with the Hach direct reading colorimeters may be purchased from the Hach Company at the following address:

Hach Company  
P.O. Box 389  
Loveland, Colorado 80539

### **Orion Model 97-70 Electrode Method**

With the exception of the 1 ppm potassium iodate standard and the chlorine water (100 ppm), all of the reagents required for this method can be purchased from Orion Research at the following address:

Orion Research Incorporated  
840 Memorial Drive  
Cambridge, Massachusetts 02139

- I. Prepare a 1 mg/L iodate standard by volumetrically diluting 1 mL of the 100 ppm iodate standard to 100 mL with distilled water.
- II. Prepare the chlorine water (approximately 100 ppm) by diluting 1 mL hypochlorite solution (household chlorine bleach) to 500 mL with distilled water.

### **Hach Model CN-66 Test Kit Method**

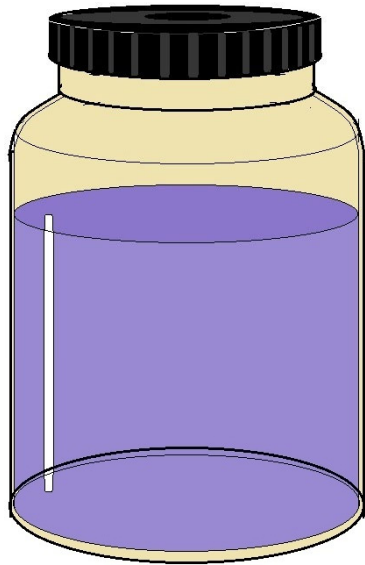
The DPD indicator powder pillows used in the Hach Model CN-66 Test Kit may be purchased from the Hach Company at the following address:

Hach Company  
P.O. Box 389  
Loveland, Colorado 80539

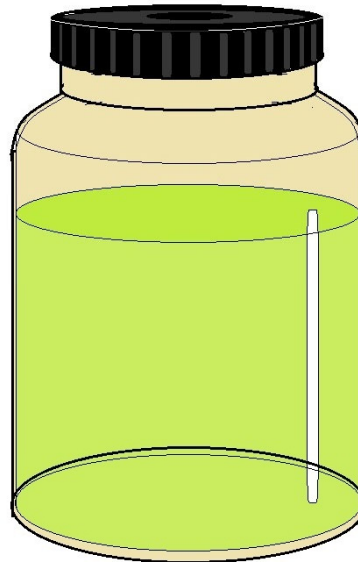




## Bacteriological Sample Processing Procedures



**COLIFORM POSITIVE  
SAMPLE**



**COLIFORM NEGATIVE  
SAMPLE**

### **COLIFORM BACTERIA COLOR TESTING DIAGRAM**

Samples need to be kept on ice and shipped to a central laboratory for analysis of coliphage, *C. perfringens*, *Cryptosporidium*, *Giardia*, and enteric viruses by the current analytical methods. The single-agar layer (SAL), direct plating method with induction of  $\beta$ -galactosidase (Ijzerman and Hagedorn, 1992) is recommended for detection of somatic and F-specific coliphage in streamwater samples. In this method, 100-mL sample volumes are mixed with an agar medium, *E. coli* host culture, chemicals that induce the  $\beta$ -galactosidase enzyme, and appropriate antibiotics. The mixtures are poured into four 150-x 15-mm plates and incubated at 35°C.

Upon infection by coliphage in the water sample, the *E. coli* host cells are lysed and stable indolyl product that is dark blue is visible within each plaque. Viral plaques are easily identified and enumerated by the distinct blue circle. Because of contamination by naturally occurring bacteria in streamwater samples, antibiotic-resistant host-culture strains, *E. coli* CN-13 (resistant to nalidixic acid) and *E. coli* F-amp (resistant to streptomycin and ampicillin) are used as hosts for somatic and F-specific coliphage, respectively. Large sample volumes, such as 1-L volumes or greater, are recommended for detection of coliphage in ground water. Because the SAL method is impractical for sample volumes above 100 mL, an alternative method should be used for ground-water sample analysis.

One example, currently being tested by USEPA, is a two-step enrichment presence-absence method (U.S. Environmental Protection Agency, 1999e). Samples for enumeration of *C. perfringens* are analyzed by use of the mCP agar method (U.S. Environmental Protection Agency, 1996c). Standard MF techniques are used, and the plates are incubated anaerobically for 24 hours at 44.5°C. After incubation, the plates are exposed to ammonium hydroxide, and all straw-colored colonies that turn dark pink to magenta are counted as *C. perfringens*. In the laboratory, *C. perfringens* analyses are done on 100-, 30-, and 10-mL volumes of streamwater. In the case of a high-flow or high-turbidity streamwater sample, lower sample volumes may be plated.

Method 1623 (U.S. Environmental Protection Agency, 1999c) is recommended for detection of *Cryptosporidium* oocysts and *Giardia* cysts in water. The oocysts are concentrated on a capsule filter from a 10-L water sample, eluted from the capsule filter with buffer, and concentrated by centrifugation. Immunomagnetic separation (IMS) is used to separate the oocysts from other particulates in the sample. In IMS, the oocysts are magnetized by attachment of magnetic beads conjugated to an antibody and then are separated from sediment and debris by means of a magnet.

Fluorescently labeled antibodies and vital dye are used to make the final microscopic identification of oocysts and cysts. The reverse-transcriptase, polymerase chain reaction (RT-PCR) and cell-culture methods are recommended for detection of enteric viruses in water samples (G. Shay Fout, U.S. Environmental Protection Agency, written commun., 1997; U.S. Environmental Protection Agency, 1996c). To prepare samples for RT-PCR and cell culture, attached viruses are eluted from a 1MDS filter with beef extract (pH 9.5), concentrated using celite (pH 4.0), and eluted with sodium phosphate (pH 9.5).

For RT-PCR analysis, viruses are isolated from the eluate by ultracentrifugation through a sucrose gradient, and trace contaminants are removed by extraction with a solvent mixture. During these steps, the 10-L streamwater sample (or 2,000-L ground-water sample) is concentrated down to 40 µL. An aliquot of the concentrate is used for RT-PCR, wherein any target viral RNA is converted to DNA and amplified by use of an enzymatic process. The RT-PCR products are analyzed by agarose gel electrophoresis and confirmed by hybridization. The enteric viruses detected by use of this method include enterovirus, hepatitis-A, rotavirus, reovirus, and calicivirus.

For cell-culture analysis, the sample eluate is added to a monolayer of a continuous cell line derived from African green monkey kidney cells (U.S. Environmental Protection Agency, 1996c). Each cell culture is examined microscopically for the appearance of cytopathic effects (CPE) for a total of 14 days; if CPE is not observed in 14 days, a second passage is done. Results are reported as most probable number of infectious units per volume of water.

### **QA/QC Activities and Measures**

QA/QC activities and measures to take to reduce contamination.

- Use a sterilization indicator, such as autoclave tape, in preparing sample bottles and other equipment for collection of microbiological samples to determine whether adequate temperatures and pressures have been attained during autoclaving.
- Prepare a separate set of sterile equipment for microbiological sampling at each site.
- Before processing samples in the field vehicle, wipe down the area with a disinfectant (such as isopropyl alcohol) to ensure a sterile working surface.

- Monitor the incubators daily to ensure temperatures are appropriate for the methods used.

For bacteria samples, membrane-filtration (MF) equipment and MF procedure blanks are used to estimate analytical bias.

**Field personnel should do the following:**

- Prepare an MF equipment blank, a 50- to 100-mL aliquot of sterile buffered water plated before the sample—for every sample by field personnel for total coliform, *E. coli*, and enterococci analyses to determine the sterility of equipment and supplies.
- Prepare a MF procedure blank, a 50- to 100-mL aliquot of sterile buffered water plated after the sample—for every fourth sample to measure the effectiveness of the analyst's rinsing technique or presence of incidental contamination of the buffered water.

If contamination from a MF equipment or procedure blank is found, results are suspect and are qualified or not reported. Proper and consistent procedures for counting and identifying target colonies will be followed, as described in Myers and Sylvester (1997).

- After counting, turn the plate 180° and ensure the second count is within 5 percent of the first count. Have a second analyst check calculations of bacterial concentrations in water for errors.

For coliphage, *Cryptosporidium*, *Giardia*, and enteric virus samples, equipment and field blanks are used to determine sampling and analytical bias. Equipment blanks for these analyses are different from the MF equipment blanks for bacterial analysis. An equipment blank is a blank solution (sterile buffered water) subjected to the same aspects of sample collection, processing, storage, transportation, and laboratory handling as an environmental sample, but it is processed in an office or laboratory. Field blanks are the same as equipment blanks except that they are generated under actual field conditions.

- For enteric virus analysis, collect one equipment blank after collection of the first sample to ensure that equipment cleaning and sterilization techniques are adequate.
- For coliphage, *Cryptosporidium*, *Giardia*, and enteric virus analyses, collect field blanks periodically.

At a minimum, the number of field blanks should equal 5 percent of the total number of samples collected. Five percent of samples collected for bacterial and viral indicators (total coliforms, *E. coli*, enterococci, *C. perfringens*, and coliphage) should be nested replicate samples to estimate sampling and analytical variability. For streamwater samples, concurrent replicates to estimate sampling variability are collected by alternating subsamples in each vertical between two collection bottles. For ground-water samples, sequential replicates are collected one after another into separate sterile bottles. Concurrent and sequential replicates are then analyzed in duplicate (split replicates) to estimate analytical variability.

- Because of the expense associated with collection and analysis of samples for pathogens (*Cryptosporidium* and enteric viruses), collect only one replicate sample per year at a site wherein detection of pathogens was found in an earlier sample.

To assess analytical bias of the sampling and analytical method, 2 to 5 percent of the samples collected for enteric virus should be field matrix spikes.

- Run all but 10 L of ground water through the 1 MDS filter and collect the remaining 10 L in a carboy. In the laboratory, the poliovirus vaccine will be added to the 10 L and then passed through the same 1MDS filter. Analysis will be done by use of the cell-culture and RT-PCR methods.
- All cell-culture positive samples are serotyped to identify or discount laboratory contamination. Because of the variability in the performance of Method 1623 for recovery of *Cryptosporidium* and *Giardia*, each sample will be collected in duplicate—one will be a regular sample and the other a matrix spike. The laboratory will add a known quantity of cysts and oocysts to the matrix spike to determine recovery efficiency, as described in USEPA (1999c).

### **Quality Assurance and Quality Control in the Laboratory**

The following criteria may be used to evaluate each production analytical laboratory: (1) appropriate, approved, and published methods, (2) documented standard operating procedures, (3) approved quality-assurance plan, (4) types and amount of quality-control data fully documented and technical defensible, (5) participation in the standard reference sample project (6) scientific capability of personnel, and (7) appropriate laboratory equipment.

The microbiology laboratories must follow good laboratory practices—cleanliness, safety practices, procedures for media preparation, specifications for reagent water quality—as set forth by American Public Health Association (1998) and Britton and Greeson (1989). Some specific guidelines are listed in the following paragraphs.

Reference cultures are used by the central laboratory to evaluate the performance of the test procedures, including media and reagents. Pure cultures of *E. coli*, *Enterobacter aerogenes*, and *Streptococcus faecalis* (American Type Culture Collection, Rockville, Md.) are used to ensure that MF culture media and buffered water are performing adequately.

A pure culture of *C. perfringens*, isolated from a sewage sample and verified by standard procedures, is used to evaluate the test procedure and each lot of media and reagents.

Because contamination of samples from coliphage during the analytical procedure is highly probable (Francy and others, 2000), a negative control of host and sterile buffered water is run concurrently with each batch of samples.

In addition, to ensure that the method is being executed properly, a positive-control sewage sample is run with each batch of samples. A laminar flow safety hood is recommended for processing the samples for coliphage analysis.

Alternatively, a separate coliphage room may be established to discourage laboratory contamination during the analytical process. An ultraviolet light is installed and operated for 8 hours every night in the safety hood or coliphage room to reduce contamination.

The laboratory should follow the QA/QC guidelines in Method 1623 (U.S. Environmental Protection Agency, 1999c) for *Cryptosporidium* and *Giardia* and in the cell-culture and RT-PCR analysis for enteric viruses (G. Shay Fout, U.S. Environmental Protection Agency, written commun., 1997; U.S. Environmental Protection Agency, 1996c).

## Protozoan Pathogens

The principal protozoan pathogens that affect the public health acceptability of waters in the United States are *Giardia lamblia* (*Giardia*) and *Cryptosporidium parvum* (*Cryptosporidium*). These organisms are widely distributed in the aquatic environment and have been implicated in several recent outbreaks of waterborne disease, including a well-publicized outbreak of cryptosporidiosis in Milwaukee, Wisconsin (Rose and others, 1997). Both *Giardia* and *Cryptosporidium* produce environmentally resistant forms (called cysts and oocysts), which allow for the extended survival of the parasites in water and treated water.

Because cysts and oocysts are more resistant to disinfection and survive longer in the environment than bacterial indicators, fecal-indicator bacteria are not adequate indicators for *Giardia* and *Cryptosporidium* in source waters. The presence of protozoan pathogens in water, therefore, must be verified by identification of the pathogens themselves.

The USEPA-required method for detection of *Giardia* and *Cryptosporidium* in source and drinking water under the ICR involves nominal porosity filtration and indirect fluorescent antibody procedures (U.S. Environmental Protection Agency, 1996c).

The ICR method has been criticized for being difficult to implement, being characterized by poor recovery of target organisms, and yielding highly variable results (U.S. Environmental Protection Agency, 1996b). As a result, the USEPA supported the development of Method 1622 for *Cryptosporidium* (U.S. Environmental Protection Agency, 1998b), and Method 1623 for *Giardia* and *Cryptosporidium* (U.S. Environmental Protection Agency, 1999c). Method 1622 was validated through an interlaboratory study and revised as a final, valid method in January 1999.

### Understanding Routine Coliform Sampling

#### Streamwater sample collection

When designing a sampling plan, consider that the spatial and temporal distribution of microorganisms in surface water can be as variable as the distribution of suspended sediment because microorganisms are commonly associated with solid particles.

The standard samplers can be used to collect streamwater samples for bacterial and viral indicators, *Cryptosporidium*, and *Giardia* providing that the equipment coming in contact with the water is properly cleaned and sterilized. For streamwater samples, these include the US-D77TM, US-D95, US-DH81, and weighted- and open-bottle samplers with autoclavable Teflon, glass, or polypropylene components.

- Prepare a separate set of sterile equipment (bottles nozzles, and caps) for sampling at each site.
- Follow sampling techniques given in Shelton (1994) to ensure that a sample is representative of the flow in the cross section. Use equal-width increment (EWI) or equal-discharge-increment (EDI) methods described in Edwards and Glysson (1988), unless site characteristics dictate otherwise.
- Because churn and cone splitters cannot be autoclaved, use a sterile 3-L bottle to composite subsamples for bacterial and viral indicators when using EDI and EWI methods. If possible, composite by collecting subsamples at vertical locations in the cross section without overfilling the bottle.

- Alternatively, if the stream depth and (or) velocity is not sufficient to use depth-width integrating techniques, collect a sample by a hand-dip method (Myers and Sylvester, 1997).
- Collect approximately 1 L of streamwater for bacterial and viral indicators. Process the sample for *E. coli* and enterococci; send the remainder (at least 500 mL) on ice to the laboratory for *C. perfringens* and coliphage analysis.

## Method 1623

For *Cryptosporidium* and *Giardia* analysis by Method 1623 (U.S. Environmental Protection Agency, 1999c), collect 20 L of streamwater for each protozoan pathogen using standard sampling techniques described in Myers and Sylvester (1997). Special sterilization procedures are needed for equipment used in the collection of samples for *Cryptosporidium* and *Giardia*. Autoclaving is not effective in neutralizing the epitopes on the surfaces of the oocysts and cysts that will react with the antibodies used for detection.

- Wash and scrub the equipment with soap and warm tap water to remove larger particulates and rinse with deionized water. Submerge the equipment in a vessel containing 12 percent hypochlorite solution for 30 minutes. Wash the equipment free of residual sodium hypochlorite solution with three rinses of filter-sterilized water; do not dechlorinate the equipment using sodium thiosulfate. This procedure is best done in the office with dedicated sampling equipment for each site; however, it may be done in the field as long as the hypochlorite solution is stored and disposed of properly.
- Composite the sample in a 10-L cubitainer that is pre-sterilized by the manufacturer. The cubitainer is sent in a cardboard box to laboratory for *Cryptosporidium* analysis. The sample does not have to be kept on ice during transport. At this time, two methods are recommended for analysis of water samples for enteric viruses: (1) the reverse-transcriptase, polymerase chain reaction (RTPCR) method (G. Shay Fout, U.S. Environmental Protection Agency, written commun., 1997) and (2) the cell-culture method (U.S. Environmental Protection Agency, 1996c). Sampling and equipment cleaning procedures are more thoroughly described elsewhere (G. Shay Fout, U.S. Environmental Protection Agency, 1997; U.S. Environmental Protection Agency, 1996c). Briefly, 100 L of streamwater is pumped by means of a specially designed sampling apparatus and passed through a Virosorb1 1MDS filter (Cuno, Meriden, Conn.). The sampling equipment is obtained from the analyzing laboratory; for example, the USGS Ohio District Laboratory has modified the sampling apparatus (G. Shay Fout, U.S. Environmental Protection Agency, 1997) into a self-contained box with easy-to-use control valves. The 1MDS filters, which remove viruses present in the water by charge interactions, are kept on ice and sent to a central laboratory for virus elution, concentration, and detection.

### Groundwater Sample Collection

Collecting ground-water samples by use of sterile techniques requires knowledge of the type of well, its use, its construction, and its condition.

- Swab the electronic tape used for water-level measurements with isopropyl or ethyl alcohol.
- In sampling subunit survey wells, once purging criteria have been met as described in Koterba and others (1995), collect the sample directly from the tap into a sterile container.
- Remove screens, filters, other devices from the tap before collecting the sample, and do not sample from leaking taps. Because we are interested in the microbial population in the ground water and not in the distribution system, it is best to sample directly from the wellhead using a pump with sterile tubing, if possible. Because this is operationally prohibitive for private domestic wells, a tap that yields water directly from the well and before entering the holding tank is preferred. Water collected after treatment is unsuitable for microbiological analysis.
- Document the stage of the distribution system from which water was collected and details about the distribution system, including the type of tank and condition of the tank and pipes.

In addition, if the well can easily be opened for inspection, document the condition of the well, including the sanitary seal (if any) and the amount of debris in the well. Any information on the location of the well, including proximity to septic systems or feedlots, should also be documented in the field at the time of sampling.

**For wells without in-place pumps, samples should be obtained by use of the following methods**

**(in descending order from most to least desirable):**

(1) a peristaltic or vacuum pump with autoclavable silicon tubing, (2) a sterile bailer, (3) a chlorine-disinfected pump and tubing, or (4) a detergent-cleaned pump and tubing. Pre-sampling activities, such as purging, must be carried out in such a way as to avoid contaminating the well. All equipment must be properly cleaned and sterilized between sites, using a Liquinox wash and a thorough tap water or deionized-water rinse. If using this last method, collect additional field blanks to evaluate the effectiveness of the cleaning procedure. Refer to Myers and Sylvester (1997) for a detailed discussion of ground-water sampling for microbiological analysis.

**Because ground water is less prone to microbiological contamination than surface water, larger volumes of ground water are needed than of surface water.**

- For regular sampling, collect 3 L of ground water for bacterial and viral indicators.
- Process the sample for total coliforms, *E. coli*, and enterococci using 200-mL sample volumes for each analysis; send the remainder (at least 2.5 L) to the laboratory for coliphage analysis. In the laboratory, coliphage analysis is done using 1 L for somatic and 1 L for F-specific coliphage.
- For enteric virus analysis by RT-PCR and cell culture, use the same sampler for ground-water samples as for streamwater samples; pump 2,000 L of ground water through the sampling apparatus and 1MDS filter.

**Sample Preservation and Storage**

Holding times for samples before processing are 6 hours for total coliforms, *E. coli*, and enterococci and 24 hours for *C. perfringens*, coliphage, *Cryptosporidium*, *Giardia*, and the 1MDS filters for enteric viruses by RTPCR and cell culture.

- After collection, immediately store the sample on ice.
- Be sure to keep the sample out of direct sunlight, because ultraviolet rays kill microorganisms.
- Add sodium thiosulfate to sample bottles for bacterial and viral indicators if the water collected contains residual chlorine. (Samples may have residual chlorine if the sampling site is downstream from a wastewater-treatment plant that chlorinates its effluents). Add ethylene diaminetetracetic acid to sample bottles when water is suspected to contain trace elements such as copper, nickel, and zinc at concentrations greater than 1 mg/L (Britton and Greeson, 1989, p. 5-6; U.S. Environmental Protection Agency, 1978, p. 6; American Public Health Association and others, 1998, p. 9-19). (Sodium thiosulfate or ethylene diaminetetracetic acid are not added to containers for *Cryptosporidium* and *Giardia*).

**Analytical Methods**

**Field Analysis**

Analysis of water samples for total coliforms, *E. coli*, and enterococci, are done by use of membrane filtration (MF) or most-probable number (MPN) methods. Because membrane filtration is easier to use and provides a more precise quantification of bacteria than MPN, MF is recommended for most analyses. Refer to Myers and Sylvester (1997) for complete MF procedures.



**Different MF methods are used for quantification of bacteria in ground-water and streamwater samples.**

- For examining streamwater samples for *E. coli*, use the USEPA-recommended mTEC agar method (Environmental Protection Agency, 1986b).
- For examining ground-water samples for total coliforms and *E. coli*, use the MI method (Brenner and others, 1993).
- For enterococci, use the mEI method (U.S. Environmental Protection Agency, 1997).
- For streamwater, plate sufficient sample volumes in order to obtain at least one plate in the ideal count range. For ground water, a 200-mL sample volume is usually sufficient.

Testing of new microbiological monitoring methods and comparing the recoveries of new methods to the USEPA-approved method can be done by use of the NAWQA network.

For groundwater samples, for example, one may include a commercially available MPN kit, Colilert (Idexx Laboratories, Westbrook, Maine), for simultaneous detection of total coliforms and *Escherichia coli*. For streamwater sampling, one may include a single-step modified Mtec medium with 5-bromo-6-chloro-3-indolyl' $\beta$ -d-glucuronide (Bennett Smith, USEPA, Cincinnati, Ohio, oral commun., 1997); this method was developed to replace the mTEC method. Other new methods can be added to the monitoring program for field testing as they are developed.



## Method 1623: *Cryptosporidium* and *Giardia* in Water by Filtration IMS/FA

### 1.0 Scope and Application

**1.1** This method is for determination of the identity and concentration of *Cryptosporidium* (CAS Registry number 137259-50-8) and *Giardia* (CAS Registry number 137259-49-5) in water by filtration, immunomagnetic separation (IMS), and immunofluorescence assay (FA) microscopy. *Cryptosporidium* and *Giardia* may be confirmed using 4',6-diamidino-2-phenylindole (DAPI) staining and differential interference contrast (DIC) microscopy. The method has been validated in surface water, but may be used in other waters, provided the laboratory demonstrates that the method's performance acceptance criteria are met.

**1.2** This method is designed to meet the survey and monitoring requirements of the U.S. Environmental Protection Agency (EPA). It is based on laboratory testing of recommendations by a panel of experts convened by EPA. The panel was charged with recommending an improved protocol for recovery and detection of protozoa that could be tested and implemented with minimal additional research.

**1.3** This method will not identify the species of *Cryptosporidium* or *Giardia* or the host species of origin, nor can it determine the viability or infectivity of detected oocysts and cysts.

**1.4** This method is for use only by persons experienced in the determination of *Cryptosporidium* and *Giardia* by filtration, IMS, and FA. Experienced persons are defined in Section 22.2 as analysts. Laboratories unfamiliar with analyses of environmental samples by the techniques in this method should gain experience using water filtration techniques, IMS, fluorescent antibody staining with monoclonal antibodies, and microscopic examination of biological particulates using bright-field and DIC microscopy.

**1.5** Any modification of the method beyond those expressly permitted is subject to the application and approval of alternative test procedures under 40 CFR Part 141.27.

### 2.0 Summary of Method

**2.1** A water sample is filtered and the oocysts, cysts, and extraneous materials are retained on the filter. Although EPA has only validated the method using laboratory filtration of bulk water samples shipped from the field, field-filtration also can be used.

### 2.2 Elution and separation

**2.2.1** Materials on the filter are eluted and the eluate is centrifuged to pellet the oocysts and cysts, and the supernatant fluid is aspirated.

**2.2.2** The oocysts and cysts are magnetized by attachment of magnetic beads conjugated to anti-*Cryptosporidium* and anti-*Giardia* antibodies. The magnetized oocysts and cysts are separated from the extraneous materials using a magnet, and the extraneous materials are discarded. The magnetic bead complex is then detached from the oocysts and cysts.

### 2.3 Enumeration

**2.3.1** The oocysts and cysts are stained on well slides with fluorescently labeled monoclonal antibodies and 4',6-diamidino-2-phenylindole (DAPI). The stained sample is examined using fluorescence and differential interference contrast (DIC) microscopy.

**2.3.2** Qualitative analysis is performed by scanning each slide well for objects that meet the size, shape, and fluorescence characteristics of *Cryptosporidium* oocysts or *Giardia* cysts. Potential oocysts or cysts are confirmed through DAPI staining characteristics and DIC microscopy. Oocysts and cysts are identified when the size, shape, color, and morphology agree with specified criteria and examples in a photographic library.

**2.3.3** Quantitative analysis is performed by counting the total number of objects on the slide confirmed as oocysts or cysts.

**2.4** Quality is assured through reproducible calibration and testing of the filtration, immunomagnetic separation (IMS), staining, and microscopy systems. Detailed information on these tests is provided in Section 9.0.

### 3.0 Definitions

**3.1** *Cryptosporidium* is defined as a protozoan parasite potentially found in water and other media. The six species of *Cryptosporidium* and their potential hosts are *C. parvum* (mammals, including humans); *C. baileyi* and *C. meleagridis* (birds); *C. muris* (rodents); *C. serpentis* (reptiles); and *C. nasorum* (fish).

**3.2** *Giardia* is defined as a protozoan parasite potentially found in water and other media. The two species of *Giardia* and their potential hosts are *G. intestinalis* (humans) and *G. muris* (mice).

**3.3** Definitions for other terms used in this method are given in the glossary (Section 22.0).

### 4.0 Contamination, Interferences, and Organism Degradation

**4.1** Turbidity caused by inorganic and organic debris can interfere with the concentration, separation, and examination of the sample for *Cryptosporidium* oocysts and *Giardia* cysts. In addition to naturally-occurring debris, such as clays and algae, chemicals, such as iron and alum coagulants and polymers, may be added to finished waters during the treatment process, which may result in additional interference.

**4.2** Organisms and debris that autofluoresce or demonstrate non-specific fluorescence, such as algal and yeast cells, when examined by epifluorescent microscopy, may interfere with the detection of oocysts and cysts and contribute to false positives by immunofluorescence assay (FA).

**4.3** Solvents, reagents, labware, and other sample-processing hardware may yield artifacts that may cause misinterpretation of microscopic examinations for oocysts and cysts. All materials used shall be demonstrated to be free from interferences under the conditions of analysis by running a method blank (negative control sample) initially and a minimum of every week or after changes in source of reagent water. Specific selection of reagents and purification of solvents and other materials may be required.

**4.4** Interferences co-extracted from samples will vary considerably from source to source, depending on the water being sampled. Experience suggests that high levels of algae, bacteria, and other protozoa can interfere in the identification of oocysts and cysts (Reference 20.1).

**4.5** Freezing samples, filters, eluates, concentrates, or slides may interfere with the detection and/or identification of oocysts and cysts.

**4.6** All equipment should be cleaned according to manufacturers' instructions. Disposable supplies should be used wherever possible.

### 5.0 Safety

**5.1** The biohazard associated with, and the risk of infection from, oocysts and cysts is high in this method because live organisms are handled. This method does not purport to address all of the safety problems associated with its use. It is the responsibility of the laboratory to establish appropriate safety and health practices prior to use of this method. In particular, laboratory staff must know and observe the safety procedures required in a microbiology laboratory that handles pathogenic organisms while preparing, using, and disposing of sample concentrates, reagents and materials, and while operating sterilization equipment.

**5.2** The toxicity or carcinogenicity of each compound or reagent used in this method has not been precisely determined; however, each chemical compound should be treated as a potential health hazard. Exposure to these compounds should be reduced to the lowest possible level. The laboratory is responsible for maintaining a current awareness file of Occupational Safety and Health Administration regulations regarding the safe handling of the chemicals specified in this method. A reference file of Safety Data Sheet (formerly MSDS)s should be made available to all personnel involved in these analyses. Additional information on laboratory safety can be found in References 20.2 through 20.5.

**5.3** Samples may contain high concentrations of biohazards and toxic compounds, and must be handled with gloves and opened in a biological safety cabinet to prevent exposure. Reference materials and standards containing oocysts and cysts must also be handled with gloves and laboratory staff must never place gloves in or near the face after exposure to solutions known or suspected to contain oocysts and cysts. Do not mouth-pipette.

**5.4** Laboratory personnel must change gloves after handling filters and other contaminant-prone equipment and reagents. Gloves must be removed or changed before touching any other laboratory surfaces or equipment.

**5.5** Centers for Disease Control (CDC) regulations (42 CFR 72) prohibit interstate shipment of more than 4 L of solution known to contain infectious materials. State regulations may contain similar regulations for intrastate commerce. Unless the sample is known or suspected to contain *Cryptosporidium*, *Giardia*, or other infectious agents (e.g., during an outbreak), samples should be shipped as noninfectious and should not be marked as infectious. If a sample is known or suspected to be infectious, and the sample must be shipped to a laboratory by a transportation means affected by CDC or state regulations, the sample should be shipped in accordance with these regulations.

## **6.0 Equipment and Supplies**

**NOTE:** *Brand names, suppliers, and part numbers are for illustrative purposes only. No endorsement is implied. Equivalent performance may be achieved using apparatus and materials other than those specified here, but demonstration of equivalent performance that meets the requirements of this method is the responsibility of the laboratory.*

**6.1 Sample collection equipment for shipment of bulk water samples for laboratory filtration.** Collapsible LDPE cubitainer for collection of 10-L bulk sample(s)—Cole Parmer cat. no. U-06100-30 or equivalent. Fill completely to ensure collection of a full 10-L sample. Discard after one use.

**6.2** Equipment for sample filtration. Three options have been demonstrated to be acceptable for use with Method 1623. Other options may be used if their acceptability is demonstrated according to the procedures outlined in Section 9.1.2.

**6.2.1** Cubitainer spigot to facilitate laboratory filtration of sample (for use with any filtration option)—Cole Parmer cat. no. U-06061-01, or equivalent.

**6.2.2** Envirochek™ sampling capsule equipment requirements for use with the procedure described in Section 12.0. The version of the method using this filter was validated using 10-L sample volumes; alternate sample volumes may be used, provided the laboratory demonstrates acceptable performance on initial and ongoing spiked reagent water and source water samples (Section 9.1.2).

**6.2.2.1** Sampling capsule—Envirochek™, Pall Gelman Laboratory, Ann Arbor, MI, product 12110

**6.2.2.2** Laboratory shaker with arms for agitation of sampling capsules

**6.2.2.2.1** Laboratory shaker—Lab-Line model 3589, VWR Scientific cat. no. 57039-055, Fisher cat. no. 14260-11, or equivalent

**6.2.2.2.2** Side arms for laboratory shaker—Lab-Line Model 3587-4, VWR Scientific cat. no. 57039-045, Fisher cat. no. 14260-13, or equivalent

**6.2.3** CrypTest™ capsule filter equipment requirements. Follow the manufacturer's instructions when using this filtration option. The version of the method using this filter was validated using 10-L sample volumes; alternate sample volumes may be used, provided the laboratory demonstrates acceptable performance on initial and ongoing spiked reagent water and matrix samples (Section 9.1.2).

**6.2.3.1** Capsule filter—CrypTest™, Whatman Inc, Clifton, NJ, product no. 610064

**6.2.3.2** Cartridge housing—Ametek 5-in. clear polycarbonate, Whatman cat. no. 71503, or equivalent

**6.2.3.3** Ultrasonic bath—VWR Model 75T#21811-808, or equivalent

**6.2.3.4** Laboratory tubing—Tygon formula R-3603, or equivalent

**6.2.4** Filta-Max™ foam filter equipment requirements. Follow the manufacturer's instructions when using this filtration option. The version of the method using this filter was validated using 50-L sample volumes; alternate sample volumes may be used, provided the laboratory demonstrates acceptable performance on initial and ongoing spiked reagent water and matrix samples (Section 9.1.2).

6.2.4.1 Foam filter—Filta-Max™, IDEXX, Westbrook, ME. Filter module and membrane: product code FMC 10601; filter membranes (100 pack), product code FMC 10800

**NOTE:** Check at least one filter per batch to ensure that the filters have not been affected by improper storage or other factors that could result in brittleness or other problems. At a minimum confirm that the test filter expands properly in water before using the batch or shipping filters to the field.

6.2.4.2 Filter processing equipment—Filta-Max starter kit, IDEXX, Westbrook, ME, cat. no. FMC 11002. Includes all equipment required to run and process Filta-Max filter modules (manual wash station (FMC 10102) including plunger head (FMC 12001), elution tubing set (FMC 10301), vacuum set (FMC 10401), filter housing (FMC 10501), and magnetic stirrer (FMC 10901).

### 6.3 Ancillary sampling equipment

6.3.1 Tubing—Glass, polytetrafluoroethylene (PTFE), high-density polyethylene (HDPE), or other tubing to which oocysts and cysts will not easily adhere—Tygon formula R-3603, or equivalent. If rigid tubing (glass, PTFE, HDPE) is used and the sampling system uses a peristaltic pump, a minimum length of compressible tubing may be used in the pump. Before use, the tubing must be autoclaved, thoroughly rinsed with detergent solution, followed by repeated rinsing with reagent water to minimize sample contamination.

Alternately, decontaminate using hypochlorite solution, sodium thiosulfate, and multiple reagent water rinses; dispose of tubing when wear is evident. Dispose of tubing after one use whenever possible.

6.3.2 Flow control valve—0.5 gpm (0.03 L/s), Bertram Controls, Plast-O-Matic cat. no. FC050B½-PV, or equivalent; or 0.4- to 4-Lpm flow meter with valve—Alamo Water Treatment, San Antonio, TX, cat. no. R5310, or equivalent.

6.3.3 Centrifugal pump—Grainger, Springfield, VA, cat. no. 2P613, or equivalent

6.3.4 Flow meter—Sameco cold water totalizer, E. Clark and Associates, Northboro, MA, product no. WFU 10.110, or equivalent.

### 6.4 Equipment for spiking samples in the laboratory

6.4.1 10-L carboy with bottom delivery port (½")—Cole-Palmer cat. no. 06080-42, or equivalent; calibrate to 10.0 L and mark level with waterproof marker.

6.4.2 Stir bar—Fisher cat. no. 14-511-93, or equivalent.

6.4.3 Stir plate—Fisher cat. no. 14-493-120S, or equivalent.

6.4.4 Hemacytometer—Neubauer type, Hauser Scientific, Horsham, PA, cat. no. 3200 or 1475, or equivalent.

6.4.5 Hemacytometer coverslip—Hauser Scientific, cat. no. 5000 (for hemacytometer cat. no. 3200) or 1461 (for hemacytometer cat. no. 1475), or equivalent.

6.4.6 Lens paper without silicone—Fisher cat. no. 11-995, or equivalent.

6.4.7 Polystyrene or polypropylene conical tubes with screw caps—15- and 50-mL.

6.4.8 Equipment required for enumeration of spiking suspensions using membrane filters.

6.4.8.1 Glass microanalysis filter holder—25-mm-diameter, with fritted glass support, Fisher cat. no. 09-753E, or equivalent. Replace stopper with size 8, one-hole rubber stopper, Fisher Cat. No. 14-135M, or equivalent.

6.4.8.2 Three-port vacuum filtration manifold and vacuum source—Fisher Cat. No. 09-753-39A, or equivalent.

6.4.8.3 Cellulose acetate support membrane—1.2-µm-pore-size, 25-mm-diameter, Fisher cat. no. A12SP02500, or equivalent.

6.4.8.4 Polycarbonate track-etch hydrophilic membrane filter—1-µm-pore-size, 25-mm-diameter, Fisher cat. no. K10CP02500, or equivalent.

6.4.8.5 100 × 15 mm polystyrene Petri dishes (bottoms only).

6.4.8.6 60 × 15 mm polystyrene Petri dishes.

6.4.8.7 Glass microscope slides—1 in. × 3 in or 2 in. × 3 in.

6.4.8.8 Coverslips—25 mm<sup>2</sup>

## 6.5 Immunomagnetic separation (IMS) apparatus

6.5.1 Sample mixer—Dynal Inc., Lake Success, NY, cat. no. 947.01, or equivalent.

6.5.2 Magnetic particle concentrator for 10-mL test tubes—Dynal MPC-1® , cat. no. 120.01, or equivalent.

6.5.3 Magnetic particle concentrator for microcentrifuge tubes—Dynal MPC-M®, cat. no. 120.09, or equivalent.

6.5.4 Flat-sided sample tubes—16 × 125 mm Leighton-type tubes with 60 × 10 mm flat-sided magnetic capture area, Dynal L10, cat. no. 740.03, or equivalent.

6.6 Powder-free latex gloves—Fisher cat no. 113945B, or equivalent.

6.7 Graduated cylinders, autoclavable—10-, 100-, and 1000-mL.

## 6.8 Centrifuges

6.8.1 Centrifuge capable of accepting 15- to 250-mL conical centrifuge tubes and achieving 1500 × G—International Equipment Company, Needham Heights, MA, Centrifuge Size 2, Model K with swinging bucket, or equivalent.

6.8.2 Centrifuge tubes—Conical, graduated, 1.5-, 50-, and 250-mL.

## 6.9 Microscope

6.9.1 Epifluorescence/differential interference contrast (DIC) with stage and ocular micrometers and 20X (N.A.=0.4) to 100X (N.A.=1.3) objectives—Zeiss™ Axioskop, Olympus™ BH, or equivalent.

6.9.2 Excitation/band-pass filters for immunofluorescence assay (FA)—Zeiss™ 487909 or equivalent, including, 450- to 490-nm exciter filter, 510-nm dichroic beam-splitting mirror, and 515- to 520-nm barrier or suppression filter.

6.9.3 Excitation/band-pass filters for DAPI—Filters cited below (Chroma Technology, Brattleboro, VT), or equivalent.

Microscope model	Fluoro-chrome	Excitation filter (nm)	Dichroic beam-splitting mirror (nm)	Barrier or suppression filter (nm)	Chroma catalog number
Zeiss™ - Axioskop	DAPI (UV)	340-380	400	420	CZ902
Zeiss™ -IM35	DAPI (UV)	340-380	400	420	CZ702
Olympus™ BH	DAPI (UV)	340-380	400	420	11000
			Filter holder		91002
Olympus™ BX	DAPI (UV)	340-380	400	420	11000
			Filter holder		91008
Olympus™ IMT2	DAPI (UV)	340-380	400	420	11000
			Filter holder		91003

## **6.10 Ancillary equipment for microscopy**

- 6.10.1 Well slides— Spot-On well slides, Dynal cat. no. 740.04; treated, 12-mm diameter well slides, Meridian Diagnostics Inc., Cincinnati, OH, cat. no. R2206; or equivalent.
- 6.10.2 Glass coverslips—22 × 50 mm.
- 6.10.3 Nonfluorescing immersion oil.
- 6.10.4 Micropipette, adjustable: 0- to 10- $\mu$ L with 0- to 10- $\mu$ L tips 10- to 100- $\mu$ L, with 10- to 200- $\mu$ L tips 100- to 1000- $\mu$ L with 100- to 1000- $\mu$ L tips
- 6.10.5 Forceps—Splinter, fine tip.
- 6.10.6 Forceps—Blunt-end.
- 6.10.7 Desiccant—Drierite™ Absorbent, Fisher cat. no. 07-577-1A, or equivalent
- 6.10.8 Humid chamber—A tightly sealed plastic container containing damp paper towels on top of which the slides are placed.

## **6.11 Pipettes—Glass or plastic**

- 6.11.1 5-, 10-, and 25-mL.
- 6.11.2 Pasteur, disposable.

## **6.12 Balances**

- 6.12.1 Analytical—Capable of weighing 0.1 mg.
- 6.12.2 Top loading—Capable of weighing 10 mg.

## **6.13 pH meter**

**6.14 Incubator**—Fisher Scientific Isotemp™, or equivalent.

**6.15 Vortex mixer**—Fisons Whirlmixer, or equivalent.

**6.16 Vacuum source**—Capable of maintaining 25 in. Hg, equipped with shutoff valve and vacuum gauge.

## **6.17 Miscellaneous labware and supplies**

- 6.17.1 Test tubes and rack.
- 6.17.2 Flasks—Suction, Erlenmeyer, and volumetric, various sizes.
- 6.17.3 Beakers—Glass or plastic, 5-, 10-, 50-, 100-, 500-, 1000-, and 2000-mL.
- 6.17.4 Lint-free tissues.
- 6.18 10- to 15-L graduated container—Fisher cat. no. 02-961-50B, or equivalent; calibrate to 9.0, 9.5, 10.0, 10.5, and 11.0 L and mark levels with waterproof marker.
- 6.19 Filters for filter-sterilizing reagents—Sterile Acrodisc, 0.45  $\mu$ m, Gelman Sciences cat no. 4184, or equivalent.

## **7.0 Reagents and Standards**

### **7.1 Reagents for adjusting pH**

- 7.1.1 Sodium hydroxide (NaOH)—ACS reagent grade, 6.0 N and 1.0 N in reagent water
- 7.1.2 Hydrochloric acid (HCl)—ACS reagent grade, 6.0 N, 1.0 N, and 0.1 N in reagent water.

**NOTE:** Due to the low volumes of pH-adjusting reagents used in this method, and the impact that changes in pH have on the immunofluorescence assay, the laboratory should purchase standards at the required normality directly from a vendor. Normality should not be adjusted by the laboratory.

**7.2 Solvents**—Acetone, glycerol, ethanol, and methanol, ACS reagent grade

**7.3 Reagent water**—Water in which oocysts and cysts and interfering materials and substances, including magnetic minerals, are not detected by this method.



## 7.4 Reagents for eluting filters

7.4.1 Reagents for eluting Envirochek™ sampling capsules (Section 6.2.2)

7.4.1.1 Laureth-12—PPG Industries, Gurnee, IL, cat. no. 06194, or equivalent. Store Laureth-12 as a 10% solution in reagent water. Weigh 10 g of Laureth-12 and dissolve using a microwave or hot plate in 90 mL of reagent water. Dispense 10-mL aliquots into sterile vials and store at room temperature for up to 2 months, or in the freezer for up to a year.

7.4.1.2 1 M Tris, pH 7.4—Dissolve 121.1 g Tris (Fisher cat. no. BP152) in 700 mL of reagent water and adjust pH to 7.4 with 1 N HCl or NaOH. Dilute to a final 1000 mL with reagent water and adjust the final pH. Filter-sterilize through a 0.2-µm membrane into a sterile plastic container and store at room temperature.

7.4.1.3 0.5 M EDTA, 2 Na, pH 8.0—Dissolve 186.1 g ethylenediamine tetraacetic acid, disodium salt dihydrate (Fisher cat. no. S311) in 800 mL and adjust pH to 8.0 with 6.0 N HCl or NaOH. Dilute to a final volume of 1000 mL with reagent water and adjust to pH 8.0 with 1.0 N HCl or NaOH.

7.4.1.4 Antifoam A—Sigma Chemical Co. cat. no. A5758, or equivalent

7.4.1.5 Preparation of elution buffer solution—Add the contents of a pre-prepared Laureth-12 vial (Section 7.4.1.1) to a 1000-mL graduated cylinder. Rinse the vial several times to ensure the transfer of the detergent to the cylinder. Add 10 mL of Tris solution (Section 7.4.1.2), 2 mL of EDTA solution (Section 7.4.1.3), and 150 µL Antifoam A (Section 7.4.1.4). Dilute to 1000 mL with reagent water.

7.4.2 Reagents for eluting CrypTest™ capsule filters (Section 6.2.3). To 900 mL of reagent water add 8.0 g NaCl, 0.2 g KH<sub>2</sub>PO<sub>4</sub>, 2.9 g Na<sub>2</sub>HPO<sub>4</sub> (12H<sub>2</sub>O) 0.2 g KCl, 0.2 g sodium lauryl sulfate (SDS), 0.2 mL Tween 80, and 0.02 mL Antifoam A (Sigma Chemical Co. cat. no. A5758, or equivalent). Adjust volume to 1 L with reagent water and adjust pH to 7.4 with 1 N NaOH or HCl.

7.4.3 Reagents for eluting Filta-Max™ foam filters (Section 6.2.4)

7.4.3.1 Phosphate buffered saline (PBS), pH 7.4—Sigma Chemical Co. cat. no. P-3813, or equivalent. Alternately, prepare PBS by adding the following to 1 L of reagent water: 8 g NaCl; 0.2 g KCl; 1.15 g Na<sub>2</sub>HPO<sub>4</sub>, anhydrous; and 0.2 g KH<sub>2</sub>PO<sub>4</sub>.

7.4.3.2 Tween 20—Sigma Chemical Co. cat. no. P-7949, or equivalent.

7.4.3.3 High-vacuum grease—BDH/Merck. cat. no. 636082B, or equivalent.

7.4.3.4 Preparation of PBST elution buffer. Add the contents of one sachet of PBS to 1.0 L of reagent water. Dissolve by stirring for 30 minutes. Add 100 µL of Tween 20. Mix by stirring for 5 minutes.

7.5 Reagents for immunomagnetic separation (IMS)—Dynabeads® GC-Combo, Dynal cat. nos. 730.02, 730.12, or equivalent.

7.6 Direct antibody labeling reagents for detection of oocysts and cysts. Store reagents at 0 °C to 8 °C and return promptly to this temperature after each use. Do not allow any of the reagents to freeze. The reagents should be protected from exposure to light. Diluted, unused working reagents should be discarded after 48 hours. Discard reagents after the expiration date is reached. The labeling reagents in Sections 7.6.1-7.6.3 have been approved for use with this method.

7.6.1 Merifluor Cryptosporidium/Giardia, Meridian Diagnostics cat. no. 250050, Cincinnati, OH, or equivalent.

7.6.2 Aqua-Glo™ G/C Direct FL, Waterborne cat. no. A100FLR, New Orleans, LA, or equivalent.

7.6.3 Crypt-a-Glo™ and Giardi-a-Glo™, Waterborne cat. nos. A400FLR and A300FLR, respectively, New Orleans, LA, or equivalent.

**NOTE:** If a laboratory will use multiple types of labeling reagents, the laboratory must demonstrate acceptable performance through an initial precision and recovery test (Section 9.4) for each type, and must perform positive and negative staining controls for each batch of slides stained using each product. However, the laboratory is not required

to analyze additional ongoing precision and recovery samples or method blank samples for each type.

7.6.4 Diluent for labeling reagents—Phosphate buffered saline (PBS), pH 7.4—Sigma Chemical Co. cat. no. P-3813, or equivalent. Alternately, prepare PBS by adding the following to 1 L of reagent water: 8 g NaCl; 0.2 g KCl; 1.15 g Na<sub>2</sub>HPO<sub>4</sub>, anhydrous; and 0.2 g KH<sub>2</sub>PO<sub>4</sub>. Filter-sterilize (Section 6.19) or autoclave. Discard if growth is detected or after 6 months, whichever comes first.

7.7 4',6-diamidino-2-phenylindole (DAPI) stain—Sigma Chemical Co. cat. no. A5758, or equivalent.

7.7.1 Stock solution—Dissolve 2 mg/mL DAPI in absolute methanol. Prepare volume consistent with minimum use. Store at 0 °C to 8 °C in the dark. Do not allow to freeze. Discard unused solution when positive staining control fails.

7.7.2 Staining solution (1/5000 dilution in PBS [Section 7.6.4])—Add 10 µL of 2 mg/mL DAPI stock solution to 50 mL of PBS. Prepare daily. Store at 0 °C to 8 °C in the dark except when staining. Do not allow to freeze. The solution concentration may be increased up to 1 µg/mL if fading/diffusion of DAPI staining is encountered, but the staining solution must be tested first on expendable environmental samples to confirm that staining intensity is appropriate.

## 7.8 Mounting medium

7.8.1 DABCO/glycerol mounting medium (2%)—Dissolve 2 g of DABCO (Sigma Chemical Co. cat no. D-2522, or equivalent) in 95 mL of warm glycerol/PBS (60% glycerol, 40% PBS [Section 7.6.4]). After the DABCO has dissolved completely, adjust the solution volume to 100 mL by adding an appropriate volume of glycerol/PBS solution. Alternately, dissolve the DABCO in 40 mL of PBS, then add azide (1 mL of 100X, or 10% solution), then 60 mL of glycerol.

7.8.2 Mounting medium supplied with Merifluor direct labeling kit (Section 7.6.1)

7.9 Clear fingernail polish or clear fixative, PGC Scientifics, Gaithersburg, MD, cat. no. 60-4890, or equivalent.

## 7.10 Oocyst and cyst suspensions for spiking

7.10.1 Enumerated spiking suspensions prepared by flow cytometer—not heat-fixed or formalin fixed: Wisconsin State Laboratory of Hygiene Flow Cytometry Unit or equivalent

7.10.2 Materials for manual enumeration of spiking suspensions

7.10.2.1 Purified Cryptosporidium oocyst stock suspension for manual enumeration—not heat-fixed or formalin-fixed: Sterling Parasitology Laboratory, University of Arizona, Tucson, or equivalent

7.10.2.2 Purified Giardia cyst stock suspension for manual enumeration—not heat-fixed or formalin-fixed: Waterborne, Inc., New Orleans, LA; Hyperion Research, Medicine Hat, Alberta, Canada; or equivalent

7.10.2.3 Tween-20, 0.01%—Dissolve 1.0 mL of a 10% solution of Tween-20 in 1 L of reagent water

7.10.2.4 Storage procedure—Store oocyst and cyst suspensions at 0 °C to 8 °C, until ready to use; do not allow to freeze

7.11 Additional reagents for enumeration of spiking suspensions using membrane filtration (Section 11.3.6)—Sigmacote® Sigma Company Product No. SL-2, or equivalent

## 8.0 Sample Collection and Storage

8.1 Samples are collected as bulk samples and shipped to the laboratory for processing through the entire method, or are filtered in the field and shipped to the laboratory for processing from elution (Section 12.2.6) onward. Samples must be shipped via overnight service on the day they are collected. Chill samples as much as possible between collection and shipment by storing in a refrigerator or pre-icing the sample in a cooler. If the sample is pre-iced before shipping, replace with fresh ice immediately before shipment. Samples should be shipped at 0 °C to 8 °C, unless the time required to chill the sample to 8 °C would prevent the sample from being shipped

overnight for receipt at the laboratory the day after collection. Samples must not be allowed to freeze. Upon receipt, the laboratory should record the temperature of the samples and store them refrigerated at 0 °C to 8 °C until processed. Results from samples shipped overnight to the laboratory and received at >8 °C should be qualified by the laboratory.

**NOTE:** See transportation precautions in Section 5.5.

**8.2 Sample holding times.** Sample processing should be completed as soon as possible by the laboratory. The laboratory should complete sample filtration, elution, concentration, purification, and staining the day the sample is received wherever possible. However, the laboratory is permitted to split up the sample processing steps if processing a sample completely in one day is not possible. If this is necessary, sample processing can be halted after filtration, application of the purified sample onto the slide, or staining. Table 1, in Section 21.0 provides a breakdown of the holding times for each set of steps. Sections 8.2.1 through 8.2.4 provide descriptions of these holding times.

8.2.1 Sample collection and filtration. Sample elution must be initiated within 96 hours of sample collection (if shipped to the laboratory as a bulk sample) or filtration (if filtered in the field).

8.2.2 Sample elution, concentration, and purification. The laboratory must complete the elution, concentration, and purification (Sections 12.2.6 through 13.3.3.11) in one work day. It is critical that these steps be completed in one work day to minimize the time that any target organisms present in the sample sit in eluate or concentrated matrix. This process ends with the application of the purified sample on the slide for drying.

8.2.3 Staining. The sample must be stained within 72 hours of application of the purified sample to the slide.

8.2.4 Examination. Although immunofluorescence assay (FA) and 4',6-diamidino-2-phenylindole (DAPI) and differential interference contrast (DIC) microscopy examination and confirmation should be performed immediately after staining is complete, laboratories have up to 7 days from completion of sample staining to complete the examination and confirmation of samples.

However, if fading/diffusion of FITC or DAPI staining is noticed, the laboratory must reduce this holding time. In addition the laboratory may adjust the concentration of the DAPI staining solution (Sections 7.7.2) so that fading/diffusion does not occur.

8.5 Spiking suspension enumeration holding times. Flow-cytometer-sorted spiking suspensions (Sections 7.10.1 and 11.2) used for spiked quality control (QC) samples (Section 9) must be used within the expiration date noted on the suspension. Laboratories should use flow-cytometer sorted spiking suspensions containing live organisms within two weeks of preparation at the flow cytometry laboratory. Manually enumerated spiking suspensions must be used within 24 hours of enumeration of the spiking suspension if the hemacytometer chamber technique is used (Section 11.3.4); or within 24 hours of application of the spiking suspension to the slides if the well slide or membrane filter enumeration technique is used (Sections 11.3.5 and 11.3.6).

## 9.0 Quality Control

9.1 Each laboratory that uses this method is required to operate a formal quality assurance (QA) program (Reference 20.6). The minimum requirements of this program consist of an initial demonstration of laboratory capability through performance of the initial precision and recovery (IPR) test (Section 9.4), analysis of spiked samples to evaluate and document data quality, and analysis of standards and blanks as tests of continued performance. Laboratory performance is compared to established performance criteria to determine if the results of analyses meet the performance characteristics of the method.

9.1.1 A test of the microscope used for detection of oocysts and cysts is performed prior to examination of slides. This test is described in Section 10.0.

9.1.2 In recognition of advances that are occurring in analytical technology, the laboratory is permitted to modify certain method procedures to improve recovery or lower the costs of measurements, provided that all required quality control (QC) tests are performed and

all QC acceptance criteria are met. Method procedures that can be modified include front-end techniques, such as filtration or immunomagnetic separation (IMS). The laboratory is not permitted to use an alternate determinative technique to replace immunofluorescence assay in this method (the use of different determinative techniques are considered to be different methods, rather than modified version of this method). However, the laboratory is permitted to modify the immunofluorescence assay procedure, provided that all required QC tests are performed (Section 9.1.2.1) and all QC acceptance criteria are met (see guidance on the use of multiple labeling reagents in Section 7.6).

#### 9.1.2.1 Method modification validation/equivalency demonstration requirements.

9.1.2.1.1 Method modifications at a single laboratory. Each time a modification is made to this method for use in a single laboratory, the laboratory is required to validate the modification according to Tier 1 of EPA's performance-based measurement system (PBMS) (Table 2 and Reference 20.7) to demonstrate that the modification produces results equivalent or superior to results produced by this method as written. Briefly, each time a modification is made to this method, the laboratory is required to demonstrate acceptable modified method performance through the IPR test (Section 9.4). IPR results must meet the QC acceptance criteria in Tables 3 and 4 in Section 21.0, and should be comparable to previous results using the unmodified procedure. Although not required, the laboratory also should perform a matrix spike/matrix spike duplicate (MS/MSD) test to demonstrate the performance of the modified method in at least one real-world matrix before analyzing field samples using the modified method. The laboratory is required to perform MS samples using the modified method at the frequency noted in Section 9.1.8.

9.1.2.1.2 Method modifications for nationwide approval. If the laboratory or a manufacturer seeks EPA approval of a method modification for nationwide use, the laboratory or manufacturer must validate the modification according to Tier 2 of EPA's PBMS (Table 2 and Reference 20.7). Briefly, at least three laboratories must perform IPR tests (Section 9.4) and MS/MSD (Section 9.5) tests using the modified method, and all tests must meet the QC acceptance criteria specified in Tables 3 and 4 in Section 21.0. Upon nationwide approval, laboratories electing to use the modified method still must demonstrate acceptable performance in their own laboratory according to the requirements in Section 9.1.2.1.1.

9.1.2.2 The laboratory is required to maintain records of modifications made to this method.

These records include the following, at a minimum:

9.1.2.2.1 The names, titles, addresses, and telephone numbers of the analyst(s) who performed the analyses and modification, and of the quality control officer who witnessed and will verify the analyses and modification.

9.1.2.2.2 A listing of the analyte(s) measured (Cryptosporidium and Giardia).

9.1.2.2.3 9.1.2.2.4 A narrative stating reason(s) for the modification.

9.1.2.2.5 Results from all QC tests comparing the modified method to this method, including: (a) IPR (Section 9.4) (b) MS/MSD (Section 9.5) (c) Analysis of method blanks (Section 9.6) Data that will allow an independent reviewer to validate each determination by tracing the following processing and analysis steps leading to the final result:

**9.1.2.2.5** Data that will allow an independent reviewer to validate each determination by tracing the following processing and analysis steps leading to the final result:

- (a) Sample numbers and other identifiers
- (b) Source of spiking suspensions, as well as lot number and date received (Section 7.10)
- (c) Spike enumeration date and time
- (d) All spiking suspension enumeration counts and calculations (Section 11.0)
- (e) Sample spiking dates and times
- (f) Volume filtered (Section 12.2.5.2)
- (g) Filtration and elution dates and times
- (h) Pellet volume, resuspended concentrate volume, resuspended concentrate volume transferred to IMS, and all calculations required to verify the percent of concentrate examined (Section 13.2)

- (i) Purification completion dates and times (Section 3.3.3.11)
- (j) Staining completion dates and times (Section 14.10)
- (k) Staining control results (Section 15.2.1)
- (l) All required examination information (Section 15.2.2)
- (m) Examination completion dates and times (Section 15.2.4)
- (n) Analysis sequence/run chronology
- (o) Lot numbers of elution, IMS, and staining reagents
- (p) Copies of bench sheets, logbooks, and other recordings of raw data
- (q) Data system outputs, and other data to link the raw data to the results reported

**9.1.3** The laboratory shall spike a separate sample aliquot from the same source to monitor method performance. This MS test is described in Section 9.5.1.

**9.1.4** Analysis of method blanks is required to demonstrate freedom from contamination. The procedures and criteria for analysis of a method blank are described in Section 9.6.

**9.1.5** The laboratory shall, on an ongoing basis, demonstrate through analysis of the ongoing precision and recovery (OPR) sample that the analysis system is in control. These procedures are described in Section 9.7.

**9.1.6** The laboratory shall maintain records to define the quality of data that are generated. Development of accuracy statements is described in Sections 9.5.1.4 and 9.7.3.

**9.1.7** The laboratory shall analyze one method blank (Section 9.6) and one OPR sample (Section 9.7) each week during which samples are analyzed if 20 or fewer field samples are analyzed during this period. The laboratory shall analyze one laboratory blank and one OPR sample for every 20 samples if more than 20 samples are analyzed in a week.

**9.1.8** The laboratory shall analyze one MS sample (Section 9.5.1) when samples are first received from a utility for which the laboratory has never before analyzed samples. The MS analysis is performed on an additional (second) sample sent from the utility. If the laboratory routinely analyzes samples from 1 or more utilities, 1 MS analysis must be performed per 20 field samples. For example, when a laboratory receives the first sample from a given site, the laboratory must obtain a second aliquot of this sample to be used for the MS. When the laboratory receives the 21st sample from this site, a separate aliquot of this 21st sample must be collected and spiked.

## **9.2 Micropipette calibration**

**9.2.1** Micropipettes must be sent to the manufacturer for calibration annually. Alternately, a qualified independent technician specializing in micropipette calibration can be used. Documentation on the precision of the recalibrated micropipette must be obtained from the manufacturer or technician.

**9.2.2** Internal and external calibration records must be kept on file in the laboratory's QA logbook.

**9.2.3** If a micropipette calibration problem is suspected, the laboratory shall tare an empty weighing boat on the analytical balance and pipette the following volumes of reagent water into the weigh boat using the pipette in question: 100% of the maximum dispensing capacity of the micropipette, 50% of the capacity, and 10% of the capacity. Ten replicates should be performed at each weight. Record the weight of the water (assume that 1.00 mL of reagent water weighs 1.00 g) and calculate the relative standard deviation (RSD) for each. If the weight of the reagent water is within 1% of the desired weight (mL) and the RSD of the replicates at each weight is within 1%, then the pipette remains acceptable for use.

**9.2.4** If the weight of the reagent water is outside the acceptable limits, consult the manufacturer's instruction manual troubleshooting section and repeat steps described in Section 9.2.3. If problems with the pipette persist, the laboratory must send the pipette to the manufacturer for recalibration.

**9.3 Microscope adjustment and certification:** Adjust the microscope as specified in Section 10.0. All of the requirements in Section 10.0 must be met prior to analysis of IPRs, blanks, OPRs, field samples, and MS/SDS.

9.4 Initial precision and recovery (IPR)—To establish the ability to demonstrate control over the analytical system and to generate acceptable precision and recovery, the laboratory shall perform the following operations:

9.4.1 Using the spiking procedure in Section 11.4 and enumerated spiking suspensions (Section 7.10.1 or Section 11.3), spike, filter, elute, concentrate, separate (purify), stain, and examine four reagent water samples spiked with 100 to 500 oocysts and 100 to 500 cysts. If more than one process will be used for filtration and/or separation of samples, a separate set of IPR samples must be prepared for each process.

**NOTE:** IPR tests must be accompanied by analysis of a method blank (Section 9.6).

9.4.2 Using results of the four analyses, calculate the average percent recovery and the relative standard deviation (RSD) of the recoveries for *Cryptosporidium* and for *Giardia*. The RSD is the standard deviation divided by the mean times 100.

9.4.3 Compare RSD and the mean with the corresponding limits for initial precision and recovery in Tables 3 and 4 in Section 21.0. If the RSD and the mean meet the acceptance criteria, system performance is acceptable and analysis of blanks and samples may begin. If the RSD or the mean falls outside the range for recovery, system performance is unacceptable. In this event, correct the problem and repeat the test (Section 9.4.1).

### 9.5 Matrix spike (MS) and matrix spike duplicate (MSD):

9.5.1 Matrix spike—The laboratory shall spike and analyze a separate field sample aliquot to determine the effect of the matrix on the method's oocyst and cyst recovery.

The MS shall be analyzed according to the frequency in Section 9.1.8.

9.5.1.1 Analyze an unspiked field sample according to the procedures in Sections 12.0 to 15.0. Using the spiking procedure in Section 11.4 and enumerated spiking suspensions (Section 7.10.1 or Section 11.3), spike, filter, elute, concentrate, separate (purify), stain, and examine a second field sample aliquot with the number of organisms used in the IPR or OPR tests (Sections 9.4 and 9.7).

9.5.1.2 For each organism, calculate the percent recovery (R) using the following equation.

$$R = 100 \times \frac{N_{sp} - N_s}{T}$$

where

R is the percent recovery

$N_{sp}$  is the number of oocysts or cysts detected in the spiked sample

$N_s$  is the number of oocysts or cysts detected in the unspiked

sample T is the true value of the oocysts or cysts spiked

9.5.1.3 Compare the recovery for each organism with the corresponding limits in Tables 3 and 4 in Section 21.0.

**NOTE:** Some sample matrices may prevent the acceptance criteria in Tables 3 and 4 from being met. An assessment of the distribution of MS recoveries across 430 MS samples from 87 sites during the ICR Supplemental Surveys is provided in Table 5.

9.5.1.4 As part of the QA program for the laboratory, method precision for samples should be assessed and records maintained. After the analysis of five samples for which the spike recovery for each organism passes the tests in Section 9.5.1.3, the laboratory should calculate the average percent recovery (P) and the standard deviation of the percent recovery ( $s_r$ ). Express the precision assessment as a percent recovery interval from  $P - 2 s_r$  to  $P + 2 s_r$  for each matrix. For example, if  $P = 80\%$  and  $s_r = 30\%$ , the accuracy interval is expressed as 20% to 140%. The

precision assessment should be updated regularly across all MS samples and stratified by MS samples for each source.

9.5.2 Matrix spike duplicate—MSD analysis is required as part of nationwide approval of a modified version of this method to demonstrate that the modified version of this method produces results equal or superior to results produced by the method as written (Section 9.1.2.1.2). At the same time the laboratory spikes and analyzes the second field sample aliquot in Section 9.5.1.1, the laboratory shall spike and analyze a third, identical field sample aliquot.

**NOTE:** Matrix spike duplicate samples are only required for Tier 2 validation studies. They are recommended for Tier 1 validation, but not required.

9.5.2.1 For each organism, calculate the percent recovery (R) using the equation in Section 9.5.1.2.

9.5.2.2 Calculate the mean of the number of oocysts or cysts in the MS and MSD ( $X_{\text{mean}}$ )  
(=  $[MS+MSD]/2$ ).

9.5.2.3 Calculate the relative percent difference (RPD) of the recoveries using the following equation:

$$RPD = 100 \frac{|N_{MS} - N_{MSD}|}{X_{\text{mean}}}$$

where

RPD is the relative percent difference

$N_{MS}$  is the number of oocysts or cysts detected in the MS

$N_{MSD}$  is the number of oocysts or cysts detected in the MSD

$X_{\text{mean}}$  is the mean number of oocysts or cysts detected in the MS and MSD

9.5.2.4 Compare the mean MS/MSD recovery and RPD with the corresponding limits in Tables 3 and 4 in Section 21.0 for each organism.

9.6 Method blank (negative control sample, laboratory blank): Reagent water blanks are analyzed to demonstrate freedom from contamination. Analyze the blank immediately prior to analysis of the IPR test (Section 9.4) and OPR test (Section 9.7) and prior to analysis of samples for the week to demonstrate freedom from contamination.

9.6.1 Filter, elute, concentrate, separate (purify), stain, and examine at least one reagent water blank per week (Section 9.1.7) according to the procedures in Sections 12.0 to 15.0. If more than 20 samples are analyzed in a week, process and analyze one reagent water blank for every 20 samples.

9.6.2 If *Cryptosporidium* oocysts, *Giardia* cysts, or any potentially interfering organism or material is found in the blank, analysis of additional samples is halted until the source of contamination is eliminated and a blank shows no evidence of contamination. Any sample in a batch associated with a contaminated blank that shows the presence of one or more oocysts or cysts is assumed to be contaminated and should be recollected, if possible. Any method blank in which oocysts or cysts are not detected is assumed to be uncontaminated and may be reported.

9.7 Ongoing precision and recovery ([OPR]; positive control sample; laboratory control sample): Using the spiking procedure in Section 11.4 and enumerated spiking suspensions (Section 7.10.1 or Section 11.3), filter, elute, concentrate, separate (purify), stain, and examine at least one reagent water sample spiked with 100 to 500 oocysts and 100 to 500 cysts each week to verify all performance criteria. The laboratory must analyze one OPR sample for every 20 samples if more than 20 samples are analyzed in a week. If multiple method variations are used, separate OPR samples must be prepared for each method variation. Adjustment and/or

recalibration of the analytical system shall be performed until all performance criteria are met. Only after all performance criteria are met may samples be analyzed.

**9.7.1** Examine the slide from the OPR prior to analysis of samples from the same batch.

**9.7.1.1** Using 200X to 400X magnification, more than 50% of the oocysts or cysts must appear undamaged and morphologically intact; otherwise, the analytical process is damaging the organisms. Determine the step or reagent that is causing damage to the organisms. Correct the problem and repeat the OPR test.

**9.7.1.2** Identify and enumerate each organism using epifluorescence microscopy. The first three presumptive *Cryptosporidium* oocysts and three *Giardia* cysts identified in the OPR sample must be examined using FITC, DAPI, and DIC, as per Section 15.2, and the detailed characteristics (size, shape, DAPI category, and DIC category) reported on the *Cryptosporidium* and *Giardia* report form, as well as any additional comments on organism appearance, if notable.

**9.7.2** For each organism, calculate the percent recovery (R) using the following equation:

$$R = 100 \times \frac{N}{T}$$

where:

R = the percent recovery

N = the number of oocysts or cysts detected

T = the number of oocysts or cysts spiked

**9.7.3** Compare the recovery with the limits for ongoing precision and recovery in Tables 3 and 4 in Section 21.0. If the recovery meets the acceptance criteria, system performance is acceptable and analysis of blanks and samples may proceed. If, however, the recovery falls outside of the range given, system performance is unacceptable. In this event, there may be a problem with the microscope or with the filtration or separation systems. Troubleshoot the problem using the procedures at Section 9.7.4 as a guide. After assessing the issue, reanalyze the OPR sample. All samples must be associated with an OPR that passes the criteria in Section 21.0. Samples that are not associated with an acceptable OPR must be flagged accordingly.

**9.7.4 Troubleshooting.** If an OPR sample has failed, and the cause of the failure is not known, the laboratory generally should identify the problem working backward in the analytical process from the microscopic examination to filtration.

**9.7.4.1** Microscope system and antibody stain: To determine if the failure of the OPR test is due to changes in the microscope or problems with the antibody stain, re-examine the positive staining control (Section 15.2.1), check Köhler illumination, and check the fluorescence of the fluorescein-labeled monoclonal antibodies (Mabs) and 4',6-diamidino-2-phenylindole (DAPI). If results are unacceptable, re-examine the previously-prepared positive staining control to determine whether the problem is associated with the microscope or the antibody stain.

**9.7.4.2** Separation (purification) system: To determine if the failure of the OPR test is attributable to the separation system, check system performance by spiking a 10-mL volume of reagent water with 100 - 500 oocysts and cysts and processing the sample through the IMS, staining, and examination procedures in Sections 13.3 through 15.0.

**9.7.4.3** Filtration/elution/concentration system: If the failure of the OPR test is attributable to the filtration/elution/concentration system, check system performance by processing spiked reagent water according to the procedures in Section 12.2 through 13.2.2.1, and filter, stain, and examine the sample concentrate according to Section 11.3.6.

**9.7.5** The laboratory should add results that pass the specifications in Section 9.7.3 to initial and previous ongoing data and update the QC chart to form a graphic representation of continued laboratory performance. The laboratory should develop a statement of laboratory accuracy (reagent water, raw surface water) by calculating the average percent recovery (R) and the



standard deviation of percent recovery ( $s_r$ ). Express the accuracy as a recovery interval from  $R - 2s_r$  to  $R + 2s_r$ . For example, if  $R = 95\%$  and  $s_r = 25\%$ , the accuracy is 45% to 145%.

9.8 The laboratory should periodically analyze an external QC sample, such as a performance evaluation or standard reference material, when available.

The laboratory also should periodically participate in interlaboratory comparison studies using the method.

**9.9** The specifications contained in this method can be met if the analytical system is under control. The standards used for initial (Section 9.4) and ongoing (Section 9.7) precision and recovery should be identical, so that the most precise results will be obtained. The microscope in particular will provide the most reproducible results if dedicated to the settings and conditions required for the determination of *Cryptosporidium* and *Giardia* by this method.

**9.10** Depending on specific program requirements, field replicates may be collected to determine the precision of the sampling technique, and duplicate spiked samples may be required to determine the precision of the analysis.

### **10.0 Microscope Calibration and Analyst Verification**

10.1 In a room capable of being darkened to near-complete darkness, assemble the microscope, all filters, and attachments. The microscope should be placed on a solid surface free from vibration. Adequate workspace should be provided on either side of the microscope for taking notes and placement of slides and ancillary materials.

10.2 Using the manuals provided with the microscope, all analysts must familiarize themselves with operation of the microscope.

### **10.3 Microscope adjustment and calibration (adapted from Reference 20.6)**

#### **10.3.1 Preparations for adjustment**

10.3.1.1 The microscopy portion of this procedure depends upon proper alignment and adjustment of very sophisticated optics. Without proper alignment and adjustment, the microscope will not function at maximal efficiency, and reliable identification and enumeration of oocysts and cysts will not be possible. Consequently, it is imperative that all portions of the microscope from the light sources to the oculars are properly adjusted.

10.3.1.2 While microscopes from various vendors are configured somewhat differently, they all operate on the same general physical principles. Therefore, slight deviations or adjustments may be required to make the procedures below work for a particular instrument.

10.3.1.3 The sections below assume that the mercury bulb has not exceeded time limits of operation, that the lamp socket is connected to the lamp house, and that the condenser is adjusted to produce Köhler illumination.

10.3.1.4 Persons with astigmatism should always wear contact lenses or glasses when using the microscope.

**CAUTION:** In the procedures below, do not touch the quartz portion of the mercury bulb with your bare fingers. Finger oils can cause rapid degradation of the quartz and premature failure of the bulb.

**WARNING:** Never look at the ultraviolet (UV) light from the mercury lamp, lamp house, or the UV image without a barrier filter in place. UV radiation can cause serious eye damage.

**10.3.2 Epifluorescent mercury bulb adjustment:** The purpose of this procedure is to ensure even field illumination. This procedure must be followed when the microscope is first used, when replacing bulbs, and if problems such as diminished fluorescence or uneven field illumination are experienced.

- 10.3.2.1 Remove the diffuser lens between the lamp and microscope or swing it out of the transmitted light path.
- 10.3.2.2 Using a prepared microscope slide, adjust the focus so the image in the oculars is sharply defined.
- 10.3.2.3 Replace the slide with a business card or a piece of lens paper.
- 10.3.2.4 Close the field diaphragm (iris diaphragm in the microscope base) so only a small point of light is visible on the card. This dot of light indicates the location of the center of the field of view.
- 10.3.2.5 Mount the mercury lamp house on the microscope without the UV diffuser lens in place and turn on the mercury bulb.
- 10.3.2.6 Remove the objective in the light path from the nosepiece. A primary (brighter) and secondary image (dimmer) of the mercury bulb arc should appear on the card after focusing the image with the appropriate adjustment.
- 10.3.2.7 Using the lamp house adjustments, adjust the primary and secondary mercury bulb images so they are side by side (parallel to each other) with the transmitted light dot in between them.
- 10.3.2.8 Reattach the objective to the nosepiece.
- 10.3.2.9 Insert the diffuser lens into the light path between the mercury lamp house and the microscope.
- 10.3.2.10 Turn off the transmitted light and replace the card with a slide of fluorescent material. Check the field for even fluorescent illumination. Adjustment of the diffuser lens probably will be required. Additional slight adjustments as in Section 10.3.2.7 above may be required.
- 10.3.2.11 Maintain a log of the number of hours the UV bulb has been used. Never use the bulb for longer than it has been rated. Fifty-watt bulbs should not be used longer than 100 hours; 100-watt bulbs should not be used longer than 200 hours.

**10.3.3 Transmitted bulb adjustment:** The purpose of this procedure is to center the filament and ensure even field illumination. This procedure must be followed when the bulb is changed.

- 10.3.3.1 Remove the diffuser lens between the lamp and microscope or swing it out of the transmitted light path.
- 10.3.3.2 Using a prepared microscope slide and a 40X (or similar) objective, adjust the focus so the image in the oculars is sharply defined.
- 10.3.3.3 Without the ocular or Bertrand optics in place, view the pupil and filament image at the bottom of the tube.
- 10.3.3.4 Focus the lamp filament image with the appropriate adjustment on the lamp house.
- 10.3.3.5 Similarly, center the lamp filament image within the pupil with the appropriate adjustment(s) on the lamp house.
- 10.3.3.6 Insert the diffuser lens into the light path between the transmitted lamp house and the microscope.

**10.3.4 Adjustment of the interpupillary distance and oculars for each eye:** These adjustments are necessary so that eye strain is reduced to a minimum, and must be made for each individual using the microscope. Section 10.3.4.2 assumes use of a microscope with both oculars adjustable; Section 10.3.4.3 assumes use of a microscope with a single adjustable ocular. The procedure must be followed each time an analyst uses the microscope.

**10.3.4.1 Interpupillary distance**

- 10.3.4.1.1** Place a prepared slide on the microscope stage, turn on the transmitted light, and focus the specimen image using the coarse and fine adjustment knobs.
- 10.3.4.1.2** Using both hands, move the oculars closer together or farther apart until a single circle of light is observed while looking through the oculars with both eyes. Note interpupillary distance.

**10.3.4.2** Ocular adjustment for microscopes capable of viewing a photographic frame through the viewing binoculars: This procedure assumes both oculars are adjustable.

**10.3.4.2.1** Place a card between the right ocular and eye keeping both eyes open. Adjust the correction (focusing) collar on the left ocular by focusing the left ocular until it reads the same as the interpupillary distance. Bring an image located in the center of the field of view into as sharp a focus as possible.

**10.3.4.2.2** Transfer the card to between the left eye and ocular. Again keeping both eyes open, bring the same image into as sharp a focus for the right eye as possible by adjusting the ocular correction (focusing) collar at the top of the right ocular.

**10.3.4.3** Ocular adjustment for microscopes without binocular capability: This procedure assumes a single focusing ocular. The following procedure assumes that only the right ocular is capable of adjustment.

**10.3.4.3.1** Place a card between the right ocular and eye keeping both eyes open. Using the fine adjustment, focus the image for the left eye to its sharpest point.

**10.3.4.3.2** Transfer the card to between the left eye and ocular. Keeping both eyes open, bring the image for the right eye into sharp focus by adjusting the ocular collar at the top of the ocular without touching the coarse or fine adjustment.

**10.3.5** Calibration of an ocular micrometer: This section assumes that a reticle has been installed in one of the oculars by a microscopy specialist and that a stage micrometer is available for calibrating the ocular micrometer (reticle). Once installed, the ocular reticle should be left in place. The more an ocular is manipulated the greater the probability is for it to become contaminated with dust particles. This calibration should be done for each objective in use on the microscope. If there is a top lens on the microscope, the calibration procedure must be done for the respective objective at each top lens setting. The procedure must be followed when the microscope is first used and each time the objective is changed.

**10.3.5.1** Place the stage micrometer on the microscope stage, turn on the transmitted light, and focus the micrometer image using the coarse and fine adjustment knobs for the objective to be calibrated. Continue adjusting the focus on the stage micrometer so you can distinguish between the large (0.1 mm) and the small (0.01 mm) divisions.

**10.3.5.2** Adjust the stage and ocular with the micrometer so the 0 line on the ocular micrometer is exactly superimposed on the 0 line on the stage micrometer.

**10.3.5.3** Without changing the stage adjustment, find a point as distant as possible from the two 0 lines where two other lines are exactly superimposed.

**10.3.5.4** Determine the number of ocular micrometer spaces as well as the number of millimeters on the stage micrometer between the two points of superimposition. For example: Suppose 48 ocular micrometer spaces equal 0.6 mm.

**10.3.5.5** Calculate the number of mm/ocular micrometer space. For example:  
 $0.6 \text{ mm} / 48 \text{ ocular micrometer spaces} = 0.0125 \text{ mm/ocular micrometer space}$

**10.3.5.6** Because most measurements of microorganisms are given in  $\mu\text{m}$  rather than mm, the value calculated above must be converted to  $\mu\text{m}$  by multiplying it by 1000  $\mu\text{m}/\text{mm}$ . For example:

$$0.0125 \text{ mm} \times 1,000 \frac{\mu\text{m}}{\text{mm}} = 12.5 \mu\text{m/ocular micrometer space}$$

**10.3.5.7** Follow the procedure below for each objective. Record the information as shown in the example below and keep the information available at the microscope.

Item no.	Objective power	Description	No. of ocular micrometer spaces	No. of stage micrometer mm <sup>1</sup>	$\mu\text{m}/\text{ocular micrometer space}$ <sup>2</sup>
1		10X		N.A. <sup>3</sup> =	
2		20X		N.A.=	
3		40X		N.A.=	
4		100X		N.A.=	

<sup>1</sup>  $100 \mu\text{m} / \text{mm}$  <sup>2</sup> (Stage micrometer length in mm  $\times$  (1000  $\mu\text{m} / \text{mm}$ ))  $\div$  no. ocular micrometer spaces

<sup>3</sup> N.A. refers to numerical aperture. The numerical aperture value is engraved on the barrel of the objective.

**10.3.6 Köhler illumination:** This section assumes that Köhler illumination will be established for only the 100X oil DIC objective that will be used to identify internal morphological characteristics in *Cryptosporidium* oocysts and *Giardia* cysts. If more than one objective is to be used for DIC, then each time the objective is changed, Köhler

illumination must be reestablished for the new objective lens. Previous sections have adjusted oculars and light sources. This section aligns and focuses the light going through the condenser underneath the stage at the specimen to be observed. If Köhler illumination is not properly established, then DIC will not work to its maximal potential. These steps need to become second nature and must be practiced regularly until they are a matter of reflex rather than a chore. The procedure must be followed each time an analyst uses the microscope and each time the objective is changed.

10.3.6.1 Place a prepared slide on the microscope stage, place oil on the slide, move the 100X oil objective into place, turn on the transmitted light, and focus the specimen image using the coarse and fine adjustment knobs.

10.3.6.2 At this point both the radiant field diaphragm in the microscope base and the aperture diaphragm in the condenser should be wide open. Now close down the radiant field diaphragm in the microscope base until the lighted field is reduced to a small opening.

10.3.6.3 Using the condenser centering screws on the front right and left of the condenser, move the small lighted portion of the field to the center of the visual field.

10.3.6.4 Now look to see whether the leaves of the iris field diaphragm are sharply defined (focused) or not. If they are not sharply defined, then they can be focused distinctly by changing the height of the condenser up and down with the condenser focusing knob while you are looking through the binoculars. Once you have accomplished the precise focusing of the radiant field diaphragm leaves, open the radiant field diaphragm until the leaves just disappear from view.

10.3.6.5 The aperture diaphragm of the condenser is now adjusted to make it compatible with the total numerical aperture of the optical system. This is done by removing an ocular, looking into the tube at the rear focal plane of the objective, and stopping down the aperture diaphragm iris leaves until they are visible just inside the rear plane of the objective.

10.3.6.6 After completing the adjustment of the aperture diaphragm in the condenser, return the ocular to its tube and proceed with the adjustments required to establish DIC

#### **10.4 Protozoa libraries: Each laboratory is encouraged to develop libraries of photographs and drawings for identification of protozoa.**

10.4.1 Take color photographs of *Cryptosporidium* oocysts and *Giardia* cysts by FA and 4',6-diamidino-2-phenylindole (DAPI) that the analysts (Section 22.2) determine are accurate (Section 15.2).

10.4.2 Similarly, take color photographs of interfering organisms and materials by FA and DAPI that the analysts believe are not *Cryptosporidium* oocysts or *Giardia* cysts. Quantify the size, shape, microscope settings, and other characteristics that can be used to differentiate oocysts and cysts from interfering debris and that will result in positive identification of DAPI positive or negative organisms.

**10.5 Verification of performance:** Until standard reference materials, such as National Institute of Standards and Technology standard reference materials, are available that contain a reliable number of DAPI positive or negative oocysts and cysts, this method shall rely upon the ability of the analyst for identification and enumeration of oocysts and cysts.

10.5.1 At least monthly when microscopic examinations are being performed, the laboratory shall prepare a slide containing 40 to 100 oocysts and 40 to 100 cysts. More than 50% of the oocysts and cysts must be DAPI positive.

10.5.2 Each analyst shall determine the total number of oocysts and cysts and the number that are DAPI positive or negative using the slide prepared in Section 10.5.1.

10.5.3 The total number and the number of DAPI positive or negative oocysts and cysts determined by each analyst (Section 10.5.2.) must be within  $\pm 10\%$  of each other. If the number is not within this range, the analysts must identify the source of any variability

between analysts' examination criteria, prepare a new slide, and repeat the performance verification (Sections 10.5.1 to 10.5.2).

10.5.4 Document the date, name(s) of analyst(s), number of total, DAPI positive or negative oocysts and cysts determined by the analyst(s), whether the test was passed/failed and the results of attempts before the test was passed.

10.5.5 Only after an analyst has passed the criteria in Section 10.5.3, may oocysts and cysts in QC samples and field samples be identified and enumerated.

## **11.0 Oocyst and Cyst Suspension Enumeration and Spiking**

11.1 This method requires routine analysis of spiked QC samples to demonstrate acceptable initial and ongoing laboratory and method performance (initial precision and recovery samples [Section 9.4], matrix spike and matrix spike duplicate samples [Section 9.5], and ongoing precision and recovery samples [Section 9.7]). The organisms used for these samples must be enumerated to calculate recoveries and precision. EPA recommends that flow cytometry be used for this enumeration, rather than manual techniques. Flow cytometer–sorted spikes generally are characterized by a relative standard deviation of  $\leq 2.5\%$ , versus greater variability for manual enumeration techniques (Reference 20.8). Guidance on preparing spiking suspensions using a flow cytometer is provided in Section 11.2. Manual enumeration procedures are provided in Section 11.3. The procedure for spiking bulk samples in the laboratory is provided in Section 11.4.

11.2 Flow cytometry enumeration guidelines. Although it is unlikely that many laboratories performing Method 1623 will have direct access to a flow cytometer for preparing spiking suspensions, flow-sorted suspensions are available from commercial vendors and other sources (Section 7.10.1). The information provided in Sections 11.2.1 through 11.2.4 is simply meant as a guideline for preparing spiking suspensions using a flow cytometer. Laboratories performing flow cytometry must develop and implement detailed standardized protocols for calibration and operation of the flow cytometer.

11.2.1 Spiking suspensions should be prepared using unstained organisms that have not been heat-fixed or formalin-fixed.

11.2.2 Spiking suspensions should be prepared using *Cryptosporidium parvum* oocysts <3 months old, and *Giardia intestinalis* cysts <2 weeks old.

11.2.3 Initial calibration. Immediately before sorting spiking suspensions, an initial calibration of the flow cytometer should be performed by conducting 10 sequential sorts directly onto membranes or well slides. The oocyst and cyst levels used for the initial calibration should be the same as the levels used for the spiking suspensions. Each initial calibration sample should be stained and manually counted microscopically and the manual counts used to verify the accuracy of the system. The relative standard deviation (RSD) of the 10 counts should be  $\leq 2.5\%$ . If the RSD is  $> 2.5\%$ , the laboratory should perform the initial calibration again, until the RSD of the 10 counts is  $\leq 2.5\%$ . In addition to counting the organisms, the laboratory also should evaluate the quality of the organisms using DAPI and DIC to confirm that the organisms are in good condition.

11.2.4 Ongoing calibration. When sorting the spiking suspensions for use in QC samples, the laboratory should perform ongoing calibration samples at a 10% frequency, at a minimum. The laboratory should sort the first run and every eleventh sample directly onto a membrane or well slide. Each ongoing calibration sample should be stained and manually counted microscopically and the manual counts used to verify the accuracy of the system. The mean of the ongoing calibration counts also should be used as the estimated spike dose, if the relative standard deviation (RSD) of the ongoing calibration counts is  $\leq 2.5\%$ . If the RSD is  $> 2.5\%$ , the laboratory should discard the batch.

11.2.5 Method blanks. Depending on the operation of the flow cytometer, method blanks should be prepared and examined at the same frequency as the ongoing calibration samples (Section 11.2.4).

11.2.6 Holding time criteria. Flow-cytometer-sorted spiking suspensions (Sections 7.10.1 and 11.2) used for spiked quality control (QC) samples (Section 9) must be used within the expiration date noted on the suspension. Laboratories should use flow-cytometer-sorted spiking suspensions containing live organisms within two weeks of preparation at the flow cytometry laboratory.

**11.3 Manual enumeration procedures.** Two sets of manual enumerations are required per organism before purified *Cryptosporidium* oocyst and *Giardia* cyst stock suspensions (Sections 7.9.2.1 and 7.9.2.2) received from suppliers can be used to spike samples in the laboratory. First, the stock suspension must be diluted and enumerated (Section 11.3.3) to yield a suspension at the appropriate oocyst or cyst concentration for spiking (spiking suspension). Then, 10 aliquots of spiking suspension must be enumerated to calculate a mean spike dose. Spiking suspensions can be enumerated using hemacytometer chamber counting (Section 11.3.4), well slide counting (Section 11.3.5), or membrane filter counting (Section 11.3.6).

**11.3.1 Precision criteria.** The relative standard deviation (RSD) of the calculated mean spike dose for manually enumerated spiking suspensions must be  $\leq 16\%$  for *Cryptosporidium* and  $\leq 19\%$  for *Giardia* before proceeding (these criteria are based on the pooled RSDs of 105 manual *Cryptosporidium* enumerations and 104 manual *Giardia* enumerations submitted by 20 different laboratories under the EPA Protozoa Performance Evaluation Program).

**11.3.2 Holding time criteria.** Manually enumerated spiking suspensions must be used within 24 hours of enumeration of the spiking suspension if the hemacytometer chamber technique is used (Section 11.3.4); or within 24 hours of application of the spiking suspension or membrane filter to the slides if the well slide or membrane filter enumeration technique is used (Sections 11.3.5 and 11.3.6).

### **11.3.3 Enumerating and diluting stock suspensions**

**11.3.3.1** Purified, concentrated stock suspensions (Sections 7.10.2.1 and 7.10.2.2) must be diluted and enumerated before the diluted suspensions are used to spike samples in the laboratory. Stock suspensions should be diluted with reagent water/Tween-20, 0.01% (Section 7.10.2.3), to a concentration of 20 to 50 organisms per large hemacytometer square before proceeding to Section 11.3.3.2.

**11.3.3.2** Apply a clean hemacytometer coverslip (Section 6.4.5) to the hemacytometer and load the hemacytometer chamber with 10  $\mu\text{L}$  of vortexed suspension per chamber. If this operation has been properly executed, the liquid should amply fill the entire chamber without bubbles or overflowing into the surrounding moats. Repeat this step with a clean, dry hemacytometer and coverslip if loading has been incorrectly performed. See Section 11.3.3.13, below, for the hemacytometer cleaning procedure.

**11.3.3.3** Place the hemacytometer on the microscope stage and allow the oocysts or cysts to settle for 2 minutes. Do not attempt to adjust the coverslip, apply clips, or in any way disturb the chamber after it has been filled.

**11.3.3.4** Use 200X magnification.

**11.3.3.5** Move the chamber so the ruled area is centered underneath it.

**11.3.3.6** Move the objective close to the coverslip while watching it from the side of the microscope, rather than through the microscope.

**11.3.3.7** Focus up from the coverslip until the hemacytometer ruling appears.

**11.3.3.8** At each of the four corners of the chamber is a 1-square-mm area divided into 16 squares in which organisms are to be counted (Figure 1). Beginning with the top row of four squares, count with a hand-tally counter in the directions indicated in Figure 2. Avoid counting organisms twice by counting only those touching the top and left boundary lines. Count each square millimeter in this fashion.

**11.3.3.9** Use the following formula to determine the number of organisms per mL of suspension:

**11.3.3.10** Record the result on a hemacytometer data sheet.

**11.3.3.11** A total of six different hemacytometer chambers must be loaded, counted, and averaged for each suspension to achieve optimal counting accuracy.

**11.3.3.12** Based on the hemacytometer counts, the stock suspension should be diluted to a final concentration of between 8000 and 12,000 organisms per mL (80 to 120 organisms per 10  $\mu\text{L}$ ); however, ranges as great as 5000 to 15,000 organisms per mL (50 to 150 organisms per 10  $\mu\text{L}$ ) can be used.

**NOTE:** If the diluted stock suspensions (the spiking suspensions) will be enumerated using hemacytometer chamber counts (Section 11.3.4) or membrane filter counts (Section 11.3.6), then the stock suspensions should be diluted with 0.01% Tween-20. If the spiking suspensions will be enumerated using well slide counts (Section 11.3.3), then the stock suspensions should be diluted in reagent water.

To calculate the volume (in  $\mu\text{L}$ ) of stock suspension required per mL of reagent water (or reagent water/Tween-20, 0.01%), use the following formula:

$$\text{required number of organisms} \times 1000 \mu\text{L volume of stock suspension} (\mu\text{L}) \text{ required} = \frac{\text{number of organisms/mL of Stock suspension}}{\text{dilution factor}}$$

If the volume is less than 10  $\mu\text{L}$ , an additional dilution of the stock suspension is recommended before proceeding.

To calculate the dilution factor needed to achieve the required number of organisms per 10  $\mu\text{L}$ , use the following formula:

$$\text{Total volume} (\mu\text{L}) \text{ number of organisms required} \times 10 \mu\text{L predicted number of organisms per } 10 \mu\text{L} (80 \text{ to } 120)$$

To calculate the volume of reagent water (or reagent water/Tween-20, 0.01%) needed, use the following formula:

$$\text{reagent water volume} (\mu\text{L}) = \text{total volume} (\mu\text{L}) - \text{stock suspension volume required} (\mu\text{L})$$

11.3.3.13 After each use, the hemacytometer and coverslip must be cleaned immediately to prevent the organisms and debris from drying on it. Since this apparatus is precisely machined, abrasives cannot be used to clean it, as they will disturb the flooding and volume relationships.

11.3.3.13.1 Rinse the hemacytometer and cover glass first with tap water, then 70% ethanol, and finally with acetone.

11.3.3.13.2 Dry and polish the hemacytometer chamber and cover glass with lens paper. Store it in a secure place.

11.3.3.14 Several factors are known to introduce errors into hemacytometer counts, including:

- Inadequate mixing of suspension before flooding the chamber.
- Irregular filling of the chamber, trapped air bubbles, dust, or oil on the chamber or coverslip.
- Total number of organisms counted is too low to provide statistical confidence in the result
- Error in recording tally.
- Calculation error; failure to consider dilution factor, or area counted.
- Inadequate cleaning and removal of organisms from the previous count.
- Allowing filled chamber to sit too long, so that the chamber suspension dries and concentrates.

#### 11.3.4 Enumerating spiking suspensions using a hemacytometer chamber

**NOTE:** Spiking suspensions enumerated using a hemacytometer chamber must be used within 24 hours of enumeration.

11.3.4.1 Vortex the tube containing the spiking suspension (diluted stock suspension; Section 11.3.3) for a minimum of 2 minutes. Gently invert the tube three times.

11.3.4.2 To an appropriate-size beaker containing a stir bar, add enough spiking suspension to perform all spike testing and the enumeration as described. The liquid volume and beaker relationship should be such that a spinning stir bar does not splash the sides of the beaker, the stir bar has unimpeded rotation, and there is enough room to draw sample from the beaker with a 10- $\mu\text{L}$  micropipette without touching the stir bar. Cover the beaker with a watch glass or Petri dish to prevent evaporation between sample withdrawals.

11.3.4.3 Allow the beaker contents to stir for a minimum of 30 minutes before beginning enumeration.

11.3.4.4 While the stir bar is still spinning, remove a 10- $\mu\text{L}$  aliquot and carefully load one side of the hemacytometer. Count all organisms on the platform, at 200X magnification using phase-contrast or darkfield microscopy. The count must include the entire area under the hemacytometer, not just the four outer 1-mm<sup>2</sup> squares. Repeat this procedure nine times. This

step allows confirmation of the number of organisms per 10  $\mu\text{L}$  (Section 11.3.3.12). Based on the 10 counts, calculate the mean, standard deviation, and RSD of the counts. Record the counts and the calculations on a spiking suspension enumeration form. The relative standard deviation (RSD) of the calculated mean spike dose must be  $\leq 16\%$  for *Cryptosporidium* and  $\leq 19\%$  for *Giardia* before proceeding. If the RSD is unacceptable, or the mean number is outside the expected range, add additional oocysts from stock suspension or dilute the contents of the beaker appropriately with reagent water. Repeat the process to confirm counts. Refer to Section 11.3.3.14 for factors that may introduce errors.

#### **Enumerating spiking suspensions using well slides**

**NOTE:** Spiking suspensions enumerated using well slides must be used within 24 hours of application of the spiking suspension to the slides.

11.3.5.1 Remove well slides from cold storage and lay the slides on a flat surface for 15 minutes to allow them to warm to room temperature.

11.3.5.2 Vortex the tube containing the spiking suspension (diluted stock suspension; Section 11.3.3) for a minimum of 2 minutes. Gently invert the tube three times.

11.3.5.3 Remove a 10- $\mu\text{L}$  aliquot from the spiking suspension and apply it to the center of a well.

11.3.5.4 Before removing subsequent aliquots, cap the tube and gently invert it three times to ensure that the oocysts or cysts are in suspension.

11.3.5.5 Ten wells must be prepared and counted, and the counts averaged, to sufficiently enumerate the spike dose. Air-dry the well slides. Because temperature and humidity varies from laboratory to laboratory, no minimum time is specified. However, the laboratory must take care to ensure that the sample has dried completely before staining to prevent losses during the rinse steps. A slide warmer set at 35  $^{\circ}\text{C}$  to 42  $^{\circ}\text{C}$  also can be used.

11.3.5.6 Positive and negative controls must be prepared.

11.3.5.6.1 For the positive control, pipette 10  $\mu\text{L}$  of positive antigen or 200 to 400 intact oocysts or cysts to the center of a well and distribute evenly over the well area.

11.3.5.6.2 For the negative control, pipette 50  $\mu\text{L}$  of PBS onto the center of a well and spread it over the well area with a pipette tip.

11.3.5.6.3 Air-dry the control slides.

11.3.5.7 Apply 50- $\mu\text{L}$  of absolute methanol to each well containing the dried sample and allow to air-dry for 3 to 5 minutes.

11.3.5.8 Follow the manufacturer's instructions (Section 7.6) in applying the stain to the slide.

11.3.5.9 Place the slides in a humid chamber in the dark and incubate at room temperature for approximately 30 minutes. The humid chamber consists of a tightly sealed plastic container containing damp paper towels on top of which the slides are placed.

11.3.5.10 Apply one drop of wash buffer (prepared according to the manufacturer's instructions [Section 7.6]) to each well. Tilt each slide on a clean paper towel, long edge down. Gently aspirate the excess detection reagent from below the well using a clean Pasteur pipette or absorb with a paper towel or other absorbent material. Avoid disturbing the sample.

**NOTE:** If using the Merifluor stain (Section 7.6.1), do not allow slides to dry completely.

11.3.5.11 Add mounting medium (Section 7.8) to each well.

11.3.5.12 Apply a cover slip. Use a tissue to remove excess mounting fluid from the edges of the coverslip. Seal the edges of the coverslip onto the slide using clear nail polish.

11.3.5.13 Record the date and time that staining was completed. If slides will not be read immediately, store in a humid chamber in the dark at 0  $^{\circ}\text{C}$  to 8  $^{\circ}\text{C}$  until ready for examination.

11.3.5.14 After examination of the 10 wells, calculate the mean, standard deviation, and RSD of the 10 replicates. Record the counts and the calculations on a spiking suspension enumeration form. The relative standard deviation (RSD) of the calculated mean spike dose must be  $\leq 16\%$  for *Cryptosporidium* and  $\leq 19\%$  for *Giardia* before proceeding. If the RSD is unacceptable, or the mean number is outside the expected range, add additional oocysts from stock suspension or dilute the contents of the beaker appropriately with reagent water. Repeat the process to confirm counts.

11.3.6 Enumeration of spiking suspensions using membrane filters



**NOTE:** Spiking suspensions enumerated using membrane filters must be used within 24 hours of application of the filters to the slides.

11.3.6.1 Pre-coat the glass funnels with Sigmacote® by placing the funnel in a large Petri dish and applying 5-mL of Sigmacoat® to the funnel opening using a pipette and allowing it to run down the inside of the funnel. Repeat for all funnels to be used. The pooled Sigmacoat® may be returned to the bottle for re-use. Place the funnels at 35 °C or 41 °C for approximately 5 minutes to dry.

11.3.6.2 Place foil around the bottoms of the 100 × 15 mm Petri dishes.

11.3.6.3 Filter-sterilize (Section 6.19) approximately 10 mL of PBS pH 7.2 (Section 7.9.4). Dilute detection reagent (Section 7.7) as per manufacturer's instructions using sterile PBS. Multiply the anticipated number of filters to be stained by 100 mL to calculate total volume of stain required. Divide the total volume required by 5 to obtain the microliters of antibody necessary. Subtract the volume of antibody from the total stain volume to obtain the required microliters of sterile PBS to add to the antibody.

11.3.6.4 Label the tops of foil-covered, 60 × 15 mm Petri dishes for 10 spiking suspensions plus positive and negative staining controls and multiple filter blanks controls (one negative control, plus a blank after every five sample filters to control for carry-over). Create a humid chamber by laying damp paper towels on the bottom of a stain tray (the inverted foil-lined Petri dishes will protect filters from light and prevent evaporation during incubation).

11.3.6.5 Place a decontaminated and cleaned filter holder base (Section 6.4.8.1) into each of the three ports of the vacuum manifold (Section 6.4.8.2).

11.3.6.6 Pour approximately 10 mL of 0.01% Tween 20 into a 60 × 15 mm Petri dish.

11.3.6.7 Using forceps, moisten a 1.2-µm cellulose-acetate support membrane (Section 6.4.8.3) in the 0.01% Tween 20 and place it on the fritted glass support of one of the filter bases. Moisten a polycarbonate filter (Section

6.4.8.4) the same way and position it on top of the cellulose-acetate support membrane.

Carefully clamp the glass funnel to the loaded filter support. Repeat for the other two filters.

11.3.6.8 Add 5 mL of 0.01% Tween 20 to each of the three filtration units and allow to stand.

11.3.6.9 Vortex the tube containing the spiking suspension (diluted stock suspension; Section 11.3.3) for a minimum of 2 minutes. Gently invert the tube three times.

11.3.6.10 Using a micropipettor, sequentially remove two, 10-µL aliquots from the spiking suspension and pipet into the 5 mL of 0.01% Tween 20 standing in the unit. Rinse the pipet tip twice after each addition. Apply 10 µL of 0.01% Tween 20 to the third unit to serve as the negative control. Apply vacuum at 2" Hg and allow liquid to drain to meniscus, then close off vacuum. Pipet 10 mL of reagent water into each funnel and drain to meniscus, closing off the vacuum. Repeat the rinse and drain all fluid, close off the vacuum.

11.3.6.11 Pipet 100 mL of diluted antibody to the center of the bottom of a 60 × 15 mm Petri dish for each sample.

11.3.6.12 Unclamp the top funnel and transfer each cellulose acetate support membrane/polycarbonate filter combination onto the drop of stain using forceps (apply each membrane/filter combination to a different Petri dish containing stain). Roll the filter into the drop to exclude air. Place the small Petri dish containing the filter onto the damp towel and cover with the corresponding labeled foil-covered top. Incubate for approximately 45 minutes at room temperature.

11.3.6.13 Reclamp the top funnels, apply vacuum and rinse each three times, each time with 20 mL of reagent water.

11.3.6.14 Repeat Sections 11.3.6.4 through 11.3.6.10 for the next three samples (if that the diluted spiking suspension has sat less than 15 minutes, reduce the suspension vortex time to 60 seconds). Ten, 10-µL spiking suspension aliquots must be prepared and counted, and the counts averaged, to sufficiently enumerate the spike dose. Include a filter blank sample at a frequency of every five samples; rotate the position of filter blank to eventually include all three filter placements.

11.3.6.15 Repeat Sections 11.3.6.4 through 11.3.6.10 until the 10- $\mu$ L spiking suspensions have been filtered. The last batch should include a 10- $\mu$ L 0.01 Tween 20 blank control and 20  $\mu$ L of positive control antigen as a positive staining control.

11.3.6.16 Label slides. After incubation is complete, for each sample, transfer the cellulose acetate filter support and polycarbonate filter from drop of stain and place on fritted glass support. Cycle vacuum on and off briefly to remove excess fluid. Peel the top polycarbonate filter off the supporting filter and place on labeled slide. Discard cellulose acetate filter support. Mount and apply coverslips to the filters immediately to avoid drying.

11.3.6.17 To each slide, add 20  $\mu$ L of mounting medium (Section 7.8).

11.3.6.18 Apply a coverslip. Seal the edges of the coverslip onto the slide using clear nail polish. (Sealing may be delayed until cover slips are applied to all slides.)

11.3.6.19 Record the date and time that staining was completed. If slides will not be read immediately, store sealed slides in a closed container in the dark at 0 °C to 8 °C until ready for examination.

11.3.6.20 After examination of the 10 slides, calculate the mean, standard deviation, and RSD of the 10 replicates. Record the counts and the calculations on a spiking suspension enumeration form. The relative standard deviation (RSD) of the calculated mean spike dose must be  $\leq 16\%$  for *Cryptosporidium* and  $\leq 19\%$  for *Giardia* before proceeding. If the RSD is unacceptable, or the mean number is outside the expected range, add additional oocysts from stock suspension or dilute the contents of the beaker appropriately with reagent water. Repeat the process to confirm counts.

11.3.6.21 If oocysts or cysts are detected on the filter blanks, modify the rinse procedure to ensure that no carryover occurs and repeat enumeration.

11.4 Procedure for spiking samples in the laboratory with enumerated spiking suspensions.

11.4.1 Arrange a bottom-dispensing container to feed the filter.

11.4.2 For initial precision and recovery (Section 9.4) and ongoing precision and recovery (Section 9.7) samples, fill the container with a volume of reagent water equal to the volume of the field samples analyzed in the analytical batch. For matrix spike samples (Section 9.5), fill the container with the field sample to be spiked. Continuously mix the sample (using a stir bar and stir plate for smaller-volume samples and alternate means for larger-volume samples).

11.4.3 Vortex the spiking suspension(s) (Section 11.2 or Section 11.3) for a minimum of 2 minutes.

11.4.3.1 For flow cytometer–enumerated suspensions (where the entire volume of a spiking suspension tube will be used):

11.4.3.1.1 Add 500  $\mu$ L of the diluted antifoam to the tube containing the spiking suspension and vortex for 2 minutes.

11.4.3.1.2 Pour the suspension into the sample container.

11.4.3.1.3 Add 20 mL of reagent water to the empty tube, cap, vortex 10 seconds to rinse, and add the rinsate to the carboy.

11.4.3.1.4 Repeat this rinse using another 20 mL of reagent water.

11.4.3.1.5 Record the estimated number of organisms spiked, the date and time the sample was spiked, and the sample volume spiked on a bench sheet.

11.4.3.1.6 Proceed to Section 11.4.4.

11.4.3.2 For manually enumerated spiking suspensions:

11.4.3.2.1 Rinse a pipette tip with 0.01% Tween-20 once, then rinse with the well-mixed spiking suspension a minimum of five times before pulling an aliquot to be used to spike the container.

11.4.3.2.2 Add the spiking suspension(s) to the carboy, delivering the aliquot below the surface of the water.

11.4.3.2.3 Record the estimated number of organisms spiked, the date and time the sample was spiked, and the sample volume spiked on a bench sheet. Proceed to Section 11.4.4

11.4.4 Allow the spiking suspensions to mix for approximately 1 minute in the container.

11.4.5 Turn on the pump and allow the flow rate to stabilize. Set flow at the rate designated for the filter being used. As the carboy is depleted, check the flow rate and adjust if necessary.

11.4.6 When the water level approaches the discharge port of the carboy, tilt the container so that it is completely emptied. At that time, turn off the pump and add sufficient reagent water to the container to rinse. Swirl the contents to rinse down the sides.

11.4.7 Turn on the pump. Allow all of the water to flow through the filter and turn off the pump.

## 12.0 Sample Filtration and Elution

12.1 A water sample is filtered according to the procedures in Section 12.2. Alternate procedures may be used if the laboratory first demonstrates that the alternate procedure provides equivalent or superior performance per Section 9.1.2.

**NOTE:** Sample elution must be initiated within 96 hours of sample collection (if shipped to the laboratory as a bulk sample) or filtration (if filtered in the field).

**12.2 Capsule filtration** (adapted from Reference 20.9). This procedure was validated using 10-L sample volumes. Alternate sample volumes may be used, provided the laboratory demonstrates acceptable performance on initial and ongoing spiked reagent water and source water samples (Section 9.1.2).

**NOTE:** The filtration procedures specified in Section 12.2.1 - 12.2.5.3 are specific to laboratory filtration of a bulk sample, and reflect the procedures used during the interlaboratory validation of this method (Reference 20.10). These procedures may require modification if samples will be filtered in the field.

### 12.2.1 Flow rate adjustment

12.2.1.1 Connect the sampling system, minus the capsule, to a carboy filled with reagent water (Figure 3).

12.2.1.2 Turn on the pump and adjust the flow rate to 2.0 L/min.

12.2.1.3 Allow 2 to 10 L of reagent water to flush the system. Adjust the pump speed as required during this period. Turn off the pump when the flow rate has been adjusted.

12.2.2 Install the capsule filter in the line, securing the inlet and outlet ends with the appropriate clamps/fittings.

12.2.3 Record the sample number, sample turbidity (if not provided with the field sample), sample type, and sample filtration start date and time on a bench sheet.

### 12.2.4 Filtration

12.2.4.1 Connect the sampling system to the field carboy of sample water, or transfer the sample water to the laboratory carboy used in Section

12.2.1.1. If the sample will be filtered from a field carboy, a spigot (Section 6.2.1) can be used with the carboy to facilitate sample filtration.

**NOTE:** If the bulk field sample is transferred to a laboratory carboy, the laboratory carboy must be cleaned and disinfected before it is used with another field sample.

12.2.4.2 Place the drain end of the sampling system tubing into an empty graduated container with a capacity of 10 to 15 L, calibrated at 9.0, 9.5, 10.0, 10.5, and 11.0 L (Section 6.18). This container will be used to determine the sample volume filtered. Alternately, connect a flow meter (Section 6.3.4) downstream of the filter, and record the initial meter reading.

12.2.4.3 Allow the carboy discharge tube and capsule to fill with sample water. Vent residual air using the bleed valve/vent port, gently shaking or tapping the capsule, if necessary. Turn on the pump to start water flowing through the filter. Verify that the flow rate is 2 L/min.

12.2.4.4 After all of the sample has passed through the filter, turn off the pump. Allow the pressure to decrease until flow stops. (If the sample was filtered in the field, and excess sample remains in the filter upon receipt in the laboratory, pull the remaining sample volume through the filter before eluting the filter [Section 12.2.6].)

### 12.2.5 Disassembly

12.2.5.1 Disconnect the inlet end of the capsule filter assembly while maintaining the level of the inlet fitting above the level of the outlet fitting to prevent backwashing and the loss of oocysts and

cysts from the filter. Restart the pump and allow as much water to drain as possible. Turn off the pump.

12.2.5.2 Based on the water level in the graduated container or meter reading, record the volume filtered on the bench sheet to the nearest quarter liter. Discard the contents of the graduated container.

12.2.5.3 Loosen the outlet fitting, then cap the inlet and outlet fittings.

### **12.2.6 Elution**

**NOTE:** The laboratory must complete the elution, concentration, and purification (Sections 12.2.6 through 13.3.3.11) in one work day. It is critical that these steps be completed in one work day to minimize the time that any target organisms present in the sample sit in eluate or concentrated matrix. This process ends with the application of the purified sample on the slide for drying.

#### **12.2.6.1 Setup**

12.2.6.1.1 Assemble the laboratory shaker with the clamps aligned vertically so that the filters will be aligned horizontally. Extend the clamp arms to their maximum distance from the horizontal shaker rods to maximize the shaking action.

12.2.6.1.2 Prepare sufficient elution buffer so that all samples to be eluted that day can be eluted with the same batch of buffer. Elution may require up to 275 mL of buffer per sample.

12.2.6.1.3 Designate at least one 250-mL conical centrifuge tube for each sample and label with the sample number.

#### **12.2.6.2 Elution**

**12.2.6.2.1** Record the elution date and time on the bench sheet. Using a ring stand or other means, clamp each capsule in a vertical position with the inlet end up. Remove the inlet cap and allow the liquid level to stabilize.

**12.2.6.2.2** Pour elution buffer through the inlet fitting. Sufficient elution buffer must be added to cover the pleated white membrane with buffer solution. Replace the inlet cap and clamp the cap in place.

**12.2.6.2.3** Securely clamp the capsule in one of the clamps on the laboratory shaker with the bleed valve positioned at the top on a vertical axis (in the 12 o'clock position). Turn on the shaker and set the speed to maximum (approximately 900 rpm). Agitate the capsule for approximately 5 minutes. Time the agitation using a lab timer, rather than the timer on the shaker to ensure accurate time measurement.

**12.2.6.2.4** Remove the filter from the shaker, remove the inlet cap, and pour the contents of the capsule into the 250-mL conical centrifuge tube.

**12.2.6.2.5** Clamp the capsule vertically with the inlet end up and add sufficient volume of elution buffer through the inlet fitting to cover the pleated membrane. Replace the inlet cap.

**12.2.6.2.6** Return the capsule to the shaker with the bleed valve positioned at the 4 o'clock position. Turn on the shaker and agitate the capsule for approximately 5 minutes.

**12.2.6.2.7** Remove the filter from the shaker, but leave the elution buffer in the capsule. Re-clamp the capsule to the shaker at the 8 o'clock position. Turn on the shaker and agitate the capsule for a final 5 minutes.

**12.2.6.2.8** Remove the filter from the shaker and pour the contents into the 250-mL centrifuge tube. Rinse down the inside of the capsule filter walls with reagent water or elution buffer using a squirt bottle inserted in the inlet end of the capsule. Invert the capsule filter over the centrifuge tube and ensure that as much of the eluate as possible has been transferred.

**12.2.7** Proceed to Section 13.0 for concentration and separation (purification).

### **13.0 Sample Concentration and Separation (Purification)**

**13.1** During concentration and separation, the filter eluate is concentrated through centrifugation, and the oocysts and cysts in the sample are separated from other particulates through immunomagnetic separation (IMS). Alternate procedures and products may be used if the laboratory first demonstrates equivalent or superior performance as per Section 9.1.2.

### **13.2 Adjustment of pellet volume**

13.2.1 Centrifuge the 250-mL centrifuge tube containing the capsule filter eluate at 1500 × G for 15 minutes. Allow the centrifuge to coast to a stop—do not use the brake. Record the pellet volume (volume of solids) on the bench sheet.

**NOTE:** Recoveries may be improved if centrifugation force is increased to 2000 × G. However, do not use this higher force if the sample contains sand or other gritty material that may degrade the condition of any oocysts and/or cysts in the sample.

13.2.2 Using a Pasteur pipette, carefully aspirate the supernatant to 5 mL above the pellet. Extra care must be taken to avoid aspirating oocysts and cysts during this step, particularly if the sample is reagent water (e.g. initial or ongoing precision and recovery sample).

13.2.3 If the packed pellet volume is ≤ 0.5 mL, vortex the tube vigorously until pellet is completely resuspended. Swirl the centrifuge tube gently to reduce any foaming after vortexing. Record the resuspended pellet volume on the bench sheet. Proceed to Section 13.3.

**NOTE:** Extra care must be taken with samples containing sand or other gritty material when vortexing to ensure that the condition of any oocysts and/or cysts in the sample is not compromised.

13.2.4 If the packed pellet volume is > 0.5 mL, the concentrate needs to be separated into multiple subsamples (a subsample is equivalent to no greater than 0.5 mL of packed pellet material, the recommended maximum amount of particulate material to process through the subsequent purification and examination steps in the method). Use the following formula to determine the total volume required in the centrifuge tube before separating the concentrate into two or more subsamples:

$$\text{total volume (mL) required} = \frac{\text{pellet volume}}{0.5 \text{ mL}} \times 5 \text{ mL}$$

(For example, if the packed pellet volume is 1.2 mL, the total volume required is 12 mL.) Add reagent water to the centrifuge tube to bring the total volume to the level calculated above. Vortex the tube vigorously for 10 to 15 seconds to completely resuspend the pellet. Record the resuspended pellet volume on the bench sheet.

**NOTE:** Extra care must be taken with samples containing sand or other gritty material when vortexing to ensure that the condition of any oocysts in the sample is not compromised.

13.2.4.1 Analysis of entire sample. If analysis of the entire sample is required, determine the number of subsamples to be processed independently through the remainder of the method:

13.2.4.1.1 Calculate number of subsamples: Divide the total volume in the centrifuge tube by 5 mL and round up to the nearest integer (for example, if the resuspended volume in Section 13.2.4 is 12 mL, then the number of subsamples would be 12 mL / 5 mL = 2.4, rounded = 3 subsamples).

13.2.4.1.2 Determine volume of resuspended concentrate per subsample. Divide the total volume in the centrifuge tube by the calculated number of subsamples (for

13.2.4.1.3 example, if the resuspended volume in Section 13.2.4 is 12 mL, then the volume to use for each subsample = 12 mL / 3 subsamples = 4 mL).

Process sub-samples through IMS. Proceed to Section 13.3, and transfer aliquots of the resuspended concentrate equivalent to the volume in the previous step to multiple, flat-sided sample tubes in Section 13.3.2.1. Process the sample as multiple, independent subsamples from Section 13.3 onward, including the preparation and examination of separate slides for each aliquot. Record the volume of resuspended concentrate transferred to IMS on the bench sheet (this will be equal to the volume recorded in Section 13.2.4). Also record the number of subsamples processed independently through the method on the bench sheet.

13.2.4.2 Analysis of partial sample. If not all of the concentrate will be examined, proceed to Section 13.3, and transfer one or more 5-mL aliquots of the resuspended concentrate to one or more flat-sided sample tubes in Section 13.3.2.1. Record the volume of resuspended concentrate transferred

to IMS on the bench sheet. To determine the volume analyzed, calculate the percent of the concentrate examined using the following formula:

$$\text{percent examined} = \frac{\text{total volume of resuspended concentrate transferred to IMS}}{\text{total volume of resuspended concentrate in Section 13.2.4}} \times 100\%$$

Then multiply the volume filtered (Section 12.2.5.2) by this percentage to determine the volume analyzed.

### 13.3 IMS procedure (adapted from Reference 20.11)

**NOTE:** The IMS procedure should be performed on a bench top with all materials at room temperature, ranging from 15 °C to 25 °C.

#### 13.3.1 Preparation and addition of reagents

13.3.1.1 Prepare a 1X dilution of SL-buffer-A from the 10X SL-buffer-A (clear, colorless solution) supplied. Use reagent water (demineralized; Section 7.3) as the diluent. For every 1 mL of 1X SL-buffer-A required, take 100 µL of 10X SL-buffer-A and make up to 1 mL with the diluent water. A volume of 1.5 mL of 1X SL-buffer-A will be required per sample or subsample on which the Dynal IMS procedure is performed.

13.3.1.2 For each sample or subsample (Section 13.2) to be processed through IMS, add 1 mL of the 10X SL-buffer-A (supplied—not the diluted 1X SL-buffer-A) to a flat-sided tube (Section 6.5.4).

13.3.1.3 For each subsample, add 1 mL of the 10X SL-buffer-B (supplied—magenta solution) to the flat-sided tube containing the 10X SL-buffer-A.

#### 13.3.2 Oocyst and cyst capture

13.3.2.1 Use a graduated, 10-mL pipette that has been pre-rinsed with elution buffer to transfer the water sample concentrate from Section 13.2 to the flat-sided tube(s) containing the SL-buffer. If all of the concentrate is used, rinse the centrifuge tube twice with reagent water and add the rinsate to the flat-sided tube containing the concentrate (or to the tube containing the first subsample, if multiple subsamples will be processed). Each of the two rinses should be half the volume needed to bring the total volume in the flat-sided sample tube to 10 mL. (For example, if 5 mL was transferred after resuspension of the pellet, the centrifuge tube would be rinsed twice with 2.5 mL of reagent water to bring the total volume in the flat-sided tube to 10 mL.) Visually inspect the centrifuge tube after completing the transfer to ensure that no concentrate remains. If multiple subsamples will be processed, bring the volume in the remaining flat-sided tubes to 10 mL with reagent water. Label the flat-sided tube(s) with the sample number (and subsample letters).

13.3.2.2 Vortex the Dynabeads®Crypto-Combo vial from the IMS kit for approximately 10 seconds to suspend the beads. Ensure that the beads are fully resuspended by inverting the sample tube and making sure that there is no residual pellet at the bottom.

13.3.2.3 Add 100 µL of the resuspended Dynabeads®Crypto-Combo (Section 13.3.2.2) to the sample tube(s) containing the water sample concentrate and SL-buffer.

13.3.2.4 Vortex the Dynabeads®Giardia-Combo vial from the IMS kit for approximately 10 seconds to suspend the beads. Ensure that the beads are fully resuspended by inverting the tube and making sure that there is no residual pellet at the bottom.

13.3.2.5 Add 100 µL of the resuspended Dynabeads®Giardia-Combo (Section 13.3.2.4) to the sample tube(s) containing the water sample concentrate, Dynabeads®Crypto-Combo, and SL-buffer.

13.3.2.6 Affix the sample tube(s) to a rotating mixer and rotate at approximately 18 rpm for 1 hour at room temperature.

13.3.2.7 After rotating for 1 hour, remove each sample tube from the mixer and place the tube in the magnetic particle concentrator (MPC-1) with flat side of the tube toward the magnet.

13.3.2.8 Without removing the sample tube from the MPC-1, place the magnet side of the MPC-1 downwards, so the tube is horizontal and the flat side of the tube is facing down.

**13.3.2.9** Gently rock the sample tube by hand end-to-end through approximately 90°, tilting the cap-end and base-end of the tube up and down in turn. Continue the tilting action for 2 minutes with approximately one tilt per second.

**13.3.2.10** Ensure that the tilting action is continued throughout this period to prevent binding of low-mass, magnetic or magnetizable material. If the sample in the MPC-1 is allowed to stand motionless for more than 10 seconds, repeat Section 13.3.2.9 before continuing to Section 13.3.2.11.

**13.3.2.11** Return the MPC-1 to the upright position, sample tube vertical, with cap at top. Immediately remove the cap and, keeping the flat side of the tube on top, pour off all of the supernatant from the tube held in the MPC-1 into a suitable container. Do not shake the tube and do not remove the tube from MPC-1 during this step.

**13.3.2.12** Remove the sample tube from the MPC-1 and resuspend the sample in 1-mL 1X SL-buffer-A (prepared from 10X SL-buffer-A stock—supplied). Mix very gently to resuspend all material in the tube. Do not vortex.

**13.3.2.13** Quantitatively transfer (transfer followed by two rinses) all the liquid from the sample tube to a labeled, 1.5-mL microcentrifuge tube. Use 1 mL of 1X SL-buffer-A to perform the first rinse and 0.5 mL of reagent water for the second rinse. Liberally rinse down the sides of the Leighton tube before transferring. Allow the flat-sided sample tube to sit for a minimum of 1 minute after transfer of the second rinse volume, then use a pipette to collect any residual volume that drips down to the bottom of the tube to ensure that as much sample volume is recovered as possible. Ensure that all of the liquid and beads are transferred.

**13.3.2.14** Place the microcentrifuge tube into the second magnetic particle concentrator (MPC-M), with its magnetic strip in place.

**13.3.2.15** Without removing the microcentrifuge tube from MPC-M, gently rock/roll the tube through 180° by hand. Continue for approximately 1 minute with approximately one 180° roll/rock per second. At the end of this step, the beads should produce a distinct brown dot at the back of the tube.

**13.3.2.16** Immediately aspirate the supernatant from the tube and cap held in the MPC-M. If more than one sample is being processed, conduct three 90° rock/roll actions before removing the supernatant from each tube. Take care not to disturb the material attached to the wall of the tube adjacent to the magnet. Do not shake the tube. Do not remove the tube from MPC-M while conducting these steps.

### **13.3.3 Dissociation of beads/oocyst/cyst complex**

**NOTE:** Two acid dissociations are required.

**13.3.3.1** Remove the magnetic strip from the MPC-M.

**13.3.3.2** Add 50 µL of 0.1 N HCl, then vortex at the highest setting for approximately 50 seconds.

**NOTE:** The laboratory should use 0.1-N standards purchased directly from a vendor, rather than adjusting the normality in-house.

**13.3.3.3** Place the tube in the MPC-M without the magnetic strip in place and allow to stand in a vertical position for at least 10 minutes at room temperature.

**13.3.3.4** Vortex vigorously for approximately 30 seconds.

**13.3.3.5** Ensure that all of the sample is at the base of the tube. Place the microcentrifuge tube in the MPC-M.

**13.3.3.6** Replace magnetic strip in MPC-M and allow the tube to stand undisturbed for a minimum of 10 seconds.

**13.3.3.7** Prepare a well slide for sample screening and label the slide.

**13.3.3.8** Add 5 µL of 1.0 N NaOH to the sample wells of two well slides (add 10 µL to the sample well of one well slide if the volume from the two required dissociations will be added to the same slide).

**NOTE:** The laboratory should use 1.0-N standards purchased directly from a vendor rather than adjusting the normality in-house.

**13.3.3.9** Without removing the microcentrifuge tube from the MPC-M, transfer all of the sample from the microcentrifuge tube in the MPC-M to the sample well with the NaOH. Do not disturb the beads at the back wall of the tube. Ensure that all of the fluid is transferred.

**13.3.3.10** Do not discard the beads or microcentrifuge tube after transferring the volume from the first acid dissociation to the well slide. Perform the steps in Sections 13.3.3.1 through 13.3.3.9 a second time. The volume from the second dissociation can be added to the slide containing the volume from the first dissociation, or can be applied to a second slide.

**NOTE:** If one slide is used, exert extra care when using Dynal Spot-On slides to ensure that the sample stays within the smaller-diameter wells on these slides.

**13.3.3.11** Record the date and time the purified sample was applied to the slide(s).

**13.3.3.12** Air-dry the sample on the well slide(s). Because temperature and humidity varies from laboratory to laboratory, no minimum time is specified. However, the laboratory must take care to ensure that the sample has dried completely before staining to prevent losses during the rinse steps. A slide warmer set at 35 °C to 42 °C also can be used.

#### **14.0 Sample Staining**

**NOTE:** The sample must be stained within 72 hours of application of the purified sample to the slide.

##### **14.1 Prepare positive and negative controls.**

14.1.1 For the positive control, pipette 10 µL of positive antigen or 200 to 400 intact oocysts and 200 to 400 cysts to the center of a well.

14.1.2 For the negative control, pipette 50 µL of 150 mM PBS (Section 7.6.4) into the center of a well and spread it over the well area with a pipette tip.

14.1.3 Air-dry the control slides (see Section 13.3.3.12 for guidance).

14.2 Apply 50-µL of absolute methanol to each well containing the dried sample and allow to air-dry for 3 to 5 minutes.

14.3 Follow manufacturer's instructions in applying stain to slide.

14.4 Place the slides in a humid chamber in the dark and incubate at room temperature for approximately 30 minutes. The humid chamber consists of a tightly sealed plastic container containing damp paper towels on top of which the slides are placed.

14.5 Apply one drop of wash buffer (prepared according to the manufacturer's instructions [Section 7.6]) to each well. Tilt each slide on a clean paper towel, long edge down. Gently aspirate the excess detection reagent from below the well using a clean Pasteur pipette or absorb with paper towel or other absorbent material placed at edge of slide. Avoid disturbing the sample.

**NOTE:** If using the Merifluor stain (Section 7.6.1), do not allow slides to dry completely.

14.6 Apply 50 µL of 4',6-diamidino-2-phenylindole (DAPI) staining solution (Section 7.7.2) to each well. Allow to stand at room temperature for a minimum of 1 minute. (The solution concentration may be increased up to 1 µg /mL if fading/diffusion of DAPI staining is encountered, but the staining solution must be tested first on expendable environmental samples to confirm that staining intensity is appropriate.)



14.7 Apply one drop of wash buffer (prepared according to the manufacturer's instructions [Section 7.6]) to each well. Tilt each slide on a clean paper towel, long edge down. Gently aspirate the excess DAPI staining solution from below the well using a clean Pasteur pipette or absorb with paper towel or other absorbent material placed at edge of slide. Avoid disturbing the sample.

**NOTE:** If using the Merifluor stain (Section 7.6.1), do not allow slides to dry completely.

14.8 Add mounting medium (Section 7.8) to each well.

14.9 Apply a cover slip. Use a tissue to remove excess mounting fluid from the edges of the coverslip. Seal the edges of the coverslip onto the slide using clear nail polish.

14.10 Record the date and time that staining was completed on the bench sheet. If slides will not be read immediately, store in a humid chamber in the dark at 0 °C to 8 °C until ready for examination.

## 15.0 Examination

**NOTE:** Although immunofluorescence assay (FA) and 4',6-diamidino-2-phenylindole (DAPI) and differential interference contrast (DIC) microscopy examination and confirmation should be performed immediately after staining is complete, laboratories have up to 7 days from completion of sample staining to complete the examination and confirmation of samples. However, if fading/diffusion of FITC or DAPI staining is noticed, the laboratory must reduce this holding time. In addition the laboratory may adjust the concentration of the DAPI staining solution (Sections 7.7.2) so that fading/diffusion does not occur.

**15.1 Scanning technique:** Scan each well in a systematic fashion. An up-and-down or a side-to-side scanning pattern may be used (Figure 4).

**15.2 Examination using immunofluorescence assay (FA), 4',6-diamidino-2-phenylindole (DAPI) staining characteristics, and differential interference contrast (DIC) microscopy.** The minimum magnification requirements for each type of examination are noted below.

**NOTE:** All shape and measurements must be determined using 1000X magnification and reported to the nearest 0.5 µm.

Record examination results for *Cryptosporidium* oocysts on a *Cryptosporidium* report form; record examination results for *Giardia* cysts on a *Giardia* report form. All oocysts and cysts that meet the criteria specified in Sections 15.2.2 and 15.2.3, less atypical organisms specifically identified as non-target organisms by DIC or DAPI (e.g. possessing spikes, stalks, appendages, pores, one or two large nuclei filling the cell, red fluorescing chloroplasts, crystals, spores, etc.), must be reported.

**15.2.1 Positive and negative staining control.**

**15.2.1.1** Each analyst must characterize a minimum of three *Cryptosporidium* oocysts and three *Giardia* cysts on the positive staining control slide before examining field sample slides. This characterization must be performed by each analyst during each microscope examination session.

FITC examination must be conducted at a minimum of 200X total magnification, DAPI examination must be conducted at a minimum of 400X, and DIC examination must be conducted at a minimum of 1000X. Size, shape, and DIC and DAPI characteristics of the three *Cryptosporidium* oocysts and *Giardia* cysts must be recorded by the analyst on a microscope log. The analyst also must indicate on each sample report form whether the positive staining control was acceptable.

**15.2.1.2** Examine the negative staining control to confirm that it does not contain any oocysts or cysts (Section 14.1). Indicate on each sample report form whether the negative staining control was acceptable.

**15.2.1.3** If the positive staining control contains oocysts and cysts within the expected range and at the appropriate fluorescence for both FA and DAPI, and the negative staining control does not contain any oocysts or cysts (Section 14.1), proceed to Sections 15.2.2 and 15.2.3.

### **15.2.2 Sample examination—Cryptosporidium**

**15.2.2.1** FITC examination (the analyst must use a minimum of 200X total magnification). Use epifluorescence to scan the entire well for apple-green fluorescence of oocyst and cyst shapes. When brilliant apple-green fluorescing ovoid or spherical objects 4 to 6 µm in diameter are observed with brightly highlighted edges, increase magnification to 400X and switch the microscope to the UV filter block for DAPI (Section 15.2.2.2), then to DIC (Section 15.2.2.3).

**15.2.2.2** DAPI examination (the analyst must use a minimum of 400X total magnification). Using the UV filter block for DAPI, the object will exhibit one of the following characteristics: (a) Light blue internal staining (no distinct nuclei) with a green rim (b) Intense blue internal staining (c) Up to four distinct, sky-blue nuclei Record oocysts in category (a) as DAPI negative; record oocysts in categories (b) and (c) as DAPI positive.

**15.2.2.3** DIC examination (the analyst must use a minimum of 1000X total magnification). Using DIC, look for external or internal morphological characteristics atypical of Cryptosporidium oocysts (e.g., spikes, stalks, appendages, pores, one or two large nuclei filling the cell, red fluorescing chloroplasts, crystals, spores, etc.) (adapted from Reference 20.6). If atypical structures are not observed, then categorize each apple-green fluorescing object as: (a) An empty Cryptosporidium oocyst (b) A Cryptosporidium oocyst with amorphous structure (c) A Cryptosporidium oocyst with internal structure (one to four sporozoites/oocyst) Using 1000X total magnification, record the shape, measurements (to the nearest 0.5 µm ), and number of sporozoites (if applicable) for each apple-green fluorescing object meeting the size and shape characteristics. Although not a defining characteristic, surface oocyst folds may be observed in some specimens.

**NOTE:** All measurements must be made at 1000X magnification.

### **15.2.3 Sample examination—Giardia**

**15.2.3.1** FITC examination (the analyst must use a minimum of 200X total magnification). When brilliant apple-green fluorescing round to oval objects (8 - 18 µm long by 5 - 15 µm wide) are observed, increase magnification to 400X and switch the microscope to the UV filter block for DAPI (Section 15.2.3.2) then to DIC (Section 15.2.3.3).

**15.2.3.2** DAPI examination (the analyst must use a minimum of 400X total magnification). Using the UV filter block for DAPI, the object will exhibit one or more of the following characteristics: (a) Light blue internal staining (no distinct nuclei) and a green rim (b) Intense blue internal staining (c) Two to four sky-blue nuclei Record cysts in category (a) as DAPI negative; record cysts in categories (b) and (c) as DAPI positive.

**15.2.3.3** DIC examination (the analyst must use a minimum of 1000X total magnification). Using DIC, look for external or internal morphological characteristics atypical of Giardia cysts (e.g., spikes, stalks, appendages, pores, one or two large nuclei filling the cell, red fluorescing chloroplasts, crystals, spores, etc.) (adapted from Reference 20.6). If atypical structures are not observed, then categorize each object meeting the criteria specified in Sections 15.2.3.1 - 15.2.3.3 as one of the following, based on DIC examination: (a) An empty Giardia cyst (b) A Giardia cyst with amorphous structure (c) A Giardia cyst with one type of internal structure (nuclei, median body, or axonemes), or (d) A Giardia cyst with more than one type of internal structure.

Using 1000X total magnification, record the shape, measurements (to the nearest 0.5 µm ), and number of nuclei and presence of median body or axonemes (if applicable) for each apple-green fluorescing object meeting the size and shape characteristics.

**NOTE:** All measurements must be made at 1000X magnification.

**15.2.4** Record the date and time that sample examination was completed on the report form.

**15.2.5** Report Cryptosporidium and Giardia concentrations as oocysts/L and cysts/L.

## **16.0 Analysis of Complex Samples**

**16.1** Some samples may contain high levels (>1000/L) of oocysts and cysts and/or interfering organisms, substances, or materials. Some samples may clog the filter (Section 12.0); others will not allow separation of the oocysts and cysts from the retentate or eluate; and others may contain materials that preclude or confuse microscopic examination.

**16.2** If the sample holding time has not been exceeded and a full-volume sample cannot be filtered, dilute an aliquot of sample with reagent water and filter this smaller aliquot (Section 12.0). This dilution must be recorded and reported with the results.

**16.3** If the holding times for the sample and for microscopic examination of the cleaned up retentate/eluate have been exceeded, the site should be re-sampled. If this is not possible, the results should be qualified accordingly.

## **17.0 Method Performance**

**17.1** Method acceptance criteria are shown in Tables 3 and 4 in Section 21.0. The initial and ongoing precision and recovery criteria are based on the results of spiked reagent water samples analyzed during the Information Collection Rule Supplemental Surveys (Reference 20.12). The matrix spike and matrix spike duplicate criteria are based on spiked source water data generated during the interlaboratory validation study of Method 1623 involving 11 laboratories and 11 raw surface water matrices across the U.S. (Reference 20.10).

**NOTE:** Some sample matrices may prevent the MS acceptance criteria in Tables 3 and 4 to be met. An assessment of the distribution of MS recoveries across 430 MS samples from 87 sites during the ICR Supplemental Surveys is provided in Table 5.

## **18.0 Pollution Prevention**

**18.1** The solutions and reagents used in this method pose little threat to the environment when recycled and managed properly.

**18.2** Solutions and reagents should be prepared in volumes consistent with laboratory use to minimize the volume of expired materials to be disposed.

## **19.0 Waste Management**

**19.1** It is the laboratory's responsibility to comply with all federal, state, and local regulations governing waste management, particularly the biohazard and hazardous waste identification rules and land disposal restrictions, and to protect the air, water, and land by minimizing and controlling all releases from fume hoods and bench operations. Compliance with all sewage discharge permits and regulations is also required. An overview of these requirements can be found in the *Environmental Management Guide for Small Laboratories* (EPA 233-B-98-001).

**19.2** Samples, reference materials, and equipment known or suspected to have viable oocysts or cysts attached or contained must be sterilized prior to disposal.

**19.3** For further information on waste management, consult *The Waste Management Manual for Laboratory Personnel* and *Less is Better: Laboratory Chemical Management for Waste Reduction*, both available from the American Chemical Society's Department of Government Relations and Science Policy, 1155 16th Street N.W., Washington, D.C. 20036.

## 20.0 References

- 20.1** Rodgers, Mark R., Flanigan, Debbie J., and Jakubowski, Walter, 1995. *Applied and Environmental Microbiology* 61 (10), 3759-3763.
- 20.2** Fleming, Diane O., et al.(eds.), *Laboratory Safety: Principles and Practices*, 2nd edition.1995. ASM Press, Washington, DC
- 20.3** "Working with Carcinogens," DHEW, PHS, CDC, NIOSH, Publication 77-206, (1977).
- 20.4** "OSHA Safety and Health Standards, General Industry," OSHA 2206, 29 *CFR* 1910 (1976).
- 20.5** "Safety in Academic Chemistry Laboratories," ACS Committee on Chemical Safety (1979).
- 20.6** *ICR Microbial Laboratory Manual*, EPA/600/R-95/178, National Exposure Research Laboratory, Office of Research and Development, U.S. Environmental Protection Agency, 26 Martin Luther King Drive, Cincinnati, OH 45268 (1996).
- 20.7** USEPA. *EPA Guide to Method Flexibility and Approval of EPA Water Methods*, EPA 821-D-96-004. Office of Water, Engineering and Analysis Division, Washington, DC 20460 (1996).
- 20.8** Connell, K., C.C. Rodgers, H.L. Shank-Givens, J Scheller, M.L Pope, and K. Miller, 2000. Building a Better Protozoa Data Set. *Journal AWWA*, 92:10:30.
- 20.9** "Envirochek™ Sampling Capsule," PN 32915, Gelman Sciences, 600 South Wagner Road, Ann Arbor, MI 48103-9019 (1996).
- 20.10** USEPA. Results of the Interlaboratory Method Validation Study for Determination of Cryptosporidium and Giardia Using USEPA Method 1623, EPA-821-R-01-028. Office of Water, Office of Science and Technology, Engineering and Analysis Division, Washington, DC (2001).
- 20.11** "Dynabeads® GC-Combo," Dynal Microbiology R&D, P.O. Box 8146 Dep., 0212 Oslo, Norway (September 1998, Revision no. 01).
- 20.12** USEPA. Implementation and Results of the Information Collection Rule Supplemental Surveys. EPA-815-R-01-003. Office of Water, Office of Ground Water and Drinking Water, Standards and Risk Management Division, Washington, DC (2001).
- 20.13** Connell, K., J. Scheller, K. Miller, and C.C. Rodgers, 2000. Performance of Methods 1622 and 1623 in the ICR Supplemental Surveys. Proceedings, American Water Works Association Water Quality Technology Conference, November 5 - 9, 2000, Salt Lake City, UT.

## 21.0 Tables and Figures

Table 1. Method Holding Times (See Section 8.2 for details)

**Table 2. Tier 1 and Tier 2 Validation/Equivalency Demonstration Requirements**

Test	Descriptio	Tier 1 modification(1)	Tier 2 modification(2)
IPR (Section 9.5)	4 replicates of spiked reagent water	Required. Must be accompanied by a method blank.	Required per laboratory
Method blank (Section 9.6)	Unspiked reagent water	Required	Required per laboratory
MS (Section 9.5)	Spiked matrix water	Required on each water to which the modification will be applied and on every sample of that water thereafter. Must be accompanied by an unspiked field sample collected at the same time as the MS sample.	Not required
MS/MSD (Section 9.5)	2 replicates of spiked matrix water	Recommended, but not required. Must be accompanied by an unspiked field sample collected at the same time as the MS sample.	Required per laboratory laboratory must analyze different water.

(1) If a modification will be used only in one laboratory, these tests must be performed and the results must meet all of the QC acceptance criteria in the method (these tests also are required the first time a laboratory uses the validated version of the method).

(2) If nationwide approval of a modification is sought for one type of water matrix (such as surface water), a minimum of 3 laboratories must perform the tests and the results from each lab individually must meet all QC acceptance criteria in the method. If more than 3 laboratories are used in a study, a minimum of 75% of the laboratories must meet all QC acceptance criteria.

**NOTE:** The initial precision and recovery and ongoing precision and recovery (OPR) acceptance criteria listed in Tables 3 and 4 are based on results from 293 *Cryptosporidium* OPR samples and 186 *Giardia* OPR samples analyzed by six laboratories during the Information Collection Rule Supplemental Surveys (Reference 20.12). The matrix spike acceptance criteria are based on data generated through interlaboratory validation of Method 1623 (Reference 20.10).

**Table 3. Quality Control Acceptance Criteria for *Cryptosporidium***

Performance test	Section	Acceptance criteria
	9.4 9.4.2 9.4.2	
Initial precision and recovery Mean recovery (percent) Precision (as maximum relative standard deviation)		24 - 100 55
Ongoing precision and recovery (percent)	9.7	11 - 100
Matrix spike/matrix spike duplicate (for method modifications) Mean recovery <sup>1, 2</sup> (as percent) Precision (as maximum relative percent difference)	9.5 9.5.2 9.5.2	13 - 111 61

(1) The acceptance criteria for mean MS/MSD recovery serves as the acceptance criteria for MS recovery during routine use of the method (Section 9.5.1).

(2) Some sample matrices may prevent the acceptance criteria from being met. An assessment of the distribution of MS recoveries from multiple MS samples from 87 sites during the ICR Supplemental Surveys is provided in Table 5.

**Table 4. Quality Control Acceptance Criteria for *Giardia***

Quality Control Acceptance Criteria for <i>Giardia</i> Performance test	Section	Acceptance criteria
	9.4 9.4.2 9.4.2	
Initial precision and recovery Mean recovery (percent) Precision (as maximum relative standard deviation)		24 - 100 49
Ongoing precision and recovery (percent)	9.7	14 - 100
Matrix spike/matrix spike duplicate (for method modifications) Mean recovery* (as percent) Precision (as maximum relative percent difference)	9.5 9.5.2 9.5.2	15 - 118 30

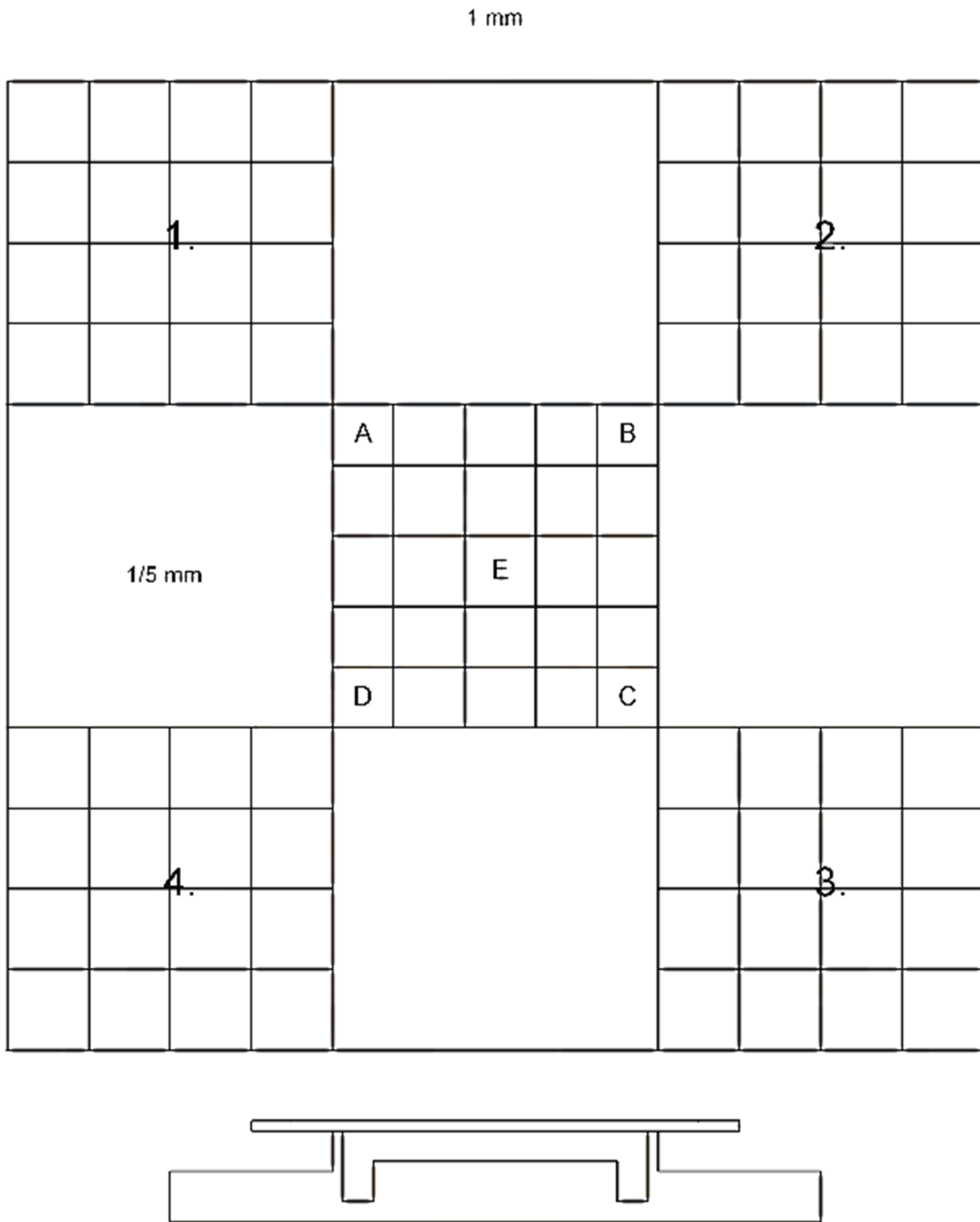
(1) The acceptance criteria for mean MS/MSD recovery serves as the acceptance criteria for MS recovery during routine use of the method (Section 9.5.1).

(2) Some sample matrices may prevent the acceptance criteria from being met. An assessment of the distribution of MS recoveries across multiple MS samples from 87 sites during the ICR Supplemental Surveys is provided in Table 5.

**Table 5. Distribution of Matrix Spike Recoveries from Multiple Samples Collected from 87 Source Waters During the ICR Supplemental Surveys (Adapted from Reference 20.13)**

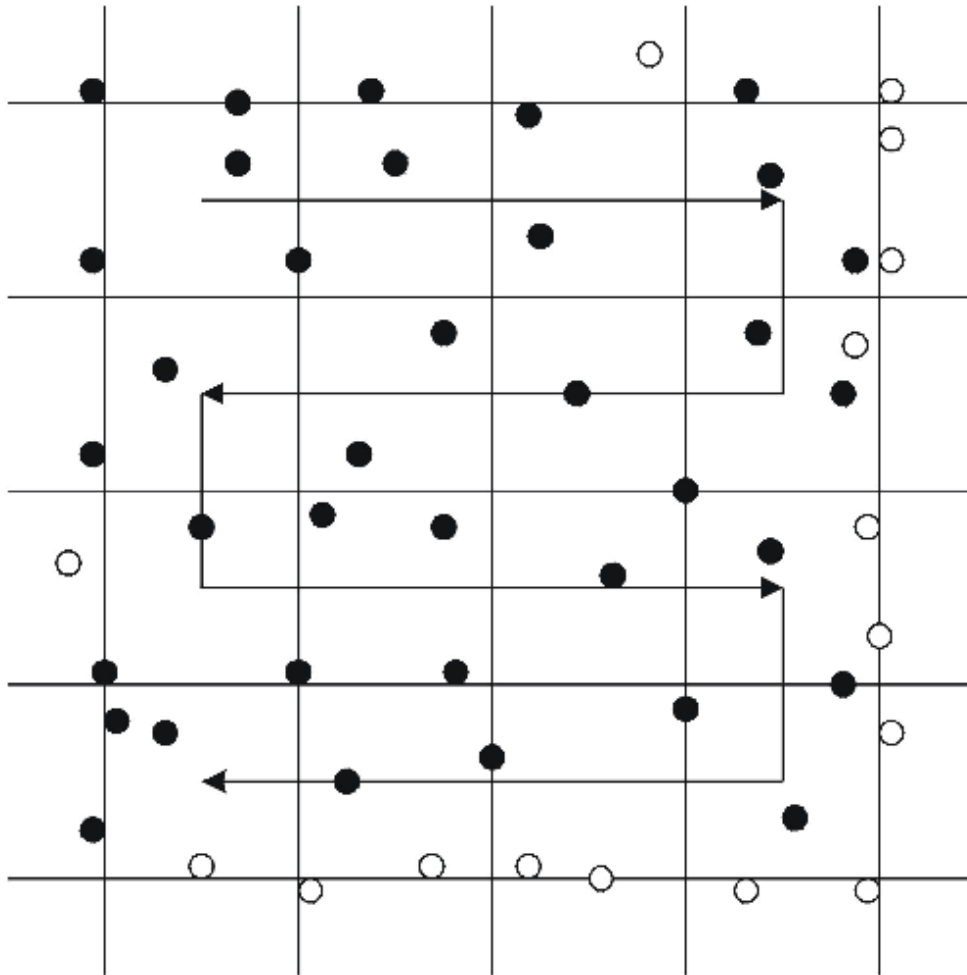
<b>Source Waters During the ICR Supplemental Surveys (Adapted from Reference 20.13) MS Recovery Range</b>	<b>Percent of 430 <i>Cryptosporidium</i> MS Samples in Recovery Range</b>	<b>Percent of 270 <i>Giardia</i> MS Samples in Recovery Range</b>
<10%	6.7%	5.2%
>10% - 20%	6.3%	4.8%
>20% - 30%	14.9%	7.0%
>30% - 40%	14.2%	8.5%
>40% - 50%	18.4%	17.4%
>50% - 60%	17.4%	16.3%
>60% - 70%	11.2%	16.7%
>70% - 80%	8.4%	14.1%
>80% - 90%	2.3%	6.3%
>90%	0.2%	3.7%

Figure 1.



Hemacytometer Platform Ruling. Squares 1, 2, 3, and 4 are used to count stock suspensions of *Cryptosporidium* oocysts and *Giardia* cysts (after Miale, 1967)

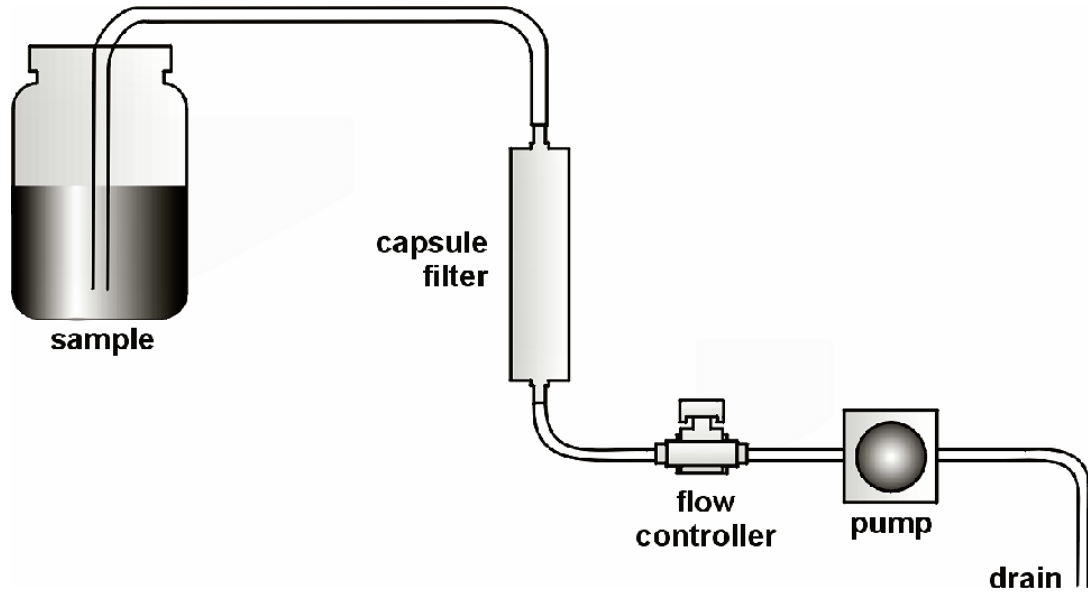
Figure 2.



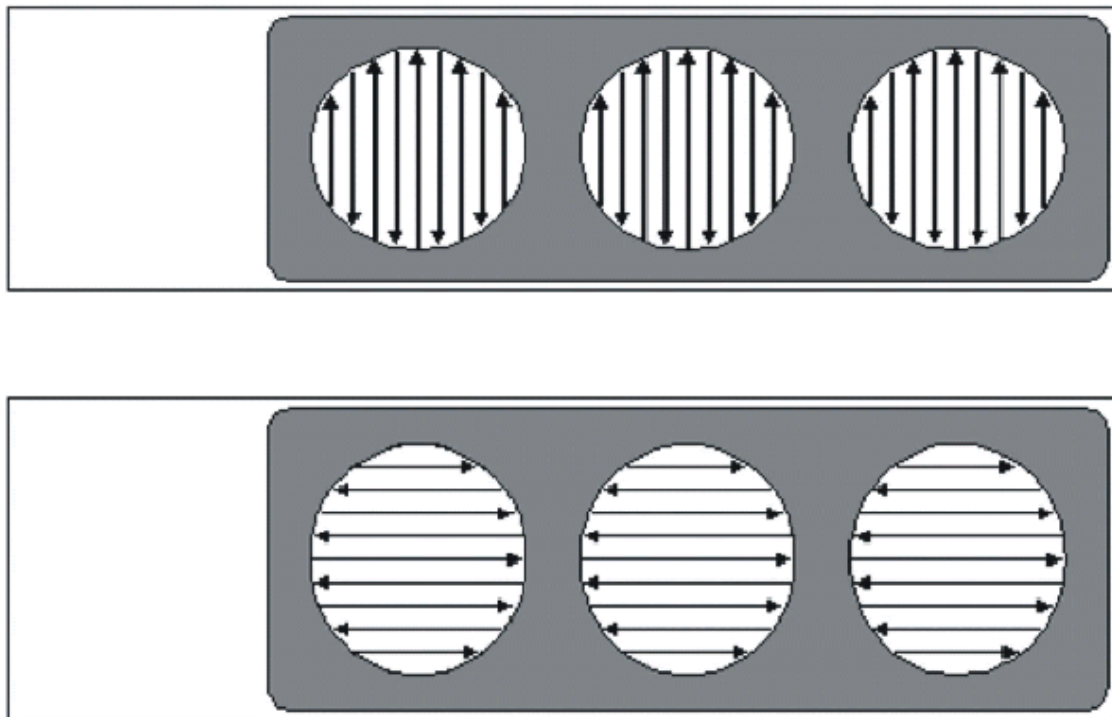
Manner of Counting Oocysts and Cysts in 1 Square mm. Dark organisms are counted and light organisms are omitted (after Miale, 1967).



**Figure 3. Laboratory Filtration System**



**Figure 4. Methods for Scanning a Well Slide**





# Method 1604: Total Coliforms and *Escherichia coli* in Water by Membrane Filtration Using a Simultaneous Detection Technique (MI Medium)

## 1.0 Scope and Application

**1.1** This test method describes a sensitive and differential membrane filter (MF) medium, using MI agar or MI broth, for the simultaneous detection and enumeration of both total coliforms (TC) and *Escherichia coli* (*E. coli*) in water samples in 24 hours or less on the basis of their specific enzyme activities. Two enzyme substrates, the fluorogen 4-Methylumbelliferyl- $\beta$ -D-galactopyranoside (MUGal) and a chromogen Indoxyl- $\beta$ -D-glucuronide (IBDG), are included in the medium to detect the enzymes  $\beta$ -galactosidase and  $\beta$ -glucuronidase, respectively, produced by TC and *E. coli*, respectively.

**1.2** Total coliforms include species that may inhabit the intestines of warm-blooded animals or occur naturally in soil, vegetation, and water. They are usually found in fecally-polluted water and are often associated with disease outbreaks. Although they are not usually pathogenic themselves, their presence in drinking water indicates the possible presence of pathogens. *E. coli*, one species of the coliform group, is always found in feces and is, therefore, a more direct indicator of fecal contamination and the possible presence of enteric pathogens. In addition, some strains of *E. coli* are pathogenic (Reference 16.12).

**1.3** This method, which has been validated for use with drinking water in single-lab and multi-lab studies (References 16.8 - 16.10), will be used primarily by certified drinking water laboratories for microbial analysis of potable water. Other uses include recreational, surface or marine water, bottled water, groundwater, well water, treatment plant effluents, water from drinking water distribution lines, drinking water source water, and possibly foods, pharmaceuticals, clinical specimens (human or veterinary), other environmental samples (e.g., aerosols, soil, runoff, or sludge) and/or isolation and separation of transformants through the use of *E. coli lac Z* or *gus A* uid reporter genes (Reference 16.11).

**1.4** Since a wide range of sample volumes or dilutions can be analyzed by the MF technique, a wide range of *E. coli* and TC levels in water can be detected and enumerated.

## 2.0 Summary of Method

**2.1** An appropriate volume of a water sample (100 mL for drinking water) is filtered through a 47-mm, 0.45- $\mu$ m pore size cellulose ester membrane filter that retains the bacteria present in the sample. The filter is placed on a 5-mL plate of MI agar or on an absorbent pad saturated with 2-3 mL of MI broth, and the plate is incubated at 35°C for up to 24 hours. The bacterial colonies that grow on the plate are inspected for the presence of blue color from the breakdown of IBDG by the *E. coli* enzyme  $\beta$ -glucuronidase and fluorescence under long wave ultraviolet light (366 nm) from the breakdown of MUGal by the TC enzyme  $\beta$ -galactosidase (Reference 16.8).

## 3.0 Definitions

**3.1** Total coliforms (TC) - In this method, TC are those bacteria that produce fluorescent colonies upon exposure to long wave ultraviolet light (366 nm) after primary culturing on MI agar or broth (See Figure 1.). The fluorescent colonies can be completely blue-white (TC other than *E. coli*) or blue-green (*E. coli*) in color or fluorescent halos may be observed around the edges of the blue-green *E. coli* colonies. In addition, non-fluorescent blue colonies, which rarely occur, are added to the total count because the fluorescence is masked by the blue color from the breakdown of IBDG (Reference 16.8).

**3.2** *Escherichia coli* - In this method, the *E. coli* are those bacteria that produce blue colonies under ambient light after primary culturing on MI agar or broth (See Figures 1 and 2.). These colonies can be fluorescent or non-fluorescent under long wave ultraviolet light (366 nm) (Reference 16.8).

#### **4.0 Interferences and Contamination**

4.1 Water samples containing colloidal or suspended particulate material can clog the membrane filter, thereby preventing filtration, or cause spreading of bacterial colonies which could interfere with identification of target colonies. However, the blue *E. coli* colonies can often be counted on plates with heavy particulates or high concentrations of total bacteria (See Figures 2 and 3.) (Reference 16.8).

4.2 The presence of some lateral diffusion of blue color away from the target *E. coli* colonies can affect enumeration and colony picking on plates with high concentrations of *E. coli*. This problem should not affect filters with low counts, such as those obtained with drinking water or properly diluted samples (Reference 16.8).

4.3 Tiny, flat or peaked pinpoint blue colonies (# 0.5-mm in diameter on filters containing # 200 colonies) may be due to species other than *E. coli*. These colonies occur occasionally in low numbers and should be excluded from the count of the *E. coli* colonies, which are usually much larger in size (1-3-mm in diameter). The small colonies have never been observed in the absence of typical *E. coli*, but, if such should occur, the sample should not be considered *E. coli*-positive unless at least one colony has been verified by another method [e.g., EC medium with 4-Methylumbelliferyl- $\beta$ -D-glucuronide (MUG) or API 20E strips] (Reference 16.8).

4.4 Bright green, fluorescent, non-blue colonies, observed along with the typical blue/white or blue-green fluorescent TC colonies, may be species other than coliforms. These colonies, which generally occur in low numbers (# 5%) and can usually be distinguished from the TC, should be eliminated from the TC count. An increase in the number of bright green colonies may indicate an unusual sample population or a breakdown of the cefsulodin in the medium (Reference 16.8).

#### **5.0 Safety**

5.1 The analyst/technician must know and observe the normal safety procedures required in a microbiology laboratory while preparing, using, and disposing of cultures, reagents, and materials, and while operating sterilization equipment.

5.2 Mouth-pipetting is prohibited.

5.3 Avoid prolonged exposure to long wave or germicidal ultraviolet light.

5.4 Autoclave all contaminated plates and materials at the end of the analysis.

#### **6.0 Equipment and Supplies**

6.1 Incubator set at 35°C  $\pm$  0.5°C, with approximately 90% humidity if loose-lidded Petri dishes are used.

6.2 Stereoscopic microscope, with magnification of 10-15x, wide-field type.

6.3 A microscope lamp producing diffuse light from cool, white fluorescent lamps adjusted to give maximum color.

6.4 Hand tally.

6.5 Pipet container of stainless steel, aluminum, or Pyrex glass, for pipets.

6.6 Graduated cylinders (100-mL for drinking water), covered with aluminum foil or kraft paper and sterilized.

6.7 Membrane filtration units (filter base and funnel), glass, plastic or stainless steel. These are wrapped with aluminum foil or kraft paper and sterilized.

6.8 Germicidal ultraviolet (254 nm) light box for sanitizing the filter funnels is desirable, but optional.

6.9 Line vacuum, electric vacuum pump, or aspirator is used as a vacuum source. In an emergency, a hand pump or a syringe can be used. Such vacuum-producing devices should be equipped with a check valve to prevent the return flow of air.

6.10 Vacuum filter flask, usually 1 liter, with appropriate tubing. Filter manifolds to hold a number of filter bases are desirable, but optional.

6.11 Safety trap flask, placed between the filter flask and the vacuum source.

6.12 Forceps, straight (preferred) or curved, with smooth tips to permit easy handling of filters without damage.

6.13 Alcohol, 95% ethanol, in small wide-mouthed vials, for sterilizing forceps.

6.14 Bunsen or Fisher-type burner or electric incinerator unit.

- 6.15 Sterile T.D. (To Deliver) bacteriological or Mohr pipets, glass or plastic (1-mL and 10-mL volumes).
- 6.16 Membrane Filters (MF), white, grid-marked, cellulose ester, 47-mm diameter,  $0.45\ \mu\text{m} \pm 0.02\text{-}\mu\text{m}$  pore size, pretrial or sterilized for 10 minutes at  $121^\circ\text{C}$  (15-lb pressure).
- 6.17 Long wave ultraviolet lamp (366 nm), handheld 4-watt (preferred) or 6-watt, or microscope attachment.
- 6.18 Dilution water: Sterile phosphate-buffered dilution water, prepared in large volumes (e.g., 1 liter) for wetting membranes before addition of the sample and for rinsing the funnel after sample filtration or in 99-mL dilution blanks [Section 9050C in Standard Methods (Reference 16.2)].
- 6.19 Indelible ink marker for labeling plates.
- 6.20 Thermometer, checked against a National Institute of Science and Technology (NIST)-certified thermometer, or one traceable to an NIST thermometer.
- 6.21 Petri dishes, sterile, plastic, 9 x 50 mm, with tight-fitting lids, or 15 x 60 mm, glass or plastic, with loose-fitting lids; 15 x 100 mm dishes may also be used.
- 6.22 Bottles, milk dilution, borosilicate glass, screw-cap with neoprene liners, marked at 99 mL for 1:100 dilutions (if needed). Dilution bottles marked at 90 mL, or tubes marked at 9 mL may be used for 1:10 dilutions.
- 6.23 Flasks, borosilicate glass, screw-cap, 250- to 2000-mL volume, for agar preparation.
- 6.24 Waterbath maintained at  $50^\circ\text{C}$  for tempering agar.
- 6.25 Syringe filter, sterile, disposable, 25-mm diameter,  $0.22\text{-}\mu\text{m}$  pore size, to filter cefsulodin for MI agar.
- 6.26 Syringe, sterile, plastic, disposable, 20-cc capacity. Autoclaved glass syringes are also acceptable.
- 6.27 Test tubes, sterile, screw-cap, 20 x 150-mm, borosilicate glass or plastic, with lids.
- 6.28 Sterilization filter units, presterile, disposable, 500- or 1000-mL capacity,  $0.2\text{-}\mu\text{m}$  pore size, to filter stock buffer solutions.
- 6.29 Sterile 47-mm diameter absorbent pads (used with MI broth).

**Note:** Brand names, suppliers, and part numbers are for illustrative purposes only. No endorsement is implied. Equivalent performance may be achieved using apparatus and materials other than those specified here, but demonstration of equivalent performance that meets the requirements of this method is the responsibility of the laboratory.

## 7.0 Reagents and Standards

- 7.1 Purity of Reagents: Reagent grade chemicals shall be used in all tests. Unless otherwise indicated, reagents shall conform to the specifications of the Committee on Analytical Reagents of the American Chemical Society (Reference 16.1). The agar used in preparation of culture media must be of microbiological grade.
- 7.2 Whenever possible, use commercial culture media as a means of quality control.
- 7.3 Purity of Water: Reagent-grade distilled water conforming to Specification D1193, Type II water or better, ASTM Annual Book of Standards (Reference 16.3).
- 7.4 Buffered Dilution Water (Reference 16.2)
- 7.4.1 Stock Phosphate Buffer Solution (Reference 16.2):  
Potassium Dihydrogen Phosphate ( $\text{KH}_2\text{PO}_4$ ) 34.0 g Reagent-Grade Distilled Water 500 mL
- 7.4.2 Preparation of Stock Buffer Solution: Adjust the pH of the solution to 7.2 with 1 N NaOH, and bring volume to 1000 mL with reagent-grade distilled water. Sterilize by filtration or autoclave for 15 minutes at  $121^\circ\text{C}$  (15-lb pressure).
- 7.4.3  $\text{MgCl}_2$  Solution (Reference 16.2): Dissolve 38 g anhydrous  $\text{MgCl}_2$  (or 81.1 g  $\text{MgCl}_2 \cdot 6\text{H}_2\text{O}$ ) in one liter of reagent-grade distilled water. Sterilize by filtration or autoclave for 15 minutes at  $121^\circ\text{C}$  (15-lb pressure).
- 7.4.4 Storage of Stock Buffer and  $\text{MgCl}_2$  Solutions: After sterilization of the stock solutions, store in the refrigerator until used. Handle aseptically. If evidence of mold or other contamination appears in either stock, the solution should be discarded, and a fresh solution should be prepared.
- 7.4.5 Working Solution (Final pH  $7.0 \pm 0.2$ ): Add 1.25 mL phosphate buffer stock (Section 7.4.2) and 5 mL  $\text{MgCl}_2$  stock (Section 7.4.3) for each liter of reagent-grade distilled water prepared. Mix well, and dispense in appropriate amounts for dilutions in screw-cap dilution bottles or culture

tubes, and/or into larger containers for use as rinse water. Autoclave at 121°C (15-lb pressure) for 15 minutes. Longer sterilization times may be needed depending on the container and load size and the amount of time needed for the liquid to reach 121°C.

### 7.5 MI Agar (Reference 16.8)

#### 7.5.1 Composition:

Proteose Peptone #3	5.0 g
Yeast Extract	3.0 g
β -D-Lactose	1.0 g
4-Methylumbelliferyl- β -D-Galactopyranoside (MUGal)	
(Final concentration 100µg/mL)	0.1 g
Indoxyl- β -D-Glucuronide (IBDG)	
(Final concentration 320 µg/mL)	0.32 g
NaCl	7.5 g
K <sub>2</sub> HPO <sub>4</sub>	3.3 g
KH <sub>2</sub> PO <sub>4</sub>	1.0 g
Sodium Lauryl Sulfate	0.2 g
Sodium Desoxycholate	0.1 g
Agar	15.0 g
Reagent-Grade Distilled Water	1000 mL

7.5.2 Cefsulodin Solution (1 mg / 1 mL): Add 0.02 g of cefsulodin to 20 mL reagent-grade distilled water, sterilize using a 0.22-µm syringe filter, and store in a sterile tube at 4°C until needed. Prepare fresh solution each time. Do not save the unused portion.

7.5.3 Preparation: Autoclave the medium for 15 minutes at 121°C (15-lb pressure), and add 5 mL of the freshly-prepared solution of Cefsulodin (5 µg/mL final concentration) per liter of tempered agar medium. Pipet the medium into 9 x 50-mm Petri dishes (5 mL/plate). Store plates at 4°C for up to 2 weeks. The final pH should be 6.95 ± 0.2.

7.6 MI Broth: The composition of MI broth is the same as MI agar, but without the agar. The final pH of MI broth should be 7.05 ± 0.2. The broth is prepared and sterilized by the same methods described for MI agar in Sections 7.5.1, 7.5.2, and 7.5.3, except that absorbent pads are placed in 9 x 50 mm Petri dishes and saturated with 2-3 mL of MI broth containing 5 µg/mL final concentration of Cefsulodin. Alternately, the broth can be filter-sterilized. Excess broth is poured off before using the plates. Plates should be stored in the refrigerator and discarded after 96 hours (Reference 16.15).

7.7 Tryptic Soy Agar/Trypticase Soy Agar (Difco 0369-17-6, BD 4311043, Oxoid CM 0129B, or equivalent) (TSA)

#### 7.7.1 Composition:

Tryptone	15.0 g
Soytone	5.0 g
NaCl	5.0 g
Agar	15.0 g

7.7.2 Preparation: Add the dry ingredients listed above to 1000 mL of reagent-grade distilled water, and heat to boiling to dissolve the agar completely. Autoclave at 121°C (15-lb pressure) for 15 minutes. Dispense the agar into 9 x 50-mm Petri dishes (5 mL/plate). Incubate the plates for 24 - 48 hours at 35°C to check for contamination. Discard any plates with growth. If > 5% of the plates show contamination, discard all plates, and make new medium. Store at 4°C until needed. The final pH should be 7.3 ± 0.2.

## 8.0 Sample Collection, Preservation, and Storage

8.1 Water samples are collected in sterile polypropylene sample containers with leakproof lids.

8.2 Sampling procedures are described in detail in Sections 9060A and 9060B of the 18<sup>th</sup> edition of *Standard Methods for the Examination of Water and Wastewater* (Reference 16.2) or in the *USEPA Microbiology Methods Manual*, Section II, A (Reference 16.6). Residual chlorine in drinking water (or chlorinated effluent) samples should be neutralized with sodium thiosulfate (1 mL of a 10% solution per liter of water) at the time of collection. Adherence to sample preservation procedures and holding time limits are critical to the production of valid data. Samples not collected according to these rules should not be analyzed.

8.2.1 *Storage Temperature and Handling Conditions:* Ice or refrigerate water samples at a temperature of 1-4°C during transit to the laboratory. Use insulated containers to assure proper maintenance of storage temperature. Take care that sample bottles are not totally immersed in water from melted ice during transit or storage.

8.2.2 *Holding Time Limitations:* Analyze samples as soon as possible after collection. Drinking water samples should be analyzed within 30 h of collection (Reference 16.13). Do not hold source water samples longer than 6 h between collection and initiation of analyses, and the analyses should be complete within 8 h of sample collection.

## 9.0 Calibration and Standardization

9.1 Check temperatures in incubators twice daily to ensure operation within stated limits (Reference 16.14).

9.2 Check thermometers at least annually against an NIST-certified thermometer or one traceable to NIST. Check mercury columns for breaks.

## 10.0 Quality Control (QC)

10.1 Pretest each batch of MI agar or broth for performance (*i.e.*, correct enzyme reactions) with known cultures (*E. coli*, TC, and a non-coliform).

10.2 Test new lots of membrane filters against an acceptable reference lot using the method of Brenner and Rankin (Reference 16.7).

10.3 Perform specific filtration control tests each time samples are analyzed, and record the results.

10.3.1 *Filter Control:* Place one or more membrane filters on TSA plates, and incubate the plates for 24 hours at 35°C. Absence of growth indicates sterility of the filter(s).

10.3.2 *Phosphate-Buffered Dilution Water Controls:* Filter a 50-mL volume of sterile dilution water before beginning the sample filtrations and a 50-mL volume of dilution water after completing the filtrations. Place the filters on TSA plates, and incubate the plates for 24 hours at 35°C. Absence of growth indicates sterility of the dilution water.

10.3.3 *Agar or Broth Controls:* Place one or more TSA plates and one or more MI agar plates or MI broth pad plates in the incubator for 24 hours at 35°C. Broth pad plates should be incubated *grid-side up*, not inverted like the agar plates. Absence of growth indicates sterility of the plates.

10.4 See recommendations on quality control for microbiological analyses in the “*Manual for the Certification of Laboratories Analyzing Drinking Water: Criteria and Procedures; Quality Assurance*” (Reference 16.15) and the *USEPA Microbiology Methods Manual*, part IV, C (Reference 16.6).

## 11.0 Procedure

11.1 Prepare MI agar or MI broth and TSA as described in Sections 7.5, 7.6, and 7.7. If plates are made ahead of time and stored in the refrigerator, remove them and allow them to warm to room temperature. The crystals that form on MI agar after refrigeration will disappear as the plates warm up (Reference 16.8).

11.2 Label the bottom of the MI agar or MI broth plates with the sample number/identification and the volume of sample to be analyzed. Label QC TSA plates and the MI agar or MI broth sterility control plate(s).

**11.3** Using a flamed forceps, place a membrane filter, grid-side up, on the porous plate of the filter base. If you have difficulties in removing the separation papers from the filters due to static electricity, place a filter with the paper on top of the funnel base and turn on the vacuum. The separation paper will curl up, allowing easier removal.

**11.4** Attach the funnel to the base of the filter unit, taking care not to damage or dislodge the filter. The membrane filter is now located between the funnel and the base.

**11.5** Put approximately 30 mL of sterile dilution water in the bottom of the funnel.

**11.6** Shake the sample container vigorously 25 times.

**11.7** Measure an appropriate volume (100 mL for drinking water) or dilution of the sample with a sterile pipette or graduated cylinder, and pour it into the funnel. Turn on the vacuum, and leave it on while rinsing the funnel twice with about 30 mL sterile dilution water.

**11.8** Remove the funnel from the base of the filter unit. A germicidal ultraviolet (254 nm) light box can be used to hold and sanitize the funnel between filtrations. At least 2 minutes of exposure time is required for funnel decontamination. Protect eyes from UV irradiation with glasses, goggles, or an enclosed UV chamber.

**11.9** Holding the membrane filter at its edge with a flamed forceps, gently lift and place the filter grid-side up on the MI agar plate or MI broth pad plate. Slide the filter onto the agar or pad, using a rolling action to avoid trapping air bubbles between the membrane filter and the underlying agar or absorbent pad. Run the tip of the forceps around the outside edge of the filter to be sure the filter makes contact with the agar or pad. Reseat the membrane if non-wetted areas occur due to air bubbles.

**11.10** Invert the agar Petri dish, and incubate the plate at 35°C for 24 hours. Pad plates used with MI broth should be incubated grid-side up at 35°C for 24 hours. If loose-lidded plates are used for MI agar or broth, the plates should be placed in a humid chamber.

**11.11** Count all blue colonies on each MI plate under normal/ambient light, and record the results (See Figures 1 and 2.). This is the E. coli count. Positive results that occur in less than 24 hours are valid, but the results cannot be recorded as negative until the 24-hour incubation period is complete (Reference 16.14).

**11.12** Expose each MI plate to long wave ultraviolet light (366 nm), and count all fluorescent colonies [blue/green fluorescent E. coli, blue/white fluorescent TC other than E. coli, and blue/green with fluorescent edges (also E. coli)] (See Figure 1.). Record the data.

11.13 Add any blue, non-fluorescent colonies (if any) found on the same plate to the TC count (Reference 16.8).

## 12.0 Data Analysis and Calculations

12.1 Use the following general rules to calculate the E. coli or TC per 100 mL of sample:

12.1.1 Select and count filters with # 200 total colonies per plate.

12.1.2 Select and count filter with # 100 target colonies (ideally, 20-80).

12.1.3 If the total number of colonies or TC on a filter are too-numerous-to-count or confluent, record the results as “TC<sup>+</sup> (TNTC)” and count the number of E. coli. If both target organisms are \$ 200, record the results as “TC<sup>+</sup> EC<sup>+</sup> (TNTC)”.

12.1.4 Calculate the final values using the formula:

$$\text{E. coli/100 mL} = \frac{\text{Number of blue colonies}}{\text{Volume of sample filtered (mL)}} \times 100$$

$$\text{TC/100 mL} = \frac{\text{Number of fluorescent colonies} + \text{Number of blue, non-fluorescent colonies (if any)}}{\text{Volume of sample filtered (mL)}} \times 100$$

12.2 See the USEPA Microbiology Manual, Part II, Section C, 3.5, for general counting rules (Reference 16.6).

12.3 Report results as E. coli or TC per 100 mL of drinking water.



### **13.0 Method Performance**

**13.1** The detection limits of this method are one *E. coli* and/or one total coliform per sample volume or dilution tested (Reference 16.8).

**13.2** The false-positive and false-negative rates for *E. coli* are both reported to be 4.3% (Reference 16.8).

**13.3** The single lab recovery of *E. coli* is reported (Reference 16.8) to be 97.9% of the Heterotrophic Plate Count (pour plate) (Reference 16.2) and 115% of the R2A spread plate (Reference 16.2). For *Klebsiella pneumoniae* and *Enterobacter aerogenes*, two total coliforms, the recoveries are 87.5% and 85.7% of the HPC (Reference 16.8), respectively, and 89.3% and 85.8% of the R2A spread plate, respectively.

**13.4** The specificities for *E. coli* and total coliforms are reported to be 95.7% and 93.1% (Reference 16.8), respectively.

**13.5** The single lab coefficients of variation for *E. coli* and total coliforms are reported to be 25.1% and 17.6% (Reference 16.8), respectively, for a variety of water types.

**13.6** In a collaborative study (References 16.4, 16.5, and 16.9), 19 laboratories concurrently analyzed six wastewater-spiked Cincinnati tap water samples, containing 3 different concentrations of *E. coli* (# 10, 11-30, and > 30 per 100 mL).

**13.6.1** The single laboratory precision (coefficient of variation), a measure of the repeatability, ranged from 3.3% to 27.3% for *E. coli* and from 2.5% to 5.1% for TC for the six samples tested, while the overall precision (coefficient of variation), a measure of reproducibility, ranged from 8.6% to 40.5% and from 6.9% to 27.7%, respectively. These values are based on log<sub>10</sub>-transformed data (Reference 16.5).

**13.6.2** Table 1 contains the statistical summary of the collaborative study (Reference 16.9) results.

### **14.0 Pollution Prevention**

**14.1** Pollution prevention is any technique that reduces or eliminates the quantity or toxicity of waste at the point of generation. It is the environmental management tool preferred over waste disposal or recycling. When feasible, laboratory staff should use a pollution prevention technique, such as preparation of the smallest practical volumes of reagents, standards, and media or downsizing of the test units in a method.

**14.2** The laboratory staff should also review the procurement and use of equipment and supplies for other ways to reduce waste and prevent pollution. Recycling should be considered whenever practical.

### **15.0 Waste Management**

**15.1** The Environmental Protection Agency requires that laboratory waste management practices be consistent with all applicable rules and regulations. The Agency urges laboratories to protect the air, water, and land by minimizing and controlling releases from hoods and bench operations, complying with the letter and spirit of sewer discharge permits and regulations and by complying with solid and hazardous waste regulations, particularly the hazardous waste identification rules and land disposal restrictions. All infectious wastes should be autoclaved before disposal.

### **16.0 References**

- 16.1** American Chemical Society. 1981. Reagent Chemicals. In American Chemical Society Specifications, 6<sup>th</sup> edition. American Chemical Society, Washington, D.C. For suggestions on the testing of reagents not listed by the American Chemical Society, see Analar Standards for Laboratory Chemicals, BDH Ltd., Poole, Dorset, U.K. and the United States Pharmacopeia.
- 16.2** American Public Health Association. 1992. Standard Methods for the Examination of Water and Wastewater, 18<sup>th</sup> edition. American Public Health Association, Washington, D.C.
- 16.3** American Society for Testing and Materials. 1993. Standard Specification for Reagent Water, Designation D1193-91, p. 45-47. In 1993 Annual Book of ASTM Standards: Water and Environmental Technology, Volume 11.01. American Society for Testing and Materials, Philadelphia, PA.

- 16.4** American Society for Testing and Materials. 1994. Standard Practice for Determination of Precision and Bias of Applicable Methods of Committee D-19 on Water, Designation D 2777-86, p. 31-44. In 1994 Annual Book of ASTM Standards, Section 11: Water and Environmental Technology, Volume 11.01. American Society for Testing and Materials, Philadelphia, PA.
- 16.5** Association of Official Analytical Chemists. 1989. Guidelines for Collaborative Study Procedure to Validate Characteristics of a Method of Analysis. *Journal of the Association of Official Analytical Chemists* 72 (4): 694-704.
- 16.6** Bordner, R., J. Winter, and P. Scarpino (ed). 1978. *Microbiological Methods for Monitoring the Environment: Water and Wastes*. EPA-600/8-78-017, Environmental Monitoring and Support Laboratory, U.S. Environmental Protection Agency, Cincinnati, OH.
- 16.7** Brenner, K.P., and C.C. Rankin. 1990. New Screening Test to Determine the Acceptability of 0.45- $\mu$ m Membrane Filters for Analysis of Water. *Applied and Environmental Microbiology* 56: 54-64.
- 16.8** Brenner, K.P., and C.C. Rankin, Y.R. Roybal, G.N. Stelma, Jr., P.V. Scarpino, and A.P. Dufour. 1993. New Medium for the Simultaneous Detection of Total Coliforms and *Escherichia coli* in Water. *Applied and Environmental Microbiology* 59: 3534-3544.
- 16.9** Brenner, K.P., C.C. Rankin, and M. Sivaganesan. 1996. Interlaboratory Evaluation of MI Agar and the U.S. Environmental Protection Agency-Approved Membrane Filter Method for the Recovery of Total Coliforms and *Escherichia coli* from Drinking Water. *Journal of Microbiological Methods* 27: 111-119.
- 16.10** Brenner, K.P., C.C. Rankin, M. Sivaganesan, and P.V. Scarpino. 1996. Comparison of the Recoveries of *Escherichia coli* and Total Coliforms from Drinking Water by the MI Agar Method and the U.S. Environmental Protection Agency-Approved Membrane Filter Method. *Applied and Environmental Microbiology* 62 (1): 203-208.
- 16.11** Buntel, C.J. 1995. *E. coli*  $\beta$ -Glucuronidase (GUS) as a Marker for Recombinant Vaccinia Viruses. *BioTechniques* 19 (3): 352-353.
- 16.12** Federal Register. 1985. National Primary Drinking Water Regulations; Synthetic Organic Chemicals, Inorganic Chemicals and Microorganisms; Proposed Rule. *Federal Register* 50: 46936-47022.
- 16.13** Federal Register. 1994. National Primary and Secondary Drinking Water Regulations: Analytical Methods for Regulated Drinking Water Contaminants; Final Rule. *Federal Register* 59: 62456-62471.
- 16.14** Federal Register. 1999. National Primary and Secondary Drinking Water Regulations: Analytical Methods for Chemical and Microbiological Contaminants and Revisions to Laboratory Certification Requirements; Final Rule. *Federal Register* 64: 67450-67467.
- 16.15** U.S. Environmental Protection Agency. 1992. *Manual for the Certification of Laboratories Analyzing Drinking Water: Criteria and Procedures, Quality Assurance*, Third Edition. EPA-814B-92-002, Office of Ground Water and Drinking Water, Technical Support Division, U.S. Environmental Protection Agency, Cincinnati, OH.

## 17.0 Tables and Figures

**Table 1. Statistical Summary of the Collaborative Study Results**<sup>1</sup>

Target Organism	Sample Number	<i>E. coli</i> Count Category (Range) <sup>2</sup>	Initial n <sup>3</sup>	Final n <sup>4</sup>	S <sub>r</sub> <sup>5</sup>	RSD <sub>r</sub> <sup>6</sup> (%)	$\bar{\chi}$ <sup>7</sup>	S <sub>R</sub> <sup>8</sup>	RSD <sub>R</sub> <sup>9</sup> (%)	$\frac{RSD_R}{RSD_r}$ Ratio
<i>Escherichia coli</i>	1	Low ( $\leq 10$ )	63	63	0.17	27.3	0.64	0.26	40.5	1.49
	2		63	63	0.21	25.0	0.84	0.33	39.0	1.56
	3	Medium (11-30)	63	63	0.10	7.9	1.27	0.15	12.1	1.52
	4		63	60	0.07	5.6	1.32	0.12	9.2	1.65
	5	High (> 30)	63	60	0.06	3.3	1.87	0.16	8.6	2.62
	6		63	63	0.09	4.3	1.99	0.25	12.6	2.91
Total Coliforms	1	Low ( $\leq 10$ )	63	63	0.10	4.3	2.35	0.62	26.4	6.11
	2		63	63	0.09	3.8	2.31	0.64	27.7	7.25
	3	Medium (11-30)	63	63	0.11	5.1	2.17	0.47	21.8	4.28
	4		63	57	0.10	3.3	3.07	0.21	6.9	2.08
	5	High (> 30)	63	63	0.15	4.8	3.10	0.43	14.0	2.96
	6		63	63	0.08	2.5	3.14	0.46	14.7	5.97

<sup>1</sup> The values are based on log<sub>10</sub> transformed data (Reference 16.5).

<sup>2</sup> The samples were grouped by their *E. coli* count on MI agar into the following categories: Low (# 10 *E. coli* / 100 mL, samples 1 and 2), Medium (11-30 *E. coli* / 100 mL, samples 3 and 4), and High (> 30 *E. coli* / 100 mL, samples 5 and 6).

<sup>3</sup> These values are based on triplicate analyses by each laboratory. The reference laboratory analyzed three sets of samples: the initial and final samples prepared and a sample shipped along with the other 18 lab samples.

<sup>4</sup> These values were obtained after removing outliers by the AOAC procedure (Reference 16.5).

<sup>5</sup> S<sub>r</sub>, Single Operator Standard Deviation, a measure of repeatability.

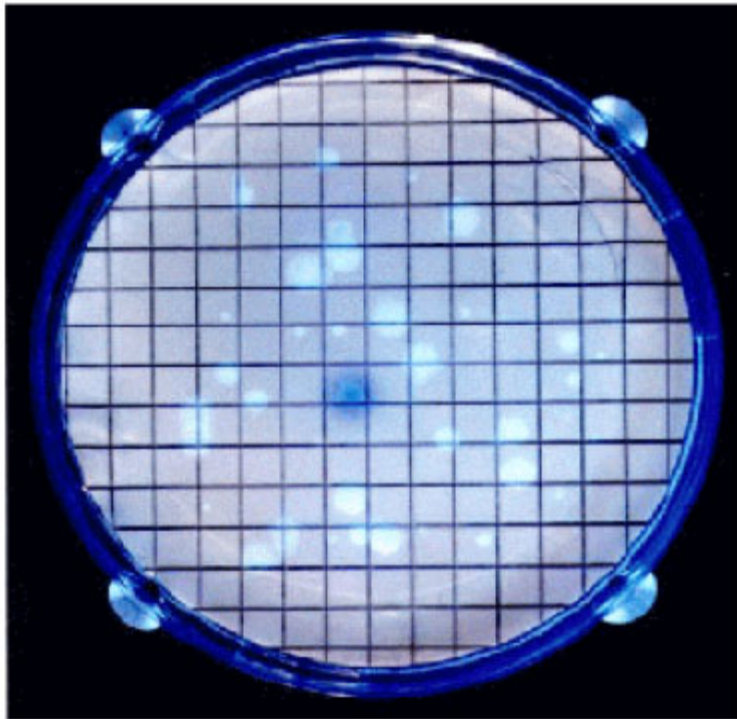
<sup>6</sup> RSD<sub>r</sub>, Single Operator Relative Standard Deviation (Coefficient of Variance), a measure of repeatability.

<sup>7</sup>  $\bar{\chi}$ , The mean of the replicate analyses for all laboratories.

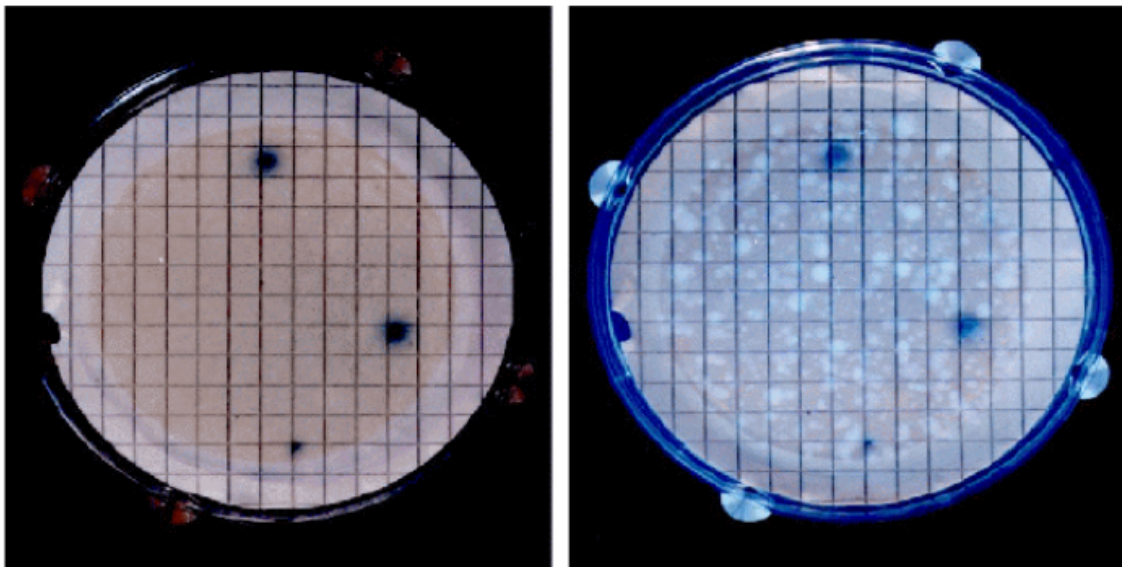
<sup>8</sup> S<sub>R</sub>, Overall Standard Deviation, a measure of reproducibility.

<sup>9</sup> RSD<sub>R</sub>, Overall Relative Standard Deviation (Coefficient of Variation), a measure of reproducibility.

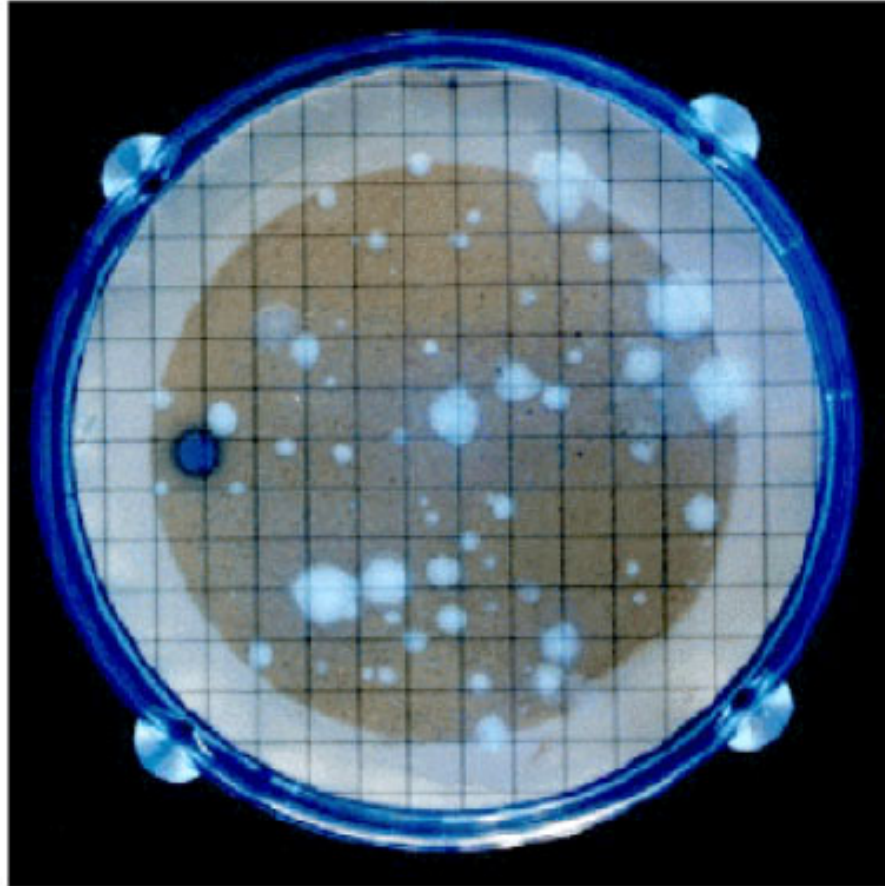




**Figure 1.** This photograph shows *Escherichia coli* (blue/green fluorescence) and total coliforms other than *E. coli* (blue/white fluorescence) on MI agar under long wave UV light (366 nm). The sample used was a wastewater-spiked Cincinnati, Ohio tap water.



**Figure 2.** These photographs show *Escherichia coli* and total coliforms from cistern water on MI agar. The confluent plate was photographed under different lighting: ambient light on the left, and long wave UV light (366 nm) on the right. Under ambient light, *E. coli* are blue, and total coliforms other than *E. coli* and non-coliforms are their natural color. Under long wave UV light, all total coliforms, including *E. coli*, are fluorescent, and noncoliforms are non-fluorescent (*i.e.*, they are not visible).



**Figure 3.** This photograph shows that *Escherichia coli* (blue/green fluorescence) and total coliforms other than *E. coli* (blue/white fluorescence) can easily be detected on MI agar plates from samples with high turbidity levels. The sample used was surface water-spiked Cincinnati, Ohio tap water.

## Water Quality Summary

A daily chemistry lab sheet will show: Temperature, Turbidity, pH, Alkalinity, Hardness- Calcium and Magnesium, Total Solids, Iron, Fluoride, Free Chlorine, Combined Chlorine, Particle Count, Langelier Index, Log Removal and UV 254.

### Temperature

A measure of the average kinetic energy of the particles in a sample of matter, expressed in terms of units or degrees designated on a standard scale. Depending on how cold or hot the water temperature is, chemical reactions in the process, such as coagulation, will be affected. We are all aware the colder the water, the longer the contact time; consideration must be made when setting the mixing speed due to the viscosity of the water. Disinfection is also influenced by temperature, depending on the amount of demand and contact required. This could increase the formation of THM.

### pH

The pH of a sample of water is a measure of the concentration of hydrogen ions. The term pH was derived from the manner in which the hydrogen ion concentration is calculated - it is the negative logarithm of the hydrogen ion ( $H^+$ ) concentration. What this means to those of us who are not mathematicians is that at higher pH, there are fewer free hydrogen ions, and that a change of one pH unit reflects a tenfold change in the concentrations of the hydrogen ion. For example, there are 10 times as many hydrogen ions available at a pH of 7 than at a pH of 8. The pH scale ranges from 0 to 14. A pH of 7 is considered to be neutral. Substances with pH of less than 7 are acidic; substances with pH greater than 7 are basic.

The pH of water determines the solubility (amount that can be dissolved in the water) and biological availability (amount that can be utilized by aquatic life) of chemical constituents such as nutrients (phosphorus, nitrogen, and carbon) and heavy metals (lead, copper, cadmium, etc.). For example, in addition to affecting how much and what form of phosphorus is most abundant in the water, pH may also determine whether aquatic life can use it. In the case of heavy metals, the degree to which they are soluble determines their toxicity. Metals tend to be more toxic at lower pH because they are more soluble.

### Reasons for Natural Variation

Photosynthesis uses up dissolved carbon dioxide which acts like carbonic acid ( $H_2CO_3$ ) in water.  $CO_2$  removal, in effect, reduces the acidity of the water and so pH increases. In contrast, respiration of organic matter produces  $CO_2$ , which dissolves in water as carbonic acid, thereby lowering the pH. For this reason, pH may be higher during daylight hours and during the growing season, when photosynthesis is at a maximum. Respiration and decomposition processes lower pH. Like dissolved oxygen concentrations, pH may change with depth in a lake, due again to changes in photosynthesis and other chemical reactions.

There is typically a seasonal decrease in pH in the lower layers of a stratified lake because  $CO_2$  accumulates. There is no light for plants to fix  $CO_2$  and decomposition releases  $CO_2$ .

Fortunately, lake water is complex; it is full of chemical "shock absorbers" that prevent major changes in pH. Small or localized changes in pH are quickly modified by various chemical reactions, so little or no change may be measured. This ability to resist change in pH is called buffering capacity.

Not only does the buffering capacity control would-be localized changes in pH, but it controls the overall range of pH change under natural conditions. The pH scale may go from 0 to 14, but the pH of natural waters hovers between 6.5 and 8.5.

pH influences how well enhanced coagulation will remove TOC. It also has adverse effects to disinfection and the Distribution system.

### **Alkalinity**

Alkalinity is a total measure of the substances in water that have "acid-neutralizing" ability. Don't confuse alkalinity with pH. pH measures the strength of an acid or base; alkalinity indicates a solution's power to react with acid and "buffer" its pH -- that is, the power to keep its pH from changing.

The main sources of natural alkalinity are rocks, which contain carbonate, bicarbonate, and hydroxide compounds. Borates, silicates, and phosphates may also contribute to alkalinity.

Limestone is rich in carbonates, so waters flowing through limestone regions generally have high alkalinity -- hence it's good buffering capacity. Alkalinity has an impact on enhanced coagulation and SUVA. Without alkalinity corrosion would occur.

### **Hardness**

Water hardness is a measure of the amount of calcium and magnesium salts in water. Calcium and magnesium enter water mainly through the weathering of rocks. The more calcium and magnesium in water, the harder the water will be.

Water hardness is usually expressed in milligrams per liter (mg/l) of dissolved calcium and magnesium carbonate. The term "hardness" comes from the fact that it is hard to get soapsuds from soap or detergents in hard water. This happens because calcium and magnesium react strongly with negatively-charged chemicals like soap to form insoluble compounds. As a result, hard water can reduce the effectiveness of the cleaning process. This is also known to cause scale formation; it usually correlates with pH increase.

### **Total Dissolved Solids**

Dissolved solids" refer to any minerals, salts, metals, cations or anions dissolved in water. Total dissolved solids (**TDS**) comprise inorganic salts (principally calcium, magnesium, potassium, sodium, bicarbonates, chlorides and sulfates) and some small amounts of organic matter that are dissolved in water.

TDS in drinking-water originate from natural sources, sewage, urban run-off, industrial wastewater, and chemicals used in the water treatment process, and the nature of the piping or hardware used to convey the water, i.e., the plumbing. In the United States, elevated TDS has been due to natural environmental features such as: mineral springs, carbonate deposits, salt deposits, and sea water intrusion, but other sources may include: salts used for road de-icing, anti-skid materials, drinking water treatment chemicals, stormwater and agricultural runoff, and point/non-point wastewater discharges.

In general, the total dissolved solids concentration is the sum of the cations (positively charged) and anions (negatively charged) ions in the water. Therefore, the total dissolved solids test provides a qualitative measure of the amount of dissolved ions, but does not tell us the nature or ion relationships. In addition, the test does not give us insight into the specific water quality issues, such as: Elevated Hardness, Salty Taste, or Corrosiveness.



Therefore, the total dissolved solids test is used as an indicator test to determine the general quality of the water. The sources of total dissolved solids can include all of the dissolved cations and anions, but the following table can be used as a generalization of the relationship of TDS to water quality problems.

Cations combined with Carbonates CaCO <sub>3</sub> , MgCO <sub>3</sub> etc.	Associated with hardness, scale formation, bitter taste
Cations combined with Chloride NaCl, KCl	Salty or brackish taste, increase corrosivity

An elevated total dissolved solids (TDS) concentration is not a health hazard. The TDS concentration is a secondary drinking water standard and therefore is regulated because it is more of an aesthetic rather than a health hazard. An elevated TDS indicates the following:

- 1)The concentration of the dissolved ions may cause the water to be corrosive, have a salty or brackish taste, result in scale formation, and interfere and decrease efficiency of hot water heaters; and
- 2)Many contain elevated levels of ions that are above the Primary or Secondary Drinking Water Standards, such as: an elevated level of nitrate, arsenic, aluminum, copper, lead, etc.

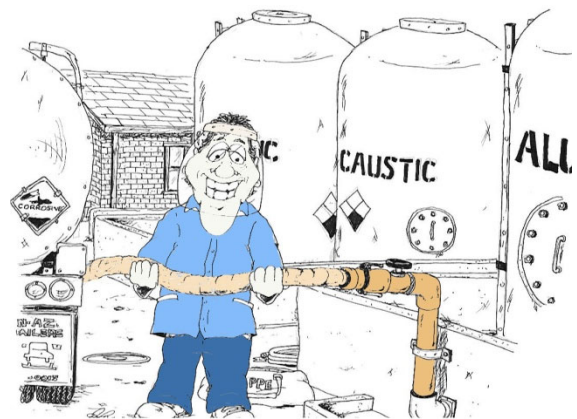
### Iron

Iron is part of the Secondary Rules. Iron is one of the most troublesome elements in water supplies. Making up at least 5 percent of the earth's crust, iron is one of the earth's most plentiful resources. Rainwater as it infiltrates the soil and underlying geologic formations dissolves iron. It is understandable, therefore, that most groundwater supplies contain some measurable amount of iron. Although present in water, iron is seldom found at concentrations greater than 10 milligrams per liter (mg/l) or 10 parts per million. However, *as little as 0.3 mg/l can cause water to turn a reddish brown color.* Iron stains and contaminates anything it contacts. The resulting stains are usually yellowish-brown to reddish-brown, but may be gray to black in the presence of some organics. *Iron may also cause undesirable odors and tastes in water.*

Iron is mainly present in water in various forms but the two most common forms are either the soluble ferrous iron or the insoluble ferric iron. Water containing ferrous iron is clear and colorless because the iron is completely dissolved. When exposed to air or the atmosphere, the water turns cloudy and a reddish brown substance begins to form. This sediment is the oxidized or ferric form of iron that will not dissolve in water. Manganese is frequently found with and is similar to iron but forms a brownish-black precipitate and stains. Manganese is less commonly found in groundwater than iron, rarely found alone in a water source, and generally found with dissolved iron.

### Fluoride

Fluoride exists naturally in water sources and is derived from fluorine, the thirteenth most common element in the Earth's crust. It is well known that fluoride helps prevent and even reverse the early stages of tooth decay. The primary rule MCL is 4.0 mg/L.



### Free and Combined Residual

When chlorine is added to water, some of the chlorine reacts first with organic materials and metals in the water and is not available for disinfection (this is called the *chlorine demand* of the water). The remaining chlorine concentration after the chlorine demand is accounted for is called *total chlorine*. Total chlorine is further divided into: 1) the amount of chlorine that has reacted with nitrates and is unavailable for disinfection which is called *combined chlorine* and, 2) the *free chlorine*, which is the chlorine available to inactivate disease-causing organisms, and thus a measure to determine the potability of water.

### Particle Count

Particle counters are instruments currently used in research that have the capacity to count numbers and determine sizes of particles in suspension. Research has shown that reducing the amount of particulate matter in potable water reduces the risk of human pathogens such as *Cryptosporidium parvum* entering drinking water supplies.

Since particle counters have several advantages over turbidity meters, such as a higher sensitivity to changes in water quality at low turbidities (below 0.1 NTU), a higher sensitivity to changes associated with larger particle sizes, and a particle-sizing capability, they may someday replace turbidity meters. However, turbidity meters are the preferred monitoring mechanism for process control of particulate matter in potable water at this time.

### Langelier Index

The Langelier Saturation Index is a means of evaluating water quality data to determine if the water has a tendency to form a chemical scale. In order to use this index, the following laboratory analysis is needed: pH, conductivity, total dissolved solids, alkalinity, and total hardness. In manipulating the data, the actual pH of the water is compared to the theoretical pH (pHs) based on the chemical analysis.

### The Saturation Index (SI) $SI = pH - pHs$

The Saturation Index is typically either negative or positive and rarely 0. A Saturation Index of zero indicates that the water is “balanced” and is less likely not to cause scale formation. A negative SI suggests that the water would be undersaturated with respect to carbonate equilibrium and the water may be more likely to have a greater corrosive potential.

A positive SI suggests that water may be scale forming. The scale, typically a carbonate residue, could clog or reduce the flow in pipes, cause buildup on hot water heaters, impart an alkali taste to the water, reduce the efficiency of the water heaters, and cause other aesthetic problems.

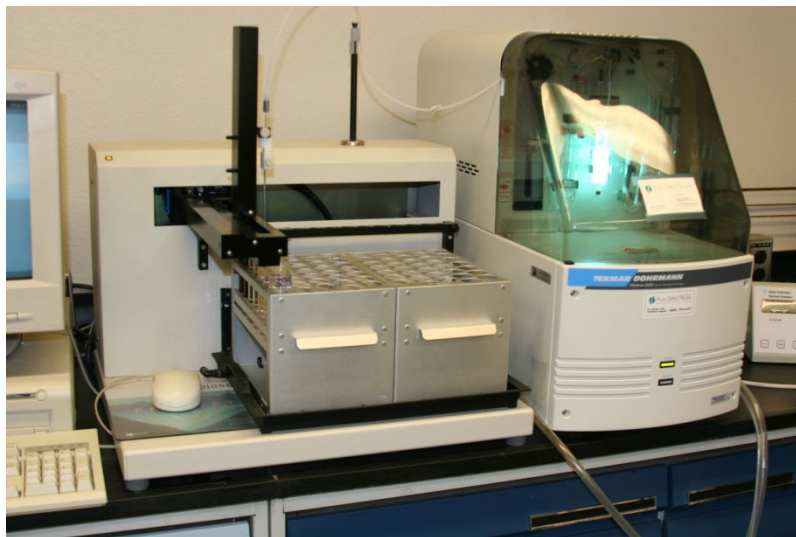
Saturation Index	Description	General Recommendation
- 5	Severe Corrosion	Treatment Recommended
- 4	Severe Corrosion	Treatment Recommended
- 3	Moderate Corrosion	Treatment Recommended
- 2	Moderate Corrosion	Treatment May Be Needed
-1	Mild Corrosion	Treatment May Be Needed
-0.5	None- Mild Corrosion	Probably No Treatment

0	Near Balanced	No Treatment
0.5	Some Faint Coating	Probably No Treatment
1	Mild Scale Coating	Treatment May Be Needed
2	Mild to Moderate Coatings	Treatment May Be Needed
3	Moderate Scale Forming	Treatment Advisable
4	Severe Scale Forming	Treatment Advisable

Please Note- SI Index is not a reliable means of evaluating corrosion potential, but it can be used as a guide.

### UV 254

Total organic carbon (TOC) is an important indicator of water quality in drinking water supply systems. Prescribed chlorination rates are often based on TOC levels, and levels of disinfection byproducts (DBP) can be subsequently approximated. Unfortunately, TOC is difficult to measure, and some water utilities rely on the more easily measured absorbance of ultraviolet light (specifically at a wavelength of 254 nm, abbreviated UV-254) as a surrogate indicator of organic content. For daily or weekly operating purposes, measurements of UV-254 can provide inexpensive and meaningful prescriptive guidance for disinfection processes.



Water treatment labs use unit like this to measure total organic carbon (TOC).

## Required EPA Information

- EPA is directed to require public water systems to provide customers with annual "**Consumer Confidence Reports**" in newspapers and by direct mail.
- The reports must list levels of regulated contaminants along with Maximum Contaminant Levels (**MCLs**) and Maximum Contaminant Level Goals (**MCLGs**), along with plainly worded definitions of both.
- The reports must also include a plainly worded statement of the health concerns for any contaminants for which there has been a violation, describe the utility's sources of drinking water and provide data on unregulated contaminants for which monitoring is required, including Cryptosporidium and radon.
- EPA must establish a toll-free hot line customers can call to get additional information.
- EPA is required to publish guidelines for states to develop water source assessment programs that delineate protection areas and assess contamination risks.
- EPA is required to identify technologies that are affordable for small systems to comply with drinking water regulations.

the recognition of *Giardia lamblia* as a cause of gastroenteritis (Lindquist, 1999).

## Laboratory Analysis Post Quiz

### Sample Procedures

1. Upon infection by coliphage in the water sample, the *E. coli* host cells are lysed and stable indolyl product that is yellow in color is visible within each plaque.  
A. True B. False
2. Viral plaques are easily identified and enumerated by the distinct red circle.  
A. True B. False
3. Large sample volumes, such as 1-L volumes or greater, are recommended for detection of coliphage in ground water.  
A. True B. False
4. Samples for enumeration of \_\_\_\_\_ are analyzed by use of the mCP agar method (U.S. Environmental Protection Agency, 1996c).
5. Standard MF techniques are used, and \_\_\_\_\_ are incubated anaerobically for 24 hours at 44.5°C.
6. After incubation, the plates are exposed to ammonium hydroxide, and all straw-colored colonies that turn dark pink to magenta are counted as \_\_\_\_\_.
7. Method 1623 (U.S. Environmental Protection Agency, 1999c) is recommended for detection of *coliform bacteria* in water. The oocysts are concentrated on a capsule filter from a 10-L water sample, eluted from the capsule filter with buffer, and concentrated by centrifugation.  
A. True B. False
8. In IMS, the \_\_\_\_\_ are magnetized by attachment of magnetic beads conjugated to an antibody and then are separated from sediment and debris by means of a magnet.
9. \_\_\_\_\_ means that fluorescently labeled antibodies and vital dye were used to make the final microscopic identification of \_\_\_\_\_.

10. QA/QC activities and measures to take to reduce contamination.  
A. True B. False

11. Prepare a separate set of *E. coli* host cultures for microbiological sampling at each site.  
A. True B. False

12. Membrane-filtration (MF) equipment and MF procedure blanks are used to estimate \_\_\_\_\_.

**Field personnel should do the following:**

13. Prepare \_\_\_\_\_, a 50- to 100-mL aliquot of sterile buffered water plated before the sample—for every sample by field personnel for total coliform, *E. coli*, and enterococci analyses to determine the sterility of equipment and supplies.

14. Prepare a \_\_\_\_\_, a 50- to 100-mL aliquot of sterile buffered water plated after the sample—for every fourth sample to measure the effectiveness of the analyst's rinsing technique or presence of incidental contamination of the buffered water.

15. \_\_\_\_\_ are the same as equipment blanks except that they are generated under actual field conditions.

**Quality Assurance and Quality Control in the Laboratory**

16. Production analytical laboratory criteria may be used to evaluate each of the following: (1) appropriate, approved, and published methods, (2) documented standard operating procedures, (3) approved quality-assurance plan, (4) types and amount of quality-control data fully documented and technical defensible, (5) participation in the standard reference sample project (6) scientific capability of personnel, and (7) \_\_\_\_\_.

17. According to the text, microbiology laboratories must follow good laboratory practices—cleanliness, safety practices, procedures for \_\_\_\_\_, specifications for reagent water quality—as set forth by American Public Health Association.

## Common Water Treatment Chemicals

Chemical Name	Common Name	Chemical Formula
Aluminum hydroxide		Al(OH) <sub>3</sub>
Aluminum sulfate	Alum, liquid	Al <sub>2</sub> (SO <sub>4</sub> ) <sub>3</sub> · 14(H <sub>2</sub> O)
Ammonia		NH <sub>3</sub>
Ammonium		NH <sub>4</sub>
Bentonitic clay	Bentonite	
Calcium bicarbonate		Ca(HCO <sub>3</sub> ) <sub>2</sub>
Calcium carbonate	Limestone	CaCO <sub>3</sub>
Calcium chloride		CaCl <sub>2</sub>
Calcium Hypochlorite	HTH	Ca(OCl) <sub>2</sub> · 4H <sub>2</sub> O
Calcium hydroxide	Slaked Lime	Ca(OH) <sub>2</sub>
Calcium oxide	Unslaked (Quicklime)	CaO
Calcium sulfate	Gypsum	CaSO <sub>4</sub>
Carbon	Activated Carbon	C
Carbon dioxide		CO <sub>2</sub>
Carbonic acid		H <sub>2</sub> CO <sub>3</sub>
Chlorine gas		Cl <sub>2</sub>
Chlorine Dioxide		ClO <sub>2</sub>
Copper sulfate	Blue vitriol	CuSO <sub>4</sub> · 5H <sub>2</sub> O
Dichloramine		NHCl <sub>2</sub>
Ferric chloride	Iron chloride	FeCl <sub>3</sub>
Ferric hydroxide		Fe(OH) <sub>3</sub>
Ferric sulfate	Iron sulfate	Fe <sub>2</sub> (SO <sub>4</sub> ) <sub>3</sub>
Ferrous bicarbonate		Fe(HCO <sub>3</sub> ) <sub>2</sub>
Ferrous hydroxide		Fe(OH) <sub>2</sub>
Ferrous sulfate	Copperas	FeSO <sub>4</sub> · 7H <sub>2</sub> O
Hydrofluorsilicic acid		H <sub>2</sub> SiF <sub>6</sub>
Hydrochloric acid	Muriatic acid	HCl
Hydrogen sulfide		H <sub>2</sub> S
Hypochlorous acid		HOCl
Magnesium bicarbonate		Mg(HCO <sub>3</sub> ) <sub>2</sub>
Magnesium carbonate		MgCO <sub>3</sub>
Magnesium chloride		MgCl <sub>2</sub>
Magnesium hydroxide		Mg(OH) <sub>2</sub>
Magnesium dioxide		MgO <sub>2</sub>
Manganous bicarbonate		Mn(HCO <sub>3</sub> ) <sub>2</sub>
Manganous sulfate		MnSO <sub>4</sub>
Monochloramine		NH <sub>2</sub> Cl
Potassium bicarbonate		KHCO <sub>3</sub>

Potassium permanganate		KMnO <sub>3</sub>
Sodium carbonate	Soda ash	Na <sub>2</sub> CO <sub>3</sub>
Sodium chloride	Salt	NaCl
Sodium chlorite		NaClO <sub>2</sub>
Sodium fluoride		NaF
Sodium fluorsilicate		Na <sub>2</sub> SiF <sub>6</sub>
Sodium hydroxide	Lye	NaOH
Sodium hypochlorite		NaOCl
Sodium Metaphosphate	Hexametaphosphate	NaPO <sub>3</sub>
Sodium phosphate	Disodium phosphate	Na <sub>3</sub> PO <sub>4</sub>
Sodium sulfate		Na <sub>2</sub> SO <sub>4</sub>
Sulfuric acid		H <sub>2</sub> SO <sub>4</sub>



*When should employees read the label for a hazardous chemical? (Before starting the job every time that chemical is used—its hazards or protections could change or an employee could forget or confuse it with other chemicals.)*



<b>Common Used Products</b>	<b>Chemical Name</b>
acetone	dimethyl ketone
acid of sugar	oxalic acid
alcohol, grain	ethyl alcohol
alcohol, wood	methyl alcohol
alum	aluminum potassium sulfate
alumina	aluminum oxide
antichlor	sodium thiosulfate
aqua ammonia	aqueous solution of ammonium hydroxide
aqua regia	nitrohydrochloric acid
aqua fortis	nitric acid
aromatic spirit of ammonia	ammonia in alcohol
asbestos	magnesium silicate
aspirin	acetylsalicylic acid
baking soda	sodium bicarbonate
banana oil (artificial)	isoamyl acetate
benzol	benzene
bichloride of mercury	mercuric chloride
black copper oxide	cupric oxide
black lead	graphite (carbon)
bleaching powder	chlorinated lime
blue vitriol	copper sulfate
bluestone	copper sulfate
borax	sodium borate
brimstone	sulfur
brine	aqueous sodium chloride solution
butter of antimony	antimony trichloride
butter of tin	anhydrous stannic chloride
calomel	mercury chloride
carbolic acid	phenol
carbonic acid gas	carbon dioxide
caustic potash	potassium hydroxide
caustic soda	sodium hydroxide
chalk	calcium carbonate
Chile saltpeter	sodium nitrate
chrome, alum	chromic potassium sulfate
chrome, yellow	lead (VI) chromate
copperas	ferrous sulfate
cream of tartar	potassium bitartrate
crocus powder	ferric oxide
emery powder	impure aluminum oxide
Epsom salts	magnesium sulfate
ethanol	ethyl alcohol
fluorspar	natural calcium fluoride
formalin	aqueous formaldehyde solution
French chalk	natural magnesium silicate
galena	natural lead sulfide
Glauber's salt	sodium sulfate
gypsum	natural calcium sulfate
hydrocyanic acid	hydrogen cyanide

hypo (photography)	sodium thiosulfate solution
lime	calcium oxide
limewater	aqueous solution of calcium hydroxide
lunar caustic	silver nitrate
magnesia	magnesium oxide
mercury oxide, black	mercurous oxide
methanol	methyl alcohol
methyated spirits	methyl alcohol
muriatic acid	hydrochloric acid
oil of vitriol	sulfuric acid
oil of wintergreen (artificial)	methyl salicylate
Paris green	copper acetoarsenite
Paris white	powdered calcium carbonate
pear oil (artificial)	isoamyl acetate
pearl ash	potassium carbonate
plaster of Paris	calcium sulfate
plumbago	graphite
potash	potassium carbonate
potassa	potassium hydroxide
Prussic acid	hydrogen cyanide
pyro	tetrasodium pyrophosphate
quicklime	calcium oxide
quicksilver	mercury
red lead	lead tetraoxide
Rochelle salt	potassium sodium tartrate
rouge, jeweler's	ferric oxide
rubbing alcohol	isopropyl alcohol
sal ammoniac	ammonium chloride
sal soda	sodium carbonate
salt, table	sodium chloride
salt of lemon	potassium binoxalate
salt of tartar	potassium carbonate
saltpeter	potassium nitrate
silica	silicon dioxide
soda ash	sodium carbonate
soda lye	sodium hydroxide
soluble glass	sodium silicate
spirit of hartshorn	ammonium hydroxide solution
sugar, table	sucrose
talc or talcum	magnesium silicate
vinegar	impure dilute acetic acid
vitamin C	ascorbic acid
washing soda	sodium carbonate
water glass	sodium silicate

## Post Quiz Answers

### Chapter 1 - Disinfection Rules

1. Trihalomethanes (THMs) 2. Surface Water Treatment Rule, 3. Interim Enhanced Surface Water Treatment Rule, 4. True, 5. Stage 1 Disinfectants/Disinfection Byproducts Rule, 6. 10 parts per billion, 7. 1 part per million, 8. Free available chlorine and Combined chlorine, 9. Ammonia and Cl<sub>2</sub>, 10. True, 11. False, 12. True, 13. Chlorate and Chlorite, 14. False, 15. True, 16. True, 17. Waterborne diseases, 18. THM formation

### Chapter 2 - Waterborne Pathogens

1. False, 2. False, 3. True, 4. False, 5. False, 6. True, 7. True, 8. True, 9. True, 10. False

### Chapter 3- Water Chemistry Section Answers

1. Primary pH standard values, 2. 7, 3. Hydronium ion concentration, 4. Measurement of pH, 5. A dimensionless quantity, 6. Alkalinity, 7. Hydrogen ion activity, 8. Acid, 9. Visual comparison, 10. Nature of the solution, 11. The concentration value, 12. End-point pH, 13. Solution of a cubic equation, 14. An aggregate property of water, 15. Colorimeter or spectrophotometer, 16. The solution of a quadratic equation, 17. Chemical speciation, 18. Alkalinity, 19. Strong acids and bases, 20. Strong base

### Chapter 4- Chlorine Section Post Quiz Answers

1. Use a new, approved gasket on the connector, 2. 1/4 turn to unseat the valve, then open one complete turn, 3. The cylinder may rupture, 4. The ratio of the density of the liquid to the density of water at 4 degrees C, 5. Gold, Platinum, and Tantalum, 6. Gas chlorine, 7. Secure each cylinder in an upright position. Attach the protective bonnet over the valve. Firmly secure each cylinder, 8. Open chlorine metering orifice slightly. Inspect vacuum lines. Start injector water supply, 9. In addition to protective clothing and goggles, chlorine gas should be used only in a well-ventilated area so that any leaking gas cannot concentrate, 10. Chlorine gas forms a mixture of hydrochloric and hypochlorous acids, 11. Because it is too easy to roll, 12. A yellowish green, nonflammable and liquefied gas with an unpleasant and irritating smell. Can be readily compressed into a clear, amber colored liquid, a noncombustible gas, and a strong oxidizer. Liquid chlorine is about 1.5 times heavier than water and gaseous chlorine is about 2.5 times heavier than air, 13. Notify local emergency response team. Warn and evacuate people in adjacent areas, be sure that no one enters the leak area without adequate self-contained breathing equipment, 14. Burning of eyes, nose, and mouth; lacrimation and rhinorrhea; Coughing, sneezing, choking, nausea and vomiting; headaches and dizziness; Fatal pulmonary edema; pneumonia; conjunctivitis; keratitis; pharyngitis; burning chest pain; dyspnea; hemoptysis; hypoxemia; dermatitis; and skin blisters, 15. 646 mg/L, 16. Get out of the area of the leak, proceeding upwind, and 2) take only very short breaths through the mouth, 17. 0.195 or also written 19.5%, 18. True, 19. True, 20. True, 21. HOCl and OCl<sup>-</sup>; free available chlorine, 22. Cl<sub>2</sub> + H<sub>2</sub>O --> H<sup>+</sup> + Cl<sup>-</sup> + HOCl

### Chapter 5- Hypochlorites and Chloramines Section

1. Trichloramine, 2. Chloramine(s), 3. Monochloramine, 4. Nitrogen gas, 5. Dichloramine, 6. Monochloramine and dichloramine, 7. Calcium hypochlorite, 8. Calcium hypochlorite, 9. Calcium hypochlorite, 10. True, 11. False, 12. Liquid chlorine, 13. Hypochlorite ion (OCl<sup>-</sup>) in solution, 14. Hypochlorite ion, 15. Liquid chlorine, 16. Hypochlorite, 17. Sodium and calcium hypochlorite, 18. Chlorine gas

### **Chapter 6- Safety and Chlorination Equipment Post Quiz**

1. The chlorine room 2. Mechanically ventilated enclosure, 3. The chlorine room, 4. Air inlets, 5. Separate switches for fans and lights, 6. Automatic chlorine leak detection, 7. False, 8. Chlorine leak detection equipment, 9. False, 10. True, 11. A separate storage room, 12. The chlorine gas storage room, 13. Chlorine rooms, 14. Acute exposure, 15. Chronic exposure, 16. Inhalation, 17. True, 18. True

### **Chapter 7 - Alternative Disinfectants Post Quiz**

1. Sodium chlorite, 2. Chlorine dioxide or  $\text{ClO}_2$ , 3.  $\text{NaOCl}$  and  $\text{HCl}$ , 4. Sodium chlorate ( $\text{NaClO}_3$ ), 5. Ultraviolet (UV) radiation, 6. 2.0 gpm - 15 seconds, 7. UV rays, 8. UV rays, 9. UV arrays, 10. UV disinfection, 11. Ozone, 12. Ozone, 13. Self-polishing pungent odor, 14. THMs, 15. DBPs, 16. Liquid Ozone, 17. Ozone demand, 18. Chlorine dioxide or  $\text{ClO}_2$

### **Chapter 8 - Respirator Protection Post Quiz Answers**

1. False, 2. True, 3. True, 4. True, 5. False, 6. True, 7. False, 8. True, 9. False, 10. True, 11. True, 12. False, 13. True, 14. True, 15. True, 16. True, 17. True, 18. False, 19. True, 20. True

### **Chapter 9- Laboratory Analysis Post Quiz**

1. False, 2. False, 3. True, 4. *C. perfringens*, 5. The plates, 6. *C. perfringens*, 7. False, 8. Oocyst(s), 9. Oocysts and cysts, 10. True, 11. False, 12. Analytical bias, 13. An MF equipment blank, 14. MF procedure blank(s), 15. Field blanks, 16. Appropriate laboratory equipment, 17. Media preparation

# Math Conversion Factors Section

1 PSI = 2.31 Feet of Water  
 1 Foot of Water = .433 PSI  
 1.13 Feet of Water = 1 Inch of Mercury  
 454 Grams = 1 Pound  
 2.54 CM = Inch  
 1 Gallon of Water = 8.34 Pounds  
 1 mg/L = 1 PPM  
 17.1 mg/L = 1 Grain/Gallon  
 1% = 10,000 mg/L  
 694 Gallons per Minute = MGD  
 1.55 Cubic Feet per Second = 1 MGD  
 60 Seconds = 1 Minute  
 1440 Minutes = 1 Day  
 .746 kW = 1 Horsepower

## LENGTH

12 Inches = 1 Foot  
 3 Feet = 1 Yard  
 5280 Feet = 1 Mile

## AREA

144 Square Inches = 1 Square Foot  
 43,560 Square Feet = 1 Acre

## VOLUME

1000 Milliliters = 1 Liter  
 3.785 Liters = 1 Gallon  
 231 Cubic Inches = 1 Gallon  
 7.48 Gallons = 1 Cubic Foot of water  
 62.38 Pounds = 1 Cubic Foot of water

## Dimensions

**SQUARE:** Area (sq.ft.) = Length X Width  
 Volume (cu.ft.) = Length (ft) X Width (ft) X Height (ft)

**CIRCLE:** Area (sq.ft.) = 3.14 X Radius (ft) X Radius (ft)

**CYLINDER:** Volume (Cu. ft) = 3.14 X Radius (ft) X Radius (ft) X Depth (ft)

**PIPE VOLUME:** .785 X Diameter <sup>2</sup> X Length = ? To obtain gallons multiply by 7.48

**SPHERE:**  $\frac{(3.14) (\text{Diameter})^3}{(6)}$  Circumference = 3.14 X Diameter

## General Conversions

### Flowrate

Multiply	→	to get
to get	←	Divide
cc/min	1	mL/min
cfm (ft <sup>3</sup> /min)	28.31	L/min
cfm (ft <sup>3</sup> /min)	1.699	m <sup>3</sup> /hr
cfh (ft <sup>3</sup> /hr)	472	mL/min
cfh (ft <sup>3</sup> /hr)	0.125	GPM
GPH	63.1	mL/min
GPH	0.134	cfh
GPM	0.227	m <sup>3</sup> /hr
GPM	3.785	L/min
oz/min	29.57	mL/min

**POUNDS PER DAY** = Concentration (mg/L) X Flow (MG) X 8.34  
**AKA Solids Applied Formula** = Flow X Dose X 8.34

$$\text{PERCENT EFFICIENCY} = \frac{\text{In} - \text{Out}}{\text{In}} \times 100$$

$$\begin{aligned} \text{TEMPERATURE: } \quad {}^{\circ}\text{F} &= ({}^{\circ}\text{C} \times 9/5) + 32 & 9/5 &= 1.8 \\ {}^{\circ}\text{C} &= ({}^{\circ}\text{F} - 32) \times 5/9 & 5/9 &= .555 \end{aligned}$$

$$\text{CONCENTRATION: } \text{Conc. (A)} \times \text{Volume (A)} = \text{Conc. (B)} \times \text{Volume (B)}$$

$$\text{FLOW RATE (Q): } Q = A \times V \text{ (Quantity = Area X Velocity)}$$

$$\text{FLOW RATE (gpm): } \text{Flow Rate (gpm)} = \frac{2.83 (\text{Diameter, in})^2 (\text{Distance, in})}{\text{Height, in}}$$

$$\% \text{ SLOPE} = \frac{\text{Rise (feet)}}{\text{Run (feet)}} \times 100$$

$$\text{ACTUAL LEAKAGE} = \frac{\text{Leak Rate (GPD)}}{\text{Length (mi.)} \times \text{Diameter (in)}}$$

$$\text{VELOCITY} = \frac{\text{Distance (ft)}}{\text{Time (Sec)}}$$

**N** = Manning's Coefficient of Roughness

**R** = Hydraulic Radius (ft.)

**S** = Slope of Sewer (ft/ft.)

$$\text{HYDRAULIC RADIUS (ft)} = \frac{\text{Cross Sectional Area of Flow (ft)}}{\text{Wetted pipe Perimeter (ft)}}$$

$$\text{WATER HORSEPOWER} = \frac{\text{Flow (gpm)} \times \text{Head (ft)}}{3960}$$

$$\text{BRAKE HORSEPOWER} = \frac{\text{Flow (gpm)} \times \text{Head (ft)}}{3960 \times \text{Pump Efficiency}}$$

$$\text{MOTOR HORSEPOWER} = \frac{\text{Flow (gpm)} \times \text{Head (ft)}}{3960 \times \text{Pump Eff.} \times \text{Motor Eff.}}$$

$$\text{MEAN OR AVERAGE} = \frac{\text{Sum of the Values}}{\text{Number of Values}}$$

$$\text{TOTAL HEAD (ft)} = \text{Suction Lift (ft)} \times \text{Discharge Head (ft)}$$

$$\text{SURFACE LOADING RATE} = \frac{\text{Flow Rate (gpm)}}{\text{Surface Area (sq. ft)}} \text{ (gal/min/sq.ft)}$$

$$\text{MIXTURE STRENGTH (\%)} = \frac{(\text{Volume 1, gal}) (\text{Strength 1, \%}) + (\text{Volume 2, gal}) (\text{Strength 2, \%})}{(\text{Volume 1, gal}) + (\text{Volume 2, gal})}$$

$$\text{INJURY FREQUENCY RATE} = \frac{(\text{Number of Injuries}) \times 1,000,000}{\text{Number of hours worked per year}}$$

$$\text{DETENTION TIME (hrs)} = \frac{\text{Volume of Basin (gals)} \times 24 \text{ hrs}}{\text{Flow (GPD)}}$$

$$\text{SLOPE} = \frac{\text{Rise (ft)}}{\text{Run (ft)}}$$

$$\text{SLOPE (\%)} = \frac{\text{Rise (ft)} \times 100}{\text{Run (ft)}}$$

**POPULATION EQUIVALENT (PE):**

- 1 PE = .17 Pounds of BOD per Day
- 1 PE = .20 Pounds of Solids per Day
- 1 PE = 100 Gallons per Day

$$\text{LEAKAGE (GPD/inch)} = \frac{\text{Leakage of Water per Day (GPD)}}{\text{Sewer Diameter (inch)}}$$

$$\text{CHLORINE DEMAND (mg/L)} = \text{Chlorine Dose (mg/L)} - \text{Chlorine Residual (mg/L)}$$

**MANNING'S EQUATION**

$\tau Q$  = Allowable time for decrease in pressure from 3.5 PSI to 2.5 PSI

$\tau q$  = As below

$$\tau Q = (0.022) (d_1^2 L_1) / Q \quad \tau q = \frac{[0.085] [(d_1^2 L_1)]}{q}$$

Q = 2.0 cfm air loss

$\theta$  = .0030 cfm air loss per square foot of internal pipe surface

$\delta$  = Pipe diameter (inches)

L = Pipe Length (feet)

$$V = \frac{1.486}{v} R^{2/3} S^{1/2}$$

V = Velocity (ft./sec.)

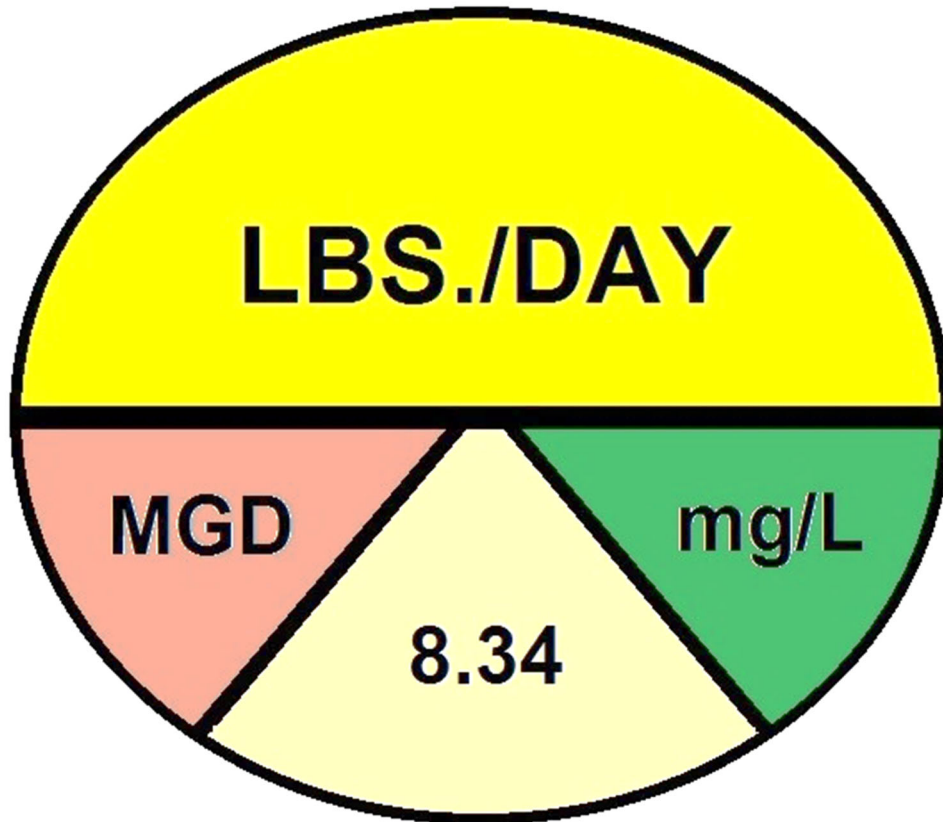
v = Pipe Roughness

R = Hydraulic Radius (ft)

S = Slope (ft/ft)

$$\text{HYDRAULIC RADIUS (ft)} = \frac{\text{Flow Area (ft. }^2\text{)}}{\text{Wetted Perimeter (ft.)}}$$

$$\text{WIDTH OF TRENCH (ft)} = \text{Base (ft)} + (2 \text{ Sides}) \times \frac{\text{Depth (ft }^2\text{)}}{\text{Slope}}$$



**POUNDS PER DAY PIE CHART**



## Course Credits

- Bates, Roger G. *Determination of pH: theory and practice*. Wiley, 1973.
- Benenson, Abram S., editor. 1990. *Control of Communicable Diseases in Man*. 15th ed. Baltimore: Victor Graphics, Inc.
- Bick, H. 1972. Ciliated protozoa. An illustrated guide to the species used as biological indicators in freshwater biology. World Health Organization, Geneva. 198 pp.
- Bickford, T.M., Lindsey, B.D., and Beaver, M.R., 1996, Bacteriological quality of ground water used for
- Bisson, J.W. and Cabelli, V.J., 1980, *Clostridium perfringens* as a water pollution indicator: Journal of the Water Pollution Control Federation, v. 52, no. 2, p. 241-248.
- Born, Stephen M., Douglas A. Yanggen, and Alexander Zaporozec. *A Guide to Groundwater Quality Planning and Management for Local Governments*. Wisconsin Geological and Natural History Survey, Madison, WI, 1987.
- Brenner, K.P., Rankin, C.C., Roybal, Y.R., Stelma, G.R., Scarpino, P.V., and Dufour, A.P., 1993, New medium for simultaneous detection of total coliforms and *Escherichia coli* in water: Applied and Environmental Microbiology, v. 59, no. 11, p. 3534-3544.
- Britton, L.J., and Greeson, P.E., ed., 1989, Methods for collection and analysis of aquatic biological and microbiological samples: U.S. Geological Survey Techniques of Water-Resources Investigations, book 5, chap. A4, 363 p.
- Brooks, D., and Cech, I., 1979, Nitrates and bacterial distribution in rural domestic water supplies: Water
- Butterworth, B.E., Kedderis, G.L., and Conolly, R.B. (1998) The chloroform risk assessment: A mirror of scientific understanding. CIIT Activities, 18 no.4.
- Cabelli, V.J., 1981, Health effects criteria for marine recreational waters: Cincinnati, Ohio, U.S. Environmental Protection Agency, EPA-600/1-80-031.
- Cairns, J., and J.A. Ruthven. 1972. A test of the cosmopolitan distribution of fresh-water protozoans. *Hydrobiologia* 39:405-427.
- Cairns, J., and W.H. Yongue. 1977. Factors affecting the number of species of freshwater protozoan communities. Pages 257-303 in J. Cairns, ed. *Aquatic microbial communities*. Garland, New York.
- Cairns, J., and W.H. Yongue. 1977. Factors affecting the number of species of freshwater protozoan communities. Pages 257-303 in J. Cairns, ed. *Aquatic microbial communities*. Garland, New York.
- Cairns, J., G.R. Lanza, and B.C. Parker. 1972. Pollution related structural and functional changes in aquatic communities with emphasis on freshwater algae and protozoa. *Proceedings of the National Academy of Sciences* 124:79-127.
- Christian, M.S., York, R.G., Hoberman, A.M., Diener, R.M., and Fisher, L.C. (2001b). Oral (drinking water) developmental toxicity studies of bromodichloromethane (BDCM) in rats and rabbits. *International Journal of Toxicology*, 20, 225-237.
- Christian, M.S., York, R.G., Hoberman, A.M., Diener, R.M., Fisher, L.C., and Gates, G.A. (2001a). Biodisposition of dibromoacetic acid (DBA) and bromodichloromethane (BDCM) administered to rats and rabbits in drinking water during range-finding reproduction and developmental toxicity studies. *International Journal of Toxicology*, 20, 239-253.
- Christian, M.S., York, R.G., Hoberman, A.M., Fisher, L.C., and Brown, W.R. (2002a). Oral (drinking water) two-generation reproductive toxicity study of bromodichloromethane (BDCM) in rats. *International Journal of Toxicology*, 21, 115-146.
- Christian, M.S., York, R.G., Hoberman, A.M., Frazee, J., Fisher, L.C., Brown, W.R., and Creasy, D.M. (2002b). Oral (drinking water) two-generation reproductive toxicity study of dibromoacetic acid (DBA) in rats. *International Journal of Toxicology*, 21, 1-40.
- Concern, Inc. *Groundwater: A Community Action Guide*. Washington, D.C., 1989.
- Connell, G.F. (1996). *The chlorination/chloramination handbook*. Denver: American Water Works Association.
- Coulston, F., and Kolbye, A. (Eds.) (1994). *Regulatory Toxicology and Pharmacology*, vol. 20, no. 1, part 2.
- Covington, A. K.; Bates, R. G.; Durst, R. A. (1985). "Definitions of pH scales, standard reference values, measurement of pH, and related terminology" (PDF). *Pure Appl. Chem.* **57** (3): 531–542. doi:10.1351/pac198557030531.

Craun, G.F., 1992, Waterborne disease outbreaks in the United States of America—Causes and prevention: *World Health Statistician Quarterly*, v. 45.

Craun, G.F., and Calderon, R., 1996, Microbial risks in groundwater systems—Epidemiology of waterborne outbreaks, *in Under the microscope—Examining microbes in groundwater*, Proceedings of the Groundwater Foundation's 12th Annual Fall Symposium, Sept. 5-6, 1996, Boston, Mass.: Research Foundation of the American Water Works Association.

Craun, G.F., Hauchman, F.S. and Robinson D.E. (Eds.) (2001). Microbial pathogens and disinfection byproducts in drinking water: Health effects and management of risks, Conference Conclusions, (pp.533-545). Washington, D.C.: ILSI Press.

Craun, G.F., Nwachuku, N., Calderon, R.L., and Craun, M.F. (2002). Outbreaks in drinking-water systems, 1991-1998. *Journal of Environmental Health*, 65, 16-25.

Cross, Brad L and Jack Schulze. *City of Hurst (A Public Water Supply Protection Strategy)*. Texas Water Commission, Austin, TX, 1989.

Curds, C.R. 1992. Protozoa and the water industry. Cambridge University Press, MA. 122 pp.

Curtis, Christopher and Teri Anderson. *A Guidebook for Organizing a Community Collection Event: Household Hazardous Waste*. Pioneer Valley Planning Commission and Western Massachusetts Coalition for Safe Waste Management, West Springfield, MA, 1984.

Curtis, Christopher, Christopher Walsh, and Michael Przybyla. *The Road Salt Management Handbook: Introducing a Reliable Strategy to Safeguard People & Water Resources*. Pioneer Valley Planning Commission, West Springfield, MA, 1986.

Davis, J.V., and Witt, E.C., III, 1998, Microbiological quality of public-water supplies in the Ozark Plateaus Aquifer System: U.S. Geological Survey Fact Sheet 028-98, 2 p.

DiNovo, F., and Jaffe, M., 1984, Local groundwater protection—Midwest Region: Chicago, Ill., American Planning Association., chap. 2-4, p. 5-40.

Dufour, A.P., 1984, Health effects criteria for fresh recreational waters: Cincinnati, Ohio, U.S. Environmental Protection Agency, EPA-600/1-84-004.

Dutka, B.J., Palmateer, G.A., Meissner, S.M., Janzen, E.M., and Sakellaris, M., 1990, The presence of bacterial virus in groundwater and treated drinking water: *Environmental Pollution*, v. 63.

Edwards, T.K., and Glysson, G.D., 1988, Field methods for measurement of fluvial sediment: U.S. Geological Survey Techniques of Water-Resources Investigations, book 3, chap. C2, 89 p.

Embrey, S.S., 1992, Surface-water-quality assessment of the Yakima River Basin, Washington—Areal distribution of fecal-indicator bacteria, July 1988: U.S. Geological Survey Water-Resources Investigations Report 91- 4073, 33 p.

Fenchel, T. 1974. Intrinsic rate increase: the relationship with body size. *Oecologia* 14:317-326.

Fenchel, T., T. Perry, and A. Thane. 1977. Anaerobiosis and symbiosis with bacteria in free-living ciliates. *Journal of Protozoology* 24:154-163.

Flint, K.P., 1987, The long-term survival of *Escherichia coli* in river water: *Journal of Applied Bacteriology*, v. 63.

Foissner, W. 1987. Soil protozoa: fundamental problems, ecological significance, adaptations in ciliates and testaceans, bioindicators, and guide to the literature. *Progress in Protistology* 2:69-212.

Foissner, W. 1988. Taxonomic and nomenclatural revision of Stádeček's list of ciliates (Protozoa: Ciliophora) as indicators of water quality. *Hydrobiologia* 166:1-64.

Ford, T.E. and Colwell R.R. (1996). A global decline in microbiological safety of water: A call for action, a report prepared for the American Academy of Microbiology.

Foster, Laurence, M.D. 1985. "Waterborne Disease - It's Our Job to Prevent It". PIPELINE newsletter, Oregon Health Division, Drinking Water Program, Portland, Oregon 1(4 ): 1-3.

Foster, Laurence, M.D. 1990. "Waterborne Disease," *Methods for the Investigation and Prevention of Waterborne Disease Outbreaks*. Ed. Gunther F. Craun. Cincinnati: U.S. Environmental Protection Agency.

Francy, D.S. and Darner, R. A., 1998, Factors affecting *Escherichia coli* concentrations at Lake Erie public bathing beaches: U.S. Geological Survey Water- Resources Investigations Report 98-4241, 42 p.

Francy, D.S., Hart, T.L., and Virosteck, C.M., 1996, Effects of receiving-water quality and wastewater treatment on injury, survival, and regrowth of fecal-indicator bacteria and implications for assessment of recreational water quality: U.S. Geological Survey Water- Resources Investigations Report 96-4199.

Francy, D.S., Helsel, D.L., and Nally, R.A., 2000, Occurrence and distribution of microbiological indicators in groundwater and streamwater: *Water Environment Research*. v. 72, no. 2., p. 152-161.

Francy, D.S., Jones, A.L., Myers, D.N., Rowe, G.L., Eberle, Michael, and Sarver, K.M., 1998, Quality-assurance/quality-control manual for collection and analysis of water-quality data in the Ohio District, U.S. Geological Survey: U.S. Geological Survey Water-Resources Investigations Report 98-4057, 71 p.

Francy, D.S., Myers, D.N., and Metzker, K.D., 1993, *Escherichia coli* and fecal-coliform bacteria as indicators of recreational water quality: U.S. Geological Survey Water-Resources Investigations Report 93-4083.

Fujioka, R.S. and Shizumura, L.K., 1985, *Clostridium perfringens*, a reliable indicator of streamwater quality: Journal of the Water Pollution Control Federation, v. 57, no. 10, p. 986-992.

Gannon, J.T., Manilal, V.B., and Alexander, M., 1991, Relationship between cell surface properties and transport of bacteria through soil: Applied and Environmental Microbiology, v. 57, n. 1, p. 190-193.

Geldreich, E.E., 1976, Fecal coliform and fecal streptococcus density relationships in waste discharges and receiving waters: CRC Critical Reviews in Environmental Control, October 1976, p. 349-369.

Gerba, C.P., and Bitton, G., 1984, Microbial pollutants—Their survival and transport pattern in ground

Giese, A.C. 1973. *Blepharisma*. Stanford University Press, CA. 366 pp.

Gilliom, R.J., Alley, W.M., and Gurtz, M.E., 1995, Design of the National Water-Quality Assessment Program— Occurrence and distribution of water-quality conditions: U.S. Geological Survey Circular 1112, 33 p.

Gordon, Wendy. *A Citizen's Handbook on Groundwater Protection*. Natural Resources Defense Council, New York, NY 1984.

Guerra de Macedo, G. (1991). Pan American Health Organization. Ref. No. HPE/PER/CWS/010/28/1.1.

Guerrant, R.L. (1997). Cryptosporidiosis: An emerging, highly infectious threat. *Emerging Infectious Diseases*, 3, Synopses. [On-Line.] Available: <http://www.cdc.gov/ncidod/ied/vol3no1/guerrant.htm>

Handzel, T.R., Green, R.M., Sanchez, C., Chung, H., and Sobsey, M.D., 1993, Improved specificity in detecting F-specific coliphages in environmental samples by suppression of somatic phages: *Water Science Technology*, v. 27, no. 3-4, p. 123-131.

Harrison, Ellen Z. and Mary Ann Dickinson. *Protecting Connecticut's Groundwater: A Guide to Groundwater Protection for Local Officials*. Connecticut Department of Environmental Protection, Hartford, CT, 1984.

Havelaar, A.H., van Olphen, M., and Drost, Y.C., 1993, F specific bacteriophages are adequate model organisms for enteric viruses in fresh water: *Applied and Environmental Microbiology*, v. 59, n. 9, p. 2956-2962.

Helsel, D.R. and Hirsch, R.M., 1992, *Statistical methods in water resources*: New York, Elsevier Science Publishing Company.

Hernandez-Delgado, E.A., Sierra, M.L., and Toranzos, G.A., 1991, Coliphages as alternate indicators of fecal contamination in tropical waters: *Environmental Toxicology and Water Quality*, v. 6, p. 131-143.

Herwaldt, B.L., Craun, G.F., Stokes, S.L., and Juranek, D.D., 1991, Waterborne-disease outbreaks, 1989-1990: Morbidity and Mortality Weekly Report, Centers for Disease Control, v. 40, no. SS-3, p. 1-13.

Hirsch, R.M., Alley, W.M., and Wilber, W.G., 1988, Concepts for a national-water quality assessment program: U.S. Geological Survey Circular 1021.

household supply, Lower Susquehanna River Basin, Pennsylvania and Maryland: U.S. Geological Survey Water-Resources Investigations Report 96-4212.

Howell, J.M., Coyne, M.S., and Cornelius, P., 1995, Fecal bacteria in agricultural waters of the Bluegrass Region of Kentucky: *Journal of Environmental Quality*, v. 24, p. 411-419.

Hrezo, Margaret and Pat Nickinson. *Protecting Virginia's Groundwater A Handbook for Local Government Officials*. Virginia Polytechnic Institute and State University, Blacksburg, VA, 1986.

Ijzerman, M.M., and Hagedorn, C., 1992, Improved method for coliphage detection based on  $\square$ -galactosidase induction: *Journal of Virological Methods*, v. 40, p. 31-36.

International Association of Water Pollution Research and Control Study Group on Health Related Water Microbiology, 1991, Bacteriophages as model viruses in water quality control: *Water Research*, v. 25, no. 5, p. 529-545.

International Programme on Chemical Safety (2000). Disinfectants and disinfectant byproducts, *Environmental Health Criteria* 216.

Jaffe, Martin and Frank Dinovo. *Local Groundwater Protection*. American Planning Association, Chicago, IL, 1987.

Kirmeyer, G.J. (1994). An assessment of the condition of North American water distribution systems and associated research needs. American Water Works Association Research Foundation Project #706.

Koterba, M.T., Wilde, F.D., and Lapham, W.W., 1995, Ground-water data-collection protocols and procedures for the National Water-Quality Assessment Program—Collection and documentation of water-quality samples and related data: U.S. Geological Survey Open-File Report 95-399, 113 p.

Kreier, J.P., and J.R. Baker. 1987. Parasitic protozoa. Allen and Unwin, Boston, MA. 241 pp.

Larson, J.L., Wolf, D.C., and Butterworth, B.E. (1994a). Induced cytolethality and regenerative cell proliferation in the livers and kidneys of male B6C3F1 mice given chloroform by gavage. *Fundamentals and Applied Toxicology*, 23, 537-543.

Larson, J.L., Wolf, D.C., and Butterworth, B.E. (1994b). Induced cytotoxicity and cell proliferation in the hepatocarcinogenicity of chloroform in female B6C3F1 mice: comparison of administration by gavage in corn oil vs. ad libitum in drinking water. *Fundamentals and Applied Toxicology*, 22, 90-102.

Laybourn, J., and B.J. Finlay. 1976. Respiratory energy losses related to cell weight and temperature in ciliated protozoa. *Oecologia* 44:165-174.

LeChevallier, M.W., Norton, W.D., and Lee, R.G., 1991, Occurrence of *Giardia* and *Cryptosporidium* species in surface water supplies: *Applied and Environmental Microbiology*, v. 57, no. 9, p. 2610-2616.

Lee, C.C., and T. Fenchel. 1972. Studies on ciliates associated with sea ice from Antarctica. II. Temperature responses and tolerances in ciliates from Antarctica, temperate and tropical habitats. *Archive für Protistenkunde* 114:237-244.

Levy, D.A., Bens, M.S., Craun, G.F., Calderon, R.L., and Herwaldt, B.L., 1998, Surveillance for waterborne disease outbreaks—United States, 1995-1996: Morbidity and Mortality Weekly Report—Surveillance Summaries, December 11, 1998, 47(SS-5).

Lim, Kieran F. (2006). "Negative pH Does Exist". *Journal of Chemical Education*. 83 (10): 1465. Bibcode:2006JChEd..83.1465L. doi:10.1021/ed083p1465.

Lindquist, H.D.A. (1999). Emerging pathogens of concern in drinking water. EPA Publication #EPA 600/R-99/070.

Loomis, George and Yael Calhoon. "Natural Resource Facts: Maintaining Your Septic System." University of Rhode Island, Providence, RI, 1988.

Macozzi, Maureen. *Groundwater- Protecting Wisconsin's Buried Treasure*. Wisconsin Department of Natural Resources, Madison, WI, 1989.

Maine Association of Conservation Commissions. *Ground Water... Maine's Hidden Resource*. Hallowell, ME, 1985.

Malard, F., Reygrobellet, J-L., and Soulie, Michel, 1994, Transport and retention of fecal bacteria at sewage polluted fractured rock sites: *Journal of Environmental Quality*, v. 23, p. 1352-1363.

Massachusetts Audubon Society "Local Authority for Groundwater Protection." Groundwater Information Flyer #4. Lincoln, MA, 1984.

Massachusetts Audubon Society. "Groundwater and Contamination: From the Watershed into the Well." Groundwater Information Flyer # 2. Lincoln, MA, 1984.

Massachusetts Audubon Society. "Mapping Aquifers and Recharge Areas." Groundwater Information Flyer # 3. Lincoln, MA, 1984.

Massachusetts Audubon Society. "Road Salt and Groundwater Protection." Groundwater Information Flyer # 9. Lincoln, MA, 1987.

Mast, A.M., and Turk, J.T., 1999, Environmental Characteristics and Water Quality of Hydrologic Benchmark Network Stations in the Eastern United States, 1963- 95: U.S. Geological Survey Circular 1173-B, 158 p.

McCann, Alyson and Thomas P Husband. "Natural Resources Facts: Household Hazardous Waste." University of Rhode Island, Providence, RI; 1988.

Miller, David W. *Groundwater Contamination: A Special Report*. Geraghty & Miller, Inc., Syosset, NY 1982.

Montagnes, D.J.S., D.H. Lynn, J.C. Roff, and W.D. Taylor. 1988. The annual cycle of heterotrophic planktonic ciliates in the waters surrounding the Isles of Shoals, Gulf of Maine: an assessment of their trophic role. *Marine Biology* 99:21-30.

Mullikin, Elizabeth B. *An Ounce of Prevention: A Ground Water Protection Handbook for Local Officials*. Vermont Departments of Water Resources and Environmental Engineering, Health, and Agriculture, Montpelier, VT, 1984.

Murphy, Jim. "Groundwater and Your Town: What Your Town Can Do Right Now." Connecticut Department of Environmental Protection, Hartford, CT.

Myers, D.N., 1992, Distribution and variability of fecal indicator bacteria in Scioto and Olentangy Rivers in the Columbus, Ohio, area: U.S. Geological Survey Water-Resources Investigations Report 92-4130, 61 p.

Myers, D.N., and Sylvester, M.D., 1997, National field manual for the collection of water-quality data—Biological indicators: U.S. Geological Survey Techniques of Water-Resources Investigations, book 9, chap. A7, 38 p.

Myers, D.N., Koltun, G.F., and Francy, D.S., 1998, Effects of hydrologic, biological, and environmental processes on sources and concentrations of fecal bacteria in the Cuyahoga River, with implications for management of recreational waters in Summit and Cuyahoga Counties, Ohio: U.S. Geological Survey Water-Resources Investigations Report 98-4089, 38 p.

National Academy of Engineering (2000). Greatest engineering achievements of the 20th century. [On-Line]. Available: (<http://www.greatachievements.org/greatachievements/>) (accessed 2-10-03).

National Research Council. *Ground Water Quality Protection: State and Local Strategies*. National Academy Press, Washington, D.C., 1986.

Natural Resources Defense Council, 1998, Testing the waters—Volume VIII: New York, 145 p.

Novotony, V., Sung, Hung-Ming, Bannerman, R., and Baum, K., 1985, Estimating nonpoint pollution from small urban watersheds: Journal of the Water Pollution Control Federation, v. 57, p. 339-348.

New England Interstate Water Pollution Control Commission. "Groundwater: Out of Sight Not Out of Danger." Boston, MA, 1989.

Niederlehner, B.R., K.W. Pontasch, J.R. Pratt, and J. Cairns. 1990. Field evaluation of predictions of environmental effects from multispecies microcosm toxicity test. Archives of Environmental Contamination and Toxicology 19:62-71.

Noake, Kimberly D. Guide to *Contamination Sources for Wellhead Protection*. Draft. Massachusetts Department of Environmental Quality Engineering, Boston, MA, 1988.

Office of Drinking Water. *A Local Planning Process for Groundwater Protection*. U.S. EPA, Washington, D.C., 1989.

Office of Ground-Water Protection. *Guidelines for Delineation of Wellhead Protection Areas*. U.S. EPA, Washington, D.C., 1987.

Office of Ground-Water Protection. *Survey of State Ground Water Quality Protection Legislation Enacted From 1985 Through 1987*. U.S. EPA, Washington, D.C., 1988.

Office of Ground-Water Protection. *Wellhead Protection Programs. - Tools for Local Governments*. U.S. EPA, Washington, D.C., 1989.

Office of Ground-Water Protection. *Wellhead Protection: A Decision-Makers' Guide*. U.S. EPA, Washington, D.C., 1987.

Office of Pesticides and Toxic Substances. *Citizen's Guide to Pesticides*. U.S. EPA, Washington, D.C., 1989.

Office of Underground Storage Tanks. *Musts for USGS. - A Summary of the New Regulations for Underground Storage Tank Systems*. U.S. EPA, Washington, D.C., 1988.

Ohio Environmental Protection Agency. *Ground Water*. Columbus, OH.

Ontario Ministry of the Attorney General, The Honorable Dennis R. O'Connor (2002). Part one: A summary: Report of the Walkerton inquiry: The events of May 2000 and related issues.

Otterstetter, H. and Craun, C. (September, 1997). Disinfection in the Americas: A necessity. Journal of the American Water Works Association, 8-10.

Palmer, M.D., Lock, J.D., and Gowda, T.P.H., 1984, The use of bacteriological indicators for swimming water quality: Water and Pollution Control, v. 122, no. 3, p. 14-15, 17-18, and 74.

Payment, P., and Franco, E., 1993, *Clostridium perfringens* and somatic coliphages as indicators of the efficiency of drinking water treatment for viruses and protozoan cysts: Applied and Environmental Microbiology, v. 59, no. 8, p. 2418-2424.

Redlich, Susan. *Summary of Municipal Actions for Groundwater Protection in the New England/New York Region*. New England Interstate Water Pollution Control Commission, Boston, MA, 1988.

Research, v. 13, p. 33-41.

Robertson, J.B., and Edberg, S.C., 1997, Natural protection of spring and well drinking water against surface microbial contamination. 1. Hydrogeological parameters: Critical Reviews in Microbiology, v. 23, no. 2, p. 143-178.

Rose, J.B. (2002). Water quality security. Environmental Science and Technology, 36, 217-256.

Rose, J.B., Atlas, R.M., Gerba, C.P., Gilchrist, M.J.R., Le Chevallier, M.W., Sobsey, M.D., and Yates, M.V., 1999, Microbial pollutants in our Nation's

Rose, J.B., Gerba, C.P., and Jakubowski, W., 1991, Survey of potable water supplies for *Cryptosporidium* and *Giardia*: Environmental Science and Technology, v. 25, no. 8, p. 1393-1400.

Southern Arizona Water Resources Association. "Water Warnings: Our Drinking Water.... It Takes Everyone to Keep It Clean." Tucson, AZ.

Sponenberg, Torsten D. and Jacob H. Kahn. *A Groundwater Primer for Virginians*. Virginia Polytechnic Institute and State University, Blacksburg, VA, 1984.

Taylor, W., and R. Sanders. 1991. Protozoa. Pages 37-93 in J.H. Thorp and A.P. Covich, eds. Ecology and classification of North American freshwater invertebrates. Academic Press, New York.

Texas Water Commission. "On Dangerous Ground: The Problem of Abandoned Wells in Texas." Austin, TX, 1989.

Texas Water Commission. *The Underground Subject: An Introduction to Ground Water Issues in Texas*. Austin, TX, 1989.

U.S. Centers for Disease Control and Prevention (1997). Summary of notifiable diseases. U.S. Centers for Disease Control and Prevention (April 12, 1996). Morbidity and Mortality Weekly Report, CDC Surveillance summaries: Surveillance for waterborne disease outbreaks, United States, 1993-1994.

U.S. Centers for Disease Control and Prevention (December 11, 1998). Morbidity and Mortality Weekly Report, CDC Surveillance summaries: Surveillance for waterborne disease outbreaks, United States, 1995-1996.

U.S. Centers for Disease Control and Prevention (May 26, 2000). Morbidity and Mortality Weekly Report, CDC Surveillance summaries: Surveillance for waterborne disease outbreaks, United States, 1997-1998.

U.S. Centers for Disease Control and Prevention (November 19, 1993). Morbidity and Mortality Weekly Report, CDC Surveillance summaries: Surveillance for waterborne disease outbreaks-United States, 1991-1992.

U.S. Centers for Disease Control and Prevention, (2002). National Center for Infectious Diseases, Infectious Disease Information, Diseases related to water. [On-Line]. Available: <http://www.cdc.gov/ncidod/diseases/water/drinking.htm>

U.S. Centers for Disease Control and Prevention, (November 22, 2002). Morbidity and Mortality Weekly Report, CDC Surveillance summaries: Surveillance for waterborne disease outbreaks, United States, 1999-2000.

U.S. Environmental Protection Agency (1991). Letter from Wilcher, L.S. to Guerra de Macedo, G.

U.S. Environmental Protection Agency (1998a). National Primary Drinking Water Regulations: Disinfectants and Disinfection Byproducts; Final Rule. Federal Register Vol 63, No. 157. Wednesday, Dec.16, 1998.

U.S. Environmental Protection Agency (1998b). Regulatory Impact Analysis of Final Disinfectant/Disinfection byproducts Regulations. Washington, D.C. EPA Number 815-B-98-002-PB 99-111304

U.S. Environmental Protection Agency (2001a). Toxicological review of chloroform in support of summary information on the Integrated Risk Information System (IRIS). EPA Number 635/R-01/001.

U.S. Environmental Protection Agency (2001b). Controlling Disinfection byproducts and Microbial Contaminants in Drinking Water. EPA Number 600/R-01/110.

U.S. Environmental Protection Agency (2002). Public drinking water systems: Facts and figures. [On-Line]. Available: <http://www.epa.gov/safewater/pws/factoids.html> (accessed 11-22-02).

U.S. Environmental Protection Agency. *Seminar Publication: Protection of Public Water Supplies from Ground-Water Contaminants*. Center for Environmental Research Information, Cincinnati, OH, 1985.

Waller, Roger M. *Ground Water and the Rural Homeowner*. U.S. Geological Survey, Reston, VA, 1988.

water, in Groundwater pollution microbiology: New York, John Wiley and Sons, p. 65-88.

water—Environmental and public health issues: Washington, D.C., American Society for Microbiology, World Health Organization (2002a). Water and Sanitation: Facts and Figures. [On-Line]. Available: [http://www.who.int/water\\_sanitation\\_health/General/factsandfigures.htm](http://www.who.int/water_sanitation_health/General/factsandfigures.htm)

World Health Organization (2002b). Water and Sanitation: Guidelines for drinking water quality. [On-Line]. Available: [http://www.who.int/water\\_sanitation\\_health/GDWQ/Microbiology/Microbioladd/microadd5.htm](http://www.who.int/water_sanitation_health/GDWQ/Microbiology/Microbioladd/microadd5.htm)



We welcome you to complete the assignment in Microsoft Word. You can easily find the assignment at [www.abctlc.com](http://www.abctlc.com).

Once complete, just simply fax or e-mail the answer key along with the registration page to us and allow two weeks for grading. Once we grade it, we will mail a certificate of completion to you. Call us if you need any help.

If you need your certificate back within 48 hours, you may be asked to pay a rush service fee of \$50.00.

You can download the assignment in Microsoft Word from TLC's website under the Assignment Page. [www.abctlc.com](http://www.abctlc.com)

You will have 90 days in order to successfully complete this assignment with a score of 70% or better.

If you need any assistance, please contact TLC's Student Services. Once you are finished, please mail, e-mail or fax your answer sheet along with your registration form.